

IGBT MODULE

■ Features

- Square RBSOA
- Low Saturation Voltage
- Less Total Power Dissipation
- Improved FWD Characteristic
- Minimized Internal Stray Inductance

■ Applications

- High Power Switching
- A.C. Motor Controls
- D.C. Motor Controls
- Uninterruptible Power Supply

■ Outline Drawing

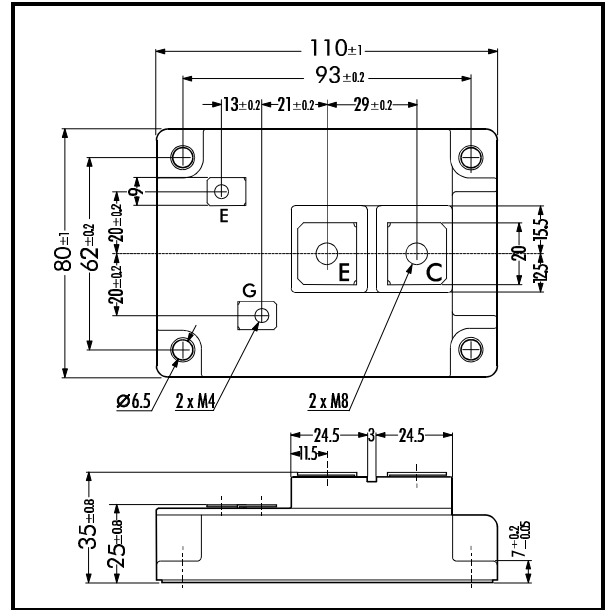

■ Maximum Ratings and Characteristics

• Absolute Maximum Ratings (T_c=25°C)

Items	Symbols	Ratings	Units
Collector-Emitter Voltage	V _{CEs}	1400	V
Gate -Emitter Voltage	V _{GES}	± 20	V
Collector Current	Continuous (25°C / 80°C)	I _C	800 / 600
	1ms (25°C / 80°C)	I _{C PULSE}	1600 / 1200
	Continuous	-I _C	600
	1ms	-I _{C PULSE}	1200
Max. Power Dissipation	P _C	4100	W
Operating Temperature	T _j	+150	°C
Storage Temperature	T _{stg}	-40 ~ +125	°C
Isolation Voltage	A.C. 1min. V _{is}	2500	V
Screw Torque	Mounting *1	4.5	Nm
	Terminals *2	11.0	
	Terminals *3	1.7	

Note: *1:Recommendable Value; 4.0 ± 0.5 Nm (M6)
*2:Recommendable Value; 10.0 ± 1.0 Nm (M8)
*3:Recommendable Value; 1.5 ± 0.2 Nm (M4)

■ Equivalent Circuit

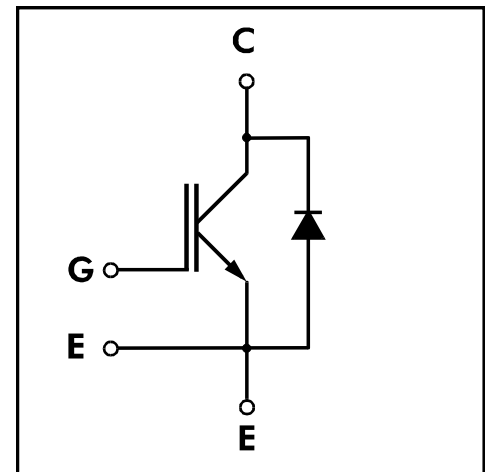

• Electrical Characteristics (at T_j=25°C)

Items	Symbols	Test Conditions	Min.	Typ.	Max.	Units
Zero Gate Voltage Collector Current	I _{CEs}	V _{GE} =0V V _{CE} =1400V			2.0	mA
Gate-Emitter Leakage Current	I _{GES}	V _{CE} =0V V _{GE} =± 20V			± 0.5	μA
Gate-Emitter Threshold Voltage	V _{GE(th)}	V _{GE} =20V I _C =600mA	6.0	8.0	9.0	V
Collector-Emitter Saturation Voltage	V _{CE(sat)}	V _{GE} =15V I _C =600A		2.85	3.2	V
Input capacitance	C _{ies}	V _{GE} =0V		60		nF
Output capacitance	C _{oes}	V _{CE} =10V		9		
Reverse Transfer capacitance	C _{res}	f=1MHz		4		
Turn-on Time	t _{ON}	V _{CC} =600V		0.75	1.20	μs
	t _r	I _C =600A		0.02	0.60	
Turn-off Time	t _{OFF}	V _{GE} =± 15V		0.65	1.00	
	t _f	R _G =2.0Ω		0.01	0.30	
Diode Forward On-Voltage	V _F	I _F =600A V _{GE} =0V			3.4	V
Reverse Recovery Time	t _{rr}	I _F =600A, V _{GE} =-15V			350	ns

• Thermal Characteristics

Items	Symbols	Test Conditions	Min.	Typ.	Max.	Units
Thermal Resistance	R _{th(j-c)}	IGBT			0.03	°C/W
	R _{th(j-e)}	Diode			0.06	
	R _{th(c-f)}	With Thermal Compound		0.0063		

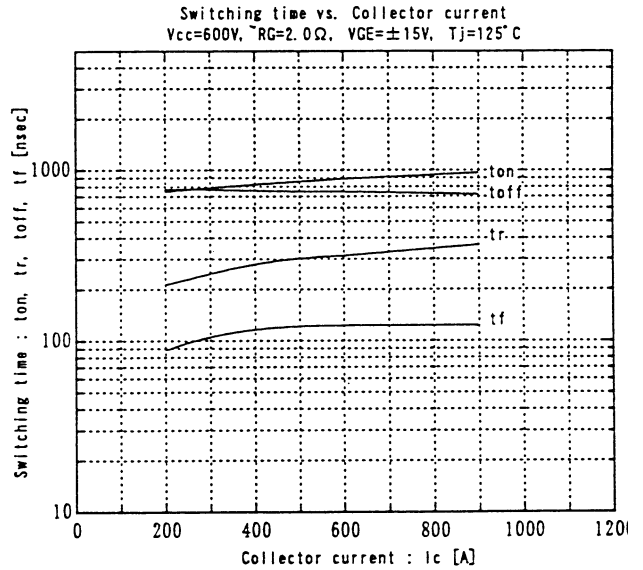
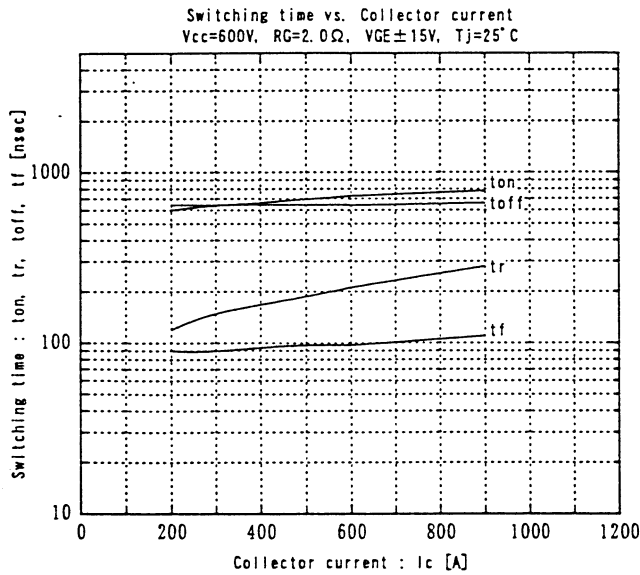
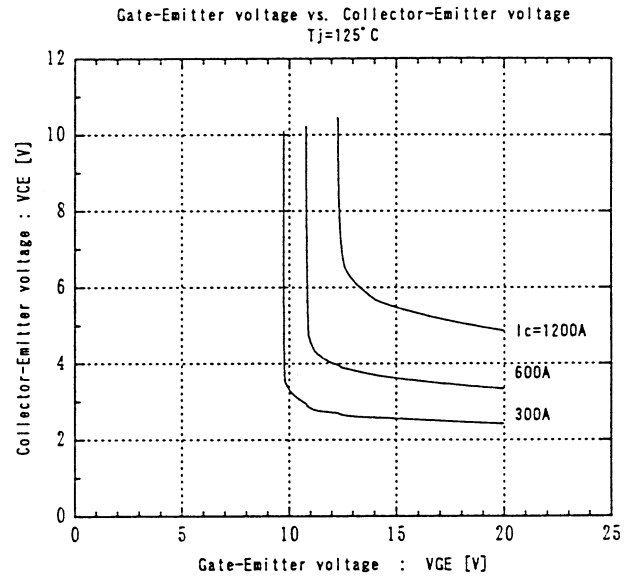
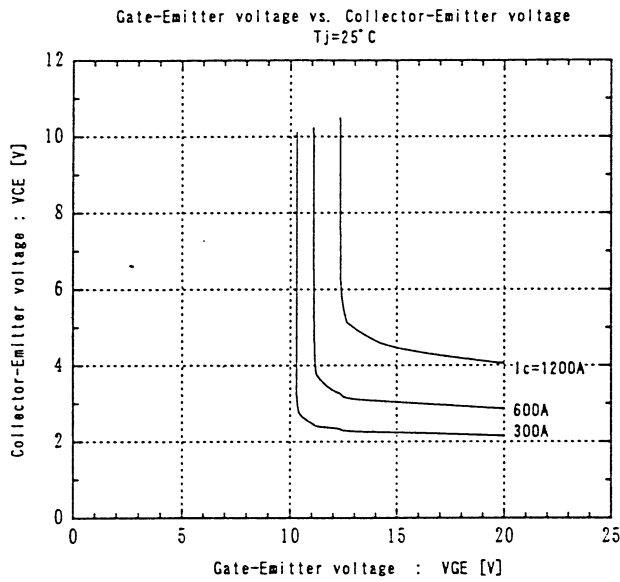
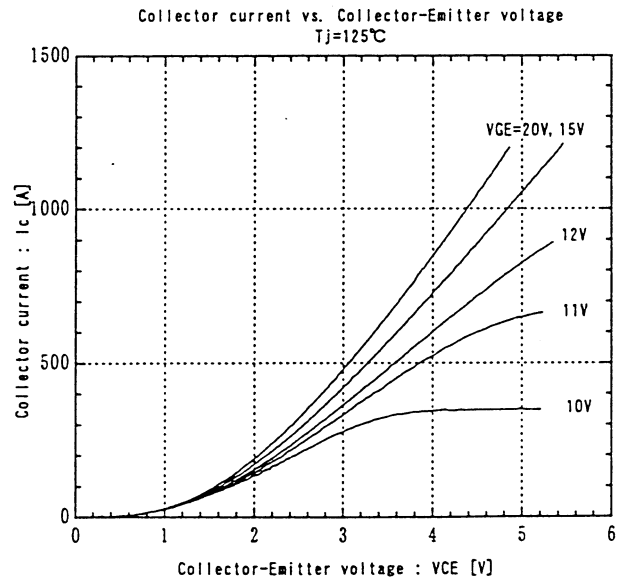
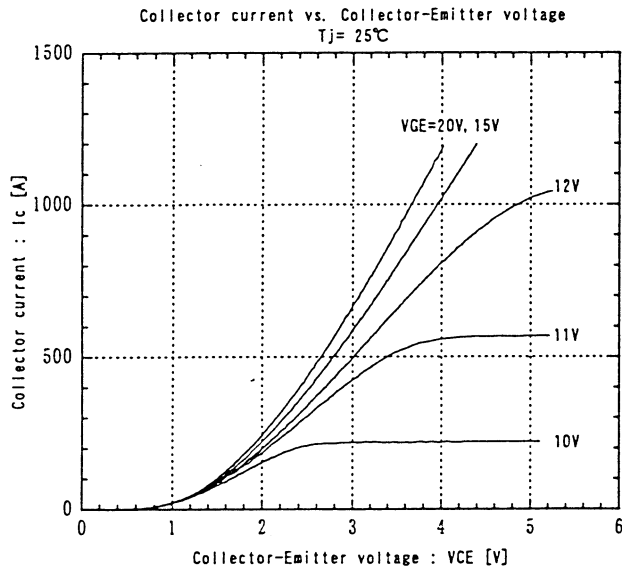

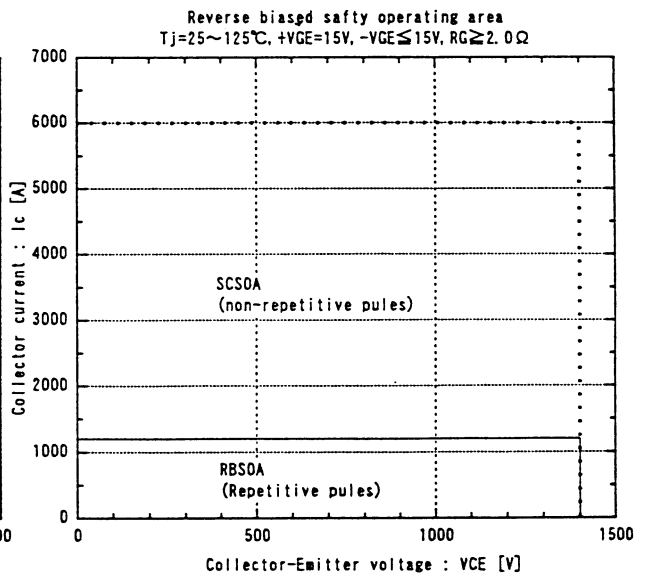
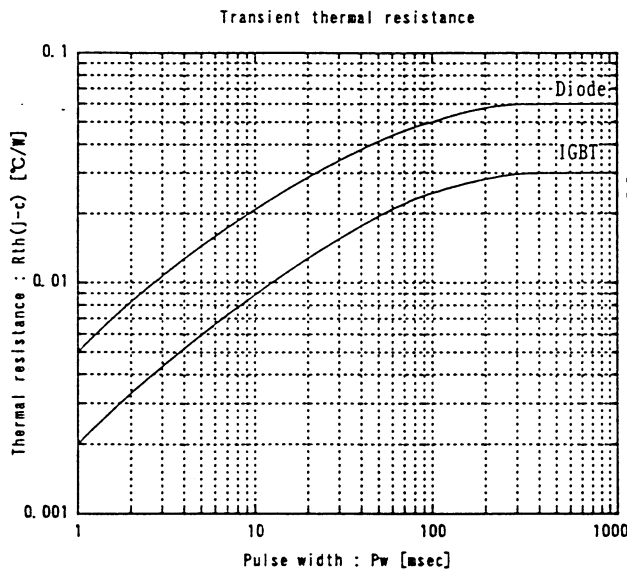
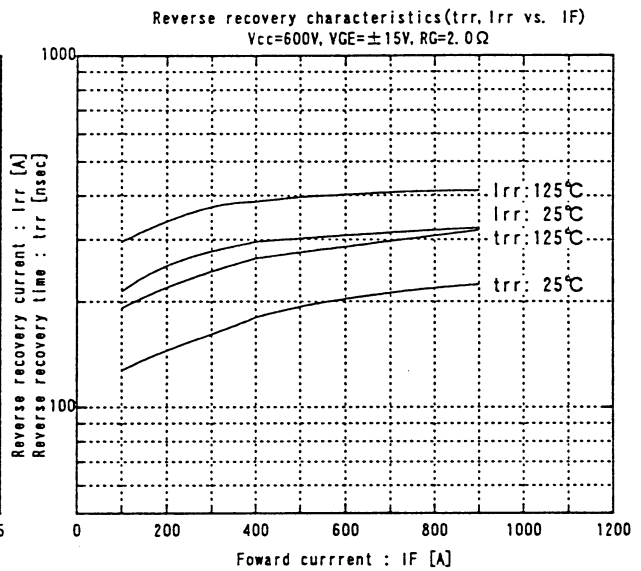
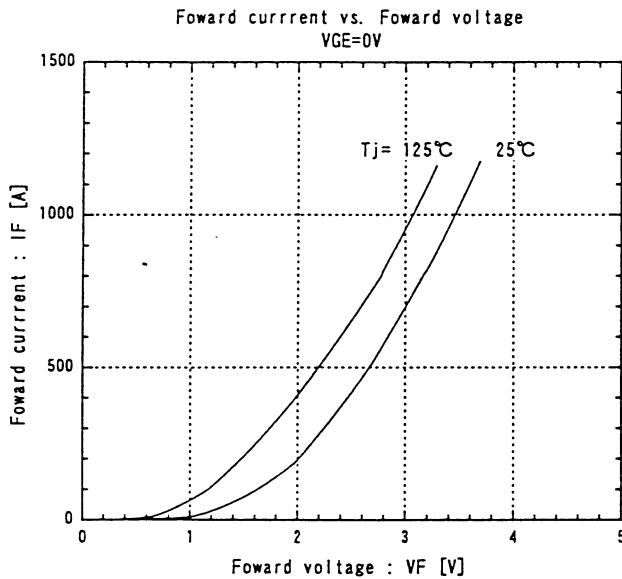
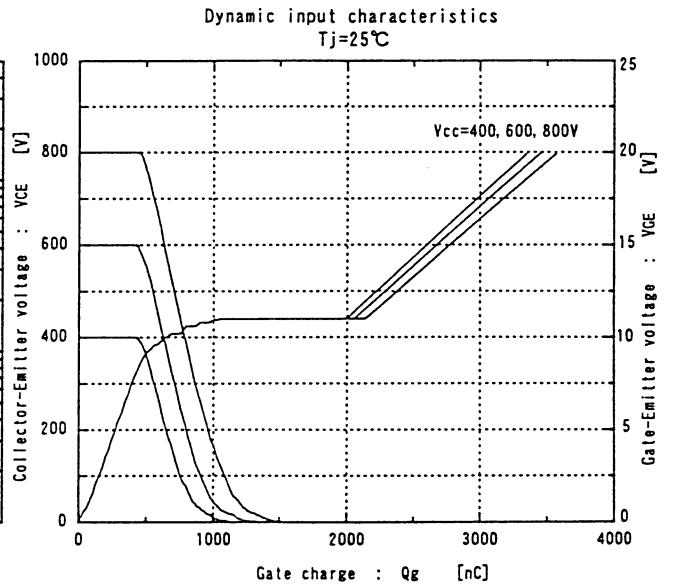
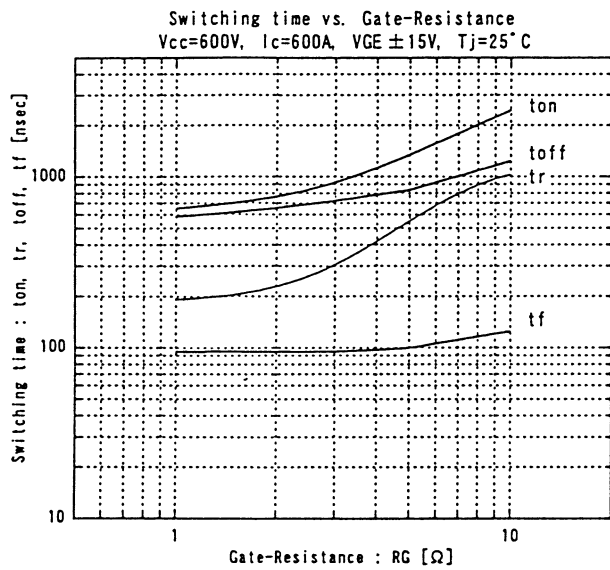

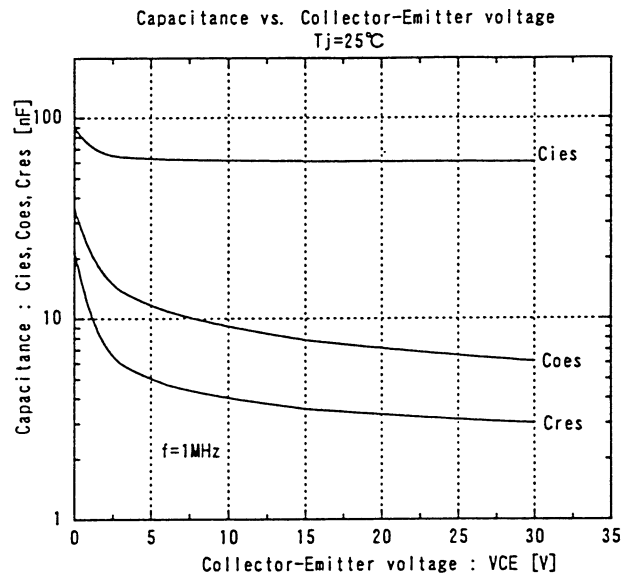
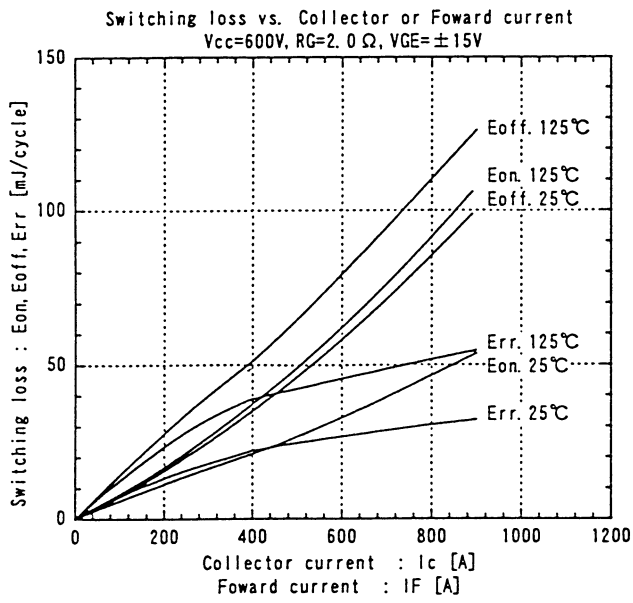

For more information, contact:

Collmer Semiconductor, Inc.

P.O. Box 702708

Dallas, TX 75370

972-233-1589

972-233-0481 Fax

<http://www.collmer.com>

This datasheet has been download from:

www.datasheetcatalog.com

Datasheets for electronics components.