

Contractual warranty

Warranty period	18 months
-----------------	-----------

Dimensions

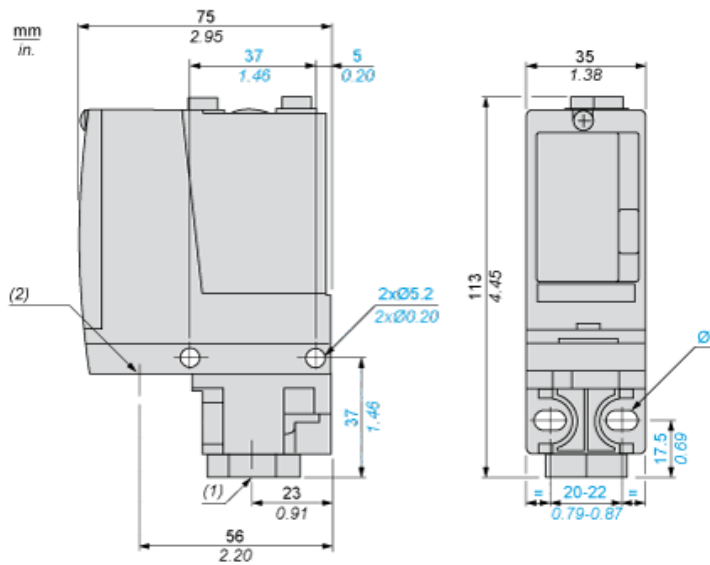

- (1) 1 fluid entry, tapped G1/4 (BSP female)
- (2) 1 electrical connections entry, tapped M20 x 1.5
- Ø : 2 elongated holes Ø 5.2 x 6.7