

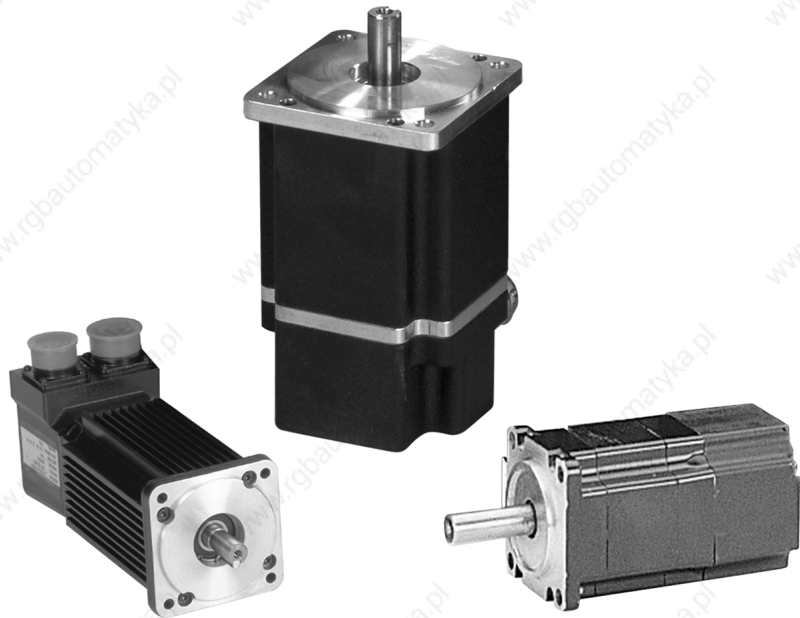

1398 ULTRA Series™ 230V Brushless Servo Motors

Product Data



This publication provides product information for the 0.17 to 50 N-m (1.5 to 450 lb-in.) 1398 ULTRA Series™ 230V, Low-to-Medium Inertia, Brushless Servo Motors. This publication includes:

- Detailed lists of the features and options available for 1398 ULTRA Series 230V, Low-to-Medium Inertia, Brushless Servo Motors
- Performance data and speed-torque curves for the entire 1398 ULTRA Series Servo motor family
- Servo motor dimensions

Table of Contents

Servo Motor Introduction	7
Determining Which Motor to Use	7
Determining Possible Drive/Motor Combinations	8
F-Series Motors	9
Features	9
Typical Applications	10
Characteristics	10
Selecting a Drive/Motor Combination	10
F-Series Specifications	11
F-Series Mechanical Specifications	11
F-Series Winding Specifications	12
Storage and Operating Specifications	12
F-Series Thermostat Specifications	12
F-Series Standard Motor Radial Load Force Ratings	13
ULTRA 100 Series Specifications for F-Series Motors	14
ULTRA 200 Series Specifications for F-Series Motors	14
ULTRA Plus Specifications for F-Series Motors	15
F-Series Brake Specifications	15
Brake Motor Application Guidelines	15
F-Series Standard Motors Dimensions	16
Supplemental Motor Dimensions	17
F-4000 NEMA 56C Dimensions	17
Supplemental Motor Dimensions	18
Encoder Data	18
Encoder Outputs	19
F-Series Connector Pins and Signals	19
Motor Power Connector (All F-Series Motors)	19
Motor Encoder Connector (F-4000 and F-6000 Motors)	20
Optional Motor Brake Connector (F-Series Motors with an 04 Designator)	20
Wire and Contact Sizing Recommendations	21
Power Connector	21
Encoder Connector	21
Brake Connector	21
H-Series Motors	22
Features	22
Typical Applications	23
Characteristics	23
Selecting a Drive/Motor Combination	24
H-Series Specifications	25
H-Series Mechanical Specifications	25
H-Series Winding Specifications	26
Storage and Operating Specifications	27
H-Series Thermostat Specifications	27
H-Series Standard Motor Radial Load Force Ratings	28

ULTRA 100 Series Specifications for H-Series Motors	29
ULTRA 200 Series Specifications for H-Series Motors	30
ULTRA Plus Specifications for H-Series Motors	31
H-Series Brake Specifications	31
Brake Motor Application Guidelines	32
H-Series Standard Motors Dimensions	32
H-2000 Motors Dimensions	33
H-3000, -4000, -6000, and -8000 Motors Dimensions	33
Supplemental Motor Dimensions	35
H-4000 NEMA 56C Dimensions	35
Supplemental Motor Dimensions	36
Encoder Data	37
Encoder Outputs	37
H-Series Connector Pins and Signals	38
Motor Power Connector (All H-Series Motors)	38
Motor Encoder Connector	38
Optional Motor Brake Connector	39
Wire and Contact Sizing Recommendations	39
Power Connector	39
Encoder Connector	40
Brake Connector	40
Y-Series Motors	41
Features	41
Typical Applications	42
Selecting a Drive/Motor Connection	42
Y-Series Specifications	43
Y-Series Mechanical Specifications	43
Y-Series Winding Specifications	44
Storage and Operating Specifications	44
Brake Motor Application Guidelines	44
Y-Series Brake Specifications	45
Y-Series Motor Brake and Shaft Load Data	45
ULTRA 100 Series Specifications for Y-Series Motors	46
ULTRA 200 Specifications for Y-Series Motors	46
Y-Series Standard Motors Dimensions	47
Supplemental Motor Dimensions	48
Cable Diameters	48
Encoder Data	48
Encoder Outputs	49
Y-Series Connector Pins and Signals	49
Motor Power Connector (All Y-Series Motors)	49
Motor Feedback Connector (All Y-Series Motors)	50
Wire and Contact Sizing Recommendations	50
Power/Brake Connector	50
Encoder Connector	51

N-Series Motors	52
Features	52
Typical Applications	53
Characteristics	53
Selecting a Drive/Motor Combination	53
N-Series Specifications	54
N-Series Mechanical Specifications	54
N-Series Thermostat Specifications	55
N-Series Winding Specifications	55
Storage and Operating Specifications	56
N-Series Standard Motor Radial Load Force Ratings	57
N-Series Motors Shaft Load Specifications	58
ULTRA 100 Series Specifications for N-Series Motors	58
ULTRA 200 Series Specifications for N-Series Motors	59
ULTRA Plus Specifications for N-Series Motors	59
N-Series Brake Specifications	60
Brake Motor Application Guidelines	60
N-2300 Motors Dimensions	61
N-3400, -4200, and -5600 Motors Dimensions	61
Supplemental Motor Dimensions	63
Encoder Data	63
Encoder Outputs	64
N-Series Connector Pins and Signals	64
Encoder Connectors (All N-Series Motors)	64
Power and Brake Connectors (All N-Series Motors)	65
ULTRA 100™/200™ System Ordering Guide	66
ULTRA Servo Drives with F-Series Motors	66
ULTRA Servo Drives with F-Series Motors	67
ULTRA Servo Drives with F-Series Motors	68
ULTRA Servo Drives with H-Series Motors	69
ULTRA Servo Drives with H-Series Motors	70
ULTRA Servo Drives with H-Series Motors	71
ULTRA Servo Drives with H-Series Motors	72
ULTRA Servo Drives with H-Series Motors	73
ULTRA Servo Drives with Y-Series Motors (115V AC RMS Input Voltage)	74
ULTRA Servo Drives with Y-Series Motors (230V AC RMS Input Voltage)	75
ULTRA Servo Drives with N-Series Motors	76
ULTRA Servo Drives with N-Series Motors	77
ULTRA Servo Drives with N-Series Motors	78
ULTRA Servo Drives with N-Series Motors	79
ULTRA Servo Drives with N-Series Motors	80
ULTRA Plus System Ordering Guide	81
ULTRA Plus Drives with F-Series Motors (1398-PDM-20, -30, and -75)	81
ULTRA Plus Drives with F-Series Motors (1398-PDM-20, -30, and -75)	82

ULTRA Plus Drives with F-Series Motors(1398-PDM-25, -50, -100, and -150) . . .	83
ULTRA Plus Drives with F-Series Motors (1398-PDM-25, -50, -100, and -150) . .	84
ULTRA Plus Drives with H-Series Motors (1398-PDM-10, -20, -30, and -75)	85
ULTRA Plus Drives with H-Series Motors (1398-PDM-10, -20, -30, and -75)	86
ULTRA Plus Drives with H-Series Motors (1398-PDM-10, -20, -30, and -75)	87
ULTRA Plus Drives with H-Series Motors (1398-PDM-25, -50, -100, and -150) . .	88
ULTRA Plus Drives with H-Series Motors (1398-PDM-25, -50, -100, and -150) . .	89
ULTRA Plus Drives with N-Series Motors (1398-PDM-20 and 1398-PDM-30)	90
ULTRA Plus Drives with N-Series Motors(1398-PDM-20 and 1398-PDM-30)	91
F-Series Motor and Connector Ordering Information	92
H-Series Motor and Connector Ordering Information	93
Y-Series Motor and Connector Ordering Information	94
N-Series Motor and Connector Ordering Information	95

Servo Motor Introduction

The 1398 ULTRA Series servo motors feature ferrite, neodymium-iron-boron, high-energy ring and high-energy neodymium magnet rotors. These compact, brushless servo motors are intended to be used with the Allen-Bradley 1398 Motion Control System. The motors in this series are:

- F-Series
- H-Series
- N-Series
- Y-Series

Determining Which Motor to Use

Use the following table to determine which family of motors you need.

Motors	Description	Typical Applications
F-Series (see page 9)	<ul style="list-style-type: none"> • Medium inertia brushless servo motors • Ferrite magnet that provides greater inertia for matching larger loads • Available in two frame sizes—mechanically interchangeable with H-Series • Continuous torque from 3.5 to 28 N-m (31 to 245 lb-in.) • Speeds up to 4000 RPM • 2000-line incremental encoder standard • Environmental connectors, IP65 enclosure rating 	<ul style="list-style-type: none"> • Web processing • Machine tool • Textile machinery • CAM replacement
H-Series (see page 22)	<ul style="list-style-type: none"> • Low inertia brushless servo motors • Neodymium-iron boron magnet to provide low inertias for high acceleration • Available in five frame sizes • Continuous torque from 0.5 to 50 N-m (5 to 450 lb-in.) • Speeds up to 6000 RPM • 2000-line incremental encoder standard • Environmental connectors, IP65 enclosure rating 	<ul style="list-style-type: none"> • Smart conveyors • Packaging machinery • Material feeding • Pick-and-place machines • High duty cycle applications
Y-Series (see page 41)	<ul style="list-style-type: none"> • Small, low inertia brushless servo motors • High-energy Neodymium magnet to provide low inertias for high acceleration • Available in three popular metric frame sizes • Continuous torque from 0.17 to 2.5 N-m (1.5 to 22 lb-in.) • Speeds up to 4500 RPM • Available in either 115V or 230V windings • IP43 enclosure rating 	<ul style="list-style-type: none"> • Robotics • Material handling • X-Y tables • Specialty machinery • Semiconductor manufacturing
N-Series (see page 52)	<ul style="list-style-type: none"> • NEMA style brushless servo motors • High energy ring magnet rotor construction to provide low inertias for high acceleration • Available in four common NEMA style frame sizes • Continuous torque from 0.18 to 5.9 N-m (1.6 to 52 lb-in.) • Speeds up to 6000 RPM • 1000-, 2000-line incremental encoder standard • Environmental connectors, IP65 enclosure rating 	<ul style="list-style-type: none"> • Web processing • Machine tool • Textile machinery • CAM replacements • Stepper replacement

Determining Possible Drive/Motor Combinations

Use the following table to determine which motors can be used with which drives:

Motors:	Drives:		
	ULTRA 100	ULTRA 200	ULTRA Plus
F-Series	X	X	X
H-Series	X	X	X
Y-Series	X	X	NA
N-Series	X	X	X ¹

¹ Excluding N-23xx motors.

Note: To learn more about the ULTRA Series drives family, see publication 1398-2.0.

F-Series Motors



F-Series motors, mechanically interchangeable with H-Series motors, use a Ferrite magnet to provide nearly four times greater inertia than the H-Series family for matching larger load inertias. Available in two frame sizes, the F-Series motors range in continuous torque capability from 3.5 to 28 N-m, (31 to 245 lb-in.) and reach speeds up to 4000 RPM. The F-Series motors use an optical 2000-line incremental encoder with a 5000-line option for superior low-speed performance with the ULTRA Series. Typical applications for the F-Series include web processing, machine tool, textile machinery, and CAM replacements. When you install the optional motor shaft seal, the motor meets the IP65 requirements of the IEC standard.

Features

The F-Series motors have the following features:

- Compact design that is mechanically interchangeable with the H-Series family
- Two frame sizes, six models
- Continuous torque from 3.5 to 28 N-m (31 to 245 lb-in.)
- Speeds up to 4000 RPM
- Ferrite permanent magnet rotors provide approximately four times greater rotor inertia than the H-Series family for matching larger load inertias
- Internal thermal switch indicates overheating
- Motor-mounted optical encoder included 2000 quadrature pulses, index pulse, and standard commutation channels for drives
- Water tight MS connections are compatible with standard cable assemblies; in addition, the extruded aluminum housing and environmental connectors provide an IP65 package (with the addition of the optional shaft seal kit)
- Economical, compact design ready for harsh environments
- Optional spring-set holding brakes available with 24V DC
- Axially-trapped front bearing in a steel insert for long life at high speeds
- Vibration: 2.5 g peak 3-2000Hz
- Shock: 10.0 g peak 6 ms duration
- UL recognized

Typical Applications

Typical applications for the F-Series motors are:

- Web and film processing
- Machine tool/metal cutting
- Textile machinery
- CAM replacements

Characteristics

- Higher inertia matching capability
- Heavy duty continuous operations
- Environmentally rugged

Selecting a Drive/Motor Combination

The following drive/motor combinations are available for the F-Series motors:

Motor	ULTRA 100	ULTRA 200	ULTRA Plus
F-4030-Q-H00AA	1398-DDM-019	1398-DDM-020	1398-PDM-20
			1398-PDM-25
F-4050-Q-H00AA	1398-DDM-019 ¹	1398-DDM-030	1398-PDM-30
			1398-PDM-50
F-4075-R-H00AA	NA	1398-DDM-030 ²	1398-PDM-30
		1398-DDM-075	1398-PDM-50
F-6100-R-H00AA	NA	1398-DDM-075	1398-PDM-75
			1398-PDM-50
F-6200-R-H00AA	NA	1398-DDM-075	1398-PDM-75
		1398-DDM-150	1398-PDM-100
F-6300-R-H00AA	NA	1398-DDM-075	1398-PDM-75
		1398-DDM-150	1398-PDM-100

¹ Continuous current/torque is limited to 5.2 N-m (46.0 lb-in.).

² Peak torque is limited to 18.6 N-m (164.6 lb-in.).

F-Series Specifications

This section contains the mechanical, thermostat and winding specifications for the F-Series motor family, as well as the load force ratings and performance specifications for every combination of ULTRA series drives and F-Series motors. It also provides motor dimensions, connector pin and signal designations, and all motor and connector ordering information.

F-Series Mechanical Specifications

Specifications	Units	F-4030	F-4050	F-4075	F-6100	F-6200	F-6300
Rotor moment of inertia	kg-m ² (lb-in.-s ²)	0.0010 (0.009)	0.0021 (0.019)	0.0032 (0.029)	0.0064 (0.057)	0.0107 (0.095)	0.0162 (0.144)
Rotor moment of inertia (brake motors)	kg-m ² (lb-in.-s ²)	0.0011 (0.010)	0.0022 (0.020)	0.0033 (0.030)	0.007 (0.061)	0.011 (0.098)	0.017 (0.147)
Motor shipping weight	kg (lb)	11.0 (23.0)	15.8 (34.8)	21.5 (47.2)	25.2 (55.4)	33.5 (73.8)	46 (101.2)
Motor net weight	kg (lb)	9.0 (19.6)	14.1 (31.0)	14.1 (42.0)	22.3 (49.2)	30.9 (68.2)	43.2 (95.2)
Brake motor shipping weight	kg (lb)	12.5 (27.6)	17.8 (39.2)	23.9 (52.6)	30 (66.0)	38.4 (84.4)	51.4 (113.1)
Brake motor net weight	kg (lb)	10.9 (24.0)	16.0 (35.2)	21.2 (46.8)	27.1 (59.8)	35.6 (78.4)	48.0 (105.8)
Damping	N-m/kRPM (lb-in./kRPM)	0.06 (0.5)	0.10 (0.94)	0.15 (1.3)	0.16 (1.4)	0.24 (2.1)	0.37 (3.3)
Friction torque	N-m (lb-in.)	0.063 (0.56)	0.10 (0.94)	0.17 (1.5)	0.17 (1.5)	0.24 (2.1)	0.46 (4.1)
Maximum Operating Speed	rpm	4000	4000	3000	3000	3000	3000

F-Series Winding Specifications

Specifications	Units	F-4030	F-4050	F-4075	F-6100	F-6200	F-6300
Sine wave K_T torque Constant at 25°C ¹	N-m/A (lb-in./A)	0.54 (4.8)	0.54 (4.8)	0.73 (6.5)	0.71 (6.3)	0.70 (6.2)	0.73 (6.5)
Square wave K_T torque Constant at 25°C ²	N-m/A (lb-in./A)	0.60 (5.3)	0.60 (5.3)	0.80 (7.1)	0.78 (6.9)	0.80 (6.8)	0.81 (7.1)
K_E voltage constant ³	V/kRPM	66	66	89	86	85	89
Winding resistance Phase to phase at 25°C	Ohm	2.2	0.89	0.98	0.51	0.26	0.16
Winding inductance Phase to phase	mH	6.8	3.3	3.4	3.3	1.7	1.1
Thermal resistance ⁴	°C/Watt	0.63	0.48	0.40	0.45	0.37	0.30
Poles		8	8	8	8	8	8

¹ Peak value of per phase sine wave amps.

² Peak value of per phase square wave amps

³ Peak value of sinusoidal phase to phase volts

⁴ At 125°C winding temperature, in a 40°C ambient, with motor mounted on 0.5 in. x 12 in. x 12 in. aluminum heat sink.

Storage and Operating Specifications

Storage and Operating Conditions	
Ambient Temperature	Operating: 0 to 40°C (32 to 104°F) Storage: -30 to 70°C (-25 to 158°F)
Relative Humidity	5% to 95% non-condensing

F-Series Thermostat Specifications

Specifications	
Rated voltage	0 - 250V DC or 50/60 Hz AC ¹
Rated current	2.5A at power factor of 1.0 1.6A at power factor of 0.6
Maximum switching current	5 A
Contact resistance	Less than 0.10 Ohms maximum
Contacts	Normally closed
Insulation dielectric	Mylar Nomex capable of withstanding 1500V AC RMS 50/60 Hz for 1 minute
Opening temperature (±5°C)	140°C

¹ The thermostat is normally used as a switch for a 24V DC logic signal.

F-Series Standard Motor Radial Load Force Ratings

Specifications	Units	F-4030	F-4050	F-4075	F-6100	F-6200	F-6300
500 RPM	kg (lbs)	34.5 (76)	39.9 (88)	41.7 (92)	72.1 (159)	78.0 (172)	83.0 (183)
1000 RPM	kg (lbs)	27.2 (60)	31.3 (69)	33.1 (73)	57.1 (126)	61.7 (136)	65.8 (145)
2000 RPM	kg (lbs)	21.3 (47)	24.9 (55)	26.3 (58)	45.4 (100)	49.0 (108)	52.2 (115)
3000 RPM	kg (lbs)	18.6 (41)	21.8 (48)	23.1 (51)	39.5 (87)	42.6 (94)	45.8 (101)
4000 RPM	kg (lbs)	17.2 (38)	20.0 (44)	20.9 (46)	NA	NA	NA

Motors are capable of carrying an axial load in most applications according to the following general guidelines. These guidelines should only be used as approximations.

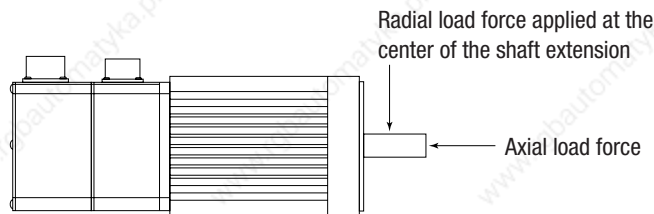

- When the motor shaft has no radial load, the axial load rating is 100% of the radial load rating from the table above.
- When the motor shaft has both a radial and an axial load, the axial load rating is 44% of the radial load rating from the table above.

ULTRA 100 Series Specifications for F-Series Motors¹

Specifications		F-4030	F-4050	F-4075	F-6100	F-6200	F-6300
Drive	1398-DDM	019	019	NA	NA	NA	NA
Maximum continuous operating speed ²	RPM	3600	3500	NA	NA	NA	NA
Continuous stall torque ^{3,4}	N-m (lb-in.)	3.5 (31)	5.2 (46)	NA	NA	NA	NA
Peak torque ⁵	N-m (lb-in.)	11.3 (100)	13.6 (120)	NA	NA	NA	NA

¹ Ambient temperature is 0°C to 40°C for motors and 0°C to 50°C for drives.

² With 230V AC line voltage input.

³ At 125°C winding temperature, in a 40°C ambient, with motor mounted on 0.5 in. x 12 in. x 12 in. aluminum heat sink.

⁴ Brake motor continuous stall torque derated by 15%.

⁵ System limit.

ULTRA 200 Series Specifications for F-Series Motors¹

Specifications		F-4030	F-4050	F-4075	F-6100	F-6200	F-6300
Drive	1398-DDM-	020	030	030/075	075	075/150	075/150
Maximum continuous operating speed ²	RPM	4000	4000	3000	3000	3000	3000
Continuous stall torque ^{3,4}	N-m (lb-in.)	3.5 (31)	6.9 (61)	9.3 (82)	13 (115)	19.8 (175)	23.7 (210)
Peak torque ⁵	N-m (lb-in.)	9.0 (80)	13.6 (120)	19.2 (170)	31.1 (275)	39.5 (350)	49.7/56.5 (440/500)

¹ Ambient temperature is 0°C to 40°C for motors and 0°C to 50°C for drives.

² With 230 V AC line voltage input.

³ At 125°C winding temperature, in a 40°C ambient, with motor mounted on 0.5 in. x 12 in. x 12 in. aluminum heat sink.

⁴ Brake motor continuous stall torque derated by 15%.

⁵ System limit.

ULTRA Plus Specifications for F-Series Motors¹

Specifications		F-4030	F-4050	F-4075	F-6100	F-6200	F-6300
Drive	1398-PDM-	20	30	30/75	75	75	75
Maximum continuous operating speed ²	RPM	4000	4000	3000	3000	3000	3000
Continuous stall torque ^{3,4}	N-m (lb-in.)	3.5 (31)	6.9 (61)	9.3 (82)	13 (115)	19.8 (175)	23.7 (210)
Peak torque ⁵	N-m (lb-in.)	9.0 (80)	13.6 (120)	19.2 (170)	31.1 (275)	39.5 (350)	49.7 (440)

¹ Ambient temperature is 0°C to 40°C for motors and 0°C to 50°C for drives.

² With 230 V AC line voltage input.

³ At 125°C winding temperature, in a 40°C ambient, with motor mounted on 0.5 in. x 12 in. x 12 in. aluminum heat sink.

⁴ Brake motor continuous stall torque derated by 15%.

⁵ System limit.

F-Series Brake Specifications

Specifications	F-4000	F-6000
Maximum backlash (brake engaged)	44 minutes	29 minutes
Holding torque	90 lb-in. (10.2 N-m)	300 lb-in. (22.6 N-m)
Coil current at 24V DC	0.88 ADC	1.13 ADC

Brake Motor Application Guidelines

The brakes offered as options on these servo motors are holding brakes. They are designed to hold the motor shaft at 0 rpm for up to the rated brake holding torque. The brakes are spring-set type, and release when voltage is applied to the brake coil.

The brakes are *not* designed for stopping rotation of the motor shaft. Servo drive inputs should be used to stop motor shaft rotation. The recommended method of stopping motor shaft rotation is to command the servo drive to decelerate the motor to 0 rpm, and engage the brake after the servo drive has decelerated the motor to 0 rpm.

If system main power fails, the brakes can withstand use as stopping brakes. However, use of the brakes as stopping brakes creates rotational mechanical backlash that is potentially damaging to the system, increases brake pad wear and reduces brake life. The brakes are *not* designed nor are they intended to be used as a safety device.

A separate power source is required to disengage the brake. This power source may be controlled by the servo motor controls, in addition to manual operator controls.

F-Series Standard Motors Dimensions

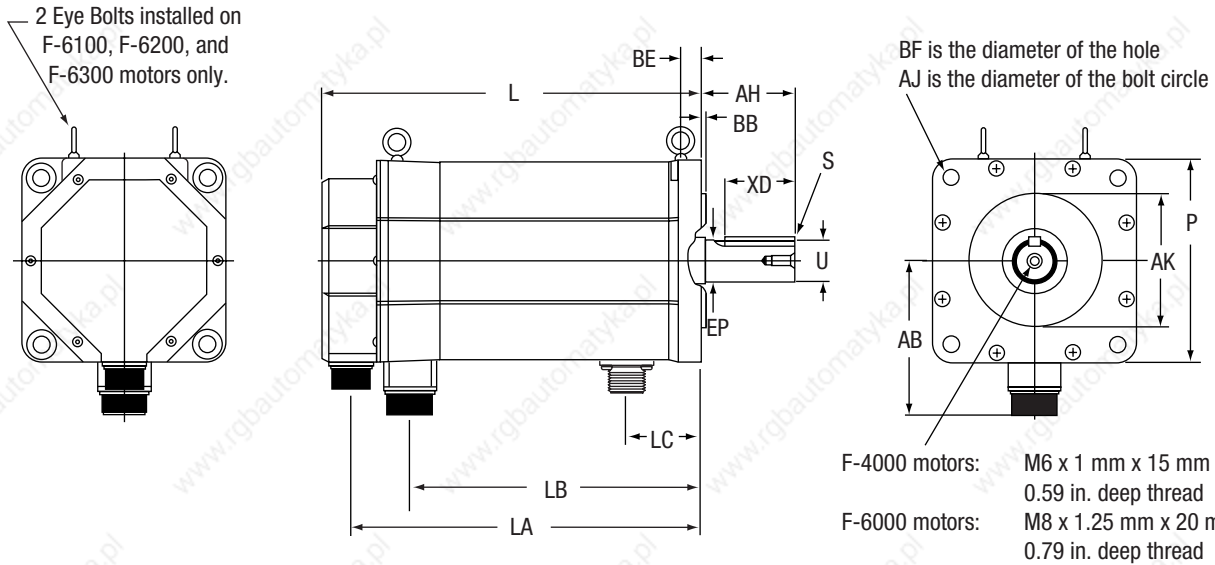

Dimensions	AB	AH	AJ	AK	BB	BE	BF	EP	L	L with brake	P	S	U	XD
Motor Models	mm (in.)	mm (in.)	mm (in.)	mm (in.)	mm (in.)	mm (in.)	mm (in.)	mm (in.)	mm (in.)	mm (in.)	mm (in.)	mm x mm (in. x in.)	mm (in.)	mm (in.)
F-4030	102 (4.02)	50 (1.97)	145 (5.71)	110 (4.33)	3 (0.12)	16 (0.64)	10 (0.39)	22.2 (0.875)	194 (7.64)	257 (10.12)	127 (5.00)	6 x 6 (0.24 x 0.24)	19 (0.75)	38 (1.49)
F-4050	102 (4.02)	50 (1.97)	145 (5.71)	110 (4.33)	3 (0.12)	16 (0.64)	10 (0.39)	22.2 (0.875)	272 (10.71)	335 (13.19)	127 (5.00)	6 x 6 (0.24 x 0.24)	19 (0.75)	38 (1.49)
F-4075	102 (4.02)	50 (1.97)	145 (5.71)	110 (4.33)	3 (0.12)	16 (0.64)	10 (0.39)	22.2 (0.875)	350 (13.78)	413 (16.26)	127 (5.00)	6 x 6 (0.24 x 0.24)	19 (0.75)	38 (1.49)
F-6100	131 (5.16)	80 (3.15)	200 (7.87)	114.3 (4.50)	4 (0.16)	19 (0.75)	13 (0.53)	36.5 (1.438)	255 (10.04)	326 (12.83)	173 (6.81)	10 x 8 (0.39 x 0.32)	35 (1.38)	60 (2.36)
F-6200	131 (5.16)	80 (3.15)	200 (7.87)	114.3 (4.50)	4 (0.16)	19 (0.75)	13 (0.53)	36.5 (1.438)	320 (12.60)	390 (15.35)	173 (6.81)	10 x 8 (0.39 x 0.32)	35 (1.38)	60 (2.36)
F-6300	131 (5.16)	80 (3.15)	200 (7.87)	114.3 (4.50)	4 (0.16)	19 (0.75)	13 (0.53)	36.5 (1.438)	420 (16.53)	490 (19.29)	173 (6.81)	10 x 8 (0.39 x 0.32)	35 (1.38)	60 (2.36)

Motors are manufactured to millimeter dimensions shown. Inch dimensions shown are appropriate conversions from millimeters. For further motor detail, engineering specification drawings are available upon request.

Note: Dimension EP is manufactured in inches.

Supplemental Motor Dimensions

Connector		F-4030	Brake	F-4050	Brake	F-4075	Brake	F-6100	Brake
Brake (mm/in)	LC	-	56/22.0	-	56/22.0	-	56/22.0	-	59/23.2
Encoder (mm/in)	LB	126/49.6	189/74.4	204/80.3	267/105.1	282/111.0	345/135.8	183/72.0	254/100.0
Power (mm/in)	LA	172/67.7	235/92.5	250/98.4	313/123.2	228/89.8	301/118.5	233/91.7	304/119.7

Connector		F-6200	Brake	F-6300	Brake
Brake (mm/in)	LC	-	59/23.2	-	59/23.2
Encoder (mm/in)	LB	248/97.6	318/125.2	348/137.0	418/164.6
Power (mm/in)	LA	298/117.3	368/144.9	398/156.7	468/184.2

F-4000 NEMA 56C Dimensions

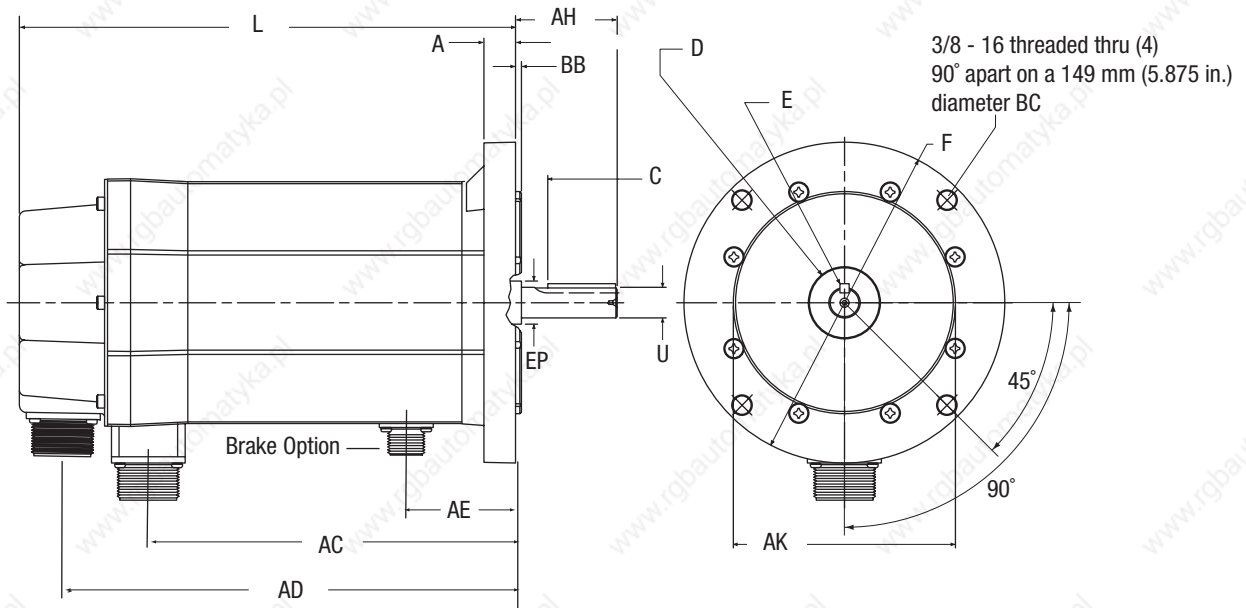

F-4000 NEMA 56C Dimensions, cont'd

Dimensions	F-4030 NEMA 56C	F-4050 NEMA 56C	F-4075 NEMA 56C
A	16.3 mm (0.64 in.)		
AH	52 mm (2.06 in.)		
AK	114.3 mm (4.500 in.) diameter		
BB	3 mm (0.12 in.)		
C	36 mm (1.41 in.) full depth		
D	Motor will accept 36.5 mm (1.437 in.) x 22.2 mm (0.875 in.) 6.3 mm (0.25 in.) shaft seal (optional, not included)		
E	Key supplied 4.8 mm (0.1875 in.) square x 35 mm (1.375 in.) long		
EP	22 mm (0.875 in.) diameter		
F	165 mm (6.50 in.) diameter		
L (without brake)	194 mm (7.64 in.)	272 mm (10.71 in.)	350 mm (13.78 in.)
L (with brake)	257 mm (10.12 in.)	335 mm (13.19 in.)	413 mm (16.26 in.)
U	15.9 mm (0.625 in.) diameter		

Supplemental Motor Dimensions

Connector		F-4030	Brake	F-4050	Brake	F-4075	Brake
Brake (mm/in)	AE	–	2.21/5.6	–	2.21/5.6	–	2.21/5.6
Encoder (mm/in)	AD	6.77/17.2	9.25/23.5	9.84/25.0	12.32/31.3	12.92/32.8	15.39/39.1
Power (mm/in)	AC	4.97/12.6	7.45/18.9	8.04/20.4	10.52/26.7	11.12/28.2	13.59/34.5

Encoder Data

Encoders are factory aligned and must not be adjusted outside the factory.

Specifications

Line Count	2000 ¹
Supply Voltage	5 VDC
Supply Current	250 mA max.
Line Driver	26LS31
Line Driver Output	TTL
Index Pulse	F-4000 and F-6000 Series when key faces the connectors (0° ± 10)

¹ Standard line count before quadrature.

Encoder Outputs

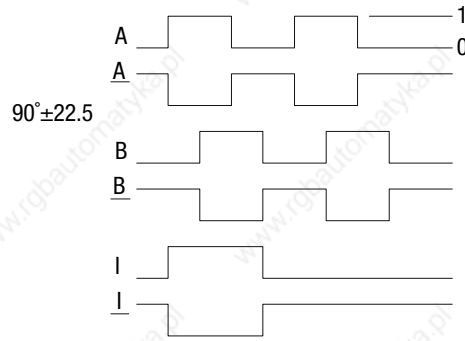

WAVEFORMS RESULT FROM CW SHAFT ROTATION
(CLOCKWISE AS VIEWED FACING THE SHAFT EXTENSION)

F-Series Connector Pins and Signals

Motor Power Connector (All F-Series Motors)

Pin	Signal
A	R
B	S
C	T
D	Motor Case

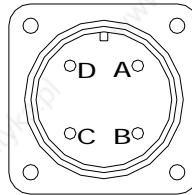

Motor Encoder Connector (F-4000 and F-6000 Motors)

Pin	Signal	Pin	Signal
A	A+	K	+5V DC
B	A-	L	COM
C	B+	M	COM
D	B-	N	Hall B
E	I+	P	Hall C
F	I-	R	TS+
G	Encoder Case	S	TS-
H	ABS	T	Hall A
J	+5V DC		

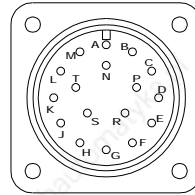
**Optional Motor Brake Connector (F-Series Motors with an 04 Designator)**

Pin	Signal
A	BR+
B	BR-

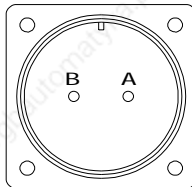

Wire and Contact Sizing Recommendations

Power Connector

The following connector contact sizes and wiring gages are recommended for cabling to a motor.

Motor	Contact AWG (mm ²)	Wire AWG (mm ²)
F-4030	12 (3.0)	16 (1.5)
F-4050		14 (2.5)
F-4075		
F-6100	8 (8.6)	12 (4)
F-6200		8 (10)
F-6300		

- Sizes are recommended minimum values for 4 conductors (R, S, T and GND).
- Wiring should be twisted.
- Local regulations should always be observed.

Encoder Connector

Contact AWG (mm ²)	Wire AWG (mm ²)
All F-Series 16 (1.5)	24 (0.25) 22 (0.34) with BRU Drives 22 (0.34) with BSA Drives

Brake Connector

Contact AWG (mm ²)	Wire AWG (mm ²)
All F-Series 16 (1.5)	18 (0.75)

- These specifications are the recommended minimum mechanical size.
- Local regulations should always be observed.

H-Series Motors



H-Series motors use a neodymium-iron-boron magnet to provide low inertias and high accelerations. Available in five frame sizes, the H-Series motors range in continuous torque capability from 0.5 to 50 N-m (5 to 450 lb-in.) and reach speeds up to 6000 RPM. The H-Series motors use an optical 2000-line incremental encoder with a 5000-line option for superior low-speed performance with the ULTRA Series. Typical applications for the H-Series include smart conveyors, packaging machinery, material feeding, pick-and-place machines, and high duty cycle applications. When you install the optional motor shaft seal, the motor meets the IP65 requirements of the IEC standard.

Features

The H-Series motors have the following features:

- Compact design that is mechanically interchangeable with the F-4000 and F-6000 Series motors
- Five frame sizes, twelve models
- Continuous torque from 0.5 to 50 N-m (5 to 450 lb-in.)
- Speeds up to 6000 RPM
- Neodymium-iron-boron permanent magnet rotors provide low inertias for high accelerations
- Internal thermal switch indicates overheating
- Motor-mounted optical encoder included 2000 quadrature pulses, index pulse, and standard commutation channels for trapezoidal drives
- Water tight MS connections are compatible with standard cable assemblies; in addition, the extruded aluminum housing and environmental connectors provide an IP65 package (with the addition of the optional shaft seal kit)
- Economical, compact design ready for harsh environments
- Optional spring-set holding brakes available with 24V DC
- Axially-trapped front bearing in a steel insert for long life at high speeds
- Vibration: 2.5 g peak 30-2000Hz
- Shock: 10.0 g peak 6 ms duration
- UL recognized

Typical Applications

Typical applications for the H-Series motors are:

- Smart conveyors
- Packaging machinery
- Punch press/material feeding
- Robotic pick-and-place
- High duty cycle applications

Characteristics

- High acceleration and peak torques
- High-speed point-to-point positioning
- Environmentally rugged

Selecting a Drive/Motor Combination

The following drive/motor combinations are available for the H-Series motors:

Motor	ULTRA 100	ULTRA 200	ULTRA Plus	
H-2005-K-H00AA	1398-DDM-009	1398-DDM-010	1398-PDM-10	
H-3007-N-H00AA	1398-DDM-009	1398-DDM-010	1398-PDM-10	
H-3016-N-H00AA	1398-DDM-019	1398-DDM-020	1398-PDM-20	
			1398-PDM-25	
H-4030-M-H00AA	NA	1398-DDM-030	1398-PDM-30	
H-4030-P-H00AA	1398-DDM-019	1398-DDM-020	1398-PDM-20	
			1398-PDM-25	
H-4050-P-H00AA	NA	1398-DDM-030	1398-PDM-30 ¹	
			1398-DDM-075	1398-PDM-75
				1398-PDM-50
H-4075-R-H00AA	NA	1398-DDM-030	1398-PDM-30 ²	
			1398-DDM-075	1398-PDM-75
				1398-PDM-50
H-6100-Q-H00AA	NA	1398-DDM-075	1398-PDM-75	
			1398-PDM-50	
H-6200-Q-H00AA	NA	1398-DDM-075	1398-PDM-75	
			1398-PDM-100	
H-6300-Q-H00AA	NA	1398-DDM-150	1398-PDM-150	
H-8350-S-H00AA	NA	1398-DDM-150	1398-PDM-100	
H-8500-S-H00AA	NA	1398-DDM-150	1398-PDM-150	

¹ Peak torque is limited to 13.5 N-m (119.5 lb-in.).

² Peak torque is limited to 19.8 N-m (175.2 lb-in.).

H-Series Specifications

This section contains the mechanical, thermostat and winding specifications for the H-Series motor family, as well as the load force ratings and performance specifications for every combination of ULTRA series drives and H-Series motors. It also provides motor dimensions, connector pin and signal designations, and all motor and connector ordering information.

H-Series Mechanical Specifications

Specifications	Units	H-2005	H-3007	H-3016	H-4030-M	H-4030-P	H-4050
Rotor moment of inertia	kg-m ² (lb-in.-s ²)	0.000015 (0.000013)	0.000030 (0.00027)	0.000080 (0.00072)	0.00025 (0.0022)	0.00025 (0.0022)	0.00046 (0.0041)
Rotor moment of inertia (brake motors)	kg-m ² (lb-in.-s ²)	NA	0.000038 (0.00034)	0.000089 (0.00079)	0.00033 (0.0029)	0.00033 (0.0029)	0.00054 (0.0048)
Motor shipping weight	kg (lb)	2.7 (6.0)	3.2 (7.0)	4.7 (10.4)	7.3 (16.1)	7.3 (16.1)	10.9 (24.0)
Motor net weight	kg (lb)	2.2 (4.9)	2.6 (5.8)	4.1 (9.0)	6.8 (14.9)	6.8 (14.9)	9.7 (21.4)
Brake motor shipping weight	kg (lb)	NA	3.8 (8.4)	5.5 (12.1)	9.4 (20.7)	9.4 (20.7)	12.7 (28.0)
Brake motor net weight	kg (lb)	NA	3.4 (7.5)	4.9 (10.8)	8.8 (19.4)	8.8 (19.4)	11.8 (26.0)
Damping	N-m/kRPM (lb-in./kRPM)	0.007 (0.06)	0.010 (0.09)	0.014 (0.12)	0.034 (0.30)	0.034 (0.30)	0.045 (0.40)
Friction torque	N-m (lb-in.)	0.014 (0.12)	0.014 (0.12)	0.028 (0.25)	0.034 (0.30)	0.034 (0.30)	0.068 (0.60)
Maximum Operating Speed	rpm	6000	5000	5000	4000	4000	4000

Specifications	Units	H-4075	H-6100	H-6200	H-6300	H-8350	H-8500
Rotor moment of inertia	kg-m ² (lb-in.-s ²)	0.00068 (0.0060)	0.0014 (0.012)	0.0024 (0.021)	0.0034 (0.030)	0.0063 (0.056)	0.0094 (0.083)
Rotor moment of inertia (brake motors)	kg-m ² (lb-in.-s ²)	0.00076 (0.0067)	0.0017 (0.015)	0.0027 (0.024)	0.0037 (0.033)	0.0093 (0.082)	0.012 (0.109)
Motor shipping weight	kg (lb)	14.1 (31.1)	19.2 (42.3)	28.6 (63.0)	37.7 (83.1)	46.8 (103)	58.1 (128)
Motor net weight	kg (lb)	12.9 (28.4)	18.3 (40.4)	27.0 (59.4)	34.8 (76.8)	44.1 (97)	56.1 (123.6)
Brake motor shipping weight	kg (lb)	16.0 (35.3)	23.8 (52.5)	32.9 (72.5)	42.2 (93.0)	53.5 (118)	64.9 (143)
Brake motor net weight	kg (lb)	14.9 (32.8)	22.5 (49.5)	31.6 (69.5)	39.2 (86.4)	50.9 (112)	61.8 (136)
Damping	N-m/kRPM (lb-in./kRPM)	0.068 (0.60)	0.10 (0.90)	0.16 (1.4)	0.19 (1.7)	0.38 (3.4)	0.43 (3.8)

Specifications	Units	H-4075	H-6100	H-6200	H-6300	H-8350	H-8500
Friction torque	N-m (lb-in.)	0.14 (1.2)	0.14 (1.2)	0.24 (2.1)	0.36 (3.2)	0.32 (2.8)	0.40 (3.5)
Maximum Operating Speed	rpm	3000	3000	3000	3000	2000	2000

H-Series Winding Specifications

Specifications	Units	H-2005	H-3007	H-3016	H-4030-M	H-4030-P	H-4050
Sine wave K_T torque Constant at 25°C ¹	N-m/A (lb-in./A)	0.13 (1.2)	0.28 (2.5)	0.28 (2.5)	0.25 (2.2)	0.50 (4.4)	0.50 (4.4)
Square wave K_T torque Constant at 25°C ²	N-m/A (lb-in./A)	0.14 (1.3)	0.31 (2.7)	0.31 (2.7)	0.27 (2.4)	0.54 (4.8)	0.54 (4.8)
K_E voltage constant ³	V/kRPM	16	34	34	30	60	60
Winding resistance Phase to phase at 25°C	Ohm	2.6	6.6	1.3	0.5	2.0	0.69
Winding inductance Phase to phase	mH	4.1	12	3.4	1.9	9.0	3.3
Thermal resistance ⁴	°C/Watt	1.5	1.2	0.89	0.79	0.79	0.57
Poles		4	6	6	6	6	6

Specifications	Units	H-4075	H-6100	H-6200	H-6300	H-8350	H-8500
Sine wave K_T torque Constant at 25°C ¹	N-m/A (lb-in./A)	0.74 (6.6)	0.68 (6.0)	0.66 (5.8)	0.70 (6.2)	0.86 (7.6)	0.92 (8.2)
Square wave K_T torque Constant at 25°C ²	N-m/A (lb-in./A)	0.81 (7.2)	0.74 (6.6)	0.72 (6.4)	0.77 (6.8)	0.94 (8.3)	1.0 (9.0)
K_E voltage constant ³	V/kRPM	90	82	80	85	104	112
Winding resistance Phase to phase at 25°C	Ohm	0.90	0.49	0.18	0.12	0.13	0.10
Winding inductance Phase to phase	mH	5.4	4.4	2.2	1.2	2.5	2.4
Thermal resistance ⁴	°C/Watt	0.48	0.34	0.31	0.24	0.23	0.21
Poles		6	8	8	8	8	8

¹ Peak value of per phase sine wave amps.

² Peak value of per phase square wave amps

³ Peak value of sinusoidal phase to phase volts

⁴ At 125°C winding temperature, in a 40°C ambient; motors 3007, 3016 mounted 0.25 in. x 10 in. x 10 in.; motors 4030, 4050, 4075 mounted on 0.5 in. x 12 in. x 12 in.; motors 6100, 6200, 6300, 8350, 8500 mounted on 1 in. x 12 in. x 12 in. aluminum heat sink.

Storage and Operating Specifications

Storage and Operating Conditions	
Ambient Temperature	Operating: 0 to 40°C (32 to 104°F) Storage: -30 to 70°C (-25 to 158°F)
Relative Humidity	5% to 95% non-condensing

H-Series Thermostat Specifications

Specifications	
Rated voltage	0 - 250V DC or 50/60 Hz AC ¹
Rated current	2.5A at power factor of 1.0 1.6A at power factor of 0.6
Maximum switching current	5 A
Contact resistance	Less than 0.10 Ohms maximum
Contacts	Normally closed
Insulation dielectric	Mylar Nomex capable of withstanding 1500V AC RMS 50/60 Hz for 1 minute
Opening temperature (±5°C)	140°C

¹ The thermostat is normally used as a switch for a 24V DC logic signal.

H-Series Standard Motor Radial Load Force Ratings

Ratings	Units	H-2005	H-3007	H-3016	H-4030-M	H-4030-P	H-4050
500 RPM	kg (lbs)	63.5 (105)	68.0 (113)	76.2 (126)	102.1 (169)	102.1 (169)	123.8 (205)
1000 RPM	kg (lbs)	50.8 (84)	54.4 (90)	60.8 (101)	91.6 (152)	91.6 (152)	98.9 (164)
2000 RPM	kg (lbs)	39.9 (66)	43.1 (71)	47.6 (79)	72.6 (120)	72.6 (120)	78.0 (129)
3000 RPM	kg (lbs)	34.9 (58)	37.6 (62)	41.7 (69)	63.5 (105)	63.5 (105)	68.0 (113)
4000 RPM	kg (lbs)	31.8 (53)	34.0 (56)	38.1 (63)	57.6 (95)	57.6 (95)	62.1 (103)
5000 RPM	kg (lbs)	29.5 (49)	31.8 (53)	35.4 (59)	NA	NA	NA
6000 RPM	kg (lbs)	20.4 (45)	NA	NA	NA	NA	NA

Ratings	Units	H-4075	H-6100	H-6200	H-6300	H-8350	H-8500
500 RPM	kg (lbs)	129.7 (215)	263.1 (435)	283.5 (469)	299.4 (495)	299.4 (495)	313.0 (518)
1000 RPM	kg (lbs)	104.3 (173)	208.7 (345)	226.8 (375)	235.9 (390)	238.1 (394)	249.5 (413)
2000 RPM	kg (lbs)	82.6 (137)	165.6 (274)	179.2 (296)	188.2 (311)	188.2 (311)	197.3 (326)
3000 RPM	kg (lbs)	71.2 (118)	145.2 (240)	156.5 (259)	163.3 (270)	NA	NA
4000 RPM	kg (lbs)	65.3 (108)	NA	NA	NA	NA	NA

Motors are capable of carrying an axial load in most applications according to the following general guidelines. These guidelines should only be used as approximations.

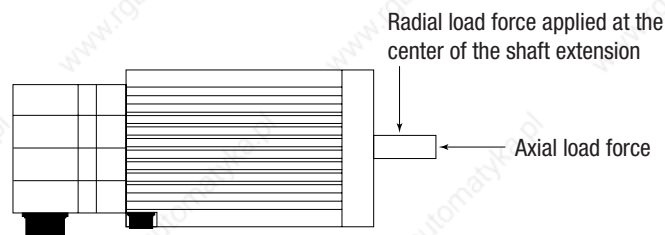

- When the motor shaft has no radial load, the axial load rating is 100% of the radial load rating from the table above.
- When the motor shaft has both a radial and an axial load, the axial load rating is 44% of the radial load rating from the table above.

ULTRA 100 Series Specifications for H-Series Motors¹

Specifications		H-2005	H-3007	H-3016	H-4030-M	H-4030-P	H-4050
Drive	1398-DDM-	009	009	019	NA	019	NA
Maximum continuous operating speed ²	RPM	6000	5000	5000	NA	4000	NA
Continuous stall torque ³	N-m (lb-in.)	0.57 (5)	0.79 (7)	2.26 (20)	NA	3.39 (30)	NA
Peak torque ⁴	N-m (lb-in.)	1.6 (14)	2.48 (22)	4.97 (44)	NA	8.25 (73)	NA

Specifications	Units	H-4075	H-6100	H-6200	H-6300	H-8350	H-8500
Drive	1398-DDM-	NA	NA	NA	NA	NA	NA
Maximum continuous operating speed ²	RPM	NA	NA	NA	NA	NA	NA
Continuous stall torque ³	N-m (lb-in.)	NA	NA	NA	NA	NA	NA
Peak torque ⁴	N-m (lb-in.)	NA	NA	NA	NA	NA	NA

¹ Ambient temperature is 0°C to 40°C for motors and 0°C to 50°C for drives.

² With 230 V AC line voltage input.

³ At 125°C winding temperature, in a 40°C ambient; motors 3007, 3016 mounted 0.25 in. x 10 in. x 10 in.; motors 4030, 4050, 4075 mounted on 0.5 in. x 12 in. x 12 in.; motors 6100, 6200, 6300, 8350, 8500 mounted on 1 in. x 12 in. x 12 in. aluminum heat sink.

⁴ System limit.

ULTRA 200 Series Specifications for H-Series Motors¹

Specifications		H-2005	H-3007	H-3016	H-4030-M	H-4030-P	H-4050
Drive	1398-DDM-	010	010	020	030	020	030/075
Maximum continuous operating speed ²	RPM	6000	5000	5000	4000 ⁵	4000	4000/4000
Continuous stall torque ³	N-m (lb-in.)	0.57 (5.0)	0.79 (7.0)	2.3 (20)	3.4 (30)	3.4 (30)	6.8 (60)
Peak torque ⁴	N-m (lb-in.)	1.2 (10)	2.5 (22)	5.0 (44)	6.8 (60)	8.3 (73)	13.6/21.5 (120/190)

Specifications		H-4075	H-6100	H-6200	H-6300	H-8350	H-8500
Drive	1398-DDM-	030/075	075	075	150	150	150
Maximum continuous operating speed ²	RPM	3000/3000	3000	3000	3000	2000	2000
Continuous stall torque ³	N-m (lb-in.)	9.9 (88)	12.4 (110)	21.4 (190)	36.7 (300)	39.5 (350)	50.8 (450)
Peak torque ⁴	N-m (lb-in.)	20.3/30.5 (180/270)	32.8 (290)	40.7 (360)	79.1 (700)	67.8 (600)	108 (960)

¹ Ambient temperature is 0°C to 40°C for motors and 0°C to 50°C for drives.

² With 230V AC line voltage input.

³ At 125°C winding temperature, in a 40°C ambient; motors 3007, 3016 mounted on 0.25 in. x 10 in. x 10 in.; motors 4030, 4050, 4075 mounted on 0.5 in. x 12 in. x 12 in.; motors 6100, 6200, 6300, 8350, 8500 mounted on 1 in. x 12 in. x 12 in. aluminum heat sink.

⁴ System limit.

⁵ With either 115 or 230V AC line voltage input.

ULTRA Plus Specifications for H-Series Motors¹

Specifications		H-2005	H-3007	H-3016	H-4030-M	H-4030-P	H-4050
Drive	1398-PDM-	10	10	20	30	20	30/75
Maximum continuous operating speed ²	RPM	6000	5000	5000	4000 ⁵	4000	4000/4000
Continuous stall torque ³	N-m (lb-in.)	0.57 (5.0)	0.79 (7.0)	2.3 (20)	3.4 (30)	3.4 (30)	6.8 (60)
Peak torque ⁴	N-m (lb-in.)	1.2 (10)	2.5 (22)	5.0 (44)	6.8 (60)	8.3 (73)	13.6/21.5 (120/190)

Specifications		H-4075	H-6100	H-6200	H-6300	H-8350	H-8500
Drive	1398-PDM-	30/75	75	75	150	NA	150
Maximum continuous operating speed ²	RPM	3000/3000	3000	3000	3000	NA	2000
Continuous stall torque ³	N-m (lb-in.)	9.9 (88)	11.30 (100)	20.9 (185)	36.7 (325)	NA	50.8 (450)
Peak torque ⁴	N-m (lb-in.)	20.3/30.5 (180/270)	25.42 (225)	40.68 (360)	79.1 (700)	NA	108 (960)

¹ Ambient temperature is 0°C to 40°C for motors and 0°C to 50°C for drives.

² With 230V AC line voltage input.

³ At 125°C winding temperature, in a 40°C ambient; motors 3007, 3016 mounted 0.25in. x 10 in. x 10 in.; motors 4030, 4050, 4075 mounted on 0.5 in. x 12 in. x 12 in.; motors 6100, 6200, 6300, 8350, 8500 mounted on 1 in. x 12 in. x 12 in. aluminum heat sink.

⁴ System limit.

⁵ With either 115 or 230V AC line voltage input.

H-Series Brake Specifications

Specifications	H-3000	H-4000	H-6000	H-8000
Maximum backlash (brake engaged)	1 degree, 30 minutes	44 minutes	29 minutes	21 minutes
Holding torque	2.26 N-m (20 lb-in.)	10.2 N-m (90 lb-in.)	22.6 N-m (200 lb-in.)	50.8 N-m (450 lb-in.)
Coil current at 24V DC	0.6 ADC	0.88 ADC	1.13 ADC	2.2 ADC
Coil current at 90V DC	0.21 ADC	0.26 ADC	0.33 ADC	0.62 ADC

Brake Motor Application Guidelines

The brakes offered as options on these servo motors are holding brakes. They are designed to hold the motor shaft at 0 rpm for up to the rated brake holding torque. The brakes are spring-set type, and release when voltage is applied to the brake coil.

The brakes are *not* designed for stopping rotation of the motor shaft. Servo drive inputs should be used to stop motor shaft rotation. The recommended method of stopping motor shaft rotation is to command the servo drive to decelerate the motor to 0 rpm, and engage the brake after the servo drive has decelerated the motor to 0 rpm.

If system main power fails, the brakes can withstand use as stopping brakes. However, use of the brakes as stopping brakes creates rotational mechanical backlash that is potentially damaging to the system, increases brake pad wear and reduces brake life. The brakes are *not* designed nor are they intended to be used as a safety device.

A separate power source is required to disengage the brake. This power source may be controlled by the servo motor controls, in addition to manual operator controls.

H-Series Standard Motors Dimensions

Dimensions	Thread	Thread/Depth
H-2000	M3 x 0.5 mm	10 mm/0.39 in.
H-3000	M4 x 0.7 mm	10 mm/0.39 in.
H-4000	M6 x 1.0 mm	15 mm/0.59 in.
H-6000	M8 x 1.25 mm	20 mm/0.79 in.
H-8000	M8 x 1.25 mm	20 mm/0.79 in.

H-2000 Motors Dimensions (see page 34 for dimension values)

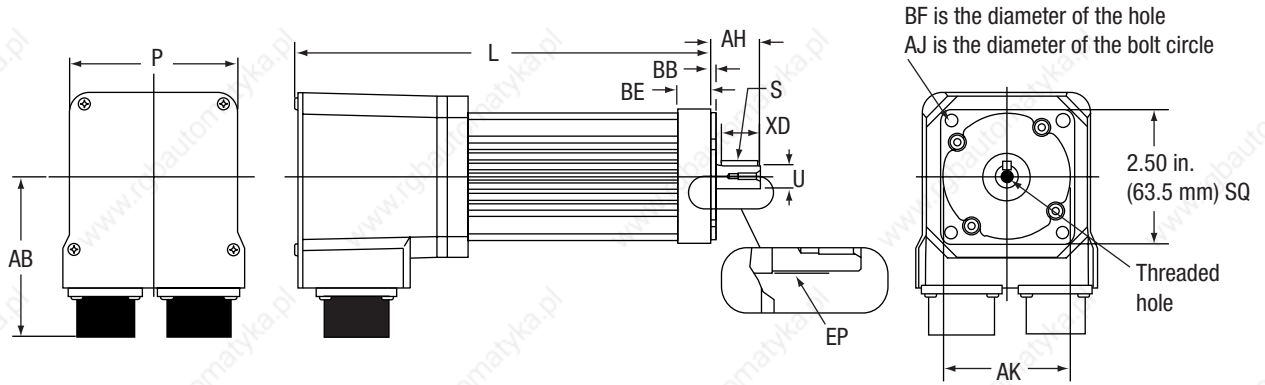

H-3000, -4000, -6000, and -8000 Motors Dimensions (see page 34 for dimension values)

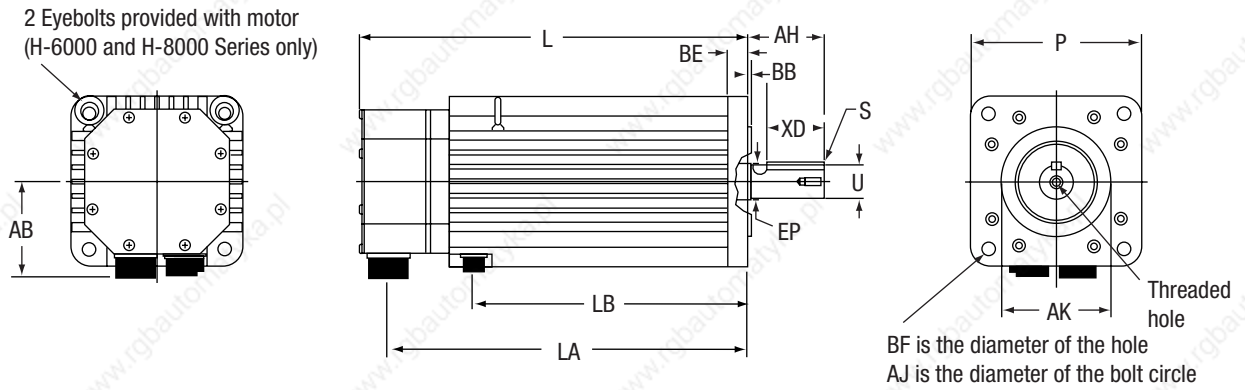

Dimensions	AB	AH ³	AJ	AK	BB ⁴	BE	BF	EP	L	L with brake	P	S	U	XD
Motor Models	mm (in.)	mm (in.)	mm (in.)	mm (in.)	mm (in.)	mm (in.)	mm (in.)	mm (in.)	mm (in.)	mm (in.)	mm (in.)	mm x mm (in. x in.)	mm (in.)	mm (in.)
H-2005	75 (2.95)	23 (0.93)	75 (2.95)	60 ¹ (2.36)	2.4 (0.09)	15.2 (0.60)	5.8 (0.23)	12 (0.47)	197 (7.7)	NA	80 (3.15)	4 x 4 (0.16 x 0.16)	11 ² (0.43)	18 (0.71)
H-3007	75 (2.95)	30 (1.18)	100 (3.94)	80 ¹ (3.15)	3 (0.12)	10.9 (0.43)	7 (0.28)	15 (0.59)	172 (6.77)	211 (8.31)	89 (3.50)	5 x 5 (0.20 x 0.20)	14 ² (0.55)	20 (0.79)
H-3016	75 (2.95)	30 (1.18)	100 (3.94)	80 ¹ (3.15)	3 (0.12)	10.9 (0.43)	7 (0.28)	15 (0.59)	233 (8.77)	262 (10.31)	89 (3.50)	5 x 5 (0.20 x 0.20)	14 ² (0.55)	20 (0.79)
H-4030	76 (3.00)	50 (1.97)	145 (5.71)	110 ⁵ (4.33)	3 (0.12)	15.5 (0.61)	10 (0.39)	20 (0.79)	213 (8.39)	266 (10.47)	121 (4.76)	6 x 6 (0.24 x 0.24)	19 ⁶ (0.75)	40 (1.57)
H-4050	76 (3.00)	50 (1.97)	145 (5.71)	110 ⁵ (4.33)	3 (0.12)	15.5 (0.61)	10 (0.39)	20 (0.79)	264 (10.39)	317 (12.48)	121 (4.76)	6 x 6 (0.24 x 0.24)	19 ⁶ (0.75)	40 (1.57)
H-4075	76 (3.00)	50 (1.97)	145 (5.71)	110 ⁵ (4.33)	3 (0.12)	15.5 (0.61)	10 (0.39)	20 (0.79)	315 (12.40)	368 (14.49)	121 (4.76)	6 x 6 (0.24 x 0.24)	19 ⁶ (0.75)	40 (1.57)
H-6100	101 (4.00)	80 (3.15)	200 (7.87)	114.3 ⁵ (4.50)	4 (0.16)	21.3 (0.84)	13.5 (0.53)	38 (1.50)	277 (10.91)	330 (12.99)	178 (7.01)	10 x 8 (0.39 x 0.31)	35 ⁷ (1.38)	60 (2.36)
H-6200	101 (4.00)	80 (3.15)	200 (7.87)	114.3 ⁵ (4.50)	4 (0.16)	21.3 (0.84)	13.5 (0.53)	38 (1.50)	353 (13.90)	406 (15.98)	178 (7.01)	10 x 8 (0.39 x 0.31)	35 ⁷ (1.38)	60 (2.36)
H-6300	101 (4.00)	80 (3.15)	200 (7.87)	114.3 ⁵ (4.50)	4 (0.16)	21.3 (0.84)	13.5 (0.53)	38 (1.50)	429 (16.89)	442 (17.40)	178 (7.01)	10 x 8 (0.39 x 0.31)	35 ⁷ (1.38)	60 (2.36)
H-8350	112 (4.41)	85 (3.35)	265 (10.43)	230 ⁸ (9.06)	4 (0.16)	22.4 (0.88)	15 (0.59)	45 (1.77)	375 (14.76)	478 (18.82)	241 (9.49)	12 x 8 (0.41 x 0.31)	42 ⁷ (1.65)	60 (2.36)
H-8500	112 (4.41)	85 (3.35)	265 (10.43)	230 ⁸ (9.06)	4 (0.16)	22.4 (0.88)	15 (0.59)	45 (1.77)	426 (16.77)	529 (20.83)	241 (9.49)	12 x 8 (0.41 x 0.31)	42 ⁷ (1.65)	60 (2.36)

1 Tolerance is -0.0012 in. (-0.03 mm).

2 Tolerance is -0.0004 in. (-0.01 mm).

3 Tolerance is ±0.0196 in. (±0.5 mm).

4 Tolerance is ±0.0079 in. (±0.2 mm).

5 Tolerance is -0.0014 in. (-0.035 mm).

6 Tolerance is -0.0051 in. (-0.013 mm).

7 Tolerance is -0.0006 in. (-0.16 mm).

8 Tolerance is -0.0181 in. (-0.46 mm).

Supplemental Motor Dimensions

Connector		H-2005	H-3007	Brake	H-3016	Brake	H-4030	Brake	H-4050	Brake	H-4075	Brake
Brake (mm/in)	LC	-	-	107/4.21	-	158/6.22	-	160/6.30	-	211/8.31	-	262/10.31
Encoder (mm/in)	LB	167/6.58	143/5.63	181/7.13	194/7.64	232/9.13	184/7.24	236/9.29	235/9.25	287/11.30	286/11.26	338/13.30
Power (mm/in)	LA											

Connector		H-6100	Brake	H-6200	Brake	H-6300	Brake	H-8350	Brake	H-8500	Brake
Brake (mm/in)	LB	-	189/7.44	-	265/10.43		341/13.42		334/13.13		384/15.13
Encoder (mm/in)	LA	251/9.88	299/11.77	327/12.87	375/14.76	403/15.87	451/17.75	326/12.83	429/16.83	377/14.83	480/18.83
Power (mm/in)											

H-4000 NEMA 56C Dimensions

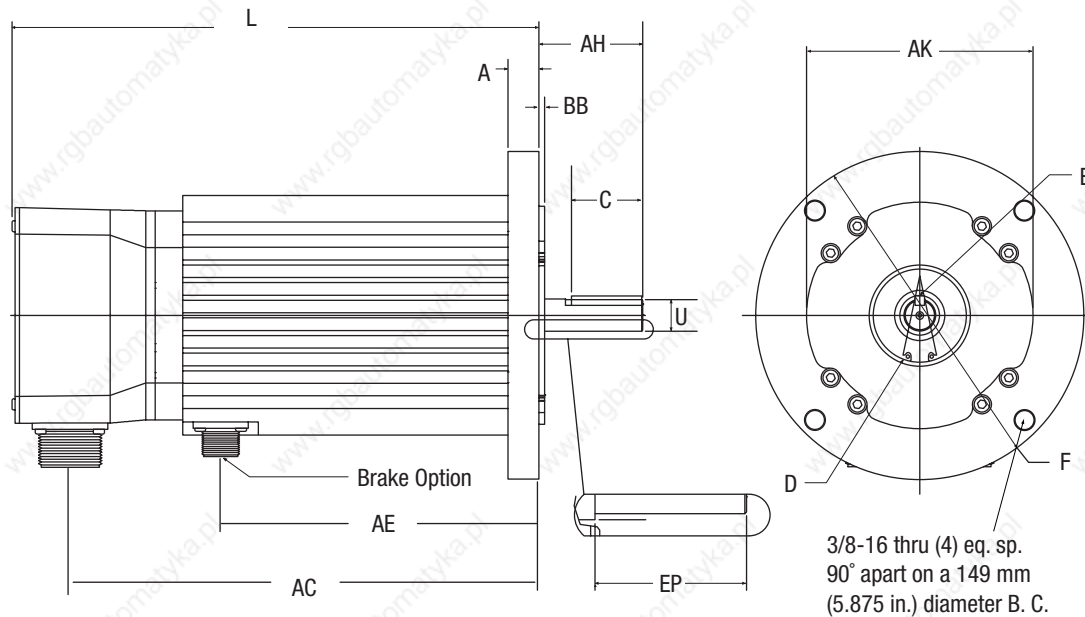

Dimensions	H-4030 NEMA 56C	H-4050 NEMA 56C	H-4075 NEMA 56C
A	15.5 mm (0.61 in.)		
AH	52 mm (2.06 in.)		
AK	114.3 mm (4.500 in.) diameter		
BB	3 mm (0.12 in.)		
C	36 mm (1.41 in.) full depth		
D	Motor will accept 47 mm (1.850 in.) x 20 mm (0.788 in.) 7 mm (0.276 in.) shaft seal (optional, not included)		
E	Key supplied 4.8 mm (0.1875 in.) square x 35 mm (1.375 in.) long		
EP	50.8 mm (2.00 in.) diameter		
F	165 mm (6.50 in.) diameter		
L (without brake)	213 mm (8.39 in.)	264 mm (10.39 in.)	315 mm (12.40 in.)
L (with brake)	266 mm (10.47 in.)	317 mm (12.48 in.)	368 mm (14.49 in.)
U	15.9 mm (0.625 in.) diameter		

Supplemental Motor Dimensions

	Brake (AE)	Power (AC)	Encoder (AC)
Motors	(in/mm)	(in/mm)	(in/mm)
H-4030	–	7.24/184	7.24/184
H-4030 Brake	6.30/160	9.29/236	9.29/236
H-4050	–	9.25/235	9.25/235
H-4050 Brake	8.31/211	11.30/287	11.30/287
H-4075	–	11.26/286	11.26/286
H-4075 Brake	10.31/262	13.30/338	13.30/338

Encoder Data

Encoders are factory aligned and must not be adjusted outside the factory.

Specifications	
Line Count	2000 ¹
Supply Voltage	5 VDC
Supply Current	250 mA max.
Line Driver	26LS31
Line Driver Output	TTL
Index Pulse	H-2000 and H-3000 Series when key faces 180° ± 10 away from the connectors
	H-4000, H-6000 and H-8000 Series when key faces the connectors (0° ± 10)

¹ Standard line count before quadrature.

Encoder Outputs

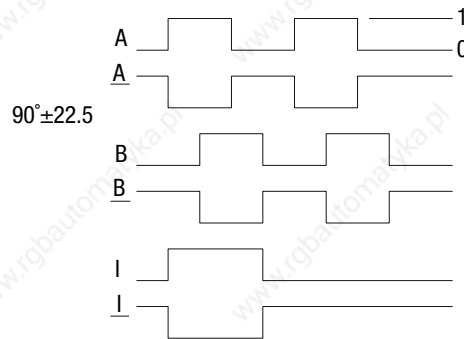

WAVEFORMS RESULT FROM CW SHAFT ROTATION
(CLOCKWISE AS VIEWED FACING THE SHAFT EXTENSION)

H-Series Connector Pins and Signals

Motor Power Connector (All H-Series Motors)

Pin	Signal
A	R
B	S
C	T
D	Motor Case

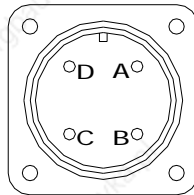

Motor Encoder Connector

Pin	Signal	Pin	Signal
A	A+	K	+5V DC
B	A-	L	COM
C	B+	M	COM
D	B-	N	Hall B
E	I+	P	Hall C
F	I-	R	TS+
G	Encoder Case	S	TS-
H	ABS	T	Hall A
J	+5V DC		

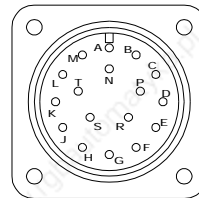

Optional Motor Brake Connector

Pin	Signal
A	BR+
B	BR-

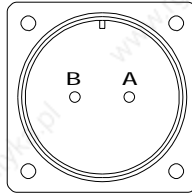

Wire and Contact Sizing Recommendations

Power Connector

The following connector contact sizes and wiring gages are recommended for cabling to a motor.

Motor	Contact AWG (mm ²)	Wire AWG (mm ²)
H-2005	16 (1.5)	16 (1.5)
H-3007		
H-3016		
H-4030	12 (4.0)	14 (2.5)
H-4050		
H-4075		
H-6100	8 (8.6)	12 (4.0)
H-6200		8 (10.0)
H-6300		
H-8350	4 (21.6)	6 (16.0)
H-8500		

- Sizes are recommended minimum values for 4 conductors (R, S, T and GND).
- Wiring should be twisted.
- Local regulations should always be observed.

Encoder Connector

Contact AWG (mm ²)	Wire AWG (mm ²)
All H-Series 16 (1.5)	24 (0.25) with ULTRA Plus Series Drives
	22 (0.34) with ULTRA Series 100-200 Drives

Brake Connector

Contact AWG (mm ²)	Wire AWG (mm ²)
All H-Series 16 (1.5)	18 (0.75)

- These specifications are the recommended minimum mechanical size.
- Local regulations should always be observed.

Y-Series Motors

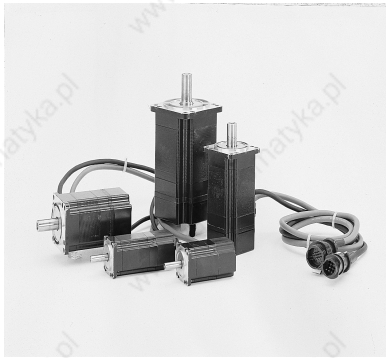

Y-Series motors, available in either 115V or 230V windings, use high energy neodymium magnets that provide low inertias for fast accelerations.

Available in three popular metric frame sizes, the Y-Series motors range in continuous torque capability from 0.17 to 2.5 N-m (1.5 to 22 lb-in.) and reach speeds up to 4500 RPM. Their outstanding torque-to-size ratios make the Y-Series a powerful combination with the ULTRA 100 and 200 drives. Typical applications for the Y-Series include robotics, material handling, X-Y tables, specialty machinery, and semiconductor manufacturing. IP43 enclosure protection is standard.

Features

The Y-Series motors have the following features:

- 115V and 230V windings
- Popular metric mounting dimensions
- Three frame sizes, ten models
- Continuous torque from 0.17 to 2.5 N-m (1.5 to 22 lb-in.)
- Motor-mounted optical encoder with differential line driver data (2000-line) and commutation signal
- Low inertia rotor
- High energy neodymium magnets
- Speeds up to 4500 RPM
- Optional internally mounted spring set, magnetic release 24V DC holding brake
- IP43 package
- Vibration: 2.5 g peak 30-2000 Hz
- Shock: 10.0 g peak 6 ms duration

Typical Applications

Typical applications for the Y-Series motors are:

- Robotics
- Material handling
- Specialty machinery
- Medical and laboratory equipment
- X-Y tables
- Light packaging machines
- Office machinery
- Postal sorting

Selecting a Drive/Motor Connection

The following drive/motor combinations are available for the Y-Series motors:

Motor	ULTRA 100	ULTRA 200	ULTRA Plus
Y-1002-1-H00AA	1398-DDM-005	1398-DDM-010	NA
Y-1002-2-H00AA	1398-DDM-005	1398-DDM-010	NA
Y-1003-1-H00AA	1398-DDM-009	1398-DDM-010	NA
Y-1003-2-H00AA	1398-DDM-005	1398-DDM-010	NA
Y-2006-1-H00AA	1398-DDM-019	1398-DDM-010	NA
Y-2006-2-H00AA	1398-DDM-009	1398-DDM-020	NA
Y-2012-1-H00AA	1398-DDM-019	1398-DDM-020	NA
Y-2012-2-H00AA	1398-DDM-009	1398-DDM-010	NA
Y-3023-2-H00AA	1398-DDM-019	1398-DDM-020	NA

Y-Series Specifications

This section contains the mechanical, thermostat and winding specifications for the Y-Series motor family, as well as the load force ratings and performance specifications for every combination of ULTRA series drives and Y-Series motors. It also provides motor dimensions, connector pin and signal designations, and all motor and connector ordering information.

Y-Series Mechanical Specifications

Specifications	Units	Y-1002-1 Y-1002-2	Y-1003-1 Y-1003-2	Y-2006-1 Y-2006-2	Y-2012-1 Y-2012-2	Y-3023-2
Rotor moment of inertia	kg-m ² (lb-in.-s ²)	0.000031 (0.000027)	0.000051 (0.000045)	0.000015 (0.00013)	0.000026 (0.00023)	0.000064 (0.00056)
Rotor moment of inertia (brake motors)	kg-m ² (lb-in.-s ²)	0.000039 (0.000034)	0.000059 (0.000052)	0.000020 (0.00018)	0.000032 (0.00028)	0.000069 (0.00062)
Motor shipping weight	kg (lb)	0.9 (2.0)	1.0 (2.3)	1.7 (3.8)	2.3 (5.1)	3.9 (8.7)
Motor net weight	kg (lb)	0.5 (1.1)	0.7 (1.5)	1.3 (2.9)	1.9 (4.1)	3.5 (7.8)
Damping	N-m/kRPM (lb-in./kRPM)	0.002 (0.022)	0.003 (0.03)	0.009 (0.08)	0.01 (0.10)	0.021 (0.19)
Friction torque	N-m (lb-in.)	0.005 (0.04)	0.007 (0.06)	0.022 (0.20)	0.03 (0.29)	0.072 (0.64)
Maximum Operating Speed	rpm	4500	4500	4500	4500	4500

Y-Series Winding Specifications

Specifications	Units	Y-1002-		Y-1003-		Y-2006-		Y-2012-		Y-3023-2
		1	2	1	2	1	2	1	2	
Sine wave K_T torque Constant at 25°C ¹	N-m/A (lb-in./A)	0.08 (0.73)	0.16 (1.4)	0.11 (1.0)	0.20 (1.8)	0.10 (0.95)	0.22 (1.9)	0.24 (2.1)	0.37 (3.3)	0.33 (2.9)
Square wave K_T torque Constant at 25°C ²	N-m/A (lb-in./A)	0.09 (0.8)	0.18 (1.6)	0.12 (1.1)	0.22 (2.0)	0.12 (1.1)	0.24 (2.2)	0.26 (2.3)	0.40 (3.6)	0.36 (3.2)
K_E voltage constant ³	V/kRPM	10	20	14	25	13	27	29	45	40
Winding resistance Phase to phase at 25°C	Ohm	4.6	18.8	3.2	8.9	0.79	3.2	1.3	2.9	0.78
Winding inductance Phase to phase	mH	5.5	22.3	3.8	11.5	2.7	12	5.1	12.4	6
Thermal resistance ⁴	°C/Watt	2.3	2.3	2.2	2.2	1.3	1.3	1.3	1.3	0.85
Encoder resolution	P/R	2000	2000	2000	2000	2000	2000	2000	2000	2000
Poles		8	8	8	8	8	8	8	8	8

¹ Peak value of per phase sine wave amps.

² Peak value of per phase square wave amps

³ Peak value of sinusoidal phase to phase volts

⁴ At 125°C winding temperature, in a 40°C ambient, with motor mounted on aluminum heat sinks: motors 1002, 1003—0.125 in. x 6 in. x 6 in.; motors 2006, 2012—0.250 in. x 8 in. x 8 in.; motor 3023—0.25 in. x 10 in. x 10 in.

Storage and Operating Specifications

Storage and Operating Conditions	
Ambient Temperature	Operating: 0 to 40°C (32 to 104°F) Storage: -20 to 65°C (-4 to 149°F)
Relative Humidity	20% to 90% non-condensing

Brake Motor Application Guidelines

The brakes offered as options on these servo motors are holding brakes. They are designed to hold the motor shaft at 0 rpm for up to the rated brake holding torque. The brakes are spring-set type, and release when voltage is applied to the brake coil.

The brakes are *not* designed for stopping rotation of the motor shaft. Servo drive inputs should be used to stop motor shaft rotation. The recommended method of stopping motor shaft rotation is to command the servo drive to decelerate the motor to 0 rpm, and engage the brake after the servo drive has decelerated the motor to 0 rpm.

If system main power fails, the brakes can withstand use as stopping brakes. However, use of the brakes as stopping brakes creates rotational mechanical backlash that is potentially damaging to the system, increases brake pad wear and reduces brake life. The brakes are *not* designed nor are they intended to be used as a safety device.

A separate power source is required to disengage the brake. This power source may be controlled by the servo motor controls, in addition to manual operator controls.

Y-Series Brake Specifications

Specifications	Y-1002	Y-1003	Y-2006	Y-2012	Y-3023
Holding Torque	1.39 lb-in. (0.157 N-m)	2.83 lb-in. (0.32 N-m)	5.64 lb-in. (0.637 N-m)	11.24 lb-in. (1.274 N-m)	21.06 lb-in. (2.38 N-m)
Coil Current at 24 VDC	0.26 Amps		0.31 Amps		0.37 Amps

Y-Series Motor Brake and Shaft Load Data

Motor	Brake Holding Torque	Shaft Radial Load (FR)	Axial Load (F)	Coil Current
Y-1002	0.157 N-m	10 kg	3 kg	0.26A
Y-1003	0.32 N-m	10 kg	3 kg	0.26A
Y-2006	0.637 N-m	20 kg	8 kg	0.31A
Y-2012	1.27 N-m	25 kg	10 kg	0.31A
Y-3023	2.38 N-m	35 kg	20 kg	0.37A

¹ The FR and F refer to loads applied as shown in the drawing above.

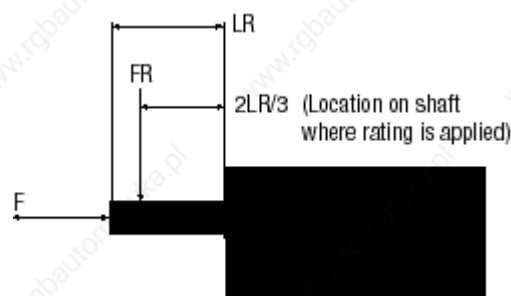

ULTRA 100 Series Specifications for Y-Series Motors¹

Specifications		Y-1002-		Y-1003-		Y-2006-		Y-2012-		Y-3023-2	
		1	2	1	2	1	2	1	2	115V	230V
Drive	1398-DDM-	005	005	009	005	019	009	019	009	019	019
Maximum continuous operating speed	RPM	4500	4500	4500	4500	4500	4500	3800	4500	2500	4500
Continuous stall torque ³	N-m (lb-in.)	0.17 (1.5)	0.17 (1.5)	0.35 (3.1)	0.35 (3.1)	0.69 (6.1)	0.69 (6.1)	1.4 (12)	1.4 (12)	2.5 (22.5)	2.5 (22.5)
Peak torque ⁴	N-m (lb-in.)	0.48 (4.3)	0.48 (4.3)	0.97 (8.6)	0.97 (8.6)	1.92 (17)	1.92 (17)	3.8 (33.7)	3.8 (33.7)	7.1 (63)	7.1 (63)

¹ Ambient temperature is 0°C to 40°C for motors and 0°C to 50°C for drives.

² At drive input voltage.

³ At 125°C winding temperature, in a 40°C ambient, with motor mounted on aluminum heat sinks: motors 1002, 1003—0.125 in. x 6 in. x 6 in.; motors 2006, 2012—0.250 in. x 8 in. x 8 in.; motor 3023—0.25 in. x 10 in. x 10 in.

⁴ System limit.

ULTRA 200 Specifications for Y-Series Motors^{1 2}

Specifications		Y-1002-		Y-1003-		Y-2006-		Y-2012-		Y-3023-	
		1	2	1	2	1	2	1	2	115V	230V
Drive	1398-DDM-	010	010	010	010	010	020	020	020	020	020
Maximum continuous operating speed	RPM	4500	4500	4500	4500	4500	4500	4500	4500	2500	4500
Continuous stall torque ³	N-m (lb-in.)	0.17 (1.5)	0.17 (1.5)	0.35 (3.1)	0.35 (3.1)	0.69 (6.1)	0.69 (6.1)	1.4 (12)	1.4 (12)	2.5 (22.5)	2.5 (22.5)
Peak torque ⁴	N-m (lb-in.)	0.48 (4.3)	0.48 (4.3)	0.97 (8.6)	0.97 (8.6)	1.9 (16.6)	1.9 (16.6)	3.4 (30.0)	3.8 (33.7)	6.0 (53.0)	7.1 (63.0)

¹ Ambient temperature is 0°C to 40°C for motors and 0°C to 50°C for drives.

² At drive input voltage.

³ At 125°C winding temperature, in a 40°C ambient, with motor mounted on aluminum heat sinks: motors 1002, 1003—0.125 in. x 6 in. x 6 in.; motors 2006, 2012—0.250 in. x 8 in. x 8 in.; motor 3023—0.25 in. x 10 in. x 10 in.

⁴ System limit.

Y-Series Standard Motors Dimensions

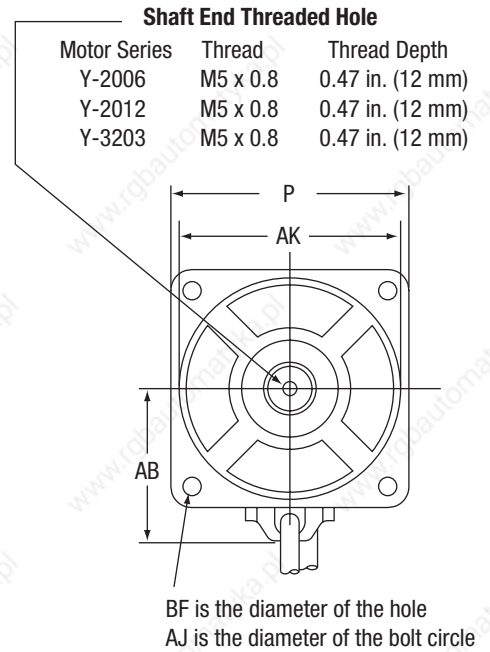
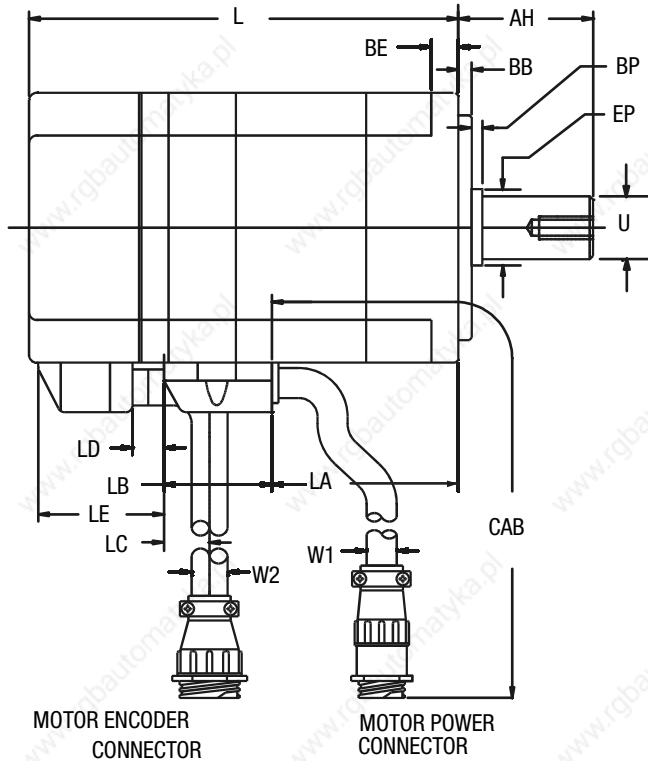

Dimensions	AB	AF	AH	AJ	AK	BB	BE	BF	BP	CAB	EP	L	L with brake	P	U
Motor Models	mm (in.)	mm (in.)	mm (in.)	mm (in.)	mm (in.)	mm (in.)	mm (in.)	mm (in.)	mm (in.)	mm (in.)	mm (in.)	mm (in.)	mm (in.)	mm (in.)	mm (in.)
Y-1002	30 (1.18)	NA	25 (0.98)	46 (1.81)	30 (1.18)	2.5 (0.10)	5 (0.20)	4.5 (0.18)	NA	1000 (39.37)	NA	70 (2.75)	108 (4.25)	40 (1.58)	8 (0.31)
Y-1003	30 (1.18)	NA	25 (0.98)	46 (1.81)	30 (1.18)	2.5 (0.10)	5 (0.20)	4.5 (0.18)	NA	1000 (39.37)	NA	88 (3.46)	126 (4.96)	40 (1.58)	8 (0.31)
Y-2006	41 (1.61)	NA	30 (1.18)	70 (2.75)	50 (1.97)	3 (0.12)	6 (0.24)	5.5 (0.22)	NA	1000 (39.37)	NA	95 (3.74)	133 (4.54)	60 (2.36)	14 (0.55)
Y-2012	41 (1.61)	NA	30 (1.18)	70 (2.75)	50 (1.97)	3 (0.12)	6 (0.24)	5.5 (0.22)	NA	1000 (39.37)	NA	123 (4.84)	161 (6.34)	60 (2.36)	14 (0.55)
Y-3023	52 (2.05)	35 (1.38)	40 (1.57)	90 (3.54)	70 (2.75)	3 (0.12)	8 (0.31)	6.5 (0.25)	2.0 (0.08)	1000 (39.37)	19 (0.75)	140 (5.57)	180 (7.09)	80 (3.15)	16 (0.63)

Motors are manufactured to millimeter dimensions shown. Inch dimensions shown are appropriate conversions from millimeters. For further motor detail, engineering specification drawings are available upon request.

Supplemental Motor Dimensions

Dimension	Y-1002	Y-1003	Y-2006	Y-2012	Y-3023
LA	23.5/0.90	41.5/1.60		69.5/2.7	80.5/3.2
LB	21.5/0.84		24.0/0.95		30.0/1.2
LC ¹	17.5/0.70		-		
LC (Brake) ¹	56/2.2				
LD	-		7.0/0.28		
LD (Brake)			45/1.77		
LE	-		28.0/1.10		
LE (Brake) ¹			66/2.60		

¹ Measurement is to the center of the perpendicular motor encoder cable.
Motor encoder cable exits the perpendicular to the motor frame on Y-1002 and Y-1003 motors (not as shown).

Cable Diameters

Motor	W1 - Power/Brake	W2 - Encoder
Y-1002	6.0/0.24	8.0/0.31
Y-1003		
Y-2006	6.7/0.26	
Y-2012		
Y-3023		

Minimum 90° cable bend allowance is 15mm.

Encoder Data

Encoders are factory aligned and must not be adjusted outside the factory.

Specifications	
Line Counts	<ul style="list-style-type: none"> • Data A+, A-, B+, B-: 2000 pulse/rev • Index I+, I-: 1 pulse/rev • Hall A+, A-, B+, B-, C+, C-: 2 pulse/rev
Supply Voltage	4.75 to 5.25 VDC
Supply Current	450 mA DC
Line Driver	AM26LS31 equivalent
Line Driver Output	<ul style="list-style-type: none"> • Output: Logic 1 - Sourcing 2.5 VDC @ 20 mA • Output: Logic 0 - Sinking 0.5 VDC @ 20 mA

The line count is standard before quadrature.

Encoder Outputs

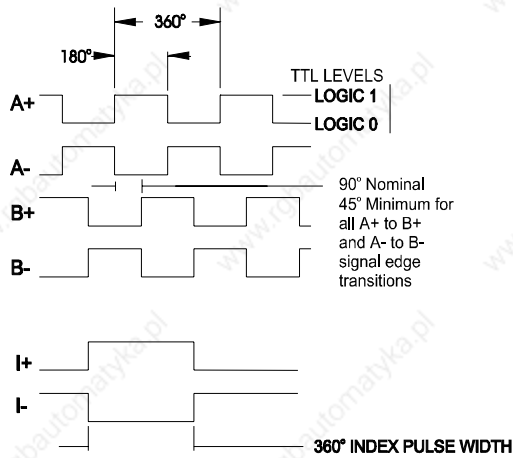

Waveforms result from clockwise rotation. "Clockwise" as viewed facing the shaft extension.

Y-Series Connector Pins and Signals

Motor Power Connector (All Y-Series Motors)

Pin	Signal	Wire Color	Pin	Signal	Wire Color
1	Phase R	Red	6	—	—
2	Phase S	Black	7	Brake+ ¹ (Option)	Yellow
3	Phase T	White	8	—	—
4	—	—	9	Brake- ¹ (Option)	Yellow
5	Ground	Green/ Yellow			

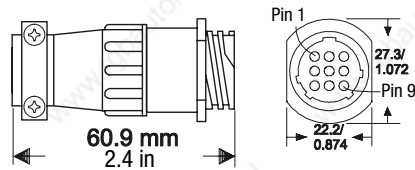

¹ No connection for nonbrake motors.

Motor Feedback Connector (All Y-Series Motors)

Pin	Signal	Wire Color	Pin	Signal	Wire Color
1 - 8	–	–	17	Hall B+	Blue/Black
9	A+	Purple	18	Hall B-	Brown/ Black
10	A-	Green	19	Hall C+	Red/Black
11	B+	Blue	20	Hall C-	Yellow/ Black
12	B-	Brown	21	–	–
13	I+	White	22	+5V DC	Red
14	I-	Yellow	23	COM	Black ¹
15	Hall A+	Green/ Black	24	SHIELD	Black ²
16	Hall A-	Purple/ Black	25 - 28	–	–

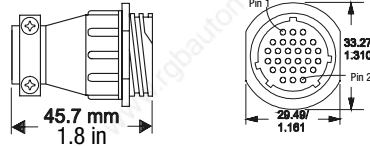

- ¹ COM (+5VDC) is not connected to the motor ground.
- ² SHIELD is connected to the motor case ground.

Wire and Contact Sizing Recommendations

Power/Brake Connector

The following connector contact sizes and wiring gages are recommended for cabling to a motor.

Motor	Contact AWG (mm ²)	Wire AWG (mm ²)
Y-1002	0.75 - 2.5 (18-14)	0.75 (18)
Y-1003		
Y-2006		1.5 (16)
Y-2012		
Y-3023		

- Sizes are recommended minimum values.
- Wiring should be twisted.
- Local regulations should always be observed.

Encoder Connector

Contact AWG (mm ²)	Wire AWG (mm ²)
All Y-Series 0.25 - 0.50 (24-20)	0.34 (22)

- Sizes are recommended minimum values.
- Wiring should be twisted.
- Local regulations should always be observed.

N-Series Motors



N-Series motors use a high-energy ring magnet rotor construction for an outstanding torque-to-size ratio. Available in four common NEMA style frame sizes, N-Series motors, matched with an ULTRA Series drive, create a high performance alternative to stepper systems. It also provides an excellent solution when interfacing to gear boxes, sprockets, and pulleys because of the standard NEMA mounting frames. The nine motors in the N-Series family range in continuous torque capability from 0.18 to 5.9 N-m (1.6 to 52 lb-in.) and reach speeds up to 6000 RPM. Typical applications for the N-Series include web processing, machine tool, textile machinery, and CAM replacements. When you install the optional motor shaft seal, the motor meets the IP65 requirements of the IEC standard.

Features

The N-Series motors have the following features:

- Rugged industrial construction
- NEMA 23, 34, 42, and 56 style mounting frames
- Continuous torque from 0.18 to 5.9 N-m (1.6 to 52 lb-in.)
- Speeds up to 6000 RPM
- High torque-to-size ratio
- High energy ring magnet rotor
- Internal thermal switch indicating overheating
- Optional internally mounted spring set, magnetic release 24V DC holding brake
- Motor mounted optical encoder includes 2000 quadrature pulses (1000 pulses for N-23xx motors), index pulse, and standard commutation channels for drives
- Water-tight, nickel-plated MS connections are compatible with standard cable assemblies.
- The extruded aluminum housing and environmental connectors provide an IP65 package (with the optional shaft seal kit)

Typical Applications

Typical applications for the N-Series motors are:

- Machine tools
- Material handling
- Web processing
- Robotics
- Packaging machinery

Characteristics

- High performance stepper replacement
- NEMA mounting provides excellent mechanical interface
- Environmentally rugged

Selecting a Drive/Motor Combination

The following drive/motor combinations are available for the N-Series motors:

Motor	ULTRA 100	ULTRA 200	ULTRA Plus
N-2302-1-F00AA	1398-DDM-005	1398-DDM-010	NA
N-2304-1-F00AA	1398-DDM-005	1398-DDM-010	NA
N-3406-2-H00AA	1398-DDM-009	1398-DDM-020	1398-PDM-20
N-3412-2-H00AA	1398-DDM-009	1398-DDM-020	1398-PDM-20
N-4214-2-H00AA	1398-DDM-009	1398-DDM-020	1398-PDM-20
N-4220-2-H00AA	1398-DDM-019	1398-DDM-030	1398-PDM-30
N-5630-2-H00AA	1398-DDM-019	1398-DDM-030	1398-PDM-30
N-5637-2-H00AA	1398-DDM-019	1398-DDM-030	1398-PDM-30
N-5647-2-H00AA	1398-DDM-019	1398-DDM-030	1398-PDM-30

N-Series Specifications

This section contains the mechanical, thermostat and winding specifications for the N-Series motor family, as well as the load force ratings and performance specifications for every combination of ULTRA series drives and N-Series motors. It also provides motor dimensions, connector pin and signal designations, and all motor and connector ordering information.

N-Series Mechanical Specifications

Specifications	Units	N-2302	N-2304	N-3406	N-3412	N-4214
Rotor moment of inertia	kg-m ² (lb-in.-s ²)	0.000009 (0.00008)	0.00002 (0.00016)	0.00008 (0.0007)	0.00015 (0.0013)	0.00024 (0.0021)
Rotor moment of inertia (brake motors)	kg-m ² (lb-in.-s ²)	0.000018 (0.00016)	0.000032 (0.00028)	0.000122 (0.00108)	0.000202 (0.00179)	0.000210 (0.00186)
Motor net weight	kg (lb)	1.0 (2.3)	1.5 (3.4)	2.6 (5.7)	3.5 (7.6)	4.7 (10.4)
Brake motor net weight	kg (lb)	1.3 (2.9)	2.0 (4.3)	3.4 (7.5)	4.3 (9.5)	5.1 (11.2)
Damping	N-m/kRPM (lb-in./kRPM)	0.0015 (0.013)	0.0021 (0.019)	0.0078 (0.069)	0.012 (0.106)	0.013 (0.113)
Friction torque	N-m (lb-in.)	0.012 (0.11)	0.014 (0.13)	0.021 (0.19)	0.035 (0.31)	0.043 (0.38)
Maximum Operating Speed	rpm	6000	6000	6000	6000	6000

Specifications	Units	N-4220	N-5630	N-5637	N-5647
Rotor moment of inertia	kg-m ² (lb-in.-s ²)	0.00035 (0.0031)	0.0009 (0.008)	0.0011 (0.01)	0.0015 (0.013)
Rotor moment of inertia (brake motors)	kg-m ² (lb-in.-s ²)	0.000320 (0.00283)	0.000651 (0.00576)	0.000778 (0.00689)	0.000893 (0.00791)
Motor net weight	kg (lb)	5.9 (13.0)	9.1 (20.0)	11.0 (24.2)	13.0 (28.7)
Brake motor net weight	kg (lb)	6.9 (15.2)	10.9 (24.0)	13.2 (29.0)	15.9 (35.0)
Damping	N-m/kRPM (lb-in./kRPM)	0.012 (0.106)	0.022 (0.194)	0.02 (0.175)	0.028 (0.25)
Friction torque	N-m (lb-in.)	0.048 (0.406)	0.078 (0.688)	0.1 (0.875)	0.11 (0.938)
Maximum Operating Speed	rpm	5000	4000	4000	3000

N-Series Thermostat Specifications

Specifications	
Rated voltage	0 - 250V DC or 50/60 Hz AC ¹
Rated current	3.0A at power factor of 1.0 2.0A at power factor of 0.6
Maximum switching current	5 A
Contact resistance	Less than 0.040 Ohms maximum
Contacts	Normally closed
Insulation dielectric	Mylar Nomex capable of withstanding 1500V AC RMS 50/60 Hz for 1 minute
Opening temperature ($\pm 5^{\circ}\text{C}$)	135 $^{\circ}\text{C}$

¹ The thermostat is normally used as a switch for a 15V DC logic signal (recommended).

N-Series Winding Specifications

Specifications	Units	N-2302	N-2304	N-3406	N-3412	N-4214
Sine wave K_T torque Constant at 25 $^{\circ}\text{C}$ ¹	N-m/A (lb-in./A)	0.08 (0.73)	0.18 (1.6)	0.17 (1.5)	0.34 (3.0)	0.41 (3.6)
Square wave K_T torque Constant at 25 $^{\circ}\text{C}$ ²	N-m/A (lb-in./A)	0.09 (0.80)	0.20 (1.8)	0.18 (1.6)	0.37 (3.3)	0.45 (4.0)
K_E voltage constant ³	V/kRPM	10	22	21	41	49
Winding resistance Phase to phase at 25 $^{\circ}\text{C}$	Ohm	3.2	4.9	2.2	2.7	2.8
Winding inductance Phase to phase	mH	4.1	8.1	6.1	8.6	11.0
Thermal resistance ⁴	$^{\circ}\text{C}/\text{Watt}$	3.0	2.2	1.6	1.2	1.1
Poles		4	4	4	4	4

Specifications	Units	N-4220	N-5630	N-5637	N-5647
Sine wave K_T torque Constant at 25°C ¹	N-m/A (lb-in./A)	0.28 (2.5)	0.38 (3.4)	0.50 (4.4)	0.63 (5.6)
Square wave K_T torque Constant at 25°C ²	N-m/A (lb-in./A)	0.31 (2.7)	0.42 (3.7)	0.54 (4.8)	0.70 (6.2)
K_E voltage constant ³	V/kRPM	34	47	60	77
Winding resistance Phase to phase at 25°C	Ohm	0.77	0.89	1.0	1.23
Winding inductance Phase to phase	mH	2.9	4.3	5.2	7.0
Thermal resistance ⁴	N-m/A (lb-in./A)	0.83	0.81	0.76	0.70
Poles		4	4	4	4

¹ Peak value of per phase sine wave amps.

² Peak value of per phase square wave amps

³ Peak value of sinusoidal phase to phase volts

⁴ At 125°C winding temperature, in a 40°C ambient, with motor mounted on aluminum heat sinks:
motors 2302, 2304—0.25 in. x 8 in. x 8 in.; motors 3406, 3412—0.25 in. x 10 in. x 10 in.;
motors 4214, 4220, 5630, 5637, 5647—0.5 in. x 12 in. x 12 in.

Storage and Operating Specifications

Storage and Operating Conditions

Ambient Temperature	Operating: 0 to 40°C (32 to 104°F) Storage: 0 to 50°C (32 to 122°F)
Relative Humidity	5% to 95% non-condensing

N-Series Standard Motor Radial Load Force Ratings

Ratings	Units	N-2302	N-2304	N-3406	N-3412	N-4214
500 RPM	kg (lbs)	8 (17)	9 (19)	47 (103)	51 (113)	62 (137)
1000 RPM	kg (lbs)	7 (16)	8 (17)	37 (82)	40 (89)	49 (109)
2000 RPM	kg (lbs)	6 (14)	7 (15)	29 (65)	32 (71)	39 (86)
3000 RPM	kg (lbs)	6 (14)	6 (14)	26 (56)	28 (62)	34 (76)
4000 RPM	kg (lbs)	5 (11)	5 (11)	23 (51)	26 (56)	31 (68)
5000 RPM	kg (lbs)	4 (9)	5 (11)	22 (48)	24 (53)	29 (64)
6000 RPM	kg (lbs)	3 (8)	3 (8)	20 (45)	22 (49)	NA

Ratings	Units	N-4220	N-5630	N-5637	N-5647
500 RPM	kg (lbs)	66 (146)	85 (188)	89 (197)	92 (203)
1000 RPM	kg (lbs)	52 (116)	67 (149)	71 (156)	73 (161)
2000 RPM	kg (lbs)	41 (92)	53 (118)	56 (124)	58 (128)
3000 RPM	kg (lbs)	36 (80)	47 (103)	49 (108)	51 (112)
4000 RPM	kg (lbs)	33 (73)	43 (94)	45 (98)	NA
5000 RPM	kg (lbs)	31 (68)	NA	NA	NA

Motors are capable of carrying an axial load in most applications according to the following general guidelines. These guidelines should only be used as approximations.

- When the motor shaft has no radial load, the axial load rating is 100% of the radial load rating from the table above.
- When the motor shaft has both a radial and an axial load, the axial load rating is 44% of the radial load rating from the table above.

N-Series Motors Shaft Load Specifications

Motor	Shaft Radial Load (FR)
N-2300	2.26 kg (5 lb)
N-3406	13.6 kg (30 lb)
N-3412	15.9 kg (35 lb)
N-4214	20.4 kg (45 lb)

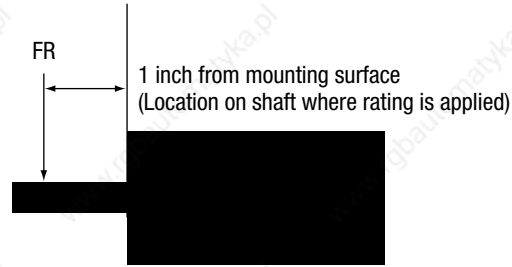

ULTRA 100 Series Specifications for N-Series Motors¹

Specifications		N-2302	N-2304	N-3406	N-3412	N-4214
Drive	1398-DDM-	005	005/009	009	009	009
Maximum continuous operating speed ²	RPM	6000	6000	6000	5500	4500
Continuous stall torque ²	N-m (lb-in.)	0.2 (1.6)	0.4/0.5 (3.5/4.4)	0.8 (6.8)	1.6 (13.8)	2.0 (15.5)
Peak torque ³	N-m (lb-in.)	0.5 (4.6)	1.1/1.4 (10.0/13.0)	2.1 (18.5)	4.1 (36.0)	5.7 (45.0)

Specifications		N-4220	N-5630	N-5637	N-5647
Drive	1398-DDM-	019	019	019	019
Maximum continuous operating speed ²	RPM	5000	4000	4000	3000
Continuous stall torque ²	N-m (lb-in.)	2.5 (22.0)	3.4 (30.0)	4.5 (40.0)	5.9 (52.0)
Peak torque ³	N-m (lb-in.)	7.1 (63.0)	10.7 (95.0)	13.0 (120)	17.0 (150)

¹ Ambient temperature is 0°C to 40°C for motors and 0°C to 50°C for drives.

² With 230V AC line voltage input, except for N-2302 and N-2304, which are used with 115V AC line voltage input.

³ System limit.

ULTRA 200 Series Specifications for N-Series Motors¹

Specifications		N-2302	N-2304	N-3406	N-3412	N-4214
Drive	1398-DDM-	010	010	020	020	020
Maximum continuous operating speed ²	RPM	6000	6000	6000	5500	4500
Continuous stall torque ²	N-m (lb-in.)	0.2 (1.7)	0.5 (4.4)	0.8 (6.8)	1.6 (13.8)	2 (18)
Peak torque ³	N-m (lb-in.)	0.5 (4.7)	1.4 (13.0)	2.1 (18.5)	4.1 (36)	5.7 (50)

Specifications		N-4220	N-5630	N-5637	N-5647
Drive	1398-DDM-	030	030	030	030
Maximum continuous operating speed ²	RPM	5000	4000	4000	3000
Continuous stall torque ²	N-m (lb-in.)	2.9 (26.0)	3.8 (34.0)	5.2 (46.0)	6.0 (53.0)
Peak torque ³	N-m (lb-in.)	7.1 (63.0)	10.7 (95.0)	13.0 (120)	17.0 (150)

¹ Ambient temperature is 0°C to 40°C for motors and 0°C to 50°C for drives.

² With 230V AC line voltage input, except for N-2302 and N-2304, which are used with 115V AC line voltage input.

³ System limit.

ULTRA Plus Specifications for N-Series Motors¹

Specifications		N-2302	N-2304	N-3406	N-3412	N-4214
Drive	1398-PDM-	NA	NA	20	20	20
Maximum continuous operating speed ²	RPM	NA	NA	6000	6000	5000
Continuous stall torque ²	N-m (lb-in.)	NA	NA	0.8 (6.8)	1.6 (13.8)	2 (18)
Peak torque ³	N-m (lb-in.)	NA	NA	2.1 (18.5)	4.1 (36)	5.7 (50)

Specifications		N-4220	N-5630	N-5637	N-5647
Drive	1398-PDM-	30	30	30	30
Maximum continuous operating speed ²	RPM	5000	4000	4000	3000
Continuous stall torque ²	N-m (lb-in.)	2.9 (26.0)	3.8 (34.0)	5.2 (46.0)	6.0 (53.0)
Peak torque ³	N-m (lb-in.)	7.1 (63.0)	10.7 (95.0)	13.0 (120)	17.0 (150)

¹ Ambient temperature is 0°C to 40°C for motors and 0°C to 50°C for drives.

² With 230V AC line voltage input.

³ System limit.

N-Series Brake Specifications

Specifications	N-2300	N-3400	N-4200	N-5600
Maximum Backlash (brake engaged)	31 minutes	72 minutes	36 minutes	102 minutes
Holding Torque	5 lb-in. (0.56 N-m)	15 lb-in. (1.69 N-m)	30 lb-in. (3.39 N-m)	50 lb-in. (5.64 N-m)
Coil Current at 24 VDC	0.28 ADC	0.36 ADC	0.36 ADC	0.71 ADC

Brake Motor Application Guidelines

The brakes offered as options on these servo motors are holding brakes. They are designed to hold the motor shaft at 0 rpm for up to the rated brake holding torque. The brakes are spring-set type, and release when voltage is applied to the brake coil.

The brakes are *not* designed for stopping rotation of the motor shaft. Servo drive inputs should be used to stop motor shaft rotation. The recommended method of stopping motor shaft rotation is to command the servo drive to decelerate the motor to 0 rpm, and engage the brake after the servo drive has decelerated the motor to 0 rpm.

If system main power fails, the brakes can withstand use as stopping brakes. However, use of the brakes as stopping brakes creates rotational mechanical backlash that is potentially damaging to the system, increases brake pad wear and reduces brake life. The brakes are *not* designed nor are they intended to be used as a safety device.

A separate power source is required to disengage the brake. This power source may be controlled by the servo motor controls, in addition to manual operator controls.

N-2300 Motors Dimensions (see page 62 for dimension values)

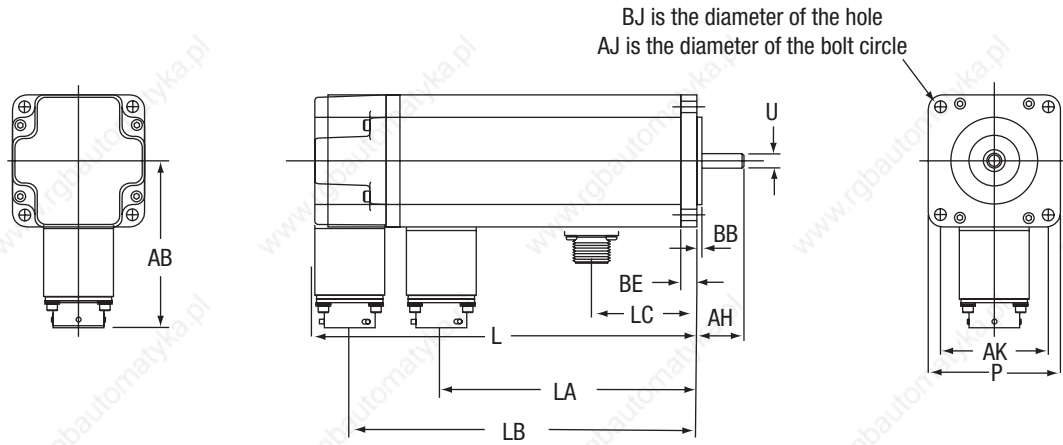

N-3400, -4200, and -5600 Motors Dimensions (see page 62 for dimension values)

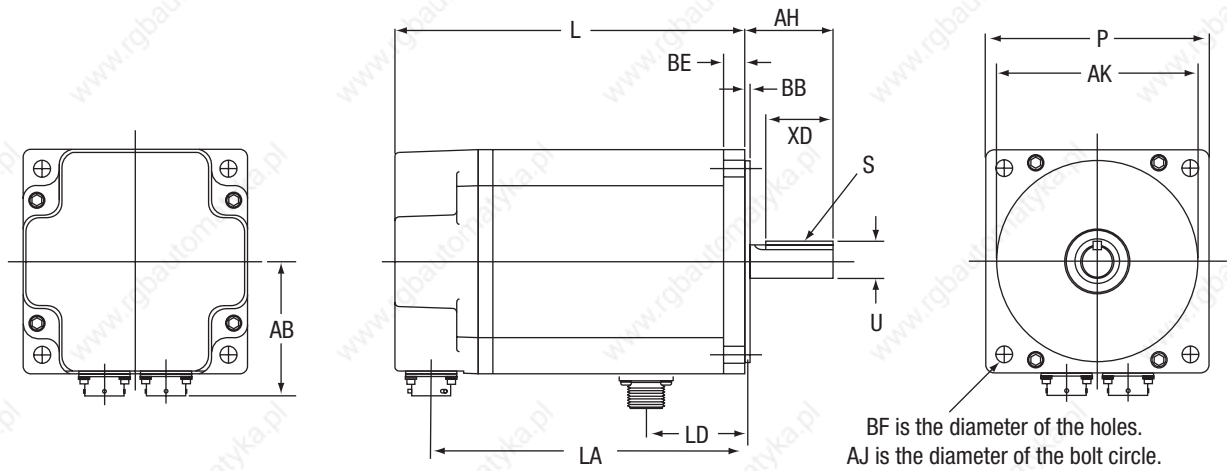

Dimensions	AB	AH ¹	AJ	AK	BB	BE	BF	L	L with brake	LA	LB	P	S (width x depth) ⁵	U ³	XD ⁶
Motor Models	mm (in.)	mm (in.)	mm (in.)	mm (in.)	mm (in.)	mm (in.)	mm (in.)	mm (in.)	mm (in.)	mm (in.)	mm (in.)	mm (in.)	mm x mm (in. x in.)	mm (in.)	mm (in.)
N-2302	69 (2.71)	21 (0.81)	67 (2.625)	38 ² (1.50)	2 (0.09)	7 (0.275)	5 (0.205)	118 (4.64)	161 (6.35)	62 (2.43)	106 (4.05)	58 (2.27)	NA	6 (0.25)	NA
N-2304	69 (2.71)	21 (0.81)	67 (2.625)	38 ² (1.50)	2 (0.09)	7 (0.275)	5 (0.205)	156 (6.14)	199 (7.85)	100 (3.93)	141 (5.55)	58 (2.27)	NA	6 (0.25)	NA
N-3406	64 (2.53)	30 (1.19)	98 (3.875)	73 ⁴ (2.878)	3 (0.12)	8 (0.315)	6 (0.220)	147 (5.8)	193 (7.59)	124 (4.87)	NA	88 (3.48)	3 x 2 (0.127 x 0.085)	13 (0.50)	20 (0.79)
N-3412	64 (2.53)	30 (1.19)	98 (3.875)	73 ⁴ (2.878)	3 (0.12)	8 (0.315)	6 (0.220)	173 (6.8)	218 (8.59)	149 (5.87)	NA	88 (3.48)	3 x 2 (0.127 x 0.085)	13 (0.50)	20 (0.79)
N-4214	63 (2.48)	35 (1.38)	126 (4.95)	56 ⁷ (2.187)	3 (0.12)	10 (0.394)	7 (0.280)	174 (6.8)	221 (8.69)	152 (5.99)	NA	102 (4.00)	5 x 3 (0.189 x 0.108)	16 (0.625)	25 (1.00)
N-4220	63 (2.48)	35 (1.38)	126 (4.95)	56 ⁷ (2.187)	3 (0.12)	10 (0.394)	7 (0.280)	200 (7.87)	246 (9.69)	178 (6.99)	NA	102 (4.00)	5 x 3 (0.189 x 0.108)	16 (0.625)	25 (1.00)
N-5630	76 (2.99)	50 (1.97)	149 (5.875)	114 ⁸ (4.50)	3 (0.12)	12 (0.472)	9.5 (0.375) in UNC	199 (7.845)	256 (10.06)	178 (7.0)	NA	127 (5.00)	5 x 3 (0.189 x 0.121)	19 (0.75)	40 (1.57)
N-5637	76 (2.99)	50 (1.97)	149 (5.875)	114 ⁸ (4.50)	3 (0.12)	12 (0.472)	9.5 (0.375) in UNC	225 (8.845)	281 (11.06)	203 (8.0)	NA	127 (5.00)	5 x 3 (0.189 x 0.121)	19 (0.75)	40 (1.57)
N-5647	76 (2.99)	50 (1.97)	149 (5.875)	114 ⁸ (4.50)	3 (0.12)	12 (0.472)	9.5 (0.375) in UNC	250 (9.845)	306 (12.06)	229 (9.0)	NA	127 (5.00)	5 x 3 (0.189 x 0.121)	19 (0.75)	40 (1.57)

¹ Tolerance is ±0.03 in. (±0.76 mm).

² Tolerance is -0.002 in. (-0.05 mm).

³ Tolerance is -0.005 in. (-0.13 mm) diameter.

⁴ Tolerance is -0.006 in. (-0.15 mm).

⁵ Tolerance is -0.002 in. (-0.05 mm) width, -0.015 in. (-0.38 mm) depth.

⁶ Tolerance is +0.06 in. (+1.5 mm).

⁷ Tolerance is -0.001 in. (-0.025 mm) diameter.

⁸ Tolerance is -0.003 in. (-0.076 mm) diameter.

Note: NEMA motors are manufactured to inch dimensions. Millimeter dimensions are approximate conversions from inches. Engineering specifications showing motor detail are available upon request.

Supplemental Motor Dimensions

Dimensions	LC	LD
Motor Models	mm(in.)	mm(in.)
N-2302	3.861(0.152)	
N-2304	5.636(0.222)	
N-3406	NA	4.490(0.177)
N-3412	NA	5.490(0.216)
N-4214	NA	5.694(0.224)
N-4220	NA	6.694(0.263)
N-5630	NA	6.887(0.271)
N-5637	NA	7.887(0.31)
N-5647	NA	8.887(0.35)

Encoder Data

Encoders are factory aligned and must not be adjusted outside the factory.

Specifications	N-2300	N-3400, N-4200 and N-5600
Line Count	1000 ^{1, 2}	2000 ¹
Supply Voltage	5 VDC	5 VDC
Supply Current	175 mA maximum	300 mA maximum
Line Driver	LM339	26LS31
Line Driver Output	TTL	<ul style="list-style-type: none"> A, B, and I signals: Logic 1 = 2.5 VDC min @ 20 mA DC source, Logic 0 = 0.5 VDC max @ 20 mA DC sink HALL signals: Logic 1 = 3.5 VDC min @ 1mA DC source, Logic 0 = 0.5 VDC max @ 5mA DC sink
Index Pulse	Refer to diagrams below. There is no key for physical reference.	When facing the motor, the key is oriented 90°±10 clockwise (mechanical) from the connectors.

¹ Standard line count before quadrature.

² N-2300 encoder lacks Absolute Signal (ABS).

Encoder Outputs

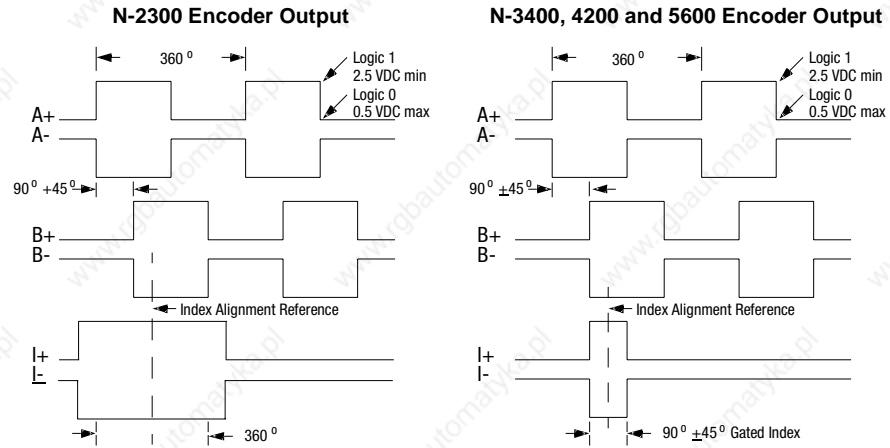

N-Series Connector Pins and Signals

Encoder Connectors (All N-Series Motors)

NEMA 23-Series Encoder

Pin	Signal	Pin	Signal
A	A+	L	Common
B	A-	M	Common
C	B+	N	Open
D	B-	P	Open
E	I+	R	Thermostat+
F	I-	S	Thermostat-
G	Ground	T	Hall A
H	Open	U	Hall B
J	5 VDC	V	Hall C
K	5 VDC		

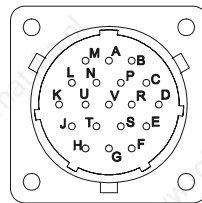

**NEMA 34, 42, & 56-Series
Encoder**

Pin	Signal	Pin	Signal
A	A+	L	Common
B	A-	M	Common
C	B+	N	Open
D	B-	P	Open
E	I+	R	Thermostat+
F	I-	S	Thermostat-
G	Ground	T	Hall A
H	ABS	U	Hall B
J	5 VDC	V	Hall C
K	5 VDC		

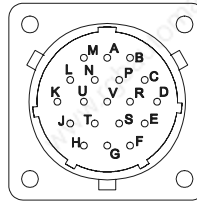

Power and Brake Connectors (All N-Series Motors)

NEMA 23-Series Power Connector		NEMA 34, 42 & 56-Series Power Connector		Brake Option Connector	
Pin	Signal	Pin	Signal	Pin	Signal
A	Phase R	A	Phase R	A	BR+
B	Phase S	B	Phase S	B	BR-
C	Phase T	C	Phase T	C	Open
D	Ground	D	Ground		
E	Open	E	Open		

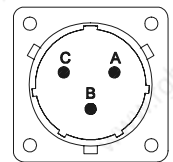
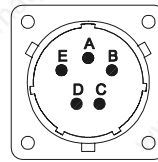
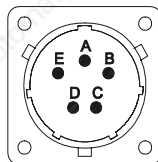

ULTRA 100™/200™ System **ULTRA Servo Drives with F-Series Motors** Ordering Guide

The following section illustrates the drive-motor combinations, motor power cables and encoders available for purchase, as well as the speed/torque reference table for each combination.

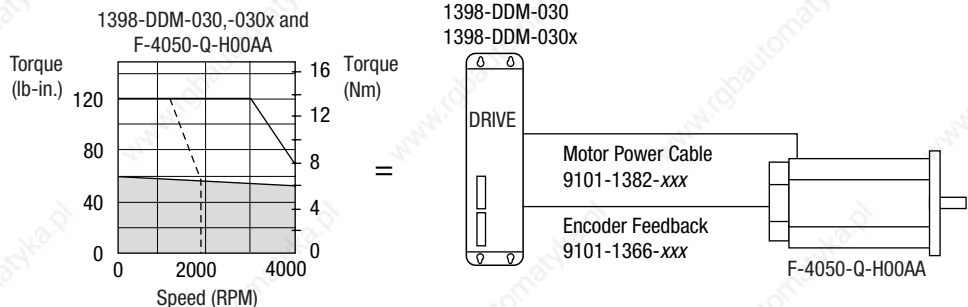
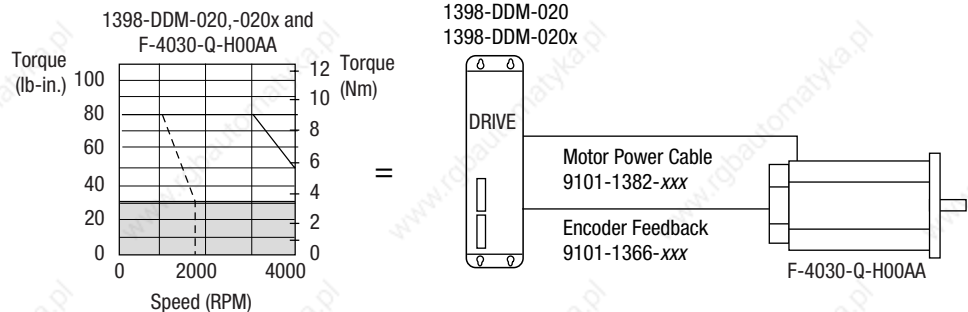
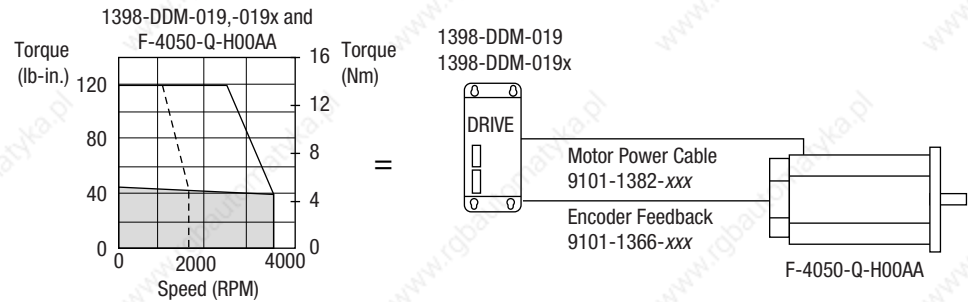
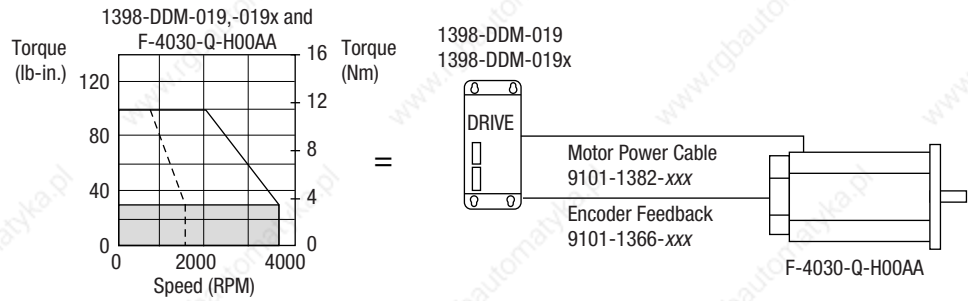

System speed-torque characteristics

Drive module input voltage = 230V AC RMS

- = Intermittent operating region
- = Continuous operating region
- = Drive operation with 115V AC RMS input voltage

* Last three digits select standard cable lengths of:
10 ft (3.0 m)-010; 25 ft (7.7 m)-025; 50 ft (15.0 m)-050; 75 ft (23.0 m)-075; 100 ft (31 m)-100

Note: Serial interface cables for use with the ULTRA 100 drives cannot exceed 50 ft.

ULTRA Servo Drives with F-Series Motors

1398-DDM-030,-030x and F-4075-R-H00AA

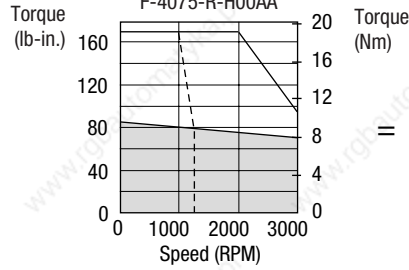

1398-DDM-030
1398-DDM-030x

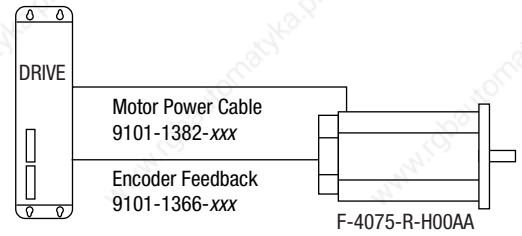

1398-DDM-075,-075x and F-4075-R-H00AA (3ø Input)

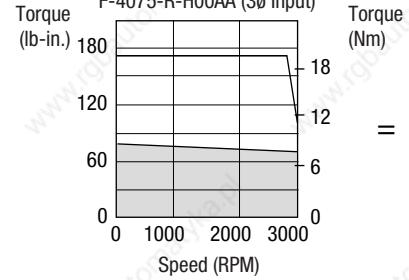

1398-DDM-075
1398-DDM-075x

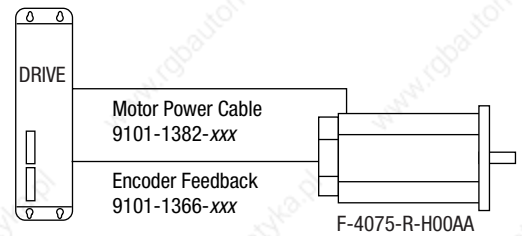

1398-DDM-075,-075x and F-6100-R-H00AA (3ø Input)

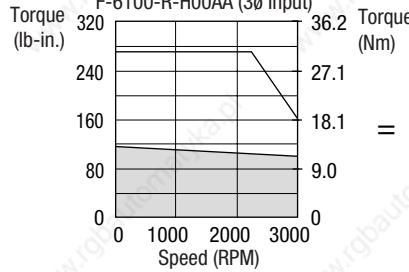

1398-DDM-075
1398-DDM-075x

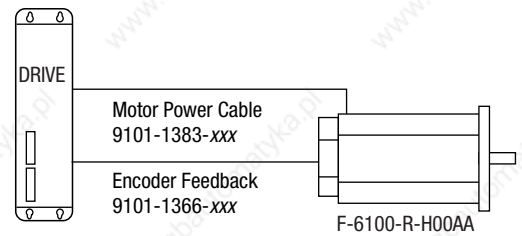

1398-DDM-075,-075x and F-6200-R-H00AA (3ø Input)

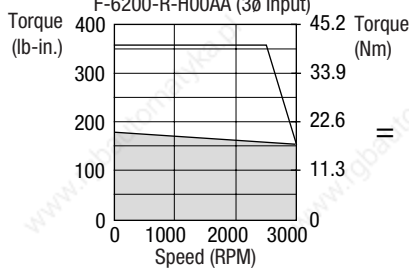

1398-DDM-075
1398-DDM-075x

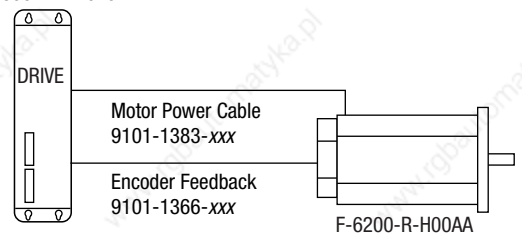



System speed-torque characteristics

Drive module input voltage = 230V AC RMS

* Last three digits select standard cable lengths of:

10 ft (3.0 m)-010; 25 ft (7.7 m)-025; 50 ft (15.0 m)-050; 75 ft (23.0 m)-075; 100 ft (31 m)-100

Note: Serial interface cables for use with the ULTRA 100 drives cannot exceed 50 ft.

-  = Intermittent operating region
-  = Continuous operating region
-  = Drive operation with 115V AC RMS input voltage

ULTRA Servo Drives with F-Series Motors

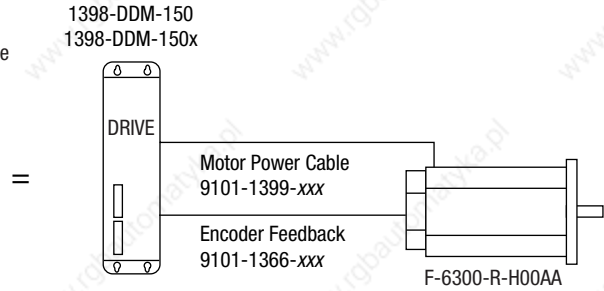
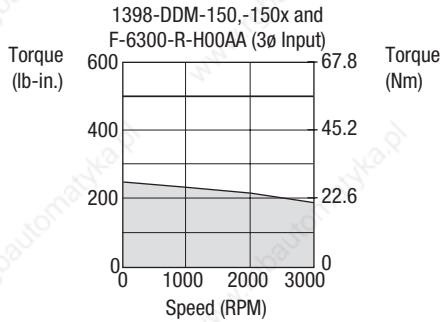
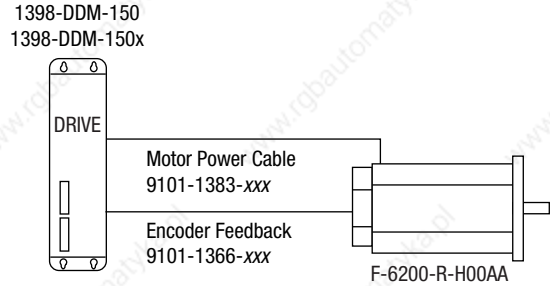
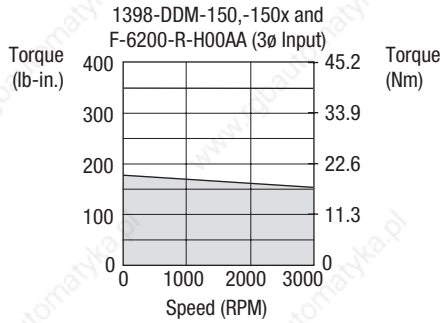
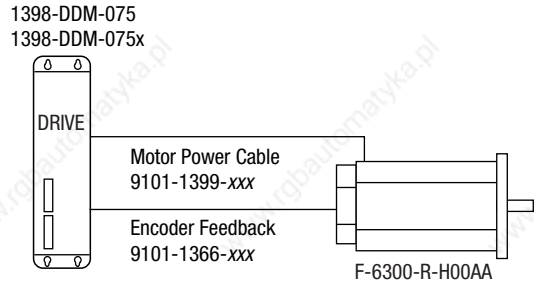
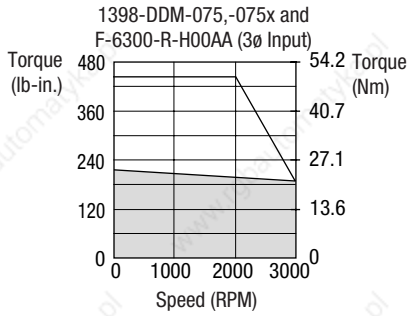



System speed-torque characteristics

Drive module input voltage = 230V AC RMS

* Last three digits select standard cable lengths of:

10 ft (3.0 m)-010; 25 ft (7.7 m)-025; 50 ft (15.0 m)-050; 75 ft (23.0 m)-075; 100 ft (31 m)-100

Note: Serial interface cables for use with the ULTRA 100 drives cannot exceed 50 ft.

-  = Intermittent operating region
-  = Continuous operating region
-  = Drive operation with 115V AC RMS input voltage

ULTRA Servo Drives with H-Series Motors

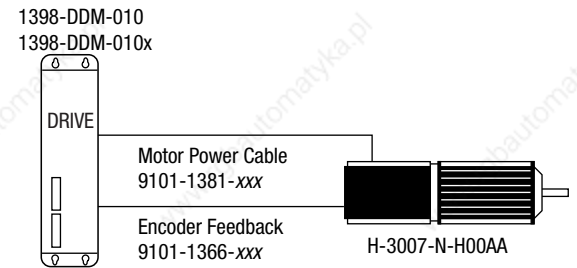
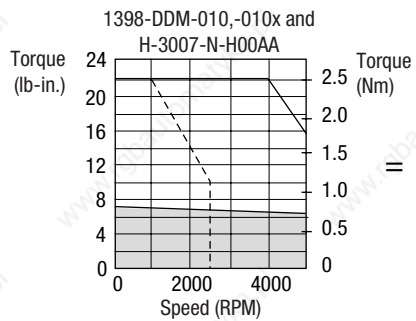
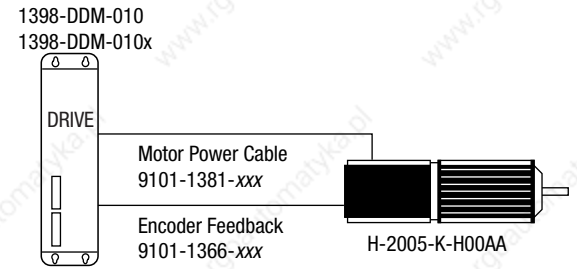
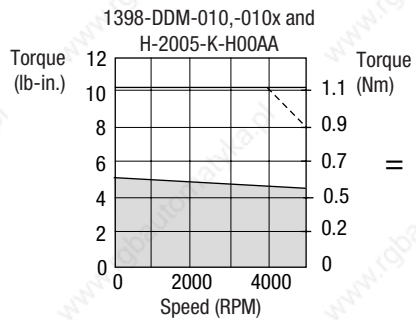
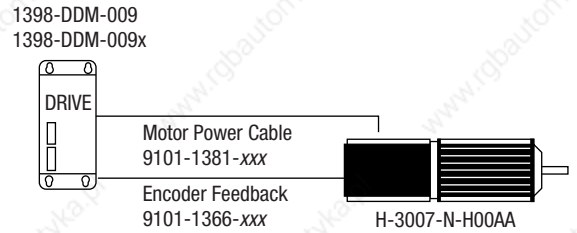
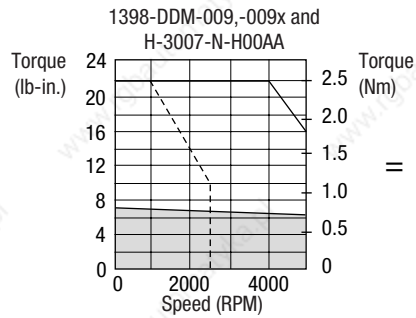
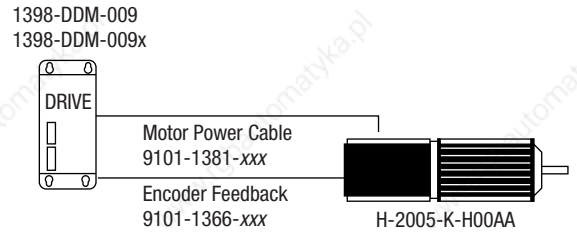
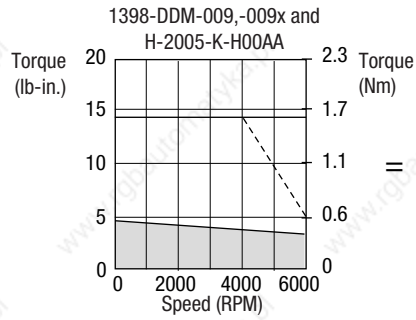



System speed-torque characteristics

Drive module input voltage = 230V AC RMS

* Last three digits select standard cable lengths of:

10 ft (3.0 m)-010; 25 ft (7.7 m)-025; 50 ft (15.0 m)-050; 75 ft (23.0 m)-075; 100 ft (31 m)-100

Note: Serial interface cables for use with the ULTRA 100 drives cannot exceed 50 ft.

-  = Intermittent operating region
-  = Continuous operating region
-  = Drive operation with 115V AC RMS input voltage

ULTRA Servo Drives with H-Series Motors

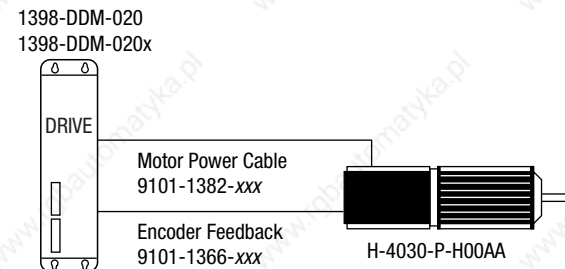
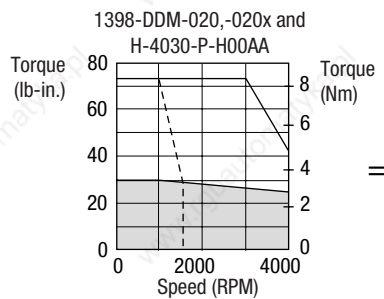
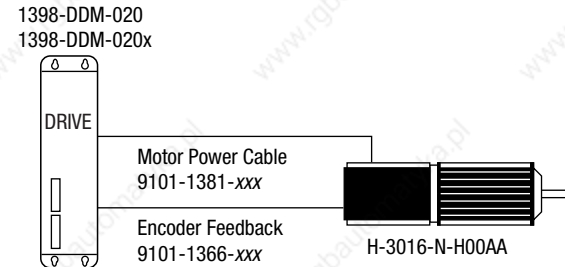
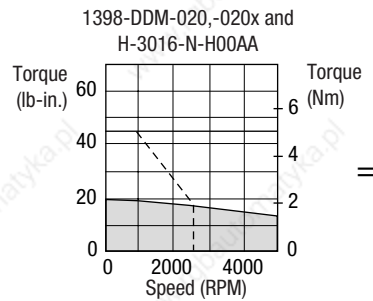
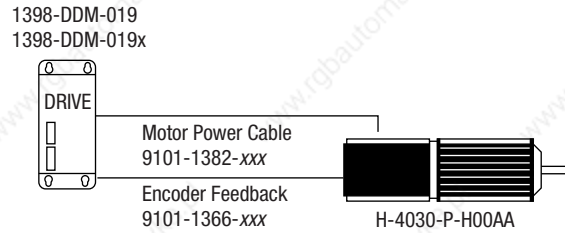
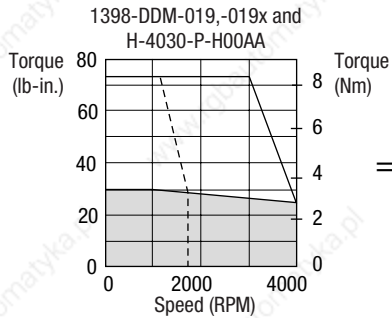
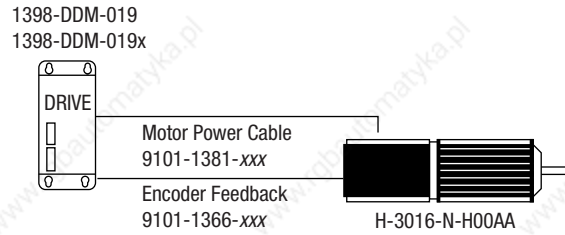
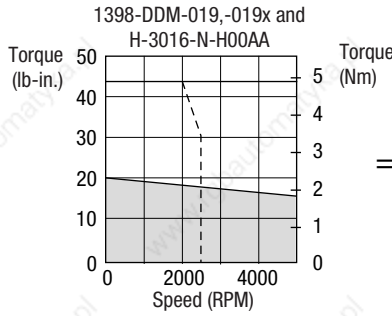

System speed-torque characteristics

Drive module input voltage = 230V AC RMS

* Last three digits select standard cable lengths of:

10 ft (3.0 m)-010; 25 ft (7.7 m)-025; 50 ft (15.0 m)-050; 75 ft (23.0 m)-075; 100 ft (31 m)-100

Note: Serial interface cables for use with the ULTRA 100 drives cannot exceed 50 ft.

- = Intermittent operating region
- = Continuous operating region
- = Drive operation with 115V AC RMS input voltage

ULTRA Servo Drives with H-Series Motors

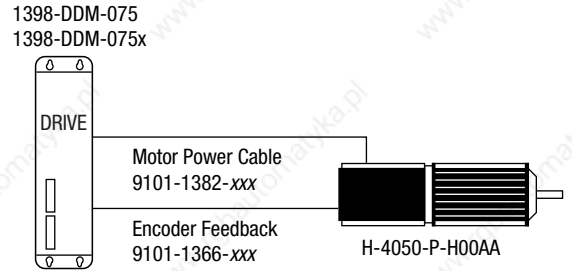
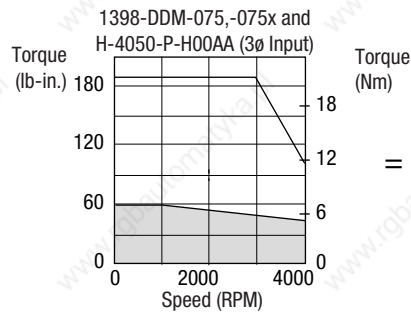
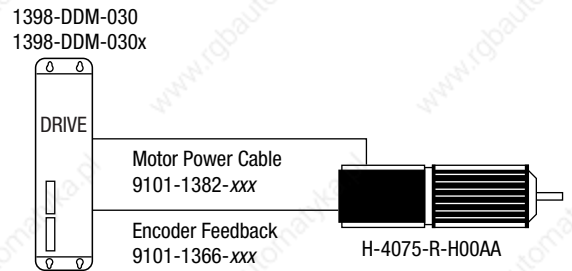
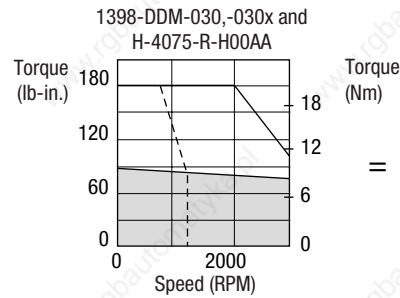
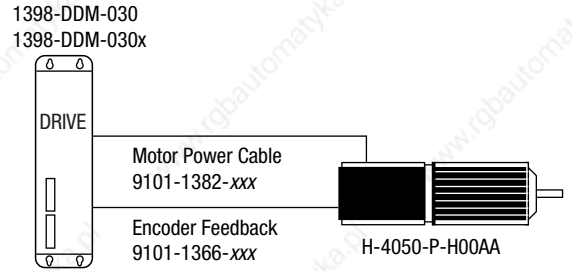
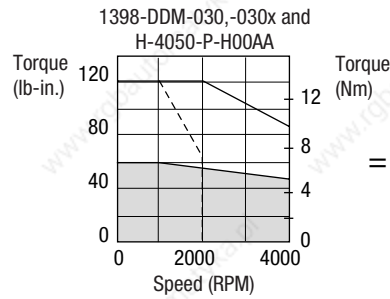
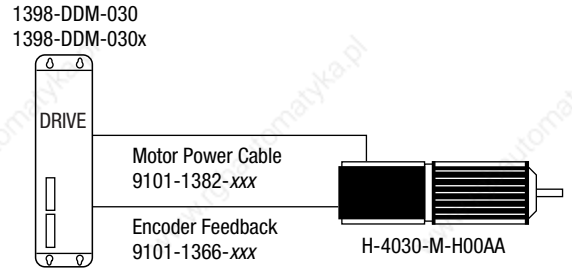
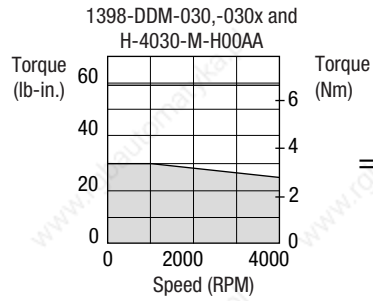

System speed-torque characteristics

Drive module input voltage = 230V AC RMS

* Last three digits select standard cable lengths of:

10 ft (3.0 m)-010; 25 ft (7.7 m)-025; 50 ft (15.0 m)-050; 75 ft (23.0 m)-075; 100 ft (31 m)-100

Note: Serial interface cables for use with the ULTRA 100 drives cannot exceed 50 ft.

- = Intermittent operating region
- = Continuous operating region
- = Drive operation with 115V AC RMS input voltage

ULTRA Servo Drives with H-Series Motors

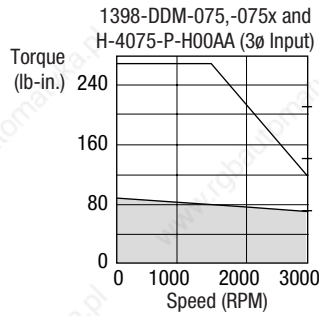

1398-DDM-075
1398-DDM-075x

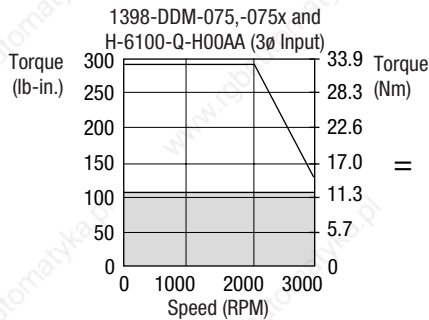
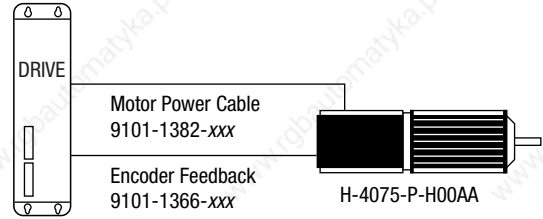

1398-DDM-075
1398-DDM-075x

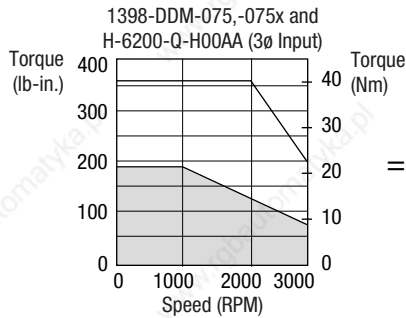
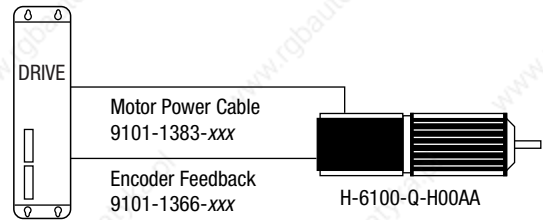

1398-DDM-075
1398-DDM-075x

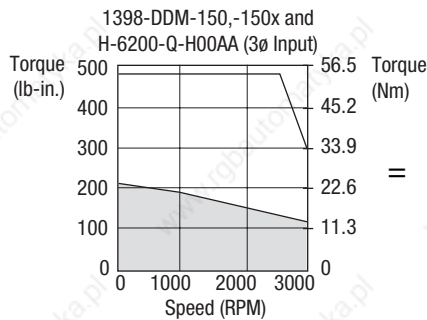
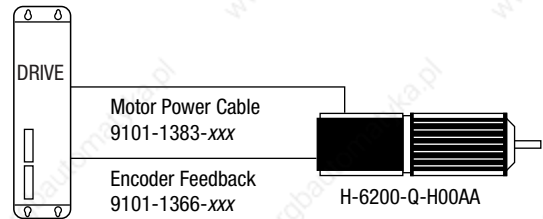

1398-DDM-150
1398-DDM-150x

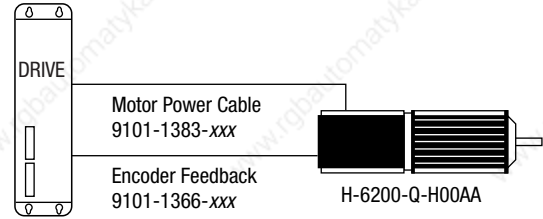

System speed-torque characteristics

Drive module input voltage = 230V AC RMS

- = Intermittent operating region
- = Continuous operating region

* Last three digits select standard cable lengths of:

10 ft (3.0 m)-010; 25 ft (7.7 m)-025; 50 ft (15.0 m)-050; 75 ft (23.0 m)-075; 100 ft (31 m)-100

Note: Serial interface cables for use with the ULTRA 100 drives cannot exceed 50 ft.

ULTRA Servo Drives with H-Series Motors

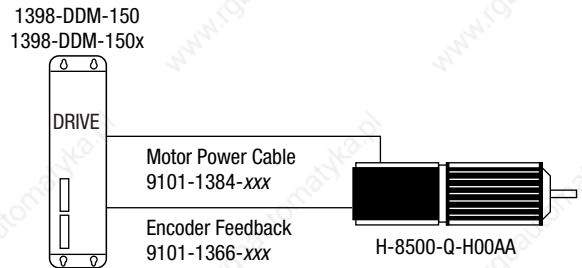
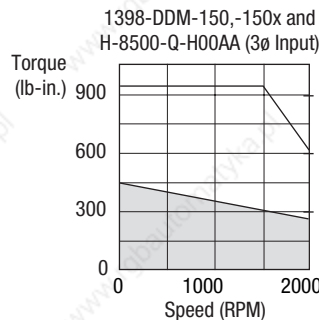
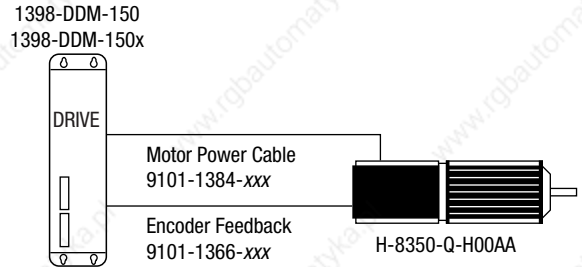
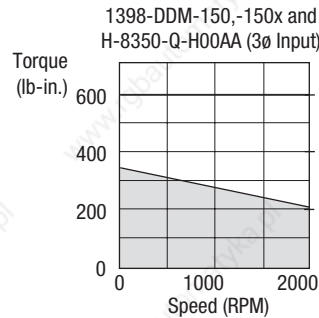
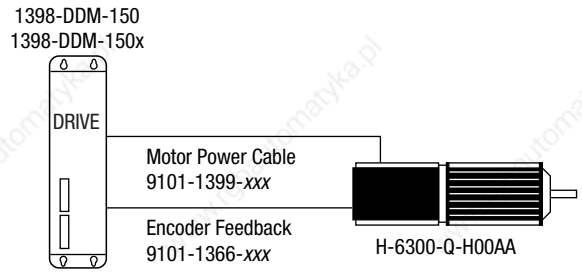
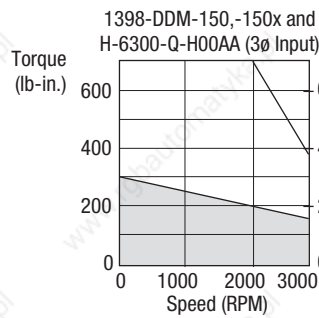

System speed-torque characteristics

Drive module input voltage = 230V AC RMS

- = Intermittent operating region
- = Continuous operating region

* Last three digits select standard cable lengths of:

10 ft (3.0 m)-010; 25 ft (7.7 m)-025; 50 ft (15.0 m)-050; 75 ft (23.0 m)-075; 100 ft (31 m)-100

Note: Serial interface cables for use with the ULTRA 100 drives cannot exceed 50 ft.

ULTRA Servo Drives with Y-Series Motors (115V AC RMS Input Voltage)

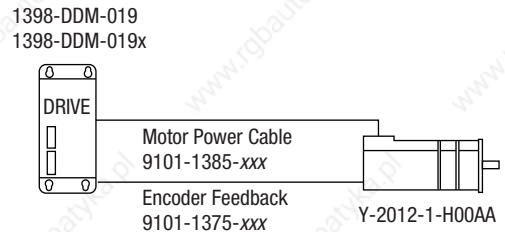
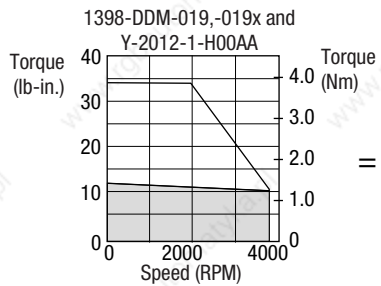
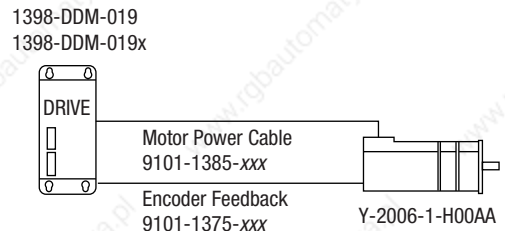
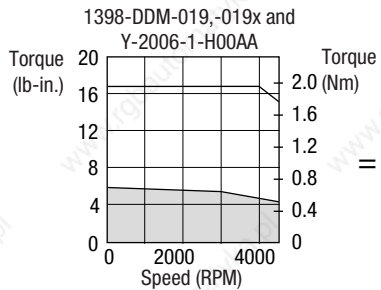
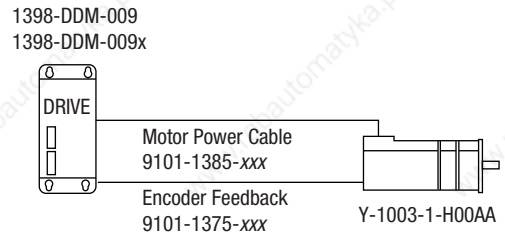
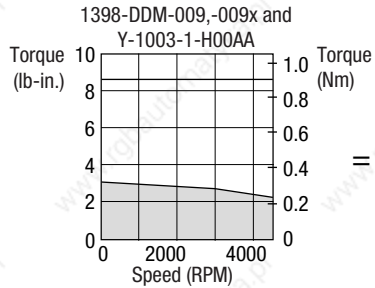
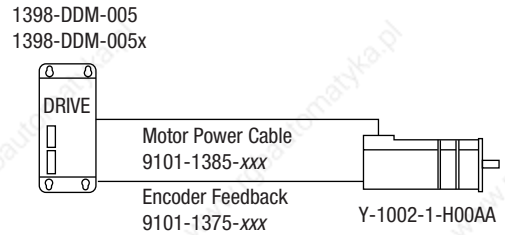
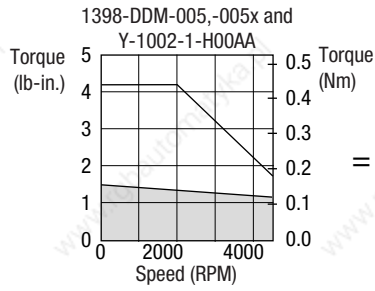

System speed-torque characteristics
Drive module input voltage = 115V AC RMS

= Intermittent operating region
 = Continuous operating region

* Last three digits select standard cable lengths of:
10 ft (3.0 m)-010; 25 ft (7.7 m)-025; 50 ft (15.0 m)-050; 75 ft (23.0 m)-075; 100 ft (31 m)-100
Note: Serial interface cables for use with the ULTRA 100 drives cannot exceed 50 ft.

ULTRA Servo Drives with Y-Series Motors (230V AC RMS Input Voltage)

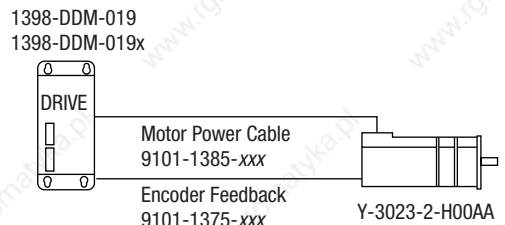
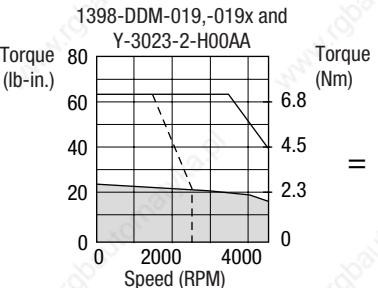
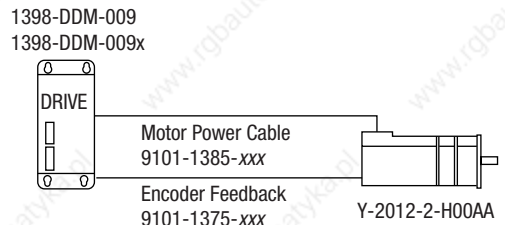
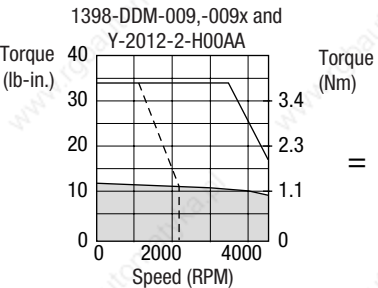
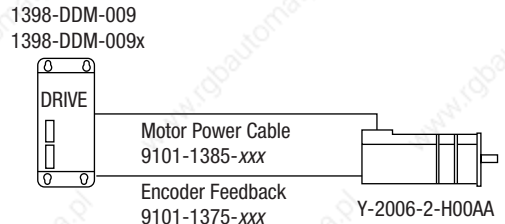
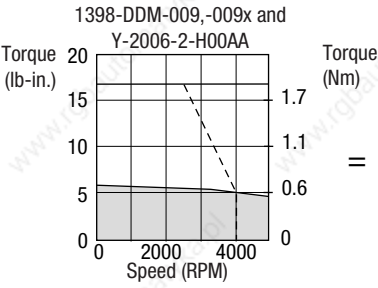
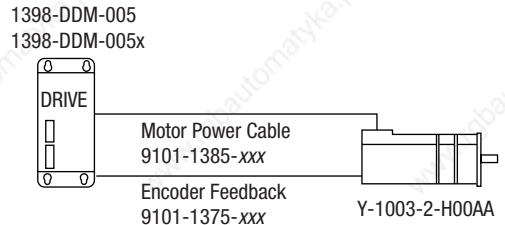
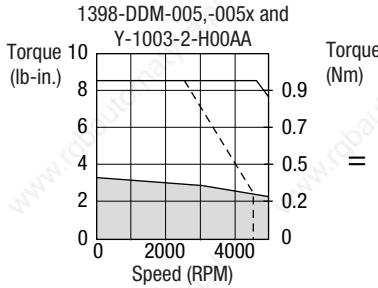
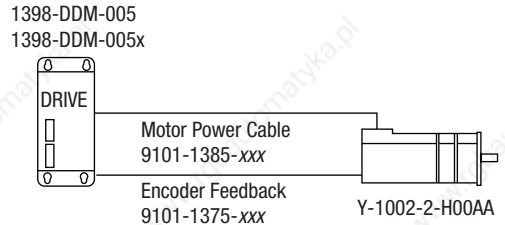
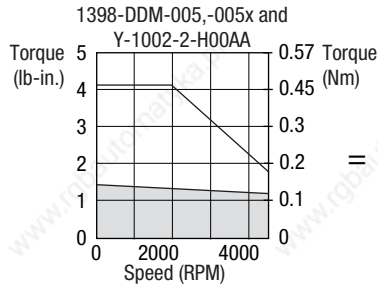

System speed-torque characteristics

Drive module input voltage = 230V AC RMS

- = Intermittent operating region
- = Continuous operating region
- = Drive operation with 115V AC RMS input voltage

* Last three digits select standard cable lengths of:

10 ft (3.0 m)-010; 25 ft (7.7 m)-025; 50 ft (15.0 m)-050; 75 ft (23.0 m)-075; 100 ft (31 m)-100

Note: Serial interface cables for use with the ULTRA 100 drives cannot exceed 50 ft.

ULTRA Servo Drives with N-Series Motors

1398-DDM-005,-005x and N-2302-1-F00AA

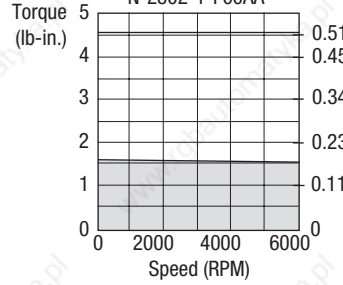

1398-DDM-005
1398-DDM-005x

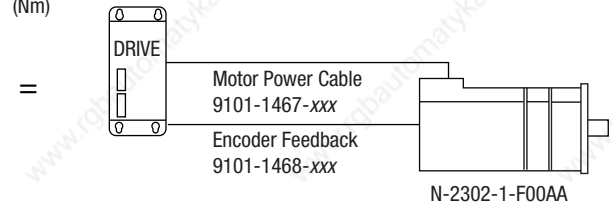

1398-DDM-005,-005x and N-2304-1-F00AA

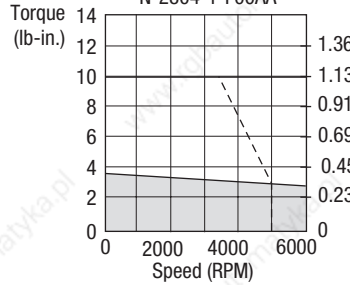

1398-DDM-005
1398-DDM-005x

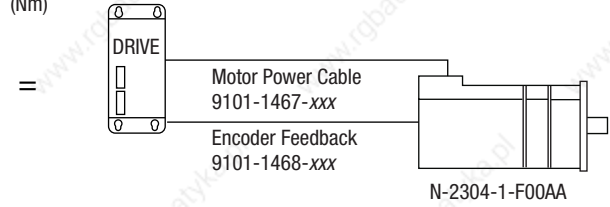

1398-DDM-010,-010x and N-2302-1-F00AA

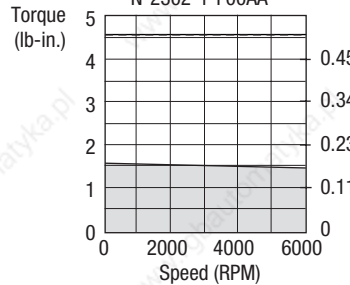

1398-DDM-010
1398-DDM-010x

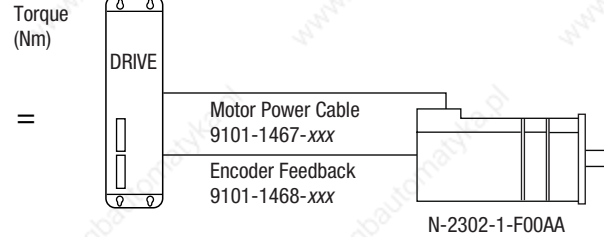

1398-DDM-010,-010x and N-2304-1-F00AA

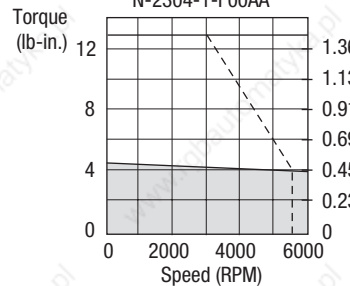

1398-DDM-010
1398-DDM-010x

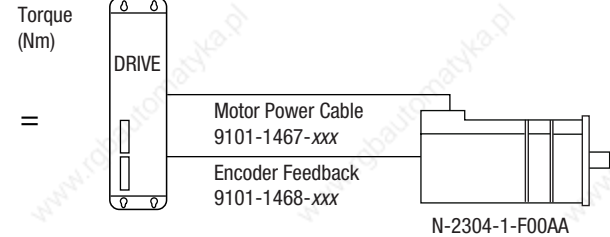

System speed-torque characteristics

Drive module input voltage = 230V AC RMS

* Last three digits select standard cable lengths of:

10 ft (3.0 m)-010; 25 ft (7.7 m)-025; 50 ft (15.0 m)-050; 75 ft (23.0 m)-075; 100 ft (31.0 m)-100

Note: Serial interface cables for use with the ULTRA 100 drives cannot exceed 50 ft.

- = Intermittent operating region
- = Continuous operating region
- = Drive operation with 115V AC RMS input voltage

ULTRA Servo Drives with N-Series Motors

1398-DDM-009,-009x and N-2304-1-F00AA

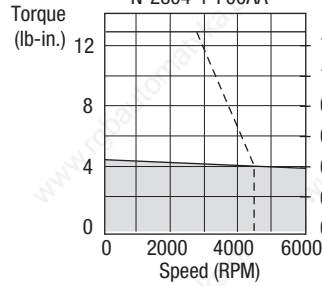

1398-DDM-009
1398-DDM-009x

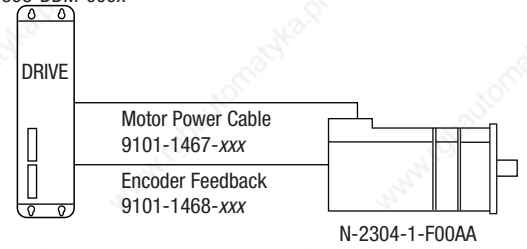

1398-DDM-009,-009x and N-3406-2-H00AA

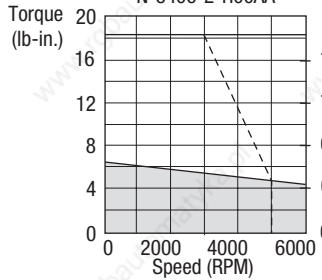

1398-DDM-009
1398-DDM-009x

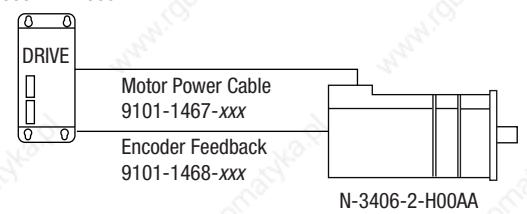

1398-DDM-009,-009x and N-3412-2-H00AA

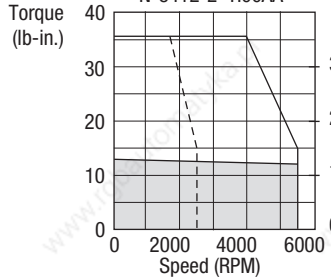

1398-DDM-009
1398-DDM-009x

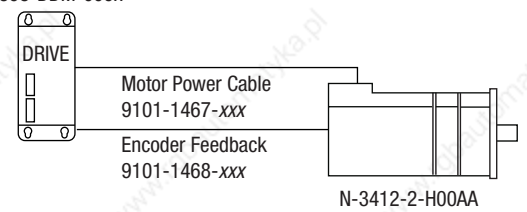

1398-DDM-009,-009x and N-4214-2-H00AA

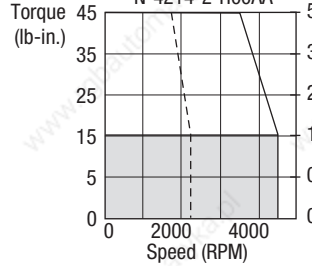

1398-DDM-009
1398-DDM-009x

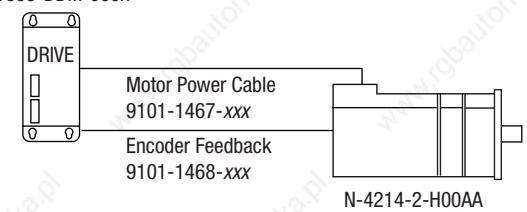

System speed-torque characteristics
Drive module input voltage = 230V AC

- = Intermittent operating region
- = Continuous operating region
- = Drive operation with 115V AC RMS input voltage

* Last three digits select standard cable lengths of:
10 ft (3.0 m)-010; 25 ft (7.7 m)-025; 50 ft (15.0 m)-050; 75 ft (23.0 m)-075; 100 ft (31.0 m)-100
Note: Serial interface cables for use with the ULTRA 100 drives cannot exceed 50 ft.

ULTRA Servo Drives with N-Series Motors

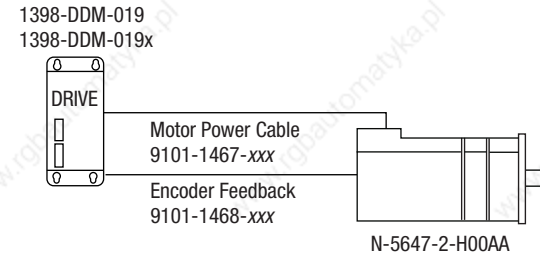
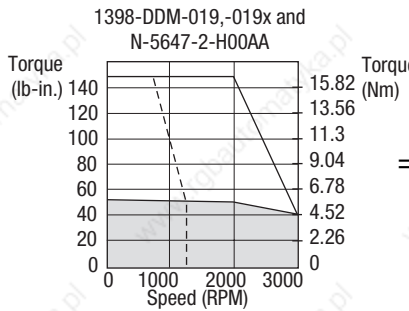
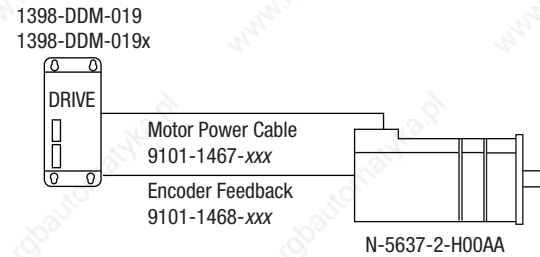
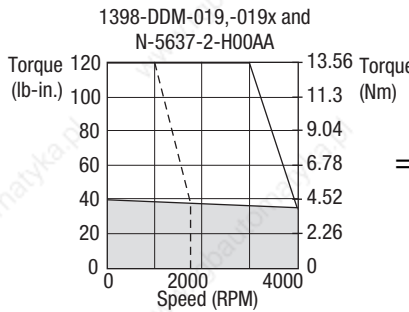
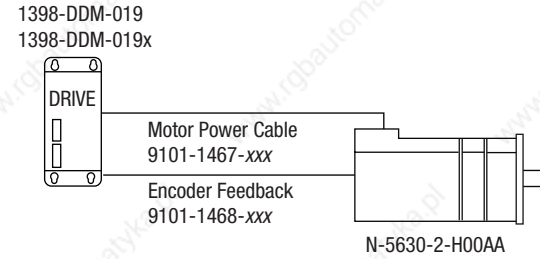
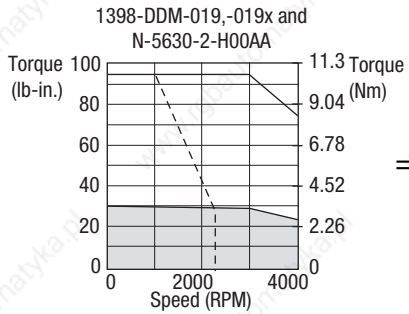
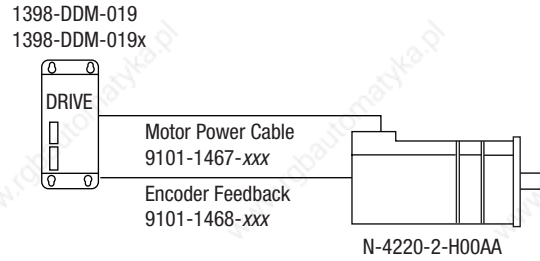
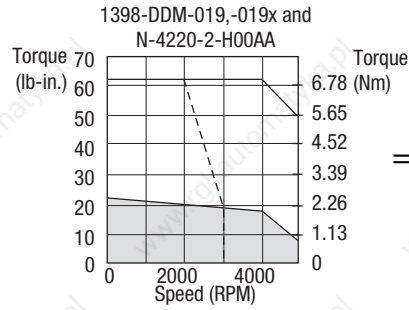



System speed-torque characteristics

Drive module input voltage = 230V AC RMS

* Last three digits select standard cable lengths of:

10 ft (3.0 m)-010; 25 ft (7.7 m)-025; 50 ft (15.0 m)-050; 75 ft (23.0 m)-075; 100 ft (31.0 m)-100

Note: Serial interface cables for use with the ULTRA 100 drives cannot exceed 50 ft.

-  = Intermittent operating region
-  = Continuous operating region
-  = Drive operation with 115V AC RMS input voltage

ULTRA Servo Drives with N-Series Motors

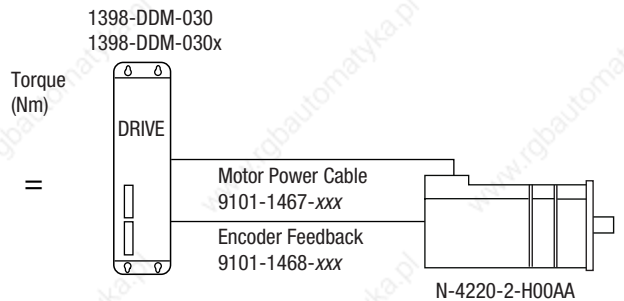
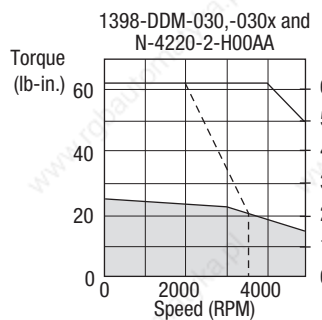
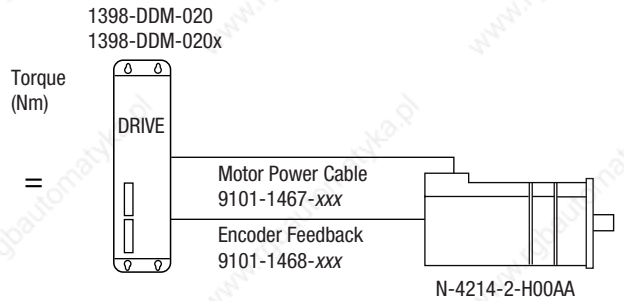
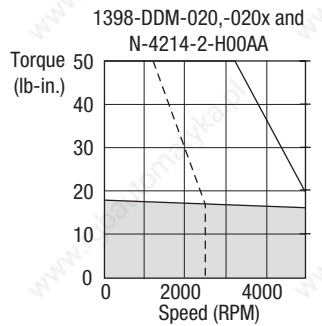
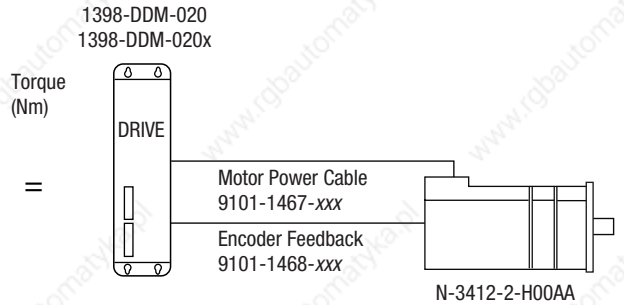
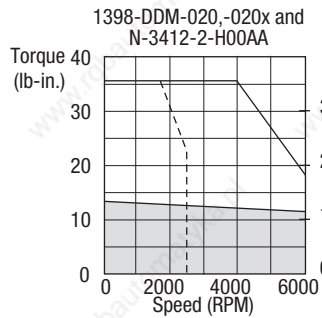
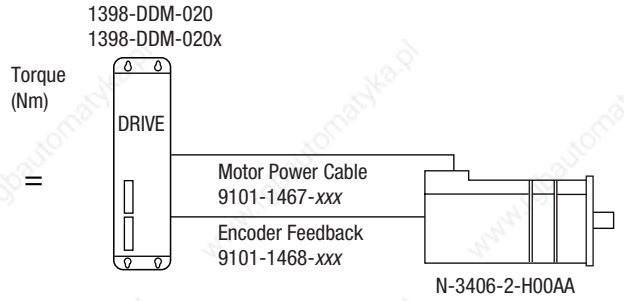
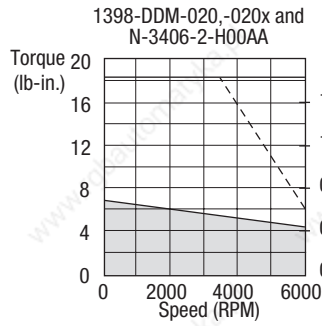

System speed-torque characteristics

Drive module input voltage = 230V AC RMS

- = Intermittent operating region
- = Continuous operating region
- = Drive operation with 115V AC RMS input voltage

* Last three digits select standard cable lengths of:

10 ft (3.0 m)-010; 25 ft (7.7 m)-025; 50 ft (15.0 m)-050; 75 ft (23.0 m)-075; 100 ft (31.0 m)-100

ULTRA Servo Drives with N-Series Motors

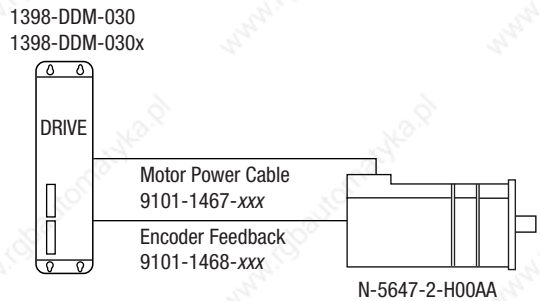
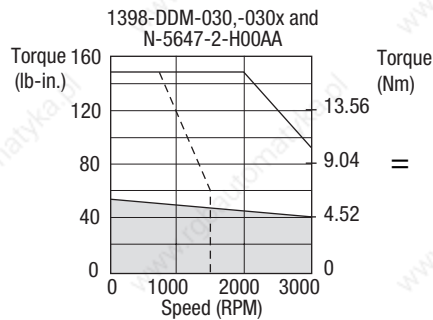
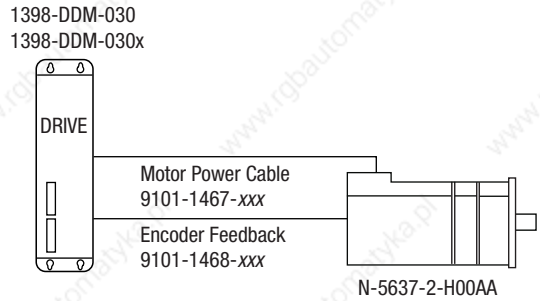
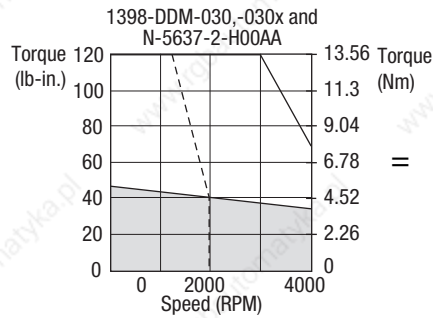
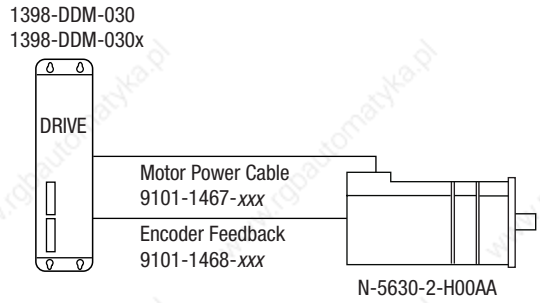
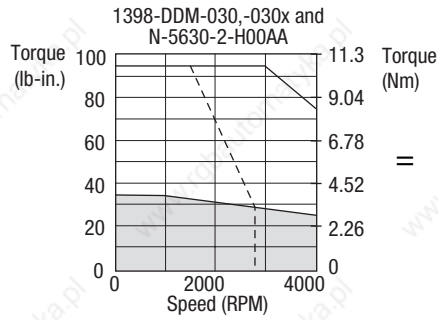

System speed-torque characteristics
Drive module input voltage = 230V AC RMS

- = Intermittent operating region
- = Continuous operating region
- = Drive operation with 115V AC RMS input voltage

* Last three digits select standard cable lengths of:
10 ft (3.0 m)-010; 25 ft (7.7 m)-025; 50 ft (15.0 m)-050; 75 ft (23.0 m)-075; 100 ft (31.0 m)-100

ULTRA Plus System Ordering Guide

ULTRA Plus Drives with F-Series Motors (1398-PDM-20, -30, and -75)

The following section illustrates the drive-motor combinations, motor power cables, and encoders available for purchase, as well as the speed/torque reference table for each combination.

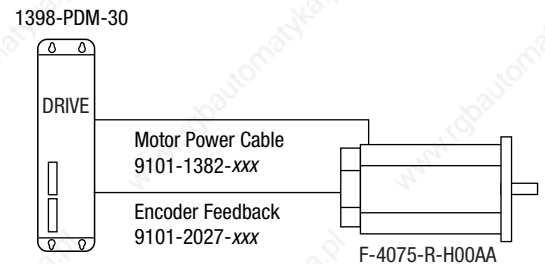
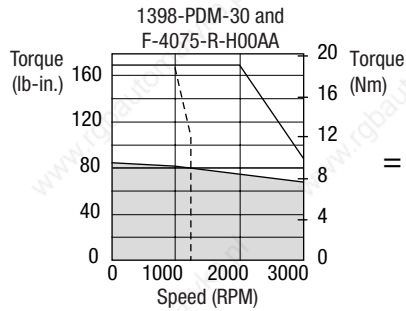
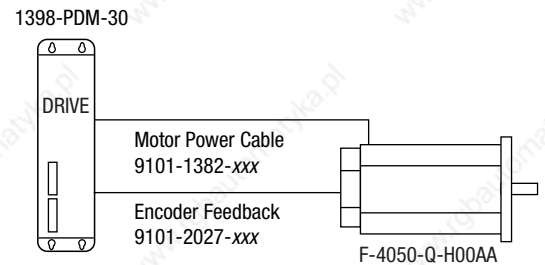
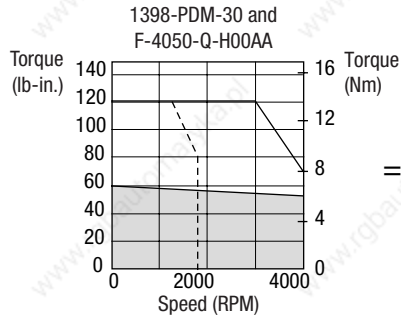
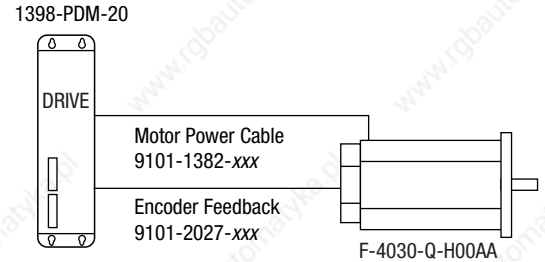
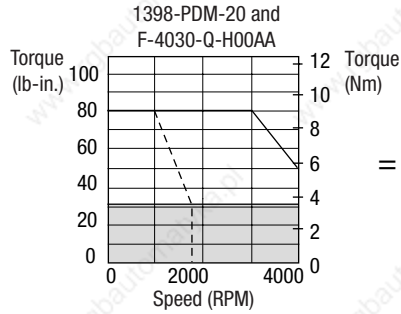

System speed-torque characteristics

Drive module input voltage = 230V AC RMS

* Last three digits select standard cable lengths of:

10 ft (3.0 m)-010; 25 ft (7.7 m)-025; 50 ft (15.0 m)-050; 75 ft (23.0 m)-075

- = Intermittent operating region
- = Continuous operating region
- = Drive operation with 115V AC RMS input voltage

ULTRA Plus Drives with F-Series Motors (1398-PDM-20, -30, and -75)

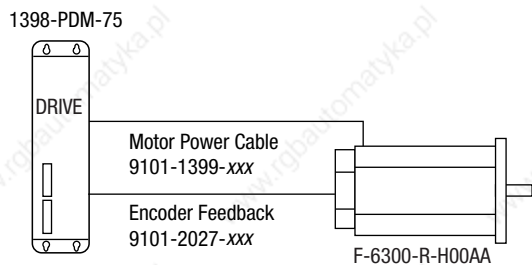
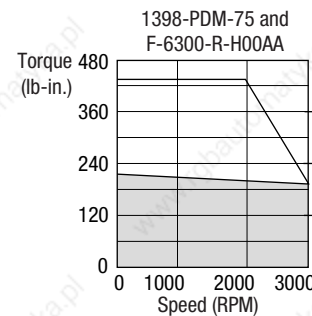
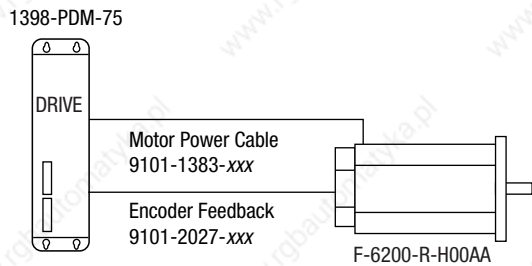
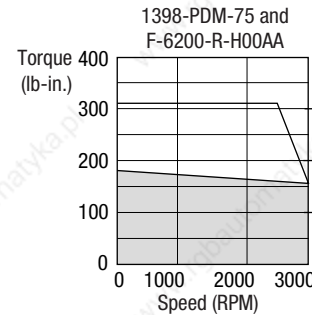
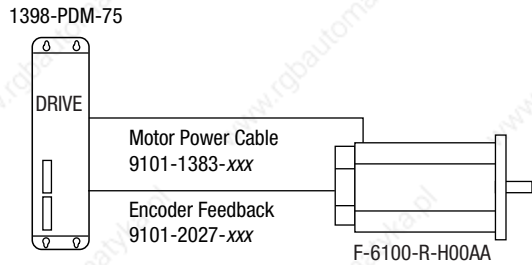
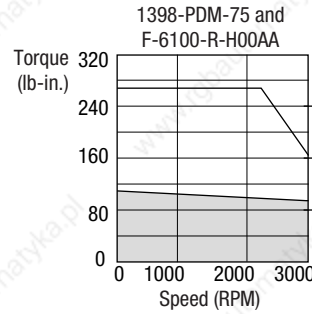
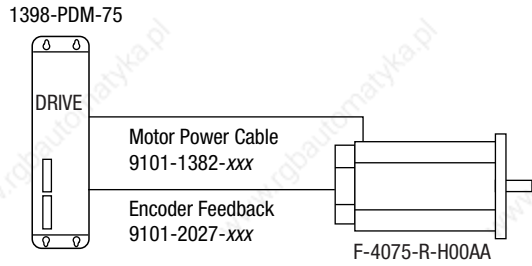
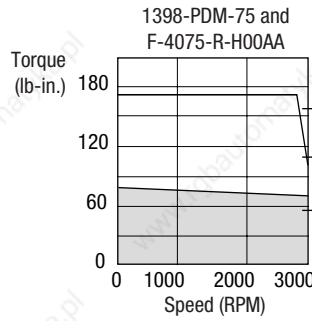

System speed-torque characteristics

Drive module input voltage = 230V AC RMS

- = Intermittent operating region
- = Continuous operating region

* Last three digits select standard cable lengths of:
10 ft (3.0 m)-010; 25 ft (7.7 m)-025; 50 ft (15.0 m)-050; 75 ft (23.0 m)-075

ULTRA Plus Drives with F-Series Motors (1398-PDM-25, -50, -100, and -150)

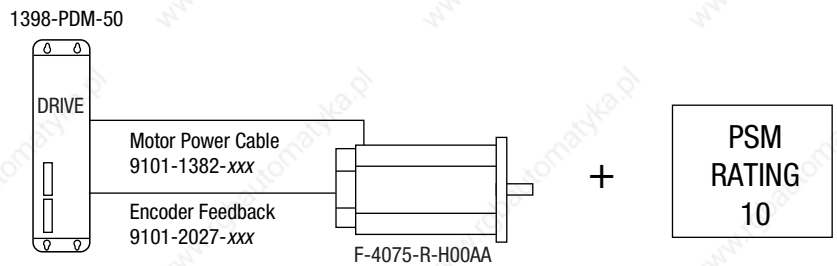
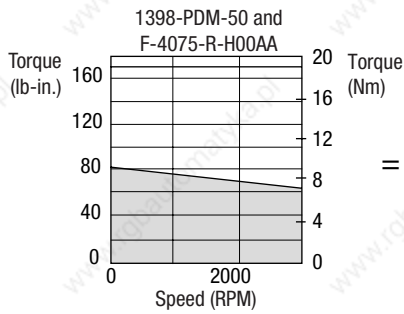
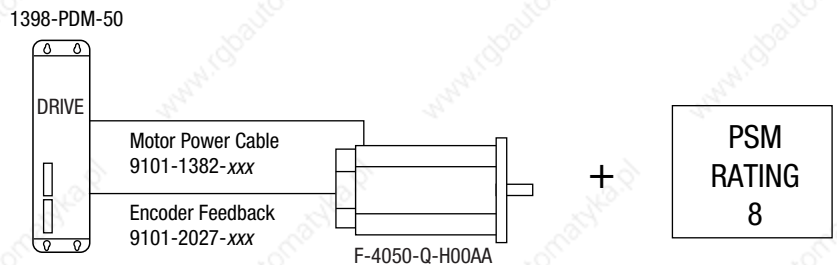
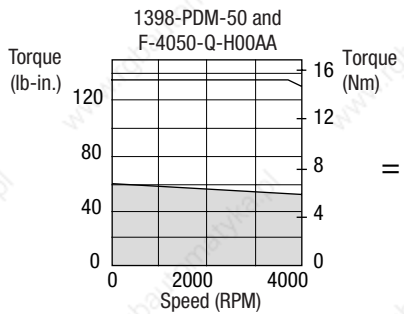
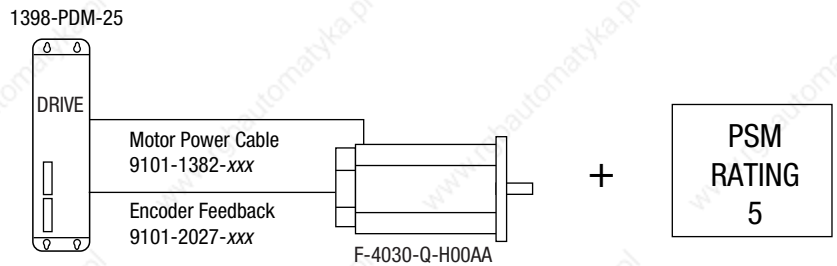
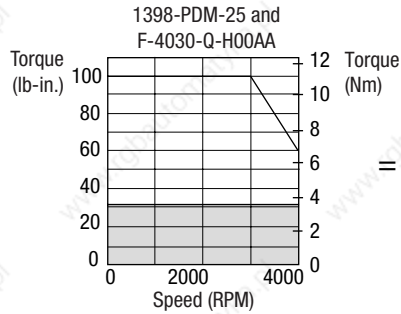

System speed-torque characteristics

Drive module input voltage = 230V AC RMS

□ = Intermittent operating region
 ■ = Continuous operating region

* Last three digits select standard cable lengths of:
 10 ft (3.0 m)-010; 25 ft (7.7 m)-025; 50 ft (15.0 m)-050; 75 ft (23.0 m)-075

ULTRA Plus Drives with F-Series Motors (1398-PDM-25, -50, -100, and -150)

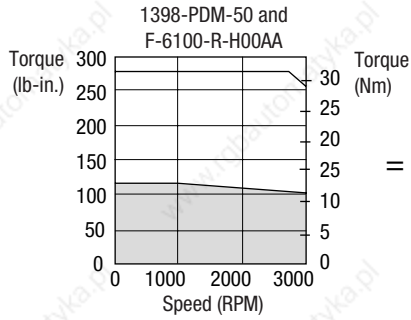

1398-PDM-50



Motor Power Cable
9101-1383-xxx

Encoder Feedback
9101-2027-xxx

F-6100-R-H00AA

+

**PSM
RATING
12**

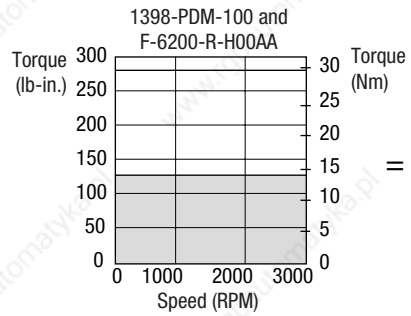

1398-PDM-100

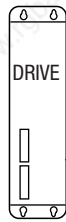

Motor Power Cable
9101-1383-xxx

Encoder Feedback
9101-2027-xxx

F-6200-R-H00AA

+

**PSM
RATING
20**

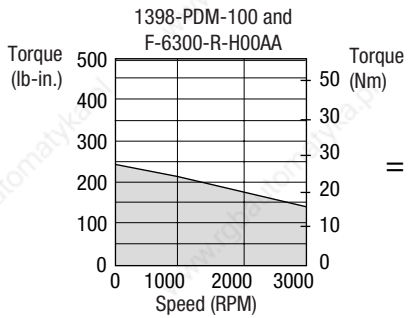

1398-PDM-100

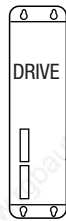

Motor Power Cable
9101-1399-xxx

Encoder Feedback
9101-2027-xxx

F-6300-R-H00AA

+

**PSM
RATING
30**

System speed-torque characteristics

Drive module input voltage = 230V AC RMS

- = Intermittent operating region
- = Continuous operating region

* Last three digits select standard cable lengths of:

10 ft (3.0 m)-010; 25 ft (7.7 m)-025; 50 ft (15.0 m)-050; 75 ft (23.0 m)-075

Note: Serial interface and encoder cables for use with the ULTRA 100 drives cannot exceed 50 ft.

ULTRA Plus Drives with H-Series Motors (1398-PDM-10, -20, -30, and -75)

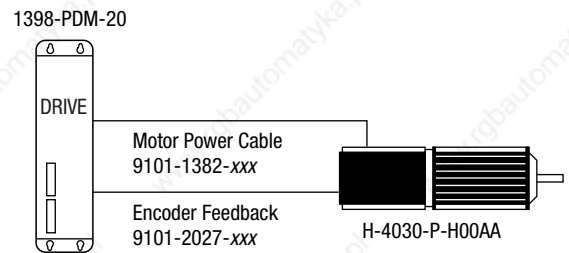
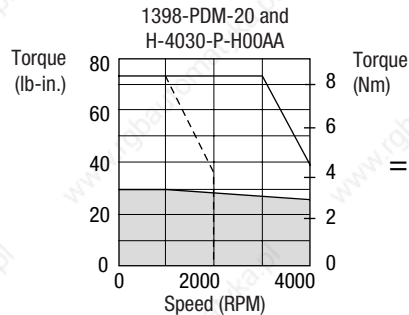
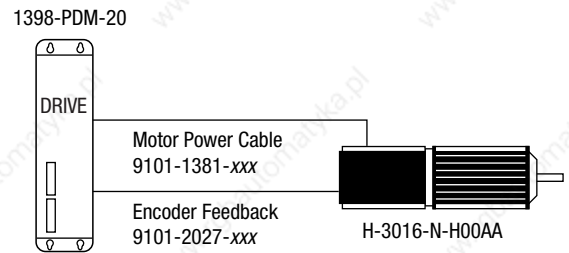
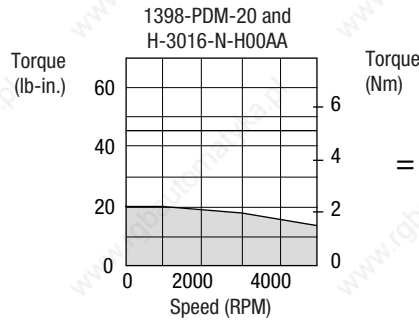
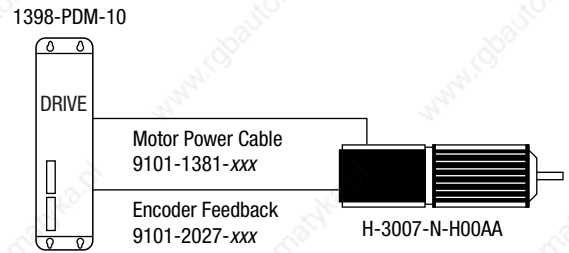
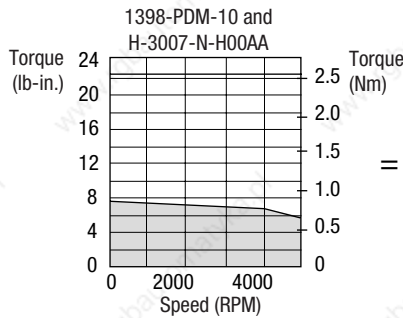
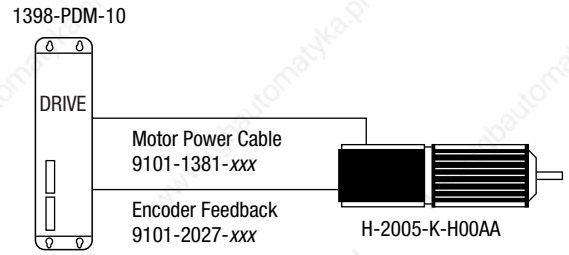
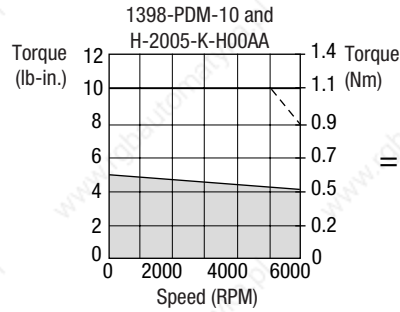

System speed-torque characteristics
Drive module input voltage = 230V AC RMS

* Last three digits select standard cable lengths of:
10 ft (3.0 m)-010; 25 ft (7.7 m)-025; 50 ft (15.0 m)-050; 75 ft (23.0 m)-075

- = Intermittent operating region
- = Continuous operating region
- = Drive operation with 115V AC RMS input voltage

ULTRA Plus Drives with H-Series Motors (1398-PDM-10, -20, -30, and -75)

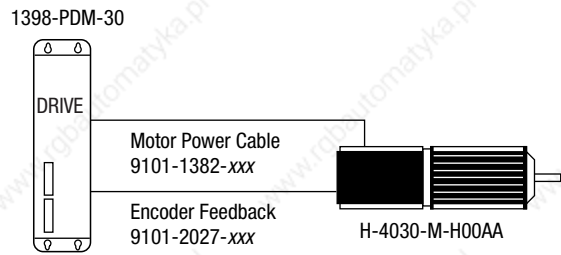
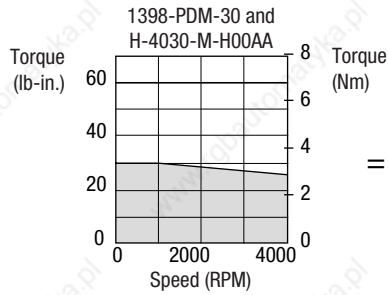

Note: For the H-4030-M-H00AA, the drive module input voltage may be either 115 or 230 VAC RMS.

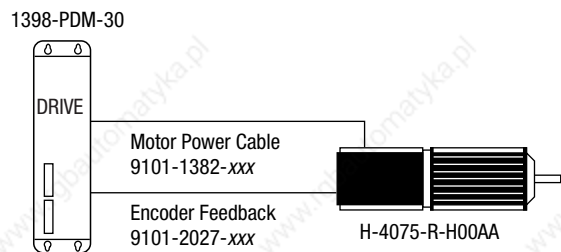
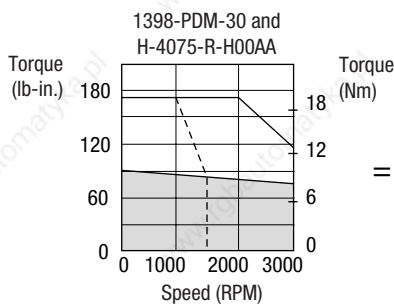
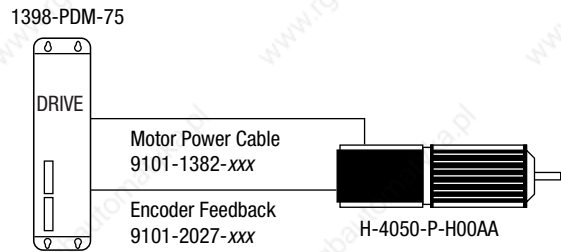
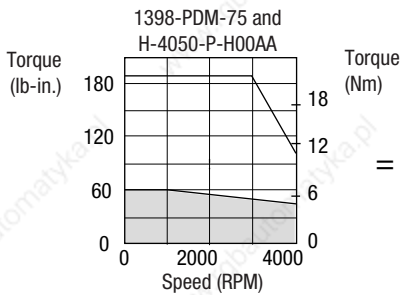
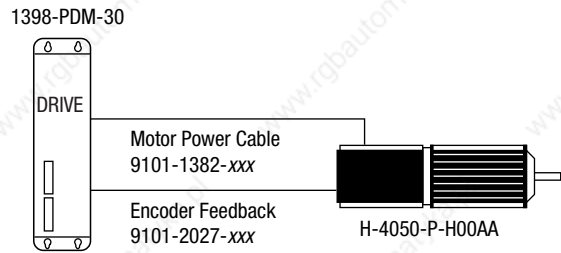
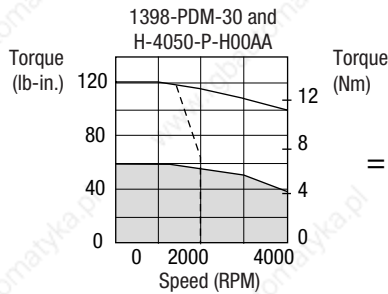

System speed-torque characteristics
Drive module input voltage = 230V AC RMS

- = Intermittent operating region
- = Continuous operating region
- = Drive operation with 115V AC RMS input voltage

* Last three digits select standard cable lengths of:
10 ft (3.0 m)-010; 25 ft (7.7 m)-025; 50 ft (15.0 m)-050; 75 ft (23.0 m)-075

ULTRA Plus Drives with H-Series Motors (1398-PDM-10, -20, -30, and -75)

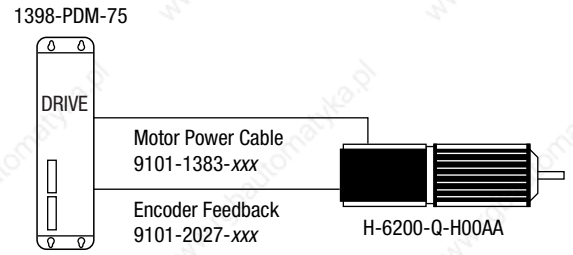
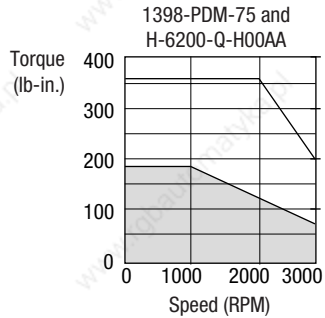
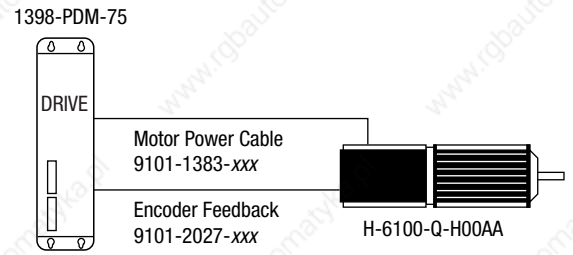
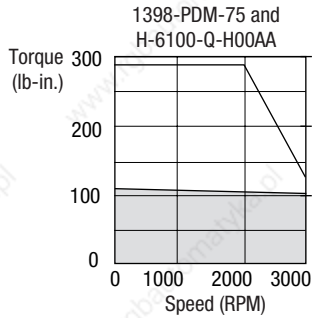
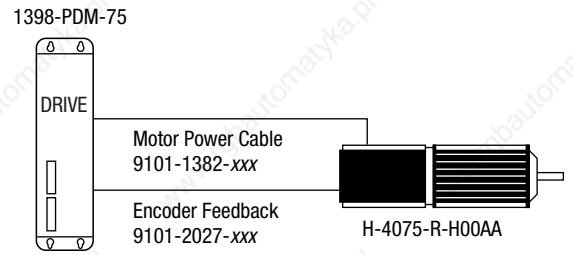
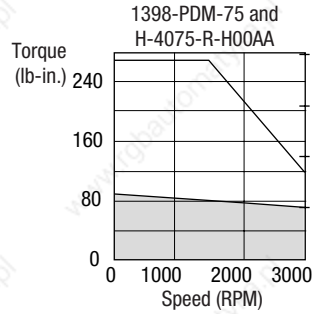

System speed-torque characteristics

Drive module input voltage = 230V AC RMS

* Last three digits select standard cable lengths of:

10 ft (3.0 m)-010; 25 ft (7.7 m)-025; 50 ft (15.0 m)-050; 75 ft (23.0 m)-075

- = Intermittent operating region
- = Continuous operating region
- = Drive operation with 115V AC RMS input voltage

ULTRA Plus Drives with H-Series Motors (1398-PDM-25, -50, -100, and -150)

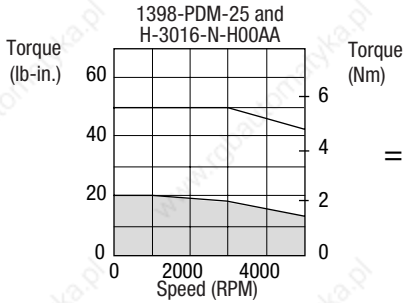

1398-PDM-25



Motor Power Cable
9101-1381-xxx
Encoder Feedback
9101-2027-xxx

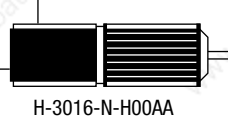

+

**PSM
RATING
4**

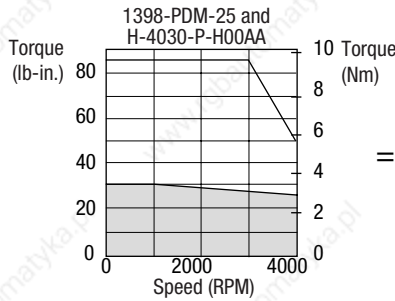

1398-PDM-25



Motor Power Cable
9101-1382-xxx
Encoder Feedback
9101-2027-xxx

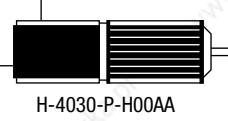

+

**PSM
RATING
5**

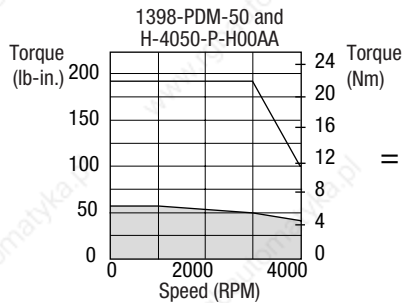

1398-PDM-50



Motor Power Cable
9101-1382-xxx
Encoder Feedback
9101-2027-xxx

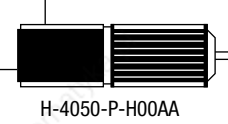

+

**PSM
RATING
8**

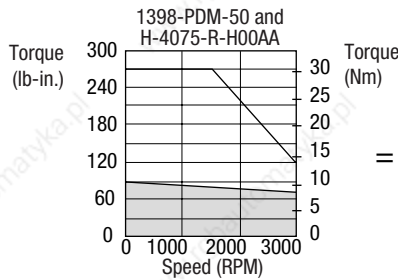

1398-PDM-50



Motor Power Cable
9101-1382-xxx
Encoder Feedback
9101-2027-xxx



+

**PSM
RATING
10**

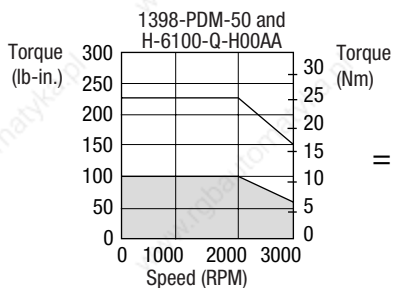

1398-PDM-50



Motor Power Cable
9101-1383-xxx
Encoder Feedback
9101-2027-xxx

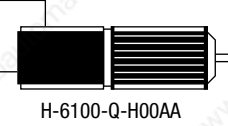

+

**PSM
RATING
12**

System speed-torque characteristics
Drive module input voltage = 230V AC RMS

- = Intermittent operating region
- = Continuous operating region
- = Drive operation with 115V AC RMS input voltage

* Last three digits select standard cable lengths of:
10 ft (3.0 m)-010; 25 ft (7.7 m)-025; 50 ft (15.0 m)-050; 75 ft (23.0 m)-075

ULTRA Plus Drives with H-Series Motors (1398-PDM-25, -50, -100, and -150)

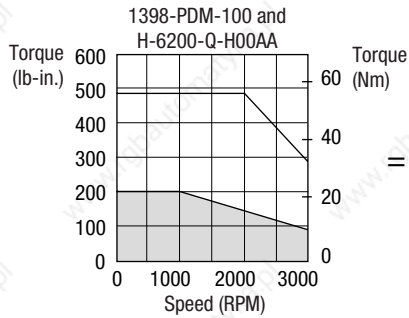

1398-PDM-100

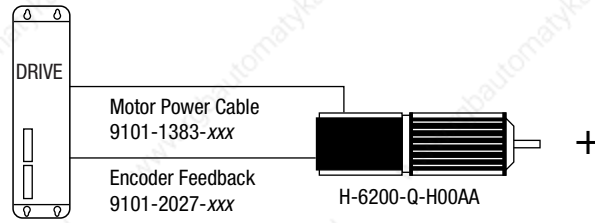

PSM RATING
20

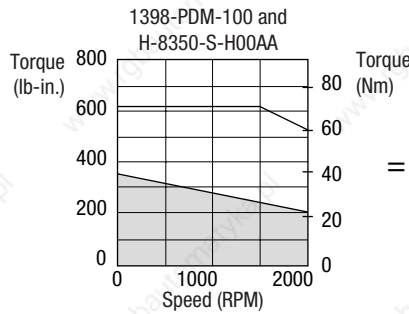

1398-PDM-100

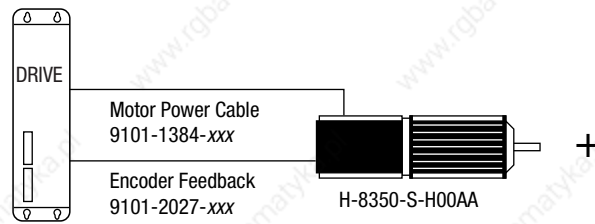

PSM RATING
45

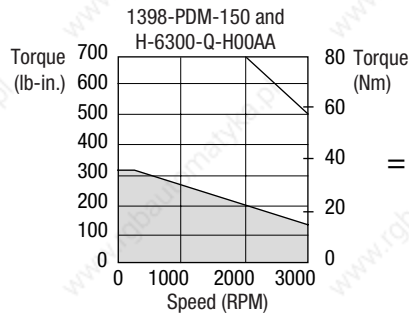

1398-PDM-150

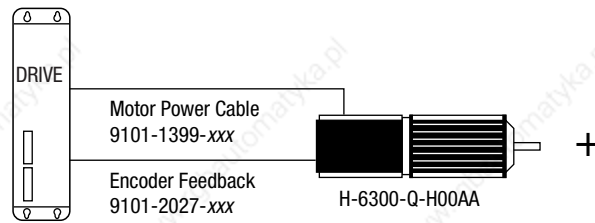

PSM RATING
30

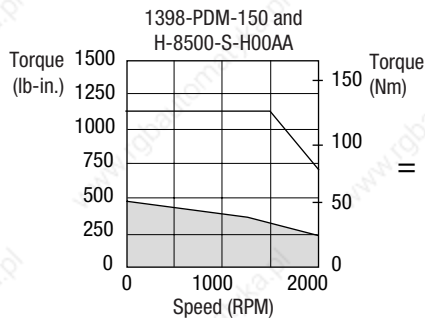

1398-PDM-150

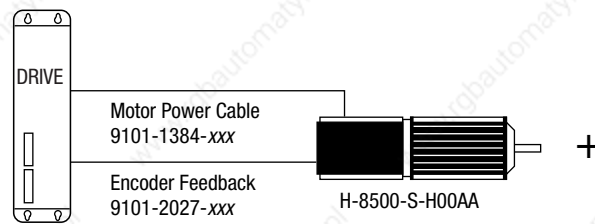

PSM RATING
55

System speed-torque characteristics
Drive module input voltage = 230V AC RMS

- = Intermittent operating region
- = Continuous operating region
- = Drive operation with 115V AC RMS input voltage

* Last three digits select standard cable lengths of:
10 ft (3.0 m)-010; 25 ft (7.7 m)-025; 50 ft (15.0 m)-050; 75 ft (23.0 m)-075

ULTRA Plus Drives with N-Series Motors (1398-PDM-20 and 1398-PDM-30)

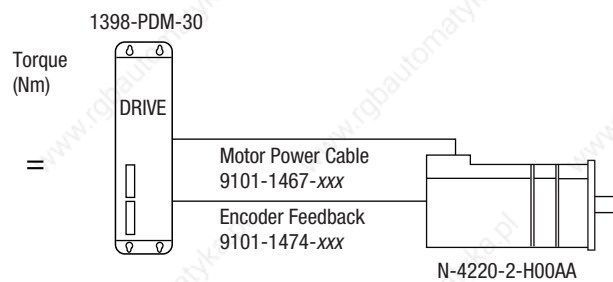
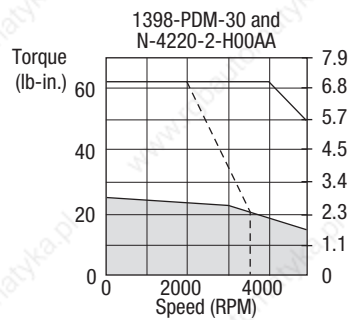
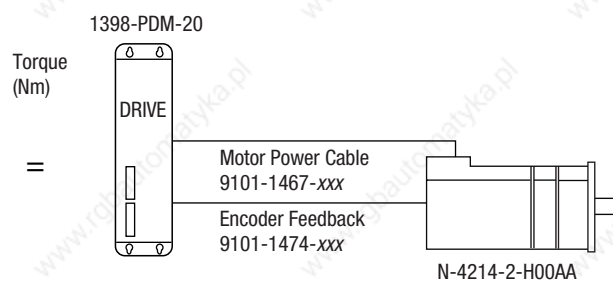
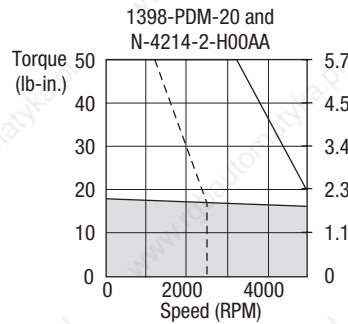
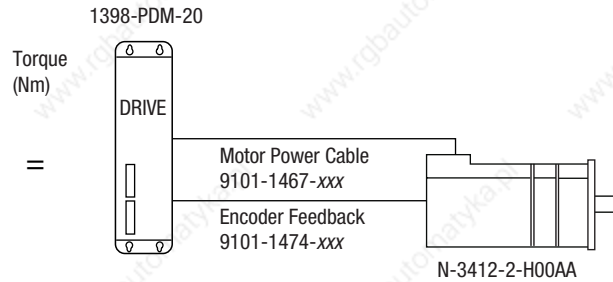
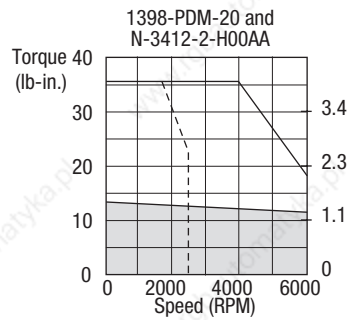
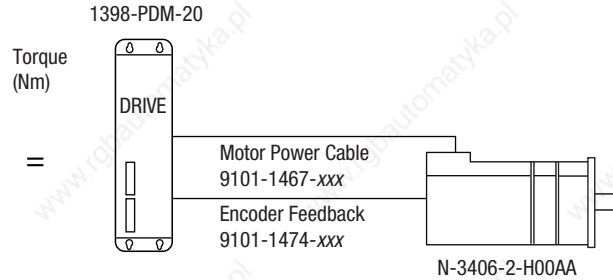
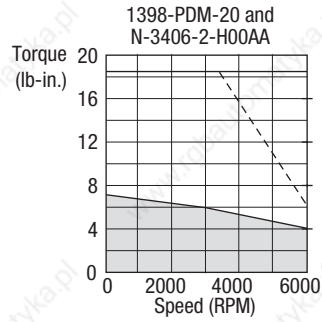

System speed-torque characteristics

Drive module input voltage = 230V AC RMS

* Last three digits select standard cable lengths of:

10 ft (3.0 m)-010; 25 ft (7.7 m)-025; 50 ft (15.0 m)-050; 75 ft (23.0 m)-075

- = Intermittent operating region
- = Continuous operating region
- = Drive operation with 115V AC RMS input voltage

ULTRA Plus Drives with N-Series Motors (1398-PDM-20 and 1398-PDM-30)

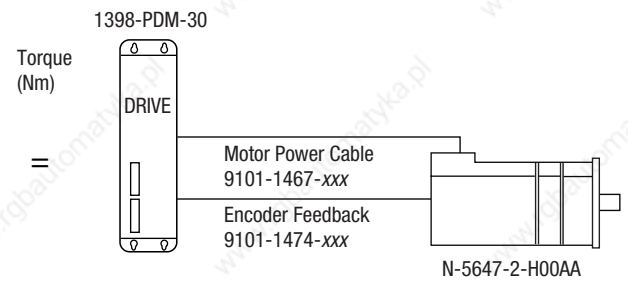
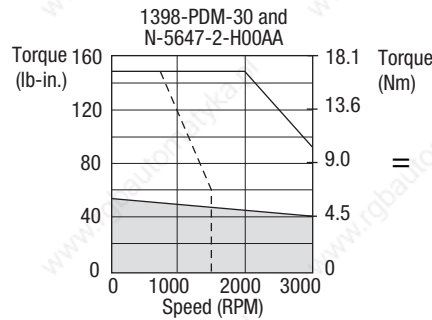
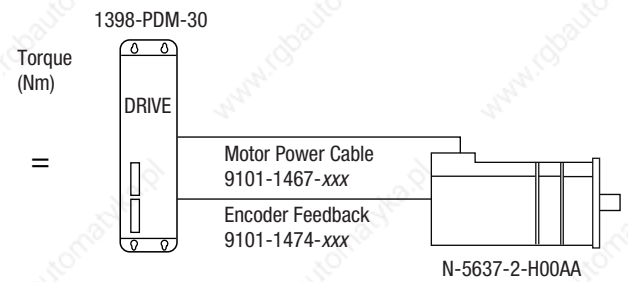
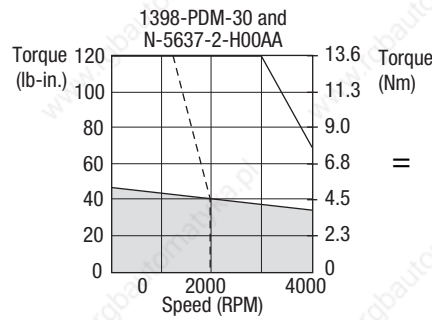
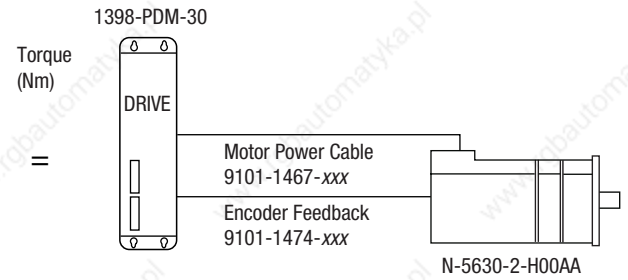
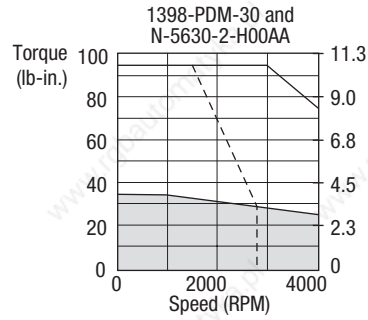

System speed-torque characteristics
Drive module input voltage = 230V AC RMS

- = Intermittent operating region
- = Continuous operating region
- = Drive operation with 115V AC RMS input voltage

* Last three digits select standard cable lengths of:
10 ft (3.0 m)-010; 25 ft (7.7 m)-025; 50 ft (15.0 m)-050; 75 ft (23.0 m)-075

F-Series Motor and Connector Ordering Information

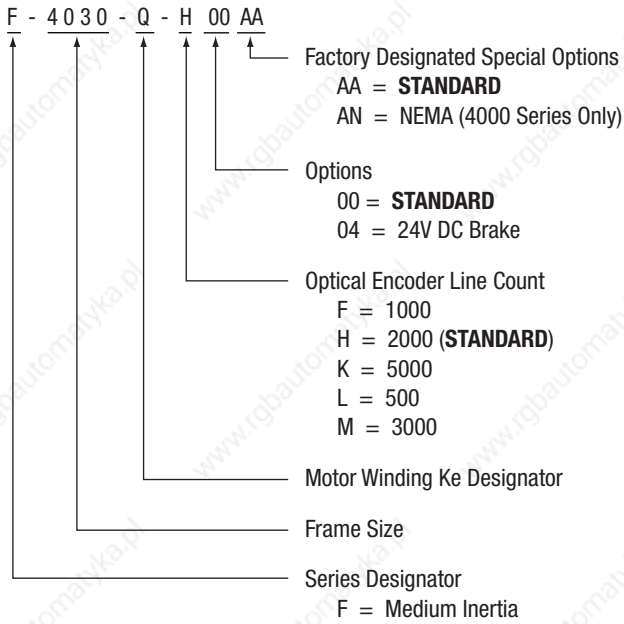

MOTOR MATING CONNECTORS

MS CONN KITS F-SERIES MOTOR POWER

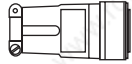

	STRAIGHT	RIGHT ANGLE
F-4000 SERIES:	9101-0326	9101-0399
F-6000 SERIES:	9101-0327	9101-0400

MS CONN KIT

STRAIGHT	RIGHT ANGLE
9101-0329	9101-0402
F-Series Encoder Feedback	



MS CONN KIT

STRAIGHT	RIGHT ANGLE
9101-0330	9101-0403
Brake Power	

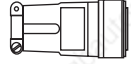

F-SERIES MOTOR SHAFT SEAL KITS

F-4000 SERIES: 0041-5060
 F-6000 SERIES: 0041-5061

Shaft seals generally require the presence of a lubricant to reduce premature wear

Note: The mating connectors listed above are not CE compliant. See the cable options for CE compliant cable assemblies.

Note: Optional configurations or encoder line counts have extended lead times and additional charges

Note: Options are not available in all sizes

* The maximum speed with the 5000-line encoder is 2400 RPM because of the frequency output limit of the encoder.

H-Series Motor and Connector Ordering Information

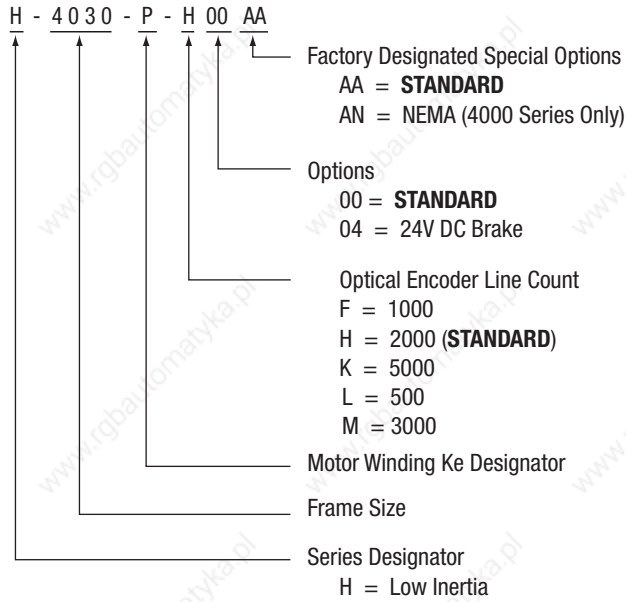

Note: Optional configurations or encoder line counts have extended lead times and additional charges

Note: Options are not available in all sizes

Note: 5000 line count encoder, motor top speed is limited to 3600 RPM due to frequency output limit of encoder. Check drive system configuration data for any additional restrictions imposed by drive input.

Motor Mating Connectors		
MOTOR SERIES	STRAIGHT	RIGHT ANGLE
H-2000, -3000	9101-0325 (MS3106F18-4S)	9101-0398 (MS3108F18-4S)
H-4000	9101-0326 (MS3106F20-4S)	9101-0399 (MS3108F20-4S)
H-6000	9101-0327 (MS3106F24-22S)	9101-0400 (MS3108F24-22S)
H-8000	9101-0328 (MS3106F32-17S)	9101-0401 (MS3108F32-17S)

BRAKE POWER CONNECTORS	
STRAIGHT	RIGHT ANGLE
9101-0330 (MS3106F12S-3S)	9101-0403 (MS3108F12S-3S)

ENCODER FEEDBACK CONNECTORS	
STRAIGHT	RIGHT ANGLE
9101-0329 (MS3106F20-29S)	9101-0402 (MS3108F20-29S)

H-SERIES MOTOR SHAFT SEAL KITS	
H-2000	Series:
H-3000 Series:	0041-5065
H-4000 Series:	0041-5058
H-6000 Series:	0041-5059
H-8000 Series:	0041-5053-005

Shaft seal kits generally require the presence of a lubricant to reduce premature wear.

Note: The mating connectors listed above are not CE compliant. See the cable options for CE compliant cable assemblies.

Y-Series Motor and Connector Ordering Information

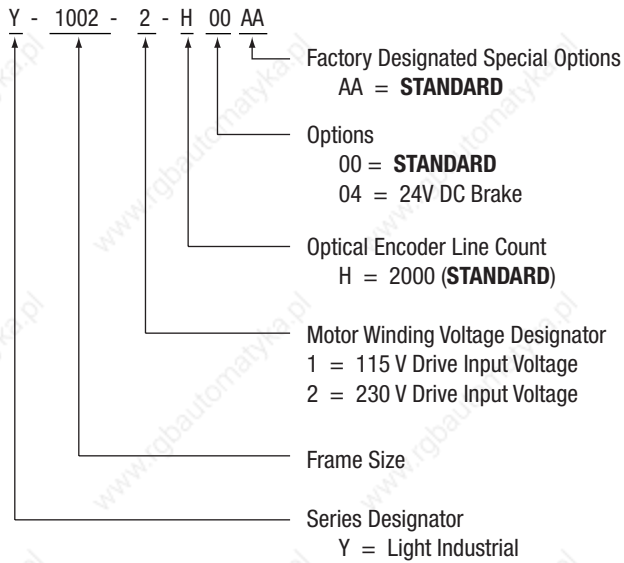

Motor Mating Connectors

CONNECTOR KITS FOR Y-SERIES MOTORS

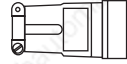

ALL Y-SERIES MOTORS
9106-0066

This kit includes connector, pins, and backshell for both the power and encoder connectors.

Note: The mating connectors listed above are not CE compliant. See the cable options for CE compliant cable assemblies.

N-Series Motor and Connector Ordering Information

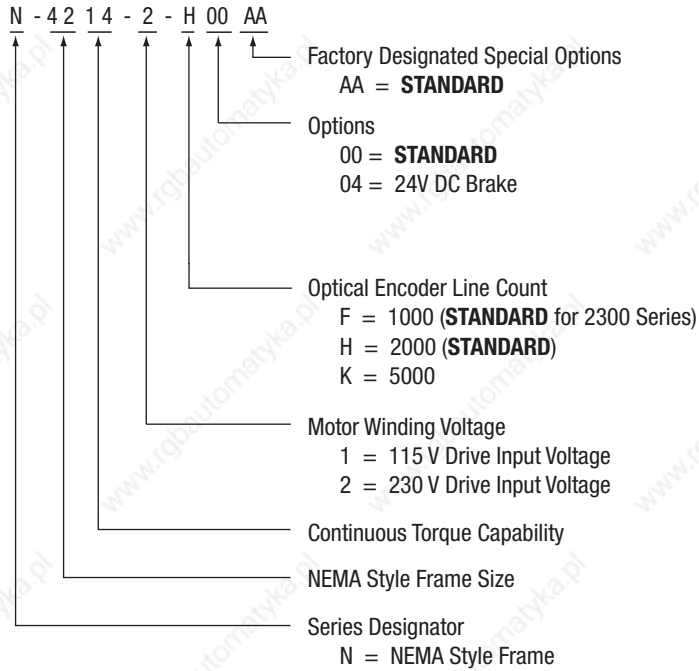

Note: Optional configurations or encoder line counts have extended lead times and additional charges

Note: Options are not available in all sizes

Note: 5000 line count encoder, motor top speed is limited to 3600 RPM due to frequency output limit of encoder. Check drive system configuration data for any additional restrictions imposed by drive input.

Motor Mating Connectors

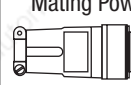
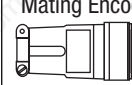
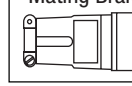
<p style="text-align: center;">MS CONN KIT</p> <p style="text-align: center;">Mating Power Connector</p>  <p style="text-align: right;">9101-1557</p>	<p style="text-align: center;">MS CONN KIT</p> <p style="text-align: center;">Mating Encoder Connector</p>  <p style="text-align: right;">9101-1558</p>
<p style="text-align: center;">MS CONN KIT</p> <p style="text-align: center;">Mating Brake Connector</p>  <p style="text-align: right;">9101-1698</p>	

POWER CONNECTOR		
	STRAIGHT	RIGHT ANGLE
Solder	MS3116F14-5S	KPT08F14-5S
Crimp	MS3126F14-5S	KPSE08F14-5S

BRAKE POWER CONNECTOR		
	STRAIGHT	RIGHT ANGLE
Solder	MS3116F12-3S	KPT08F12-3S
Crimp	MS3126F12-3S	KPSE08F12-3S

F-SERIES MOTOR SHAFT SEAL KITS

N-2300 SERIES: 0041-5068
 N-3400 SERIES: 0041-5069
 N-4200 SERIES: 0041-5070
 N-5600 SERIES: 0041-5071

Shaft seals generally require the presence of a lubricant to reduce premature wear

ENCODER CONNECTOR		
	STRAIGHT	RIGHT ANGLE
Solder	MS3116F14-19S	KPT08F14-19S
Crimp	MS3126F14-19S	KPSE08F14-19S

Note: The mating connectors listed above are not CE compliant. See the cable options for CE compliant cable assemblies.

For more information refer to our web site: www.ab.com/motion

ULTRA Series, ULTRA 100, and ULTRA 200 are registered trademarks of Allen-Bradley Company, Inc.

www.rockwellautomation.com

Power, Control and Information Solutions Headquarters

Americas: Rockwell Automation, 1201 South Second Street, Milwaukee, WI 53204-2496 USA, Tel: (1) 414.382.2000, Fax: (1) 414.382.4444

Europe/Middle East/Africa: Rockwell Automation, Vorstlaan/Boulevard du Souverain 36, 1170 Brussels, Belgium, Tel: (32) 2 663 0600, Fax: (32) 2 663 0640

Asia Pacific: Rockwell Automation, Level 14, Core F, Cyberport 3, 100 Cyberport Road, Hong Kong, Tel: (852) 2887 4788, Fax: (852) 2508 1846

Publication 1398-2.1 – August 1999

Supersedes Publication 1398-2.0 - February 1999

© 1999 Rockwell International. All Rights Reserved. Printed in USA