



motion control

SERVOMOTORS



High Performance
Motors and Accessories

SIEMENS

Catalogs of the Motion Control Series

General Motion Control Catalog Part 1

SIMOVERT MASTERDRIVES MC
0.75 HP to 270 HP



Order No.: DRSP-02060

Catalog MC Part 2

High Performance
Motors and Accessories



Order No.: DRSP-02062

General Motion Control Catalog Part 3

SIMODRIVE 611 universal
and POSMO A
Single-Motor and Multi-Motor Drives
1.5 HP to 160 HP



Order No.: DRSP-02080

SIEMENS

Servomotors

High Performance Motors and Accessories

Catalog MC Part 2 · 2002/2003

Supersedes: Catalog GMC Part 2 · 1999

The products and systems described in this catalog are sold under application of a management system certified by DQS. The DQS Certificate is recognized in all IQ Net countries.



DQS-certified in accordance with
DIN EN ISO 9001 Reg.-No. 1258-05
DIN EN ISO 14001 Reg.-No. 81342-01

Overview

1

Synchronous Servomotors

2

Asynchronous Servomotors

3

Built-on Accessories

4

Connecting Systems

5

Documentation

6

Configuration Aids

7

Dimension Drawings

8

Appendix

A

Note

The technical data are intended for general information.
Please observe the Operating Instructions and the references indicated on the products for installation, operation and maintenance.

Trademarks

® COMBIMASTER, DURIGINIT, MICROMASTER, MOTION-CONNECT, SIMADYN, SIMATIC, SIMATIC HMI, SIMODRIVE, SIMOREG, SIMOTION and SIMOVERT are Siemens registered trademarks.

All other products and system names in this catalog are (registered) trademarks of their respective owners and must be treated accordingly.

- The technical data, selection and ordering data (Order Nos.), accessories and availability are subject to alteration.
- All dimensions in this catalog are stated in inches and in (mm).

Servomotors

Overview



1/2

Brief description

1/3

Flow chart
Selection procedure

1/8

Overview of types and rated data

1/11

Technical explanations

1

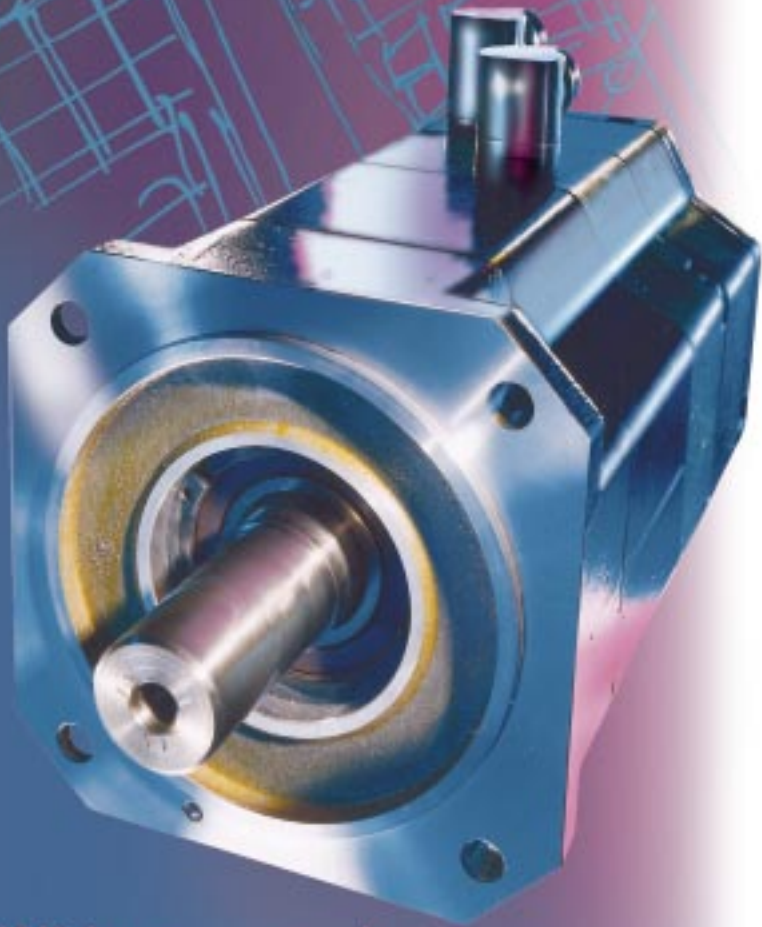

*w. St-Verstärker
konstante Drehmoment
Feldschleife*

Servomotors

Overview

Brief description

SIEMENS servomotors have been specially designed to satisfy the high requirements placed on variable-speed drives.

Versions

- Synchronous servomotors
- Asynchronous servomotors

Principal characteristics

- Compact design
- High power density and overload capability
- High maximum speeds
- Integral encoder system
- High dynamic response due to low rotor moment of inertia
- Excellent concentricity properties
- Rugged, almost maintenance-free design.

Synchronous servomotors

The special synchronous servomotors characteristics include:

- high overload capability,
- high dynamic response and
- high static torque.

1FK6 and 1FK7 servomotors

The 1FK6 servomotors satisfy the requirements in the lower power range from 0.7 HP to 7 HP (0.5 kW to 5.2 kW). Their optimized design means they are the most economical solution for many applications.

The new 1FK7 servomotors are based on the experiences gained with the 1FK6 range, and are especially characterized by:

- an extremely high dynamic response (1FK7 HD, high dynamic),
- compact design (1FK7 CT, compact) and
- expanded range of performances and options.

1FT6 servomotors – high performance

The 1FT6 servomotors can be used for extreme requirements in a power range from 25 HP to 61 HP (0.2 kW to 45 kW).

Synchronous Servomotors

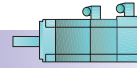

These motors are available with self-cooling in protection classes IP 64 to IP 68, with separate cooling, or with water cooling. The wide range of options means they are the optimum solution for many high-end applications.

1FS6 servomotors – explosion-protected

The 1FS6 servomotors are designed for use in Zone 1 hazardous areas. These motors conform to type of protection EEx de IIC T3.

1PH7, 1PL6, 1PH4 asynchronous servomotors

The compact asynchronous motors supplement the synchronous servomotors for applications in the upper power range (up to 630 kW).

Versions:

- Force-cooled 1PH7 motors in protection class IP 55
- Water-cooled 1PH4 motors in protection class IP 65
- Air-through and force-cooled 1PL6 motors in protection class IP 23.

Asynchronous Servomotors



These motors permit the full rated torque throughout the entire constant flux range.

Depending on the requirements, the motors may be fitted with the appropriate options:

- Encoders (incremental encoder HTL, resolver, sin/cos incremental encoder 1 V_{pp}, absolute-value encoder)
- Holding brakes.

Gearboxes can be mounted on all servomotors as required.

The motors and Siemens Drives are optimally matched to one another to provide powerful drive systems.

Synchronous AC linear motors – 1FN3

The 1FN3 linear motors are especially characterized by

- outstanding dynamic response
- very high traversing velocity
- excellent precision

non-wearing drive components due to contactless drive power transmission.



Servomotors Overview

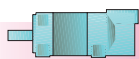

Asynchronous
Servomotors

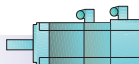

Synchronous
Servomotors

Brief description

1



Optimal integration of drives into the world of automation

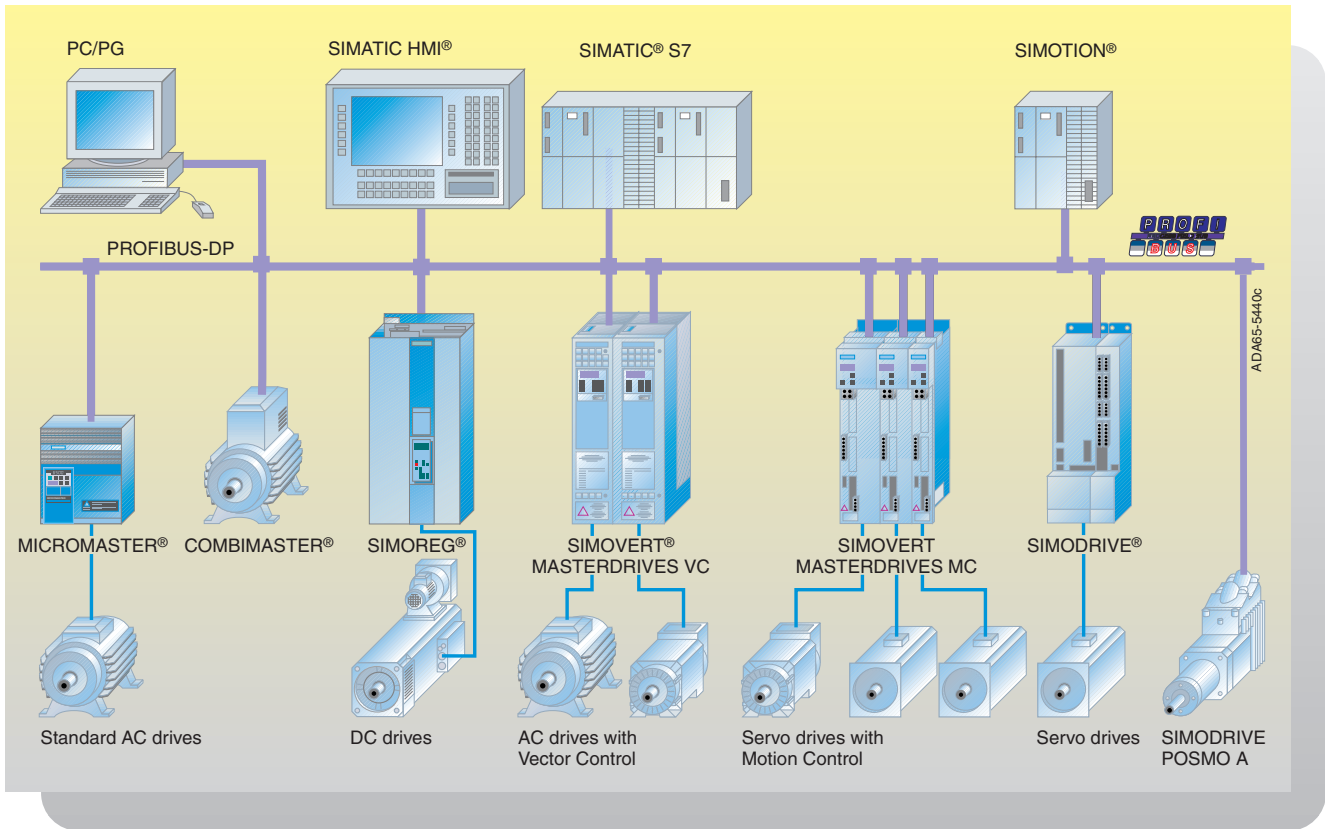

Servomotors

Overview

Flowchart Selecting procedure

Synchronous
Servomotors

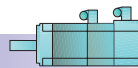

Asynchronous
Servomotors

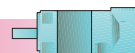

Basic information

In order to select the correct drive and motor, the specific speed and load cycle of the drive application must be known.

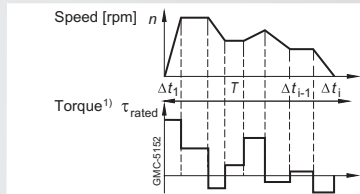

1) For 1FN3 applications torque is replaced by force.

Step 1

Specifying the degree of protection:

IP 23; IP 55; IP 64; IP 65; IP 67; IP 68

For details, see Part 1

Step 2

Specifying the supply voltage:

380 to 400 V; 460 to 480 V

Step 3

Specifying the type of construction:

IM B 3 (foot-mounting); IM B 5 (flange-mounting); IM B 35 (foot/flange-mounting)

For details, see Part 7

Step 4

Specifying the maximum torque from the load-cycle profile:

Step 5

Specifying the average (rms) torque:

Step 6

Specifying the motor type needed (synchronous/asynchronous servomotor):

1FK6; 1FK7; 1FT6; 1FS6; 1PH7; 1PL6; 1PH4; 1FN3

See Overview in Part 1

Step 7

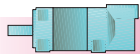

Asynchronous
Servomotors

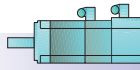

Synchronous
Servomotors

1

Step 7

Selecting the motor from the corresponding data page (Part 2 or 3) which satisfies the following criteria:

Synchronous servomotor:
 $n_{max} \leq 1.1 \times n_n$
 $\tau_{eff} \leq \tau_n$

Asynchronous servomotor:
 n_{max} must not be exceeded
 $\tau_{eff} \leq \tau_n$
 The load points (n, P) must be at least 30% below the stalling limit curve.

Step 8

Specifying the encoder system needed:

Incremental encoder HTL; resolver; sin/cos incremental encoder 1 V_{pp} ;
 absolute-value encoder

For details, see Part 4

Step 9

Complete motor order number with all the necessary options:

1FK6; 1FK7; 1FT6; 1FS6; 1PH7; 1PL6; 1FH4; 1FN3

For details, see Part 2 or 3

Order No. for motor:

1FK6	□□□-□□□□□-□□□□
1FK7	□□□-□□□□□-□□□□
1FT6	□□□-□□□□□-□□□□
1FS6	□□□-□□□□□-□□□□
1PH7	□□□-□□□□□-□□□□
1PL6	□□□-□□□□□-□□□□
1PH4	□□□-□□□□□-Option + plain text
1FN3	□□□-□□□□□-□□□□

Step 10

Specifying the length and cross-section of the prefabricated power cable needed or specifying the plug size for customer fitting:

For details and order number structure, see Part 5

For details, see Part 5

Order number for power cable:

Step 11

Specifying the prefabricated encoder cable needed or specifying the plug size for customer fitting:

Incremental encoder HTL; resolver; sin/cos incremental encoder 1 V_{pp} ; absolute-value encoder

For details, see Part 5

Order number for power cable:

In the case of standard overload¹⁾

Step 12

Selecting the converter/inverter for the selected motor in the selection and ordering data on the basis of the standard overload conditions:

The selection of converters/inverters in this catalog is based on the respective motor stall current or rated motor current.

For 1FK6, 1FT6, 1FS6, see Part 2.
 For 1PH7, 1PL6 and 1PH4, see Part 3.

Order number for drive:

In the case of high overload conditions²⁾

Step 13

If higher overload times and overload components are necessary, see catalogs MC Part 1 (SIMOVERT MASTERDRIVES MC), Part 3 (SIMODRIVE 611 universal and POSMO) or use the software tool SIMOSIZE.

1) 160% for 30 s or 136% for 60 s during 300 s load cycle. 2) In the case of exceeding the standard overload.

Servomotors

Overview

Overview of types and rated data

Synchronous
Servomotors

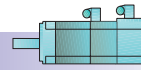

Asynchronous
Servomotors



Motor/Types	Designation/Method of functioning	Degree of protection	Cooling	Size
1FK6	Servomotor Frameless permanent-magnet synchronous motor	IP 64 (IP 65 optional)	Natural cooling	36 to 100
1FK7 CT (Compact)	Compact-servomotor (like 1FK6, but shorter)		Natural cooling	28 to 100
1FK7 HD (High Dynamic)	High Dynamic-servomotor with extremely low rotor moment of inertia		Natural cooling	36 to 80
1FT6	Servomotor-High Performance Permanent-magnet synchronous motor	IP 64 (IP 65, IP 67, IP 68 optional)	Natural cooling Separate cooling Water cooling	28 to 132 80 to 132 63 to 100
1FS6 	Servomotor – explosion-proof Permanent-magnet synchronous motor and EEx de II C T3 explosion protection	IP 64 (IP 65 optional)	Natural cooling	71 to 132
1FN3	Synchronous AC linear motor	IP 65	Water cooling	50 to 900
1PH7	Asynchronous servomotor Frameless three-phase squirrel-cage motor	IP 55	Separate cooling Surface cooling	100 to 280 ¹⁾
1PL6	Asynchronous servomotor Frameless three-phase squirrel-cage motor	IP 23	Separate cooling Axial ventilation	180 to 280 ¹⁾
1PH4	Asynchronous servomotor Liquid-cooled three-phase squirrel-cage motor	IP 65	Water cooling	100 to 160

1) Size 280 available as of third quarter 2002.

Servomotors Overview



Asynchronous
Servomotors

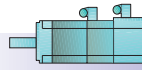



Synchronous
Servomotors

Overview of types and rated data

Power range



Rated torque

Selection and ordering
data on pages

0.7 HP  **7 HP**
0.5 kW  **5.2 kW**

7 to 148 lb_f-in
0.8 to 16.5 Nm

2/3 to 2/4

0.5 HP  **7.2 HP**
0.4 kW  **5.4 kW**

4.4 to 181 lb_f-in
0.5 to 20.5 Nm



2/6

0.8 HP  **4.2 HP**
0.6 kW  **3.1 kW**

8 to 106 lb_f-in
0.9 to 12 Nm

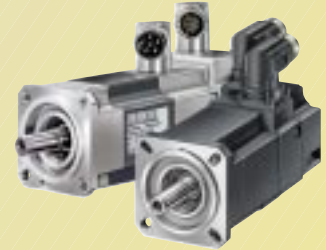

2/7



0.25 HP  **20.7 HP**
0.2 kW  **15.5 kW**



2.7 to 779 lb_f-in
0.3 to 88 Nm

2/9 to 2/14

9.2 HP  **61 HP**
6.9 kW  **45.5 kW**



150 to 1416 lb_f-in
17 to 160 Nm

2/10 to 2/14

4.3 HP  **37 HP**
3.2 kW  **34 kW**

89 to 690 lb_f-in
10 to 116 Nm



2/13

1.6 HP  **16.6 HP**
1.2 kW  **12.4 kW**

16.8 to 602 lb_f-in
1.9 to 68 Nm

2/17





10.6 HP  **281 HP**
7.9 kW  **214 kW**

45 to 1821 lb_f-in
200 to 8100 Nm

2/20



5 HP  **516 HP**
3.7 kW  **385 kW**

16 to 1829 lb_f-ft
22 to 2480 Nm

3/4 to 3/12



27.5 HP  **844 HP**
20.5 kW  **630 kW**

273 to 2655 lb_f-ft
370 to 3600 Nm

3/16 to 3/20



10 HP  **81 HP**
7.5 kW  **65 kW**

35 to 243 lb_f-ft
45 to 333 Nm

3/22



Servomotors

Overview

Technical explanations

Synchronous Servomotors

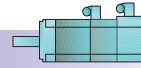

Asynchronous Servomotors



Specifications, standards, regulations

The motors comply with pertinent standards and specifications; please refer to the table.

As a result of the adaptation of national specifications to international recommendation IEC 60 034-1, already implemented in many countries, there are no longer any differences in coolant temperatures, temperature classes and temperature rise limits.

The motors listed below are UL-approved to Underwriters Laboratories Inc.®, including the Canadian specification with the identification URc: 1FK6, 1FK7, 1FT self-cooled, 1PH7²⁾ (without brake) 1PL6²⁾ and 1PH4.

Title	DIN/VDE	EN	IEC
General regulations for electrical rotating machines	DIN VDE 0530 Part 1	EN 60 034-1	IEC 60 034-1
Terminal designations and direction of rotation for electrical machines	DIN VDE 0530 Part 8	EN 60 034-8	IEC 60 034-8
Types of electrical rotating machines	DIN VDE 0530 Part 7	EN 60 034-7	IEC 60 034-7
Cooling methods for electrical rotating machines	DIN VDE 0530 Part 6	EN 60 034-6	IEC 60 034-6
Degrees of protection for electrical rotating machines	DIN VDE 0530 Part 5	EN 60 034-5	IEC 60 034-5
Vibration severity of electrical rotating machines	DIN VDE 0530 Part 14	EN 60 034-14	IEC 60 034-14
Noise limits of electrical rotating machines	DIN VDE 0530 Part 9	EN 60 034-9	IEC 60 034-9
Cylindrical shaft ends for electrical machines	DIN 748 Part 3	–	IEC 60 072

The most common degrees of protection of three-phase motors to IEC 60034-5

Depending on operating and environmental conditions, the choice of a suitable degree of protection is intended to prevent:

- continuous effect of water, dust and foreign matter
- contact with rotating parts within a motor
- contact with live parts.

The degrees of protection of electrical machines are indicated by a code consisting of two letters, two digits and, if applicable, an additional letter.

IP (International Protection) Identification letter for degrees of protection against contact and the ingress of foreign matter and water

0 to 6

First identification digit for degrees of protection against contact and the ingress of foreign matter

0 to 8

Second identification digit for degrees of protection against the ingress of water (no oil protection)

W, S and M

Additional identification letter for special degrees of protection

The motors are supplied mainly in the following degrees of protection:

Motor	Degree of protection	1st digit Contact protection	Foreign matter protection	2nd digit Water protection
Open-circuit cooling	IP 23	Protection against contact with fingers	Protection against medium-size solid foreign bodies of more than 12 mm dia.	Protection against rain water at up to 60 degrees from the vertical
Fan-cooled	IP 54	Full protection against contact	Protection against harmful dust deposits	Splash water from all directions
	IP 55			Water jets from all directions
	IP 64	Full protection against contact	Protection against the ingress of dust	Splash water from all directions
	IP 65¹⁾			Water jets from all directions
	IP 67¹⁾			Motor immersed in water under stated conditions of pressure and time
IP 68¹⁾			Motor is suitable for full immersion in water under conditions to be described by the manufacturer	

1) According to DIN VDE 0530 Part 5 or EN 60 034 Part 5, there are only five degrees of protection for the first digit, and eight degrees of protection for the second digit for electrical rotating machines. However, IP 6 is contained in DIN 40050 which generally applies to electrical apparatus.

2) Approbation for size 280 is pending.

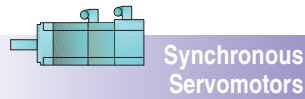

Radial eccentricity tolerance, shaft and flange accuracy (concentricity and axial eccentricity to IEC 60072)

Radial eccentricity tolerance of the shaft with respect to housing axis (referred to the cylindrical shaft ends)

Frame size	Standard N in (mm)	Option R in (mm)
28	0.0014 (0.035)	0.0007 (0.018)
36	0.0014 (0.035)	0.0007 (0.018)
48	0.0016 (0.04)	0.0008 (0.021)
63	0.0016 (0.04)	0.0008 (0.021)
71	0.0016 (0.04)	0.0008 (0.021)
80	0.002 (0.05)	0.001 (0.025)
100	0.002 (0.05)	0.001 (0.025)
132	0.002 (0.05)	0.001 (0.025)

Concentricity and axial eccentricity of the flange surface with respect to the shaft axis (referred to the centering diameter of the mounting flange)

Frame size	Standard N in (mm)	Option R in (mm)
28	0.0032 (0.08)	0.0016 (0.04)
36	0.0032 (0.08)	0.0016 (0.04)
48	0.0032 (0.08)	0.0016 (0.04)
63	0.0039 (0.1)	0.002 (0.05)
71	0.0039 (0.1)	0.002 (0.05)
80	0.0039 (0.1)	0.002 (0.05)
100	0.0039 (0.1)	0.002 (0.05)
132	0.0049 (0.125)	0.0025 (0.063)

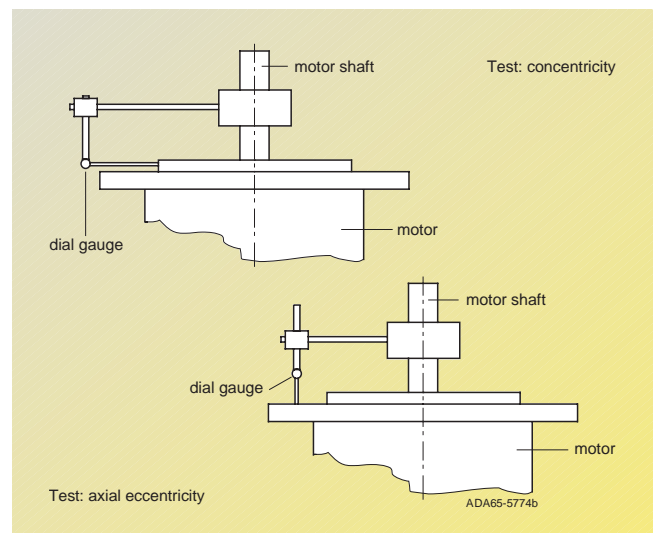
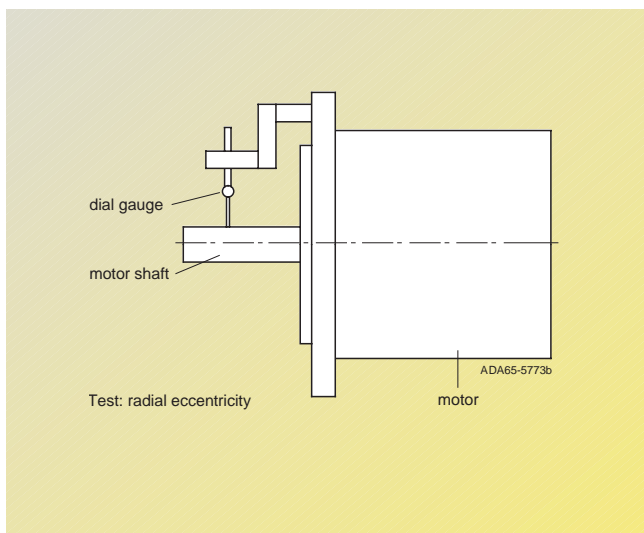

Vibration severity grades to IEC 60034-14

The vibration severity is the rms value of the vibration rate (frequency range from 10 to 1000 Hz). The vibration severity is measured with

electrical measuring instruments to DIN 45 666.

The specified values relate to the motor only. Installation-related system vibrations

can lead to an increase in these values.

Speeds of 1800 rpm and 3600 rpm and the corresponding limit values are

specified according to IEC 60034-14. The speeds of 4500 rpm and 6000 rpm and the specified values have been stipulated by the motor manufacturer.

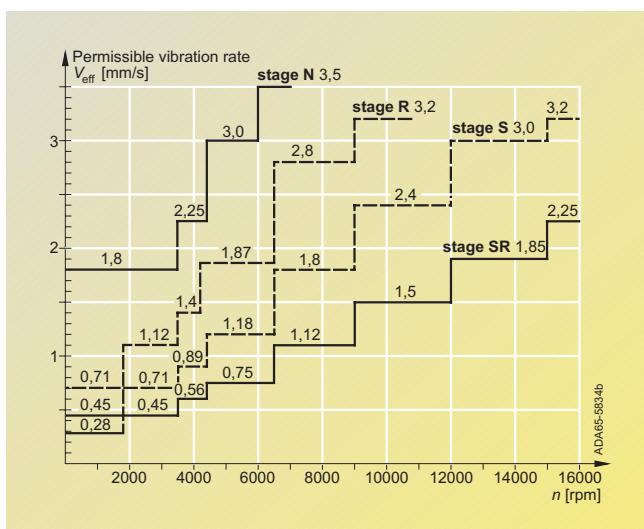

Limits of vibration severity grades for frame sizes 28 to 132.

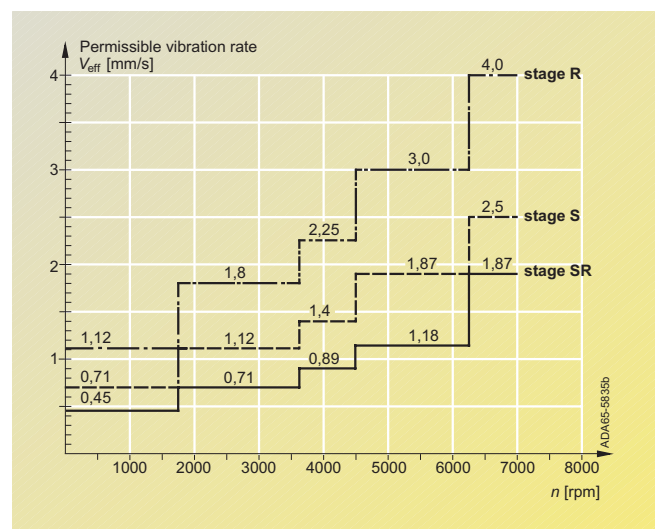

Limits of vibration severity grades for frame sizes 160 to 280.

Servomotors

Overview

Technical explanations

Synchronous Servomotors

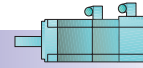

Asynchronous Servomotors



Balancing to DIN ISO 8821

Requirements of the balancing process for fitted parts, particularly belt pulleys

The vibration response of motors fitted with belt pulleys is decisively governed by the balance of the fitted part, in addition to the balance quality of the motor.

If the motor and the part to be fitted are balanced

separately before assembly, the balancing process for the belt pulley must be adapted to the balancing method for the motor. A distinction must be made between the following balancing methods for motors 1PH4, 1PH7 and 1PL6:

- Half-keyed balancing
- Full-keyed balancing
- Smooth shaft end

For 1PH7 and 1PL6 motors, the balancing method is coded in the ordering designation. Motors with half-keyed and full-keyed balancing are identified by the abbreviation "H" (half-key) and "F" (full-key) at the shaft end face.

Motors 1FK6, 1FK7 and 1FT6 with a fitted key are always half-key balanced.

The basic recommendation is for the highest demands for system balance quality. For motors with full-keyed balancing, belt pulleys with two opposite keyways are recommended, but only one key in the shaft end.

Vibration stress, induced vibration values

Permanent-magnet synchronous motors 1FK6, 1FK7, 1FT6 and 1FS6: the following, maximum permissible limits for vibration stress at full reliability performance, apply only to motors without brake or with closed brake.

Vibration acceleration:

- 10 m/s² axial (20 Hz to 2 kHz)
- 30 m/s² radial (20 Hz to 2 kHz)

All induction motors 1PH7, 1PH4 and 1PL6: the following limits apply for all vibration values induced in the motor from the exterior:

Vibration frequency	Vibration values for	Sizes	
		100 to 160	180 to 280
<6.3 Hz	vibration excursion <i>s</i>	≤ 0.16 mm	≤ 0.25 mm
6.3 to 63 Hz	vibration rate <i>V_{rms}</i>	≤ 4.5 mm/s	≤ 7.1 mm/s
>63 Hz	vibration acceleration <i>a</i>	≤ 2.55 m/s ²	≤ 4.0 m/s ²

Coolant temperature and installation altitude

The rated power (rated torque) applies to continuous duty (S1 operation) to DIN EN 60 034-1 at rated frequency, at a coolant temperature of 104 °F (40 °C) and at an installation altitude of up to 3280 ft (1000 m) above sea level.

The motors are all designed to temperature class F and are utilized according to temperature class F. In the event of different conditions, the permissible power (torque) must be determined according to the table.

Coolant temperature and installation altitude are rounded off to 41 °F (5 °C) and 1640 ft (500 m).

Remark concerning the surface temperature: The temperature of the motor surface can reach 212 °F (100 °C) and more.

Non- and blower-ventilated motors

Installation altitude above sea level in ft (m)	Coolant (air) temperature in °F (°C)					
	<86 (<30)	86-104 (30-40)	113 (45)	122 (50)	131 (55)	140 (60)
3280 (1000)	1.07	1.00	0.96	0.92	0.87	0.82
4920 (1500)	1.04	0.97	0.93	0.89	0.84	0.79
6560 (2000)	1.00	0.94	0.90	0.86	0.82	0.77
8200 (2500)	0.96	0.90	0.86	0.83	0.78	0.74
9840 (3000)	0.92	0.86	0.82	0.79	0.75	0.70
11480 (3500)	0.88	0.82	0.79	0.75	0.71	0.67
13120 (4000)	0.82	0.77	0.74	0.71	0.67	0.63

Water-cooled motors

The recommendation for the coolant inlet temperature is 77° F (25 °C). In order to prevent moisture condensation, the cooling-medium inlet temperature can, depending on the ambient temperature, be up to 140 °F (60 °C).

When the cooling-medium temperature is increased the rated output P_n is decreased as follows:

Cooling-medium temperature	Reduction in the rated output
86 °F (30 °C)	1.00
104 °F (40 °C)	0.95
122 °F (50 °C)	0.90
140 °F (60 °C)	0.85



Asynchronous
Servomotors

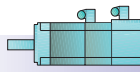

Synchronous
Servomotors

Technical explanations

Duty types S1 and S6 to EN 0530

S1: Continuous operation

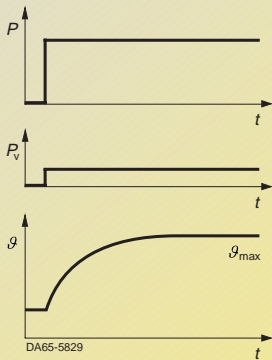

Operation under constant load whose duration is sufficient to reach thermal equilibrium.

Identification: S1

Specification of power (torque)

ϑ Temperature

DA65-5829

S6: Continuous operation with intermittent loading

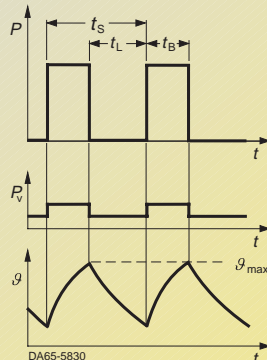

Operation consisting of a sequence of cycles of the same type, each of which consists of a time with constant load and a no-load time. There is no interval.

Identification

e.g.: S6-40%, 114 HP (85 kW)

$$t_r = \frac{t_B}{t_B + t_L}, t_S = 10 \text{ min}$$

DA65-5830

Rating plates

SIEMENS			
3 ~ Motor 1FK7060-5AF71-1EH0			
No. YF PN18 4583 01 001			
M ₀ 6,0 Nm	I ₀ 4,5 A	n _N 3000 /min.	
M _n 4,7 Nm	I _n 3,7 A	n _{max.} 6600 /min.	
Th.Cl.F	U _{in} 253 V	IP 64	
Encoder F02 Brake EBD 0,8B / 24 V -- / 15 W			
Rev. No. 000			
Made in Germany		EN60034	

DA65-6038

Example from series 1FK7 (adhesive plate)

SIEMENS		3 ~ Brushless Servomotor			
Made in Germany		1FT6084-1AF71-3EG1			
No. YF P118 9979 01		001 EN 60034			
M ₀ = 16,6/20,0 Nm	I ₀ = 11,3/14,0 A	60/100K			
M _N = 14,0 Nm	n _N = 3000 /min	U _{IN} = 270 VY			
IMB5	IP 65	Th.CL.F	n _{max} = 4700 /min		
ABSOLUTE-ENCODER F02 2048 S/R KTY 84					

DA65-6041

Example from series 1FT6 (metal plate)

SIEMENS					
3 ~ Mot. 1PH7137 - 2NG00 - 0BA0 Nr.YF L994 0025 01 001					
IM B3	IP 55/54	Th.Cl.F			
V	A	kW	cos φ	Hz	1/min
350 Y	60,00	28,00	0,88	68,0	2000 S1
398 Y	56,00	29,00	0,87	77,8	2300 S1
450 Y	52,00	30,00	0,84	89,4	2650 S1
EN 60034					max. 8000 /min
TEMP - SENSOR KTY 84 - 130 ENCODER D01 2048 S/R					
CODE-NR.: 412					
Made in Germany					

DA65-5837

Example from series 1PH7, shaft height 100 to 160 (adhesive plate)

SIEMENS					
3 ~ Mot. 1PL6228-4HF00-0AA0 No N- 1102033010001 / 2000					
IM B3	IP 23	Th.Cl. F		Gew./WT 870 kg	
V	A	kW	cos φ	Hz	1/min
345 Y	476	230	0.86	51	1500
400 Y	473	265	0.86	59	1750
460 Y	452	288	0.85	67	2000
EN60034-1 IEC 34-1			max 4500 1/min		
KTY84					
ENCODER H01 1024 S/R					
MADE IN GERMANY					

DA65-6033

Example from series 1PL6, shaft height 180 to 280 (metal plate)

Servomotors

Overview

Technical explanations

Synchronous Servomotors



Asynchronous Servomotors



Rated power

The motor power in the technical selection tables is calculated from the torque and speed values.

$$P_n = \frac{\tau_n \cdot n_n}{5250}$$

P_n Rated power in HP
 n_n Rated speed in rpm
 τ_n Rated torque in lb_f-ft

$$P_n = \frac{\tau_n \cdot n_n}{9550}$$

P_n Rated power in kW
 n_n Rated speed in rpm
 τ_n Rated torque in Nm

DURIGNIT® IR2000 insulation

The DURIGNIT IR2000 insulating material system comprises high-grade enameled wire and insulating sheet materials, combined with solvent-free impregnating resin.

It guarantees great mechanical and electrical strength, as well as a high service value and long service life of the motors.

The insulation extensively protects the winding from the effects of corrosive gases, vapors, dust, oil and increased humidity, and withstands the usual vibration stress.

The insulation of the motors is tropic-proof, i.e. it is suitable for humidity up to 100%.

All motors are in temperature class F.

Utilization of the motors corresponds to temperature rise class F at rated power/ rated torque.

Motor protection

Sensing of the motor temperature for converter operation takes place with the KTY 84-130 temperature sensor.

This sensor is a semiconductor whose resistance varies according to temperature, following a defined curve.

The Siemens converters determine the motor temperature by means of the resistance of the temperature sensor.

They can be set to a desired temperature for warning and tripping.

The KTY 84-130 temperature sensor is fitted in the end winding of the motor like a PTC thermistor.

Evaluation takes place as standard in the SIMOVERT MASTERDRIVES converter.

If the motors are operated on converters which do not have KTY 84 evaluation, the tempera-

ture evaluation can be carried out using the external 3RS10 temperature monitoring relay.

Device examples:

- Control supply voltage: 24 V AC/DC
Order No. 3RS1040-1GD50
- Control supply voltage: 24 - 240 V AC/DC
Order No. 3RS1040-1GW50

In addition to the KTY 84 the 1FN3 motor includes three PTC elements connected in series which are located in each of the three-phase windings (U, V, W) of the primary section. Each PTC element has a quasi characteristic. The rated response temperature is 248 °F (120 °C) ± 41 °F (± 5 °C), which corresponds approximately to 1500 Ω.

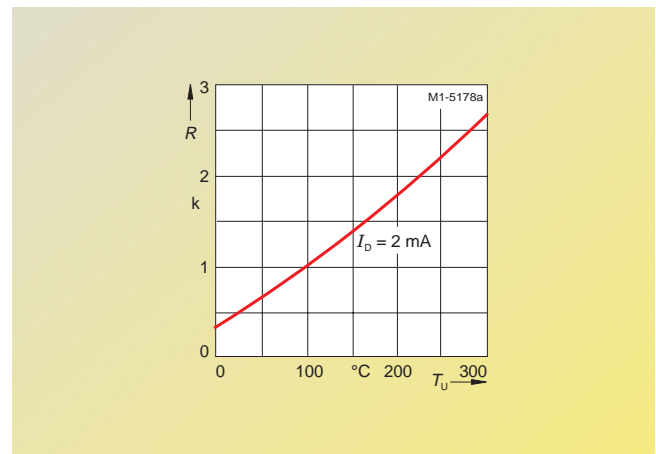

Coating

The following motor coatings are possible:

- No paint finish (with impregnating resin coating) e.g. 1FK6
- Primer (as corrosion protection) e.g. 1PH7, 1PL6
- Normal paint finish (e.g. RAL 7016) e.g. 1FK7, 1PH4, 1PH7, 1PL6, 1FS6

Paint finish	Suitability of coating for climate group to DIN IEC 60721, Part 2-1	Short-time:	Continuous:
Normal paint finish	Moderate (extended) for indoor and outdoor installation	up to 248 °F (120 °C)	up to 212 °F (100 °C)
Special paint finish	Worldwide for outdoor installation	up to 284 °F (140 °C)	up to 248 °F (120 °C)
		Additional:	For corrosive atmosphere up to 1% acid and caustic solution concentration or in protected rooms in continuous moisture

- Special paint finish (e.g. RAL 7016) e.g. 1FT6, 1PH7, 1PL6.

All motors with exception of the 1FN3 can be painted using commercially available paints (max. 2 additional paint finishes).

Synchronous Servomotors Linear Motors

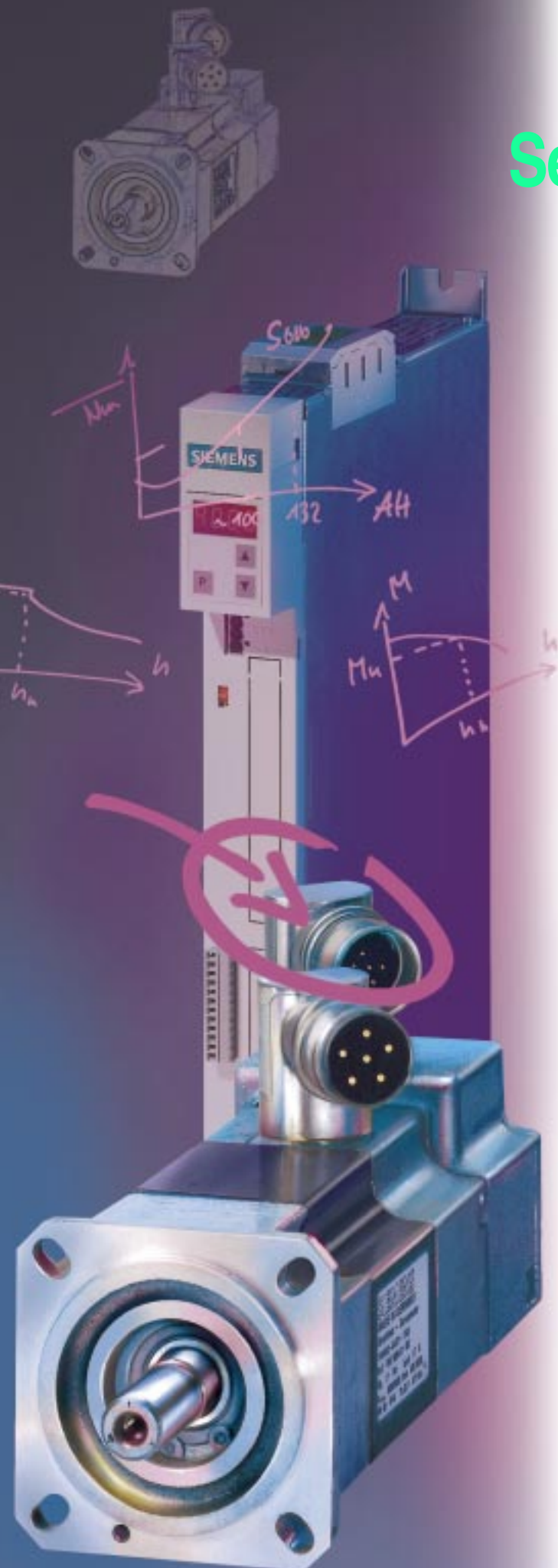

1FK6 servomotors

- 2/2 Technical data
- 2/3 Selection and ordering example with SIMOVERT MASTERDRIVES compact units
- 2/3 Order No. suffix
- 2/4 1FK6 stock motors

1FK7 servomotors

- 2/5 Technical data
- 2/6 1FK7 Compact · Selection and ordering example with SIMOVERT MASTERDRIVES compact units
- 2/7 1FK7 High Dynamic servomotors · Selection and ordering example with SIMOVERT MASTERDRIVES compact units

1FT6 servomotors

- 2/8 Technical data
- 2/9 Selection and ordering example of 1FT6 Fast Mover (core-type) with SIMOVERT MASTERDRIVES compact units
- 2/10 Selection and ordering example of 1FT6 air-cooled with SIMOVERT MASTERDRIVES compact units
- 2/13 Selection and ordering example of 1FT6 water-cooled with SIMOVERT MASTERDRIVES converters
- 2/14 1FT6 stock motors
- 2/15 Order No. suffix

1FS6 servomotors

- 2/16 Technical data
- 2/17 Selection and ordering example with SIMOVERT MASTERDRIVES compact units

1FN3 AC linear motors

- 2/18 Technical data
- 2/20 Selection and ordering data for 1FN3 primary and secondary section

Synchronous Servomotors

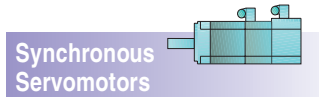

1FK6 servomotors

Technical data



Fig. 2/1
1FK6 servomotor

Technical characteristics

The 1FK6 three-phase servomotors are frameless permanent-magnet synchronous motors. The magnets are made of rare-earth materials.

The 1FK6 standard is an industry-proven servomotor for many applications.

The 1FK6 servomotors cannot be operated with SIMOVERT MASTERDRIVES Vector Control.

They are especially characterized by the following properties:

- high power density with low physical volume
- winding insulation for temperature class F
- high short-time overload capability (250 ms)
 $\tau_{max} \approx 3 \cdot \tau_0$ (100 K) for size 36
- very good efficiency
- torque ripple 3% (mean value)
- high degree of protection
- low maintenance requirements
- high concentricity and vibration quality
- high lateral-force withstand capability
- high mechanical stiffness
- low weight
- monitoring of motor temperature by KTY 84
- integrated encoder system for detecting motor speed and rotor position
- standard connector for encoder and power connections.

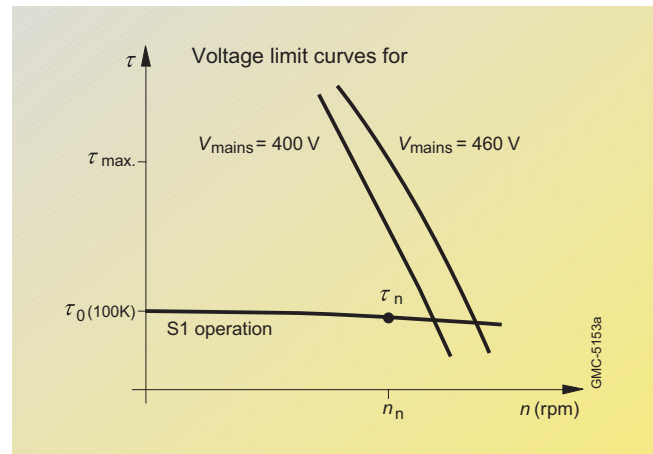

Fig. 2/2
Torque-speed characteristic

Application

Packing machines, storage and retrieval units for high-bay warehouses, handling systems, wood processing, manipulators etc.

Stock motors³⁾

To meet our customer's logistical expectations, the 1FK6 motor is stocked in its most demanded configuration.

The technical features of these stock motors are:

- naturally cooled motors with power connectors.
- rotatable connector socket (270°)
- integrated resolver
- vibration severity class N
- degree of protection IP 64
- type of construction IM B5 (flange mounting).

For a complete listing of stock motor refer to table "Stock motors" on page 2/4.

	Standard	Options
Type of construction	IM B 5 (IM V 1, IM V 3)	–
Degree of protection	IP 64	IP 65 with radial shaft seal for oil-tight flange
Vibration severity	N	–
Shaft and flange accuracy	N	–
Shaft extension	Smooth shaft extension	Featherkey with semi-wedge balancing
Power connection	Connector socket (rotatable approx. 270° by customer)	–
Motor protection	PTC thermistor KTY 84 in the stator winding	–
Encoder system (plug connector, rotatable approx. 270° by customer)	2-pole resolver	sin/cos incremental encoder 1 V _{pp} Absolute-value encoder (EnDat) 2048 p/r (from size 48 on) ²⁾ Basic absolute-value encoder (EnDat) 32 p/r (from size 48 on) ²⁾ Multi-pole resolver
Paint finish	Without paint coating	–
Bearings	Permanently lubricated deep-groove ball bearing (locating bearing on ND-end)	–
Cooling	Natural cooling	–
Brake	–	Holding brake integrated in motor
Gearbox mounting ¹⁾	–	The following gears can be fitted: • Alpha planetary gear, LP series

1) To find out which gears can be used with which motors, see Chapter 4 "Built-on Accessories" (page 4/8).

2) If an absolute-value encoder is used, the rated torque must be reduced by 10%.

3) Stock quantities are subject to prior sale.

Synchronous Servomotors

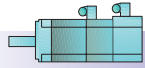

Synchronous Servomotors

1FK6 servomotors

1FK6 standard servomotors - Selection and ordering example with SIMOVERT MASTERDRIVES Motion Control¹⁾

Motor data for a 100 K temperature increase										Converter data		
Rated speed	Size	Motor	Rated torque	Rated current	Stall torque	Stall current	Rated power	Moment of inertia without brake	Weight without brake	Plug size for power cable	Rated current	Inverter**
n_n			τ_n	I_n	τ_0	I_0	P_n	J	lb		I_{nU}	
rpm	Order No.		lb _r -in (Nm)	A	lb _r -in (Nm)	A	HP (kW)	lb _r -in-s ² ($\times 10^{-3}$ kgm ²)	(kg)		A	Order No.*

Mains voltage 3 AC 400 to 480 V with SIMOVERT MASTERDRIVES Motion Control selection example¹⁾

3000	48	1FK6042-6AF71-1... ²⁾	23 (2.6)	2.4	26.6 (3)	2.6	1.1 (0.82)	0.0029 (0.33)	11 (5)	1	4	6SE7014-0TP50
	63	1FK6060-6AF71-1...	35 (4)	3.1	53 (6)	4.3	1.69 (1.26)	0.0076 (0.86)	19.8 (9)	1	6.1	6SE7016-0TP50
	63	1FK6063-6AF71-1... ²⁾	53 (6)	4.7	97 (11)	7.9	2.52 (1.88)	0.0142 (1.61)	29.1 (13.2)	1	10.2	6SE7021-0TP50
	80	1FK6080-6AF71-1... ²⁾	60 (6.8)	5.2	71 (8)	5.8	2.87 (2.14)	0.0133 (1.5)	27.6 (12.5)	1	6.1	6SE7016-0TP50
	80	1FK6083-6AF71-1... ²⁾	93 (10.5)	7.7	142 (16)	10.4	4.42 (3.3)	0.0242 (2.73)	37.5 (17)	1	13.2	6SE7021-3TP50
	100	1FK6100-8AF71-1...	106 (12)	8.4	159 (18)	12.2	5.05 (3.77)	0.0489 (5.53)	46.3 (21)	1	13.2	6SE7021-3TP50
	100	1FK6101-8AF71-1... ²⁾	137 (15.5)	10.8	239 (27)	17.5	6.53 (4.87)	0.0707 (7.99)	57.3 (26)	1.5	17.5	6SE7021-8TP50
	100	1FK6103-8AF71-1...	146 (16.5)	11.8	319 (36)	23.5	6.94 (5.18)	0.0929 (10.5)	66.1 (30)	1.5	25.5	6SE7022-6TP50
6000	36	1FK6032-6AK71-1...	7 (0.8)	1.5	10 (1.1)	1.7	0.67 (0.5)	0.0006 (0.07)	6.4 (2.9)	1	2	6SE7012-0TP50
	48	1FK6040-6AK71-1... ²⁾	7 (0.8)	1.75	14 (1.6)	2.8	0.67 (0.5)	0.0016 (0.18)	8.2 (3.7)	1	4	6SE7014-0TP50

Order No. suffix

1 2 3 4 5 6 7 8 9 10 11 12 13 14 15 16
1FK6...-.A.71-1□□□

Encoder			
sin/cos incremental encoder 1 V _{pp}			A
Absolute-value encoder (EnDat) (2048 p/r from size 48 on) ³⁾			E
Basic absolute-value encoder (EnDat) (32 p/r from size 48 on) ³⁾			G
Resolver, multi-pole (resolver pole number equivalent to motor pole number ⁴⁾)			S
Resolver, 2-pole			T
Shaft extension			
Smooth	Radial eccentricity tolerance	Holding brake	
Smooth	N	without	G
Smooth	N	with	H
With featherkey	N	without	A
With featherkey	N	with	B
Vibration severity			
N		Degree of protection	
N		IP 64	0
N		IP 65 with radial shaft seal for oil-tight flange ⁵⁾	2

1) For selection of SIMODRIVE 611 universal and SIMODRIVE POSMO units use stall current I_0 and refer to MC Catalog Part 3.

2) Typically stocked, see page 2/4 for available configurations.

3) If an absolute-value encoder is used, the rated torque must be reduced by 10%.

4) 8th position of 1FK6 motor number indicates number of motor poles.

5) For oil-tight flange or gearbox mounting.

* Listed Compact/Chassis units were selected for standard overload conditions (160% for 30 s at 300 s load cycle).

** For rated current below 37.5 A Compact Plus units can also be used.

Synchronous Servomotors

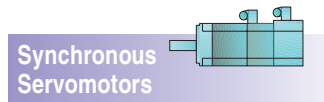

1FK6 servomotors

1FK6 stock motors ¹⁾

Rated speed n_n rpm	Size	Motor	
		Order No. Smooth shaft end	Shaft end with key
3000	48	1FK6042-6AF71-1TG0	
	63	1FK6063-6AF71-1TG0	1FK6063-6AF71-1TA0
	80	1FK6080-6AF71-1TG0	1FK6080-6AF71-1TA0
	80	1FK6083-6AF71-1TG0	1FK6083-6AF71-1TA0
	100	1FK6101-8AF71-1TG0	1FK6101-8AF71-1TA0
6000	48	1FK6040-6AK71-1TG0	

2

1) Stock quantities are subject to prior sale.

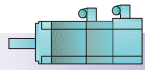

Technical data



Fig. 2/3
1FK7 servomotor

Technical characteristics

The 1FK7 three-phase servomotors are frameless servomotors in a permanent state of electromagnetic excitation, just like the 1FK6 servomotors.

The new 1FK7 servomotors are based on the experiences gained with the 1FK6 series, and are available in high dynamic response or compact versions.

The 1FK7 servomotors cannot be operated with SIMOVERT MASTERDRIVES Vector Control.

1FK7 CT (compact) servomotors

Properties:

- compact design (up to 25% smaller than 1FK6)
- improved torque ripple compared with 1FK6
- mechanically compatible with 1FK6 (shaft, flange and connector)
- wide range of performances and options.

1FK7 HD (high dynamic) servomotors

Properties:

- extremely high dynamic response resulting from new rotor design (very low rotor moments of inertia)
- mechanically compatible with 1FK6 (shaft, flange and connector)
- high short-term overload capability (250 ms)
 $M_{max} = 3 \cdot M_0$ (100 K)

Area of application

Machines for all industrial sectors.

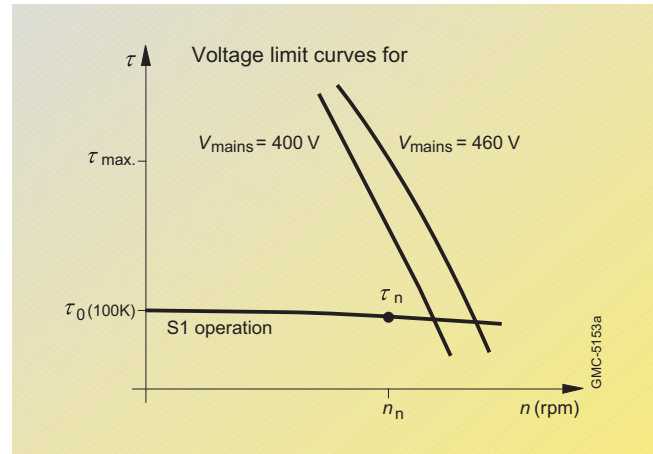

Fig. 2/4
Torque-speed characteristic

	Standard	Options
Type of construction	IM B 5 (IM V 1, IM V 3)	–
Degree of protection	IP 64	IP 65 with radial shaft seal for oil-tight flange
Vibration severity	N	–
Shaft and flange accuracy	N	–
Shaft extension	Smooth shaft extension	Featherkey with semi-wedge balancing
Power connection	Connector socket (rotatable approx. 270° by customer)	–
Motor protection	PTC thermistor KTY 84 in the stator winding	–
Encoder system (plug connector, rotatable approx. 270° by customer)	2-pole resolver	sin/cos incremental encoder 1 V _{pp} Absolute-value encoder (EnDat) 2048 p/r (from size 48 on) ²⁾ Absolute-value encoder (EnDat) 512 p/r (only sizes 28 and 36) ²⁾ Basic absolute-value encoder (EnDat) 32 p/r (from size 48 on) ²⁾ Multi-pole resolver
Paint finish	Normal paint finish anthracite RAL 7016	–
Bearings	Permanently lubricated deep-groove ball bearing (locating bearing on ND-end)	–
Cooling	Natural cooling	–
Brake	–	Holding brake integrated in motor
Gearbox mounting ¹⁾	–	The following gears can be fitted: • Alpha planetary gears, LP series Other gears on request

1) To find out which gears can be used with which motors, see Chapter 4 "Built-on Accessories" (page 4/8).

2) If an absolute-value encoder is used, the rated torque must be reduced by 10%.

Synchronous Servomotors

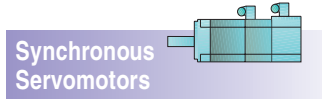

1FK7 Compact servomotors

1FK7 CT (compact) servomotors - Selection and ordering example with SIMOVERT MASTERDRIVES Motion Control¹⁾

Motor data for a 100 K temperature increase									Converter data			
Rated speed	Size	Motor	Rated torque	Rated current	Stall torque	Stall current	Rated power	Moment of inertia without brake	Weight without brake	Plug size for power cable	Rated current	Inverter**
n_n			τ_n	I_n	τ_0	I_0	P_n	J	lb		I_{nU}	Order No.*
rpm	Order No.		lb _r -in (Nm)	A	lb _r -in (Nm)	A	HP (kW)	lb _r -in-s ² (×10 ⁻³ kgm ²)	(kg)		A	

Mains voltage 3 AC 400 to 480 V with SIMOVERT MASTERDRIVES Motion Control selection example¹⁾

3000	48	1FK7042-5AF71-1...	23 (2.6)	1.95	26.5 (3)	2.2	1.1 (0.82)	0.0027 (0.301)	10.6 (4.8)	1	4	6SE7014-0TP50
	63	1FK7060-5AF71-1...	41.6 (4.7)	3.7	53 (6)	4.5	2 (1.48)	0.007 (0.795)	17.6 (8)	1	6.1	6SE7016-0TP50
	63	1FK7063-5AF71-1...	64.6 (7.3)	5.6	97 (11)	8	3.1 (2.29)	0.0134 (1.51)	26.5 (12)	1	10.2	6SE7021-0TP50
	80	1FK7080-5AF71-1...	60.2 (6.8)	4.4	71 (8)	4.8	2.9 (2.14)	0.0132 (1.5)	24.9 (11.3)	1	6.1	6SE7016-0TP50
	80	1FK7083-5AF71-1...	93 (10.5)	7.4	142 (16)	10.4	4.4 (3.3)	0.0242 (2.73)	35.3 (16)	1	13.2	6SE7021-3TP50
	100	1FK7100-5AF71-1...	106 (12)	8	159 (18)	11.2	5.1 (3.77)	0.0489 (5.53)	41.7 (18.9)	1	13.2	6SE7021-3TP50
	100	1FK7101-5AF71-1...	137 (15.5)	11.8	239 (27)	19	6.5 (4.87)	0.0707 (7.99)	55.1 (25)	1.5	25.5	6SE7022-6TP50
100	1FK7103-5AF71-1...	181 ³⁾ (20.5)	16.5 ³⁾	319 (36)	27.5	7.2 ³⁾ (5.37)	0.0929 (10.5)	68.4 (31)	1.5	34	6SE7023-4TP50	
4500	63	1FK7060-5AH71-1...	32.8 (3.7)	4.1	53 (6)	6.2	2.3 (1.74)	0.0007 (0.795)	17.6 (8)	1	6.1	6SE7016-0TP50
	63	1FK7063-5AH71-1...	44.2 ⁴⁾ (5)	6.1 ⁴⁾	97 (11)	12	2.8 ⁴⁾ (2.09)	0.0134 (1.51)	26.5 (12)	1	13.2	6SE7021-3TP50
	80	1FK7080-5AH71-1...	50.4 (5.7)	5.6	71 (8)	7.4	3.2 (2.38)	0.0132 (1.5)	24.9 (11.3)	1	10.2	6SE7021-0TP50
	80	1FK7083-5AH71-1...	73.5 ⁵⁾ (8.3)	9 ⁵⁾	142 (16)	15	4.1 ⁵⁾ (3.04)	0.0242 (2.73)	35.3 (16)	1	17.5	6SE7021-8TP50
6000	28	1FK7022-5AK71-1... ²⁾	5.6 (0.63)	1.26	7.5 (0.85)	1.69	0.54 (0.4)	0.0003 (0.028)		1	2	6SE7012-0TP50
	36	1FK7032-5AK71-1... ²⁾	6.6 (0.75)	1.2	9.7 (1.1)	1.6	0.63 (0.47)	0.0005 (0.061)		1	2	6SE7012-0TP50
	48	1FK7040-5AK71-1...	9.7 (1.1)	1.7	14.2 (1.6)	2.25	0.92 (0.69)	0.0015 (0.169)	7.5 (3.4)	1	4	6SE7014-0TP50
	48	1FK7042-5AK71-1...	17.7 ⁶⁾ (2)	3.1 ⁶⁾	26.6 (3)	4.4	1.37 ⁶⁾ (1.02)	0.0027 (0.301)	10.6 (4.8)	1	6.1	6SE7016-0TP50

Order No. suffix

1 2 3 4 5 6 7 8 9 10 11 12 13 14 15 16
1FK7...-5A.71-1 □ □ □ □

Encoder

sin/cos incremental encoder 1 V _{pp}	A
Absolute-value encoder (EnDat) (512 p/r only sizes 28 and 36, 2048 p/r from size 48 on) ⁷⁾	E
Basic absolute-value encoder (EnDat) (32 p/r from size 48 on) ⁷⁾	G
Resolver, multi-pole (resolver pole number equivalent to motor pole number)	S
Resolver, 2-pole	T

Shaft extension	Radial eccentricity tolerance	Holding brake	
Smooth	N	without	G
Smooth	N	with	H
With featherkey	N	without	A
With featherkey	N	with	B

Vibration severity	Degree of protection/paint finish	
N	IP 64/without paint finish	0
N	IP 65 with radial shaft seal ⁸⁾ /without paint finish	2
N	IP 64/RAL 7016	3
N	IP 65 with radial shaft seal ⁸⁾ /RAL 7016	5

1) For selection of SIMODRIVE 611 universal and SIMODRIVE POSMO units use stall current I_0 and refer to MC Catalog Part 3.

2) Available soon.

3) Rated data refer to $n = 2,500$ rpm.

4) Rated data refer to $n = 4,000$ rpm.

5) Rated data refer to $n = 3,500$ rpm.

6) Rated data refer to $n = 5,000$ rpm.

7) If an absolute-value encoder is used, the rated torque of the motor must be reduced by 10%.

8) For oil-tight flange or gearbox mounting.

* Listed Compact/Chassis units were selected for standard overload conditions (160% for 30 s at 300 s load cycle).

** For rated current below 37.5 A Compact Plus units can also be used.

Synchronous Servomotors

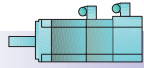

Synchronous Servomotors

1FK7 High Dynamic servomotors

1FK7 HD (High Dynamic) servomotors - Selection and ordering example with SIMOVERT MASTERDRIVES Motion Control¹⁾

Motor data for 100 K temperature increase										Converter data		
Rated speed	Size	Motor	Rated torque	Rated current	Stall torque	Stall current	Rated power	Moment of inertia without brake	Weight without brake	Plug size for power cable	Rated current	Inverter**
n_n rpm		Order No.	τ_n lb _r -in (Nm)	I_n A	τ_0 lb _r -in (Nm)	I_0 A	P_n HP (kW)	J lb _r -in-s ² ($\times 10^{-3}$ kgm ²)	lb (kg)		I_{nU} A	Order No.*

Mains voltage 3 AC 400 to 480 V with SIMOVERT MASTERDRIVES Motion Control selection example

3000	48	1FK7044-7AF71-1...	31 (3.5)	4	35.4 (4)	4.5	1.47 (1.1)	0.00113 (0.128)	16.5 (7.5)	1	6.1	6SE7016-0TP50
	63	1FK7061-7AF71-1...	47.8 (5.4)	5.3	56.6 (6.4)	6.1	2.27 (1.7)	0.00301 (0.34)	22.3 (10.1)	1	6.1	6SE7016-0TP50
	63	1FK7064-7AF71-1...	70.8 (8)	7.5	106.2 (12)	11	3.36 (2.51)	0.00575 (0.65)	33.7 (15.3)	1	13.2	6SE7021-3TP50
	80	1FK7082-7AF71-1...	70.8 (8)	6.7	124 (14)	10.6	3.36 (2.51)	0.0124 (1.4)	38 (17.2)	1	13.2	6SE7021-3TP50
	80	1FK7085-7AF71-1...	106 ²⁾ (12)	12.5 ²⁾	194.7 (22)	22.5	4.21 ²⁾ (3.14)	0.0204 (2.3)	51.8 (23.5)	1.5	25.5	6SE7022-6TP50
4500	48	1FK7043-7AH71-1...	23 (2.6)	4	27.4 (3.1)	4.5	1.64 (1.23)	0.00089 (0.101)	14.8 (6.7)	1	6.1	6SE7016-0TP50
	48	1FK7044-7AH71-1..	26.6 (3)	4.9	35.4 (4)	6.3	1.89 (1.41)	0.00113 (0.128)	17.6 (8)	1	10.2	6SE7021-0TP50
	63	1FK7061-7AH71-1...	38.1 (4.3)	5.9	56.6 (6.4)	8	2.72 (2.03)	0.00301 (0.34)	22.3 (10.1)	1	10.2	6SE7021-0TP50
	63	1FK7064-7AH71-1...	44.3 (5)	7	106.2 (12)	15	3.16 (2.36)	0.00575 (0.65)	33.7 (15.3)	1	17.5	6SE7021-8TP50
6000	36	1FK7033-7AK71-1...	8 (0.9)	1.5	11.5 (1.3)	2.2	0.76 (0.57)	0.00024 (0.027)	7.1 (3.2)	1	4	6SE7014-0TP50
	48	1FK7043-7AK71-1...	17.7 (2)	4.4	27.4 (3.1)	6.4	1.68 (1.26)	0.00089 (0.101)	14.8 (6.7)	1	10.2	6SE7021-0TP50

Order No. suffix

1 2 3 4 5 6 7 8 9 10 11 12 13 14 15 16
1FK7...-7A.7 1-1 □□□□

Encoder												
sin/cos incremental encoder 1 V _{pp}												A
Absolute-value encoder (EnDat) (512 p/r only size 36, 2048 p/r from size 48 on) ³⁾												E
Basic absolute-value encoder (EnDat) (32 p/r from size 48 on) ³⁾												G
Resolver, multi-pole (resolver pole number equivalent to motor pole number)												S
Resolver, 2-pole												T
Shaft extension	Radial eccentricity tolerance	Holding brake										
Smooth	N	without										G
Smooth	N	with										H
With featherkey	N	without										A
With featherkey	N	with										B
Vibration severity		Degree of protection/paint finish										
N		IP 64/without paint finish										0
N		IP 65 with radial shaft seal ⁴⁾ /without paint finish										2
N		IP 64/RAL 7016										3
N		IP 65 with radial shaft seal ⁴⁾ /RAL 7016										5

1) For selection of SIMODRIVE 611 universal and SIMODRIVE POSMO units use stall current I_0 and refer to MC Catalog Part 3.

2) Rated data refer to $n = 2,500$ rpm.

3) If an absolute-value encoder is used motor needs to be derated by 10%.

4) For oil-tight flange or gearbox mounting.

* Listed Compact/Chassis units were selected for standard overload conditions (160% for 30 s at 300 s load cycle).

** For rated current below 37.5 A Compact Plus units can also be used.

Synchronous Servomotors

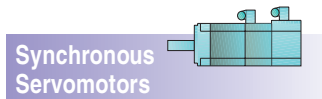

1FT6 servomotors

Technical data



Fig. 2/5
1FT6 three-phase servomotor

Technical characteristics

The 1FT6 three-phase servomotors are permanent-magnet synchronous motors. The magnets are made of rare-earth materials

The 1FT6 servomotors cannot be operated with SIMOVERT MASTERDRIVES Vector Control.

They are especially characterized by

- high power-density with low physical volume
- winding insulation for temperature class F
- high thermal reserves for continuous load and overload
- high overload capability (250 ms):
 $\tau_{max} \approx 4 \cdot \tau_0$ (100 K)
 for sizes 28, 36, 48 and 63
 $\tau_{max} \approx 3.3 \cdot \tau_0$ (100 K)
 for sizes 80 and 100
 $\tau_{max} \approx 2.5 \cdot \tau_0$ (100 K)
 for size 200 for naturally cooled motors
- low losses with very good efficiency
- high acceleration factors (τ_{acc}/I_{mot}) and therefore very good dynamic response of the drive
- low torque ripple (1%)
- plug for encoder and power connection as standard. Terminal box for power cable available for motors of 1FT6 range, size 100 or above
- high degree of protection
- low maintenance
- high concentricity and vibration quality
- high lateral-force withstand capability
- high mechanical stiffness
- low weight
- monitoring of motor temperature by KTY 84

- integrated encoder system for detecting rotational speed of motor and position of rotor
- plug for signal and power connection as standard. Terminal box for power cable available for motors of 1FT6 range, size 100 or above.

Technical and commercial features of the main 1FT6 types

- high-resolution optical sensor system (encoder or absolute-value encoder)
- vibration severity grade N
- degree of protection IP 65
- holding brake option
- motors with short delivery (delivery time: 20 working days)
- more favorable price than comparable motor

Area of application

Machines for all industrial sectors with high dynamic response, precision and flexibility demands, e.g. packaging machines, storage and retrieval systems for high-bay ware houses, conveyor and robotic systems, printing machines (sheet and rotary presses) as well as for machine tool applications.

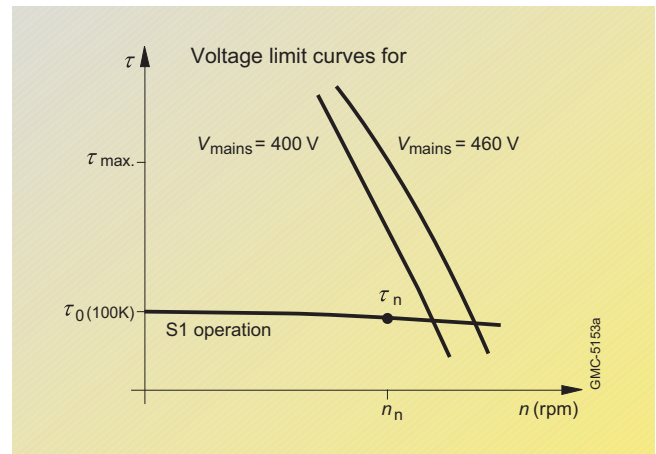

Fig. 2/6
Torque-speed characteristic

Stock motors²⁾

To meet our customer's logistical expectations, the 1FT6 motor is typically stocked in its most demanded configuration.

The technical features of these stock motors are:

- naturally cooled motors with power connectors
- plug connection direction axial (plug from ND-end)
- integrated high resolution optical sin/cos encoder

- vibration severity class N
- degree of protection IP 65
- type of construction IM B 5 (flange mounting).

For a complete listing of stock motor refer to table "Stock motors" on page 2/14.

Minor modifications on the stock motors are possible for an additional charge. A listing of the possible changes is given on page 2/14. Allow an average of 5 working days to complete the modifications.

	Standard	Options
Type of construction	IM B 5 (IM V 1, IM V 3)	IM B 14 (sizes 63 to 100)
Degree of protection	IP 64	IP 65, IP 67 (IP 54 in the case of separate cooling)
Vibration severity	N	R
Shaft and flange accuracy	N	R
Shaft extension	Smooth shaft extension	Featherkey with semi-wedge balancing, 1FT5-compatible shaft extension on request
Power connection	Connector	Terminal box (only for sizes 63 to 132)
Motor protection	KTY 84 in the stator winding	–
Encoder system (plug connector)	2-pole resolver	sin/cos incremental encoder 1 V_{pp} Absolute-value encoder (EnDat) 2048 p/r (from size 36 on) ³⁾ Absolute-value encoder (EnDat) 512 p/r (only size 28) ³⁾ Multi-pole resolver
Paint finish	Anthracite RAL 7016	K23 (worldwide)
Bearings	Permanently lubricated deep-groove ball bearing	–
Cooling	Natural cooling	Separate cooling (only for sizes 80 to 132) Water cooling (only for sizes 63 to 100)
Brake	–	Holding brake integrated in motor
Gearbox mounting ¹⁾	–	The following gears can be fitted: • Alpha low-play planetary gear, SPG series

1) To find out which gears can be used with which motors, see Chapter 4 "Built-on Accessories".

2) Stock quantities are subject to prior sale.

3) If an absolute-value encoder is used, the rated torque must be reduced by 10%.

Synchronous Servomotors

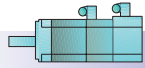

Synchronous Servomotors

1FT6 servomotors core types

1FT6 Fast Mover (core-type) motors · Selection and ordering example with SIMOVERT MASTERDRIVES Motion Control¹⁾

Motor data for 100 K temperature increase										Converter data		
Rated speed	Size	Motor	Rated torque	Rated current	Stall torque	Stall current	Rated power	Moment of inertia without brake	Weight without brake	Plug size for power cable	Rated current	Inverter**
n_n		Order No.	τ_n lb _r -in (Nm)	I_n A	τ_0 lb _r -in (Nm)	I_0 A	P_n HP (kW)	J lb _r -in-s ² ($\times 10^{-3}$ kgm ²)	lb (kg)		I_{nU} A	Order No.*
rpm												

Mains voltage 3 AC 400 to 480 V with SIMOVERT MASTERDRIVES Motion Control selection example

2000	100	1FT6102-1AC71- 1	204 (23)	11	239 (27)	12.4	6.43 (4.8)	0.09 (9.9)	23.2 (27.5)	1.5	13.2	6SE7021-3TP50
	100	1FT6105-1AC71- 1	336 (38)	17.6	443 (50)	22.9	10.72 (8)	0.15 (16.8)	87.1 (39.5)	1.5	25.5	6SE7022-6TP50
3000	48	1FT6044-1AF71- 1	38.1 (4.3)	2.9	44.3 (5)	3	1.87 (1.4)	0.005 (0.51)	18.3 (8.3)	1	4	6SE7014-0TP50
	63	1FT6062-1AF71- 1	41.6 (4.7)	3.4	53.1 (6)	4	2 (1.5)	0.008 (0.85)	21 (9.5)	1	4	6SE7014-0TP50
	63	1FT6064-1AF71- 1	62 (7)	4.9	84.1 (9.5)	6.1	2.95 (2.2)	0.01 (1.3)	27.6 (12.5)	1	6.1	6SE7016-0TP50
	80	1FT6084-1AF71- 1	130 (14.7)	11	177 (20)	14	6.17 (4.6)	0.04 (4.8)	45.2 (20.5)	1.5	10.2	6SE7021-0TP50
	80	1FT6086-1AF71- 1	164 (18.5)	13	239 (27)	17.5	7.77 (5.8)	0.06 (6.6)	56 (25.5)	1.5	17.5	6SE7021-8TP50
4500	63	1FT6062-1AH71- 1	31.9 (3.6)	3.9	53.1 (6)	5.6	2.28 (1.7)	0.008 (0.85)	21 (9.5)	1	6.1	6SE7016-0TP50
	63	1FT6064-1AH71- 1	42.5 (4.8)	5.5	84.1 (9.5)	9.1	3.08 (2.3)	0.01 (1.3)	27.6 (12.5)	1	10.2	6SE7021-0TP50
	80	1FT6084-1AH71- 1	92.9 (10.5)	12.5	177 (20)	21.6	6.63 (4.9)	0.04 (4.8)	45.2 (20.5)	1.5	25.5	6SE7022-6TP50
	80	1FT6086-1AH71- 1	106 (12)	12.6	239 (27)	25.3	7.58 (5.7)	0.06 (6.65)	56.2 (25.5)	1.5	25.5	6SE7022-6TP50
6000	36	1FT6034-1AK71- 1	12.4 (1.4)	2.1	17.7 (2)	2.6	1.18 (0.88)	0.001 (0.11)	9.7 (4.4)	1	4	6SE7014-0TP50
	80	1FT6084-1AK71- 1	57.5 (6.5)	9.2	177 (20)	25	5.47 (4.1)	0.04 (4.8)	55.1 (25)	1	25.5	6SE7022-6TP50

Order No. suffix for core types

1 2 3 4 5 6 7 8 9 10 11 12 13 14 15 16
1FT6 . . . -1 A . 7 1 - □ □ □ 1

Plug direction

Transversely to the right (only sizes 80 and 100)

Transversely to the left (only sizes 80 and 100)

Axial ND-end

Axial D-end

Encoder

sin/cos incremental encoder 1 V_{pp}

Absolute-value encoder (EnDat) 2048 p/r²

Shaft extension

Radial eccentricity tolerance

Holding brake

Smooth

N

without

Smooth

N

with

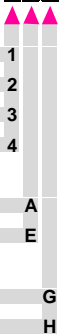

1) For selection of SIMODRIVE 611 universal and SIMODRIVE POSMO units use the stall current I_0 and refer to MC Catalog Part 3.

2) If an absolute-value encoder is used, the rated torque must be reduced by 10%.

* Listed Compact/Chassis units were selected for standard overload conditions (160% for 30 s at 300 s load cycle).

** For rated currents below 37.5 A Compact Plus units can also be used.

Synchronous Servomotors

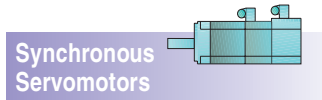

1FT6 servomotors

1FT6 air-cooled servomotors - Selection and ordering example with SIMOVERT MASTERDRIVES Motion Control¹⁾

Motor data for 100 K temperature increase										Converter data		
Rated speed	Size	Motor	Rated torque	Rated current	Stall torque	Stall current	Rated power	Moment of inertia without brake	Weight without brake	Plug size for power cable	Rated current	Inverter**
n_n		Order No.	τ_n lb _r -in (Nm)	I_n A	τ_0 lb _r -in (Nm)	I_0 A	P_n HP (kW)	J lb _r -in-s ² ($\times 10^{-3}$ kgm ²)	lb (kg)		I_{nU} A	Order No.*
rpm												

Mains voltage 3 AC 400 to 480 V with SIMOVERT MASTERDRIVES Motion Control selection example

1500 Non-ventilated	100	1FT6102-8AB7-....	217 (24.5)	8.4	239 (27)	8.4	5.09 (3.8)	0.0876 (9.9)	60.6 (27.5)	1.5	10.2	6SE7021-0TP50
	100	1FT6105-8AB7-....	363 (41)	14.5	442 (50)	17.2	8.85 (6.4)	0.1487 (16.8)	87.1 (39.5)	1.5	17.5	6SE7021-8TP50
	100	1FT6108-8AB7-....	540 (61)	20.5	619 (70)	22.1	12.87 (9.6)	0.2301 (43)	122.4 (55.5)	1.5	25.5	6SE7022-6TP50
	132	1FT6132-6AB7-....	549 (62)	19	664 (75)	23	13 (9.7)	0.3805 (26)	187.4 (85)	1.5	25.5	6SE7022-6TP50
	132	1FT6134-6AB7-....	664 (75)	24	841 (95)	29	15.82 (11.8)	0.4841 (54.7)	220.5 (100)	1.5	34	6SE7023-4TP50
	132	1FT6136-6AB7-....	779 (88)	27	1018 (115)	34	18.5 (13.8)	0.5876 (66.4)	257.9 (117)	1.5	34	6SE7023-4TP50
1500 Blower-ventilated	100	1FT6105-8SB7-....	552 (59)	21.7	575 (65)	23.5	12.47 (9.3)	0.1487 (16.8)	100.3 (45.5)	1.5	25.5	6SE7022-6TP50
	100	1FT6108-8SB7-....	735 (83)	31	796 (90)	31	17.43 (13)	0.2301 (26)	135.6 (61.5)	1.5	34	6SE7023-4TP50
	132	1FT6132-6SB7-....	885 (102)	36	973 (110)	39	21.05 (16)	0.3805 (43)	200.6 (91)	3	47	6SE7024-7.D51
	132	1FT6134-6SB7-....	1150 (130)	45	1239 (140)	48	27.35 (20.4)	0.4841 (54.7)	233.7 (106)	3	47	6SE7024-7.D52
	132	1FT6136-6SB7-....	1416 (160)	55	1549 (175)	55	33.65 (25.1)	0.5876 (66.4)	271.2 (123)	3	59	6SE7026-0.D51
2000 Non-ventilated	63	1FT6061-6AC7-....	33 (3.7)	1.9	35 (4)	2	1.07 (0.8)	0.0053 (0.6)	17.6 (8)	1	2	6SE7012-0TP50
	63	1FT6062-6AC7-....	46 (5.2)	2.6	53 (6)	2.7	1.47 (1.1)	0.0075 (0.85)	20.9 (9.5)	1	4	6SE7014-0TP50
	80	1FT6081-8AC7-....	66 (7.5)	4.1	71 (8)	4.1	2.14 (1.6)	0.0186 (2.1)	27.6 (12.5)	1.5	6.1	6SE7016-0TP50
	63	1FT6064-6AC7-....	71 (8)	3.8	84 (9.5)	4.2	2.28 (1.7)	0.0115 (1.3)	27.6 (12.5)	1	6.1	6SE7016-0TP50
	80	1FT6082-8AC7-....	101 (11.4)	6.6	115 (13)	6.9	3.22 (2.4)	0.0265 (3)	33.1 (15)	1.5	10.2	6SE7021-0TP50
	80	1FT6084-8AC7-....	150 (16.9)	8.3	177 (20)	9.5	4.69 (3.5)	0.0425 (4.8)	45.2 (20.5)	1.5	10.2	6SE7021-0TP50
	80	1FT6086-8AC7-....	204 (22.5)	10.9	239 (27)	12	6.43 (4.7)	0.0588 (6.65)	56.2 (25.5)	1.5	13.2	6SE7021-3TP50
	100	1FT6102-8AC7-....	204 (23)	11	239 (27)	12.4	6.43 (4.8)	0.0876 (9.9)	60.6 (27.5)	1.5	13.2	6SE7021-3TP50
	100	1FT6105-8AC7-....	336 (38)	17.6	442 (50)	22.9	10.72 (8)	0.1487 (16.8)	87.1 (39.5)	1.5	25.5	6SE7022-6TP50
	100	1FT6108-8AC7-....	487 (55)	24.5	619 (70)	29	15.42 (11.5)	0.2558 (26)	122.4 (55.5)	1.5	34	6SE7023-4TP50
	132	1FT6132-6AC7-....	487 (55)	23	664 (75)	31	15.42 (11.5)	0.3805 (43)	187.4 (85)	1.5	34	6SE7023-4TP50
	132	1FT6134-6AC7-....	575 (65)	27	841 (95)	39	18.23 (13.6)	0.4841 (54.7)	220.5 (100)	1.5	47	6SE7024-7.D51
	132	1FT6136-6AC7-....	665 (74)	30	1018 (115)	43	20.78 (15.5)	0.5876 (66.4)	257.9 (117)	3	47	6SE7024-7.D51

Order No. suffix: see page 2/15.

1) For selection of SIMODRIVE 611 universal and SIMODRIVE POSMO units use the stall current I_0 and refer to MC Catalog Part 3.

* Listed Compact/Chassis units were selected for standard overload conditions (160% for 30 s at 300 s load cycle).

** For rated current below 37.5 A Compact Plus units can also be used.

Synchronous Servomotors

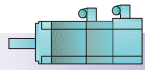

Synchronous Servomotors

1FT6 servomotors

1FT6 air-cooled servomotors - Selection and ordering example with SIMOVERT MASTERDRIVES Motion Control¹⁾

Motor data for a 100 K temperature increase									Converter data			
Rated speed	Size	Motor	Rated torque	Rated current	Stall torque	Stall current	Rated power	Moment of inertia without brake	Weight without brake	Plug size for power cable	Rated current	Inverter**
n_n		Order No.	τ_n lb _r -in (Nm)	I_n A	τ_0 lb _r -in (Nm)	I_0 A	P_n HP (kW)	J lb _r -in-s ² ($\times 10^{-3}$ kgm ²)	lb (kg)		I_{nU} A	Order No.*
rpm												

Mains voltage 3 AC 400 to 480 V with SIMOVERT MASTERDRIVES Motion Control selection example

2000 Blower-ventilated	100	1FT6105-8SC7.-....	496 (56)	28	575 (65)	32	15.68 (11.7)	0.1487 (16.8)	100.3 (45.5)	1.5	34	6SE7023-4TP50
	100	1FT6108-8SC7.-....	708 (80)	40	796 (90)	41	22.52 (16.8)	0.2301 (26)	135.6 (61.5)	3	47	6SE7024-7.D51
	132	1FT6132-6SC7.-....	867 (98)	46	973 (110)	51	27.48 (20.5)	0.3805 (43)	200.6 (91)	3	59	6SE7026-0.D51
	132	1FT6134-6SC7.-....	1106 (125)	57	1239 (140)	62	35.12 (26.2)	0.4841 (54.7)	233.7 (106)	3	72	6SE7027-2.D51
	132	1FT6136-6SC7.-....	1372 (155)	72	1549 (175)	78	43.57 (32.5)	0.5876 (66.4)	271.2 (123)	3	92	6SE7031-0.E50
3000 Non-ventilated	48	1FT6041-4AF7.-....	19 (2.15)	1.7	22 (2.6)	1.8	0.94 (0.7)	0.0026 (0.29)	14.6 (6.6)	1	2	6SE7012-0TP50
	63	1FT6061-6AF7.-....	31 (3.5)	2.6	35 (4)	2.75	1.47 (1.1)	0.0053 (0.6)	17.6 (8)	1	4	6SE7014-0TP50
	48	1FT6044-4AF7.-....	38 (4.3)	2.9	44 (5)	3	1.88 (1.4)	0.0045 (0.51)	18.3 (8.3)	1	4	6SE7014-0TP50
	63	1FT6062-6AF7.-....	42 (4.7)	3.4	53 (6)	4	2 (1.5)	0.0075 (0.85)	20.9 (9.5)	1	4	6SE7014-0TP50
	80	1FT6081-8AF7.-....	61 (6.9)	5.6	71 (8)	6	2.95 (2.2)	0.0186 (2.1)	27.6 (12.5)	1.5	6.1	6SE7016-0TP50
	63	1FT6064-6AF7.-....	62 (7)	4.9	84 (9.5)	6.1	2.95 (2.2)	0.0115 (1.3)	27.6 (12.5)	1	6.1	6SE7016-0TP50
	80	1FT6082-8AF7.-....	91 (10.3)	8.7	115 (13)	10.2	4.29 (3.2)	0.0265 (3)	33.1 (15)	1.5	10.2	6SE7021-0TP50
	80	1FT6084-8AF7.-....	130 (14.7)	11	177 (20)	14	6.17 (4.6)	0.0425 (4.8)	45.2 (20.5)	1.5	17.5	6SE7021-8TP50
	80	1FT6086-8AF7.-....	164 (18.5)	13	239 (27)	17.5	7.77 (5.8)	0.0588 (6.65)	56.2 (25.5)	1.5	17.5	6SE7021-8TP50
	100	1FT6102-8AF7.-....	173 (19.5)	13.2	239 (27)	17.2	8.18 (6.1)	0.0878 (9.9)	60.6 (27.5)	1.5	17.5	6SE7021-8TP50
100	1FT6105-8AF7.-....	274 (31)	22.5	442 (50)	34	13 (9.7)	0.1478 (16.8)	87.1 (39.5)	1.5	34	6SE7023-4TP50	
132	1FT6132-6AF7.-....	319 (36)	23	664 (75)	46	15.15 (11.3)	0.3805 (43)	187.4 (85)	3	47	6SE7024-7.D51	
3000 Blower-ventilated	80	1FT6084-8SF7.-....	195 (22)	17	230 (26)	19.3	9.25 (6.9)	0.0425 (4.8)	55.1 (25)	1.5	25.5	6SE7022-6TP50
	80	1FT6086-8SF7.-....	274 (31)	24.5	310 (35)	26	13 (9.7)	0.0588 (6.65)	66.1 (30)	1.5	34	6SE7023-4TP50
	100	1FT6105-8SF7.-....	443 (50)	35	575 (65)	45	21.05 (15.7)	0.1487 (16.8)	100.3 (45.5)	3	47	6SE7024-7.D51
	132	1FT6132-6SF7.-....	796 (90)	62	973 (110)	74	37.94 (28.3)	0.3805 (43)	200.6 (91)	3	72	6SE7027-2.D51
	132	1FT6134-6SF7.-....	973 (110)	72	1239 (140)	90	46.38 (34.6)	0.4841 (54.7)	233.7 (106)	3	92	6SE7031-0.E50
132	1FT6136-6SF7.-....	1283 (145)	104	1549 (175)	111	60.32 (45.5)	0.5876 (66.4)	271.2 (123)	3	124	6SE7031-2.F50	

Order No. suffix: see page 2/15.

1) For selection of SIMODRIVE 611 universal and SIMODRIVE POSMO units use the stall current I_0 and refer to MC Catalog Part 3.

* Listed Compact/Chassis units were selected for standard overload conditions (160% for 30 s at 300 s load cycle).

** For rated currents below 37.5 A Compact Plus units can also be used.

Synchronous Servomotors

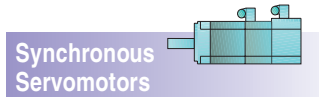

1FT6 servomotors

1FT6 air-cooled servomotors - Selection and ordering example with SIMOVERT MASTERDRIVES Motion Control¹⁾

Motor data for a 100 K temperature increase									Converter data			
Rated speed	Size	Motor	Rated torque	Rated current	Stall torque	Stall current	Rated power	Moment of inertia without brake	Weight without brake	Plug size for power cable	Rated current	Inverter**
n_n			τ_n	I_n	τ_0	I_0	P_n	J	lb		I_{nU}	
rpm	Order No.		lb _{r-in} (Nm)	A	lb _{r-in} (Nm)	A	HP (kW)	lb _{r-in-s²} ($\times 10^{-3}$ kgm ²)	(kg)		A	Order No.*

Mains voltage 3 AC 400 to 480 V with SIMOVERT MASTERDRIVES Motion Control selection example

4500 Non-ventilated	63	1FT6061-6AH7-....	26 (2.9)	3.4	35 (4)	4.1	1.88 (1.4)	0.0053 (0.6)	17.6 (8)	1	6.1	6SE7016-0TP50
	63	1FT6062-6AH7-....	32 (3.6)	3.9	53 (6)	5.6	2.28 (1.7)	0.0075 (0.85)	20.9 (9.5)	1	6.1	6SE7016-0TP50
	63	1FT6064-6AH7-....	42 (4.8)	5.5	84 (9.5)	9.1	3.08 (2.3)	0.0115 (1.3)	27.6 (12.5)	1	10.2	6SE7021-0TP50
	80	1FT6081-8AH7-....	51 (5.8)	7.3	71 (8)	9	3.62 (2.7)	0.0186 (2.1)	27.6 (12.5)	1.5	10.2	6SE7021-0TP50
	80	1FT6082-8AH7-....	75 (8.5)	11	115 (13)	15	5.36 (4)	0.0265 (6.65)	33.1 (15)	1.5	17.5	6SE7021-8TP50
	80	1FT6084-8AH7-....	173 (10.5)	12.5	177 (20)	21.6	6.57 (4.9)	0.0425 (4.8)	45.2 (20.5)	1.5	25.5	6SE7022-6TP50
	80	1FT6086-8AH7-....	106 (12)	12.6	239 (27)	25.3	7.64 (5.7)	0.0588 (6.65)	56.2 (25.5)	1.5	25.5	6SE7022-6TP50
100	1FT6102-8AH7-....	106 (12)	12	239 (27)	24.8	7.64 (5.7)	0.0876 (9.9)	60.6 (27.5)	1.5	25.5	6SE7022-6TP50	
4500 Blower-ventilated	80	1FT6084-8SH7-....	177 (20)	24.5	230 (26)	28	12.6 (9.4)	0.0425 (4.8)	55.1 (25)	1.5	34	6SE7023-4TP50
	80	1FT6086-8SH7-....	239 (27)	31.5	310 (35)	39	17 (12.7)	0.0588 (6.65)	66.1 (30)	3	47	6SE7024-7.D51
	100	1FT6105-8SH7-....	354 (40)	41	575 (65)	64	25.2 (18.8)	0.1486 (16.8)	100 (45.5)	3	72	6SE7027-2.D51
6000 Non-ventilated	28	1FT6021-6AK71-....	2.7 (0.3)	1.1	3.5 (0.4)	1.25	0.25 (0.2)	0.00019 (0.02)	2.6 (1.2)	1	2	6SE7012-0TP50
	28	1FT6024-6AK71-....	4.4 (0.5)	0.9	7.1 (0.8)	1.25	0.42 (0.3)	0.0003 (0.034)	4.6 (2.1)	1	2	6SE7012-0TP50
	36	1FT6031-4AK7-....	6.63 (0.75)	1.2	9 (1)	1.45	0.63 (0.47)	0.0006 (0.065)	6.8 (3.1)	1	2	6SE7012-0TP50
	36	1FT6034-4AK7-....	12 (1.4)	2.1	18 (2)	2.6	1.18 (0.88)	0.001 (0.11)	9.7 (4.4)	1	4	6SE7014-0TP50
	48	1FT6041-4AK7-....	15 (1.7)	2.4	22 (2.6)	3	1.47 (1.1)	0.0026 (0.29)	14.6 (6.6)	1	4	6SE7014-0TP50
	63	1FT6061-6AK7-....	19 (2.1)	3.1	35 (4)	5	1.74 (1.3)	0.0053 (0.6)	17.6 (8)	1	6.1	6SE7016-0TP50
	63	1FT6062-6AK7-....	19 (2.1)	3.2	53 (6)	7.5	1.74 (1.3)	0.0075 (0.85)	20.9 (9.5)	1	10.2	6SE7021-0TP50
	63	1FT6064-6AK7-....	19 (2.1)	3.5	84 (9.5)	12.1	1.74 (1.3)	0.0115 (1.3)	27.6 (12.5)	1	13.2	6SE7021-3TP50
	48	1FT6044-4AK7-....	27 (3)	4.1	44 (5)	5.9	2.55 (1.9)	0.0045 (0.51)	18.3 (8.3)	1	6.1	6SE7016-0TP50
	80	1FT6081-8AK7-....	41 (4.6)	7.7	71 (8)	11.1	3.89 (2.9)	0.0186 (2.1)	27.6 (12.5)	1.5	13.2	6SE7021-3TP50
	80	1FT6082-8AK7-....	49 (5.5)	9.1	115 (13)	18.2	4.69 (3.5)	0.0265 (3)	33.1 (15)	1.5	25.5	6SE7022-6TP50
	80	1FT6084-8AK7-....	57.5 (6.5)	9.2	177 (20)	25	5.5 (4.1)	0.0424 (4.8)	45.2 (20.5)	1.5	25.5	6SE7022-6TP50
	6000 Blower-ventilated	80	1FT6084-8SK7-....	150 (17)	25.5	230 (26)	36	14.34 (10.7)	0.0425 (4.8)	55.1 (25)	1.5	37.5
80		1FT6086-8SK7-....	195 (22)	29	310 (35)	45	18.5 (13.8)	0.0588 (6.65)	66.1 (30)	3	47	6SE7024-7.D51

Order No. suffix, see page 2/15.

Notes on the blower-ventilated design

	Frame sizes 80 and 100	Frame size 132
Direction of air flow	From ND-end to D-end	From D-end to ND-end
Connecting method	Plug, size 1	Terminal box
Power cable type	6FX.002-5CA01-...0	6FX.008-1BB11-..A0
Pin/terminal assignment	Pin1: L1, Pin2: N	U1/L1; V2/L2; W3/L3
Supply voltage	1 AC 220/260 V, 50/60 Hz	3 AC 400/460 V, 50/60 Hz
Max. fan current	0.3 A	0.4 A
Weight of the ventilation module	approx. 10.6 lb (4.8 kg)	approx. 12.3 lb (5.6 kg)
Sound pressure level	size 80: 69 dB (A) size 100: 71 dB (A)	74 dB (A)

1) For selection of SIMODRIVE 611 universal and POSMO units use the stall current I_0 and refer to MC Catalog Part 3.

* Listed Compact/Chassis units were selected for standard overload conditions (160% for 30 s at 300 s load cycle).

** For rated currents below 37.5 A Compact Plus units can also be used.

Synchronous Servomotors

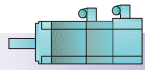

Synchronous Servomotors

1FT6 servomotors

1FT6 water-cooled servomotors - Selection and ordering example with SIMOVERT MASTERDRIVES Motion Control¹⁾

Motor data for a 100 K temperature increase									Converter data			
Rated speed	Size	Motor	Rated torque	Rated current	Stall torque	Stall current	Rated power	Moment of inertia without brake	Weight without brake	Plug size for power cable	Rated current	Inverter**
n_n rpm		Order No.	τ_n lb _r -in (Nm)	I_n A	τ_0 lb _r -in (Nm)	I_0 A	P_n HP (kW)	J lb _r -in-s ² ($\times 10^{-3}$ kgm ²)	lb (kg)		I_{nU} A	Order No.*

Mains voltage 3 AC 400 to 480 V with SIMOVERT MASTERDRIVES Motion Control selection example

1500	100	1FT6108-8WB7 -.-----	1027 (116)	43	1053 (119)	41	24.4 (18.2)	0.2301 (26)	136 (61.5)	3	47	6SE7024-7.D51
2000	100	1FT6105-8WC7 -.-----	726 (82)	60	752 (85)	58	23.06 (17.2)	0.1487 (16.8)	100 (45.5)	3	59	6SE7026-0.D51
	100	1FT6108-8WC7 -.-----	1018 (115)	57	1053 (119)	54	32.3 (24.1)	0.2301 (26)	136 (61.5)	3	59	6SE7026-0.D51
3000	63	1FT6062-6WF7 -.-----	89 (10.1)	6.7	90 (10.2)	6.8	4.3 (3.2)	0.0075 (0.85)	21 (9.5)	1	10.2	6SE7021-0TP50
	63	1FT6064-6WF7 -.-----	143 (16.1)	10.2	143 (16.2)	10.4	6.8 (5.1)	0.0115 (1.3)	27.6 (12.5)	1	13.2	6SE7021-3TP50
	80	1FT6084-8WF7 -.-----	310 (35)	27	310 (35)	26	14.7 (11)	0.4248 (4.8)	46 (21)	1.5	34	6SE7023-4TP50
	80	1FT6086-8WF7 -.-----	407 (46)	37	416 (47)	35	19.4 (14.5)	0.0589 (6.65)	57 (26)	1.5	37.5	6SE7023-8TP50
	100	1FT6105-8WF7 -.-----	690 (78)	82	752 (85)	83	32.8 (24.5)	0.1487 (16.8)	100 (45.5)	3	92	6SE7031-0.E50
	100	1FT6108-8WF7 -.----- ²⁾	965 (109)	81	1053 (119)	81	45.8 (34.2)	0.2301 (26)	136 (61.5)	3	92	6SE7031-0.E50
4500	63	1FT6062-6WH7 -.-----	89 (10)	9.3	90 (10.2)	9.5	6.3 (4.7)	0.0075 (0.85)	21 (9.5)	1	13.2	6SE7021-3TP50
	63	1FT6064-6WH7 -.-----	142 (16)	15.2	143 (16.2)	15.5	10 (7.5)	0.0115 (1.3)	27.6 (12.5)	1	25.5	6SE7022-6TP50
	80	1FT6084-8WH7 -.-----	310 (35)	39	310 (35)	38	22.1 (16.5)	0.4248 (4.8)	46 (21)	1.5	47	6SE7024-7.D51
	80	1FT6086-8WH7 -.-----	398 (45)	53	416 (47)	53	28.4 (21.2)	0.0589 (6.65)	57 (26)	3	59	6SE7026-0.D51
6000	63	1FT6062-6WK7 -.-----	87 (9.8)	12.2	90 (10.2)	12.8	8.3 (6.2)	0.0075 (0.85)	21 (9.5)	1	17.5	6SE7021-8TP50
	63	1FT6064-6WK7 -.-----	140 (15.8)	20	143 (16.2)	20.6	13.3 (9.9)	0.0115 (1.3)	27.6 (12.5)	1	34	6SE7023-4TP50
	80	1FT6084-8WK7 -.-----	301 (34)	51	310 (35)	49	28.7 (21.4)	0.4248 (4.8)	46 (21)	3	59	6SE7026-0.D51
	80	1FT6086-8WK7 -.-----	390 (44)	58	416 (47)	61	37.1 (27.7)	0.0589 (6.65)	57 (26)	3	59	6SE7026-0.D51

Order No. suffix, see page 2/15.

Notes on the water-cooled version 1FT6

- Cooling-waterflow rate: 1.32 gpm (5 l/min),
- Cooling-water inlet temperature: 77 °F (25 °C),
- Cooling-medium: Water with up to a max. of 25% anti-corrosion agent,
- Cooling-water pressure at the inlet: max. 43.5 psi (3 bar),
- Pressure loss between inlet and outlet: <1.45 psi (0.1 bar),
- Cooling-water connection: G 3/8" on D-end, plug side.

1) For selection of SIMODRIVE 611 universal and SIMODRIVE POSMO units use the stall current I_0 and refer to MC Catalog Part 3.

2) Motor type 1FT6108-8WF7-.----- is only available in vibration severity grade N.

* Listed Compact/Chassis units were selected for standard overload conditions (160% for 30 s at 300 s load cycle).

** For rated currents below 37.5 A Compact Plus units can also be used.

Synchronous Servomotors

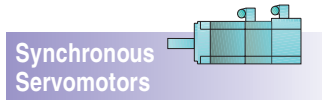

1FT6 servomotors

1FT6 stock motors ¹⁾

Rated speed n_n rpm	Size	Motor Order No. Smooth shaft end	Shaft end with key
2000	63	1FT6062-6AC71-3AG1	
	63	1FT6064-6AC71-3AG1	
	80	1FT6082-8AC71-3AG1	1FT6082-8AC71-3AA1
	80	1FT6084-8AC71-3AG1	1FT6084-8AC71-3AA1
	80	1FT6086-8AC71-3AG1	1FT6086-8AC71-3AA1
	100	1FT6105-8AC71-3AG1	1FT6105-8AC71-3AA1
3000	48	1FT6041-4AF71-3AG1	
	48	1FT6044-4AF71-3AG1	
	63	1FT6064-6AF71-3AG1	1FT6064-6AF71-3AA1
	80	1FT6082-8AF71-3AG1	1FT6082-8AF71-4AA1
	80	1FT6084-8AF71-3AG1	1FT6084-8AF71-4AA1
	80	1FT6086-8AF71-3AG1	1FT6086-8AF71-4AA1
	100	1FT6105-8AF71-3AG1	1FT6105-8AF71-4AA1

2

Modification options on stock motors ²⁾

1 2 3 4 5 6 7 8 9 10 11 12 13 14 15 16
1FT6 . . . - . A . 7 1 - □ □ . 1

Plug connection direction (looking at drive end)

- Transversely to the right (not with sizes 36, 48 and 63) 1
- Transversely to the left (not with sizes 36, 48 and 63) 2
- Axial ND-end (not with size 132) 3
- Axial D-end 4

Encoder

- Resolver, 2-pole T
- Resolver, multi-pole S
- Absolute-value encoder E

1) Stock quantities are subject to prior sale.

2) Charges apply.

Synchronous Servomotors

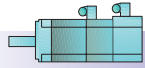

Synchronous Servomotors

1FT6 servomotors

Order No. suffix, does not apply to Fast Mover (core-type) motors

			1	2	3	4	5	6	7	8	9	10	11	12	13	14	15	16	
			1FT6...-...7-□□□□																
Type of construction																			
IM B 5, IM V 1, IM V 3				1															
IM B 14 (only sizes 63, 80 and 100) ¹⁾				2															
Plug connection direction (looking at drive end)																			
Transversely to the right (only sizes 80, 100 and 132)								1											
Transversely to the left (only sizes 80, 100 and 132)								2											
Axial ND-end (not with size 132)									3										
Axial D-end										4									
Terminal box, direction of cable entry (looking at D-end) (only at sizes 100 and 132)																			
Transversely to the right																		5	
Transversely to the left																			6
Axial ND-end																			7
Axial D-end																			8
Encoder																			
sin/cos incremental encoder 1 V _{pp}																			A
Absolute-value encoder (EnDat) (512 p/r only size 28, 2048 p/r from size 36 on) ²⁾																			E
Resolver, multi-pole (resolver pole number equivalent to motor pole number ³⁾)																			S
Resolver, 2-pole																			T
Shaft extension	Radial eccentricity tolerance	Holding brake																	
Smooth	N	without																	G
Smooth	N	with																	H
Smooth	R	without																	K
Smooth	R	with																	L
With featherkey	N	without																	A
With featherkey	N	with																	B
With featherkey	R	without																	D
With featherkey	R	with																	E
Vibration severity	Degree of protection																		
N	IP 64																		0
N	IP 65																		1
N	IP 67																		2
N	IP 68																		6
R	IP 64																		3
R	IP 65																		4
R	IP 67																		5
R	IP 68																		7

2

1) Same flange as with the IM B 5 type of construction but with threaded inserts in the four mounting holes.

2) If an absolute-value encoder is used, the rated torque must be reduced by 10%.

3) 8th position of 1FT6 motor part number indicates number of motor poles.

Synchronous Servomotors

1FS6 servomotors (explosion-proof)



Synchronous Servomotors

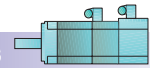

Technical specifications



Fig. 2/7
1FS6 explosion-proof servomotor²⁾

Technical characteristics

The 1FS6 three-phase servomotors are synchronous motors in a permanent state of electromagnetic excitation for applications in hazardous Zone 1 areas.

They are designed in type of protection EEx de II C T3.

The 1FS6 servomotors cannot be operated with SIMOVERT MASTERDRIVES Vector Control.

In addition to fulfilling the applicable standards and regulations for areas subject to explosion hazards, the motors also comply with the following European guidelines:

- EN 50 014
General standards for electrical equipment for hazardous areas
- EN 50 018
Standard for type of protection EEx d
- EN 50 019
Standard for type of protection EEx e
- EN 50021
Standard for type of protection Ex nA
- PBS 5000 : 16
Standard for type of protection Ex N

Technical characteristics

- winding insulation for temperature class H
- high lateral-force withstand capability
- self-cooled motors with terminal box for power connection

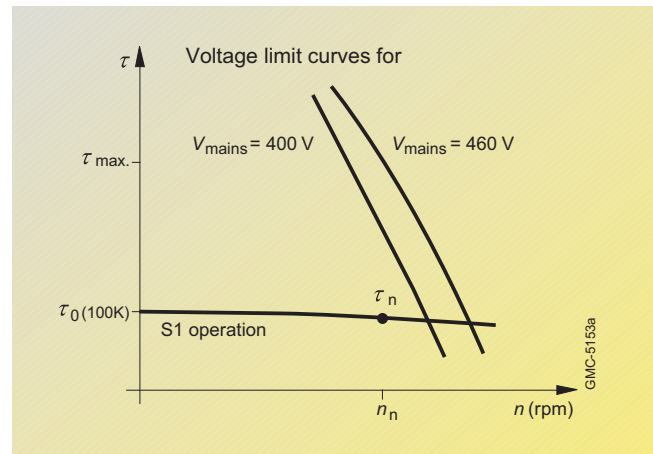

Fig. 2/8
Torque-speed characteristic

- additional terminal box for connection of encoder system
- monitoring of motor temperature by KTY 84-130 and PTC thermistor (triggering device must be certified with mark of conformity PTB 3.53-PTC/A)

Note

The PTC thermistor triggering device is mandatory for operation of the motors in hazardous areas.

Area of application

Machines for all industrial sectors with applications in hazardous Zone 1 areas.

	Standard	Options
Type of construction	IM B 5 (only frame sizes 71 and 90) IM B 35 (only frame sizes 112 and 132)	–
Degree of protection	IP 64	IP 65 with radial shaft seal
Vibration severity	N	–
Shaft and flange accuracy	N	R
Shaft extension	Smooth shaft extension	With featherkey, half-key balancing
Power connection	Terminal box	–
Motor protection	3 × PTC thermistor + KTY 84 in the stator winding	–
Encoder system	sin/cos incremental encoder 1 V _{pp}	Absolute-value encoder (EnDat) 2048 p/r ¹⁾
Paint finish	Normal paint finish anthracite RAL 7016	–
Bearings	Permanently lubricated deep-groove ball bearing	–
Cooling	Natural cooling	–

1) If an absolute-value encoder is used, the rated torque must be reduced by 10%.

2) UL/CSA approval is pending.

Synchronous Servomotors

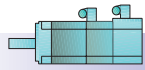

Synchronous Servomotors

1FS6 servomotors (explosion-proof)

1FS6 natural-cooled servomotors - Selection and ordering example with SIMOVERT MASTERDRIVES Compact units

Motor data for a 100 K temperature increase										Converter data	
Rated speed	Size	Motor	Rated torque	Rated current	Stall torque	Stall current	Rated power	Moment of inertia without brake	Weight without brake	Rated current	Inverter**
n_n			τ_n	I_n	τ_0	I_0	P_n	J	lb	I_{nU}	
rpm	Order No.		lb _r -in (Nm)	A	lb _r -in (Nm)	A	HP (kW)	lb _r -in-s ² ($\times 10^{-3}$ kgm ²)	(kg)	A	Order No.*

Mains voltage 3 AC 400 to 480 V with SIMOVERT MASTERDRIVES Motion Control selection example

1500	112	1FS6115-8AB73-....	327 (37)	13	354 (40)	14	7.8 (5.8)	0.1487 (16.8)	192 (87)	13.2	6SE7021-3TP50
	132	1FS6134-6AB73-.... ¹⁾	602 (68)	22	673 (76)	23	14.2 (10.6)	0.4841 (54.7)	262 (119)	25.5	6SE7022-6TP50
2000	71	1FS6074-6AC71-....	63.7 (7.2)	3.4	67.3 (7.6)	3.4	2 (1.5)	0.0115 (1.3)	64 (29)	4	6SE7014-0TP50
	90	1FS6096-8AC71-....	177 (20)	10	195 (22)	9.6	5.6 (4.2)	0.0589 (6.65)	121 (55)	10.2	6SE7021-0TP50
	112	1FS6115-8AC73-....	301 (34)	16	354 (40)	18	9.7 (7.2)	0.1487 (16.8)	192 (87)	17.5	6SE7021-8TP50
	132	1FS6134-6AC73-.... ¹⁾	513 (58)	24	673 (76)	31	16.4 (12.2)	0.4841 (54.7)	262 (119)	25.5	6SE7022-6TP50
3000	71	1FS6074-6AF71-....	55.8 (6.3)	4.4	67.3 (7.6)	4.9	2.7 (2)	0.0115 (1.3)	64 (29)	6.1	6SE7016-0TP50
	90	1FS6096-8AF71-....	150 (17)	12	195 (22)	14	7 (5.2)	0.0589 (6.65)	121 (55)	13.2	6SE7021-3TP50
	112	1FS6115-8AF73-....	248 (28)	20	354 (40)	27	11.7 (8.7)	0.1487 (16.8)	192 (87)	25.5	6SE7022-6TP50
4500	71	1FS6074-6AH71-....	40 (4.5)	5	67.3 (7.6)	7.3	2.8 (2.1)	0.0115 (1.3)	64 (29)	6.1	6SE7016-0TP50
	90	1FS6096-8AH71-....	97 (11)	11.5	195 (22)	20	6.8 (5.1)	0.0589 (6.65)	121 (55)	13.2	6SE7021-3TP50
6000	71	1FS6074-6AK71-....	17 (1.9)	3.2	67.3 (7.6)	9.7	1.6 (1.2)	0.0115 (1.3)	64 (29)	4	6SE7014-0TP50

Order No. suffix

Type of construction

IM B 5

IM B 35

Terminal box for power and encoder connection, direction of cable entry

Transversely to the right

Transversely to the left

Axial ND-end

Axial D-end

Encoder

sin/cos incremental encoder 1 V_{pp}

Absolute-value encoder (EnDat) 2048 p/r²

Shaft extension Radial eccentricity tolerance

Smooth N

With featherkey N

Smooth R

With featherkey R

Vibration severity

N

N

Degree of protection

IP 64

IP 65 with radial shaft seal

1 2 3 4 5 6 7 8 9 10 11 12 13 14 15 16
1FS6 A . 7 □ □ □ □

1 3 5 7 8 A E G A K D 0 1

1) Available soon.

2) If an absolute-value encoder is used, the rated torque must be reduced by 10%.

* Listed Compact/Chassis units were selected for standard overload conditions (160% for 30 s at 300 s load cycle).

** For rated currents below 37.5 A Compact Plus units can also be used.

1FN3 AC linear motors

Technical data

Advantages of 1FN3 AC linear motors

- Outstanding dynamic response and very high traversing velocity
- Excellent precision
- Simple installation
- Non-wearing drive components due to contactless drive power transmission

In combination with the SIMODRIVE 611 universal or the POSMO CD/CA converter, 1FN3 linear motors provide a linear drive system that is specially designed to meet high dynamic requirements.

The motors consist of a primary section and a secondary section with rare-earth magnets. The primary section has fixed dimensions, while the secondary section is made up of individual elements to suit the traversing range. Through parallel operation of the motors, force and length can be scaled beyond the available spectrum.

Another important advantage of linear drive technology is that the effects of elasticity, play, and friction, as well as natural oscillation are virtually eliminated.

If suitable measuring systems are used and the temperature conditions are appropriate, the motors can be positioned in the nanometer range (hundred billionths of an inch).

The simple mechanical construction without transmission elements such as leadscrew, coupling or belt, enhances the reliability and dynamic response of the drive components.

Heat loss occurs almost exclusively in the primary section

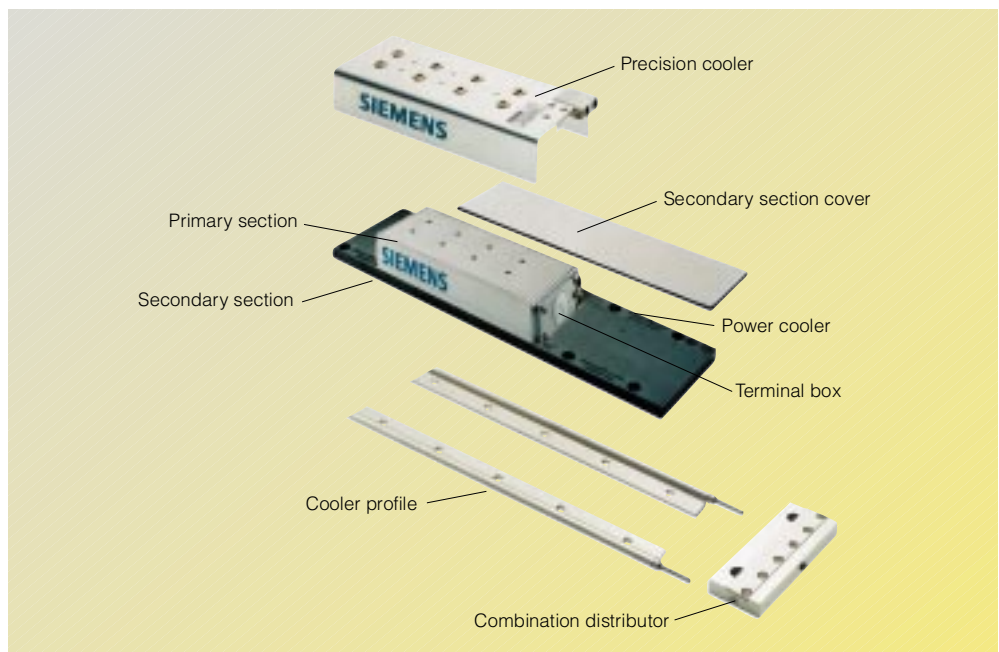

Fig. 2/9
1FN3 AC linear motors

and is dissipated via an integrated cooling system. The optional Thermosandwich dual-circuit cooling system permits both a thermal decoupling of the motor from the machine, and also a low-priced cooling design.

The stainless metal encapsulation of the primary section provides the high mechanical robustness and resistance to soiling required for use in machine tools, as well as resistance to corrosive liquids. In addition, a large air gap makes minimal demands on the preparation of mounting surfaces. The mounting tolerances for the air gap are ± 0.3 mm (0.012 in).

Applications for 1FN3

- High dynamic and flexible machine construction
- Handling
- Pick & Place

Construction variants

1FN3 linear motors are available as single-comb or double-comb motors.

- Single-comb motors

The single-comb version consists of a primary section with standard winding that is mounted parallel to the associated secondary section.

- Double-comb motors

The secondary section of the double-comb version lies between two primary sections (each primary section with standard winding and complementary winding). The construction as double-comb motor is particularly suitable for applications with movable secondary section and small traversing paths (eccentric machining).

For information and order numbers regarding optional components (precision cooler, cooler profile, combination distributor and secondary section cover) refer to section 4 "Accessories".

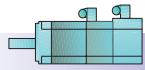

Technical data

The 1FN3 linear motors have an overload range available for acceleration processes. The maximum force F_{MAX} can only be utilized up to a maximum speed; above this speed, only the rated force F_N is available.

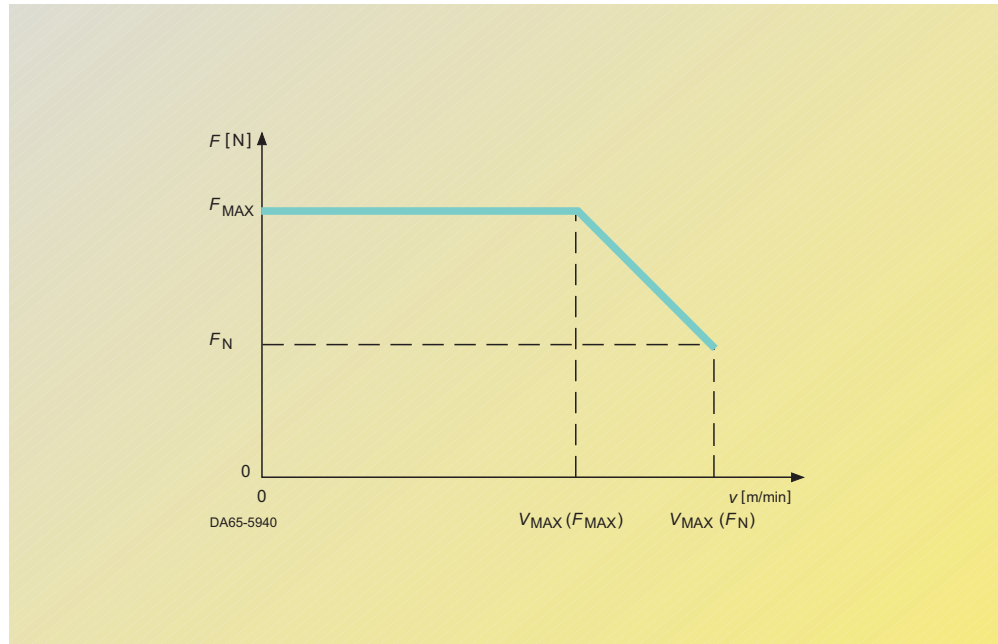

Fig. 2/10
Speed/feedrate force diagram

Technical specifications

Motor type	AC linear motor (permanent-field synchronous motor)
Magnet material	Rare-earth magnetic material
Insulation of stator winding according to EN (IEC) 60 032-1	Temperature class H for a winding temperature of +248 °F (+120 °C)
Degree of protection according to EN 60 034-5 (IEC 60 034-5)	IP 65
Overload ratio ($F_{MAX}:F_N$) up to:	2.75
Build-on options	Different gradations due to modular construction
Covering of secondary sections	Consistent across all segments, exchangeable
Cooling method	Water cooling
Water cooler connections	1/8" internal thread to all primary and secondary section coolers (when using appropriate adapters)
Temperature influence on surrounding construction for precision cooling, max.	+4 K
Max. permissible coolant inlet temperature	+95 °F (+35 °C) (avoid condensation) +95 °F (+35 °C) on reduction of rated motor power
Temperature monitoring method integrated in primary winding	PTC thermistor Temperature sensor KTY 84
Connection method	Terminal boxes with heavy-gauge thread Option: accessory for connector and cable connection
Recommended measuring systems	See Section 4, "Accessories"
2nd rating plate	Supplied separately packed

Linear Motors

Linear Motors

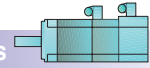

1FN3 AC linear motors

1FN3 AC linear motors - Selection and ordering data for primary and secondary section

Force of feed		Maximum velocity ¹⁾		1FN3 AC linear motor water-cooled		Weight ²⁾		
$F_{rated}^3)$	F_{max}	v_{max} at F_{rated}	v_{max} at F_{max}	Primary section Order No.	Secondary section Order No.	Primary section	Secondary section	Permanent attractive force F_{ATT}
lb _f (N)	lb _f (N)	ft/min (m/min)	ft/min (m/min)			lb (kg)	lb (kg)	lb _f (N)
44.96 (200)	123.64 (550)	1224 (373)	479 (146)	1FN3 050-2WC00-0AA0	1FN3 050-4SA00-0AA0	5.3/6.4 (2.4/2.9)	0.9/1.1 (0.4/0.5)	299 (1330)
44.96 (200)	110.16 (490)	453 (138)	728 (222)	1FN3 100-1WC00-0AA1	1FN3 100-4SA00-0AA0	4.4 (3.8)	0.8 (0.7)	
101.16 (450)	247.28 (100)	975 (297) 1631 (497)	430 (131) 778 (237)	1FN3 100-2WC00-0AA1 1FN3 100-2WE00-0AA1	1FN3 100-4SA00-0AA0	8.4/9.7 (3.8/4.4)	1.5/1.8 (0.7/0.8)	596 (2650)
151.74 (675)	370.92 (1650)	909 (277) 1631 (497)	394 (120) 778 (237)	1FN3 100-3WC00-0AA1 1FN3 100-3WE00-0AA1		11.9/13.7 (5.4/6.2)	1.5/1.8 (0.7/0.8)	895 (3980)
202.32 (900)	494.56 (2200)	975 (297) 1631 (497)	430 (131) 778 (237)	1FN3 100-4WC00-0AA1 1FN3 100-4WE00-0AA1		16.3/18.7 (7.4/8.5)	1.5/1.8 (0.7/0.8)	1194 (5310)
252.9 (1125)	618.2 (2750)	837 (255)	358 (109)	1FN3 100-5WC00-0AA1		20/22.9 (9.1/10.4)	1.5/1.8 (0.7/0.8)	1490 (6630)
151.74 (675)	370.92 (1650)	925 (282)	413 (126)	1FN3 150-2WC00-0AA1	1FN3 150-4SA00-0AA0	11.7/13.2 (5.3/6)	2.6/2.86 (1.2/1.3)	895 (3980)
228.17 (1015)	555.26 (2470)	925 (282)	413 (126)	1FN3 150-3WC00-0AA1		17.2/19.1 (7.8/8.7)	2.6/2.86 (1.2/1.3)	1342 (5970)
303.48 (1350)	741.84 (3300)	925 (282)	413 (126)	1FN3 150-4WC00-0AA1		22.4/25.1 (10.2/11.4)	2.6/2.86 (1.2/1.3)	1789 (7960)
379.91 (1690)	926.18 (4120)	925 (282)	413 (126)	1FN3 150-5WC00-0AA1		28.2/31.2 (12.8/14.2)	2.6/2.86 (1.2/1.3)	2237 (9950)
275.38 (1225)	775.56 (3450)	207 (63) 975 (297) 1211 (369)	578 (176) 410 (125) 2642 (805)	1FN3 300-2WB00-0AA1 1FN3 300-2WC00-0AA1 1FN3 300-2WG00-0AA1	1FN3 300-4SA00-0AA0	25.1/27.3 (11.4/12.4)	5.3/5.7 (2.4/2.6)	1544 (6870)
413.63 (1840)	1162.22 (5170)	975 (297) 2743 (836)	410 (125) 1257 (383)	1FN3 300-3WC00-0AA1 1FN3 300-3WG00-0AA1		37.4/40.5 (17/18.4)	5.3/5.7 (2.4/2.6)	2316 (10300)
550.76 (2450)	1551.12 (6900)	207 (63) 975 (297)	578 (176) 410 (125)	1FN3 300-4WB00-0AA1 1FN3 300-4WC00-0AA1		48.9/52.8 (22.2/24)	5.3/5.7 (2.4/2.6)	3087 (13730)
433.86 (1930)	1164.46 (5180)	902 (275) 1703 (519)	394 (120) 788 (240)	1FN3 450-2WC00-0AA1 1FN3 450-2WE00-0AA1	1FN3 450-4SA00-0AA0	35/37.6 (15.9/17.1)	8.4/8.8 (3.8/4)	2316 (10300)
650.8 (2895)	1744.45 (7760)	538 (164) 712 (217) 902 (275) 1703 (519)	203 (62) 295 (90) 394 (120) 788 (240)	1FN3 450-3WB00-0AA1 1FN3 450-3WB05-0AA1 1FN3 450-3WC00-0AA1 1FN3 450-3WE00-0AA1		49.7/53.5 (22.6/24.3)	8.4/8.8 (3.8/4)	3473 (15450)
867.73 (3860)	2326.68 (10350)	538 (164) 712 (217) 902 (275) 1703 (519)	203 (62) 295 (90) 394 (120) 788 (240)	1FN3 450-4WB00-0AA1 1FN3 450-4WB05-0AA1 1FN3 450-4WC00-0AA1 1FN3 450-4WE00-0AA1		68/72.8 (30.9/33.1)	8.4/8.8 (3.8/4)	4631 (20600)
880.09 (3915)	2326.68 (10350)	190 (58) 834 (254)	509 (155) 368 (112)	1FN3 600-3WB00-0AA1 1FN3 600-3WC00-0AA1	1FN3 600-4SA00-0AA0	69.3/73.5 (31.5/33.4)	10.1/11 (4.6/5)	4631 (20600)
1173.46 (5220)	3102.24 (13800)	509 (155) 706 (215) 834 (254)	190 (58) 299 (91) 368 (112)	1FN3 600-4WB00-0AA1 1FN3 600-4WB50-0AA1 1FN3 600-4WC00-0AA1		89.8/95.3 (40.8/43.3)	10.1/11 (4.6/5)	6173 (27460)
910.44 (4050)	2326.68 (10350)	525 (160) 830 (253)	213 (65) 377 (115)	1FN3 900-2WB00-0AA1 1FN3 900-2WC00-0AA1	1FN3 900-4SA00-0AA0	62/65.3 (28.2/29.7)	16.5/17.4 (7.5/7.9)	4631 (20600)
1820.88 (8100)	4653.36 (20700)	525 (160) 666 (203) 830 (253)	213 (65) 289 (88) 377 (115)	1FN3 900-4WB00-0AA1 1FN3 900-4WB50-0AA1 1FN3 900-4WC00-0AA1		123.6/129.6 (56.2/58.9)	16.5/17.4 (7.5/7.9)	9264 (41210)

With one temperature monitoring circuit: Temp-S	0
With one temperature monitoring circuit: Temp-S and Temp-F	1

- Speed values refer to a converter DC link voltage of 600 V DC.
- Values for version with/without components for precision cooling of the primary and secondary section (see chapter 4).
- For water cooling.
- For connection via terminal box, length < 4 ft 11 in (1.5 m) the following applies:
4 × 16 mm² + 4 × 0.5 mm²; Order No. 6FX7 008-1BC61-□□□0.

Linear Motors

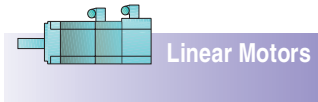

1FN3 AC linear motors

2

Motor phase current		Required converter rated current I_{rated}/I_{max}	Rated power loss P_{VN}^3	Calculated power Electrical peak power consumption P_{calc}	Motor connection via power connectors	Power cable, trailable, with shield (increased speed/acceleration)
I_{rated}^3	I_{max}					
A	A	A	HP (W)	HP (kW)	Motor cable cross-section (IEC 60204-1C) AWG (mm ²)	Available by the meter Order No.
2.7	8.2	5/ 10	0.4 (310)	5.5 (4.1)	4 × 16 + 4 × 20 (4 × 1.5 + 4 × 0.5)	6FX7 008-1BC11-□□□□
2.4	6.5	5/ 10	0.38 (280)	4.2 (3.1)	4 × 16 + 4 × 20 (4 × 1.5 + 4 × 0.5)	6FX7 008-1BC11-□□□□
5.1 8.1	13.5 21.5	9/ 18 18/ 36	0.7 (550) 0.7 (550)	8.4 (6.3) 11.1 (8.3)	4 × 16 + 4 × 20 (4 × 1.5 + 4 × 0.5) 4 × 16 + 4 × 20 (4 × 1.5 + 4 × 0.5)	6FX7 008-1BC11-□□□□ -1BC11-□□□□
7.2 12.1	19.1 32.2	18/ 36 18/ 36	1.1 (820) 1.1 (830)	12.3 (9.2) 16.6 (12.4)	4 × 16 + 4 × 20 (4 × 1.5 + 4 × 0.5) 4 × 16 + 4 × 20 (4 × 1.5 + 4 × 0.5)	6FX7 008-1BC11-□□□□ -1BC11-□□□□
10.1 16.1	27 43	18/ 36 28/ 56	1.5 (1100) 1.5 (1100)	16.9 (12.6) 22.3 (16.6)	4 × 16 + 4 × 20 (4 × 1.5 + 4 × 0.5) 4 × 14 + 4 × 20 (4 × 2.5 + 4 × 0.5)	6FX7 008-1BC11-□□□□ -1BC21-□□□□
11	29.5	18/ 36	1.8 (1320)	19.3 (14.4)	4 × 16 + 4 × 20 (4 × 1.5 + 4 × 0.5)	6FX7 008-1BC11-□□□□
7.2	19.1	18/ 36	1 (730)	11.7 (8.7)	4 × 16 + 4 × 20 (4 × 1.5 + 4 × 0.5)	6FX7 008-1BC11-□□□□
10.7	28.6	18/ 36	1.5 (1100)	17.4 (13)	4 × 16 + 4 × 20 (4 × 1.5 + 4 × 0.5)	-1BC11-□□□□
14.3	38.2	28/ 56	2 (1470)	23.3 (17.4)	4 × 16 + 4 × 20 (4 × 1.5 + 4 × 0.5)	-1BC11-□□□□
17.9	47.7	28/ 56	2.5 (1830)	29.1 (21.7)	4 × 14 + 4 × 20 (4 × 2.5 + 4 × 0.5)	-1BC21-□□□□
8 12.6 32.2	24.7 39.2 99.7	18/ 36 28/ 56 56/112	1.3 (990) 1.3 (1000) 1.2 (900)	17.7 (13.2) 22.5 (16.8) 40.5 (30.2)	4 × 16 + 4 × 20 (4 × 1.5 + 4 × 0.5) 4 × 16 + 4 × 20 (4 × 1.5 + 4 × 0.5) 4 × 10 + 4 × 20 (4 × 6 + 4 × 0.5)	6FX7 008-1BC11-□□□□ -1BC11-□□□□ -1BC41-□□□□
19 50	58.7 154.9	56/112 140/210	2 (1500) 1.8 (1370)	33.8 (25.2) 61.7 (46)	4 × 14 + 4 × 20 (4 × 2.5 + 4 × 0.5) 4 × 6 + 4 × 20 (4 × 16 + 4 × 0.5)	6FX7 008-1BC21-□□□□ -1BC61-□□□□
16 25.3	49.4 78.3	28/ 56 56/112	2.7 (2000) 2.7 (1990)	35.2 (26.3) 44.9 (33.5)	4 × 14 + 4 × 20 (4 × 2.5 + 4 × 0.5) 4 × 12 + 4 × 20 (4 × 4 + 4 × 0.5)	6FX7 008-1BC21-□□□□ -1BC31-□□□□
18.8 33.8	55.3 99.7	28/ 56 56/112	2 (1470) 1.8 (1370)	31.1 (23.2) 43.8 (32.7)	4 × 14 + 4 × 20 (4 × 2.5 + 4 × 0.5) 4 × 10 + 4 × 20 (4 × 6 + 4 × 0.5)	6FX7 008-1BC21-□□□□ -1BC41-□□□□
17.9 22.8 28.1 50.7	52.7 67.3 83 149.6	28/ 56 56/112 56/112 140/210	3 (2250) 3 (2230) 2.9 (2200) 2.8 (2060)	36.9 (27.5) 41.7 (31.1) 46.5 (34.7) 66 (49.2)	4 × 14 + 4 × 20 (4 × 2.5 + 4 × 0.5) 4 × 12 + 4 × 20 (4 × 4 + 4 × 0.5) 4 × 10 + 4 × 20 (4 × 6 + 4 × 0.5) 4 × 6 + 4 × 20 (4 × 16 + 4 × 0.5)	6FX7 008-1BC21-□□□□ -1BC31-□□□□ -1BC41-□□□□ -1BC61-□□□□
23.8 30.4 37.5 67.6	70.3 89.8 110.6 199.5	56/112 56/112 56/112 140/210	4 (3000) 4 (2980) 3.9 (2940) 3.7 (2740)	49.3 (36.8) 55.5 (41.4) 62.2 (46.4) 87.5 (65.3)	4 × 12 + 4 × 20 (4 × 4 + 4 × 0.5) 4 × 10 + 4 × 20 (4 × 6 + 4 × 0.5) 4 × 8 + 4 × 20 (4 × 10 + 4 × 0.5) 4 × 4 + 4 × 20 (4 × 25 + 4 × 0.5) ⁴⁾	6FX7 008-1BC31-□□□□ -1BC41-□□□□ -1BC51-□□□□ -1BC25-□□□□
23.2 35.2	67.3 102.4	56/112 56/112	4 (3000) 3.5 (2630)	47.3 (35.3) 55.9 (41.7)	4 × 12 + 4 × 20 (4 × 4 + 4 × 0.5) 4 × 10 + 4 × 20 (4 × 6 + 4 × 0.5)	6FX7 008-1BC31-□□□□ -1BC41-□□□□
30.9 40.8 46.9	89.8 118.5 136.5	56/112 70/140 70/140	5.4 (4000) 5.1 (3810) 4.7 (3510)	63.3 (47.2) 71 (53) 74.3 (55.4)	4 × 10 + 4 × 20 (4 × 6 + 4 × 0.5) 4 × 8 + 4 × 20 (4 × 10 + 4 × 0.5) 4 × 8 + 4 × 20 (4 × 10 + 4 × 0.5)	6FX7 008-1BC41-□□□□ -1BC51-□□□□ -1BC51-□□□□
24.7 36.7	69.5 103.3	56/112 56/112	3.9 (2940) 3.6 (2670)	46.2 (34.5) 55 (41)	4 × 12 + 4 × 20 (4 × 4 + 4 × 0.5) 4 × 8 + 4 × 20 (4 × 10 + 4 × 0.5)	6FX7 008-1BC31-□□□□ -1BC51-□□□□
49.4 60.6 73.5	138.9 170.3 206.5	70/140 140/210 140/210	7.9 (5890) 7.8 (5830) 7.1 (5340)	92.1 (68.7) 102.5 (76.5) 109.8 (81.9)	4 × 8 + 4 × 20 (4 × 10 + 4 × 0.5) 4 × 6 + 4 × 20 (4 × 16 + 4 × 0.5) 4 × 4 + 4 × 20 (4 × 25 + 4 × 0.5) ⁴⁾	6FX7 008-1BC51-□□□□ -1BC61-□□□□ -1BC25-□□□□

Lengths:	164 ft (50 m)	1 F A
(examples)	328 ft (100 m)	2 A A
	656 ft (200 m)	3 A A

The current load capability of the power cables complies with IEC 60204-1 for installation type C, Table 5, under continuous operating conditions at an ambient air temperature of +104 °F (+40 °C).

Linear Motors

Notes

Linear Motors

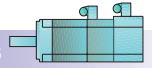

2

Asynchronous Servomotors



1PH7 Asynchronous servomotors

- 3/2 Technical data
- 3/5 Stock motors
- 3/6 Selection and ordering example with SIMOVERT MASTERDRIVES converters
- 3/16 Order No. suffix

1PL6 Asynchronous servomotors

- 3/19 Technical data
- 3/21 Selection and ordering example with SIMOVERT MASTERDRIVES converters
- 3/25 Order No. suffix

1PH4 Water-cooled asynchronous servomotors

- 3/27 Technical data
- 3/28 Selection and ordering example with SIMOVERT MASTERDRIVES converters



Asynchronous Servomotors

Asynchronous Servomotors



1PH7 Asynchronous servomotors

Technical data



Fig. 3/1
1PH7 three-phase motors,
frame sizes 100 to 160



Fig. 3/2
1PH7 three-phase motors,
frame sizes 180 to 225



Fig. 3/3
1PH7 three-phase motors,
frame size 280

Technical characteristics

The 1PH7 three-phase servomotors are compact, separately-cooled asynchronous motors with squirrel-cage rotor.

They are especially characterized by the following properties:

- high power-density with low physical volume
- high degree of protection
- high speed ranges
- speed to zero without reduction of torque
- robustness
- low maintenance requirements
- high lateral-force withstand capability
- high level of concentricity even at low speeds
- integrated encoder system for detecting motor speed, connected by plug
- terminal box for power cable connection
- monitoring of the motor temperature by the KTY 84.

Application

Hoisting equipment:

- hoists and drives in storage and retrieval systems for high-bay warehouses

Printing industry:

- single and main drives for printing machines for printing units

Rubber, plastic, wire and glass:

- drives for extruders, calenders, rubber injection moulding, film machines, conveyor systems

- wire-drawing machines, cable stranding machines etc.

General applications such as winding and coiling machines.

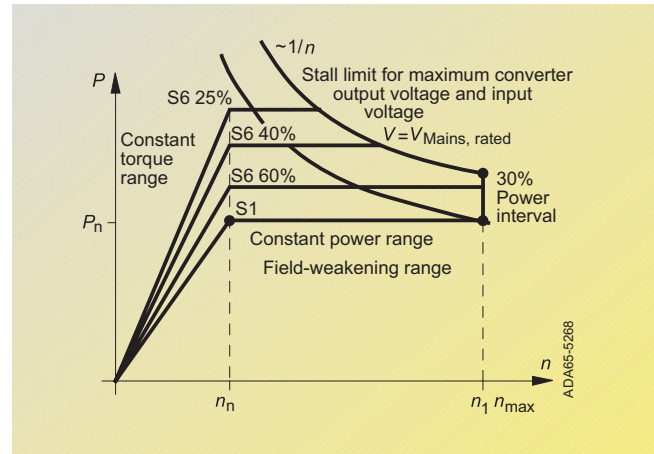

Fig. 3/4
Power-speed characteristic

Stock motors

To meet our customer's logistical expectations, the 1PH7 motor is stocked in its¹⁾ most demanded configurations.

The technical features of these stock motors are:

- blower-ventilated. Air flow direction DE to NDE.
- terminal box with cable entry from the right (looking at D-end).
- integrated pulse encoder (1024 ppr)
- vibration severity class R
- degree of protection IP 55
- type of construction IM B 35 (flange/foot mounting).

For a complete listing of stock motors refer to table "Stock motors" on page 3/5.

Minor modifications on the stock motors are possible for an additional charge. A listing of the possible changes is given on page 3/5. Allow an average of 5 working days to complete the modifications.

1) Stock quantities are subject to prior sale.



Technical data

1PH7 motors, frame sizes 100 to 160

	Standard	Options
Type of construction	IM B 3	IM B 5 (only for sizes 100, 132), IM B 35
Degree of protection	IP 55	–
Vibration severity	R	S SR
Shaft and flange accuracy	R	–
Shaft extension	With featherkey, half-key balancing	Smooth shaft extension With featherkey, full-key balancing
Terminal box	On top, cable entry from the right	Cable entry from the left or ND-end
Motor protection	KTY 84, in the stator winding	–
Encoder system (plug connection)	Incremental encoder HTL (with SIMOVERT VC and MC)	Without encoder (for use with SIMOVERT VC, SIMODRIVE 611 universal and POSMO) sin/cos incremental encoder 1 V _{pp} (for use with SIMOVERT MC and SIMODRIVE) Absolute-value encoder (EnDat) 2048 p/r (for use with SIMOVERT MC and SIMODRIVE) 2-pole resolver (for use with SIMOVERT MC and SIMODRIVE)
Paint finish	Without paint coating (with impregnating resin coating)	Normal paint finish anthracite RAL 7016 Special paint finish "worldwide" RAL 7016, other colors on request
Bearings	Permanently lubricated deep-groove ball bearing for coupling and belt drive	Special version for increased speed
Cooling	Separate ventilation The fan is axially mounted on the ND-end Air flow ND-end to D-end	Without separate fan, for pipe connection Air flow from D-end to ND-end
Brake	–	Holding brake with emergency stop function, as a brake module on D-end
Gearbox mounting ¹⁾	–	The following gearboxes can be mounted: • Two-gear gear-change units 2LG4

1PH7 motors, frame sizes 180 to 225

	Standard	Options
Type of construction	IM B 3	IM B 35
Degree of protection	IP 55	–
Vibration severity	R	S SR
Shaft and flange accuracy	N	R
Shaft extension	With featherkey, half-key balancing	Smooth shaft extension With featherkey, full-key balancing
Terminal box	On top, cable entry from the right	Cable entry from D-end, ND-end or the left
Motor protection	KTY 84, in the stator winding	–
Encoder system (connection by plug)	Incremental encoder HTL (with SIMOVERT VC and MC)	Without encoder (for use with SIMOVERT VC) sin/cos incremental encoder 1 V _{pp} (for use with SIMOVERT MC and SIMODRIVE 611 universal) Absolute-value encoder (EnDat) 2048 p/r (for use with SIMOVERT MC and SIMODRIVE 611 universal) 2-pole resolver (for use with SIMOVERT MC and SIMODRIVE 611 universal)
Paint finish	Normal coating anthracite RAL 7016	Primed Special paint finish "worldwide" RAL 7016
Bearings	Permanently lubricated deep-groove ball bearing for coupling drives	Cylindrical roller bearing for belt drives Cylindrical roller bearing for increased lateral forces Special design for greater maximum speed (only for types 1PH718. and 1PH7224)
Cooling	Separate ventilation The fan is axially mounted on the ND-end Air flow from D-end to ND-end	Without separate fan, for pipe connection Air flow from ND-end to D-end
Brake	–	Holding brake with emergency stop function on D-end, suitable for coupling drive
Gearbox mounting ¹⁾	–	Prepared for fitting a ZF gear-change unit, see Chapter 4
Silencer	–	Silencer for reducing the sound pressure level (retrofit also possible)

¹⁾ Motor is designed to allow mounting to a gearbox. For unsealed gearboxes make sure you use the shaft seal ring option.

Asynchronous Servomotors

Asynchronous
Servomotors



1PH7 Asynchronous servomotors

Technical data

1PH7 motors, frame size 280¹⁾

	Standard	Options
Type of construction	IM B 3	IM B 35
Degree of protection	IP 55	–
Vibration severity	N	R
Shaft and flange accuracy	N	R
Shaft extension	With featherkey, half-key balancing	Smooth shaft extension With featherkey, full-key balancing
Terminal box	On the right (ND-end), cable entry from below, encoder connector on D-end	On the left (ND-end), cable entry from below, encoder connector on D-end On top (ND-end), in the case of a fan ND-end left or right, cable entry from the right, encoder connector on D-end, D-end on request
Motor protection	KTY 84, in the stator winding	–
Encoder system (plug connection)	Incremental encoder HTL (with SIMOVERT VC)	Without encoder (MASTERDRIVES VC), other encoders on request
Paint finish	Normal coating anthracite RAL 7016	Primed Special paint finish, "worldwide" RAL 7016, other colors on request
Bearings	Bearing concept for coupling drive with relubricating device	Bearing concept for belt drive or increased lateral forces with relubricating device
Cooling	Separate ventilation, the fan is axially mounted on the ND-end, air flow ND-end to D-end	Without separate fan, for single pipe connection Fan ND-end left or right Fan radially mounted on the D-end (air flow from D-end to ND-end) on request

3

1) Available soon.



1PH7 stock motors¹⁾

Rated speed ²⁾ n_n rpm	Size	Motor Order No.
1150	100	1PH7103-2HD03-0BA3
	100	1PH7107-2HD03-0BA3
	132	1PH7133-2HD03-0BA3
	132	1PH7137-2HD03-0BA3
	160	1PH7163-2HD03-0BA3
	160	1PH7167-2HD03-0BA3
1750	100	1PH7101-2HF03-0BA3
	100	1PH7103-2HF03-0BA3
	100	1PH7105-2HF03-0BA3
	100	1PH7107-2HF03-0BA3
	132	1PH7131-2HF03-0BA3
	132	1PH7133-2HF03-0BA3
	132	1PH7135-2HF03-0BA3
	132	1PH7137-2HF03-0BA3
	160	1PH7163-2HF03-0BA3
	160	1PH7167-2HF03-0BA3

Modification option for stock motors³⁾

	1 2 3 4 5 6 7 8 9 10 11 12 13 14 15 16
Encoder	
Absolute-value encoder	E
Pulse encoder (1024 p/r)	H
Pulse encoder (2048 p/r)	J
sin/cos incremental encoder 1 V _{pp} (without C-track and D-track)	N
sin/cos incremental encoder 1 V _{pp} (with code signals C-track and D-track)	M
Resolver	R
Direction of cable entry (terminal box on top, looking at D-end)	
From the right	0
From the left	3

1PH7 ... - 2□ . □3-0 B A 3

1) Stock quantities are subject to prior sale.

2) Rated speed for SIMOVERT MASTERDRIVES Motion Control and SIMODRIVE 611 universal at 480 V mains voltage or for SIMOVERT MASTERDRIVES Vector Control at 400 V mains voltage. Rated speeds are increased for SIMOVERT MASTERDRIVES Vector Control at 480 V mains voltage (e.g. 1150 → 1350 and 1750 → 2000 rpm).

3) Modification charges apply.

Asynchronous Servomotors

Asynchronous Servomotors



1PH7 Asynchronous servomotors

1PH7 Asynchronous servomotors - Selection and ordering example with SIMOVERT MASTERDRIVES Vector Control converters

Motor data (utilization to temperature rise class F)													Converter data			
Rated speed	Size	Motor	Rated power	Rated torque	Rated current	Rated voltage	Speed during field-weakening ¹⁾	Max. operating speed ²⁾	Power factor	Magnetizing current	Efficiency	Rated frequency	Moment of inertia	Weight	Rated current	Converter/ Inverter
n_n			P_n	τ_n	I_n	U_n	n_1	$n_{max.}$	$\cos \varphi$	I_μ	η_n	f_n	J	m	$I_n U$	
rpm		Order No.	HP (kW)	lb _f -ft (Nm)	A	V	rpm	rpm		A		Hz	lb _f -in ₂ -s ² (kgm ²)	lb (kg)	A	Order No. ³⁾ *
Mains voltage 3 AC 400 V for SIMOVERT MASTERDRIVES Vector Control converters																
400	160	1PH7163-..B.-.-....	12.7 (9.5)	167 (227)	30	274	2000	6500	0.88	11.5	0.809	14.3	1.637 (0.185)	386 (175)	34	6SE7023-4.C61
	160	1PH7167-..B.-.-....	17.4 (13)	228 (310)	37	294	1600	6500	0.88	14	0.814	14.3	2.018 (0.228)	463 (210)	37.5	6SE7023-8.D61
	180	1PH7184-..B.-.-....	21.8 (16.3)	287 (390)	51	271	1800	5000	0.84	26	0.83	14.2	4.451 (0.503)	816 (370)	59	6SE7026-0.D61
	180	1PH7186-..B.-.-....	28.4 (21.2)	373 (505)	67	268	2000	5000	0.81	38.5	0.845	14	5.363 (0.666)	970 (440)	72	6SE7027-2.D61
	225	1PH7224-..B.-.-....	40.8 (30.4)	533 (725)	88	268	1700	4500	0.87	36.5	0.864	14	13.088 (1.479)	1389 (630)	92	6SE7031-0.E60
	225	1PH7226-..B.-.-....	52.5 (39.2)	688 (935)	114	264	2000	4500	0.86	49	0.88	14	17.08 (1.93)	1653 (750)	124	6SE7031-2.F60
225	1PH7228-..B.-.-....	64.3 (48)	842 (1145)	136	272	2000	4500	0.85	60.5	0.888	13.9	20.584 (2.326)	1896 (860)	146	6SE7031-5.F60	
500	280	1PH7284-..B.-.-0...	107 (80)	1128 (1529)	144	400	1150	3300	0.87	60	0.922	17	37.169 (4.2)	2867 (1300)	146	6SE7031-5.F60
	280	1PH7286-..B.-.-0...	134 (100)	1408 (1909)	180	400	1300	3300	0.86	78	0.93	17	40.019 (5.2)	3308 (1500)	186	6SE7031-8.F60
	280	1PH7288-..B.-.-0...	174 (130)	1830 (2481)	233	400	1400	3300	0.87	100	0.933	17	55.754 (6.3)	3749 (1700)	260	6SE7032-6.G60
1150	100	1PH7103-..D.-.-....⁴⁾	5.8 (4.3)	26 (36)	10	391	2200	9000	0.81	5	0.813	40.6	0.150 (0.017)	88 (40)	10.2	6SE7021-0.A61
	100	1PH7107-..D.-.-....⁴⁾	9.7 (7.2)	44 (60)	17.5	360	3000	9000	0.81	8.8	0.838	40.3	0.257 (0.029)	143 (65)	17.5	6SE7021-8.B61
	132	1PH7133-..D.-.-....⁴⁾	18.1 (13.5)	82 (112)	29	381	2500	8000	0.85	13	0.877	39.7	0.673 (0.076)	198 (90)	34	6SE7023-4.C61
	132	1PH7137-..D.-.-....⁴⁾	26.1 (19.5)	119 (162)	43	367	2600	8000	0.86	19	0.887	39.6	0.965 (0.109)	331 (150)	47	6SE7024-7.D61
	160	1PH7163-..D.-.-....⁴⁾	33.5 (25)	153 (208)	55	364	3400	6500	0.84	25	0.904	39.2	1.637 (0.185)	386 (175)	59	6SE7026-0.D61
	160	1PH7167-..D.-.-....⁴⁾	41.6 (31)	189 (257)	70	357	3700	6500	0.83	34	0.909	39.1	2.018 (0.228)	463 (210)	72	6SE7027-2.D61
	180	1PH7184-..D.-.-....	59 (44)	269 (366)	89	383	2800	5000	0.82	42	0.92	39.2	4.451 (0.503)	816 (370)	92	6SE7031-0.E60
	180	1PH7186-..D.-.-....	77.7 (58)	354 (482)	116	390	3100	5000	0.81	58	0.925	39.1	5.894 (0.666)	970 (440)	124	6SE7031-2.F60
	225	1PH7224-..D.-.-....	108.6 (81)	493 (670)	160	385	3300	4500	0.81	79	0.938	38.9	13.088 (1.479)	1389 (630)	186	6SE7031-8.F60
	225	1PH7226-..D.-.-....	140.8 (105)	640 (870)	197	390	3000	4500	0.84	87.5	0.941	38.9	17.08 (1.93)	1653 (750)	210	6SE7032-1.G60
	225	1PH7228-..D.-.-....	172.9 (129)	787 (1070)	238	390	2800	4500	0.85	98	0.943	38.9	20.584 (2.326)	1896 (860)	260	6SE7032-6.G60
	280	1PH7284-..D.-.-0...	228 (170)	1043 (1414)	314	400	3300	3300	0.82	158	0.956	38.6	37.169 (4.2)	2867 (1300)	315	6SE7033-2.G60
	280	1PH7286-..D.-.-0...	282 (210)	1287 (1745)	414	380	3300	3300	0.81	218	0.958	38.6	40.019 (5.2)	3308 (1500)	510	6SE7035-1.K/J60
	280	1PH7288-..D.-.-0...	349 (260)	1593 (2160)	497	385	3300	3300	0.82	252	0.96	38.6	55.754 (6.3)	3749 (1700)	510	6SE7035-1.K/J60

Converter

Inverter



Order No. suffix: see pages 3/16 to 3/18.

- 1) n_1 : motor speed at which, when $P = P_n$, there is still a power reserve of 30% before the stalling limit is reached or at which the mechanical speed limit is reached or at which the speed is limited by the SIMOVERT MASTERDRIVES Vector Control converter due to $f_{max.} \leq 5 \cdot f_n$.
- 2) Warning! The maximum speed in field-weakening mode is sometimes limited to lower values due to $f_{max.} \leq 5 \cdot f_n$.
- 3) The 9th digit in the Order No. is to be completed with the suffixes indicated below the table.
- 4) Typically stocked, see page 3/5 for available configuration.
- * Listed Compact/Chassis units were selected for standard overload conditions (160% for 30 s at 300 s load cycle).
- ** For rated currents below 37.5 A Compact Plus units can also be used.

Asynchronous Servomotors



Asynchronous Servomotors

1PH7 Asynchronous servomotors

1PH7 Asynchronous servomotors - Selection and ordering example with SIMOVERT MASTERDRIVES Vector Control converters

Motor data (utilization to temperature rise class F)													Converter data			
Rated speed	Size	Motor	Rated power	Rated torque	Rated current	Rated voltage	Speed during field-weakening ¹⁾	Max. operating speed ²⁾	Power factor	Magnetizing current	Efficiency	Rated frequency	Moment of inertia	Weight	Rated current	Converter/ Inverter
n_n		Order No.	P_n HP (kW)	τ_n lb _f -ft (Nm)	I_n A	U_n V	n_1 rpm	n_{max} rpm	$\cos \varphi$	I_μ A	η_n	f_n Hz	J lb _f -in ₂ -s ² (kgm ²)	m lb (kg)	I_{nU} A	Order No. ³⁾ *
rpm																

Mains voltage 3 AC 400 V for SIMOVERT MASTERDRIVES Vector Control converters

1750	100	1PH7101-...F... ⁴⁾	5.8 (4.3)	18 (24)	10	398	4600	9000	0.75	5.7	0.855	60	0.15 (0.017)	88 (40)	10.2	6SE7021-0.A61
	100	1PH7103-...F... ⁴⁾	8.4 (6.25)	25 (34)	13	398	2600	9000	0.84	5.3	0.849	61	0.15 (0.017)	88 (40)	13.2	6SE7021-3.B61
	100	1PH7105-...F... ⁴⁾	10.7 (8)	32 (44)	17.5	398	3500	9000	0.77	9.3	0.875	60	0.257 (0.029)	143 (65)	17.5	6SE7022-6.B61
	100	1PH7107-...F... ⁴⁾	13.4 (10)	40 (55)	23	381	4200	9000	0.8	10.6	0.87	60.3	0.257 (0.029)	143 (65)	25.5	6SE7022-6.C61
	132	1PH7131-...F... ⁴⁾	17.4 (13)	52 (71)	24	398	3300	8000	0.88	8.1	0.902	59.7	0.673 (0.076)	198 (90)	25.5	6SE7022-6.C61
	132	1PH7133-...F... ⁴⁾	23.5 (17.5)	71 (96)	34	398	3400	8000	0.85	14	0.9	59.7	0.673 (0.076)	198 (90)	34	6SE7023-4.C61
	132	1PH7135-...F... ⁴⁾	28.8 (21.5)	86 (117)	42	398	3800	8000	0.86	16	0.906	59.5	0.965 (0.109)	331 (150)	47	6SE7024-7.D61
	132	1PH7137-...F... ⁴⁾	33.5 (25)	100 (136)	56	357	4800	8000	0.85	23	0.902	59.5	0.965 (0.109)	331 (150)	59	6SE7026-0.D61
	160	1PH7163-...F... ⁴⁾	45.6 (34)	137 (186)	72	364	4600	6500	0.86	28	0.915	59.2	1.637 (0.185)	386 (175)	72	6SE7027-2.D61
	160	1PH7167-...F... ⁴⁾	55 (41)	165 (224)	79	398	3900	6500	0.86	30	0.92	59.2	2.018 (0.228)	463 (210)	92	6SE7031-0.E60
	180	1PH7184-...F... ⁴⁾	80.4 (60)	240 (327)	120	388	5000	5000	0.78	64	0.934	59	4.451 (0.503)	816 (370)	124	6SE7031-2.F60
	180	1PH7186-...F... ⁴⁾	113.9 (85)	342 (465)	169	385	5000	5000	0.8	84	0.94	59	5.894 (0.666)	970 (440)	186	6SE7031-8.F60
	225	1PH7224-...U... ⁴⁾	147.5 (110)	441 (600)	203	395	4500	4500	0.84	88	0.944	58.9	13.088 (1.479)	1389 (630)	210	6SE7032-1.G60
	225	1PH7226-...F... ⁴⁾	181 (135)	542 (737)	254	395	4500	4500	0.82	120	0.947	58.9	17.08 (1.93)	1653 (750)	260	6SE7032-6.G60
	225	1PH7228-...F... ⁴⁾	239.9 (179)	717 (975)	342	395	4500	4500	0.81	169	0.948	58.8	20.584 (2.326)	1896 (860)	370	6SE7033-7.G60
	280	1PH7284-...F...-0...	302 (225)	906 (1228)	393	400	3300	3300	0.86	163	0.962	58.7	37.169 (4.2)	2867 (1300)	510	6SE7035-1.K/J60
	280	1PH7286-...F...-0...	362 (270)	1087 (1474)	466	400	3300	3300	0.87	184	0.963	58.7	40.019 (5.2)	3308 (1500)	510	6SE7035-1.K/J60
	280	1PH7288-...F...-0...	456 (340)	1369 (1856)	586	400	3300	3300	0.87	234	0.965	58.7	55.754 (6.3)	3749 (1700)	590	6SE7036-0.K/J60

Converter

Inverter

E **
T

Order No. suffix: see pages 3/16 to 3/18.

1) n_1 : motor speed at which, when $P = P_n$, there is still a power reserve of 30% before the stalling limit is reached or at which the mechanical speed limit is reached or at which the speed is limited by the SIMOVERT MASTERDRIVES Vector Control converter due to $f_{max} \leq 5 \cdot f_n$.

2) Warning! The maximum speed in field-weakening mode is sometimes limited to lower values due to $f_{max} \leq 5 \cdot f_n$.

3) The 9th digit in the Order No. is to be completed with the suffixes indicated below the table.

4) Typically stocked, see page 3/5 for available configuration.

* Listed Compact/Chassis units were selected for standard overload conditions (160% for 30 s at 300 s load cycle).

** For rated currents below 37.5 A Compact Plus units can also be used.

Asynchronous Servomotors

Asynchronous Servomotors



1PH7 Asynchronous servomotors

1PH7 Asynchronous servomotors - Selection and ordering example with SIMOVERT MASTERDRIVES Vector Control converters

Motor data (utilization to temperature rise class F)													Converter data			
Rated speed	Size	Motor	Rated power	Rated torque	Rated current	Rated voltage	Speed during field-weakening ¹⁾	Max. operating speed ²⁾	Power factor	Magnetizing current	Efficiency	Rated frequency	Moment of inertia	Weight	Rated current	Converter/ Inverter
n_n		Order No.	P_n HP (kW)	τ_n lb _f -ft (Nm)	I_n A	U_n V	n_1 rpm	n_{max} rpm	$\cos \varphi$	I_μ A	η_n	f_n Hz	J lb _f -in-s ² (kgm ²)	m lb (kg)	$I_n U$ A	Order No. ³⁾ *
Mains voltage 3 AC 400 V for SIMOVERT MASTERDRIVES Vector Control converters																
2300	100	1PH7103-...G...-....	10.1 (7.5)	23 (31)	17	388	5400	9000	0.79	8.2	0.866	78.8	0.15 (0.017)	88 (40)	17.5	6SE7021-8.B61
	100	1PH7107-...G...-....	16.1 (12)	36.9 (50)	26	400	5400	9000	0.8	12	0.878	78.7	0.257 (0.029)	143 (65)	25.5	6SE7022-6.C61
	132	1PH7133-...G...-....	30.2 (22.5)	68 (93)	45	398	4600	8000	0.86	17	0.9	78	0.673 (0.076)	198 (90)	47	6SE7024-7.D61
	132	1PH7137-...G...-....	38.9 (29)	88 (120)	56	398	5500	8000	0.87	21	0.903	77.8	0.965 (0.109)	331 (150)	59	6SE7026-0.D61
	160	1PH7163-...G...-....	50.9 (38)	116 (158)	82	398	6500	6500	0.78	43	0.9	77.3	1.637 (0.185)	386 (175)	92	6SE7031-0.E60
	160	1PH7167-...G...-....	59 (44)	135 (183)	85	398	6500	6500	0.84	40	0.911	77.4	2.018 (0.228)	463 (210)	92	6SE7031-0.E60
2900	180	1PH7184-...L...-....	108.6 (81)	195 (265)	158	395	5000	5000	0.80	77	0.934	97.4	4.451 (0.503)	816 (370)	186	6SE7031-8.F60
	180	1PH7186-...L...-....	135.4 (101)	245 (333)	206	385	5000	5000	0.78	107	0.936	97.3	5.894 (0.666)	970 (440)	210	6SE7032-1.G60
	225	1PH7224-...L...-....	199.7 (149)	360 (490)	274	395	4500	4500	0.84	115	0.946	97.3	13.088 (1.479)	1389 (630)	315	6SE7033-2.G60
	225	1PH7226-...L...-....	248 (185)	449 (610)	348	390	4500	4500	0.83	154	0.946	97.2	17.08 (1.93)	1653 (750)	370	6SE7033-7.G60
	225	1PH7228-...L...-....	288.2 (215)	522 (708)	402	395	4500	4500	0.82	186	0.946	97.2	20.584 (2.326)	1896 (860)	510	6SE7035-1.K/J60

Converter

Inverter

E **
T

Order No. suffix: see pages 3/16 to 3/17.

1) n_1 : motor speed at which, when $P = P_n$, there is still a power reserve of 30% before the stalling limit is reached or at which the mechanical speed limit is reached or at which the speed is limited by the SIMOVERT MASTERDRIVES Vector Control converter due to $f_{max.} \leq 5 \cdot f_n$.

2) Warning! The maximum speed in field-weakening mode is sometimes limited to lower values due to $f_{max.} \leq 5 \cdot f_n$.

3) The 9th digit in the Order No. is to be completed with the suffixes indicated below the table.

* Listed Compact/Chassis units were selected for standard overload conditions (160% for 30 s at 300 s load cycle).

** For rated currents below 37.5 A Compact Plus units can also be used.

Asynchronous Servomotors



Asynchronous Servomotors

1PH7 Asynchronous servomotors

1PH7 Asynchronous servomotors - Selection and ordering example with SIMOVERT MASTERDRIVES Vector Control converters

Motor data (utilization to temperature rise class F)													Converter data			
Rated speed	Size	Motor	Rated power	Rated torque	Rated current	Rated voltage	Speed during field-weakening ¹⁾	Max. operating speed ²⁾	Power factor	Mag-netizing current	Effi-ciency	Rated fre-quency	Moment of inertia	Weight	Rated cur-rent	Converter/ Inverter
n_n rpm		Order No.	P_n HP (kW)	τ_n lb _f -ft (Nm)	I_n A	U_n V	n_1 rpm	n_{max} rpm	$\cos \varphi$	I_μ A	η_n	f_n Hz	J lb _f -in ₂ -s ² (kgm ²)	m lb (kg)	I_{nU} A	Order No. ³⁾ *
Mains voltage 3 AC 480 V for SIMOVERT MASTERDRIVES Vector Control converters																
500	160	1PH7163-...B...-....	16.1 (12)	169 (230)	30	340	2100	6500	0.86	13	0.841	17.6	1.637 (0.185)	386 (175)	34	6SE7023-4.C61
	160	1PH7167-...B...-....	21.4 (16)	225 (306)	35	350	1700	6500	0.89	13	0.836	17.7	2.018 (0.228)	463 (210)	37.5	6SE7023-8.D61
	180	1PH7184-...B...-....	27.5 (20.5)	288 (392)	51	335	2000	5000	0.83	26	0.858	17.5	4.451 (0.503)	816 (370)	59	6SE7026-0.D61
	180	1PH7186-...B...-....	35.5 (26.5)	372 (506)	67	335	2300	5000	0.79	39.5	0.87	17.3	5.363 (0.666)	970 (440)	72	6SE7027-2.D61
	225	1PH7224-...B...-....	50.9 (38)	533 (725)	86	335	1800	4500	0.85	37.5	0.888	17.3	13.088 (1.479)	1389 (630)	92	6SE7031-0.E60
	225	1PH7226-...B...-....	65.7 (49)	688 (935)	112	330	2100	4500	0.85	50	0.9	17.3	17.08 (1.93)	1653 (750)	124	6SE7031-2.F60
	225	1PH7228-...B...-....	80.4 (60)	842 (1145)	135	340	2200	4500	0.84	61.5	0.907	17.2	20.584 (2.326)	1896 (860)	146	6SE7031-5.F60
600	280	1PH7284-...B...-0...	127 (95)	1120 (1519)	144	480	1650	3300	0.86	61	0.932	20.3	37.169 (4.2)	2867 (1300)	146	6SE7031-5.F60
	280	1PH7286-...B...-0...	161 (120)	1413 (1916)	180	480	1750	3300	0.86	80	0.939	20.3	40.019 (5.2)	3308 (1500)	186	6SE7031-8.F60
	280	1PH7288-...B...-0...	208 (155)	1825 (2474)	233	480	1850	3300	0.86	102	0.941	20.3	55.754 (6.3)	3749 (1700)	260	6SE7032-6.G60
1350	100	1PH7103-...D...-....⁴⁾	6.3 (4.7)	24 (33)	9.5	433	3000	9000	0.81	4.5	0.83	47.1	0.15 (0.017)	88 (40)	10.2	6SE7021-0.A61
	100	1PH7107-...D...-....⁴⁾	10.7 (8)	42 (57)	17	405	3800	9000	0.8	8.1	0.853	47	0.257 (0.029)	143 (65)	17.5	6SE7021-8.B61
	132	1PH7133-...D...-....⁴⁾	20.1 (15)	78 (106)	30	433	3100	8000	0.84	12	0.887	46.4	0.673 (0.076)	198 (90)	34	6SE7023-4.C61
	132	1PH7137-...D...-....⁴⁾	29.5 (22)	115 (156)	42	416	3200	8000	0.85	17	0.895	46.3	0.965 (0.109)	331 (150)	47	6SE7024-7.D61
	160	1PH7163-...D...-....⁴⁾	37.5 (28)	146 (198)	53	413	4100	6500	0.83	24	0.911	45.8	1.637 (0.185)	386 (175)	59	6SE7026-0.D61
	160	1PH7167-...D...-....⁴⁾	45.6 (34)	177 (241)	67	400	4600	6500	0.83	34	0.91	45.8	2.018 (0.228)	463 (210)	72	6SE7027-2.D61
	180	1PH7184-...D...-....	67 (50)	277 (375)	86	450	3400	5000	0.81	42	0.928	45.8	4.451 (0.503)	816 (370)	92	6SE7031-0.E60
	180	1PH7186-...D...-....	89.8 (67)	349 (475)	114	460	3600	5000	0.79	59.5	0.93	45.7	5.894 (0.666)	970 (440)	124	6SE7031-2.F60
	225	1PH7224-...D...-....	123.3 (92)	478 (650)	156	450	3800	4500	0.8	78.5	0.942	45.6	13.088 (1.479)	1389 (630)	186	6SE7031-8.F60
	225	1PH7226-...D...-....	160.9 (120)	623 (847)	193	460	3500	4500	0.82	88.5	0.945	45.6	17.08 (1.93)	1653 (750)	210	6SE7032-1.G60
	225	1PH7228-...D...-....	197.1 (147)	767 (1043)	232	460	3300	4500	0.84	99.5	0.947	45.6	20.584 (2.326)	1896 (860)	260	6SE7032-6.G60
	280	1PH7284-...D...-0...	268 (200)	1044 (1416)	314	470	3300	3300	0.82	159	0.958	45.3	37.169 (4.2)	2867 (1300)	315	6SE7033-2.G60
	280	1PH7286-...D...-0...	328 (245)	1278 (1733)	414	445	3300	3300	0.8	217	0.96	45.3	40.019 (5.2)	3308 (1500)	510	6SE7035-1.K/J60
	280	1PH7288-...D...-0...	409 (305)	1592 (2158)	497	450	3300	3300	0.82	250	0.962	45.3	55.754 (6.3)	3749 (1700)	510	6SE7035-1.K/J60

Converter

Inverter

E **

T

Order No. suffix: see pages 3/16 to 3/18.

1) n_1 : motor speed at which, when $P = P_n$, there is still a power reserve of 30% before the stalling limit is reached or at which the mechanical speed limit is reached or at which the speed is limited by the SIMOVERT MASTERDRIVES Vector Control converter due to $f_{max} \leq 5 \cdot f_n$.

2) Warning! The maximum speed in field-weakening mode is sometimes limited to lower values due to $f_{max} \leq 5 \cdot f_n$.

3) The 9th digit in the Order No. is to be completed with the suffixes indicated below the table.

4) Typically stocked, see page 3/5 for available configuration.

* Listed Compact/Chassis units were selected for standard overload conditions (160% for 30 s at 300 s load cycle).

** For rated currents below 37.5 A Compact Plus units can also be used.

Asynchronous Servomotors

Asynchronous Servomotors



1PH7 Asynchronous servomotors

1PH7 Asynchronous servomotors - Selection and ordering example with SIMOVERT MASTERDRIVES Vector Control converters

Motor data (utilization to temperature rise class F)													Converter data			
Rated speed	Size	Motor	Rated power	Rated torque	Rated current	Rated voltage	Speed during field-weakening ¹⁾	Max. operating speed ²⁾	Power factor	Magnetizing current	Efficiency	Rated frequency	Moment of inertia	Weight	Rated current	Converter/ Inverter
n_n		Order No.	P_n HP (kW)	τ_n lb _f -ft (Nm)	I_n A	U_n V	n_1 rpm	n_{max} rpm	$\cos \varphi$	I_μ A	η_n	f_n Hz	J lb _f -in ² (kgm ²)	m lb (kg)	I_{nU} A	Order No. ³⁾ *
Mains voltage 3 AC 480 V for SIMOVERT MASTERDRIVES Vector Control converters																
2000	100	1PH7101...F... ⁴⁾	6.3 (4.7)	16 (22)	10	459	6000	9000	0.72	6	0.862	68.2	0.15 (0.017)	88 (40)	10.2	6SE7021-0.A61
	100	1PH7103...F... ⁴⁾	9.4 (7)	24 (33)	13	459	3400	9000	0.82	5.6	0.86	69.1	0.15 (0.017)	88 (40)	13.2	6SE7021-3.B61
	100	1PH7105...F... ⁴⁾	12.1 (9)	32 (43)	17.5	450	5000	9000	0.78	9.3	0.878	68.3	0.257 (0.029)	143 (65)	17.5	6SE7021-8.B61
	100	1PH7107...F... ⁴⁾	14.7 (11)	39 (53)	23	433	5300	9000	0.79	10.8	0.876	68.6	0.257 (0.029)	143 (65)	25.5	6SE7022-6.C61
	132	1PH7131...F... ⁴⁾	20.1 (15)	53 (72)	25	459	3900	8000	0.88	8.5	0.903	68	0.673 (0.076)	198 (90)	25.5	6SE7022-6.C61
	132	1PH7133...F... ⁴⁾	26.8 (20)	71 (96)	34	459	4100	8000	0.84	15	0.9	68	0.673 (0.076)	198 (90)	34	6SE7023-4.C61
	132	1PH7135...F... ⁴⁾	32.2 (24)	85 (115)	42	459	4700	8000	0.85	17	0.905	67.8	0.965 (0.109)	331 (150)	47	6SE7024-7.D61
	132	1PH7137...F... ⁴⁾	37.5 (28)	99 (134)	55	402	5800	8000	0.85	23	0.9	67.9	0.965 (0.109)	331 (150)	59	6SE7026-0.D61
	160	1PH7163...F... ⁴⁾	49.6 (37)	130 (177)	70	412	6300	6500	0.85	29	0.912	67.5	1.637 (0.185)	386 (175)	72	6SE7027-2.D61
	160	1PH7167...F... ⁴⁾	60.3 (45)	158 (215)	76	459	5400	6500	0.84	32	0.916	67.4	2.018 (0.228)	463 (210)	92	6SE7031-0.E60
	180	1PH7184...F... ⁴⁾	91.2 (68)	239 (325)	120	450	5000	5000	0.78	66	0.935	67.3	4.451 (0.503)	816 (370)	124	6SE7031-2.F60
	180	1PH7186...F... ⁴⁾	126 (94)	331 (450)	165	445	5000	5000	0.78	87	0.941	67.3	5.894 (0.666)	970 (440)	186	6SE7031-8.F60
	225	1PH7224...U... ⁴⁾	166.2 (124)	434 (590)	200	460	4500	4500	0.82	91	0.944	67.2	13.088 (1.479)	1389 (630)	210	6SE7032-1.G60
	225	1PH7226...F... ⁴⁾	205.1 (153)	537 (730)	254	450	4500	4500	0.82	119	0.948	67.2	17.08 (1.93)	1653 (750)	260	6SE7032-6.G60
	225	1PH7228...F... ⁴⁾	262.7 (196)	668 (936)	332	450	4500	4500	0.79	168	0.95	67.1	20.584 (2.326)	1896 (860)	370	6SE7033-7.G60
	280	1PH7284...F...-0... ⁴⁾	342 (255)	898 (1218)	393	455	3300	3300	0.86	162	0.962	67	37.169 (4.2)	2867 (1300)	510	6SE7035-1.K/J60
	280	1PH7286...F...-0... ⁴⁾	416 (310)	1092 (1481)	466	455	3300	3300	0.87	182	0.964	67	40.019 (5.2)	3308 (1500)	510	6SE7035-1.K/J60
	280	1PH7288...F...-0... ⁴⁾	516 (385)	1356 (1838)	586	455	3300	3300	0.87	232	0.965	67	55.754 (6.3)	3749 (1700)	590	6SE7036-0.K/J60

Converter
Inverter

E **
T

Order No. suffix: see pages 3/16 to 3/18.

- 1) n_1 : motor speed at which, when $P = P_n$, there is still a power reserve of 30% before the stalling limit is reached or at which the mechanical speed limit is reached or at which the speed is limited by the SIMOVERT MASTERDRIVES Vector Control converter due to $f_{max} \leq 5 \cdot f_n$.
- 2) Warning! The maximum speed in field-weakening mode is sometimes limited to lower values due to $f_{max} \leq 5 \cdot f_n$.
- 3) The 9th digit in the Order No. is to be completed with the suffixes indicated below the table.
- 4) Typically stocked, see page 3/5 for available configuration.
- * Listed Compact/Chassis units were selected for standard overload conditions (160% for 30 s at 300 s load cycle).
- ** For rated currents below 37.5 A Compact Plus units can also be used.

Asynchronous Servomotors



Asynchronous Servomotors

1PH7 Asynchronous servomotors

1PH7 Asynchronous servomotors - Selection and ordering example with SIMOVERT MASTERDRIVES Vector Control converters

Motor data (utilization to temperature rise class F)														Converter data		
Rated speed	Size	Motor	Rated power	Rated torque	Rated current	Rated voltage	Speed during field-weakening ¹⁾	Max. operating speed ²⁾	Power factor	Mag-netiz-ing cur-rent	Effi-ciency	Rated fre-quency	Moment of inertia	Weight	Rated cur-rent	Converter/ Inverter
n_n		Order No.	P_n HP (kW)	τ_n lb _f -ft (Nm)	I_n A	U_n V	n_1 rpm	n_{max} rpm	$\cos \varphi$	I_μ A	η_n	f_n Hz	J lb _f -in ² -s ² (kgm ²)	m lb (kg)	I_{nU} A	Order No. ³⁾ *
Mains voltage 3 AC 480 V for SIMOVERT MASTERDRIVES Vector Control converters																
2650	100	1PH7103-...G...-....	10.7 (8)	21 (29)	16.5	440	7000	9000	0.78	8.2	0.871	90.3	0.15 (0.017)	88 (40)	17.5	6SE7021-8.B61
	100	1PH7107-...G...-....	17.4 (13)	34.7 (47)	24.5	459	6700	9000	0.78	12	0.887	90.2	0.257 (0.029)	143 (65)	25.5	6SE7022-6.C61
	132	1PH7133-...G...-....	32.2 (24)	64 (87)	42	450	5900	8000	0.85	17	0.898	89.6	0.673 (0.076)	198 (90)	47	6SE7024-7.D61
	132	1PH7137-...G...-....	40.2 (30)	79 (108)	52	450	7100	8000	0.84	21	0.894	89.4	0.965 (0.109)	331 (150)	59	6SE7026-0.D61
	160	1PH7163-...G...-....	53.6 (40)	106 (144)	76	433	6500	6500	0.82	37	0.895	89	1.637 (0.185)	386 (175)	92	6SE7031-0.E60
	160	1PH7167-...G...-....	60 (44)	117 (159)	77	459	6500	6500	0.8	40	0.911	89	2.018 (0.228)	463 (210)	92	6SE7031-0.E60
2900	180	1PH7184-...L...-....	108.6 (81)	196 (267)	158	395	5000	5000	0.8	77	0.934	97.4	4.451 (0.503)	816 (370)	186	6SE7031-8.F60
	180	1PH7186-...L...-....	135.4 (101)	245 (333)	206	385	5000	5000	0.78	107	0.936	97.3	5.894 (0.666)	970 (40)	210	6SE7032-1.G60
	225	1PH7224-...L...-....	199.7 (149)	360 (490)	274	395	4500	4500	0.84	115	0.946	97.3	13.088 (1.479)	1389 (630)	315	6SE7033-2.G60
	225	1PH7226-...L...-....	248 (185)	449 (610)	348	390	4500	4500	0.83	154	0.946	97.2	17.08 (1.93)	1653 (750)	370	6SE7033-7.G60
	225	1PH7228-...L...-....	288.2 (215)	521 (708)	402	395	4500	4500	0.82	188	0.954	97.2	20.584 (2.326)	1896 (860)	510	6SE7035-1.K/J60

Converter

Inverter

E **
T

Order No. suffix: see pages 3/16 to 3/17.

1) n_1 : motor speed at which, when $P = P_n$, there is still a power reserve of 30% before the stalling limit is reached or at which the mechanical speed limit is reached or at which the speed is limited by the SIMOVERT MASTERDRIVES Vector Control converter due to $f_{max} \leq 5 \cdot f_n$.

2) Warning! The maximum speed in field-weakening mode is sometimes limited to lower values due to $f_{max} \leq 5 \cdot f_n$.

3) The 9th digit in the Order No. is to be completed with the suffixes indicated below the table.

* Listed Compact/Chassis units were selected for standard overload conditions (160% for 30 s at 300 s load cycle).

** For rated currents below 37.5 A Compact Plus units can also be used.

Asynchronous Servomotors

Asynchronous Servomotors



1PH7 Asynchronous servomotors

1PH7 Asynchronous servomotors - Selection and ordering example with SIMOVERT MASTERDRIVES Motion Control converters

Motor data (utilization to temperature rise class F)														Converter data		
Rated speed	Size	Motor	Rated power	Rated torque	Rated current	Rated voltage	Speed during field-weakening ¹⁾	Max. operating speed ²⁾	Power factor	Magnetizing current	Efficiency	Rated frequency	Moment of inertia	Weight	Rated current	Converter/ Inverter
n_n rpm		Order No.	P_n HP (kW)	τ_n lb _f -ft (Nm)	I_n A	U_n V	n_1 rpm	n_{max} rpm	$\cos \varphi$	I_μ A	η_n	f_n Hz	J lb _f -in ² -s ² (kgm ²)	m lb (kg)	$I_n U$ A	Order No. ³⁾ *
Mains voltage 3 AC 400 V for SIMOVERT MASTERDRIVES Motion Control converters and SIMODRIVE 611 universal																
400	160	1PH7163-...B...-....	12.7 (9.5)	167 (227)	30	274	800	6500	0.88	11.5	0.809	14.3	1.637 (0.185)	386 (175)	34	6SE7023-4.C51
	160	1PH7167-...B...-....	17.4 (13)	228 (310)	37	294	800	6500	0.88	14	0.814	14.3	2.018 (0.228)	463 (210)	37.5	6SE7023-8.D51
	180	1PH7184-...B...-....	21.8 (16.3)	287 (390)	51	271	800	5000	0.84	26	0.83	14.2	4.451 (0.503)	816 (370)	59	6SE7026-0.D51
	180	1PH7186-...B...-....	28.4 (21.2)	372 (505)	67	268	800	5000	0.81	38.5	0.845	14	5.363 (0.666)	970 (440)	72	6SE7027-2.D51
	225	1PH7224-...B...-....	40.8 (30.4)	533 (725)	88	268	800	4500	0.87	36.5	0.864	14	13.088 (1.479)	1389 (630)	92	6SE7031-0.E50
	225	1PH7226-...B...-....	52.5 (39.2)	688 (935)	114	264	800	4500	0.86	49	0.88	14	17.08 (1.93)	1653 (750)	124	6SE7031-2.F50
	225	1PH7228-...B...-....	64.3 (48)	842 (1145)	136	272	800	4500	0.85	60.5	0.888	13.9	20.584 (2.326)	1896 (860)	155	6SE7031-8.F50
1000	100	1PH7103-...D...-....⁴⁾	5 (3.7)	26 (35)	10	343	1800	9000	0.82	4.8	0.794	35.6	0.150 (0.017)	88 (40)	10.2	6SE7021-0.A51
	100	1PH7107-...D...-....⁴⁾	8.4 (6.25)	44 (60)	17.5	319	2000	9000	0.81	8.9	0.822	35.3	0.257 (0.029)	143 (65)	17.5	6SE7021-8.B51
	132	1PH7133-...D...-....⁴⁾	16.1 (12)	85 (115)	30	336	1800	8000	0.86	13	0.865	34.8	0.673 (0.076)	198 (90)	34	6SE7023-4.C51
	132	1PH7137-...D...-....⁴⁾	22.8 (17)	119 (162)	43	322	2000	8000	0.85	19	0.878	34.6	0.965 (0.109)	331 (150)	47	6SE7024-7.D51
	160	1PH7163-...D...-....⁴⁾	29.5 (22)	154 (210)	55	315	2000	6500	0.84	24	0.899	34.2	1.637 (0.185)	386 (175)	59	6SE7026-0.D51
	160	1PH7167-...D...-....⁴⁾	37.5 (28)	196 (267)	71	312	2000	6500	0.83	33	0.903	34.2	2.018 (0.228)	463 (210)	72	6SE7027-2.D51
	180	1PH7184-...D...-....	52.3 (39)	274 (372)	90	335	2000	5000	0.81	44	0.913	34.2	4.451 (0.503)	816 (370)	92	6SE7031-0.E50
	180	1PH7186-...D...-....	68.4 (51)	357 (485)	116	340	2000	5000	0.81	58	0.918	34.1	5.894 (0.666)	970 (440)	124	6SE7031-2.F50
	225	1PH7224-...D...-....	95.2 (71)	499 (678)	161	335	2000	4500	0.81	78.5	0.934	33.9	13.088 (1.479)	1389 (630)	175	6SE7032-1.G50
	225	1PH7226-...D...-....	123.3 (92)	647 (880)	198	340	2000	4500	0.84	87.5	0.935	33.9	17.08 (1.93)	1653 (750)	218	6SE7032-6.G50
	225	1PH7228-...D...-....	151.5 (113)	794 (1080)	240	340	2000	4500	0.85	98	0.938	33.9	20.584 (2.326)	1896 (860)	262	6SE7032-2.G50

Converter

Inverter



Order No. suffix: see pages 3/16 to 3/17.

1) n_1 : motor speed at which, when $P = P_n$, there is still a power reserve of 30% before the stalling limit is reached or at which the mechanical speed limit is reached or at which the speed is limited by the SIMOVERT MASTERDRIVES Motion Control converter due to $f_{max} \leq 2 \cdot f_n$.

2) Warning! The maximum speed in field-weakening mode is sometimes limited to lower values due to $f_{max} \leq 2 \cdot f_n$ for SIMOVERT MASTERDRIVES Motion Control.

3) The **9th digit** in the Order No. is to be completed with the suffixes indicated below the table.

4) Typically stocked, see page 3/5 for available configuration.

* Listed Compact/Chassis units were selected for standard overload conditions (160% for 30 s at 300 s load cycle).

** For rated currents below 37.5 A Compact Plus units can also be used.

Asynchronous Servomotors



Asynchronous Servomotors

1PH7 Asynchronous servomotors

1PH7 Asynchronous servomotors - Selection and ordering example with SIMOVERT MASTERDRIVES Motion Control converters

Motor data (utilization to temperature rise class F)															Converter data	
Rated speed	Size	Motor	Rated power	Rated torque	Rated current	Rated voltage	Speed during field-weakening ¹⁾	Max. operating speed ²⁾	Power factor	Mag- netiz- ing cur- rent	Effi- ciency	Rated fre- quency	Moment of inertia	Weight	Rated cur- rent	Converter/ Inverter
n_n		Order No.	P_n HP (kW)	T_n lb _r -ft (Nm)	I_n	U_n	n_1	n_{max}	$\cos \varphi$	I_μ	η_n	f_n	J lb _r -in ² -s ² (kgm ²)	m lb (kg)	$I_n U$	Order No. ³⁾ *
rpm					A	V	rpm	rpm		A		Hz			A	
Mains voltage 3 AC 400 V for SIMOVERT MASTERDRIVES Motion Control converters and SIMODRIVE 611 universal																
1500	100	1PH7101...F... ⁴⁾	5 (3.7)	18 (24)	10	350	3000	9000	0.74	5.9	0.847	51.6	0.15 (0.017)	88 (40)	10.2	6SE7021-0.A51
	100	1PH7103...F... ⁴⁾	7.4 (5.5)	26 (35)	13	350	2100	9000	0.84	5.4	0.832	52.7	0.15 (0.017)	88 (40)	13.2	6SE7021-3.B51
	100	1PH7105...F... ⁴⁾	9.4 (7)	33 (45)	17.5	346	3000	9000	0.78	9.4	0.866	51.7	0.257 (0.029)	143 (65)	17.5	6SE7021-8.B51
	100	1PH7107...F... ⁴⁾	12.1 (9)	42 (57)	23.5	336	3000	9000	0.8	11	0.859	52	0.257 (0.029)	143 (65)	25.5	6SE7022-6.C51
	132	1PH7131...F... ⁴⁾	14.7 (11)	51 (70)	24	350	2900	8000	0.88	8.4	0.896	51.3	0.673 (0.076)	198 (90)	25.5	6SE7022-6.C51
	132	1PH7133...F... ⁴⁾	20.1 (15)	71 (96)	34	346	2500	8000	0.85	14	0.895	51.3	0.673 (0.076)	198 (90)	34	6SE7023-4.C65
	132	1PH7135...F... ⁴⁾	24.8 (18.5)	87 (118)	42	350	3000	8000	0.85	17	0.902	51.1	0.965 (0.109)	331 (150)	47	6SE7024-7.D51
	132	1PH7137...F... ⁴⁾	29.5 (22)	103 (140)	57	308	3000	8000	0.85	23	0.9	51.2	9.646 (0.109)	331 (150)	59	6SE7026-0.D51
	160	1PH7163...F... ⁴⁾	40.2 (30)	140 (191)	72	319	2000	6500	0.85	30	0.912	50.9	1.637 (0.185)	386 (175)	72	6SE7027-2..D50
	160	1PH7167...F... ⁴⁾	49.6 (37)	174 (236)	82	350	3000	6500	0.86	32	0.916	50.8	2.018 (0.228)	463 (210)	92	6SE7031-0.E50
	180	1PH7184...F... ⁴⁾	68.4 (51)	239 (325)	120	335	2000	5000	0.78	64	0.93	50.7	4.451 (0.503)	816 (370)	124	6SE7031-2..F50
	180	1PH7186...F... ⁴⁾	99.2 (74)	346 (471)	170	330	3000	5000	0.81	84	0.937	50.7	5.894 (0.666)	970 (440)	175	6SE7032-1.G50
	225	1PH7224...U... ⁴⁾	127.3 (95)	445 (605)	204	340	3000	4500	0.84	88.5	0.944	50.6	13.088 (1.479)	1389 (630)	218	6SE7032-6.G50
	225	1PH7226...F... ⁴⁾	174.3 (130)	609 (828)	278	340	3000	4500	0.84	120	0.945	50.6	17.08 (1.93)	1653 (750)	308	6SE7033-7.G50
	225	1PH7228...F... ⁴⁾	214.5 (160)	752 (1019)	350	340	3000	4500	0.82	169	0.949	50.5	20.585 (2.326)	1896 (860)	423	6SE7035-1EK50
2000	100	1PH7103...G... ⁴⁾	9.4 (7)	24 (33)	17.5	343	4000	9000	0.8	8.3	0.857	68.9	0.15 (0.017)	88 (40)	17.5	6SE7021-8.C51
	100	1PH7107...G... ⁴⁾	14.1 (10.5)	37 (50)	26	350	4000	9000	0.8	12	0.869	68.6	0.257 (0.029)	143 (65)	25.5	6SE7022-6.C51
	132	1PH7133...G... ⁴⁾	26.8 (20)	71 (96)	45	350	3900	8000	0.86	18	0.898	68	0.673 (0.076)	198 (90)	47	6SE7024-7.D51
	132	1PH7137...G... ⁴⁾	37.5 (28)	99 (134)	60	350	4000	8000	0.88	21	0.903	68	0.965 (0.109)	331 (150)	59	6SE7027-3.D51
	160	1PH7163...G... ⁴⁾	48.3 (36)	126 (172)	85	333	4000	6500	0.84	37	0.906	67.5	1.637 (0.185)	386 (175)	92	6SE7031-0.E50
	160	1PH7167...G... ⁴⁾	55 (41)	145 (196)	89	350	4000	6500	0.84	40	0.907	67.4	2.018 (0.228)	463 (210)	92	6SE7031-0.E50
2500	180	1PH7184...L... ⁴⁾	104.6 (78)	219 (298)	171	340	5000	5000	0.82	77	0.937	84.1	4.451 (0.503)	816 (370)	175	6SE7032-1.G50
	180	1PH7186...L... ⁴⁾	142.1 (106)	298 (405)	235	335	5000	5000	0.82	108	0.942	84.1	5.894 (0.666)	970 (440)	262	6SE7033-2.G50
	225	1PH7224...L... ⁴⁾	190.3 (142)	399 (542)	298	340	4500	4500	0.84	115	0.948	84	13.088 (1.479)	1389 (630)	308	6SE7033-7.G50
	225	1PH7226...L... ⁴⁾	225.2 (168)	474 (642)	362	335	4500	4500	0.84	154	0.95	84	17.08 (1.93)	1653 (750)	423	6SE7035-1EK50
	225	1PH7228...L... ⁴⁾	274.8 (205)	578 (783)	433	340	4500	4500	0.84	185	0.95	83.9	20.585 (2.326)	1896 (860)	491	6SE7036-0EK50

Converter
Inverter

E
T

Order No. suffix: see pages 3/16 to 3/17.

1) n_1 : motor speed at which, when $P = P_n$, there is still a power reserve of 30% before the stalling limit is reached or at which the mechanical speed limit is reached or at which the speed is limited by the SIMOVERT MASTERDRIVES Motion Control converter due to $f_{max} \leq 2 \cdot f_n$.

2) Warning! The maximum speed in field-weakening mode is sometimes limited to lower values due to $f_{max} \leq 2 \cdot f_n$ for SIMOVERT MASTERDRIVES Motion Control.
3) The 9th digit in the Order No. is to be completed with the suffixes indicated below the table.
4) Typically stocked, see page 3/5 for available configuration.

* Listed Compact/Chassis units were selected for standard overload conditions (160% for 30 s at 300 s load cycle).
** For rated currents below 37.5 A Compact Plus units can also be used.

Asynchronous Servomotors

Asynchronous Servomotors



1PH7 Asynchronous servomotors

1PH7 Asynchronous servomotors - Selection and ordering example with SIMOVERT MASTERDRIVES Motion Control converters

Motor data (utilization to temperature rise class F)														Converter data		
Rated speed	Size	Motor	Rated power	Rated torque	Rated current	Rated voltage	Speed during field-weakening ¹⁾	Max. operating speed ²⁾	Power factor	Magnetizing current	Efficiency	Rated frequency	Moment of inertia	Weight	Rated current	Converter/ Inverter
n_n rpm		Order No.	P_n HP (kW)	τ_n lb _f -ft (Nm)	I_n A	U_n V	n_1 rpm	n_{max} rpm	$\cos \varphi$	I_μ A	η_n	f_n Hz	J lb _f -in ² -s ² (kgm ²)	m lb (kg)	$I_n U$ A	Order No. ³⁾ *
Mains voltage 3 AC 480 V for SIMOVERT MASTERDRIVES Motion Control converters and SIMODRIVE 611 universal																
400	160	1PH7163-...B...-....	12.7 (9.5)	167 (227)	30	274	800	6500	0.88	11.5	0.809	14.3	1.637 (0.185)	386 (175)	34	6SE7023-4.C51
	160	1PH7167-...B...-....	17.4 (13)	228 (310)	37	294	800	6500	0.88	14	0.814	14.3	2.018 (0.228)	463 (210)	37.5	6SE7023-8.D51
	180	1PH7184-...B...-....	21.8 (16.3)	287 (390)	51	271	800	5000	0.84	26	0.83	14.2	4.451 (0.503)	816 (370)	59	6SE7026-0.D51
	180	1PH7186-...B...-....	28.4 (21.2)	372 (505)	67	268	800	5000	0.81	38.5	0.845	14	5.363 (0.666)	970 (440)	72	6SE7027-2.D51
	225	1PH7224-...B...-....	40.8 (30.4)	533 (725)	88	268	800	4500	0.87	36.5	0.864	14	13.088 (1.479)	1389 (630)	92	6SE7031-0.E50
	225	1PH7226-...B...-....	52.5 (39.2)	688 (935)	114	264	800	4500	0.86	49	0.88	14	17.08 (1.93)	1653 (750)	124	6SE7031-2.F50
	225	1PH7228-...B...-....	64.3 (48)	842 (1145)	136	272	800	4500	0.85	60.5	0.888	13.9	20.584 (2.326)	1896 (860)	155	6SE7031-8.F50
1150	100	1PH7103-...D...-....⁴⁾	5.8 (4.3)	26 (36)	10	391	2200	9000	0.81	5	0.813	40.6	0.15 (0.017)	88 (40)	10.2	6SE7021-0.A51
	100	1PH7107-...D...-....⁴⁾	9.7 (7.2)	44 (60)	17.5	360	2300	9000	0.81	8.8	0.838	40.3	0.257 (0.029)	143 (65)	17.5	6SE7021-8.B51
	132	1PH7133-...D...-....⁴⁾	18.1 (13.5)	82 (112)	29	381	2300	8000	0.85	13	0.877	39.7	0.673 (0.076)	198 (90)	34	6SE7023-4.C51
	132	1PH7137-...D...-....⁴⁾	26.1 (19.5)	119 (162)	43	367	2300	8000	0.86	19	0.887	39.6	0.965 (0.109)	331 (150)	47	6SE7024-7.D51
	160	1PH7163-...D...-....⁴⁾	33.5 (25)	153 (208)	55	364	2300	6500	0.84	25	0.904	39.2	1.637 (0.185)	386 (175)	59	6SE7026-0.D51
	160	1PH7167-...D...-....⁴⁾	41.6 (31)	189 (257)	70	357	2300	6500	0.83	34	0.909	39.1	2.018 (0.228)	436 (210)	72	6SE7027-2.D51
	180	1PH7184-...D...-....	59 (44)	269 (366)	89	383	2300	5000	0.83	42	0.92	39.2	4.451 (0.503)	816 (370)	92	6SE7031-0.E50
	180	1PH7186-...D...-....	77.7 (58)	354 (482)	116	390	2300	5000	0.81	58	0.925	39.1	5.894 (0.666)	970 (440)	124	6SE7031-2.F50
	225	1PH7224-...D...-....	108.6 (81)	346 (670)	160	385	2300	4500	0.81	79	0.938	38.9	13.088 (1.479)	1389 (630)	175	6SE7031-1.G50
	225	1PH7226-...D...-....	140.8 (105)	640 (870)	197	390	2300	4500	0.84	87.5	0.941	38.9	17.08 (1.93)	1653 (750)	218	6SE7032-6.G50
	225	1PH7228-...D...-....	172.9 (129)	787 (1070)	228	390	2300	4500	0.85	98	0.943	38.9	20.584 (2.326)	1896 (860)	262	6SE7032-2.G50

Converter
Inverter



Order No. suffix: see pages 3/16 to 3/17.

1) n_1 : motor speed at which, when $P = P_n$, there is still a power reserve of 30% before the stalling limit is reached or at which the mechanical speed limit is reached or at which the speed is limited by the SIMOVERT MASTERDRIVES Motion Control converter due to $f_{max} \leq 2 \cdot f_n$.

2) Warning! The maximum speed in field-weakening mode is sometimes limited to lower values due to $f_{max} \leq 2 \cdot f_n$ for SIMOVERT MASTERDRIVES Motion Control.

3) The 9th digit in the Order No. is to be completed with the suffixes indicated below the table.

4) Typically stocked, see page 3/5 for available configuration.

* Listed Compact/Chassis units were selected for standard overload conditions (160% for 30 s at 300 s load cycle).

** For rated currents below 37.5 A Compact Plus units can also be used.

Asynchronous Servomotors



Asynchronous Servomotors

1PH7 Asynchronous servomotors

1PH7 Asynchronous servomotors - Selection and ordering example with SIMOVERT MASTERDRIVES Motion Control converters

Motor data (utilization to temperature rise class F)														Converter data		
Rated speed	Size	Motor	Rated power	Rated torque	Rated current	Rated voltage	Speed during field-weakening ¹⁾	Max. operating speed ²⁾	Power factor	Magnetizing current	Efficiency	Rated frequency	Moment of inertia	Weight	Rated current	Converter/ Inverter
n_n rpm		Order No.	P_n HP (kW)	τ_n lb _f -ft (Nm)	I_n A	U_n V	n_1 rpm	n_{max} rpm	$\cos \varphi$	I_μ A	η_n	f_n Hz	J lb _f -in ² -s ² (kgm ²)	m lb (kg)	$I_n U$ A	Order No. ³⁾ *
Mains voltage 3 AC 480 V for SIMOVERT MASTERDRIVES Motion Control converters and SIMODRIVE 611 universal																
1750	100	1PH7101-...F... ⁴⁾	5.8 (4.3)	18 (24)	10	398	3500	9000	0.75	5.7	0.855	60	0.15 (0.017)	88 (40)	10.2	6SE7021-0.A51
	100	1PH7103-...F... ⁴⁾	8.4 (6.25)	25 (34)	13	398	2600	9000	0.84	5.3	0.849	61	0.15 (0.017)	88 (40)	13.2	6SE7021-3.B51
	100	1PH7105-...F... ⁴⁾	10.7 (8)	32 (44)	17.5	398	3500	9000	0.77	9.3	0.875	60	0.257 (0.029)	143 (65)	17.5	6SE7022-8.B51
	100	1PH7107-...F... ⁴⁾	13.4 (10)	40 (55)	23	381	3500	9000	0.80	10.6	0.87	60.3	0.257 (0.029)	143 (65)	25.5	6SE7022-6.C51
	132	1PH7131-...F... ⁴⁾	17.4 (13)	52 (71)	24	398	3300	8000	0.88	8.1	0.902	59.7	0.673 (0.076)	198 (90)	25.5	6SE7022-6.C51
	132	1PH7133-...F... ⁴⁾	23.5 (17.5)	71 (96)	34	398	3400	8000	0.85	14	0.9	59.7	0.673 (0.076)	198 (90)	34	6SE7023-4.C51
	132	1PH7135-...F... ⁴⁾	28.8 (21.5)	86 (117)	42	398	3500	8000	0.86	16	0.906	59.5	0.965 (0.109)	331 (150)	47	6SE7024-7.D51
	132	1PH7137-...F... ⁴⁾	33.5 (25)	100 (136)	56	357	3500	8000	0.85	23	0.902	59.5	0.965 (0.109)	331 (150)	59	6SE7026-0.D51
	160	1PH7163-...F... ⁴⁾	45.6 (34)	136 (186)	72	364	3500	6500	0.86	28	0.915	59.2	1.637 (0.185)	386 (175)	72	6SE7027-2.D51
	160	1PH7167-...F... ⁴⁾	55 (41)	165 (224)	79	398	3500	6500	0.86	30	0.92	59.2	2.018 (0.228)	463 (210)	92	6SE7031-0.E50
	180	1PH7184-...F... ⁴⁾	80.4 (60)	240 (327)	120	388	3500	5000	0.78	64	0.934	59	4.451 (0.503)	816 (370)	124	6SE7031-2.F50
	180	1PH7186-...F... ⁴⁾	113.9 (85)	342 (465)	169	385	3500	5000	0.8	84	0.94	59	5.894 (0.666)	970 (440)	186	6SE7032-1.G50
	225	1PH7224-...U... ⁴⁾	147.5 (110)	441 (600)	203	395	3500	4500	0.84	88	0.944	58.9	13.088 (1.479)	1389 (630)	210	6SE7032-6.G50
	225	1PH7226-...F... ⁴⁾	181 (135)	542 (737)	254	395	3500	4500	0.82	120	0.947	58.9	17.08 (1.93)	1653 (750)	262	6SE7032-2.G50
	225	1PH7228-...F... ⁴⁾	240 (179)	719 (975)	342	395	3500	4500	0.81	169	0.948	58.8	20.585 (2.326)	1896 (860)	423	6SE7035-1EK50
	2300	100	1PH7103-...G... ⁴⁾	10.1 (7.5)	23 (31)	17	388	4600	9000	0.79	8.2	0.866	78.8	0.15 (0.017)	88 (40)	17.5
100		1PH7107-...G... ⁴⁾	16.1 (12)	37 (50)	26	400	4600	9000	0.8	12	0.878	78.7	0.257 (0.029)	143 (65)	25.5	6SE7022-6.C51
132		1PH7133-...G... ⁴⁾	30.2 (22.5)	68 (93)	45	398	4600	8000	0.86	17	0.9	78.7	0.673 (0.076)	198 (90)	47	6SE7024-7.D51
132		1PH7137-...G... ⁴⁾	38.9 (29)	88 (120)	56	398	4600	8000	0.87	21	0.903	78	0.965 (0.109)	331 (150)	59	6SE7026-0.D51
160		1PH7163-...G... ⁴⁾	50.9 (38)	116 (158)	82	398	4600	6500	0.78	43	0.9	77.3	1.637 (0.185)	386 (175)	92	6SE7031-0.E50
160		1PH7167-...G... ⁴⁾	60 (44)	135 (183)	85	398	4600	6500	0.84	40	0.911	77.4	2.018 (0.228)	463 (210)	92	6SE7031-0.E50
2900	180	1PH7184-...L... ⁴⁾	108.6 (81)	195 (265)	158	395	5000	5000	0.8	77	0.934	97.4	4.451 (0.503)	816 (370)	175	6SE7032-1.G50
	180	1PH7186-...L... ⁴⁾	135.4 (101)	245 (333)	206	385	5000	5000	0.78	107	0.936	97.3	5.894 (0.666)	970 (440)	218	6SE7032-6.G50
	225	1PH7224-...L... ⁴⁾	199.7 (149)	360 (490)	274	395	4500	4500	0.84	115	0.946	97.3	13.088 (1.479)	1389 (630)	308	6SE7033-7.G50
	225	1PH7226-...L... ⁴⁾	248 (185)	450 (610)	348	390	4500	4500	0.84	154	0.947	97.2	17.081 (1.93)	1654 (750)	423	6SE7035-1EK50
	225	1PH7228-...L... ⁴⁾	288 (215)	522 (708)	402	395	4500	4500	0.82	186	0.946	97.2	20.585 (2.326)	1896 (860)	491	6SE7036-0EK50

Converter

Inverter

E
T

Order No. suffix: see pages 3/16 to 3/17.

1) n_1 : motor speed at which, when $P = P_n$, there is still a power reserve of 30% before the stalling limit is reached or at which the mechanical speed limit is reached or at which the speed is limited by the SIMOVERT MASTERDRIVES Motion Control converter due to $f_{max.} \leq 2 \cdot f_n$.

2) Warning! The maximum speed in field-weakening mode is sometimes limited to lower values due to $f_{max} \leq 2 \cdot f_n$ for SIMOVERT MASTERDRIVES Motion Control.

3) The 9th digit in the Order No. is to be completed with the suffixes indicated below the table.

4) Typically stocked, see page 3/5 for available configuration.

* Listed Compact/Chassis units were selected for standard overload conditions (160% for 30 s at 300 s load cycle).

Asynchronous Servomotors

Asynchronous Servomotors



1PH7 Asynchronous servomotors

1PH7 Asynchronous servomotors - Order No. suffix for sizes 100 to 160

	1	2	3	4	5	6	7	8	9	10	11	12	13	14	15	16
Blower																
With blower, mains supply voltage 3 AC 400 V ± 10%, 50/60 Hz; 480 V +5% -10%, 60 Hz																
Without blower, for pipe connection																
Encoder																
Without encoder																
Absolute-value encoder (EnDat) (2048 p/r)																
Incremental encoder HTL (1024 p/r)																
Incremental encoder HTL (2048 p/r)																
sin/cos incremental encoder 1 V _{pp} (without C-track and D-track)																
sin/cos incremental encoder 1 V _{pp} (with C-track and D-track)																
2-pole resolver																
Direction of cable entry (terminal box on top, looking at D-end)																
From the right																
From ND-end																
From the left																
Type of construction (see page 7/36)																
IM B 3, IM V 5, IM V 6																
IM B 5, IM V 1, IM V 3 (only sizes 100 and 132)																
IM B 35, IM V 15, IM V 36																
Holding brake with emergency-stop function ¹⁾																
No brake																
Brake supply voltage: 230 V AC, 50 to 60 Hz																
With brake																
With brake (brake with microswitch)																
With brake (brake with manual release)																
With brake (brake with manual release and microswitch)																
Brake supply voltage: 24 V DC																
With brake																
With brake (brake with microswitch)																
With brake (brake with manual release)																
With brake supply (brake with manual release and microswitch)																
Type of drive																
Coupling and belt																
Coupling and belt																
Coupling and belt																
Coupling and belt																
Increased max. speed ²⁾																
Air-flow direction																
D-end → ND-end																
ND-end → D-end																
D-end → ND-end																
ND-end → D-end																
D-end → ND-end																
ND-end → D-end																
Paint finish																
Without																
Without, oil-tight flange with radial shaft seal ring ³⁾																
Anthracite, normal coating (RAL 7016)																
Anthracite, normal coating (RAL 7016), oil-tight flange with radial shaft seal ring ³⁾																
Anthracite, special coating (RAL 7016)																
Anthracite, special coating (RAL 7016), oil-tight flange with radial shaft seal ring ³⁾																

1) Version with brake:
12th data digit "2" or "3",
14th data digit "K",
15th data digit "A", "B", "J" or "K",
16th data digit "0", "3" or "6".

2) Max. possible speed
Size 100: 12,000 rpm
Size 132: 10,000 rpm
Size 160: 8,000 rpm
Only with smooth shaft
(15th data digit "J" or "K").

3) Version prepared for ZF gear-change unit mounting
12th data digit "2" or "3"
13th data digit "0"
14th data digit "B"
15th data digit "C" or "D"
16th data digit "2", "5" or "8"
No build-up of fluid permitted at the shaft exit.

For notes on gearbox mounting, see Chapter 4.

Asynchronous Servomotors



Asynchronous Servomotors

1PH7 Asynchronous servomotors

1PH7 Asynchronous servomotors - Order No. suffix for sizes 180 and 225

	1	2	3	4	5	6	7	8	9	10	11	12	13	14	15	16
Blower																
With blower, mains supply voltage 3 AC 400 V ± 10%, 50 Hz; 480 V +5% -10%, 60 Hz																
Without blower, for pipe connection																
Encoder																
Without encoder																
Absolute-value encoder (EnDat) (2048 p/r)																
Incremental encoder HTL (1024 p/r)																
Incremental encoder HTL (2048 p/r)																
sin/cos incremental encoder 1 V _{pp} (without C-track and D-track)																
sin/cos incremental encoder 1 V _{pp} (with C-track and D-track)																
2-pole resolver																
Direction of cable entry (terminal box on top, looking at D-end)																
From the right																
From D-end																
From ND-end																
From the left																
Type of construction (see page 7/36)																
IM B 3																
IM B 6, IM B 7, IM B 8, IM V 5, IM V 6																
IM B 35 (only for 1PH7184 with flange A400)																
IM B 35 (only for 1PH7184 with flange A450)																
IM B 35 (for 1PH7186 with flange A450 and 1PH722. with flange A550)																
IM B 36, IM V 15 (only for 1PH7184 with flange A400)																
IM V 36, IM V 15 (only for 1PH7184 with flange A450)																
IM V 36, IM V 15 (for 1PH7186 with flange A450 and 1PH722. with flange A550)																
Holding brake with emergency-stop function (suitable for coupling drive in IM B 3 type of construction) ¹⁾																
No brake																
With brake (brake with emergency release screws and microswitch)																
With brake (brake with manual release and microswitch)																
Type of drive																
Coupling																
Coupling																
Coupling																
Coupling																
Belt																
Belt																
Increased lateral forces																
Increased lateral forces																
Design for increased max. speed ³⁾																
Air-flow direction																
D-end → ND-end																
D-end → ND-end																
D-end → ND-end																
ND-end → D-end																
ND-end → D-end																
ND-end → D-end																
Paint finish																
Primed																
Primed, prepared for ZF gear mounting ²⁾																
Anthracite, normal coating (RAL 7016)																
Anthracite, normal coating (RAL 7016), prepared for ZF gear mounting ²⁾																
Anthracite, special coating (RAL 7016)																
Anthracite, special coating (RAL 7016), prepared for ZF gear mounting ²⁾																

1) Version with brake:
12th data digit "0",
14th and 15th data digits "A" and
16th data digit "0", "3" or "6".

2) Version prepared for ZF gear mounting:
only for types 1PH7184, 186 and 224,
12th data digit "3" or "5",
13th data digit "0",
14th data digit "B", 15th data digit "C",
16th data digit "2", "5" or "8",
No build-up of fluid at shaft exit permissible.

3) For size 180 $n_{max} = 7,000$ rpm
1PH7224 $n_{max} = 5,500$ rpm
For notes on gearbox mounting, see Chapter 4.

Asynchronous Servomotors

Asynchronous Servomotors



1PH7 Asynchronous servomotors

1PH7 Asynchronous servomotors - Order No. suffix for size 280 (available soon)

	1	2	3	4	5	6	7	8	9	10	11	12	13	14	15	16
Blower, mains supply voltage 3 AC 400 V +/-10%, 50/60 Hz; 480 V +/-10%, 60 Hz																
With separate blower, ND-end top, direction of air flow ND-end to D-end									0							
With separate blower, ND-end right, direction of air flow ND-end to D-end									1							
With separate blower, ND-end left, direction of air flow ND-end to D-end									2							
Without separate blower, for single pipe connection to ND-end									6							
Encoder																
Without encoder									A							
Incremental encoder HTL (1024 p/r)									H							
Incremental encoder HTL (2048 p/r)									J							
Terminal box/direction of cable entry (looking at D-end)																
Terminal box ND-end right / cable entry below/encoder connector on D-end ¹⁾									0							
Terminal box ND-end left / cable entry below/encoder connector on D-end ²⁾									1							
Terminal box ND-end top / cable entry right/encoder connector on D-end ³⁾									2							
Type of construction (see page 7/36)																
IM B 3									0							
IM B 6, IM B 7, IM B 8, IM V 5, IM V 6									1							
IM B 35 (with flange A660)									3							
IM V 36, IM V 15 (with flange A660)									5							
Type of drive																
Coupling									N							
Coupling									R							
Belt, increased lateral forces									N							
Belt, increased lateral forces									R							
Shaft and flange accuracy																
Shaft extension																
With featherkey, half-key balancing																A
With featherkey, full-key balancing																C
Smooth																J
Paint finish																
Primed																0
Anthracite, normal coating (RAL 7016)																3
Anthracite, special coating (RAL 7016)																6

3

1) Only possible for 8th data digit "0", "2", "6".

2) Only possible for 8th data digit "0", "1", "6".

3) Only possible for 8th data digit "1", "2", "6".



Asynchronous Servomotors

Asynchronous Servomotors

1PL6 Asynchronous servomotors

Technical data



Fig. 3/5
1PL6 three-phase motors,
frame sizes 180 and 225

Technical characteristics

The 1PL6 three-phase servomotors are compact, separately-cooled asynchronous motors with additional axial ventilation and with degree of protection IP 23.

They are especially characterized by the following properties:

- extremely high power density with low physical volume (50% more power compared to 1PH7 motors with degree of protection IP 55)
- speed down to zero without torque reduction
- robustness
- low maintenance requirements
- high lateral-force withstand capability
- high level of concentricity even at lowest speeds
- integrated encoder system for detecting motor speed detection, plug connection
- terminal box for connecting the power cable
- KTY 84 motor temperature monitoring.

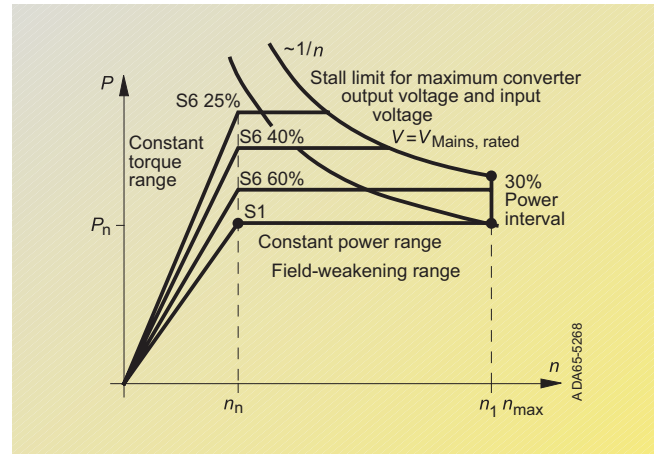

Fig. 3/6
Power-speed characteristic

IP 23 degree of protection

The three-phase induction motors of Series 1PL6 are rotor-cooled and stator-cooled by means of open-circuit cooling. A built-on separately-driven fan unit is implemented as standard for cooling.

The motors comply with the DIN standards and the IP 23 degree of protection according to EN 60034-5 (or IEC 60034-5). With this degree of protection, the motors are not suitable for operation in corrosive atmospheres or for installation outdoors.

1PL6 motors, frame sizes 180 and 225

	Standard	Options
Type of construction	IM B 3	IM B 35
Degree of protection	IP 23	–
Vibration severity	R	S SR
Shaft and flange accuracy	N	R
Shaft extension	With featherkey, half-key balancing	Smooth shaft extension With featherkey, full-key balancing
Terminal box	On top, cable entry from the right	Cable entry from D-end, ND-end or the left
Motor protection	KTY 84, in the stator winding	–
Encoder system (plug connection)	Incremental encoder HTL (for use with SIMOVERT VC and MC)	Without encoder (for use with SIMOVERT VC) sin/cos incremental encoder 1 V_{pp} (for use with SIMOVERT MC and SIMODRIVE 611 universal) Absolute-value encoder (EnDat) 2048 p/r (for use with SIMOVERT MC and SIMODRIVE 611 universal)
Paint finish	Normal coating anthracite RAL 7016	Primed Special paint finish "worldwide" RAL 7016
Bearings	Permanently lubricated deep-groove ball bearing for coupling drives	Cylindrical roller bearing for belt drives Cylindrical roller bearing for increased lateral forces
Cooling	Separate ventilation and axial ventilation Axial fan on ND-end Air-flow direction from D-end to ND-end	(without separate fan, pipe connection on request) (air-flow direction from ND-end to D-end on request)
Silencer	–	Silencer for reducing the sound pressure level (retrofit also possible)

Asynchronous Servomotors

Asynchronous Servomotors



1PL6 Asynchronous servomotors

Technical data



Fig. 3/7
1PL6 three-phase motors,
frame size 280

Technical characteristics

The newly developed asynchronous motors of size 280 expand the performance range of the compact asynchronous servomotors of Series 1PL6. The new size is characterized, in particular, by its compact construction despite enhanced performance and consistent emphasis on suitability for use in production machines.

- extremely high power/weight ratio for minimal overall volume (60% more power than 1PH7 to the IP 55 degree of protection)
- variable ventilation design; Standard: Fan unit at non-drive-end
- simple external ventilation by means of connected hose
- terminal box either above, left or right (non-drive-end) as required
- integrated encoder system for sensing the motor speed, connected with connector on terminal box
- monitoring the motor temperature by means of KTY 84; additional KTY 84 as spare part
- bearings with relubricating mechanism and insulated bearing as standard (non-drive-end)

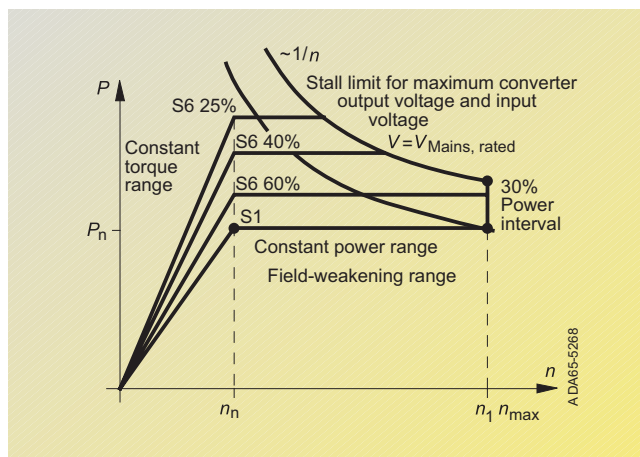

Fig. 3/8
Power-speed characteristic

Applications for 1PL6 motors

Installation in dry indoor locations (no aggressive atmosphere)

Hoisting equipment:

- hoists and closing gear for cranes

Printing industry:

- main drives for printing machines

Rubber, plastic and wire:

- drives for extrudes, calenders, rubber-spraying systems, film machines, conveyor systems

- wire-drawing machines, cable stranding machines etc.

General applications such as winding and coiling machines.

1PL6 motors, frame size 280¹⁾

	Standard	Options
Type of construction	IM B 3	IM B 35
Degree of protection	IP 55	–
Vibration severity	N	R
Shaft and flange accuracy	N	R
Shaft extension	With featherkey, half-key balancing	Smooth shaft extension With featherkey, full-key balancing
Terminal box	On the right (ND-end), cable entry from below, encoder connector on D-end	On the left (ND-end), cable entry from below, encoder connector on D-end On top (ND-end), in the case of a fan ND-end left or right, cable entry from the right, encoder connector on D-end, D-end on request
Motor protection	KTY 84, in the stator winding	–
Encoder system (plug connection)	Incremental encoder HTL (with SIMOVERT VC)	Without encoder (MASTERDRIVES VC), other encoders on request
Paint finish	Normal coating anthracite RAL 7016	Primed Special paint finish, "worldwide" RAL 7016, other colors on request
Bearings	Bearing concept for coupling drive with relubricating device	Bearing concept for belt drive or increased lateral forces with relubricating device
Cooling	Separate ventilation, the fan is axially mounted on the ND-end, air flow ND-end to D-end	Without separate fan, for single pipe connection Fan ND-end left or right Fan radially mounted on the D-end (air flow from D-end to ND-end) on request

1) Available soon.

Asynchronous Servomotors



Asynchronous Servomotors

1PL6 Asynchronous servomotors

1PL6 Asynchronous servomotors - Selection and ordering example with SIMOVERT MASTERDRIVES Vector Control converters

Motor data (utilization to temperature rise class F)													Converter data			
Rated speed	Size	Motor	Rated power	Rated torque	Rated current	Rated voltage	Speed during field-weakening ¹⁾	Max. operating speed ²⁾	Power factor	Magnetizing current	Efficiency	Rated frequency	Moment of inertia	Weight	Rated current	Converter/ Inverter
n_n rpm		Order No.	P_n HP (kW)	τ_n lb _f -ft (Nm)	I_n A	U_n V	n_1 rpm	n_{max} rpm	$\cos \varphi$	I_μ A	η_n	f_n Hz	J lb _f -in ² -s ² (kgm ²)	m lb (kg)	I_{nU} A	Order No. ³⁾ *
Mains voltage 3 AC 400 V for SIMOVERT MASTERDRIVES Vector Control converters																
400	180	1PL6184...B...0...	32.8 (24.5)	430 (585)	69	300	1000	5000	0.86	33	0.8	14.4	4.451 (0.503)	816 (370)	72	6SE7027-2.D61
	180	1PL6186...B...0...	42.2 (31.5)	553 (752)	90	290	1400	5000	0.85	47	0.814	14.3	5.894 (0.666)	970 (440)	92	6SE7031-0.E60
	225	1PL6224...B...0...	60.3 (45)	790 (1074)	117	300	1150	4500	0.87	45	0.844	14.2	13.088 (1.479)	1389 (630)	124	6SE7031-2.F60
	225	1PL6226...B...0...	76.4 (57)	1001 (1361)	145	305	1400	4500	0.85	67	0.868	14	17.08 (1.93)	1653 (750)	146	6SE7031-5.F60
	225	1PL6228...B...0...	96.5 (72)	1264 (1719)	181	305	1300	4500	0.86	77	0.871	14	20.584 (2.326)	1896 (860)	186	6SE7031-8.F60
1150	180	1PL6184...D...0...	87.1 (65)	397 (540)	121	400	1750	5000	0.86	46	0.906	39.4	4.451 (0.503)	816 (370)	124	6SE7031-2.F60
	180	1PL6186...D...0...	113.9 (85)	519 (706)	158	400	1950	5000	0.86	62	0.91	39.4	5.894 (0.666)	970 (440)	186	6SE7031-8.F60
	225	1PL6224...D...0...	160.9 (120)	733 (997)	218	400	2100	4500	0.85	86	0.93	39.1	13.088 (1.479)	1389 (630)	260	6SE7032-6.G60
	225	1PL6226...D...0...	207.8 (155)	946 (1287)	275	400	2000	4500	0.87	92	0.93	39.2	17.08 (1.93)	1653 (750)	315	6SE7033-2.G60
	225	1PL6228...D...0...	254.7 (190)	1160 (1578)	334	400	1850	4500	0.88	102	0.931	39.2	20.584 (2.326)	1896 (860)	370	6SE7033-7.G60
	280	1PL6284...D...0...	275 (280)	1715 (2325)	478	400	2400	3300	0.89	156	0.95	38.9	37.169 (4.2)	2867 (1300)	510	6SE7035-1.K/J60
	280	1PL6286...D...0...	476 (355)	2171 (2944)	637	380	2450	3300	0.89	214	0.953	38.9	40.019 (5.2)	3308 (1500)	690	6SE7037-0.K/J60
280	1PL6288...D...0...	583 (435)	2661 (3607)	765	385	2450	3300	0.89	248	0.955	38.9	55.754 (6.3)	3749 (1700)	860	6SE7038-6TK60	
1750	180	1PL6184...F...0...	119.3 (89)	357 (486)	166	400	3500	5000	0.84	68	0.921	59.3	4.451 (0.503)	816 (370)	186	6SE7031-8.F60
	180	1PL6186...F...0...	167.6 (125)	501 (682)	231	400	3400	5000	0.84	92	0.935	59.3	5.894 (0.666)	970 (440)	260	6SE7032-6.G60
	225	1PL6224...F...0...	221.2 (165)	662 (900)	292	400	3000	4500	0.87	90	0.942	59.2	13.088 (1.479)	1389 (630)	315	6SE7033-2.G60
	225	1PL6226...F...0...	268.1 (200)	802 (1091)	350	400	3550	4500	0.87	122	0.942	59.1	17.08 (1.93)	1653 (750)	370	6SE7033-7.G60
	225	1PL6228...F...0...	355 (265)	1066 (1446)	470	400	3700	4500	0.86	174	0.948	59	20.584 (2.326)	1896 (860)	510	6SE7035-1.K/J60
	280	1PL6284...F...0...	496 (370)	1489 (2019)	616	400	3250	3300	0.9	162	0.959	59	37.169 (4.2)	2867 (1300)	690	6SE7037-0.K/J60
	280	1PL6286...F...0...	597 (445)	1792 (2429)	736	400	3250	3300	0.91	182	0.96	59	40.019 (5.2)	3308 (1500)	860	6SE7038-6TK60
280	1PL6288...F...0...	751 (560)	2253 (3055)	924	400	3300	3300	0.91	232	0.962	59	55.754 (6.3)	3749 (1700)	1100	6SE7041-1TK60	
2900	180	1PL6184...L...0...	151.5 (113)	274 (372)	209	400	5000	5000	0.85	79	0.938	97.6	4.451 (0.503)	816 (370)	210	6SE7032-1.G60
	180	1PL6186...L...0...	201.1 (150)	363 (494)	280	390	5000	5000	0.84	110	0.943	97.5	5.894 (0.666)	970 (440)	315	6SE7033-2.G60
	225	1PL6224...L...0...	274.8 (205)	496 (675)	365	400	4500	4500	0.86	118	0.95	97.5	13.088 (1.479)	1389 (630)	370	6SE7033-7.G60
	225	1PL6226...L...0...	362 (270)	656 (889)	470	400	4500	4500	0.87	160	0.952	97.4	17.08 (1.93)	1653 (750)	510	6SE7035-1.K/J60
	225	1PL6228...L...0...	402 (300)	729 (988)	530	400	4500	4500	0.86	188	0.952	97.3	20.584 (2.326)	1896 (860)	590	6SE7036-0.K/J60

Converter

Inverter



Order No. suffix: see pages 3/25 and 3/26.

1) n_1 : Speed at which, for $P = P_n$, 30% reserve power is still available before reaching the stall limit.

2) Warning! The maximum speed in field-weakening mode is sometimes limited to lower values due to $f_{max} < 5 \cdot f_n$.

3) The 9th digit in the Order No. is to be completed with the suffixes indicated below the table.

* Listed Compact/Chassis units were selected for standard overload conditions (160% for 30 s at 300 s load cycle).

Asynchronous Servomotors

Asynchronous Servomotors



1PL6 Asynchronous servomotors

1PL6 Asynchronous servomotors - Selection and ordering example with SIMOVERT MASTERDRIVES Vector Control converters

Motor data (utilization to temperature rise class F)													Converter data			
Rated speed	Size	Motor	Rated power	Rated torque	Rated current	Rated voltage	Speed during field-weakening ¹⁾	Max. operating speed ²⁾	Power factor	Magnetizing current	Efficiency	Rated frequency	Moment of inertia	Weight	Rated current	Converter/ Inverter
n_n			P_n	τ_n	I_n	U_n	n_1	n_{max}	$\cos \varphi$	I_μ	η_n	f_n	J	m	I_{nU}	
rpm		Order No.	HP (kW)	lb _f -ft (Nm)	A	V	rpm	rpm		A		Hz	lb _f -in ₂ -s ² (kgm ²)	lb (kg)	A	Order No. ³⁾ *
Mains voltage 3 AC 480 V for SIMOVERT MASTERDRIVES Vector Control converters																
500	180	1PL6184...B...0...	40.2 (30)	421 (573)	66	370	1300	5000	0.84	34	0.844	17.6	4.451 (0.503)	816 (370)	72	6SE7027-2.D61
	180	1PL6186...B...0...	53.6 (40)	562 (764)	91	355	1500	5000	0.84	46	0.845	17.6	5.894 (0.666)	970 (440)	92	6SE7031-0.E60
	225	1PL6224...B...0...	73.7 (55)	772 (1050)	114	370	1300	4500	0.86	46	0.875	17.5	13.088 (1.479)	1389 (630)	124	6SE7031-2.F60
	225	1PL6226...B...0...	96.5 (72)	1011 (1375)	147	375	1500	4500	0.85	66	0.887	17.4	17.08 (1.93)	1653 (750)	146	6SE7031-5.F60
	225	1PL6228...B...0...	120.6 (90)	1264 (1719)	180	380	1400	4500	0.85	79	0.894	17.4	20.584 (2.326)	1896 (860)	186	6SE7031-8.F60
1350	180	1PL6184...D...0...	99.2 (74)	385 (523)	119	460	2200	5000	0.86	44	0.918	46.1	4.451 (0.503)	816 (370)	124	6SE7031-2.F60
	180	1PL6186...D...0...	131.4 (98)	510 (693)	156	460	2400	5000	0.85	60	0.92	46	5.894 (0.666)	970 (440)	186	6SE7031-8.F60
	225	1PL6224...D...0...	183.6 (137)	713 (969)	215	460	2600	4500	0.85	82	0.94	45.8	13.088 (1.479)	1389 (630)	260	6SE7032-6.G60
	225	1PL6226...D...0...	230.6 (172)	895 (1217)	265	460	2500	4500	0.87	88	0.94	45.8	17.08 (1.93)	1653 (750)	315	6SE7033-2.G60
	225	1PL6228...D...0...	292 (218)	1134 (1542)	332	460	2200	4500	0.88	100	0.938	45.8	20.584 (2.326)	1896 (860)	370	6SE7033-7.G60
	280	1PL6284...D...0...	436 (325)	1696 (2299)	478	470	2850	3300	0.89	157	0.955	45.5	37.169 (4.2)	2867 (1300)	510	6SE7035-1.K/J60
	280	1PL6286...D...0...	550 (410)	2140 (2901)	637	445	2950	3300	0.89	215	0.957	45.5	40.019 (5.2)	3308 (1500)	690	6SE7037-0.K/J60
	280	1PL6288...D...0...	677 (505)	2635 (3573)	765	450	2950	3300	0.89	248	0.959	45.5	55.754 (6.3)	3749 (1700)	860	6SE7038-6TK60
2000	180	1PL6184...F...0...	131.4 (98)	344 (468)	161	460	4200	5000	0.83	70	0.934	67.5	4.451 (0.503)	816 (370)	186	6SE7031-8.F60
	180	1PL6186...F...0...	181 (135)	474 (645)	220	460	4200	4500	0.83	94	0.94	67.5	5.894 (0.666)	970 (440)	260	6SE7032-6.G60
	225	1PL6224...F...0...	238.6 (178)	625 (850)	275	460	3800	4500	0.86	91	0.944	67.5	13.088 (1.479)	1389 (630)	315	6SE7033-2.G60
	225	1PL6226...F...0...	294.9 (220)	772 (1050)	342	460	4200	4500	0.86	124	0.948	67.5	17.08 (1.93)	1653 (750)	370	6SE7033-7.G60
	225	1PL6228...F...0...	386.1 (288)	1011 (1375)	450	460	4500	4500	0.85	176	0.948	67.3	20.584 (2.326)	1896 (860)	510	6SE7035-1.K/J60
	280	1PL6284...F...0...	556 (415)	1461 (1981)	616	455	3300	3300	0.9	161	0.961	67.3	37.169 (4.2)	2867 (1300)	690	6SE7037-0.K/J60
	280	1PL6286...F...0...	670 (500)	1761 (2387)	736	455	3300	3300	0.91	181	0.963	67.3	40.019 (5.2)	3308 (1500)	860	6SE7038-6TK60
	280	1PL6288...F...0...	845 (630)	2219 (3009)	924	455	3300	3300	0.91	231	0.965	67.3	55.754 (6.3)	3749 (1700)	1100	6SE7041-1TK60
2900	180	1PL6184...L...0...	151.5 (113)	274 (372)	209	400	5000	5000	0.85	79	0.938	97.6	4.451 (0.503)	816 (370)	210	6SE7032-1.G60
	180	1PL6186...L...0...	201.1 (150)	297 (494)	280	390	5000	5000	0.84	110	0.943	97.5	5.894 (0.666)	970 (440)	315	6SE7033-2.G60
	225	1PL6224...L...0...	274.8 (205)	496 (675)	365	400	4500	4500	0.86	118	0.95	97.5	13.088 (1.479)	1389 (630)	370	6SE7033-7.G60
	225	1PL6226...L...0...	361.9 (270)	654 (889)	470	395	4500	4500	0.87	160	0.952	97.4	17.08 (1.93)	1653 (750)	510	6SE7035-1.K/J60
	225	1PL6228...L...0...	402.1 (300)	726 (988)	530	400	4500	4500	0.86	188	0.952	97.3	20.584 (2.326)	1896 (860)	590	6SE7036-0.K/J60

Converter

E

Inverter

T

Order No. suffix: see pages 3/25 and 3/26.

1) n_1 : Speed at which, for $P = P_n$, 30% reserve power is still available before reaching the stall limit.

2) Warning! The maximum speed in field-weakening mode is sometimes limited to lower values due to $f_{max} < 5 \cdot f_n$.

* Listed Compact/Chassis units were selected for standard overload conditions (160% for 30 s at 300 s load cycle).

3) The 9th digit in the Order No. is to be completed with the suffixes indicated below the table.

Asynchronous Servomotors



Asynchronous Servomotors

1PL6 Asynchronous servomotors

1PL6 Asynchronous servomotors - Selection and ordering example with SIMOVERT MASTERDRIVES Motion Control converters

Motor data (utilization to temperature rise class F)													Converter data			
Rated speed	Size	Motor	Rated power	Rated torque	Rated current	Rated voltage	Speed during field-weakening ¹⁾	Max. operating speed ²⁾	Power factor	Magnetizing current	Efficiency	Rated frequency	Moment of inertia	Weight	Rated current	Converter/Inverter
n_n rpm		Order No.	P_n HP (kW)	T_n lb _f -ft (Nm)	I_n A	U_n V	n_1 rpm	n_{max} rpm	$\cos \varphi$	I_μ A	η_n	f_n Hz	J lb _f -in ² -s ² (kgm ²)	m lb (kg)	$I_n U$ A	Order No. ³⁾ *
Mains voltage 3 AC 400 V for SIMOVERT MASTERDRIVES Motion Control converters and SIMODRIVE 611 universal																
400	180	1PL6184...B...0...	27.5 (20.5)	361 (489)	58	290	800	5000	0.84	33.4	0.82	14.2	4.452 (0.503)	816 (370)	59	6SE7026-0.D51
	180	1PL6186...B...0...	40.9 (30.5)	537 (728)	87	290	800	5000	0.84	48.6	0.828	14.1	5.894 (0.666)	970 (440)	92	6SE7031-0.E50
	225	1PL6224...B...0...	53.6 (40)	704 (955)	105	296	800	4500	0.86	45.8	0.864	14	13.089 (1.479)	1389 (630)	124	6SE7031-2.F50
	225	1PL6226...B...0...	76.4 (57)	1004 (1361)	145	305	800	4500	0.85	67	0.868	14	17.081 (1.93)	1654 (750)	155	6SE7031-8.F50
	225	1PL6228...B...0...	96.5 (72)	1268 (1719)	181	305	800	4500	0.86	77	0.871	14.1	20.585 (2.326)	1896 (860)	218	6SE7032-6.G50
1000	180	1PL6184...D...0...	76.4 (57)	401 (544)	122	345	1300	5000	0.87	45	0.897	34.4	4.452 (0.503)	816 (370)	124	6SE7031-2.F50
	180	1PL6186...D...0...	99.2 (74)	521 (707)	157	345	1600	5000	0.86	61	0.907	34.3	5.894 (0.666)	970 (440)	155	6SE7031-8.E50
	225	1PL6224...D...0...	140.8 (105)	740 (1003)	212	345	1700	4500	0.86	46	0.927	34.5	13.089 (1.479)	1389 (630)	218	6SE7032-6.G50
	225	1PL6226...D...0...	181 (135)	951 (1289)	278	345	1700	4500	0.88	90	0.927	31.1	17.081 (1.93)	1654 (750)	308	6SE7033-7.G50
	225	1PL6228...D...0...	221.2 (165)	1162 (1576)	331	348	1600	4500	0.89	103	0.928	34.2	20.585 (2.326)	1896 (860)	423	6SE7035-1EK50
1500	180	1PL6184...F...0...	101.9 (76)	357 (484)	165	345	3000	5000	0.84	70	0.924	50.9	4.452 (0.503)	816 (370)	175	6SE7032-1.G50
	180	1PL6186...F...0...	144.8 (108)	507 (688)	233	340	3000	5000	0.85	91	0.93	50.9	5.894 (0.666)	1014 (460)	262	6SE7033-2.G50
	225	1PL6224...F...0...	190.3 (142)	667 (904)	292	345	2500	4500	0.87	91	0.94	50.9	13.089 (1.479)	1411 (640)	308	6SE7033-7.G50
	225	1PL6226...F...0...	234.6 (175)	822 (1114)	356	345	3000	4500	0.87	125	0.944	50.7	17.081 (1.93)	1676 (760)	423	6SE7035-1EK50
	225	1PL6228...F...0...	308.3 (230)	1081 (1465)	468	345	3000	4500	0.86	177	0.947	50.7	20.585 (2.326)	1918 (870)	423	6SE7036-0EK50
2500	180	1PL6184...L...0...	134 (100)	282 (382)	208	345	5000	5000	0.86	80	0.936	84.2	4.452 (0.503)	860 (390)	218	6SE7032-6.G50
	180	1PL6186...L...0...	174.3 (130)	367 (497)	275	340	5000	5000	0.85	113	0.943	84.1	5.894 (0.666)	1036 (470)	308	6SE7033-7.G50
	225	1PL6224...L...0...	238.6 (178)	502 (680)	358	345	4500	4500	0.87	119	0.95	84.1	13.089 (1.479)	1411 (640)	423	6SE7035-1EK50
	225	1PL6226...L...0...	315 (235)	662 (898)	476	340	4500	4500	0.88	157	0.953	84	17.081 (1.93)	1676 (760)	491	6SE7036-0EK50
	225	1PL6228...L...0...	355.2 (265)	747 (1013)	535	345	4500	4500	0.87	189	0.952	84	20.585 (2.326)	1918 (870)	491 ⁴⁾	6SE7036-0EK50

Converter

Inverter

E
T

Order No. suffix: see page 3/25.

- n_1 : Speed at which, for $P = P_n$, 30% reserve power is still available before reaching the stall limit.
- Warning! The maximum speed in field-weakening mode is sometimes limited to lower values due to $f_{max} < 2 \cdot f_n$ for SIMOVERT MASTERDRIVES Motion Control.

- The 9th digit in the Order No. is to be completed with the suffixes indicated below the table.
- Warning! The rated converter current is lower than the rated motor current.

* Listed Compact/Chassis units were selected for standard overload conditions (160% for 30 s at 300 s load cycle).

Asynchronous Servomotors

Asynchronous Servomotors



1PL6 Asynchronous servomotors

1PL6 Asynchronous servomotors - Selection and ordering example with SIMOVERT MASTERDRIVES Motion Control converters

Motor data (utilization to temperature rise class F)														Converter data		
Rated speed	Size	Motor	Rated power	Rated torque	Rated current	Rated voltage	Speed during field-weakening ¹⁾	Max. operating speed ²⁾	Power factor	Mag-netiz-ing current	Effi-ciency	Rated fre-quency	Moment of inertia	Weight	Rated current	Converter/ Inverter
n_n			P_n	τ_n	I_n	U_n	n_1	n_{max}	$\cos \varphi$	I_μ	η_n	f_n	J	m	I_{nU}	Order No. ³⁾ *
rpm	Order No.		HP (kW)	lb _r -ft (Nm)	A	V	rpm	rpm		A		Hz	lb _r -in _r -s ² (kgm ²)	lb (kg)	A	
Mains voltage 3 AC 480 V for SIMOVERT MASTERDRIVES Motion Control converters and SIMODRIVE 611 universal																
400	180	1PL6184...B...0...	32.8 (24.5)	430 (585)	69	300	800	5000	0.86	33	0.8	14.4	4.451 (0.503)	816 (370)	72	6SE7027-2.D51
	180	1PL6186...B...0...	42.2 (31.5)	553 (752)	90	290	800	5000	0.85	47	0.814	14.3	5.894 (0.666)	970 (440)	92	6SE7031-0.E50
	225	1PL6224...B...0...	60.3 (45)	790 (1074)	117	300	800	4500	0.87	45	0.844	14.2	13.088 (1.479)	1389 (630)	124	6SE7031-2.F50
	225	1PL6226...B...0...	76.4 (57)	1001 (1361)	145	305	800	4500	0.85	67	0.868	14	17.08 (1.93)	1653 (750)	155	6SE7031-8.F50
	225	1PL6228...B...0...	96.5 (72)	1264 (1719)	181	305	800	4500	0.86	77	0.871	14	20.584 (2.326)	1896 (860)	175	6SE7032-1.G50
1150	180	1PL6184...D...0...	87.1 (65)	397 (540)	121	400	1750	5000	0.86	46	0.906	39.4	4.451 (0.503)	816 (370)	124	6SE7031-2.F50
	180	1PL6186...D...0...	113.9 (85)	519 (706)	158	400	1950	5000	0.86	62	0.91	39.4	5.894 (0.666)	970 (440)	155	6SE7031-8.F50
	225	1PL6224...D...0...	160.9 (120)	733 (997)	218	400	2100	4500	0.86	86	0.93	39.1	13.088 (1.479)	1389 (630)	218	6SE7032-6.G50
	225	1PL6226...D...0...	207.8 (155)	946 (1287)	275	400	2000	4500	0.87	92	0.93	39.2	17.08 (1.93)	1653 (750)	308	6SE7033-7.G50
	225	1PL6228...D...0...	254.7 (190)	1160 (1578)	334	400	1850	4500	0.88	102	0.931	39.2	20.584 (2.326)	1896 (860)	423	6SE7035-1EK50
1750	180	1PL6184...F...0...	119.3 (89)	357 (486)	166	400	3500	5000	0.84	68	0.921	59.3	4.451 (0.503)	816 (370)	175	6SE7032-1.G50
	180	1PL6186...F...0...	167.6 (125)	501 (682)	231	400	3400	5000	0.84	92	0.935	59.3	5.894 (0.666)	970 (440)	262	6SE7033-2.G50
	225	1PL6224...F...0...	221.2 (165)	662 (900)	292	400	3000	4500	0.87	90	0.942	59.2	13.088 (1.479)	1389 (630)	308	6SE7033-7.G50
	225	1PL6226...F...0...	268.1 (200)	802 (1091)	350	400	3550	4500	0.87	122	0.945	59.1	17.08 (1.93)	1653 (750)	423	6SE7035-1EK50
	225	1PL6228...F...0...	355.2 (265)	1067 (1446)	470	400	3500	4500	0.86	174	0.948	59	20.585 (2.326)	1896 (860)	491	6SE7036-0EK50
2900	180	1PL6184...L...0...	151.5 (113)	274 (372)	209	400	5000	5000	0.85	79	0.938	97.6	4.451 (0.503)	816 (370)	218	6SE7032-6.G50
	180	1PL6186...L...0...	201.1 (150)	363 (494)	280	390	5000	5000	0.84	110	0.943	97.5	5.894 (0.666)	970 (440)	308	6SE7033-7.G50
	225	1PL6224...L...0...	274.8 (205)	496 (675)	365	400	4500	4500	0.86	118	0.95	97.5	13.088 (1.479)	1389 (630)	423	6SE7035-1EU50
	225	1PL6226...L...0...	361.9 (270)	656 (889)	470	395	4500	4500	0.87	157	0.952	97.4	17.080 (1.93)	1654 (750)	491	6SE7036-0EU50
	225	1PL6228...L...0...	402.1 (300)	729 (988)	530	400	4500	4500	0.86	188	0.952	97.3	20.585 (2.326)	1896 (860)	491 ⁴⁾	6SE7036-0EK50

Converter
Inverter

E
T

Order No. suffix: see page 3/25.

1) n_1 : Speed at which, for $P = P_n$, 30% reserve power is still available before reaching the stall limit.
2) Warning! The maximum speed in field-weakening mode is sometimes limited to lower values due to $f_{max} < 2 \cdot f_n$ for SIMOVERT MASTERDRIVES Motion Control.

3) The 9th digit in the Order No. is to be completed with the suffixes indicated below the table.
4) Warning! The rated converter current is lower than the rated motor current.

* Listed Compact/Chassis units were selected for standard overload conditions (160% for 30 s at 300 s load cycle).

Asynchronous Servomotors



Asynchronous Servomotors

1PL6 Asynchronous servomotors

1PL6 Asynchronous servomotors - Order No. suffix for sizes 180 and 225

		1	2	3	4	5	6	7	8	9	10	11	12	13	14	15	16
		1PL6...-□□.□□-0□□□															
Blower supply voltage																	
3 AC 400 V ±10%, 50 Hz (for 1PL618., also for 480 V +5% -10%, 60 Hz)		4															
3 AC 480 V +5% -10%, 60 Hz (only for 1PL622.)		5															
Encoder																	
Without encoder		A															
Absolute-value encoder (EnDat) (2048 p/r)		E															
Incremental encoder HTL (1024 p/r)		H															
Incremental encoder HTL (2048 p/r)		J															
sin/cos incremental encoder 1 V _{pp} (without C-track and D-track)		N															
sin/cos incremental encoder 1 V _{pp} (with C-track and D-track)		M															
Direction of cable entry (terminal box on top)																	
From the right		0															
From D-end		1															
From ND-end		2															
From the left		3															
Type of construction (see page 7/36)		Hoist concept															
IM B 3		Standard		0													
IM B 6, IM B 7, IM B 8, IM V 5, IM V 6		For vertical types of construction		1													
IM B 35		Standard		3													
IM V 36, IM V 15		For vertical types of construction		5													
Type of drive		Vibration severity		Shaft and flange accuracy													
Coupling		R		N		A											
Coupling		R		R		B											
Coupling		S		R		C											
Coupling		SR		R		D											
Belt		R		N		E											
Belt		R		R		F											
Increased lateral forces		R		N		G											
Increased lateral forces		R		R		H											
Air-flow direction		Shaft extension															
D-end → ND-end		With featherkey, half-key balancing		A													
D-end → ND-end		Smooth		J													
D-end → ND-end		With featherkey, full-key balancing		C													
Paint finish																	
Primed		0															
Anthracite, normal coating (RAL 7016)		3															
Anthracite, special coating (RAL 7016)		6															

Asynchronous Servomotors

Asynchronous Servomotors



1PL6 Asynchronous servomotors

1PL6 Asynchronous servomotors - Order No. suffix for size 280 (available soon)

	1	2	3	4	5	6	7	8	9	10	11	12	13	14	15	16
Blower, mains supply voltage 3 AC 400 V +/-10%, 50/60 Hz; 480 V +/-10%, 60 Hz																
With separate blower, ND-end top, direction of air flow ND-end to D-end									0							
With separate blower, ND-end right, direction of air flow ND-end to D-end									1							
With separate blower, ND-end left, direction of air flow ND-end to D-end									2							
Without separate blower, for single pipe connection to ND-end									6							
Encoder																
Without encoder									A							
Incremental encoder HTL (1024 p/r)									H							
Incremental encoder HTL (2048 p/r)									J							
Terminal box/direction of cable entry (looking at D-end)																
Terminal box ND-end right / cable entry below/encoder connector on D-end ¹⁾									0							
Terminal box ND-end left / cable entry below/encoder connector on D-end ²⁾									1							
Terminal box ND-end top / cable entry right/encoder connector on D-end ³⁾									2							
Type of construction (see page 7/36)																
IM B 3									0							
IM B 6, IM B 7, IM B 8, IM V 5, IM V 6									1							
IM B 35 (with flange A660)									3							
IM V 36, IM V 15 (with flange A660)									5							
Type of drive																
Coupling									N							
Coupling									R							
Belt, increased lateral forces									N							
Belt, increased lateral forces									R							
Shaft and flange accuracy																
Shaft extension																
With featherkey, half-key balancing																A
With featherkey, full-key balancing																
Smooth																
Paint finish																
Primed																0
Anthracite, normal coating (RAL 7016)																
Anthracite, special coating (RAL 7016)																6

1) Only possible for 8th data digit "0", "2", "6".

2) Only possible for 8th data digit "0", "1", "6".

3) Only possible for 8th data digit "1", "2", "6".



Asynchronous Servomotors

Asynchronous Servomotors

1PH4 Water-cooled asynchronous servomotors

Technical data



Fig. 3/9
1PH4 three-phase motors,
sizes 100 to 160

Technical characteristics

The 1PH4 three-phase motors are compact, water-cooled asynchronous motors with a squirrel-cage rotor.

They are especially characterized by the following properties:

- high power density with low physical volume
- high degree of protection
- large speed range
- speed down to zero without torque reduction
- robustness
- low maintenance requirements
- high lateral-force withstand capability
- high level of concentricity even at lowest speeds
- integrated encoder system for detecting motor speed detection, plug connection
- terminal box for power cable connection
- KTY 84 motor temperature monitoring.

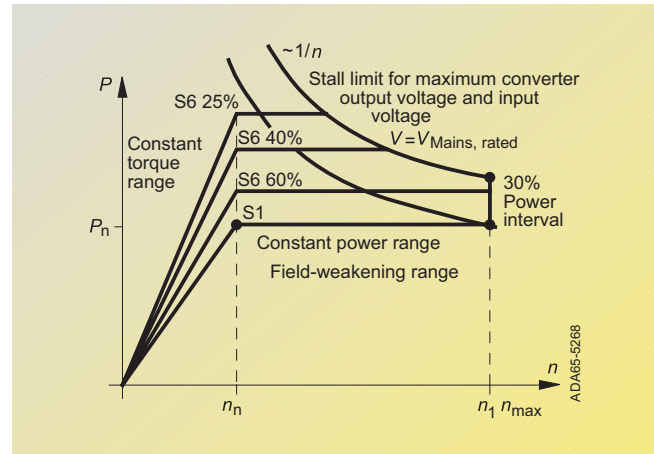

Fig. 3/10
Power-speed characteristic

Applications

- Wherever extreme ambient conditions such as high temperature, dust, dirt or aggressive atmosphere prevent air cooling
- in processes where the environment must not be thermally influenced
- on special machines where cooling water is available from the process.

1PH4 motors, frame sizes 100 to 160

	Standard	Options	Option codes
Type of construction	IM B 35 / IM V 15 / IM V 36	–	–
Degree of protection	IP 65 Shaft exit IP 55	IP 65 Shaft exit oil-tight	K18
Vibration severity	R	S (with double bearing) SR (with single bearing) S (with single bearing)	K05 K03 K02
Shaft and flange accuracy	N	R	K04
Shaft extension	With featherkey, full-key balancing	Smooth shaft extension, half-key balancing	K42 L69
Terminal box (looking at D-end)	On top, (can be rotated by 4 × 90°) cable entry from the right	On the right-hand side On the left-hand side Cable entry from D-end Cable entry from ND-end Cable entry from the left	K09 K10 K83 K84 K85
Motor protection	KTY 84, in the stator winding	–	–
Encoder system (plug connection)	Incremental encoder HTL (with SIMOVERT VC)	sin/cos incremental encoder 1 V _{pp} (for use with SIMOVERT MC) Absolute-value encoder (EnDat) (2048 p/r) (for use with SIMOVERT MC) Without encoder (SIMOVERT VC and SIMODRIVE 611 universal)	– H30
Paint finish	Anthracite RAL 7016	–	–
Bearings	Double bearing on D-end for belt drive (minimum lateral force necessary)	Single bearing on D-end for coupling drive and planetary gear (low lateral forces) Increased maximum speed ³⁾	K00 L37
Cooling ¹⁾	Water cooling ²⁾ Coolant feed temp ≤ 30 °C Connected at ND-end	–	–
Gearbox mounting ⁴⁾	–	Suitable for fitting a ZF gear-change gear unit	K00
Other	–	Second rating plate supplied as a loose item	K31
Holding brake	–	ZF holding brake on D-end	G46

1) Sound pressure level
Size 100: 69 dB(A)
132: 69 dB(A)
160: 71 dB(A).

2) Cooling water rate: connection thread
Size 100: 6 l/min; G ¼"
132: 8 l/min; G 3/8"
160: 10 l/min; G ½"
Max. pressure: 6 bar.

3) Max. possible speeds
Size 100: 12,000 rpm
132: 10,000 rpm
160: 8,000 rpm

4) For notes on gearbox mounting, see Chapter 4.

Asynchronous Servomotors

1PH4 Water-cooled asynchronous servomotors

Asynchronous Servomotors



1PH4 Asynchronous servomotors - Selection and ordering example with SIMOVERT MASTERDRIVES Vector Control converters

Motor data (utilization to temperature rise class F)														Converter data		
Rated speed	Size	Motor	Rated power	Rated torque	Rated current	Rated voltage	Speed during field-weakening ¹⁾	Max. operating speed ²⁾	Power factor	Mag-netiz-ing cur-rent	Effi-ci-en-cy	Rated fre-quen-cy	Moment of inertia	Weight	Rated cur-rent	Converter/ Inverter
n_n		Order No.	P_n HP (kW)	τ_n lb _r -ft (Nm)	I_n	U_n	n_1	n_{max}	$\cos \varphi$	I_μ	η_n	f_n	J lb _r -in _r -s ² (kgm ²)	m lb (kg)	I_{nU}	Order No. ³⁾
rpm					A	V	rpm	rpm		A		Hz			A	

Mains voltage 3 AC 400 V for SIMOVERT MASTERDRIVES Vector Control converters

1750	100	1PH4103-4.F56	11.8 (8.8)	35 (48)	20.5	400	2800	7500	0.75	11.5	0.841	61.2	0.15 (0.017)	115 (52)	25.5	6SE7022-6.EC61-1AA0
	100	1PH4105-4.F56	17.2 (12.8)	52 (70)	28	400	2600	7500	0.78	13.5	0.854	61.3	0.212 (0.024)	148 (67)	34	6SE7023-4.EC61-1AA0
	100	1PH4107-4.F56	21.8 (16.3)	66 (89)	35.5	400	2800	7500	0.78	18	0.867	61	0.274 (0.031)	176 (80)	37.5	6SE7023-8.ED61-1AA0
	132	1PH4133-4.F56	23.5 (17.5)	71 (96)	35.5	400	2100	6700	0.82	12	0.887	60.2	0.407 (0.046)	198 (90)	37.5	6SE7023-8.ED61-1AA0
	132	1PH4135-4.F56	34.2 (25.5)	103 (139)	52	400	2500	6700	0.79	22	0.901	59.8	0.628 (0.071)	247 (112)	59	6SE7026-0.ED61-1AA0
	132	1PH4137-4.F56	42.2 (31.5)	127 (172)	63	400	2300	6700	0.81	23	0.905	59.9	0.752 (0.085)	287 (130)	72	6SE7027-2.ED61-1AA0
	160	1PH4163-4.F56	57.6 (43)	173 (235)	88	400	2800	5300	0.78	42	0.914	59.3	1.504 (0.17)	386 (175)	92	6SE7031-0.EE60-1AA0
	160	1PH4167-4.F56	72.4 (54)	218 (295)	107	400	2600	5300	0.8	44	0.92	59.4	1.823 (0.206)	463 (210)	124	6SE7031-2.EF60-1AA0
	160	1PH4168-4.F56	81.8 (61)	246 (333)	117	400	2400	5300	0.82	43	0.921	59.4	1.946 (0.22)	529 (240)	124	6SE7031-2.EF60-1AA0

Mains voltage 3 AC 480 V for SIMOVERT MASTERDRIVES Vector Control converters

2000	100	1PH4103-4.F56	12.7 (9.5)	33 (45)	19.5	450	3300	7500	0.74	11.2	0.856	69.3	0.150 (0.017)	115 (52)	25.5	6SE7022-6.EC61-1AA0
	100	1PH4105-4.F56	18.8 (14)	49 (67)	26.5	450	3000	7500	0.79	12.9	0.87	69.4	0.212 (0.024)	148 (67)	34	6SE7023-4.EC61-1AA0
	100	1PH4107-4.F56	24.1 (18)	63 (86)	34.5	450	3200	7500	0.78	17.1	0.879	69.1	0.274 (0.031)	176 (80)	37.5	6SE7023-8.ED61-1AA0
	132	1PH4133-4.F56	25.5 (19)	67 (91)	33.5	450	2400	6700	0.83	11.9	0.899	68.4	0.407 (0.046)	198 (90)	34	6SE7023-4.EC61-1AA0
	132	1PH4135-4.F56	37.5 (28)	99 (134)	50	450	2700	6700	0.8	21.5	0.909	68.1	0.628 (0.071)	247 (112)	59	6SE7026-0.ED61-1AA0
	132	1PH4137-4.F56	45.6 (34)	119 (162)	59	450	2600	6700	0.83	22.1	0.914	68.1	0.752 (0.085)	287 (130)	59	6SE7026-0.ED61-1AA0
	160	1PH4163-4.F56	63 (47)	165 (224)	84	450	3000	5300	0.79	39.7	0.923	67.6	1.504 (0.17)	386 (175)	92	6SE7031-0.EE60-1AA0
	160	1PH4167-4.F56	77.7 (58)	204 (277)	101	450	3000	5300	0.81	42.6	0.926	67.6	1.823 (0.206)	463 (210)	124	6SE7031-2.EF60-1AA0
	160	1PH4168-4.F56	87.1 (65)	229 (310)	110	450	2800	5300	0.83	41	0.928	67.6	1.946 (0.22)	529 (240)	124	6SE7031-2.EF60-1AA0

Incremental encoder HTL (1024 p/r)	H
Incremental encoder HTL (2048 p/r)	J
Converter	E **
Inverter	T

1) n_1 : Speed at which, for $P = P_n$, 30% reserve power is still available before reaching the stall limit.

2) Warning! The maximum speed in field-weakening mode is sometimes limited to lower values due to $f_{max} < 5 \cdot f_n$ in case of Vector Control and $f_{max} < 2 \cdot f_n$ in the case of Motion Control.

3) The **9th digit** in the Order No. is to be completed with the suffixes indicated below the table.

** For rated currents below 37.5 A Compact Plus units can also be used.

Asynchronous Servomotors



Asynchronous Servomotors

1PH4 Water-cooled asynchronous servomotors

1PH4 Asynchronous servomotors - Selection and ordering example with SIMOVERT MASTERDRIVES Motion Control converters

Motor data (utilization to temperature rise class F)														Converter data		
Rated speed	Size	Motor	Rated power	Rated torque	Rated current	Rated voltage	Speed during field-weakening ¹⁾	Max. operating speed ²⁾	Power factor	Magnetizing current	Efficiency	Rated frequency	Moment of inertia	Weight	Rated current	Converter/ Inverter
n_n		Order No.	P_n HP (kW)	τ_n lb _f -ft (Nm)	I_n A	U_n V	n_1 rpm	n_{max} rpm	$\cos \varphi$	I_μ A	η_n	f_n Hz	J lb _f -in ² -s ² (kgm ²)	m lb (kg)	I_{nU} A	Order No. ³⁾
rpm																

Mains voltage 3 AC 400 V for SIMOVERT MASTERDRIVES Motion Control converters

1500	100	1PH4103-4.F56	10.1 (7.5)	35 (48)	20.5	350	2400	7500	0.74	12	0.82	52.8	0.15 (0.017)	115 (52)	25.5	6SE7022-6.C51
	100	1PH4105-4.F56	14.7 (11)	52 (70)	28	350	2100	7500	0.78	13.5	0.836	52.9	0.212 (0.024)	148 (67)	34	6SE7023-4.C51
	100	1PH4107-4.F56	18.8 (14)	66 (89)	35.5	350	2400	7500	0.77	18.5	0.851	52.5	0.274 (0.031)	176 (80)	37.5	6SE7023-8.D51
	132	1PH4133-4.F56	20.1 (15)	70 (95)	35	350	1800	6700	0.81	13	0.877	51.8	0.407 (0.046)	198 (90)	37.5	6SE7023-8.D51
	132	1PH4135-4.F56	29.5 (22)	103 (140)	52	350	2100	6700	0.79	24	0.89	51.4	0.628 (0.071)	247 (112)	59	6SE7026-0.D51
	132	1PH4137-4.F56	36.2 (27)	126 (172)	62	350	1900	6700	0.81	24	0.895	51.5	0.752 (0.085)	287 (130)	72	6SE7027-2.D51
	160	1PH4163-4.F56	49.6 (37)	174 (236)	89	350	2400	5300	0.77	45	0.905	50.9	1.504 (0.17)	386 (175)	92	6SE7031-0.E50
	160	1PH4167-4.F56	61.7 (46)	216 (293)	107	350	2200	5300	0.79	48	0.91	51	1.823 (0.206)	493 (210)	124	6SE7031-2.F50
160	1PH4168-4.F56	69.7 (52)	244 (331)	117	350	2100	5300	0.81	46	0.913	51	1.946 (0.22)	529 (240)	124	6SE7031-2.F50	

Mains voltage 3 AC 480 V for SIMOVERT MASTERDRIVES Motion Control converters

1750	100	1PH4103-4.F56	11.8 (8.8)	35 (48)	20.5	400	2800	7500	0.75	11.5	0.841	61.2	0.15 (0.017)	115 (52)	25.5	6SE7022-6.C51
	100	1PH4105-4.F56	17.2 (12.8)	52 (70)	28	400	2600	7500	0.78	13.5	0.854	61.3	0.212 (0.024)	148 (67)	34	6SE7023-4.C51
	100	1PH4107-4.F56	21.8 (16.3)	66 (89)	35.5	400	2800	7500	0.78	18	0.867	61	0.274 (0.031)	176 (80)	37.5	6SE7023-8.D51
	132	1PH4133-4.F56	23.5 (17.5)	71 (96)	35.5	400	2100	6700	0.82	12	0.887	60.2	0.407 (0.046)	198 (90)	37.5	6SE7023-8.D51
	132	1PH4135-4.F56	34.2 (25.5)	103 (139)	52	400	2500	6700	0.79	22	0.901	59.8	0.628 (0.071)	247 (112)	59	6SE7026-0.D51
	132	1PH4137-4.F56	42.2 (31.5)	127 (172)	63	400	2300	6700	0.81	23	0.905	59.9	0.752 (0.085)	287 (130)	72	6SE7027-2.D51
	160	1PH4163-4.F56	57.6 (43)	173 (235)	88	400	2800	5300	0.78	42	0.914	59.3	1.504 (0.17)	386 (175)	92	6SE7031-0.E50
	160	1PH4167-4.F56	72.4 (54)	218 (295)	107	400	2600	5300	0.8	44	0.92	59.4	1.823 (0.206)	463 (210)	124	6SE7031-2.F50
160	1PH4168-4.F56	81.8 (61)	246 (333)	117	400	2400	5300	0.82	43	0.921	59.4	1.946 (0.22)	529 (240)	124	6SE7031-2.F50	

sin/cos incremental encoder 1 V _{pp} (without C-track and D-track)	N	
sin/cos incremental encoder 1 V _{pp} (with C-track and D-track)	M	
Absolute-value encoder (EnDat) (2048 p/r)	E	
Converter		E **
Inverter		T

1) n_1 : Speed at which, for $P = P_n$, 30% reserve power is still available before reaching the stall limit.

2) Warning! The maximum speed in field-weakening mode is sometimes limited to lower values due to $f_{max} < 5 \cdot f_n$ in case of Vector Control and $f_{max} < 2 \cdot f_n$ in the case of Motion Control.

3) The **9th digit** in the Order No. is to be completed with the suffixes indicated below the table.

** For rated currents below 37.5 A Compact Plus units can also be used.

Asynchronous Servomotors

Notes



3

Servomotors

Accessories



- 4/2 Incremental encoder HTL (1024 p/r and 2048 p/r)
- 4/2 Resolver, 2-pole/multi-pole
- 4/3 sin/cos incremental encoder 1 V_{pp}
- 4/3 Absolute-value encoder (EnDat)

- 4/4 **Measuring Systems**
Measuring Systems for 1FN3 AC linear motors
- 4/5 Hall-effect sensor box

- 4/6 **Holding brakes**
Integrated holding brakes for 1FK. and 1FT6 motors
- 4/8 Built-on holding brakes for 1PH7 motors
- 4/9 Order No. code

- 4/10 **Built-on gears**
Planetary gears, LP series (from alpha)
- 4/12 Planetary gears, SPG series (from alpha)
- 4/15 2-gear units (from ZF)
- 4/17 Planetary gears made by Bayside Motion and other gear manufacturers

- 4/18 **Accessories for 1FN3 AC linear motors**
Optional coolers
- 4/19 Precision coolers
- 4/20 Cooling profiles (secondary section cooler)
- 4/21 Secondary section end pieces
- 4/22 Secondary section cover

Servomotors Accessories

Encoder systems

Synchronous
Servomotors

Asynchronous
Servomotors

Incremental encoder HTL (1024 p/r and 2048 p/r)

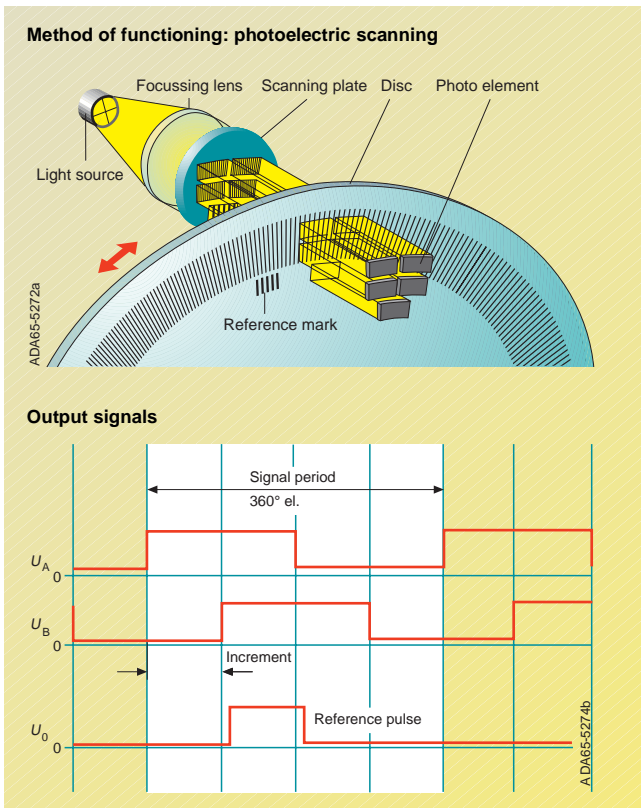

Resolver 2-pole/multi-pole¹⁾

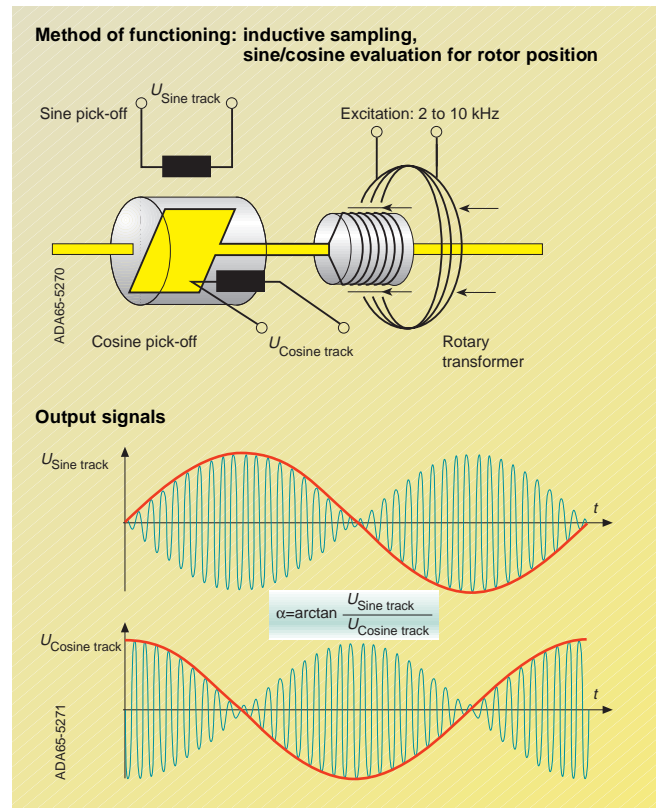

Technical data

Supply voltage:	+10 V to 30 V
Output signals:	HTL Track A, Track B Zero pulse and inverted signals
Number of pulses per revolution:	1024 (optional: 2048)
Accuracy ³⁾ :	± 0.017°
Resolution with SBP ⁴⁾ :	4096 ppr/(8192 p/r)
Positioning accuracy ⁵⁾ :	1024 ppr/(2048 p/r)
Frequency limit (-3 dB):	160 kHz
Use:	1PH7, 1PL6, 1PH4 asynchronous servomotors
Max. possible connecting cable length:	
- without transfer of the inverted signals	492 ft (150 m)
- with transfer of the inverted signals	984 ft (300 m)

Technical data 2-pole (4-, 6-, 8-pole) resolver

Operating voltage/frequency:	+5 V/4 kHz
Output signals ²⁾ :	$U_{\text{Sine track}} = \ddot{u} \cdot U_{\text{Excitation}} \cdot \sin \alpha$ $U_{\text{Cosine track}} = \ddot{u} \cdot U_{\text{Excitation}} \cdot \cos \alpha$
Transmission ratio:	$\ddot{u} = 0.5 \pm 5\%$
Width of angular error ³⁾	<0.2° (0.167°, 0.067°, 0.067°)
Use:	1FT6, 1FK6, 1FK7 synchronous servomotors 1PH7, 1PH4 (only 2-pole Resolver) asynchronous servomotors
Max. possible connecting cable length:	492 ft (150 m)
Resolution with SBR ⁴⁾	4096 p/r (8192, 12288, 16384 p/r)
Positioning accuracy ⁵⁾	1024 p/r (2048, 3072, 4096 p/r)

1) When using a multi-pole resolver, the number of poles corresponds to the number of poles of the motor.

2) Output signals:
• 2-pole resolver:
one sin/cos signal per revolution
• 4-pole resolver:
two sin/cos signals per revolution
• 6-pole resolver:
three sin/cos signals per revolution.

3) Is the maximum position deviation within one signal period of the encoder. Decisive influence on the positioning accuracy, speed stability and power loss of the drive.

4) Is the (maximum) number of increments/periods per revolution. Evaluation electronics in the encoder board allows to interpolate between periods and therefore to increase the resolution.

5) In practice, achievable positioning accuracy is a factor 4 to 10 times worse than resolution.

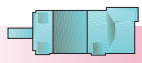

Asynchronous
Servomotors

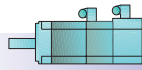

Synchronous
Servomotors

sin/cos incremental encoder 1 V_{pp}

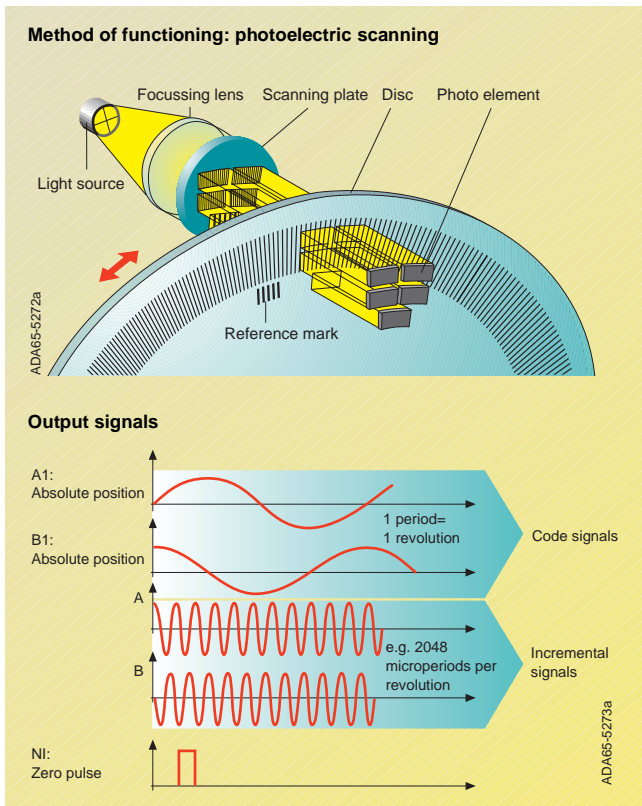

Fig. 4/3

Technical data

Supply voltage:	+5 V ±5%
Incremental signals (sinusoidal):	
• Voltage:	1 V _{pp}
• Number of pulses per revolution:	2048
• Accuracy ²⁾ :	± 0.01°
Code signals	
• Voltage:	1 V _{pp}
• Type of signals (C and D tracks):	1 sine signal and 1 cosine signal per revolution
Use:	1FT6, 1FK6, 1FK7, 1FS6 synchronous servomotors 1PH7, 1PL6, 1PH4 asynchronous servomotors
Max. possible connecting cable length:	328 ft (100 m)

Note to the method of functioning graphics:

The functioning graphics for the incremental and absolute-value encoders were taken out of the catalog of Dr. JOHANNES HEIDENHAIN GmbH, Traunreut by the company's kind permission.

Absolute-value encoder (EnDat)

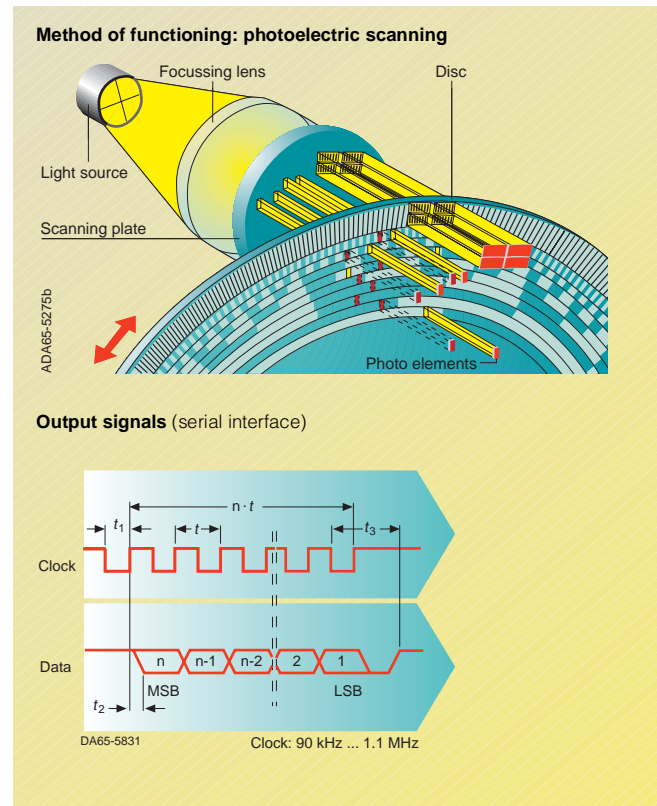

Fig. 4/4

Technical data

Supply voltage:	+5 V ±5%
Incremental signals (sinusoidal):	
• Voltage:	1 V _{pp}
• Number of pulses per revolution:	2048/512/32 ¹⁾
• Accuracy ²⁾ :	± 0.01° / ±0.02° / ± 0.1°
Code signals:	Synchronous serial EnDat interface Dual code 4096 coded revolutions
Use:	1FT6, 1FK6, 1FK7, 1FS6 synchronous servomotors 1PH7, 1PL6, 1PH4 asynchronous servomotors
Max. possible connecting cable length:	328 ft (100 m)

1) Absolute-value encoder (EnDat) with 2048 p/r for 1FT6, 1FK, 1FS6 motors from size 48 and all asynchronous motors.
Absolute-value encoder (EnDat) with 512 p/r for 1FT6 size 28 and 1FK motors from sizes 28 and 36.
Single absolute-value encoder (EnDat) with 32 p/r for 1FK motors from size 48.

2) Is the maximum position deviation within one signal period of the encoder. Decisive influence on the positioning accuracy, speed stability and power loss of the drive.

Servomotors Accessories

Measuring systems

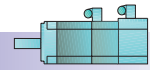

Linear Motors

Measuring systems for 1FN3 AC linear motors

The following linear encoders are recommended for use with 1FN linear motors and the SIMODRIVE 611 universal or SIMODRIVE POSMO CD/CA drive system.

Encapsulated (sealed) linear encoders are characterized by a high degree of protection and easy mounting. They are therefore ideal for application in typical production environments.

Exposed (open) linear encoders are characterized by higher accuracy grades, higher traversing speeds and contact-free scanning, i.e. without friction between the scanning head and scale.

Exposed linear encoders are suited for applications in clean environments, e.g. on measuring machines or production equipment in the semiconductor industry.

Recommended linear measuring systems for 1FN linear motors		<u>Heidenhain</u> LC 181/LC 481 Absolute encoder EnDat encapsulated	<u>Heidenhain</u> LS 186 Incremental encoder sin/cos 1 V _{pp} encapsulated	<u>Heidenhain</u> LS 486 Incremental encoder sin/cos 1 V _{pp} encapsulated	<u>Renishaw</u> RG2 Incremental encoder sin/cos 1 V _{pp} exposed
Signal cycle	μm	16	20	20	20
Maximum permissible acceleration in measuring direction	ft/s ² (m/s ²)	164 (50)	328 (100)	164 (50)	984 ¹⁾ (300)
Maximum permissible traversing velocity	ft/min (m/min)	394 (120)	394 (120)	394 (120)	984 (300)
Maximum measuring length	in (mm)	119.69 (3040)	119.69 (3040)	80.31 (2040)	1968.5 (50000)
Output signal/data output		EnDat/1 V _{pp}	1 V _{pp}	1 V _{pp}	1 V _{pp}

For more information contact the manufacturer directly at:

Heidenhain Corporation

333 E. State Parkway
Schaumburg, IL 60173-5337
Phone: (847) 490-1191
Fax: (847) 490-3931
<http://www.heidenhain.com>

Renishaw Inc.

5277 Trillium Blvd
Hoffman Estates, IL 60192
Phone: (847) 286-9953
Fax: (847) 645-9740
<http://www.renishaw.com>

4

1) Figure relates to measuring head.

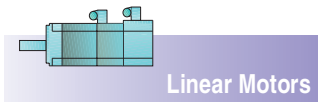

Hall-effect sensor box



Fig. 4/5
Hall-effect sensor box

When using an incremental measuring scale, a Hall sensor is required for 1FN3 linear motors.

When the machine is powered-up, the Hall sensor provides the pole position in the motor for commutation during the reference point approach.

If an absolute measuring system is used, the Hall sensor box is not required as long as the pole position angle is measured using an oscilloscope or flux meter when the system is first commissioned or when a measuring scale is changed, and is permanently entered into the parameter list of the drive control.

Ordering data

Linear motor type	Hall-effect sensor box
	Order No.
1FN3 050-2W	1FN3 002-0PH00-0AA0
1FN3 100-2W	1FN3 002-0PH00-0AA0
1FN3 100-3W	1FN3 005-0PH00-0AA0
1FN3 100-4W	1FN3 002-0PH00-0AA0
1FN3 100-5W	1FN3 005-0PH00-0AA0
1FN3 150-2W	1FN3 002-0PH00-0AA0
1FN3 150-3W	1FN3 005-0PH00-0AA0
1FN3 150-4W	1FN3 002-0PH00-0AA0
1FN3 150-5W	1FN3 005-0PH00-0AA0
1FN3 300-2W	1FN3 003-0PH00-0AA0
1FN3 300-3W	1FN3 006-0PH00-0AA0
1FN3 300-4W	1FN3 003-0PH00-0AA0
1FN3 450-2W	1FN3 003-0PH00-0AA0
1FN3 450-3W	1FN3 006-0PH00-0AA0
1FN3 450-4W	1FN3 003-0PH00-0AA0
1FN3 600-3W	1FN3 006-0PH00-0AA0
1FN3 600-4W	1FN3 003-0PH00-0AA0
1FN3 900-2W	1FN3 003-0PH00-0AA0
1FN3 900-4W	1FN3 003-0PH00-0AA0

Servomotors Accessories

Holding brakes

Synchronous
Servomotors

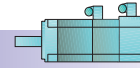

Asynchronous
Servomotors



Motors may need a holding brake with an emergency-stop function for reasons relating to the process involved or for safety. There are two different ways of attaching a brake to the motor:

1. Brake integrated in the motor 1FK. and 1FT6 (integrated holding brake).
2. Brake built onto the D-end of the 1PH7 motor (built-on holding brake).

Integrated holding brakes for 1FK. and 1FT6 motors

The permanent-magnet and spring-loaded single-face brakes used for these series of motors work on the closed-circuit current principle. The magnetic field of the permanent magnet exerts a pulling force on the brake's armature plate, i.e. in a zero-current condition, the brake is closed, thus preventing the motor shaft from turning. When there is a rated voltage of 24 V DC applied to the brake, the

current-carrying coil generates an opposing field which cancels out the force exerted by the permanent magnet and releases the brake or holds it open.

For "emergency stops" or on power failure, approximately 2000 braking operations can be carried out at maximum switching capacity without causing excess wear on the holding brake (condition: the maximum external moment

of inertia = the motor's own moment of inertia and n_{max} in relation to the type).

The holding brake is not designed as a stopping device during normal operations.

To avoid switching overvoltages and any associated influence on the plant or system environment, the brake feeder must be connected externally to a varistor. It is connected using the power plug or a terminal box.

The technical data are given in the table below (for dimension drawings, see Chapter 8).

Technical data of the integrated holding brakes (brake supply voltage: 24 V DC \pm 10%)

Size	Motor type	Brake type	Holding torque	Direct current	Opening time with varistor	Closing time with varistor	Moment of inertia	Maximum switching energy per braking operation when braking from $n = 3000$ rpm
			lb _f -ft (Nm)	A	ms	ms	lb _f -in-s ² (10 ⁻⁴ kgm ²)	J

For 1FK7 CT motors

28	1FK7022	EBD 0.11 BN	0.8 (1.1)	0.3	25	15	0.00006 (0.07)	8
36	1FK7032	EBD 0.13 BN	1 (1.3)	0.4	45	25	0.00071 (0.8)	17
48	1FK704.	EBD 0.3 BV	2.8 (3.8)	0.56	70	20	0.00064 (0.72)	74
63	1FK706.	EBD 0.8 BK	9.7 (13.2)	0.8	90	20	0.00199 (2.25)	357
80	1FK7080	EBD 1.5 BN	7.4 (10)	0.71	90	20	0.00274 (3.1)	397
80	1FK7083	EBD 2 BY	16.2 (22)	0.93	125	145	0.00761 (8.6)	1417
100	1FK710.	EBD 3.5 BV	30 (41)	0.93	140	100	0.0119 (13.5)	2983

For 1FK7 HD motors

36	1FK7033	1EB14	1.8 (2.4)	0.4	50	110	0.00012 (0.12)	17
48	1FK704.	1EB20	4.4 (6)	0.65	50	110	0.00013 (0.143)	234
63	1FK706.	1EB27	10.3 (14)	0.65	75	115	0.00037 (0.419)	542
80	1FK7082	1EB30	16.2 (22)	1	75	180	0.00077 (0.871)	1200
80	1FK7085	1EB35	20.6 (28)	1.2	115	190	0.00139 (1.574)	1500

4

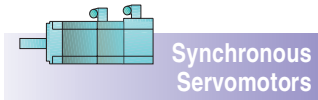

Holding brakes

Integrated holding brakes for 1FK. and 1FT6 motors

Technical data of the integrated holding brakes (brake supply voltage: 24 V DC ± 10%)

Size	Motor type	Brake type	Holding torque	Direct current	Opening time with varistor	Closing time with varistor	Moment of inertia	Maximum switching energy per braking operation when braking from $n = 3000$ rpm
			lb _f -ft (Nm)	A	ms	ms	lb _f -in-s ² (10 ⁻⁴ kgm ²)	J
For 1FK6 motors								
36	1FK6032	EBD 0.13 BS	0.8 (1.1)	0.4	30	10	0.00006 (0.07)	13
48	1FK604.	EBD 0.3 B	2.4 (3.2)	0.6	35	10	0.00023 (0.26)	68
63	1FK606.	EBD 0.8 B	7.4 (10)	0.7	55	15	0.00079 (0.9)	318
80	1FK608.	EBD 1.4 BV	13.3 (18)	0.9	150	30	0.00266 (3)	535
100	1FK6100	EBD 2 BY	14.8 (20)	0.9	100	30	0.00699 (7.9)	1135
100	1FK6101	EBD 3.8 B	26.6 (36)	0.9	180	25	0.01141 (12.9)	1233
100	1FK6103	EBD 3.8 B	26.6 (36)	0.9	180	25	0.01141 (12.9)	1233
For 1FT6 motors								
28	1FT602.	EBD 0.11 B	0.9 (1.2)	0.3	20	10	0.00006 (0.07)	34
36	1FT603.	EBD 0.15 B	1.5 (2)	0.4	30	15	0.0001 (0.12)	27
48	1FT604.	EBD 0.4 BA	3.7 (5)	0.8	30	15	0.0009 (1.06)	126
63	1FT606.	EBD 1.5 BN	16.2 (22)	0.7	130	20	0.0028 (3.2)	321
80	1FT6081	EBD 1.2 B	8.9 (12)	0.8	70	35	0.0028 (3.2)	740
80	1FT6082	EBD 1.2 B	8.9 (12)	0.8	70	35	0.0028 (3.2)	740
80	1FT6084	EBD 3.5 BN	20.7 (28)	0.9	180	35	0.0119 (13.5)	1640
80	1FT6086	EBD 3.5 BN	20.7 (28)	0.9	180	35	0.0119 (13.5)	1640
100	1FT610.	EBD 4 B	59 (80)	1.4	180	20	0.0283 (32)	2150
132	1FT613.	EBD 8 B	103.3 (140)	1.7	260	70	0.0673 (76)	9870



Built-on holding brakes for 1PH7 motors

A brake can be built onto the drive-end of **1PH7** motors frame sizes 100, 132, 160, 180 and 225.

These brakes are electro-magnetic brakes for dry running. An electromagnetic field is used to cancel out the braking effect caused by a spring. The brakes function according to the closed-circuit current principle, i.e. the spring-applied brake brakes when no current is applied and prevents the motor from moving. When current flows again, the brake is released and the motor can rotate.

During power failures and "emergency stops", the motor is braked from its current speed until it comes to a standstill. The respective holding torque and the number of emergency stops are given in the table on page 4/9.

The brakes are designed for connection to an AC voltage of 230 V AC, 50 to 60 Hz or DC 24 V (only up to size 160) which has to be provided on site. The rectifier is built into the terminal box of the brake. The degree of protection is IP 55.

In its basic design, the brake contains three emergency-release screws (only frame sizes 180 and 225) which are axially accessible from the front. The built-in or built-on microswitch can be incorporated as an NC contact or an NO contact in a higher-level control unit. The fast-switching rectifier is for overexcitation of the coil in order to release the brake and achieve short release times (release current = 2 × holding current).

All the technical data such as holding torque, permissible speeds, number of emergency braking operations and braking current are given in the table on page 4/9.

The operating instructions for built-on holding brakes are supplied together with the motor-brake unit.

Ordering example:
1PH7 186-2HF00-2AA3,
IM B 3 type of construction.

This holding brake contains a microswitch and an emergency release screw (for further ordering possibilities, see order number code on page 4/9).

Built-on holding brake for motors frame sizes 100 to 160

The holding brakes for motors frame sizes 100, 132 and 160 are braking modules (made by Binder) with their own bearings, flange and shaft extension. The dimensions of the flange and shaft extension of the braking module are identical with those of the motor. If a motor is to be equipped with a brake, the motor is supplied with a flange type of construction and with a plain shaft (without featherkey). The shaft of the braking module is then hot-shrunk onto the motor shaft. It can be removed again by means of an oil interference fit. The braking module is then screwed onto the motor flange. The shaft extension at the braking module is fitted with a featherkey (with half-key balancing).

Output is then possible by means of a coupling or belt pulley. The permissible lateral forces are indicated in the corresponding lateral-force diagrams.

The 1PH7 (frame sizes 100 and 132) motors can be supplied with an IM B 5 type of construction. In addition, frame sizes 100, 132 and 160 motors can be supplied with an IM B 35 type of construction (installation with IM B 3 foot mounting is therefore possible).

As an option, a manual release can be fitted to the brake module so that, in the event of power failure or motor stoppage, the brake can be released by hand. If the manual-release lever is released, it automatically returns to the braking-mode position. Another option is a built-on microswitch which can be incorporated in a higher-level control unit as an NC contact or an NO contact. The microswitch is connected by means of a separate cable.

The braking module complies with degree of protection IP 55. Motors with a built-on braking module are only available with vibration severity grade N and with shaft and flange accuracy N.

All the technical data such as holding torque, maximum braking energy, permissible speeds, lateral forces and braking currents are given in the table below. The dimensions are shown in the dimension drawings in Section 8.

Ordering example:
1PH7 137-2HF02-3KB3,
type of construction IM B5,
holding brake with manual
release (for further ordering
possibilities, see order
number code on page 4/9).

Built-on holding brake for 1PH7 motors (sizes 180 and 225)

With these motors, the brake (made by Stromag) is mounted on the drive-end bearing shield. To do this, the motor shaft is extended by means of a shrunk-on shaft extension. The torque is transmitted by means of a featherkey to DIN 6885/1. The shaft extension can be additionally secured axially by a pressure washer and a central screw (M 20). The holding brake does not have its own bearings. The output forces are therefore absorbed by the motor bearings. Belt pulleys cannot be fitted for reasons of space and because of the high lateral forces. When a coupling is being selected for connection to the brake-motor combination, it should be noted that the diameter of the shaft extension is now larger than the diameter of the motor shaft extension.

The exact motor dimensions are given in the dimension drawings in Section 8.



Technical data of the built-on holding brakes with emergency-stop function (brake supply voltage: 230 V AC, 50 to 60 Hz/24 V DC)

Size	Motor type	Brake type	Holding torque	Speed	Permissible power on energy W_E	Lifetime switching energy W_{max}	Number of emergency stops until change of lining from n_{max} at J z	Coil current		Flange dimension DIN 42948	Shaft extension dimension DIN 748 \varnothing length		Permissible lateral force (3000 rpm, x_{max})	Moment of inertia of the brake	Weight of the brake	Opening time	Closing time
			(tolerance $\pm 20\%$)	n_{max}				AC	DC		in	in					
			lb _f -ft (Nm)	rpm	kJ	MJ	-	A	DC		in (mm)	in (mm)	lb _f (N)	lb _f -in-s ² (kgm ²)	lb (kg)	ms	ms

For 1PH7 brake supply voltage 230 V AC, 50 to 60 Hz/24 V DC

100	1PH710.	Size 19	44 to 111 (60 to 150)	5500	25	90	8700	0.5487 (0.062)	1	4.7	A250	1.5 (38)	3.1 (80)	517 (2300)	0.0442 (0.005)	46 (21)	255	60	
132	1PH713.	Size 24	103 to 229 (140 to 310)	4500	40	226	9400	1.8407 (0.208)	1.3	6.3	A350	1.7 (42)	4.3 (110)	450 (2000)	0.1327 (0.015)	101 (46)	330	95	
160	1PH716.	Size 29	207 to 369 (280 to 500)	3700	60	401	11900	3.9646 (0.448)	1.35	6.7	A400	2.2 (55)	4.3 (110)	1528 (6800)	0.2478 (0.028)	145 (66)	350	450	
180	1PH7184	NFE 60	443 (600)	3500	69	154	2230	9.0265 (1.02)	0.9	-	-	3.5 (90)	3.5 (90)	629 (2800)	0.2389 (0.027)	121 (55)	400	160	
	1PH7186	NFE 60/80	590 (800)		91	56		620											12.0354 (1.36)
225	1PH7224	NFE 100	738 (1000)	3100	158	153	970	26.5487 (3)	1.3	-	-	3.9 (100)	3.9 (100)	629 (2800)	0.3628 (0.041)	165 (75)	460	200	
	1PH7226	NFE 100	738 (1000)		206	109		530							24.5133 (3.9)				0.3628 (0.041)
	1PH7228	NFE 100	1033 (1400)		248	32		130							41.59 (4.7)				0.3628 (0.041)
	1PH7228	NFE 100/140	1033 (1400)																0.3628 (0.041)

Holding torque in Nm: In the case of frame sizes 100 to 160 motors, the holding torque can be varied infinitely within the specified range of values by means of an adjusting ring. The dynamic braking torque is approximately 0.7 to 0.8 x the holding torque.

Speed n_{max} : Maximum permissible speed at which emergency stops are possible.

Permissible power-on energy W_E in kJ: Permissible switching energy in the event of an emergency stop $W_E = J_{tot} \times n^2 / 182.5$ (J in kgm², n in rpm).

Lifetime switching energy W_{max} in MJ: The maximum possible power-on energy of the brake (in the case of emergency stop) until the brake linings have to be renewed, $W_{max} = W_E \times z$.

Number of emergency stops z: The specified number of emergency stops relates to the following conditions: braking from speed n_{max} , $J_{tot} = 2 \times J_{mot}$. In the event of other conditions, it is possible to calculate as follows: number of emergency stops $z = W_{max} / W_E$.

Coil current in A: Current for keeping the brake in a released position. For the NFE brakes, the following applies: Release current = 2 x holding current.

Permissible lateral force in N: In the case of frame sizes 100 to 160 motors, coupling and pulley output is possible. In the case of frame sizes 180 and 225, only coupling output is permissible.

Opening time in ms: Time until the brake opens (specified values related to max. braking torque).

Closing time in ms: Time until the brake closes (specified values related to max. braking torque).

Order No. code for 1PH7 motors, frame sizes 100, 132 and 160 for built-on holding brake with emergency-stop function

1 2 3 4 5 6 7 8 9 10 11 12 13 14 15 16
1PH7 - - □ K . .

Without brake	0
Brake supply voltage: 230 V AC, 50 to 60 Hz	
With brake (brake supply voltage: 230 V AC, 50 to 60 Hz)	1
With brake (brake with microswitch)	2
With brake (brake with manual release)	3
With brake (brake with microswitch and manual release)	4
Brake supply voltage: 24 V DC	
With brake (brake supply voltage: 24 V DC)	5
With brake (brake with microswitch)	6
With brake (brake with manual release)	7
With brake (brake with microswitch and manual release)	8

Versions with brake are only available in the following combinations:

- Vibration severity grade N, shaft and flange accuracy N ("K" at the 14th digit)
- Shaft extension on the braking module with featherkey and semi-wedge balancing ("A" or "B" at 15th digit) or plain shaft extension ("J" or "K" at 15th digit)
- Type of construction IM B 5 (only for sizes 100 and 132, "2" at the 12th digit) or IM B 35 ("3" at the 12th digit, installation with IM B 3 foot mounting possible)
- and "0", "3" or "6" at the 16th digit.

Order No. code for 1PH7 motors, frame sizes 180 and 225 for built-on holding brake with emergency-stop function

1 2 3 4 5 6 7 8 9 10 11 12 13 14 15 16
1PH7 - 0 - □ A A . .

Without brake	0
With brake (brake with microswitch and emergency-release screw)	2
With brake (brake with microswitch and manual release)	4

Versions 2 and 4 are only available with type of construction IM B 3, i.e.:

- only "0" at 12th digit
- only "A" at 15th digit
- only "A" at 14th digit
- and only "0", "3" or "6" possible at 16th digit.

Planetary gears, LP series (from alpha)



Fig. 4/6
Planetary gear unit, LP series

1FK6 and 1FK7 servomotors can easily be combined with planetary gear units of the LP series to form compact coaxial drive units. The gear units are flanged directly onto the drive end of the motors.

When selecting the gear units, ensure that the permissible speed of the gear unit is not exceeded by the maximum speed of the motor. In the case of high operating frequencies (more than 1000 start-stop events per hour), the additional dynamic loading must be taken into account. Please contact alpha gear drives for further information. The frictional torque of the gear unit must always be taken into account in planning.

The gear units are only available in non-balanced design and with fitted key.

Technical features of the planetary gear units

- High efficiency (>94 %)
- Power transmission from the central sun gear via planetary gears
- Torque play: single-stage <12 arc min
- No shaft deflections in the planetary gear set due to the symmetrical force distribution
- The enclosed gear units, are attached to the shaft by means of an integral clamping hub. This requires a smooth motor shaft extension with rotational accuracy tolerance N according to DIN 42.955. The motor flange is fitted by means of adapter plates.
- The gear units are suitable for all mounting positions.
- The gear units are filled with grease. They are lubricated and sealed for their complete service life (guide value for service life ca. 20,000 h).
- Degree of protection IP 64.
- Output shaft of gear unit exactly coaxial with motor
- Oil seal on motor side included in the gear unit
- Small dimensions
- Low weight

Motors with built-on planetary gear units

The gear units assigned to the individual motors and gear ratios available for these motor/gear combinations are listed in the selection table on the following pages. When making your selection, note the maximum permissible input speed of the gear unit which should be equal to the maximum motor speed.

The motor/gear combinations listed in the selection tables are mainly intended for use as positioning drives (S5 duty). Continuous operation (S1 duty) is permissible at the rated speed and rated torque of the gear unit. The gear unit temperature must not exceed +90 °C. The torsional rigidity specifications in the catalog of the company alpha refer to the rated torque of the gear. The rigidity decreases in the partial load range in accordance with the hysteresis characteristic.

AC servo motors 1FK6 032 to 1FK6 103 and 1FK7022 to 1FK7103 and SIMODRIVE POSMO SI can be supplied from the (Siemens) factory complete with built-on planetary gear unit.

For queries relating to the gear units please contact:

alpha gear drives
1440 Howard St.
Elk Grove Village, IL 60007
Phone: +1 (847) 439-0700
Fax: +1 (847) 439-0755
<http://www.alphagear.com>

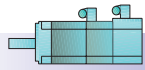

Synchronous
Servomotors

Built-on gears

Planetary gears, LP series, single-stage (from alpha)

Order data: **1 F K**□□□□-□**A**□71-1□□□-**Z** Order No. of the motor (standard type) with identifier “-Z” and short code for mounting the planetary gear assigned to the motor
V□□

G Smooth shaft, without holding brake

H Smooth shaft, with holding brake

Smooth motor shaft end is prerequisite for LP gear mounting

Servomotor Self-cooled Type 1FK6... 1FK7...	Planetary gear Single-stage Torsional play ≤ 12 arc min		Transmission ratios available <i>i</i> =		Max. permissible input speed ¹⁾ <i>n</i> _{G1} rpm	Max. permissible output torque ¹⁾		Max. permissible drive shaft load ²⁾ <i>F</i> _r lb _r (N)	Moment of inertia of the gears <i>J</i> _G <i>i</i> = 5/10 lb _r -in-s ² (10 ⁻⁴ kgm ²)
	Type	Weight of the gears Approx. lb (kg)	5	10		<i>M</i> _{G2} <i>i</i> = 5 lb _r -in (Nm)	<i>M</i> _{G2} <i>i</i> = 10 lb _r -in (Nm)		
032 033	LP 070-M01	4.1 (1.9)	■	■	6000	283 (32)	257 (29)	326 (1450)	0.0002 (0.28)
040 042 043 044	LP 090-M01	9 (4.9)	■	■	6000	708 (80)	637 (72)	540 (2400)	0.0016 (1.77)
060 061 063 064	LP 120-M01	19.8 (9)	■	■	4800	1770 (200)	1593 (180)	1034 (4600)	0.0048 (5.42)
080 082 083 085 100 101 103	LP 155-M01	386 (17.5)	■	■	4800	3540 (400)	2832 (320)	1686 (7500)	0.0228 (25.73)

Short code

For gear shaft with featherkey

V40 V42

Continuous operation S1

Continuous operation is permissible in the case of rated speed and rated torque.

The gears should not exceed a temperature of +90 °C (194 °F).

Planetary gear Single-stage Torque play ≤ 12 arc min Type	Rated speed <i>n</i> _{rated1} rpm	Max. permissible initial torque	
		<i>M</i> _{at} <i>i</i> = 5 lb _r -in (Nm)	<i>M</i> _{at} <i>i</i> = 10 lb _r -in (Nm)
LP 070-M01	3700	142 (16)	133 (15)
LP 090-M01	3400	354 (40)	310 (35)
LP 120-M01	2600	885 (100)	796 (90)
LP 155-M01	2000	2566 (290)	1504 (170)

1) Values for S5 positioning mode.

2) In relation to the midpoint of the output shaft at 100 rpm.

Planetary gears, SPG series (from alpha)



Fig. 4/7
1FT6 three-phase servomotors with built-on planetary gear unit

1FT6 AC servomotors can be combined with planetary gear units to form compact coaxial drive units. The gear units are flanged directly onto the drive end of the motors.

When selecting the gear units, ensure that the permissible speed of the gear unit is not exceeded by the maximum speed of the motor. In the case of high operating frequencies (more than 1000 start-stop events per hour), the additional dynamic loading must be taken into account. Please contact alpha gear drives for further information. The frictional torque of the gear unit must always be taken into account in planning.

The gear units are only available in non-balanced design.

Technical features of the planetary gear units

- High efficiency (>94% >97% single-stage, >94% two-stage)
- Power transmission from the central sun gear via planetary gears
- No shaft deflections in the planetary gear set due to the symmetrical force distribution
- Very low moment of inertia and hence short acceleration times of the motors
- Drive end bearing for high lateral and axial loading due to pre-stressed tapered-roller bearing.
- The enclosed gear units, filled with oil before leaving the factory, are attached to the shaft by means of an integral clamping hub. This requires a smooth motor shaft extension with rotational accuracy tolerance N according to DIN 42 955. The motor flange is fitted by means of adapter plates.
- Operation is possible in any mounting position.
- The gear units are filled with a high-grade synthetic gear oil of viscosity class SIO VG 220 in the factory. The quantity of oil is applicable for the IM B5 mounting position. The quantity of oil required is identical for all mounting positions in the case of the single-stage gear units of frame sizes SPG 060 to SPG 140. For frame sizes SPG 180 to SPG 240 and for all two-stage gear units, different quantities of oil are necessary for other mounting positions. In these cases, please specify the mounting position in the order.
- Degree of protection IP 64.
- Output shaft of gear unit exactly coaxial with motor
- Oil seal on motor side included in the gear unit
- Small dimensions
- Low weight

Motors with built-on planetary gear units

The gear units assigned to the individual motors and gear ratios available for these motor/gear combinations are listed in the selection table on the following pages. When making your selection, note the maximum permissible input speed of the gear unit which should be equal to the maximum motor speed.

The motor/gear combinations listed in the selection tables are mainly intended for use as positioning drives (S5 duty). For applications involving continuous operation at high speed, please contact the gear unit manufacturer.

AC servo motors 1FT6 024 to 1FT6 136 can be supplied from the (Siemens) factory complete with built-on planetary gear unit.

For queries relating to the gear units please contact:

alpha gear drives

1440 Howard St.
Elk Grove Village, IL 60007
Phone: +1 (847) 439-0700
Fax: +1 (847) 439-0755
<http://www.alphagear.com>

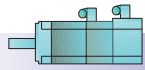

Planetary gears, SPG series, single-stage (from alpha)

Order data: **1FT6**□□□-□**A**□7□-□□□□-**Z** Order No. of the motor (standard type) with identifier “-Z” and
V□□ short code for mounting the planetary gear assigned to the motor

Servomotor Self-cooled Type	Planetary gear Single-stage Torsional play ¹⁾ ≤ 4 arc min Type	Weight of the gears Approx.	Transmission ratios available <i>i</i> =				Max. permissible input speed n_{G1} rpm	Max. permissible output torque M_{G2} lb _f -in (Nm)	Max. permissible drive shaft load ²⁾ F_r lb _f (N)	Moment of inertia of the gears	
			4	5	7	10				J_G <i>i</i> = 4 lb _f -in-s ² (10 ⁻⁴ kgm ²)	J_G <i>i</i> = 10 lb _f -in-s ² (10 ⁻⁴ kgm ²)
1FT6 024 1FT6 031 1FT6 034	SPG 060-MF1	3.3 (1.5)	■	■	■	■	6000	354 (40) [283 (32) for <i>i</i> = 10]	584 (2600)	0.00015 (0.17)	0.00013 (0.15)
1FT6 034 1FT6 041 1FT6 044	SPG 075-MF1	6.2 (2.8)	■	■	■	■	6000	885 (100) [708 (80) for <i>i</i> = 10]	854 (3800)	0.0005 (0.57) 0.00055 (0.63)	0.00035 (0.4) 0.0004 (0.46)
1FT6 044 1FT6 061 1FT6 062 1FT6 064	SPG 100-MF1	13.7 (6.2)	■	■	■	■	4500	2212 (250) [1770 (200) for <i>i</i> = 10]	1348 (6000)	0.0018 (2) 0.0024 (2.7)	0.0011 (1.3) 0.0018 (2)
1FT6 081 1FT6 082 1FT6 084 1FT6 086	SPG 140-MF1	25.4 (11.5)	■	■	■	■	4000	4425 (500) [3540 (400) for <i>i</i> = 10]	2023 (9000)	0.0074 (8.4)	0.0055 (6.2)
1FT6 086 1FT6 102 1FT6 105 1FT6 108	SPG 180-MF1	59.5 (27)	■	■	■	■	3500	9735 (1100) [7788 (880) for <i>i</i> = 10]	3147 (14000)	0.0271 (30.6) 0.0281 (31.7)	0.0154 (17.4) 0.0164 (18.5)
1FT6 105 1FT6 108 1FT6 132 1FT6 134 1FT6 136	SPG 210-MF1	116.9 (53)	■	■	■	■	2500	16814 (1900) [13451 (1520) for <i>i</i> = 10]	4047 (18000)	0.0671 (75.8)	0.0417 (47.1)
1FT6 132 1FT6 134 1FT6 136	SPG 240-MF1	176.4 (80)	■	■	■	■	2200	24071 (2720)	6070 (27000)	0.1295 (146.3)	0.0735 (83.1)
Short code											
For gear shaft with featherkey			V02	V03	V05	V09					
For gear shaft without featherkey			V22	V23	V25	V29					

1) With SPG 060 and SPG 075: ≤ 6 arc min.

2) Guide values for the maximum permissible load on the midpoint of the output shaft at a speed $n_{G2} = 300$ rpm. Axial load $F_a = 0.5 \cdot F_r$ with SPG 060 to SPG 180. $F_a = F_r$ with SPG 210 and SPG 240.

Servomotors Accessories

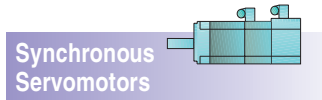

Built-on gears

Planetary gears, SPG series, 2-stage (from alpha)

Order data: **1FT6**□□□-□**A**□7□-□□□□-**Z** Order No. of the motor (standard type) with identifier “-Z” and short code for mounting the planetary gear assigned to the motor
V□□

Servomotor Self-cooled Type	Planetary gear 2-stage Torsional play ¹⁾ ≤ 6 arc min Type	Weight of the gears Approx.	Transmission ratios available <i>i</i> =					Max. permissible input speed <i>n</i> _{G1} rpm	Max. permissible output torque <i>M</i> _{G2} lb _r -in (Nm)	Max. permissible drive shaft load ²⁾ <i>F</i> _r lb _r (N)	Moment of inertia of the gears <i>J</i> _G <i>i</i> = 20 lb _r -in-s ² (10 ⁻⁴ kgm ²)
			16	20	28	40	50				
1FT6 024 1FT6 031 1FT6 034	SPG 075-MF2	6.8 (3.1)	■	■	■	■	■	6000	885 (100)	854 (3800)	0.0005 (0.52)
1FT6 034 1FT6 041 1FT6 044 1FT6 061 1FT6 062	SPG 100-MF2	15.7 (7.1)	■	■	■	■	4500	2212 (250)	1349 (6000)	0.0015 (1.7) 0.0016 (1.8)	
1FT6 041 1FT6 044 1FT6 061 1FT6 062 1FT6 064	SPG 140-MF2	32 (14.5)	■	■	■	■	4000	4425 (500)	2023 (9000)	0.0039 (4.4) 0.0045 (5.1)	
1FT6 062 1FT6 064 1FT6 081 1FT6 082 1FT6 084 1FT6 086	SPG 180-MF2	64 (29)	■	■	■	■	4000	9735 (1100)	3147 (14000)	0.0049 (5.5) 0.0073 (8.2)	
1FT6 082 1FT6 084 1FT6 086 1FT6 102 1FT6 105	SPG 210-MF2	106 (48)	■	■	■	■	3500	16816 (1900)	4047 (18000)	0.0305 (34.5) 0.0315 (35.6)	
1FT6 084 1FT6 086 1FT6 102 1FT6 105 1FT6 108	SPG 240-MF2	154 (70)	■	■	■	■	3500	30094 (3400)	6070 (27000)	0.0381 (43.1) 0.0391 (44.2)	

Short code	V12	V13	V15	V16	V17
For gear shaft with featherkey	■	■	■	■	■
For gear shaft without featherkey	■	■	■	■	■

1) With SPG 060 and SPG 075: ≤ 8 arc min.

2) Guide values for the maximum permissible load on the midpoint of the output shaft at a speed *n*_{G2} = 300 rpm. Axial load *F*_a = 0.5 · *F*_r with SPG 075 to SPG 180. *F*_a = *F*_r with SPG 210 and SPG 240.



2-gear units (from ZF)

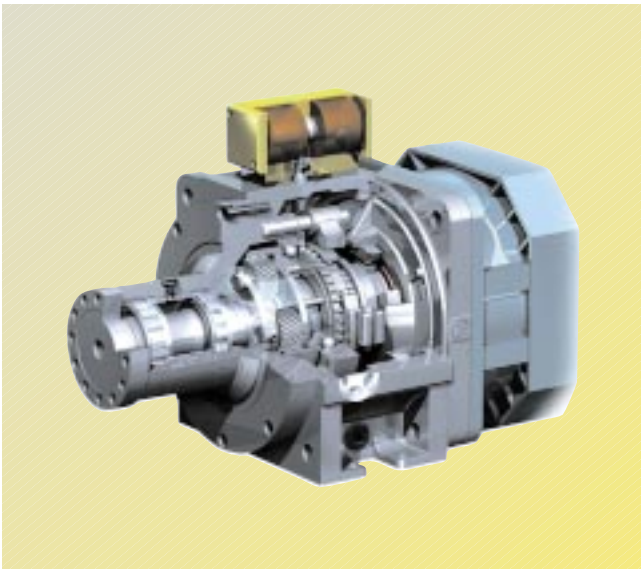

Fig. 4/8
Sectional view of a planetary gear unit

Change-speed gear units increase the drive torque at low motor speeds and expand the band of constant power output available from the asynchronous servomotors.

Technical features of the 2-gear units

- Drive power up to 134 HP (100 kW)
- Constant power band at drive shaft up to 1:24
- Bi-directional
- Motor frame sizes SH 100 to SH 225
- Types IM B 35 and IM V 15 (IM V 36 on request)
- Gearing efficiency >95%

Instead of V belts, the power output can also be transmitted from the gear drive output shaft by a spur gear pinion (available on request) or coaxially by means of a flexible coupling.

Installation, mode of operation

The 2-speed gear units have a planetary design. The central sun gear distributes the power to several planetary wheels which revolve around it. The outstanding advantage of this design is its compactness. The gear-changing device, a footed sleeve that moves axially, is of form-fit design.

Position 1:
Gear ratio $i_1 = 4$.

Position 2:
Gear ratio $i_2 = 1$.

The motor is flange-mounted onto the gear unit by means of a ring adapter. The AC motor must be suitably prepared for mounting.

At shaft heights of 160 mm and above, the type IM B 35 V 15 motor has to be supported at the non-drive end to prevent distortion.

Any cantilever forces imported into the gear unit have to be borne by the gear unit and transmitted to the machine base.

The motor for all 2K gear units must be full-key balanced with fitted key. Because the 2K 120, 2K 250 and 2K 300 gear units are enclosed, the motor flange is adequately sealed in the standard version.

Vertical mounting positions for the IM V 15 and IM V 36 require circulating oil lubrication of the gear units.

The standard version of the gear units up to and including the 2K 300 has a maximum torsional play of 30 angular minutes (measured at the gear unit output). The play is almost identical whatever the ratio. Various different special versions are available on request:

- Reduced play with special features: max. 20'
- Reduced play for high performance: max. 15'

The drive unit (i.e. the motor and gear unit) is supplied with vibration severity grade R according to EN 60034-14 (IEC 60034-14). This is also the case when the motor is ordered with grade S.

The belt pulley¹⁾ should be of the cup wheel type. For mounting the pulley, the output shaft on the gear unit has a flange with an external centering spigot and tapped holes. This ensures easy fitting and removal of the pulley.

1) Not included in scope of supply.

Servomotors Accessories

Built-on gears

Asynchronous Servomotors

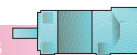

2-gear units (from ZF)

Motor Size	Gear unit Type	Order No.	Permissible max. speed $n_{max}^2)$	Permissible rated torque (S1 duty)			Permissible maximum torque (S6-60% duty)			Moment of inertia Gear unit		Gear unit weight Approx. kg
				Input n_{max} rpm	Input l_b -in (Nm)	Output $i_2 = 1$ l_b -in (Nm)	Output $i_1 = 4$ l_b -in (Nm)	Input l_b -in ² (Nm)	Output $i_2 = 1$ l_b -in ² (Nm)	Output $i_1 = 4$ l_b -in ² (Nm)	Output $i_2 = 1$ l_b -in-s ² (kgm ²)	
100	2K 120	2LG4 312 - . . .	8000	1062 (120)	1062 (120)	4248 (480)	1239 (140)	1239 (140)	4956 (560)	0.097 (0.011)	0.1009 (0.0114)	30
132	2K 250	2LG4 315 - . . .	6300	2213 (250)	2213 (250)	8850 (1000)	3540 (400)	3540 (400)	14160 (1600)	0.239 (0.027)	0.5044 (0.057)	62
160	2K 300	2LG4 320 - . . .	6300	2655 (300)	2655 (300)	10620 (1200)	3540 (400)	3540 (400)	14160 (1600)	0.239 (0.027)	0.5044 (0.057)	70
180	2K 800 2K 801	2LG4 250 - . . . 2LG4 260 - . . .	4000	7080 (800)	7080 (800)	28320 (3200)	7965 (900)	7965 (900)	31860 (3600)	1.731 (0.1956)	1.563 (0.1766)	110
225	2K 802	2LG4 270 - . . .	On requ.									

For further technical data and planning instructions (such as on lubrication, temperature rise and typical applications), please refer to Catalog No. 4161 757 701d supplied by ZF (Zahnradfabrik Friedrichshafen). The ratings of the motor and gear unit are the governing factor in the design of the complete power unit (that is the AC motor and gear unit).

In the case of motor 1PH4168 or 1PH7167-2.B, for example, the rated torque must be reduced to 300 Nm. In the case of the motors of frame size 132, it should be noted that with normal lubrication the speed of the 2K 240 gear unit is restricted to 6300 rpm.

The use of a gear unit permits the constant power band to be greatly increased.

Type for complete unit	Gear output shaft dimension D_2 (see page 8/38)	2-speed gear unit (standard version) ¹⁾ Gear stage $i_1 = 4$	ZF designation
	in (mm)	Order No.	
For 1PH7 10. / 1PH4 10. motors			
IM B 5/B 35/V 1/ V 15	3.94 (100)	2LG4 312-3CC31	2K 120
For 1PH7 13. / 1PH4 13. motors			
IM B 5/B 35	4.65 (118)	2LG4 315-3FD11	2K 250
IM V 1/V 15	4.65 (118)	2LG4 315-3FC11	2K 250
For 1PH7 16. / 1PH4 16. motors			
IM B 35	5.12 (130)	2LG4 320-3JD11	2K 300
IM V 15	5.12 (130)	2LG4 320-3JC11	2K 300
For 1PH7 184 motors			
IM B 35	7.09 (180)	2LG4 250-1JD11	2K 800
IM V 15	7.09 (180)	2LG4 250-1JC11	2K 800
For 1PH7 184 motors			
IM B 35	7.09 (180)	2LG4 260-1JD21	2K 801
IM V 15	7.09 (180)	2LG4 260-1JC21	2K 801

For further information about the gear units, please contact the manufacturer directly:

ZF Group North American Operations - Headquarters Florence, KY

7310 Turfway Road, Suite 450
Florence, KY 41042
Phone: (859) 282-4300
Fax: (859) 282-4311
<http://www.zf-group.com>

ZF Maschinenantriebe GmbH

D-88038 Friedrichshafen
Phone: +49 (0) 75 41-77-0
Fax: +49 (0) 75 41-77-90 80 00
<http://www.zf-group.de/zf-n>

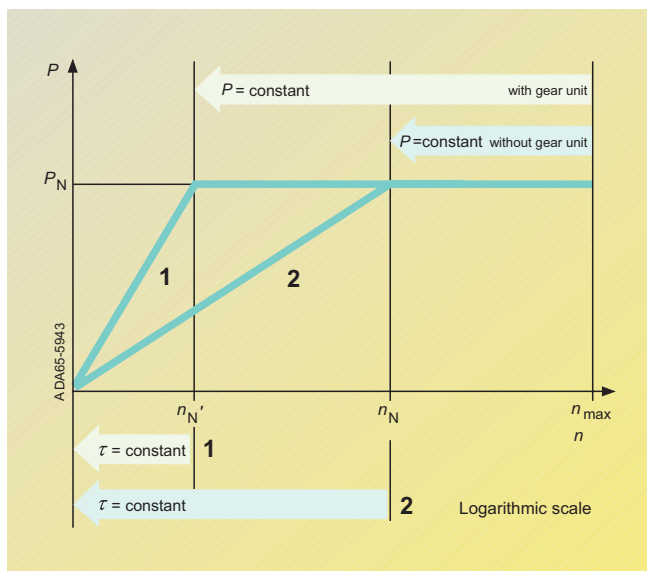

Fig. 4/9
Speed/power graph

Legend:

n_N	Rated speed
n_N'	Rated speed with 2-speed gear unit
n_{max}	Max. perm. speed
P_N	Rated speed and constant power of the motor in the speed range from n_N to n_{max} or n_N' to n_{max}
τ	Torque

1) Special versions such as gear units with different play, or other ratios ($i = 3.17$ or $i = 5.5$) are available on request.

2) Higher drive speeds are allowed for gear ratios in some instances with oil-cooled gear units (see the ZF catalog).

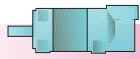

Asynchronous
Servomotors

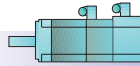

Synchronous
Servomotors

Built-on gears

Planetary gears made by Bayside Motion

The Bayside Motion Group offers planetary gearheads. The stealth helical planetary gears are well suited for use with the 1FK. and 1FT6 servomotors. For technical and selection information as well as mounting charts please contact Bayside directly at the following address:

Bayside Motion Group

27 Seaview Boulevard
Port Washington, NY 11050
Phone: (516) 484-5353
Fax: (516) 484-5496
<http://www.baysidemotion.com>

Important notes

If torque amplification elements are used such as gears, the increased mechanical stress must be borne by the gears and not by the motor.

The motor is dimensioned for mechanical stress in accordance with the maximum torque and the lateral-force diagram (chapter 7).

Planetary gears and spur-gear units from other gear manufacturers

You can, of course, contact other gear manufacturers in order to find a useful combination of SIEMENS servomotors and gear units.

Planetary gears and spur-gear units from Heynau Antriebstechnik GmbH

The 1FK., 1FT6, 1PH7 and 1PH4 motors can be combined with planetary gears of the EPR and FPR series to form compact, coaxial drive units. The EPR series with output shaft and the FPR series with output flange can be directly mounted onto the D-end of the motors. Spur-gear units of the GC series are also available for D-end mounting.

Technical characteristics:

Planetary gears

Transmission ratio:
single-stage $i = 4$ to 10 ,
2-stage $i = 16$ to 100
Max. permissible output torque: 45 to 3750 Nm
Torsional play:
single-stage < 3 arc min,
2-stage < 5 arc min
Efficiency, single-stage: 98%

Spur-gear units

Transmission ratio:
single-stage $i = 3$ to 7 ,
2-stage $i = 8$ to 30
Max. permissible output torque: 9 to 1500 Nm
Torsional play: < 10 arc min
Efficiency: 98% per stage

For planning and selecting gears in combination with SIEMENS servomotors, please contact:

Heynau Antriebstechnik GmbH
Herr Gunter Bever
Hofmark-Aich-Strasse 25
84030 Landshut
Federal Republic of Germany
Phone: +49-8717801-144
Fax: +49-8717801-140

Harmonic Drive gear units

HD Systems, Inc.
89 Cabot Court
Hauppauge, New York,
N.Y. 11788
USA
Phone: (631) 231-6630
Fax: (631) 231-6803
<http://www.HDSYSTEMSINC.COM>

Harmonic Drive
Antriebstechnik GmbH
Hoenbergstrasse 14
65555 Limburg
Federal Republic of Germany
Phone: +49-64315008-0
Fax: +49-64315008-18

Low-play planetary gear units

Umbach Servogetriebe
GmbH & Co. KG
Herr Kübler
Hinter dem Schloss 16c
74906 Bad Rappenau
Federal Republic of Germany
Phone: +49-726491-3551
Fax: +49-726491-4040

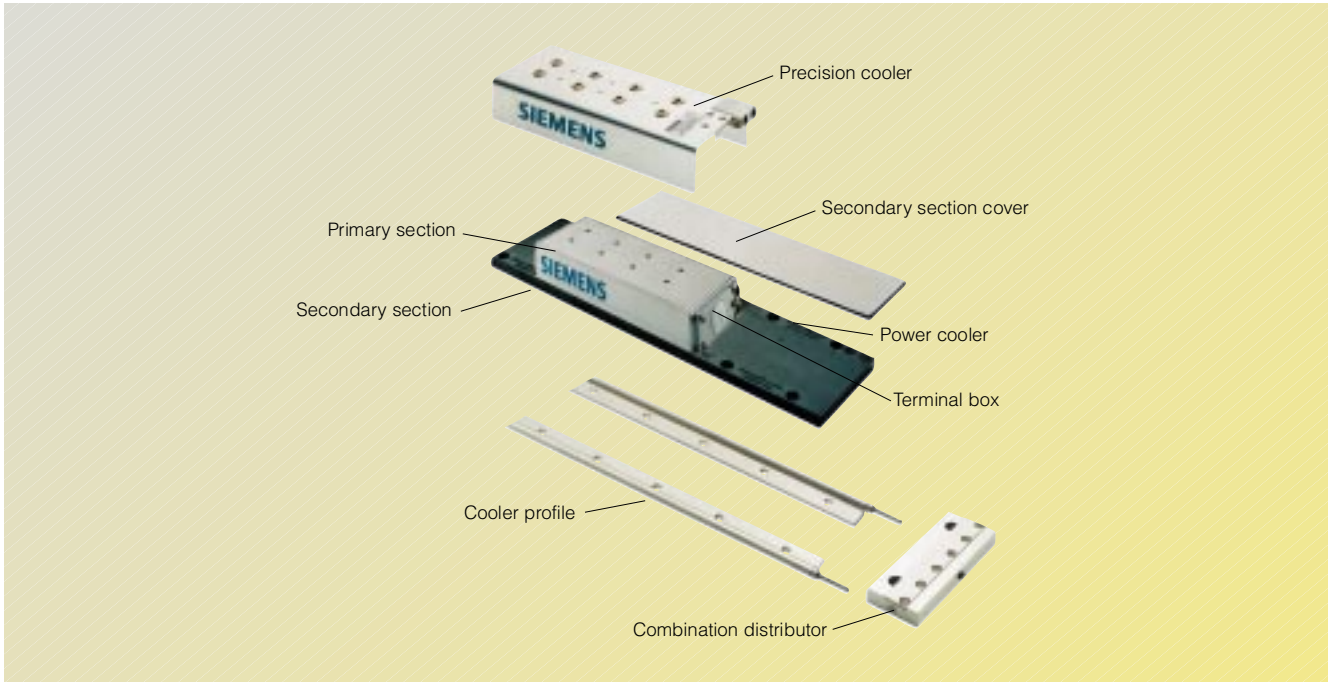

Fig. 4/10
Accessories for 1FN3 AC linear motors

4

Optional coolers

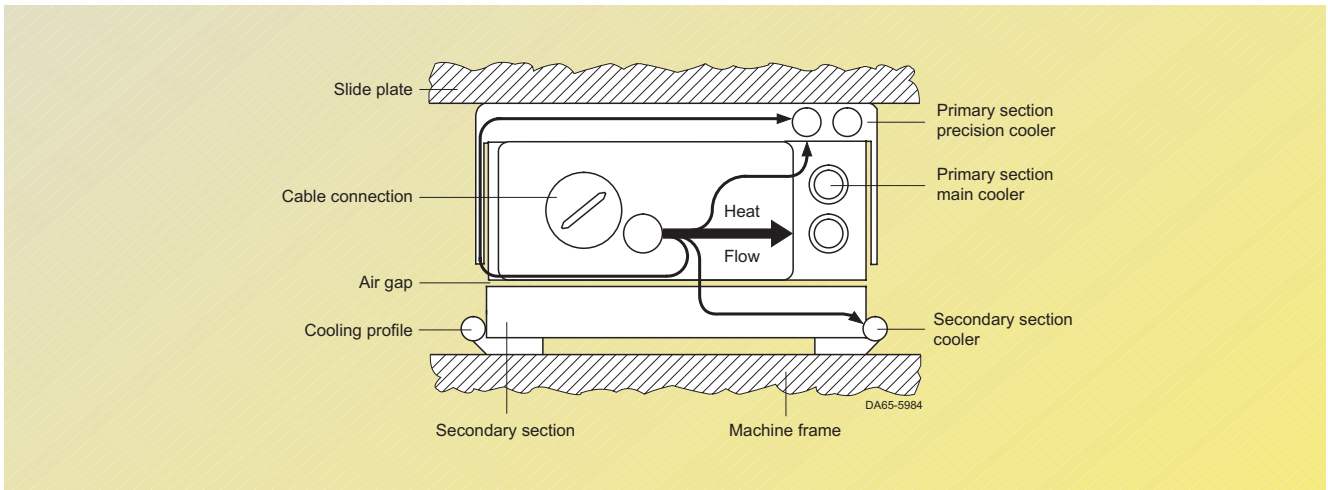

Fig. 4/11
Optional coolers

In spite of water cooling, temperatures of up to 248 °F (120 °C) occur inside the primary sections due to the high force densities of the motor. In order to prevent these temperatures having a negative impact on the machine precision, 1FN3 motors can be thermally and completely encapsulated against the environment using the thermo

sandwich® principle using the optional secondary section cooler and precision cooler. The inner cooling circuit (main cooler) dissipates the largest proportion of the power loss P_{VN} of the primary section and protects the primary section winding against overheating (refer to Section "Technical data").

The main cooler of the primary section must be operated with water cooling in order to be able to utilize the rated force F_N of the motor, specified in the data sheets (without water cooling, and depending on the convection situation and machine construction, only approx. 50% of the rated force F_N acc. to the data sheet).

Note

For motors from frame size 600, secondary section cooling is mandatory to be able to use the rated force F_N (acc. to the data sheet). This is because the power loss cannot be adequately dissipated without water cooling.

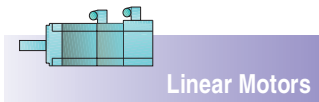

Accessories for 1FN3 AC linear motors

Precision cooler (optional)

Supplementary cooler to cool the primary section according to the thermo sandwich® concept. This is recommended for applications with high thermal requirements regarding the machine precision.

The precision cooler on the upper motor section shields the environment against the high motor temperatures. Thermal insulators at the glands and the intermediate air chambers reduce the heat transfer from the primary section.

The insulating function is provided by an air gap at the lower side of the primary section.

The lateral heat radiation sheets of the precision cooler also form air-filled intermediate spaces, which insulate the primary section sides from the machine itself. Thus, the primary section is encapsulated by a thermal insulation on all sides.

The precision cooler dissipates the residual heat, which is transferred due to thermal radiation and conduction. This means, that the mounting surface temperature and the outer surface of the primary section can be kept constant in a tolerance bandwidth of between 0 and 3 K (referred to the intake temperature) under all operating conditions.

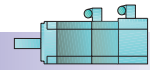

Fig. 4/12
Precision cooler

Linear motors Type	Optional components Precision cooler Order No.
1FN3 050-2W	1FN3 050-2PK00-0AA0
1FN3 100-2W	1FN3 100-2PK00-0AA0
1FN3 100-3W	1FN3 100-3PK00-0AA0
1FN3 100-4W	1FN3 100-4PK00-0AA0
1FN3 100-5W	1FN3 100-5PK00-0AA0
1FN3 150-2W	1FN3 150-2PK00-0AA0
1FN3 150-3W	1FN3 150-3PK00-0AA0
1FN3 150-4W	1FN3 150-4PK00-0AA0
1FN3 150-5W	1FN3 150-5PK00-0AA0
1FN3 300-2W	1FN3 300-2PK00-0AA0
1FN3 300-3W	1FN3 300-3PK00-0AA0
1FN3 300-4W	1FN3 300-4PK00-0AA0
1FN3 450-2W	1FN3 450-2PK00-0AA0
1FN3 450-3W	1FN3 450-3PK00-0AA0
1FN3 450-4W	1FN3 450-4PK00-0AA0
1FN3 600-3W	1FN3 600-3PK00-0AA0
1FN3 600-4W	1FN3 600-4PK00-0AA0
1FN3 900-2W	1FN3 900-2PK00-0AA0
1FN3 900-4W	1FN3 900-4PK00-0AA0

Servomotors Accessories

Accessories for 1FN3 AC linear motors



Linear Motors

Cooling profiles with plug or hose connection (optional)

The total maximum heat transfer to the secondary section is less than 10% of the total power loss of the linear motor. The secondary section can be cooled and thermally insulated by using cooling profiles between the secondary section and machine according to the thermo sandwich® principle.

Aluminum profile rails with continuous cooling ducts. They are placed under the secondary sections if high thermal requirements are placed on the machine accuracy. The cooling profiles are part of the secondary section cooling together with the secondary section end pieces.

The surface of the cooling profiles are thermally optimized. The contact surface to the secondary section absorbs the heat and transfers it to the cooling duct. On the other hand, the contact surface to the machine is low to minimize heat transfer to the machine itself.

We recommend that thermal insulation and secondary section cooling is used under the following criteria:

- Requirement for minimum heat transfer of the secondary sections to the machine (e.g. low distortion as a result of thermal effects).

- High power loss transfer to the secondary section (at high continuous feed force for short traversing paths and high continuous velocities).
- 1FN3 motors from frame size 600 (necessarily to use rated force F_n).

Warning

During linear motor operation, the secondary section may not exceed the maximum temperature of 140 °F (60 °C), as otherwise the permanent magnets could be demagnetized.

Selection of cooling profiles

Cooling profiles for secondary section cooling can be used with or without combination-distributors. For use together with a combination-distributor, it is necessary to have the cooling profile selected with plug connections to make the connection to the combination-distributor. If the cooling profile is used without combination-distributor, then the end pieces of the profile must have hose sleeve nipples to accommodate a direct hose connection.

Cooling profiles with plug connection

The table shows the available cooling profiles with plug connection to a combination-distributor.

Linear motor Type	Cooling profile with plug connection Order No. ¹⁾	Combination-distributor Order No. ²⁾
1FN3 050-...		1FN3 050-OT.01-0AA0
1FN3 100-...	1FN3 002-OTK04-1..0	1FN3 100-OT.01-0AA0
1FN3 150-...		1FN3 150-OT.01-0AA0
1FN3 300-...		1FN3 300-OT.01-0AA0
1FN3 450-...	1FN3 003-OTK04-1..0	1FN3 450-OT.01-0AA0
1FN3 600-...	1FN3 004-OTK04-1..0	1FN3 600-OT.01-0AA0
1FN3 900-...	1FN3 005-OTK04-1..0	1FN3 900-OT.01-0AA0

Length code

When ordering a cooling profile you must match the length of it to the length of the secondary section. The length of the secondary section (permanent magnets) is determined by the motor size and the number of secondary sections used. That means when you select the cooling profile for your motor size you have to specify in the 14th and 15th digit of the part number the length of the cooling profile by indicating the numbers of secondary sections used. To indicate the length the following length code is used.

For all motor sizes (050 to 900)

Number of secondary sections	Length code
1	AB
2	AC
3	AD
4	AE
5	AF
6	AG
7	AH
8	AJ
9	AK
10	BA
11	BB
12	BC
13	BD
14	BE
15	BF
16	BG

Only for motor sizes 050 to 150

Number of secondary sections	Length code
17	BH
18	BJ
19	BK
20	CA
21	CB
22	CC
23	CD
24	CE

The maximum length of a single cooling profile is 9.84 ft (3 m), which corresponds to 16 secondary segments for motor sizes 300 to 900 and up to 24 segments for sizes 050 to 150. For lengths above 9.84 ft (3 m) the cooling profile has to be split.

1) For the complete order number see length code below.

2) For the complete order number refer to the paragraph combination-distributor in this section.

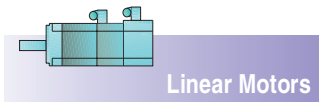

Cooling profiles with plug connection

Example 1

A 1FN3 600-3WB00-0AA1 is used with 4 secondary sections. The part number for the two cooling profiles with plug connection to a combination-distributor is therefore 1FN3 004-0TK04-1**AE**0.

The quantity necessary for this motor size is three of each cooling profile since they are placed underneath both sides and the middle of the secondary section (see Fig. 4/13).

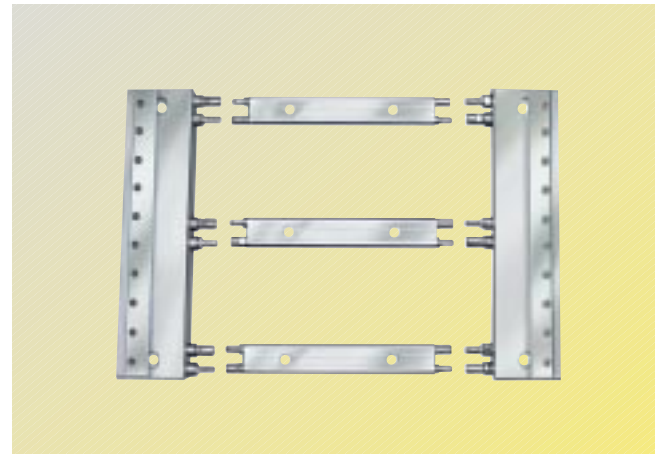

Fig. 4/13
Cooling profile with connector plugs (unconnected) and combination-distributor on each side. Total length >9.84 ft (3 m).

Example 2

A 1FN3 150-2WC00-0AA1 is used with 27 secondary sections. 27 sections exceed the length of 9.84 ft (3 m) or 24 segments for this motor size. Hence the cooling profile has to be split into 2 pieces with any length combination that adds up to the total of 27 secondary units. The part number for the two cooling profiles with

plug connection to a combination-distributor could be for instance 1FN3 004-0TK04-1**BD**0 (13 unit lengths) and 1FN3 002-0TK04-1**BE**0 (14 unit lengths). For this motor size the quantity two of the specified cooling profile part numbers is necessary since the profiles go under each side of the secondary section (see Fig. 4/14).

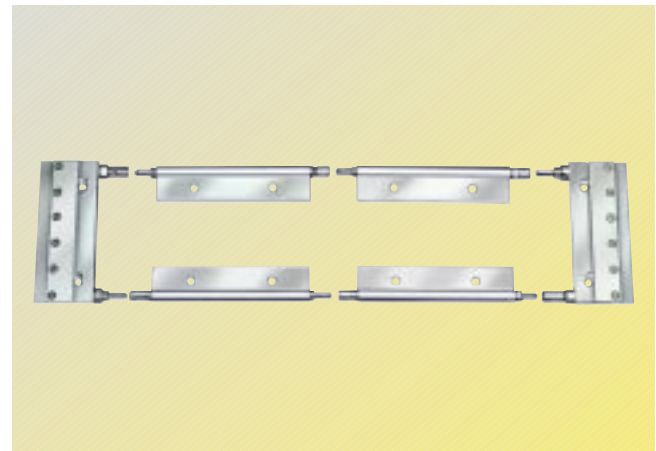
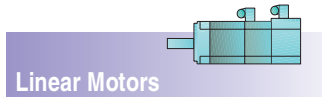

Fig. 4/14
Cooling profile with connector plugs (unconnected) and combination-distributor on each side. Total length <9.84 ft (3 m).

Servomotors Accessories

Accessories for 1FN3 AC linear motors



Cooling profiles without combination-distributor (direct hose connection via hose sleeve nipples)

For the connection of the cooling circuit via a hose directly to the cooling profiles, it is necessary to have the ends of the cooling profiles equipped with hose sleeve nipples for a direct hose connection. For this purpose, there are cooling profiles with hose sleeve nipples on both ends.

If the length of the required cooling profile exceeds 9.84 ft (3 m), the cooling profile needs to be split in two or more pieces. To allow an easy connection between these pieces, there are cooling profiles available with a hose sleeve nipple on one side and the plug connection on the other side. The cooling profile form for motors in size 050 to 450 makes it necessary to differentiate between cooling profiles with a hose sleeve nipple on the right (R) and on the left (L) side (see Fig. 4/15). Cooling profiles for size 600 and 900 motors do not have that restriction and can be used Right or Left (R/L) (see Fig. 4/16).

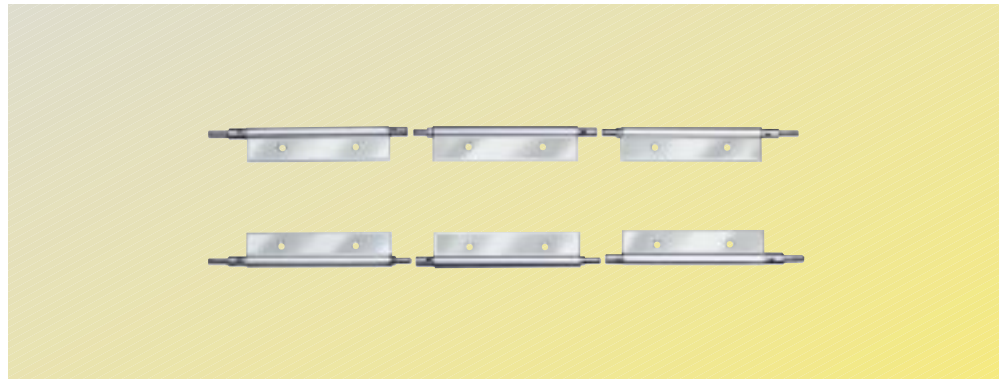

Fig. 4/15
Cooling profile with connector plug and hose sleeve nipple for size 050 to 450.
Total length >9.84 ft (3 m).

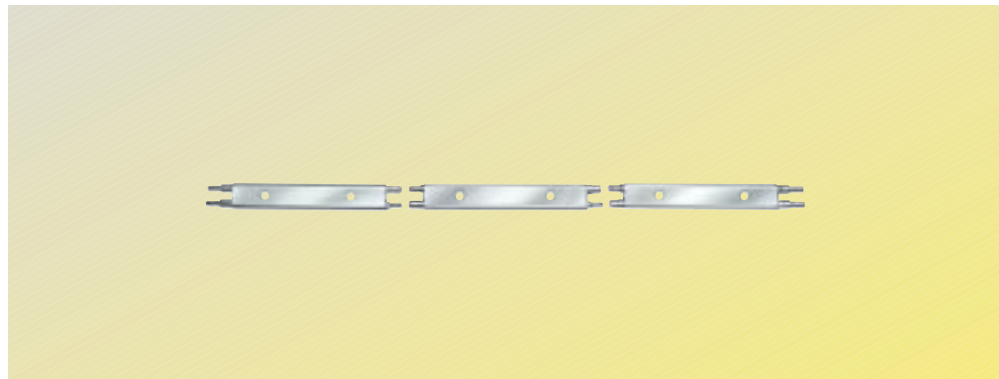
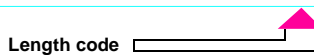

Fig. 4/16
Cooling profile with connector plug and hose sleeve nipple for size 600 and 900.
Total length >9.84 ft (3 m).

4

Linear motor Type	Cooling profile with hose sleeve nipple on both ends Order No. ¹⁾	Cooling profile with hose sleeve nipple on Right (R) Order No. ²⁾	Cooling profile with hose sleeve nipple on Left (L) Order No. ²⁾
1FN3 050-...			
1FN3 100-...	1FN3 002-0TK02-1..0	1FN3 002-0TK06-1AC0	1FN3 002-0TK07-1AC0
1FN3 150-...			
1FN3 300-...			
1FN3 450-...	1FN3 003-0TK02-1..0	1FN3 003-0TK06-1AC0	1FN3 003-0TK07-1AC0
1FN3 600-...	1FN3 004-0TK02-1..0	1FN3 004-0TK06-1AC0	1FN3 004-0TK06-1AC0
1FN3 900-...	1FN3 005-0TK02-1..0	1FN3 005-0TK06-1AC0	1FN3 005-0TK06-1AC0



1) For the complete order number see length code in "cooling profiles w/ plug connection" paragraph.
2) Cooling profiles with hose sleeve nipple have a fixed length of 2 secondary section lengths.

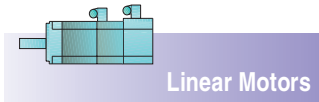

Accessories for 1FN3 AC linear motors

Secondary section end pieces (optional)

Secondary section end pieces are available in four versions. Combination-distributor, combination-adapter and

combination end piece are equipped with plug connections to connect to the cooling profiles. The

cover end piece is only used to hold down the optional secondary section cover.

Combination-distributor

For parallel water connection through the cooling profiles on all motor sizes (050 to 900). It has the following functions:

- Retains the secondary section cover at the beginning and at the end of the secondary section track.

- Connects and branches the cooling-medium to the two cooling profiles at the beginning of the secondary section track.
- Combines the cooling-medium flow and connects the cooling-medium discharge at the end of the secondary section track.

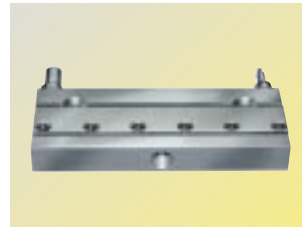

Fig. 4/17

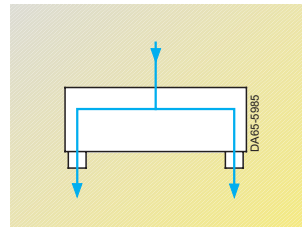

Fig. 4/18

Combination-adapter

Provides connection for the cooling-medium intake and discharge for serial water connection through the cooling profiles for motor sizes 050 to 450. It has the following functions:

- Retains the secondary section cover

- Cooling-medium connection
 - Cooling-medium routing
- The pressure loss for this system is significantly higher than when cooling using the combination-distributors, and must therefore be carefully checked.

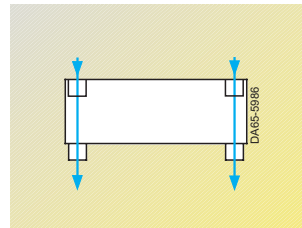

Fig. 4/19

Combination end piece

The combination end piece is required to route the cooling-medium at the order end of the

secondary section track when serial water connection is used (only in combination with a combination-adapter).

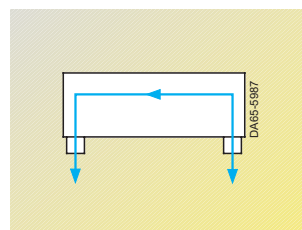

Fig. 4/20

Cover end piece

For holding down the optional secondary section cover (only necessary if

secondary section cover and no combination-distributor or adapter is used).

Secondary section end pieces	Motor sizes	Part No.
Combination-distributor	050, 100, 150, 300, 450, 600, 900	1FN3...-0TJ01-0AA0
Combination-adapter	050, 100, 150, 300, 450	1FN3...-0TG01-0AA0
Combination end piece	050, 100, 150, 300, 450	1FN3...-0TF01-0AA0
Cover end piece	050, 100, 150, 300, 450, 600, 900	1FN3...-0TC01-0AA0

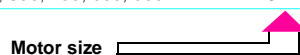

Servomotors Accessories

Accessories for 1FN3 AC linear motors

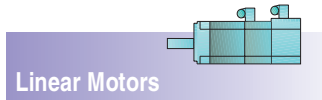

Secondary section cover (optional)

Continuous protection for the permanent magnets of the secondary section, manufactured from semi-magnetic stainless steel plates. They attach themselves to the secondary

section magnets so that when worn they can be changed without any other tools.

The cover is one continuous piece and matched to the length of the secondary

section by indicating the numbers of secondary sections used in the 14th and 15th digit of the part number.

	Motor sizes	Part No.
Secondary section cover	050, 100, 150, 300, 450, 600, 900	1FN3...-0TB00-1 . . 0

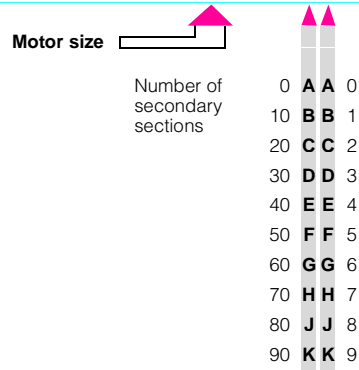

4

The secondary section cover is also available as a segmented cover over 3, 4 or 5 secondary sections:

	Motor sizes	Part No.
Secondary section cover	050, 100, 150, 300, 450, 600, 900	1FN3...-4TP00-1A . 0

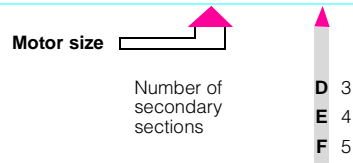

Page 4/25 gives a complete overview of the available optional components for 1FN3 linear motors.

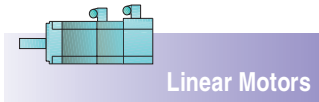

Optional components for 1FN3 AC linear motors

Ordering and planning data (overview)

Linear motors Type	Optional components Precision cooler Order No.	Secondary section end pieces Order No.	Cooling profile ¹⁾ Order No.	Secondary side cover Order No.
1FN3 050-2W	1FN3 050-2PK00-0AA0	1FN3 050-0T□0□-0AA0	1FN3 002-0TK0□-1□□0	1FN3 050-□□□00-1□□0
1FN3 100-2W	1FN3 100-2PK00-0AA0	1FN3 100-0T□0□-0AA0	1FN3 002-0TK0□-1□□0	1FN3 100-□□□00-1□□0
1FN3 100-3W	1FN3 100-3PK00-0AA0			
1FN3 100-4W	1FN3 100-4PK00-0AA0			
1FN3 100-5W	1FN3 100-5PK00-0AA0			
1FN3 150-2W	1FN3 150-2PK00-0AA0	1FN3 150-0T□0□-0AA0	1FN3 002-0TK0□-1□□0	1FN3 150-□□□00-1□□0
1FN3 150-3W	1FN3 150-3PK00-0AA0			
1FN3 150-4W	1FN3 150-4PK00-0AA0			
1FN3 150-5W	1FN3 150-5PK00-0AA0			
1FN3 300-2W	1FN3 300-2PK00-0AA0	1FN3 300-0T□0□-0AA0	1FN3 003-0TK0□-1□□0	1FN3 300-□□□00-1□□0
1FN3 300-3W	1FN3 300-3PK00-0AA0			
1FN3 300-4W	1FN3 300-4PK00-0AA0			
1FN3 450-2W	1FN3 450-2PK00-0AA0	1FN3 450-0T□0□-0AA0	1FN3 003-0TK0□-1□□0	1FN3 450-□□□00-1□□0
1FN3 450-3W	1FN3 450-3PK00-0AA0			
1FN3 450-4W	1FN3 450-4PK00-0AA0			
1FN3 600-3W	1FN3 600-3PK00-0AA0	1FN3 500-0T□0□-0AA0	1FN3 004-0TK0□-1□□0	1FN3 600-□□□00-1□□0
1FN3 600-4W	1FN3 600-4PK00-0AA0			
1FN3 900-2W	1FN3 900-2PK00-0AA0	1FN3 900-0T□0□-0AA0	1FN3 004-0TK0□-1□□0	1FN3 900-□□□00-1□□0
1FN3 900-4W	1FN3 900-4PK00-0AA0			

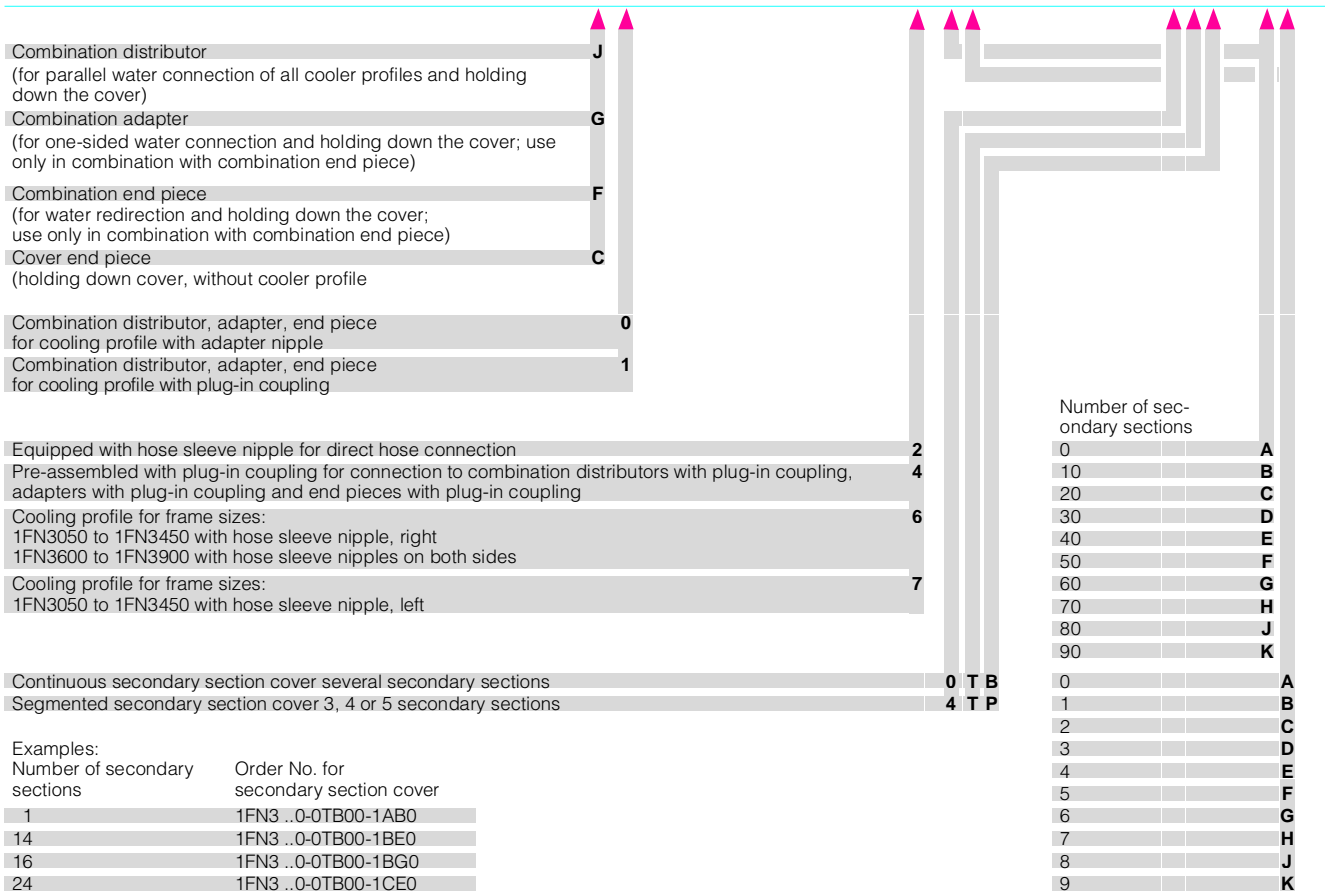

1) Frame sizes
1FN3 050 to 1FN3 450:
2 pieces per secondary section track
1FN3 600 to 1FN3 900:
3 pieces per secondary section track

The maximum length of a single-section cooling profile that can be supplied is 9.84 ft (3 m). For the following frame sizes this corresponds to:

- 1FN3050 1FN3150 a maximum number of 24 secondary sections (AB to CE)
- 1FN3300 to 1FN3900 a maximum number of 16 secondary sections (AB to BG).

Servomotors Accessories

Notes

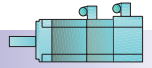

Linear Motors

4

Servomotors

Connecting Systems



Power cables

MOTION-CONNECT® 500, 700 and 800

- 5/2 6FX5, 6FX8 and 6FX7, technical data
- 5/3 6FX5, 6FX8 and 6FX7, connection overview
- 5/4 • for 1FK., 1FT6, 1FS6, 1PH., 1PL6
- 5/6 6FX7, for 1FN3 linear motors, sold by the meter
- 5/7 • for 1PH7, 1PL6 and 1PH4 induction motors
Flange for signal plug

Encoder cables

- 5/8 • for connection to motors with an incremental encoder HTL
- 5/9 • for connection to motors with a resolver 2-pole /multi-pole
- 5/10 • for connection to motors with a sin/cos incremental encoder 1 V_{pp}
- 5/11 • for connection to motors with an absolute-value encoder (EnDat)
- 5/12 • for 1FN3 AC linear motors
- 5/14 • for SIMODRIVE 611 universal

Cables

- 5/15 • for SIMODRIVE POSMO CD/CA, SI

Servomotors Connecting Systems

Power cables
MOTION-CONNECT 500, 700 and 800

Synchronous
Servomotors

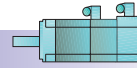

Asynchronous
Servomotors

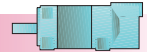

6FX5, 6FX8 and 6FX7 power cables, technical data

The new MOTION-CONNECT 6FX5 and 6FX8 cables replace the former standard (6FX4) as well as performance cables (6FX2) and add the new 6FX7 power cables with 4 temperature leads especially designed for 1FN3 linear motor applications.

MOTION-CONNECT meets the DESINA color requirements, orange jacket for servo and frequency controlled drive power cables and green jacket for measurement cables like encoder cables.

The cost-effective 6FX5 standard cable is generally permanently routed while the performance 6FX8 cable can be universally used in fixed as well as in moving applications where the cable may be flered up to 10 million times (core cross section $\leq 6 \text{ mm}^2$) during their life cycle.

Furthermore the performance cable 6FX8 has compared to the standard cable higher operating temperature ratings, significant better acceleration

values and permissible traveling speeds, an increased oil resistance and is halogen / silicon-free.

The 6FX5, 6FX8 and 6FX7 cables are sold by the meter but can also be supplied as prefabricated cables (with mounted connectors).

The prefabricated cables with connectors offer the following advantages:

- The exact length can be ordered to the meter.

- They are subject to extensive tests, thus ensuring outstanding quality.

- They are safe and reliable as they are optimally matched to the components which have to be connected.

- The savings in logistics, construction and purchasing reduce overall costs.

The 6FX cables, prefabricated and sold by the meter, are described in detail on the following pages.

Technical data

Cables	MOTION-CONNECT 500 6FX5 00.-.... type	MOTION-CONNECT 800 6FX8 00.-.... type	MOTION-CONNECT 700 6FX7 00.-.... type
Certifications			
Power/signal cables			
• VDE ¹⁾	yes	yes	yes
• c/UL or UL/CSA	758/C22.2N.210.2-M9C	758/C22.2N.210.2-M9C	758/C22.2N.210.2-M9C
• UL/CSA File No. ²⁾	yes	yes	yes
Electrical data acc. to DIN VDE 0472			
Rated voltage			
• power cable V_p/V			
– supply cores	600/1000 V	600/1000 V	600/1000 V
– signal cores	24 V (VDE) 1000 V (UL)	24 V (VDE) 1000 V (UL/CSA)	24 V (VDE) 1000 V (UL/CSA)
• signal cable	30 V	30 V	–
Test voltage			
• power cable			
– supply cores	2 kV _{eff}	4 kV _{eff}	4 kV _{eff}
– signal cores	1 kV _{eff}	2 kV _{eff}	2 kV _{eff}
• signal cable	500 V _{eff}	500 V _{eff}	–
Operating temperature			
on the surface			
• fixed cable	–4 °F to 176 °F (–20 °C to +80 °C)	–58 °F to 176 °F (–50 °C to +80 °C)	–58 °F to 176 °F (–50 °C to +80 °C)
• moving cable	32 °F to 140 °F (0 °C to +60 °C)	–4 °F to 140 °F (–20 °C to +60 °C)	–4 °F to 140 °F (–20 °C to +60 °C)
Mechanical data			
Max. tensile stress			
Power/signal cables:			
• fixed cable	7252 lb _f /in ² (50 N/mm ²)	7252 lb _f /in ² (50 N/mm ²)	7252 lb _f /in ² (50 N/mm ²)
• moving cable	–	2900 lb _f /in ² (20 N/mm ²)	2900 lb _f /in ² (20 N/mm ²)
Smallest permissible bending radius			
• fixed cable (power cable)	$5 \times D_{\max}$	$6 \times D_{\max}$	$4 \times D_{\max}$
• fixed cable (signal cable)	2.4 in (60 mm)	2.4 in (60 mm)	–
• moving cable (power cable)	–	–	–
• moving cable (signal cable)	7.1 in (180 mm)	3.9 in (100 mm)	–
Torsional stress			
	30 °/m absolute	30 °/m absolute	30 °/m absolute
Bends			
• 1.5 to 6 mm ² or signal	100.000	10 Mio.	10 Mio.
• 10 to 185 mm ²	100.000	3 Mio.	10 Mio.
Traverse rate			
• 1.5 to 6 mm ² or signal	98 ft/min (30 m/min)	591 ft/min (180 m/min)	656 ft/min (200 m/min)
• 10 to 185 mm ²	98 ft/min (30 m/min)	328 ft/min (100 m/min)	656 ft/min (200 m/min)
Acceleration			
	6.6 ft/s ² (2 m/s ²)	16 ft/s ² (5 m/s ²)	98 ft/s ² (30 m/s ²)
Chemical data			
Insulation material			
	CFC-free, silicone-free	halogen-free, CFC-free, silicone-free, DIN 472 815/IEC 754-1	halogen-free, CFC-free, silicone-free, DIN 472 815/IEC 754-1
Oil resistance			
	VDE 0472, part 803, type of test B (only hydraulic oil)	VDE 0472, part 803, type of test B	VDE 0472, part 803, type of test B
Outer sheath			
• power cable	PVC, color DESINA: orange RAL 2003	PUR DIN VDE 0282, part 10, color DESINA: orange RAL 2003	PUR DIN VDE 0282, part 10, color DESINA: orange RAL 2003
• signal cable	PVC, color DESINA: green RAL 6018	PUR DIN VDE 0282, part 10, color DESINA: green RAL 6018	–
Flame resistant			
	IEC 60 332.1	IEC 60 332.1	IEC 60 332.1

The cables are not suitable for exposure to outdoor use.

The technical data of these cables only apply to single bends with horizontal travel of up to five meters.

Degree of protection for the customized power and signal cables and their extension cables **when closed and plugged: IP 67**

1) The corresponding registration numbers are printed on the cable sheath.

2) The file no. of the respective manufacturers are printed on the cable sheath.



Asynchronous Servomotors

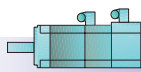

Synchronous Servomotors

Servomotors Connecting Systems

Power cables
MOTION-CONNECT 500, 700 and 800

6FX5, 6FX8 and 6FX7, connection overview

SIMOVERT MASTERDRIVES Motion Control

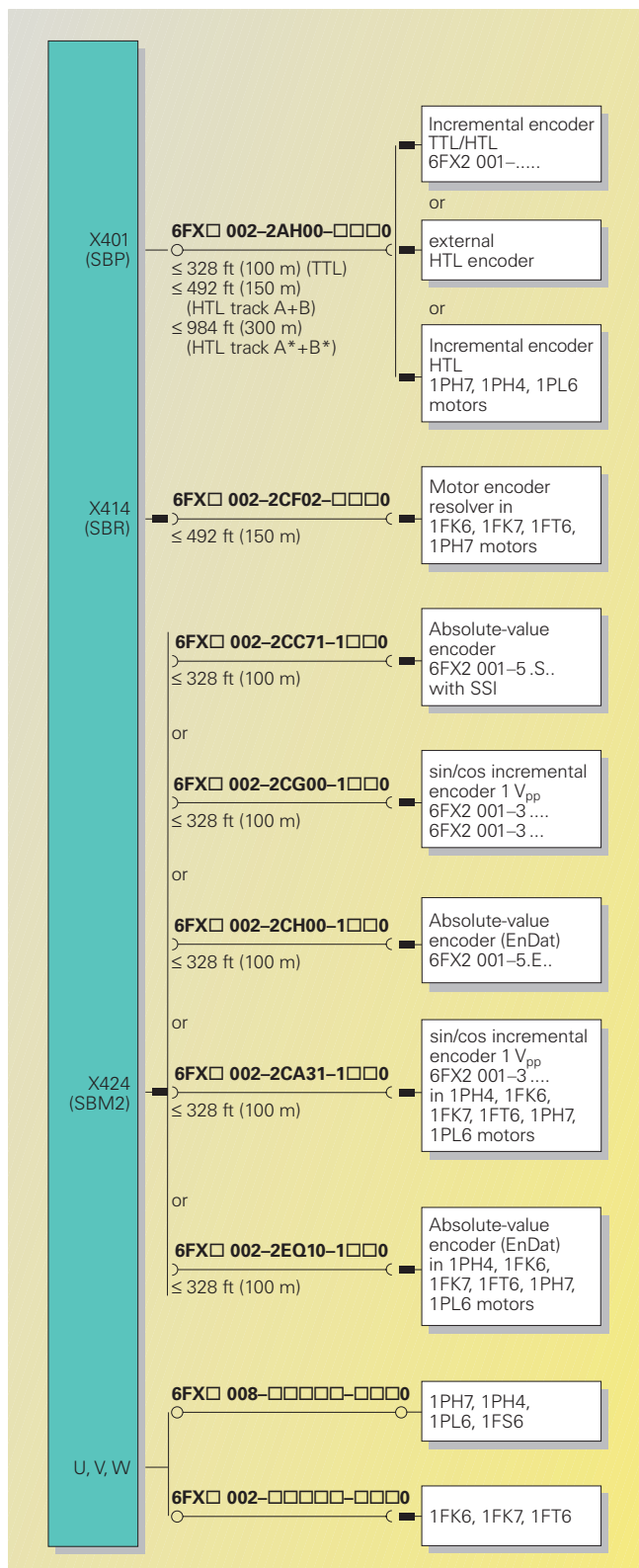

- Max. 492 ft (150 m) for HTL, supplementary board DTI essential for:
 - TTL encoders
 - requested electrical isolation
 - Length > 492 ft (150 m)
- Track A, B, N and A*, B*, N*
- Track A, B

SIMOVERT MASTERDRIVES Vector Control

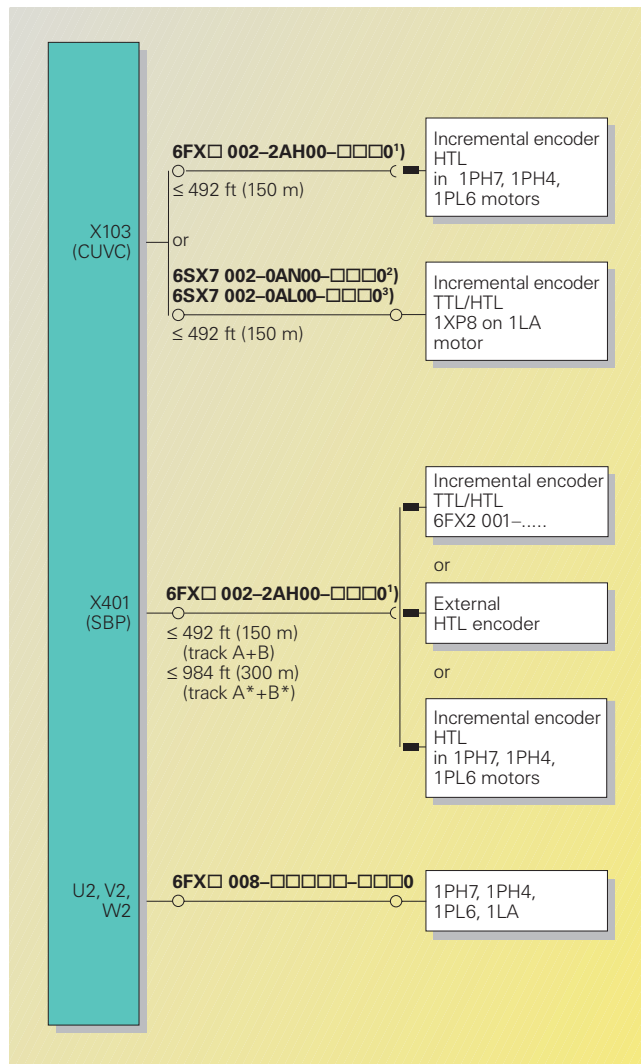

Current carrying capacity (I_z) of PVC-insulated copper conductors acc. to IEC 60 204-1: 1997 ++ Corrigendum 1998 · Correction factors

Cross-section mm ²	Current carrying capacity I_z with installation type C A	Ambient air temperature °C	Correction factor
0.75	-	30	1.15
1.0	11.7	35	1.08
1.5	15.2	40	1.00
2.5	21	45	0.91
5	28	50	0.82
6	36	55	0.71
10	50	60	0.58
16	66		
25	84		
35	104		
50	123		
70	155		
95	192		
120	221		

Note:
The correction factors are taken from IEC 60 364-5-523, table 52-D1.

5

Servomotors Connecting Systems

Power cables
MOTION-CONNECT 500 and 800

Synchronous
Servomotors

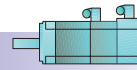

Asynchronous
Servomotors



Power cables for 1FK., 1FT6, 1FS6, 1PH., 1PL6

6FX□ 002-5DA . .
with braking cable, with shield

Motor current I_o A	No. of cores x cross section mm ²	Con- nec- tor size	Prefabricated cables ²⁾		D_{max} 6FX8		6FX5	
			Order No.	in (mm)	in (mm)	in (mm)	in (mm)	
15.2	4x1.5+2x1.5	1	6FX□ 002-5DA01-□□□□	0.51	0.52	(12.9)	(13.1)	
			1.5	6FX□ 002-5DA21-□□□□				
21	4x2.5+2x1.5	1	6FX□ 002-5DA11-□□□□	0.56	0.56	(14.2)	(14.2)	
			1.5	6FX□ 002-5DA31-□□□□				
28	4x4+2x1.5	1.5	6FX□ 002-5DA41-□□□□	0.6	0.63	(15.3)	(15.9)	
			1.5	6FX□ 002-5DA51-□□□□				
36	4x6+2x1.5	1.5	6FX□ 002-5DA13-□□□□	0.82	0.85	(20.8)	(21.7)	
			1.5	6FX□ 002-5DA61-□□□□				
50	4x10+2x1.5	3	6FX□ 002-5DA23-□□□□	0.97	0.95	(24.7)	(24.2)	
			3	6FX□ 002-5DA33-□□□□				
66	4x16+2x1.5	3	6FX□ 002-5DA43-□□□□	1.1	1.16	(27.9)	(29.4)	
			3	6FX□ 002-5DA53-□□□□				
84	4x25+2x1.5	3	6FX□ 002-5DA43-□□□□	1.26	1.28	(32)	(32.6)	
			3	6FX□ 002-5DA53-□□□□				
104	4x35+2x1.5	3	6FX□ 002-5DA43-□□□□	1.41	1.5	(35.8)	(38)	
			3	6FX□ 002-5DA53-□□□□				

6FX□ 008-1BA . .
with braking cable, with shield

Cable by the meter	Weight ¹⁾		Smallest permissible bending radius	
	6FX8 lb/ft (kg/m)	6FX5 lb/ft (kg/m)	6FX8 in (mm)	6FX5 in (mm)
6FX□ 008-1BA11-□□□□	0.17 (0.25)	0.15 (0.22)	4.92 (125)	9.45 (240)
6FX□ 008-1BA21-□□□□	0.21 (0.31)	0.19 (0.28)	5.51 (140)	10.24 (260)
6FX□ 008-1BA31-□□□□	0.27 (0.4)	0.24 (0.36)	5.91 (150)	11.42 (290)
6FX□ 008-1BA41-□□□□	0.36 (0.53)	0.36 (0.54)	7.68 (195)	12.01 (305)
6FX□ 008-1BA51-□□□□	0.5 (0.74)	0.5 (0.75)	9.06 (230)	15.55 (395)
6FX□ 008-1BA61-□□□□	0.74 (1.1)	0.74 (1.1)	10.83 (275)	17.32 (440)
6FX□ 008-1BA25-□□□□	0.98 (1.46)	1.05 (1.56)	12.8 (325)	20.87 (530)
6FX□ 008-1BA35-□□□□	1.41 (2.1)	1.35 (2.01)	14.96 (380)	23.23 (590)
6FX□ 008-1BA50-□□□□	1.85 (2.75)	2.22 (3.3)	16.54 (420)	26.97 (685)

MOTION-CONNECT 800 **8**
MOTION-CONNECT 500 **5**

MOTION-CONNECT 800 **8**
MOTION-CONNECT 500 **5**

Length code	A	B	C	D	E	F	G	H	J	K
1	0 ft (0 m)	0 ft (0 m)	0 ft (0 m)	0 ft (0 m)	0 ft (0 m)	0 ft (0 m)	0 ft (0 m)	0 ft (0 m)	0 ft (0 m)	0 ft (0 m)
2	328 ft (100 m)	33 ft (10 m)	3.3 ft (1 m)	3.3 ft (1 m)	3.3 ft (1 m)	3.3 ft (1 m)	3.3 ft (1 m)	3.3 ft (1 m)	3.3 ft (1 m)	3.3 ft (1 m)
3	656 ft (200 m)	66 ft (20 m)	6.6 ft (2 m)	6.6 ft (2 m)	6.6 ft (2 m)	6.6 ft (2 m)	6.6 ft (2 m)	6.6 ft (2 m)	6.6 ft (2 m)	6.6 ft (2 m)
		98 ft (30 m)	9.8 ft (3 m)	9.8 ft (3 m)	9.8 ft (3 m)	9.8 ft (3 m)	9.8 ft (3 m)	9.8 ft (3 m)	9.8 ft (3 m)	9.8 ft (3 m)
		131 ft (40 m)	13.1 ft (4 m)	13.1 ft (4 m)	13.1 ft (4 m)	13.1 ft (4 m)	13.1 ft (4 m)	13.1 ft (4 m)	13.1 ft (4 m)	13.1 ft (4 m)
		164 ft (50 m)	16.4 ft (5 m)	16.4 ft (5 m)	16.4 ft (5 m)	16.4 ft (5 m)	16.4 ft (5 m)	16.4 ft (5 m)	16.4 ft (5 m)	16.4 ft (5 m)
		197 ft (60 m)	19.7 ft (6 m)	19.7 ft (6 m)	19.7 ft (6 m)	19.7 ft (6 m)	19.7 ft (6 m)	19.7 ft (6 m)	19.7 ft (6 m)	19.7 ft (6 m)
		229 ft (70 m)	23 ft (7 m)	23 ft (7 m)	23 ft (7 m)	23 ft (7 m)	23 ft (7 m)	23 ft (7 m)	23 ft (7 m)	23 ft (7 m)
		263 ft (80 m)	26.2 ft (8 m)	26.2 ft (8 m)	26.2 ft (8 m)	26.2 ft (8 m)	26.2 ft (8 m)	26.2 ft (8 m)	26.2 ft (8 m)	26.2 ft (8 m)
		295 ft (90 m)	29.5 ft (9 m)	29.5 ft (9 m)	29.5 ft (9 m)	29.5 ft (9 m)	29.5 ft (9 m)	29.5 ft (9 m)	29.5 ft (9 m)	29.5 ft (9 m)

Length code:

Form of delivery:

Example:

3.3 ft (1 m): ...	- 1 A B 0
26.2 ft (8 m): ...	- 1 A J 0
45.7 ft (15 m): ...	- 1 B F 0
193.5 ft (59 m): ...	- 1 F K 0
328 ft (100 m): ...	- 2 A A 0

Deviations from form of delivery

6FX . 008-	164 ft (50 m) (-1FA0)	328 ft (100 m) (-2AA0)
-1BA25	Disposable drum	Disposable drum
-1BA35	Disposable drum	Disposable drum
-1BA50	Disposable drum	Disposable drum
-1BA51 / -1BB51	Disposable drum	Disposable drum
-1BA61 / -1BB61	Disposable drum	Disposable drum

The cross-sections 25, 35 and 50 mm² can also be ordered and delivered to the meter from 33 ft (10 m) to 161 ft (49 m) (according to the length code of the prefabricated cables) and in 33 ft (10 m) rings.

Flange for power connectors

Plugs with union nut as well as with external thread which are mounted on prefabricated cables (ex-works) can be equipped with a flange for passing cable through an enclosure. The flange needs to be ordered separately.

For power plug size 1
6FX2003-7BX00
For power plug size 1.5
6FX2003-7CX00
For power plug size 3
6FX2003-7AX10

Mounting holes

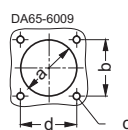

Dimension Drawing Flange

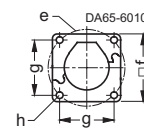

Size	a in (mm)	b in (mm)	c	d in (mm)	e in (mm)	f in (mm)	g in (mm)	h in (mm)
Size 1	∅ 1.09 (∅ 27.8)	1.11 (28.3)	M3 (4x)	1.11 (28.3)	∅ 1.57 (∅ 40)	1.38 (35)	1.11 (28.3)	∅ 0.13 (∅ 3.2)
Size 1.5	∅ 1.81 (∅ 46)	1.67 (42.4)	M4 (4x)	1.67 (42.4)	∅ 2.36 (∅ 60)	2.17 (55)	1.67 (42.4)	∅ 0.17 (∅ 4.4)
Size 3	∅ 2.56 (∅ 65)	2.95 (75)	M4 (4x)	2.95 (75)	∅ 2.48 (∅ 63)	3.15 (80)	2.95 (75)	∅ 0.18 (∅ 4.5)

1) Weight of cables sold by the meter excluding connector.

2) Prefabricated cables are typically stocked in 5 m increments, e.g. 5, 15, 20 m ... Other lengths can experience extended lead time. All quantities are subject to prior sale.



Asynchronous
Servomotors

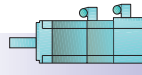

Synchronous
Servomotors

Power cables for 1FK., 1FT6, 1FS6, 1PH., 1PL6

6FX□ 002-5CA . .
without braking cable, with shield

Motor current I_o A	No. of cores x cross section mm ²	Connector size	Prefabricated cables ³⁾		D_{max} 6FX8	6FX5
			Order No.			
15.2	4 x 1.5	1 1.5	6FX□ 002-5CA01-□□□□	0.41	0.4	
			6FX□ 002-5CA21-□□□□	(10.4)	(10.1)	
21	4 x 2.5	1 1.5	6FX□ 002-5CA11-□□□□	0.48	0.45	
			6FX□ 002-5CA31-□□□□	(12.1)	(11.5)	
28	4 x 4	1.5	6FX□ 002-5CA41-□□□□	0.52	0.52	
				(13.2)	(13.3)	
36	4 x 6	1.5	6FX□ 002-5CA51-□□□□	0.63	0.61	
				(16)	(15.6)	
50	4 x 10	3 1.5	6FX□ 002-5CA13-□□□□	0.76	0.79	
			6FX□ 002-5CA61-□□□□	(19.4)	(20)	
66	4 x 16	3	6FX□ 002-5CA23-□□□□	0.93	0.96	
				(23.6)	(24.2)	
84	4 x 25	-	-	-	1.1	
					(28)	
104	4 x 35	-	-	-	1.24	
					(31.5)	
123	4 x 50	-	-	-	1.5	
					(38)	
155	4 x 70	-	-	-	1.68	
					(42.6)	
192	4 x 95	-	-	-	2.04	
					(51.7)	
221	4 x 120	-	-	-	2.2	
					(56)	
234	4 x 150	-	-	-	2.48	
					(63)	
267	4 x 185	-	-	-	2.61	
					(66.2)	

6FX□ 008-1BB . .
without braking cable, with shield

Cable by the meter	Weight ¹⁾		Smallest permissible bending radius	
	6FX8 lb/ft (kg/m)	6FX5 lb/ft (kg/m)	6FX8 in (mm)	6FX5 in (mm)
6FX□ 008-1BB11-□□□A0	0.11 (0.16)	0.12 (0.18)	3.94 (100)	7.28 (185)
6FX□ 008-1BB21-□□□A0	0.16 (0.24)	0.16 (0.24)	4.72 (120)	8.27 (210)
6FX□ 008-1BB31-□□□A0	0.21 (0.31)	0.22 (0.32)	5.12 (130)	9.45 (240)
6FX□ 008-1BB41-□□□A0	0.29 (0.43)	0.31 (0.46)	6.69 (170)	11.22 (285)
6FX□ 008-1BB51-□□□A0	0.42 (0.63)	0.49 (0.73)	8.27 (210)	14.17 (360)
6FX□ 008-1BB61-□□□A0	0.64 (0.95)	0.74 (1.1)	10.24 (260)	17.32 (440)
6FX 5 008-1BB25-□□□A0	-	0.95 (1.42)	-	19.88 (505)
6FX 5 008-1BB35-□□□A0	-	1.26 (1.87)	-	22.44 (570)
6FX 5 008-1BB50-□□□A0 ²⁾	-	2.3 (3.42)	-	26.97 (685)
6FX 5 008-1BB70-□□□A0 ²⁾	-	2.77 (4.12)	-	30.31 (770)
6FX 5 008-1BB05-□□□A0 ²⁾	-	3.21 (4.78)	-	36.81 (935)
6FX 5 008-1BB12-□□□A0 ²⁾	-	4.11 (6.11)	-	39.76 (1010)
6FX 5 008-1BB15-□□□A0 ²⁾	-	5.21 (7.75)	-	44.69 (1135)
6FX 5 008-1BB18-□□□A0 ²⁾	-	6.35 (9.45)	-	47.05 (1195)

MOTION-CONNECT 800 **8**
MOTION-CONNECT 500 **5**

MOTION-CONNECT 800 **8**
MOTION-CONNECT 500 **5**

1 0 ft (0 m)	A 0 ft (0 m)	A 0 ft (0 m)
2 328 ft (100 m)	B 33 ft (10 m)	B 3.3 ft (1 m)
3 656 ft (200 m)	C 66 ft (20 m)	C 6.6 ft (2 m)
	D 98 ft (30 m)	D 9.8 ft (3 m)
	E 131 ft (40 m)	E 13.1 ft (4 m)
	F 164 ft (50 m)	F 16.4 ft (5 m)
	G 197 ft (60 m)	G 19.7 ft (6 m)
	H 229 ft (70 m)	H 23 ft (7 m)
	J 263 ft (80 m)	J 26.2 ft (8 m)
	K 295 ft (90 m)	K 29.5 ft (9 m)

Length code:

Form of delivery:

Example:	3.3 ft (1 m): ...	- 1 A B 0
	26.2 ft (8 m): ...	- 1 A J 0
	45.7 ft (15 m): ...	- 1 B F 0
	193.5 ft (59 m): ...	- 1 F K 0
	328 ft (100 m): ...	- 2 A A 0

1 B 33 ft (10 m)	Rings (25, 35, 50 mm ²)
1 F 164 ft (50 m)	Rings (for deviations see table)
2 A 328 ft (100 m)	Rings (for deviations see table)
3 A 656 ft (200 m)	Disposable drum (not for cables > 10 mm ²)
6 A 1640 ft (500 m)	Disposable drum (not for cables > 10 mm ²)

Deviations from form of delivery

6FX . 008-	164 ft (50 m) (-1FA0)	328 ft (100 m) (-2AA0)
-1BA25	Disposable drum	Disposable drum
-1BA35	Disposable drum	Disposable drum
-1BA50	Disposable drum	Disposable drum
-1BA51 / -1BB51		Disposable drum
-1BA61 / -1BB61		Disposable drum

The cross-sections 25, 35 and 50 mm² can also be ordered and delivered to the meter from 33 ft (10 m) to 161 ft (49 m) (according to the length code of the prefabricated cables) and in 33 ft (10 m) rings.

1) Weight of cables sold by the meter excluding connector.

2) From cable cross-section 50 mm² and 164 ft (50 m), 328 ft (100 m) and 656 ft (200 m) cable length, the form of delivery is on drums.

3) Prefabricated Power cables without brake leads will NOT be routinely stocked in the U.S. Please refer to page 5/4 for Power cables with brake leads.

Servomotors Connecting Systems

Power cables
MOTION-CONNECT 700

Synchronous
Servomotors



Asynchronous
Servomotors



6FX7 power cables for 1FN3 linear motors, sold by the meter

6FX7 power cables for 1FN3 motors with temperature leads

Motor current I_0 A	Power cable cross-section		Order No.	Cable diameter D_{max} in (mm)	Cable weight lb/ft (kg/m)	Smallest permissible bending radius moving installation in (mm)
	mm ²	AWG				
15.2	4 × 1.5 + 4 × 0.5	16/20	6FX7008-1BC11-□□□□	0.55 (14)		3.94 (100)
21	4 × 2.5 + 4 × 0.5	14/20	6FX7008-1BC21-□□□□	0.6 (15.2)		4.33 (110)
28	4 × 4 + 4 × 0.5	12/20	6FX7008-1BC31-□□□□	0.65 (16.6)		4.72 (120)
36	4 × 6 + 4 × 0.5	10/20	6FX7008-1BC41-□□□□	0.72 (18.3)		5.12 (130)
50	4 × 10 + 4 × 0.5	8/20	6FX7008-1BC51-□□□□	0.93 (23.5)		6.5 (165)
66	4 × 16 + 4 × 0.5	6/20	6FX7008-1BC61-□□□□	1.03 (26.1)		7.28 (185)
84	4 × 25 + 4 × 0.5	4/20	6FX7008-1BC25-□□□□	1.2 (30.5)		8.46 (215)

32.8 ft (10 m)	Ring (only for 25 mm ²)	1 B A
164 ft (50 m)	Ring (one-way drums for 25 mm ²)	1 F A
328 ft (100 m)	Ring (one-way drums for 10, 16 and 25 mm ²)	2 A A
656 ft (200 m)	Disposable drum (not for 10, 16 and 25 mm ²)	3 A A

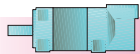

Asynchronous
Servomotors

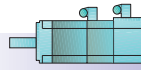

Synchronous
Servomotors

Power cables for 1PH7, 1PL6 and 1PH4 induction motors

In modern converter systems, fast-switching IGBT transistors are used. High pulse frequencies with very short switching times in the nanosecond range associated with this technology lead to a high level of efficiency but can affect the surroundings due to interference in the form of electromagnetic fields.

Any power cable that is designed for variable frequency drive operation and that meets the following requirements can be used.

- Minimum shield coverage of 80%
- Nominal voltage $V_0/V = 600/1000$ V
- "Max. operating voltage" rating: 1700 V
- Coupling resistance max. 250 Ω /km

Any other data like minimum bending radius, operating temperature range, must meet the applications requirements and ambient conditions.

Siemens recommends the Pirelli PROTOFLEX-EMV power cable or the TOPFLEX-EMV cable from Helukabel. Both cables are excellent and have proven themselves in many applications.

When using the PROTOFLEX-EMV or the TOPFLEX-EMV cable you can check with the table beside what the approximate cable size is for your application. For an exact determination of the required cable size please consult the cable supplier since factors like routing type and operating air temperature need to be considered.

Power rating* with 3 loaded cores A	No. of cores × cross section mm ²	Outer cable diameter	
		in	(mm)
15.2	4 × 1.5	0.43	(10.6)
21	4 × 2.5	0.48	(12.3)
28	4 × 4	0.57	(14.5)
36	4 × 6	0.65	(16.4)
50	4 × 10	0.79	(20.1)
66	4 × 16	0.92	(23.4)
84	4 × 25	1.06	(27.0)
104	4 × 35	1.21	(30.7)
123	4 × 50	1.42	(36.1)
155	4 × 70	1.66	(42.3)
192	4 × 95	1.88	(47.7)
221	4 × 120	2.04	(51.9)
234	4 × 150	2.26	(57.5)
267	4 × 185	2.41	(61.1)

* For permanent operation at ambient temperature of 104 °F (40 °C) and single routing.

Information about these cables can be obtained through:

PROTOFLEX-EMV

ANIXTER
Phone: (678) 377-3427
http://www.anixter.com

TOPFLEX-EMV

HI-TECH Controls Inc.
Phone: 1 800 677-8942
Fax: (303) 680-5344

Encoder cables

Flange for signal plug

Plugs with union nut as well as with external thread which are mounted on prefabricated cables (ex-works) can be equipped with a flange, for passing cable through an enclosure.

The flange needs to be ordered separately.

Flange for signal plug
6FX2003-7DX00

Mounting holes

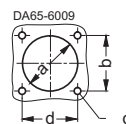

Dimension Drawing

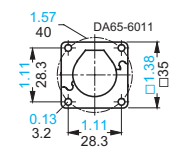

a in (mm)	b in (mm)	c	d in (mm)
∅ 1.06 (∅ 27)	1.11 (28.3)	M3 (4×)	1.11 (28.3)

Servomotors Connecting Systems

Encoder cables
MOTION-CONNECT 500 and 800

Synchronous
Servomotors

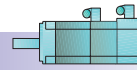

Asynchronous
Servomotors

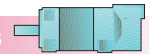

For connection to motors with an incremental encoder HTL (1024 p/r and 2048 p/r)¹⁾

Cable design and pin assignment

Type 6FX. 002-2AH00-.... base cable

Converter side	Motion Control	Vector Control	Signal name	Cable, sold by the meter 6FX.008-1BD21		Measurement system side
				Color of cores	Signal name	
	PIN	PIN	Signal name	Color of cores	Signal name	PIN
Cable end cut off	71		* B	Orange	* B	1
	63	30	KTY 84 +	White-red	KTY 84 +	2
	72	26	ZERO TRACK	Blue	ZERO TRACK	3
	73		ZERO TRACK	Violet	ZERO TRACK	4
	68	24	A	Black	A	5
	69		* A	Brown	* A	6
	74	27	CTRL TACHO	Green	CTRL TACHO	7
	70	25	B	Red	B	8
	61	23	0 V	White-blue	0 V	10
	62	29	KTY 84 -	White-black	KTY 84 -	11
	60	28	15 V	White-yellow	15 V	12
				Outer shield on plug housing		

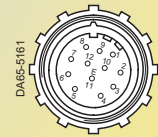
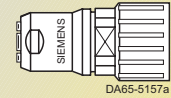

Cable extension

Type 6FX. 002-2AH04-... 0

Plug type: 6FX2 003-1CF12

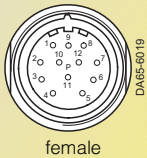
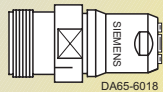

PIN assignment of the cable extension corresponding to the base cable.

Plug type: 6FX2 003-0CE12

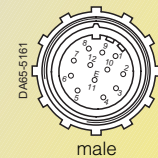

Selection and ordering data

Cable	Order No.
-------	-----------

Cable	Length ft (m)	Order No.
-------	---------------	-----------

Prefabricated cables

Encoder cables for connection to motors with an incremental encoder HTL

6FX□002-2AH00-□□□□

MOTION-CONNECT 800 **8**
MOTION-CONNECT 500 **5**

1 0 ft (0 m)	A 0 ft (0 m)	A 0 ft (0 m)
2 328 ft (100 m)	B 33 ft (10 m)	B 3.3 ft (1 m)
3 656 ft (200 m)	C 66 ft (20 m)	C 6.6 ft (2 m)
4 984 ft (300 m)	D 98 ft (30 m)	D 9.8 ft (3 m)
	E 131 ft (40 m)	E 13.1 ft (4 m)
	F 164 ft (50 m)	F 16.4 ft (5 m)
	G 197 ft (60 m)	G 19.7 ft (6 m)
	H 229 ft (70 m)	H 23 ft (7 m)
	J 263 ft (80 m)	J 26.2 ft (8 m)
	K 295 ft (90 m)	K 29.5 ft (9 m)

Length code:

Example: 3.3 ft (1 m): ... - 1 A B 0
26.2 ft (8 m): ... - 1 A J 0
45.7 ft (15 m): ... - 1 B F 0
193.5 ft (59 m): ... - 1 F K 0
328 ft (100 m): ... - 2 A A 0

Cable, sold by the meter

Encoder cables for connection to motors with an incremental encoder HTL	164 (50)	6FX□008-1BD21-1FA0
Number of cores × cross-section [mm ²] 4 × 2 × 0.34 + 4 × 0.5	328 (100)	6FX□008-1BD21-2AA0
	656 (200)	6FX□008-1BD21-3AA0
	1640 (500)	6FX□008-1BD21-6AA0

Outer diameter of cable for 6FX8: 0.37 in (9.3 mm) **8**
Outer diameter of cable for 6FX5: 0.37 in (9.3 mm) **5**

¹⁾ Cable length ≤ 492 ft (150 m) without transmission of the inverted signals and cable length 492 ft (150 m) to 984 ft (300 m) with transmission of the inverted signals and use of the DTI unit.



Asynchronous
Servomotors

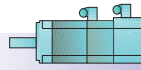



Synchronous
Servomotors

For connection to motors with a resolver 2-pole/multi-pole

Cable design and pin assignment

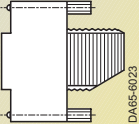
Type 6FX. 002-2CF02-.... base cable

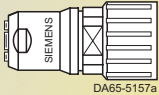
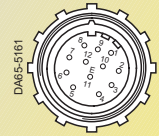
Converter side	Cable, sold by the meter 6FX.008-1BD41					Motor side
Plug type: 6FC9 348-7HP00	PIN	Signal name	Color of cores	Signal name	PIN	Plug type: 6FX2 003-0CE12
 	3	SIN	Yellow	SIN	1	 
	4	* SIN	Green	* SIN	2	
	5		Inner shield		3	
	6	COS	Black	COS	11	
	7	* COS	Brown	* COS	12	
	8		Inner shield		5	
	13	+ TEMP	Red	+ TEMP	8	
	25	- TEMP	Orange	- TEMP	9	
	24		Inner shield		4	
	9	+ V _{PP}	Brown-red	+ V _{PP}	10	
	11	- V _{PP}	Brown-blue	- V _{PP}	7	
	yes		Outer shield on plug housing		yes	

Cable extension

Type 6FX. 002-2CF04-....

Plug type: 6FX2 003-1CF12

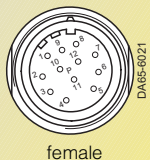
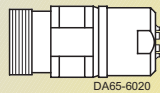

female

PIN assignment of the cable extension corresponding to the base cable.

Plug type: 6FX2 003-0CE12

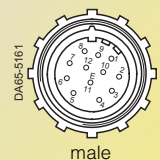
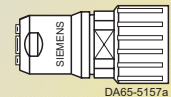

male

Selection and ordering data

Cable	Order No.
-------	-----------

Prefabricated cables (length < 492 ft (150 m))

Encoder cables for connection to motors which are fitted with a resolver (detection of rotor position and speed), prefabricated

6FX□002-2CF02 -□□□0

MOTION-CONNECT 800

8

MOTION-CONNECT 500

5

1 0 ft (0 m)	A 0 ft (0 m)	A 0 ft (0 m)
2 328 ft (100 m)	B 33 ft (10 m)	B 3.3 ft (1 m)
	C 66 ft (20 m)	C 6.6 ft (2 m)
	D 98 ft (30 m)	D 9.8 ft (3 m)
	E 131 ft (40 m)	E 13.1 ft (4 m)
	F 164 ft (50 m)	F 16.4 ft (5 m)
	G 197 ft (60 m)	G 19.7 ft (6 m)
	H 229 ft (70 m)	H 23 ft (7 m)
	J 263 ft (80 m)	J 26.2 ft (8 m)
	K 295 ft (90 m)	K 29.5 ft (9 m)

Length code:

Example:	3.3 ft (1 m): ...	- 1 A B 0
	26.2 ft (8 m): ...	- 1 A J 0
	45.7 ft (15 m): ...	- 1 B F 0
	193.5 ft (59 m): ...	- 1 F K 0
	328 ft (100 m): ...	- 2 A A 0

Cable	Length ft (m)	Order No.
-------	---------------	-----------

Cable, sold by the meter¹⁾

Encoder cables for connection to motors which are fitted with a resolver (detection of rotor position and speed). Number of cores × cross-section [mm ²]	164 (50)	6FX□008-1BD41-1FA0
	328 (100)	6FX□008-1BD41-2AA0
3 × 2 × 0.14 + 4 × 0.14 + 2 × 0.5	656 (200)	6FX□008-1BD41-3AA0
	1640 (500)	6FX□008-1BD41-6AA0

Outer diameter of cable for 6FX8: 0.36 in (9.2 mm) 8

Outer diameter of cable for 6FX5: 0.37 in (9.3 mm) 5

1) Maximum permissible length of the prefabricated cables for the resolvers: 492 ft (150 m).

Servomotors Connecting Systems

Encoder cables
MOTION-CONNECT 500 and 800

Synchronous
Servomotors

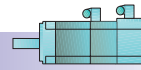



Asynchronous
Servomotors



For connection to motors with a sin/cos incremental encoder 1 V_{pp}

Cable design and pin assignment

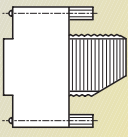

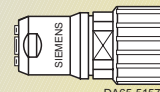
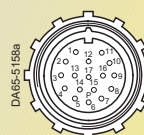
Type 6FX. 002-2CA31-..../6FX. 002-2YS01.... base cable

Converter side	PIN	Signal name	Cable, sold by the meter 6FX.008-1BD51 Color of cores	Signal name	PIN	Measurement system/ motor side
Plug type: 6FC9 348-7HP00  DA65-6023  DA65-6024 6FX. 002-2CA31- Cable outlet at the bottom 6FX. 002-2YS01- Cable outlet at the top	3	A	Yellow	Ua1	1	Plug type: 6FX2 003-0CE17  DA65-5157a  DA65-158a
	4	* A	Green	* Ua1	2	
	5		Inner shield		17	
	6	B	Black	Ua2	11	
	7	* B	Brown	* Ua2	12	
	8		Inner shield		17	
	17	R	Red	Ua0	3	
	18	* R	Orange	* Ua0	13	
	24		Inner shield		17	
	19	C	Blue	Ua3	5	
	20	* C	Gray	* Ua3	6	
	21	D	White-black	Ua4	14	
	22	* D	White-yellow	* Ua4	4	
	13	+ TEMP	Green-black	+ TEMP	8	
	25	- TEMP	Green-red	- TEMP	9	
	1	P encoder	Brown-red	P encoder	10	
	14	5 V sense	Brown-yellow	5 V sense	16	
	2	M encoder	Brown-blue	M encoder	7	
	16	0 V sense	Brown-gray	0 V sense	15	
	yes		Outer shield on plug housing		yes	

Cable extension

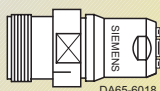

Type 6FX. 002-2CA34-....

Plug type: 6FX2 003-1CF17

 DA65-6018
 DA65-6022 female

PIN assignment of the cable extension corresponding to the base cable.

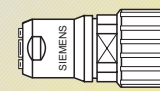
Plug type: 6FX2 003-0CE17

 DA65-5157a
 DA65-158a male

Selection and ordering data

Cable	Order No.
-------	-----------

Cable	Length ft (m)	Order No.
-------	---------------	-----------

Prefabricated cables (length < 328 ft (100 m))

Encoder cables for connection to motors which are fitted with a sin/cos incremental encoder 1 V_{pp} (detection of rotor position and speed), prefabricated

6FX□002-2CA31-□□□□

MOTION-CONNECT 800	8
MOTION-CONNECT 500	5

1 0 ft (0 m)	A 0 ft (0 m)	A 0 ft (0 m)
2 328 ft (100 m)	B 33 ft (10 m)	B 3.3 ft (1 m)
	C 66 ft (20 m)	C 6.6 ft (2 m)
	D 98 ft (30 m)	D 9.8 ft (3 m)
	E 131 ft (40 m)	E 13.1 ft (4 m)
	F 164 ft (50 m)	F 16.4 ft (5 m)
	G 197 ft (60 m)	G 19.7 ft (6 m)
	H 229 ft (70 m)	H 23 ft (7 m)
	J 263 ft (80 m)	J 26.2 ft (8 m)
	K 295 ft (90 m)	K 29.5 ft (9 m)

Length code:

Example:	3.3 ft (1 m): ...	- 1 A B 0
	26.2 ft (8 m): ...	- 1 A J 0
	45.7 ft (15 m): ...	- 1 B F 0
	193.5 ft (59 m): ...	- 1 F K 0

Cable, sold by the meter ¹⁾

Encoder cables for connection to motors which are fitted with a sin/cos incremental encoder 1 V _{pp} (detection of rotor position and speed). Number of cores × cross-section [mm ²]	164 (50)	6FX□008-1BD51-1FA0
3 × 2 × 0.14 + 4 × 0.14 +	328 (100)	6FX□008-1BD51-2AA0
2 × 0.5 + 4 × 0.23	656 (200)	6FX□008-1BD51-3AA0
	1640 (500)	6FX□008-1BD51-6AA0

Outer diameter of cable for 6FX8: 0.39 in (9.9 mm) 8

Outer diameter of cable for 6FX5: 0.39 in (9.9 mm) 5

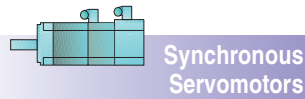

1) Maximum permissible length of the prefabricated cables for the sin/cos incremental encoder 1 V_{pp}: 328 ft (100 m).



For connection to motors with an absolute-value encoder (EnDat)

Cable design and pin assignment

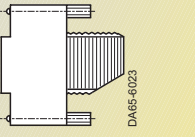
Type 6FX. 002-2EQ10-.... base cable

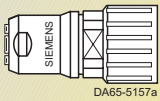
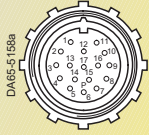
Converter side	Cable, sold by the meter 6FX.008-1BD51					Measurement system side
Plug type: 6FC9 348-7HP00	PIN	Signal name	Color of cores	Signal name	PIN	Plug type: 6FX2 003-0CE17
 	3	A	Yellow	Ua1	1	 
	4	* A	Green	* Ua1	2	
	5		Inner shield		17	
	6	B	Black	Ua2	11	
	7	* B	Brown	* Ua2	12	
	8		Inner shield		17	
	15	Data	Red	Data	3	
	23	* Data	Orange	* Data	13	
	24		Inner shield		17	
	10	Clock pulse	Blue	Clock pulse	5	
	12	* Clock pulse	White-black	* Clock pulse	14	
	13	+ TEMP	Gray	+ TEMP	8	
	25	- TEMP	White-yellow	- TEMP	9	
	1	P encoder	Brown-red	P encoder	10	
	14		Green-red		16	
	14	5 V sense	Brown-yellow	5 V sense	16	
	2	M encoder	Brown-blue	M encoder	7	
	16		Green-black		15	
	16	0 V sense	Brown-gray	0 V sense	15	
	yes		Outer shield on plug housing		yes	

Cable extension

Type 6FX. 002-2EQ14-....

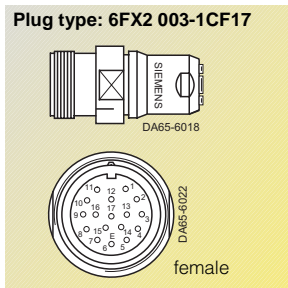

PIN assignment of the cable extension corresponding to the base cable.

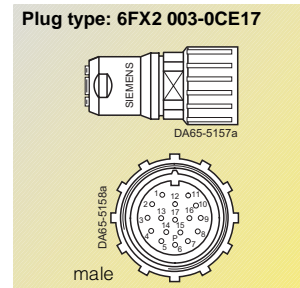

Selection and ordering data

Cable	Order No.
-------	-----------

Cable	Length ft (m)	Order No.
-------	---------------	-----------

Prefabricated cables (length < 328 ft (100 m))

Encoder cables for connection to motors which are fitted with an absolute-value encoder (EnDat) (detection of absolute position and speed), prefabricated

6FX□002-2EQ10-□□□0

MOTION-CONNECT 800 **8**
MOTION-CONNECT 500 **5**

1 0 ft (0 m)	A 0 ft (0 m)	A 0 ft (0 m)
2 328 ft (100 m)	B 33 ft (10 m)	B 3.3 ft (1 m)
	C 66 ft (20 m)	C 6.6 ft (2 m)
	D 98 ft (30 m)	D 9.8 ft (3 m)
	E 131 ft (40 m)	E 13.1 ft (4 m)
	F 164 ft (50 m)	F 16.4 ft (5 m)
	G 197 ft (60 m)	G 19.7 ft (6 m)
	H 229 ft (70 m)	H 23 ft (7 m)
	J 263 ft (80 m)	J 26.2 ft (8 m)
	K 295 ft (90 m)	K 29.5 ft (9 m)

Length code:

Example:	3.3 ft (1 m): ...	- 1 A B 0
	26.2 ft (8 m): ...	- 1 A J 0
	45.7 ft (15 m): ...	- 1 B F 0
	193.5 ft (59 m): ...	- 1 F K 0

Cable, sold by the meter¹⁾

Encoder cables for connection to motors which are fitted with an absolute-value encoder (EnDat) (detection of absolute position and speed). Number of cores × cross-section [mm ²] 3 × 2 × 0.14 + 4 × 0.14 + 2 × 0.5 + 4 × 0.23	164 (50)	6FX□008-1BD51-1FA0
	328 (100)	6FX□008-1BD51-2AA0
	656 (200)	6FX□008-1BD51-3AA0
	1640 (500)	6FX□008-1BD51-6AA0

Outer diameter of cable for 6FX8: 0.39 in (9.9 mm) **8**

Outer diameter of cable for 6FX5: 0.39 in (9.9 mm) **5**

1) Maximum permissible length of the prefabricated cables for the absolute-value encoders (EnDat): 328 ft (100 m).

Servomotors Connecting Systems

Encoder cables
for linear motors

Synchronous
Servomotors

Asynchronous
Servomotors

Encoder cables for 1FN3 AC linear motors

1FN3 primary sections are equipped with the two temperature monitoring circuits, Temp-S and Temp-F to protect the primary sections against inadmissibly high thermal stressing as well as to monitor the temperature during commissioning and operation.

Temp-S (shut-down) comprises three PTC thermistor elements connected in series located in each of the three phase windings of the primary section. Temp-S is primarily used to reliably protect the motor against overheating. If Temp-S responds, then the drive must

be quickly powered-down in order to interrupt the primary section power supply from the drive converter, which can be done by using the Siemens thermistor motor protection unit 3RN1.

Temp-F supplies an analog signal which is proportional to the temperature, and for

a symmetrical current load of the three-phase windings, provides information about the average motor temperature.

Termination technology, length measuring system

The termination technology required for the length measuring scales for 1FN3 AC linear motors, essentially depends on the measuring scale type (incremental vs.

absolute). The list of available preassembled cables and connector box to connect the length measuring systems is shown in Figure 5/1

(incremental measuring system) and Figure 5/2 (absolute measuring system).

Note:

If the connector box 1FN1 910-0AA00-0AA0 is used, then unused connector sockets have to be closed with the provided dummy plug.

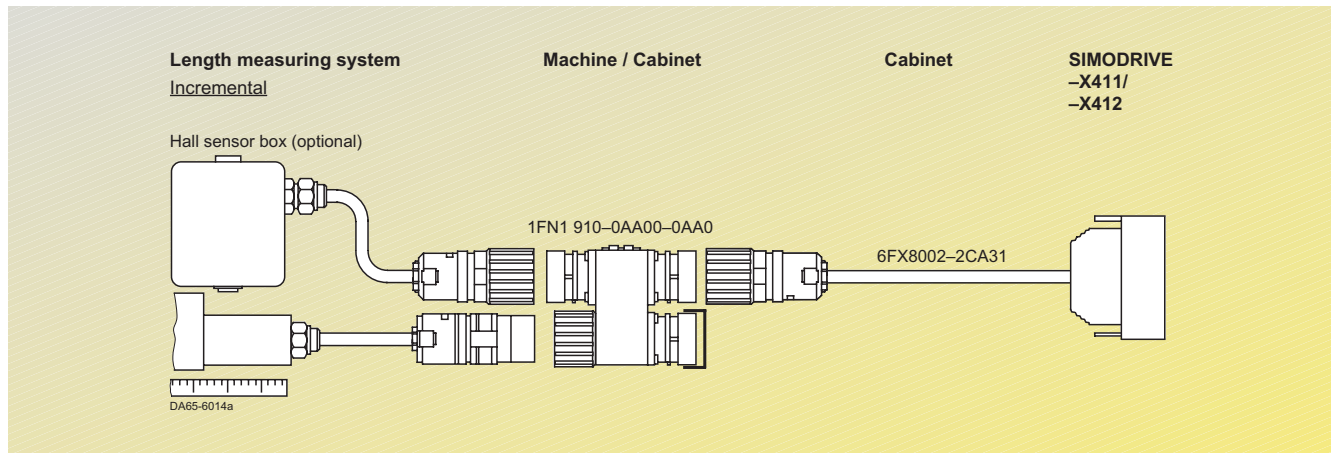

Fig. 5/1
Termination technology for incremental measuring system on 1FN3 motors

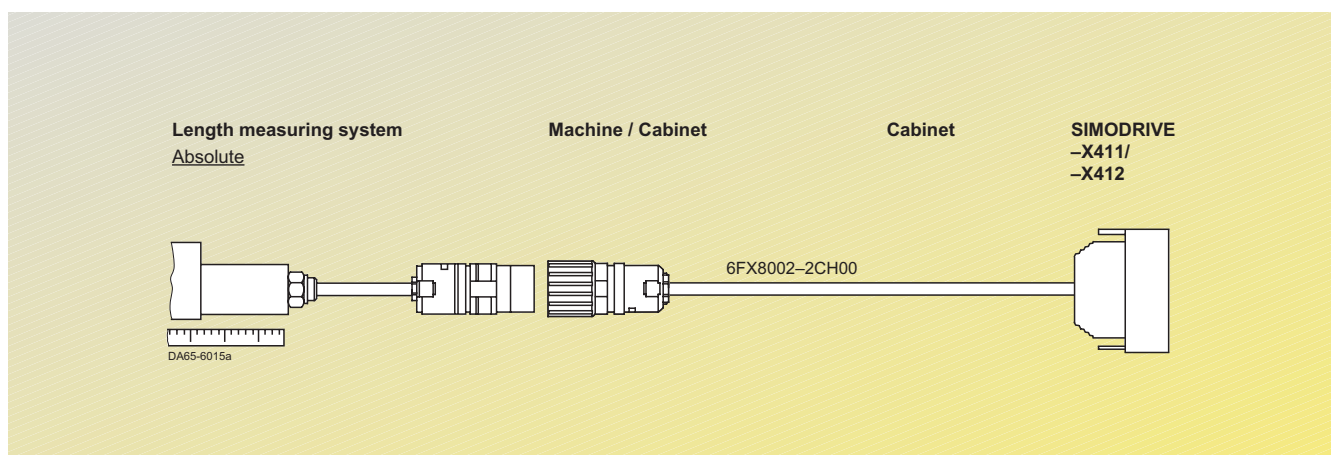
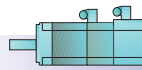

Fig. 5/2
Termination technology for absolute-value measuring system on 1FN3 motors



Asynchronous Servomotors



Synchronous Servomotors

Encoder cables for 1FN3 AC linear motors

Connector box

The connector box is used to connect the Hall sensor when an incremental encoder

is used. The connector boxes have an IP 65 degree of protection, and have on the opposite

side of the rating plate two blind tapped holes for mounting to the machine or to the cabinet.

Part number

1FN1910-0AA00-0AA0

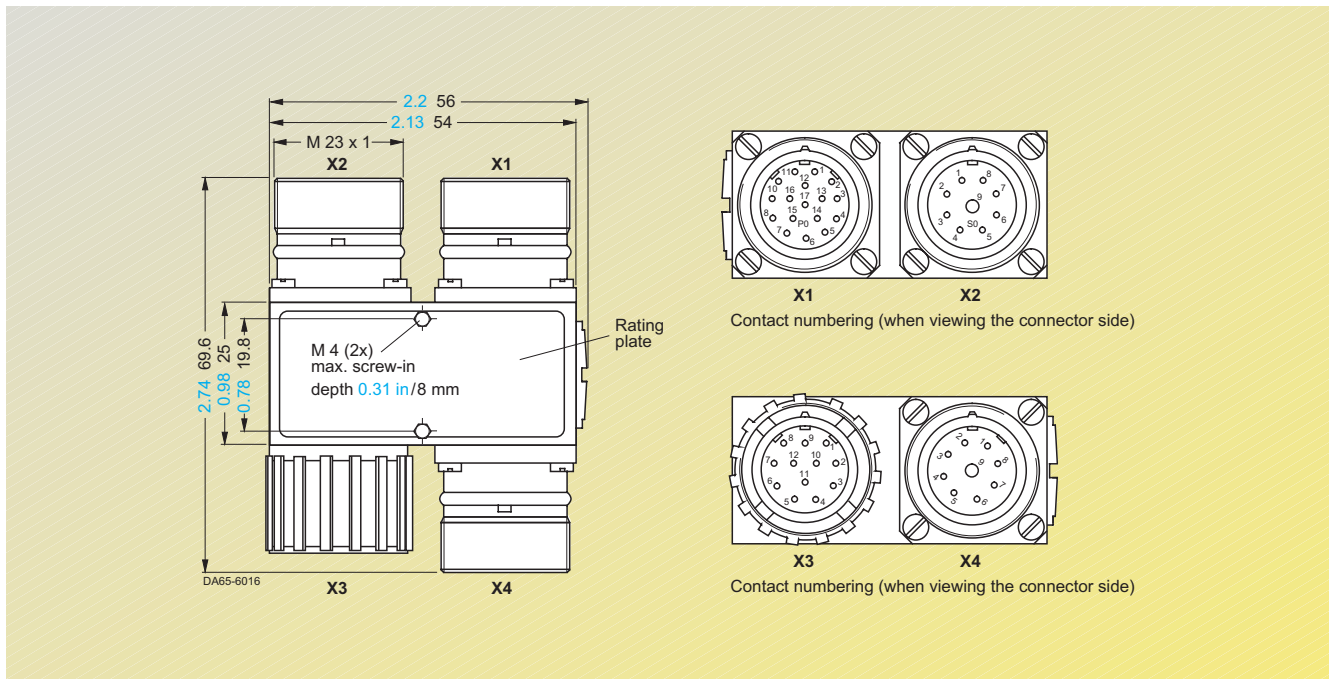

Fig. 5/3
Dimension and pin out for 1FN1910-0AA00-0AA0 connector box

	X1	X2	X3	X4
Connecting cable to	Converter SIMODRIVE 611 universal X411, X412	Temperature sensor	Linear scale	Hall sensor box
Connector type	17-pin, plug	9-pin, socket	12-pin, socket	9-pin, socket with Y-coding
Signal	Pin	Pin	Pin	Pin
A+	1		5	
A-	2		6	
R+	3		3	
D-	4			6
C+	5			1
C-	6			2
0 V	7		10	4
+Temp	8	7		
-Temp	9	8		
+5 V	10		12	3
B+	11		8	
B-	12		1	
R-	13		4	
D+	14			5
0 V sense	15		11	
+5 V sense	16		2	
Inner shield	17			9

Dimension in inches

Dimension in mm

Servomotors Connecting Systems

Encoder cables
for SIMODRIVE 611 universal

Synchronous
Servomotors

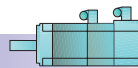

Asynchronous
Servomotors

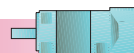

Encoder cables for SIMODRIVE 611 universal

From connector box to SIMODRIVE 611 universal

To connect the SIMODRIVE 611 universal with the connector box the same prefabricated encoder cable as with an sin/cos incremental $1 V_{pp}$

in case of an incremental measuring system is used. For dimensions and pin-out see from page 5/13.

Part number

For incremental measuring system:

Standard

6FX5002-2CA31-1□□0¹⁾

Performance

6FX8002-2CA31-1□□0¹⁾

From absolute measuring system (w/o connector box) to SIMODRIVE 611 universal

With an absolute measuring system a hall sensor box is not required. You can use

the following cable which allows a direct connection to the SIMODRIVE 611 universal.

Part number

For absolute measuring system:

Standard

6FX5002-2CH00-1□□0¹⁾

Performance

6FX8002-2CH00-1□□0¹⁾

1) Maximum cable length 164 ft (50 m), for length code see page 5/4.

Connection overview

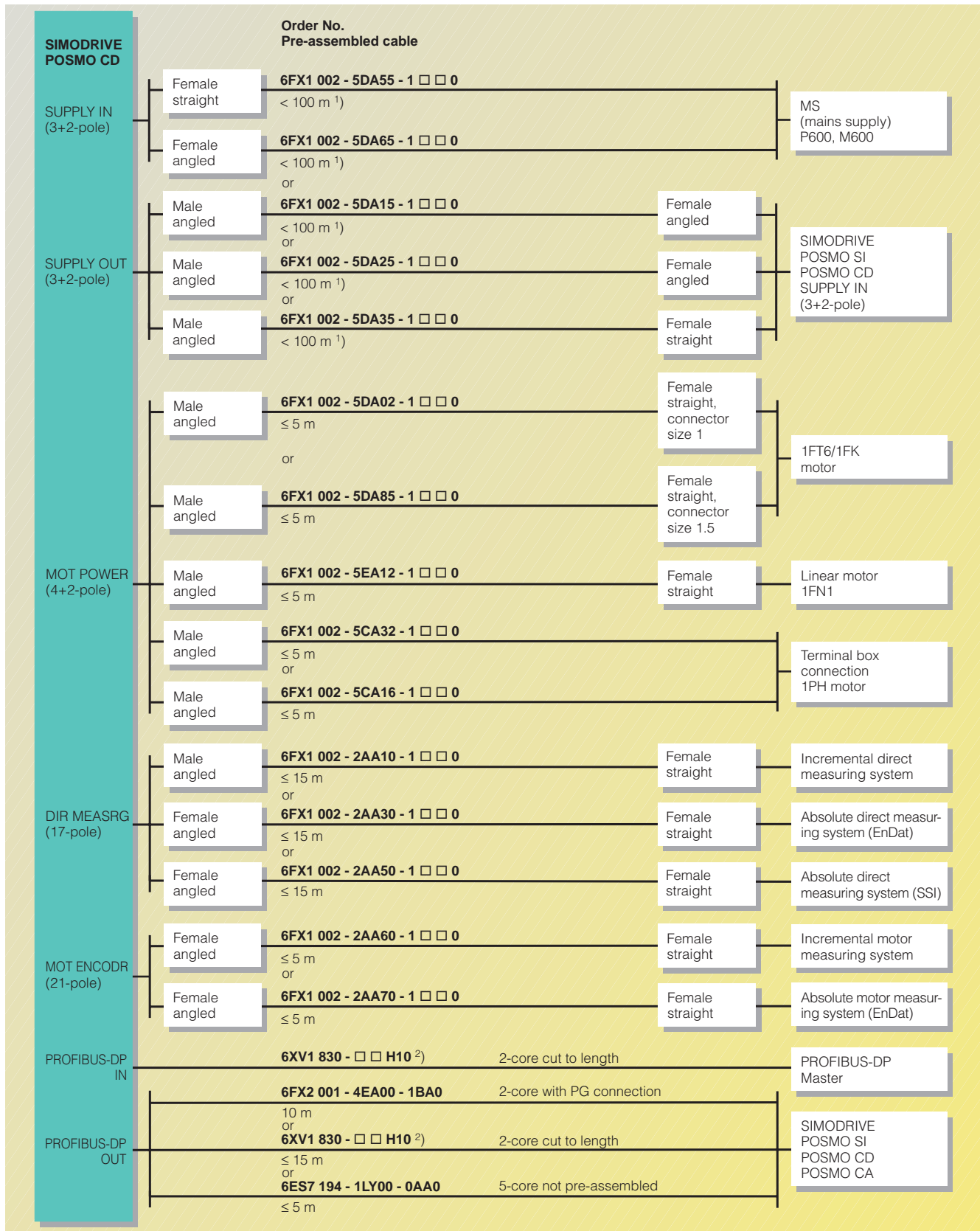

5

1) 6XV1 830-0EH10 not suitable for trailing, 6XV1 810-3EH10 for trailing.

2) The total cable length in the DC link for all devices connected to an infeed must not exceed 100 m.

Servomotors Connecting Systems

Cables
for SIMODRIVE POSMO CD/CA, SI

Connection overview

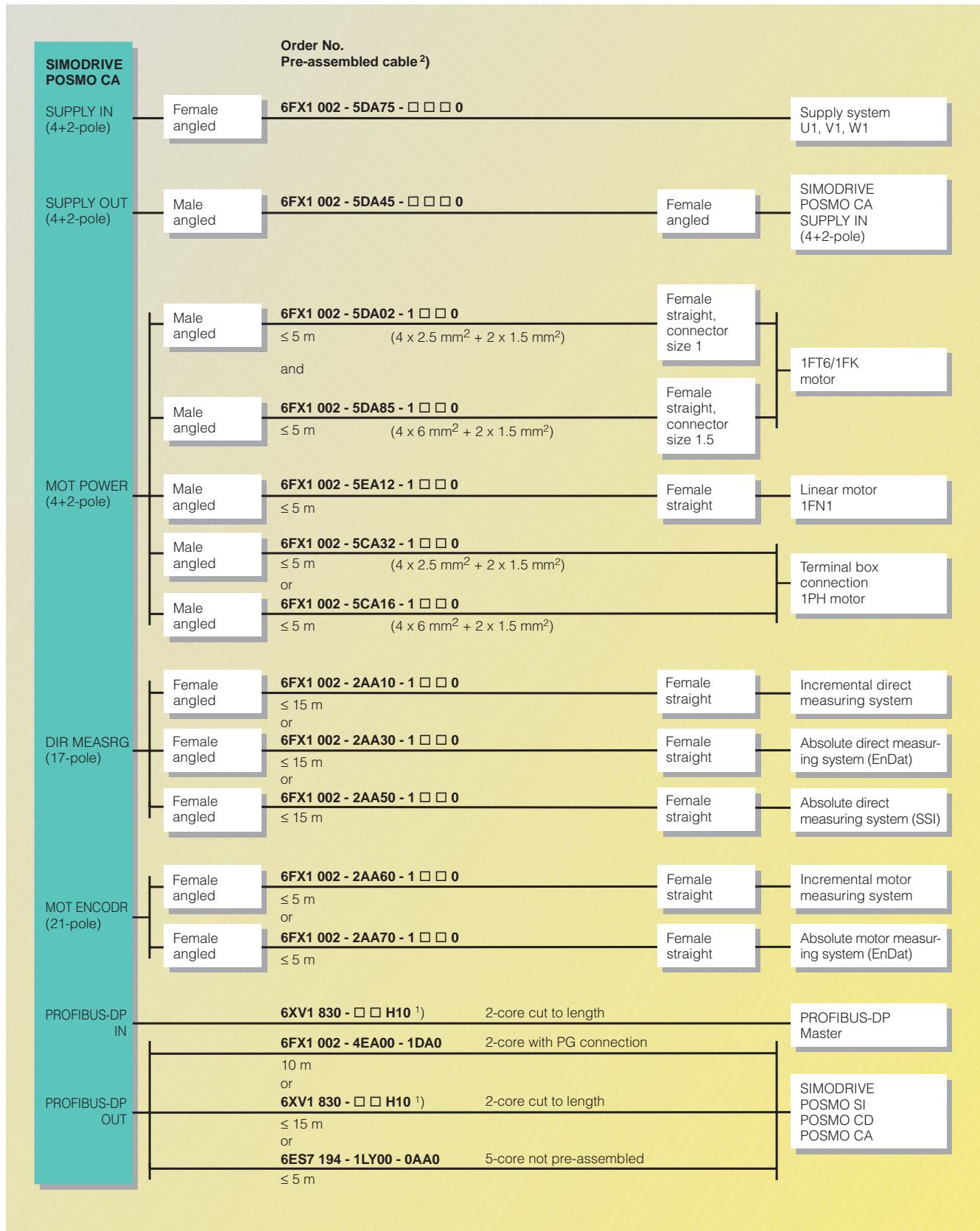

1) 6XV1 830-0EH10 not suitable for trailing, 6XV1 810-3EH10 for trailing.

2) For length code see page 5/4.

Connection overview

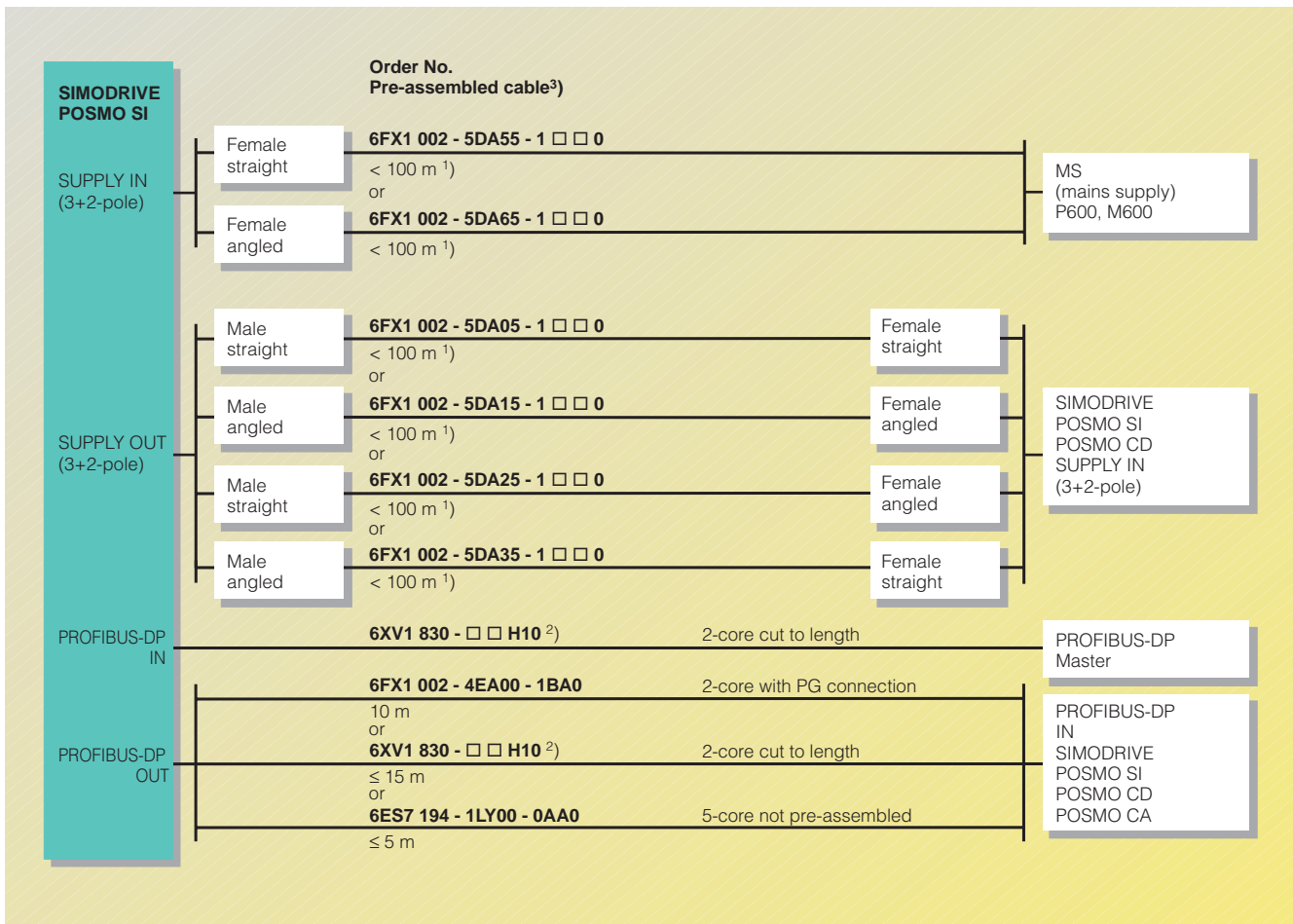

Connection overview for SIMODRIVE POSMO SI or POSMO SI – POSMO SI/CD

1) The total cable length in the DC link for all devices connected to an infeed must not exceed 100 m.

2) 6XV1 830-0EH10 not suitable for trailing, 6XV1 810-3EH10 for trailing.

3) For length code see page 5/4.

Servomotors

Connecting Systems

Notes

Synchronous
Servomotors

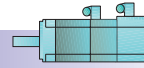

Asynchronous
Servomotors

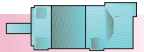

Servomotors Documentation

6/2

Documentation CD-ROM

6/2

Sizing & selection tool

6

Servomotors Documentation

Documentation CD-ROM · Sizing & selection tool

Synchronous
Servomotors

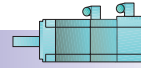

Asynchronous
Servomotors



Documentation CD-ROM

The General Motion Control CD-ROM contains information about the SIMOVERT MASTERDRIVES MC, the SIMODRIVE 611 universal drive, the POSMO and the High Performance Servomotors. For the motors in particular this includes:

- Operating instructions
- Dimension Drawings
- Torque-Speed curves
- Engineering Information
- Selection Tools (SimoSize)
- Etc.

The CD is available free of charge.

Order No.: **DRMS-02055**



Fig. 6/1

Sizing & selection tool

SimoSize

SimoSize is a PC tool which allows the user to accelerate the motion Design cycle by providing all the necessary tools and products of a modern graphical interface format using Windows 95/98/NT/2000. SimoSize is available free of charge and may be copied and distributed anytime.

SimoSize offers the following range of functions:

1. **Axis Design** allows the quick selection of components like gear-boxes, leadscrews, nip rolls, etc. just by clicking on the appropriate button and inputting the required data.
2. **Velocity Profile** allows specifying and refining the profile to your application needs.
3. **Report Generator** provides the results of all the calculation performed for speed, torque and inertia required to properly select a motor. This process is further simplified

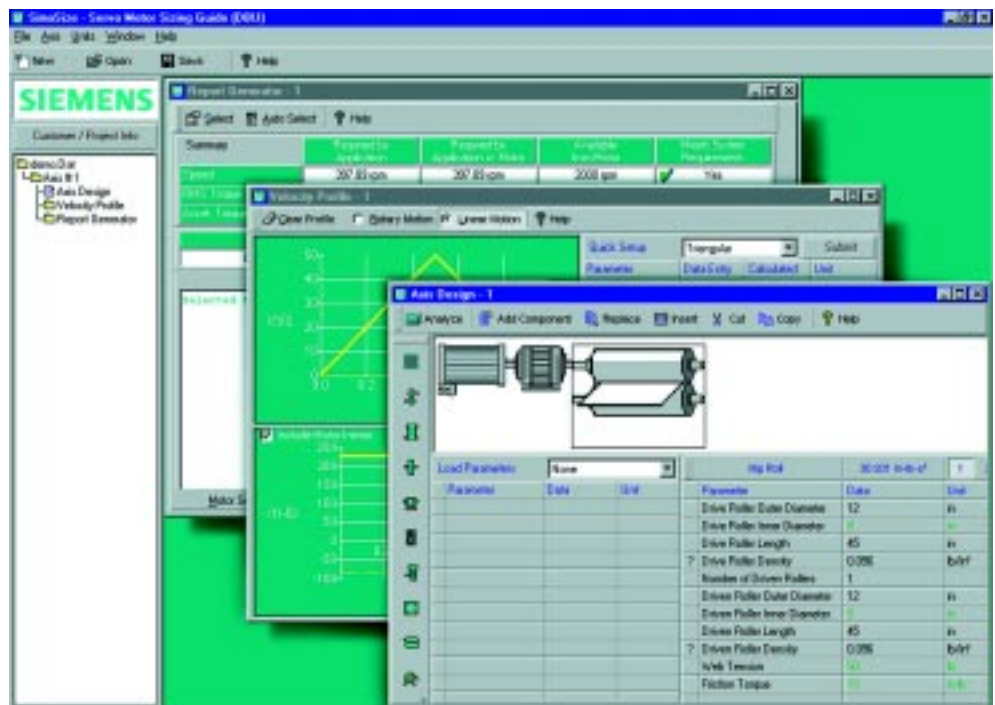

Fig. 6/2

with the "Auto Select" button. "Auto Select" will find the optimum choice for you

automatically according to the selected parameters and motor requirements.

Servomotors

Configuration Aids

7/2

General information

7/3

Speed-Torque curves

1FK6 servomotors

7/5

1FT6 servomotors

7/16

1PH7 servomotors

7/26

1PL6 servomotors

Additional data for 1PH7 and 1PL6 motors

7/32

Ventilation data and sound pressure level

7/32

Bearing design/type of drive and maximum speeds

7/33

Lateral-force diagrams

7/35

Terminal box assignment, max. cable cross-sections

7/36

Overview of possible types of construction

Servomotors Configuration Aids

General information

Asynchronous Servomotors



Synchronous Servomotors

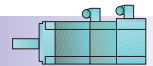

Engineering information when selecting the motor degree of protection

Often, there is no adequate protection against water, as generally oil-containing, penetrating and/or aggressive cooling-lubricating mediums are used.

The following table will help you to select the required degree of protection. In addition to the theoretical DIN regulations, practical experience values have been taken

into account. If in doubt, always select the next higher degree of protection.

Selecting the motor degree of protection

Effect	Liquids General workshop environment	Water, general, cooling-lubricating mediums (95% H ₂ O; 5% oil)	Penetrating oil; petroleum; aggressive cooling- lubricating medium
Dry	IP 23 or IP 64	–	–
Environment where liquids and fluids are present	IP 55	IP 64	IP 67
Mist	IP 55	IP 65	IP 67
Spray	IP 55	IP 65	IP 68
Jet	(IP 55)	IP 67	IP 68
Splash; brief immersion; continuous flooding	–	IP 67	IP 68

IP 1st code (0–6):
Degree of protection
against contact and the
ingress/penetration of
foreign bodies

IP 2nd code (0–8):
Degree of protection
against the ingress of
water (no protection
against oil)

Permanent Magnet Servo-
motors with separately-
driven fan fulfill, according to
EN 60 529, degree of protec-
tion IP 64. The IP 65 or IP 67
option cannot be fulfilled if a
separately-driven fan is used.



Speed-Torque curves for 1FK6

Rated speed n_n 3000 rpm

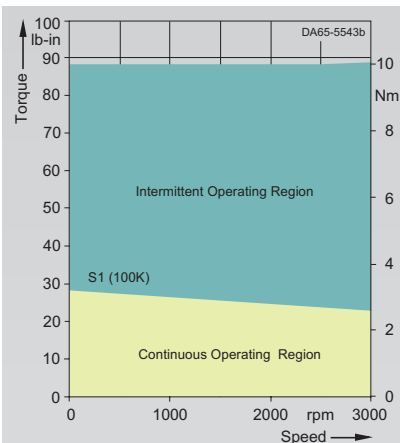

1FK6042-6AF71-1...

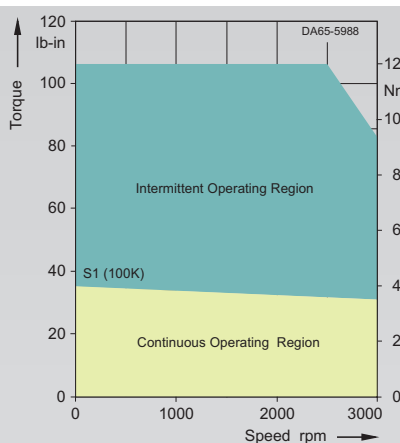

1FK6044-7AF71-1...

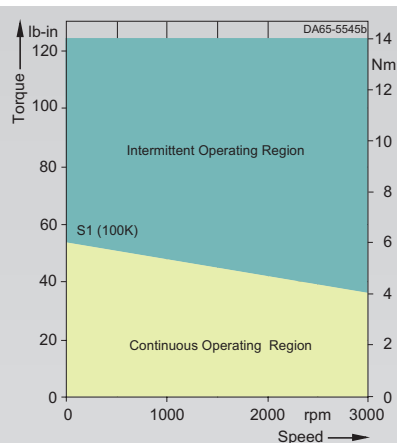

1FK6060-6AF71-1...

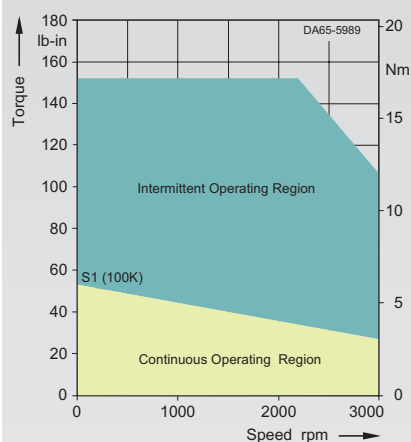

1FK6061-7AF71-1...

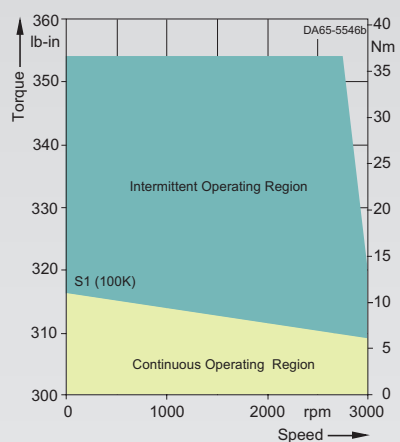

1FK6063-6AF71-1...

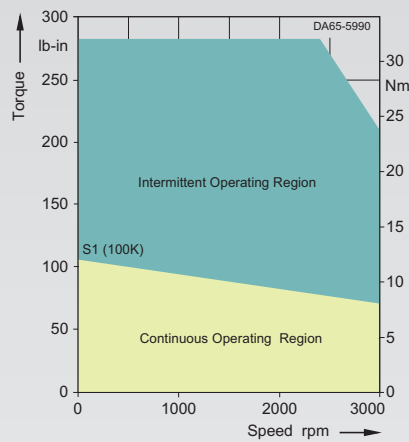

1FK6064-7AF71-1...

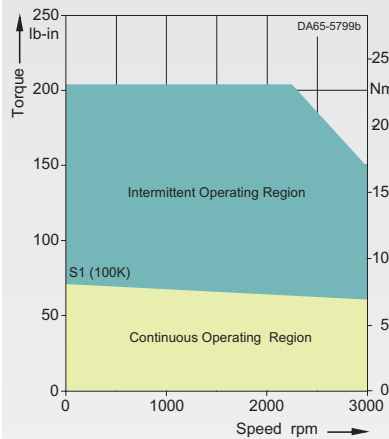

1FK6080-6AF71-1...

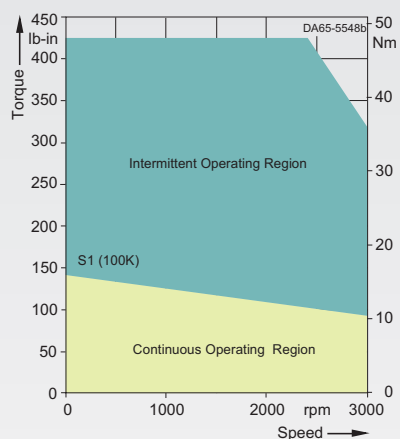

1FK6083-6AF71-1...

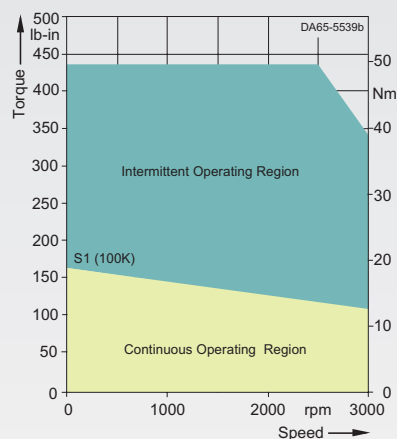

1FK6100-8AF71-1...



Servomotors Configuration Aids

1FK6 servomotors

Synchronous
Servomotors

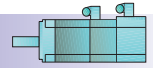

Speed-Torque curves for 1FK6

Rated speed n_n 3000 rpm

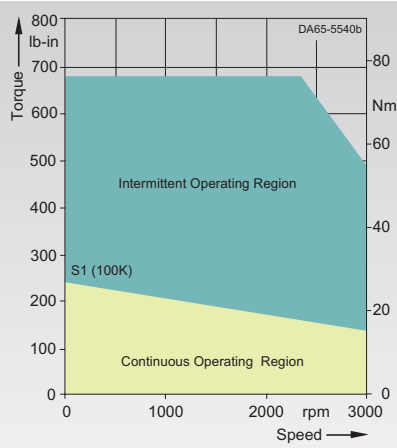

1FK6101-8AF71-1...

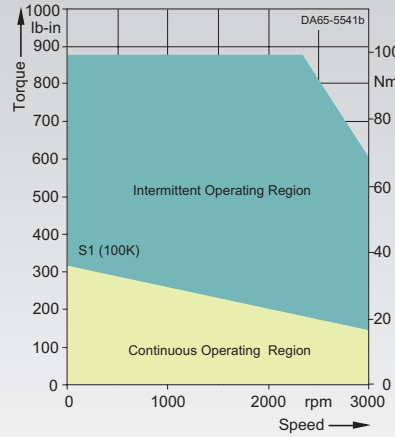

1FK6103-8AF71-1...

Rated speed n_n 4000 rpm

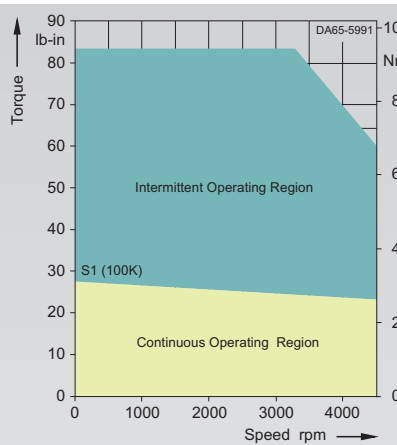

1FK6043-7AH71-1...

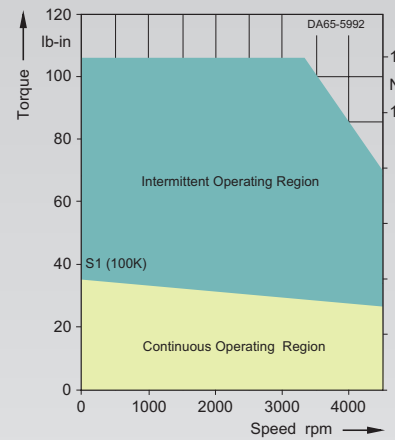

1FK6044-7AH71-1...

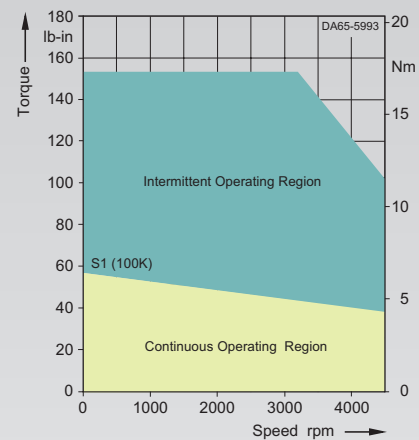

1FK6061-7AH71-1...

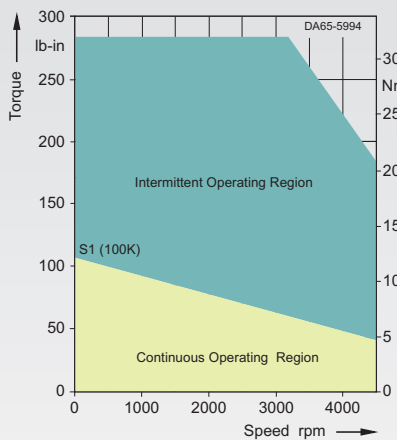

1FK6064-7AH71-1...

7



Speed-Torque curves for 1FK6

Rated speed n_n 6000 rpm

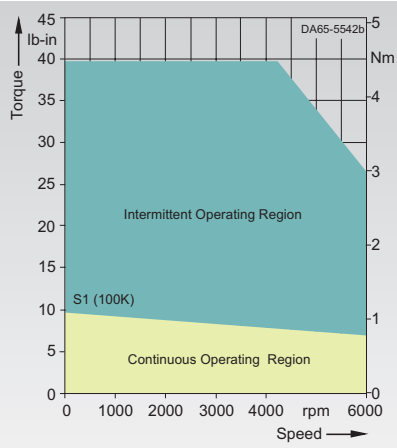

1FK6032-6AK71-1...

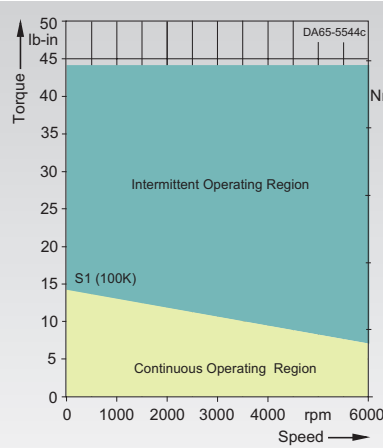

1FK6040-6AK71-1...

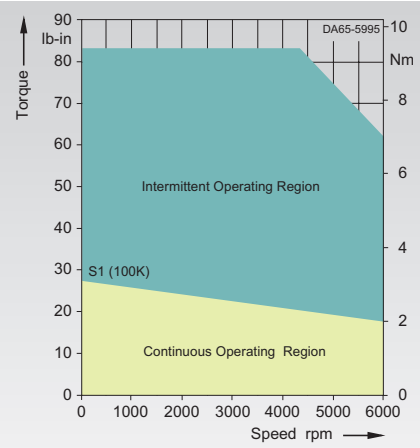

1FK6043-7AK71-1...

Speed-Torque curves for 1FT6

Rated speed n_n 1500 rpm, non-ventilated

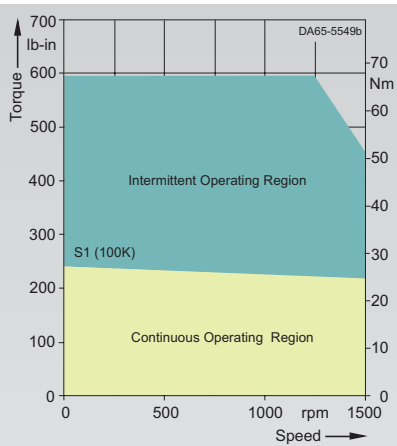

1FT6102-8AB7-....

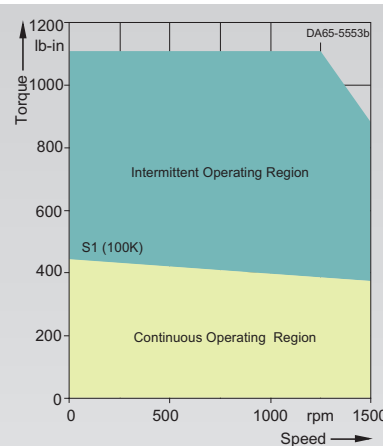

1FT6105-8AB7-....

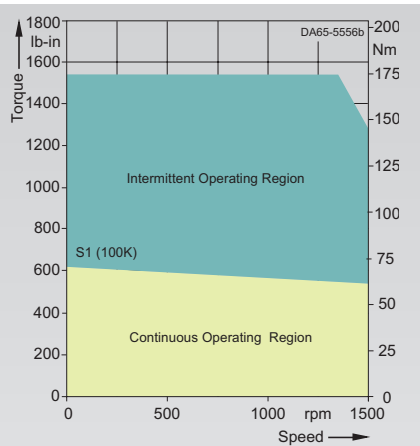

1FT6108-8AB7-....

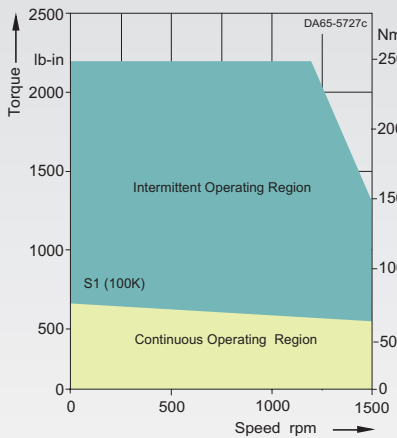

1FT6132-6AB7-....

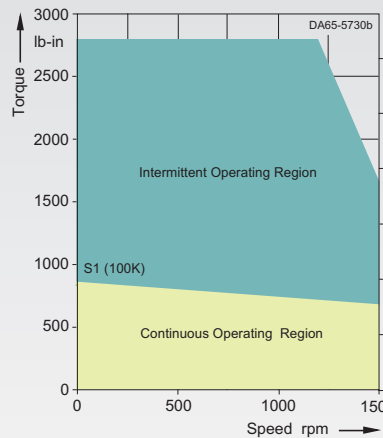

1FT6134-6AB7-....

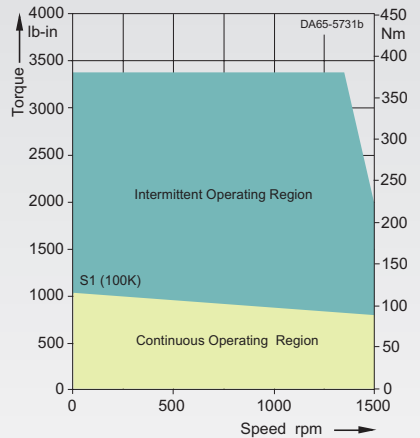

1FT6136-6AB7-....

Servomotors Configuration Aids

1FT6 servomotors



Speed-Torque curves for 1FT6

Rated speed n_n 1500 rpm, blower-ventilated

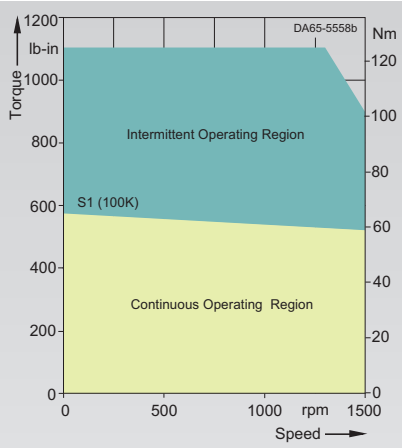

1FT6105-8SB7-....

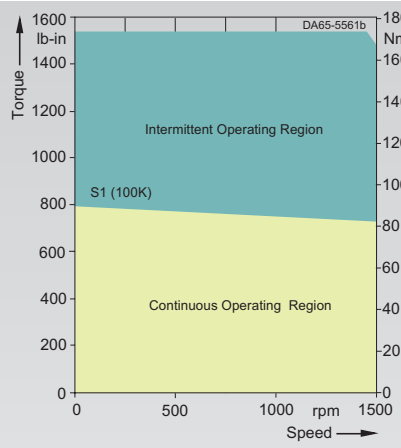

1FT6108-8SB7-....

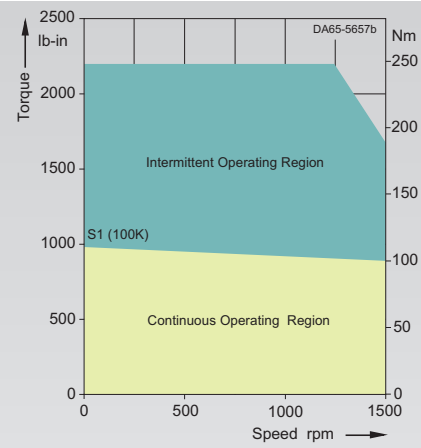

1FT6132-6SB7-....

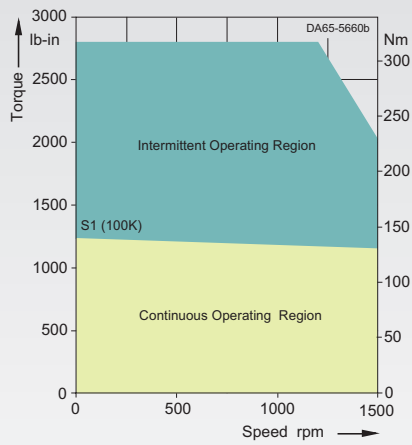

1FT6134-6SB7-....

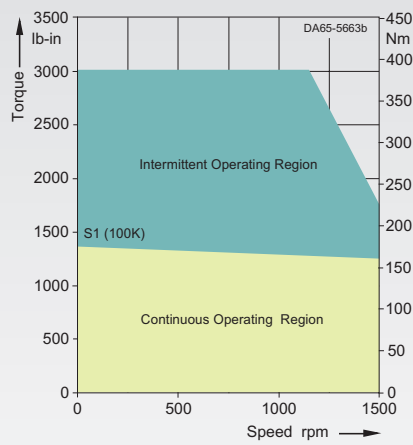

1FT6136-6SB7-....

Rated speed n_n 2000 rpm, non-ventilated

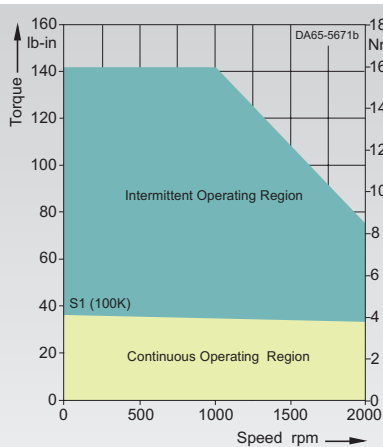

1FT6061-6AC7-....

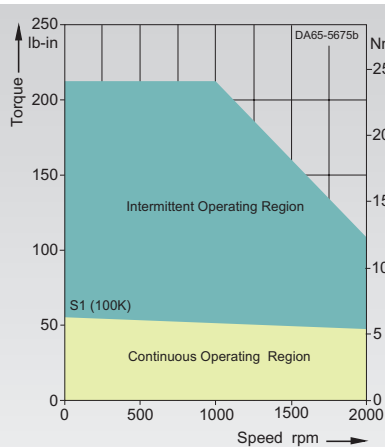

1FT6062-6AC7-....

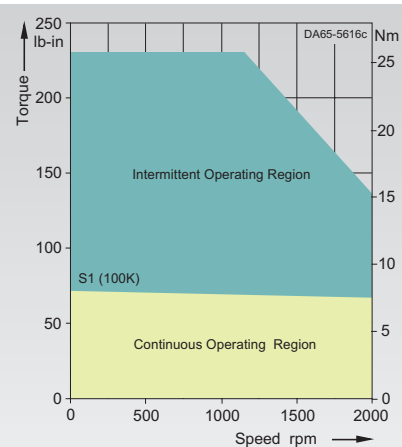

1FT6081-8AC7-....

7



Speed-Torque curves for 1FT6

Rated speed n_n 2000 rpm, non-ventilated

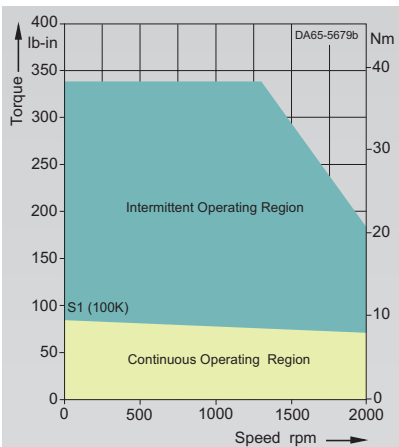

1FT6064-6AC7-....

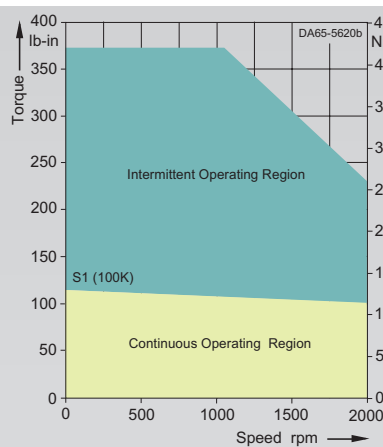

1FT6082-8AC7-....

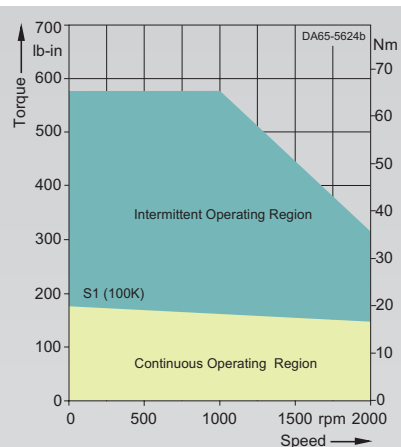

1FT6084-8AC7-....

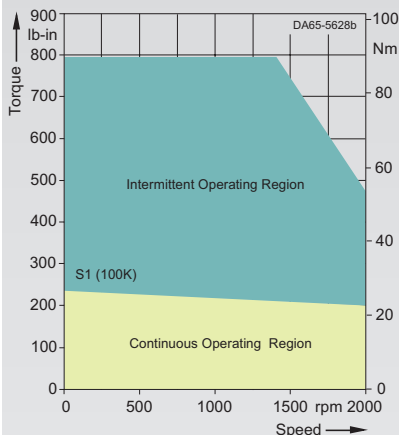

1FT6086-8AC7-....

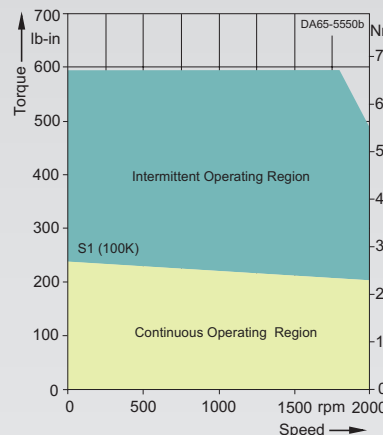

1FT6102-8AC7-....

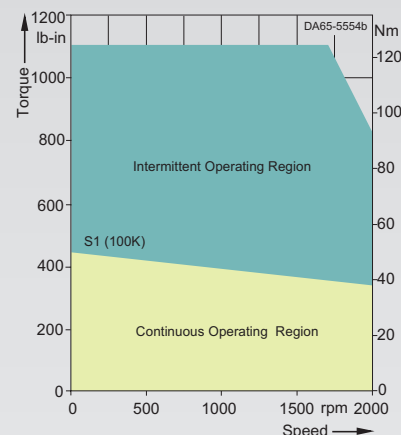

1FT6105-8AC7-....

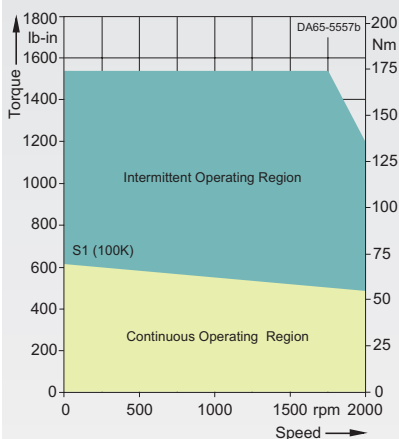

1FT6108-8AC7-....

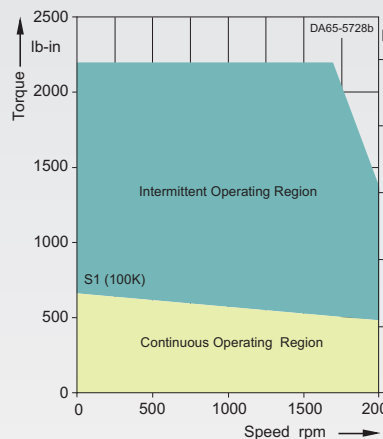

1FT6132-6AC7-....

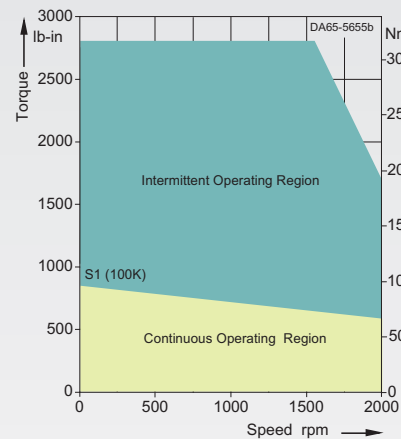

1FT6134-6AC7-....



Servomotors Configuration Aids

1FT6 servomotors

Synchronous
Servomotors

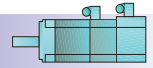

Speed-Torque curves for 1FT6

Rated speed n_n 2000 rpm, non-ventilated

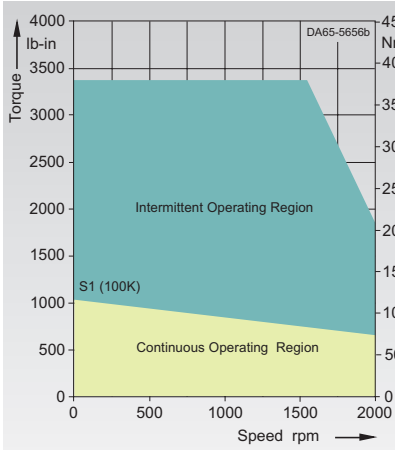

1FT6136-6AC7.-....

Rated speed n_n 2000 rpm, blower-ventilated

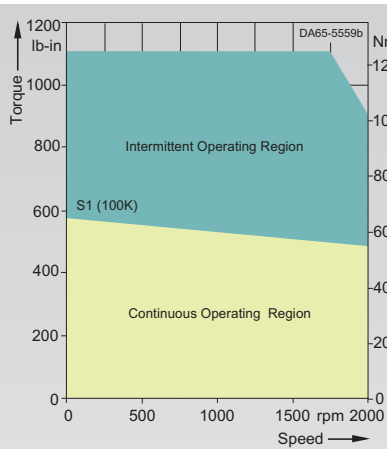

1FT6105-8SC7.-....

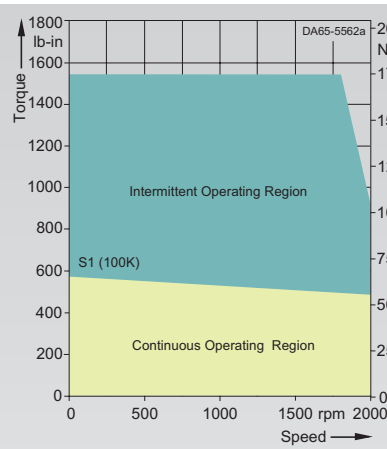

1FT6108-8SC7.-....

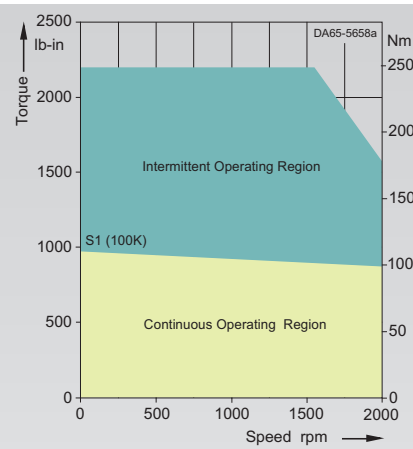

1FT6132-6SC7.-....

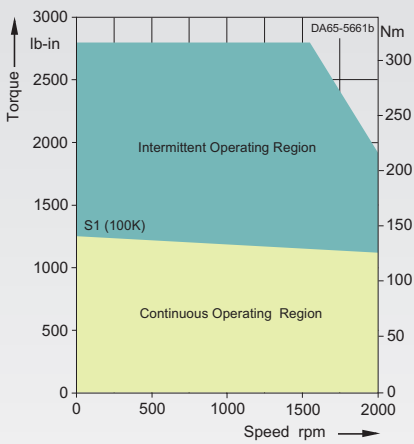

1FT6134-6SC7.-....

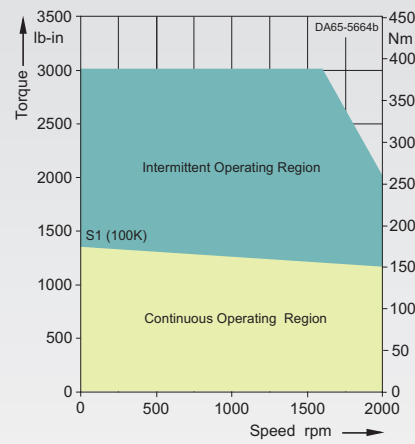

1FT6136-6SC7.-....

7



Speed-Torque curves for 1FT6

Rated speed n_n 3000 rpm, non-ventilated

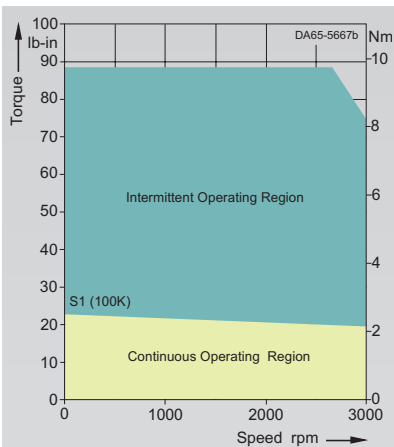

1FT6041-4AF7-....

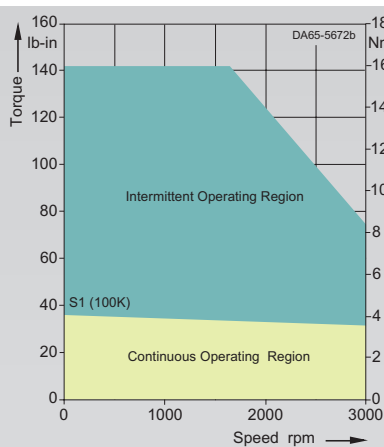

1FT6061-6AF7-....

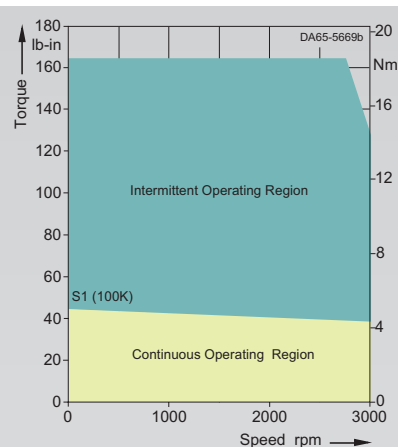

1FT6044-4AF7-....

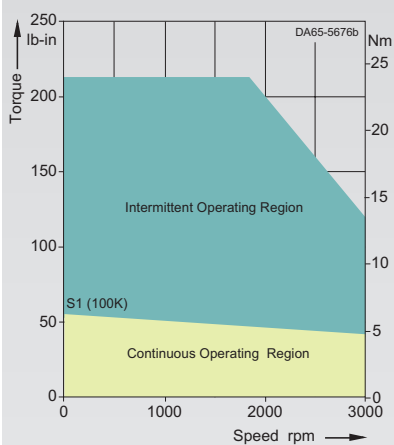

1FT6062-6AF7-....

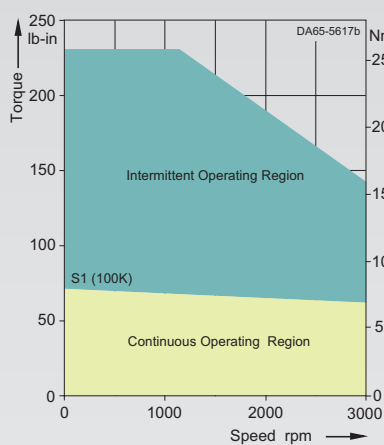

1FT6081-8AF7-....

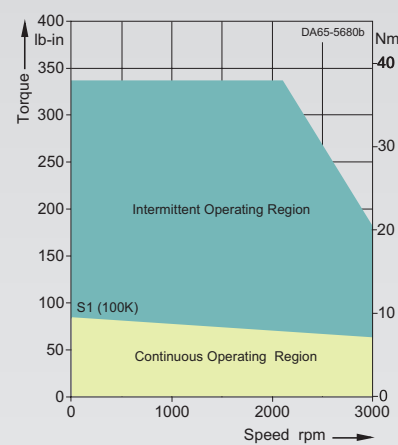

1FT6064-6AF7-....

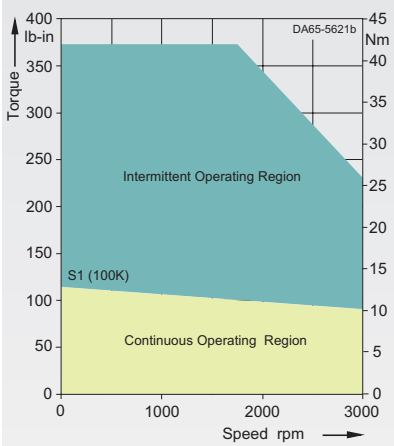

1FT6082-8AF7-....

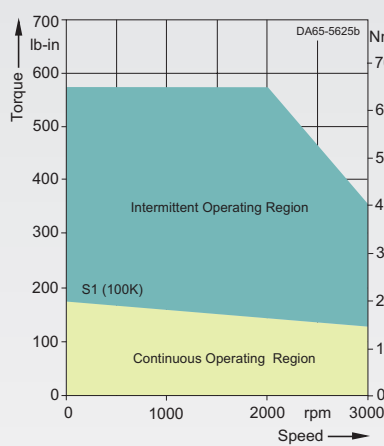

1FT6084-8AF7-....

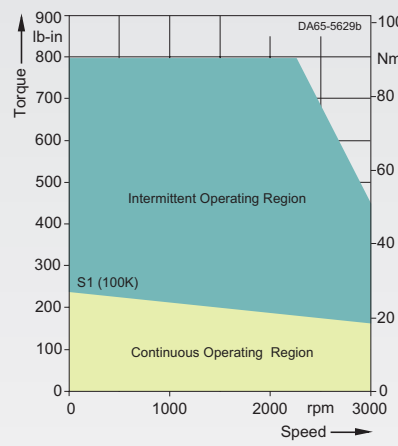

1FT6086-8AF7-....



Servomotors Configuration Aids

1FT6 servomotors



Speed-Torque curves for 1FT6

Rated speed n_n 3000 rpm, non-ventilated

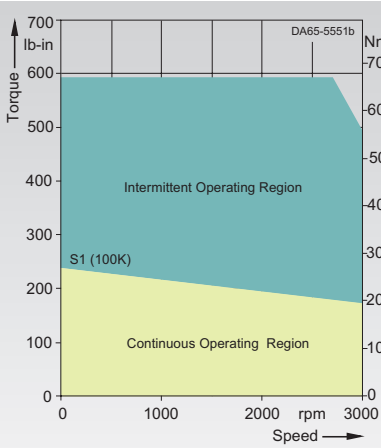

1FT6102-8AF7.-....

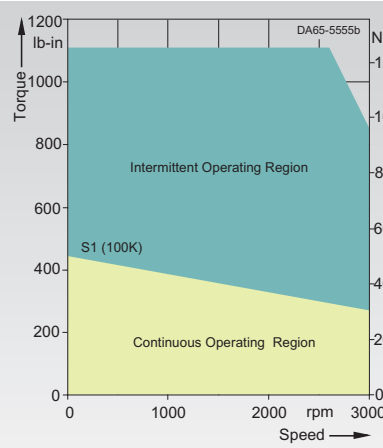

1FT6105-8AF7.-....

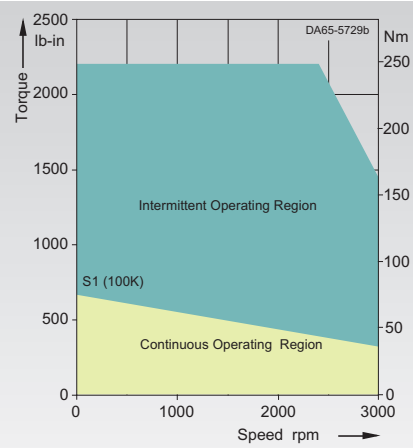

1FT6132-6AF7.-....

Rated speed n_n 3000 rpm, blower-ventilated

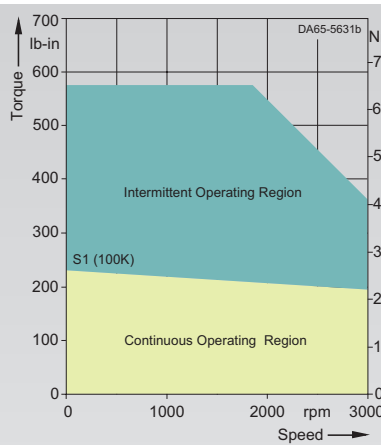

1FT6084-8SF7.-....

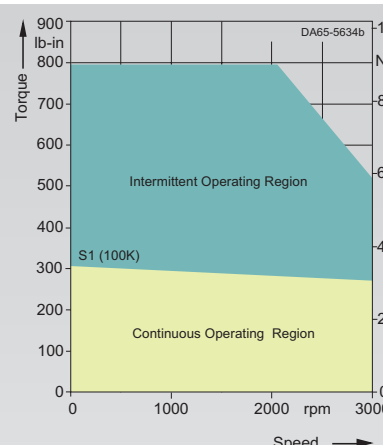

1FT6086-8SF7.-....

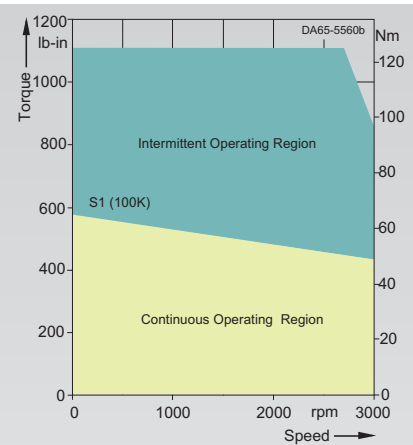

1FT6105-8SF7.-....

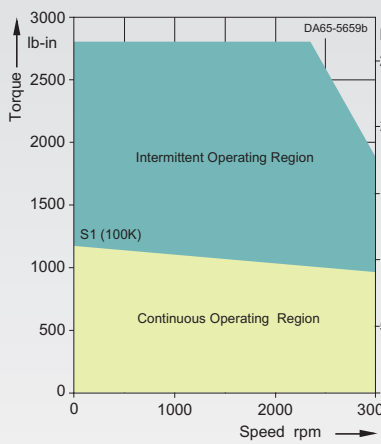

1FT6132-6SF7.-....

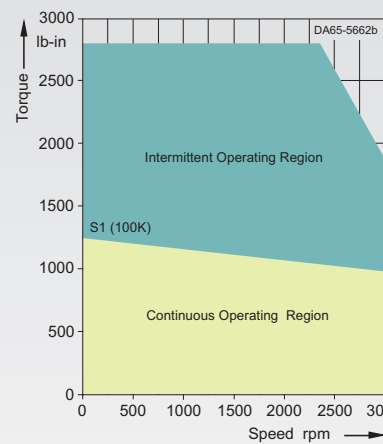

1FT6134-6SF7.-....

7

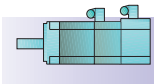

Speed-Torque curves for 1FT6

Rated speed n_n 4500 rpm, non-ventilated

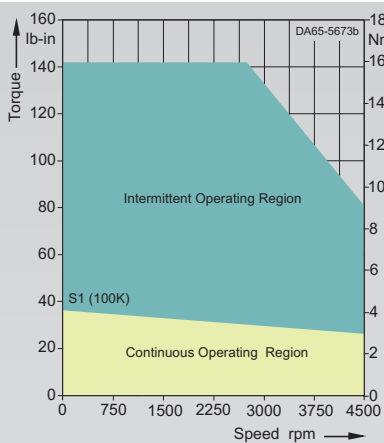

1FT6061-6AH7.-....

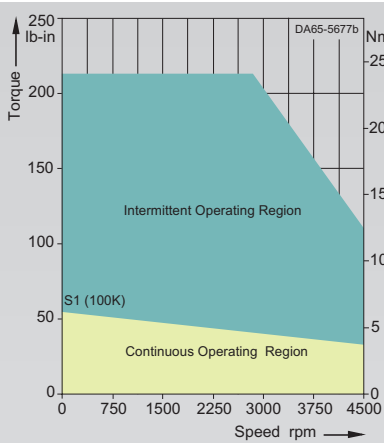

1FT6062-6AH7.-....

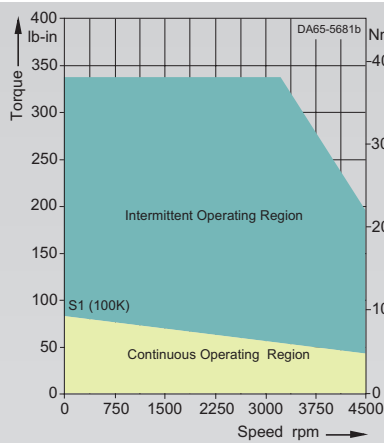

1FT6081-8AH7.-....

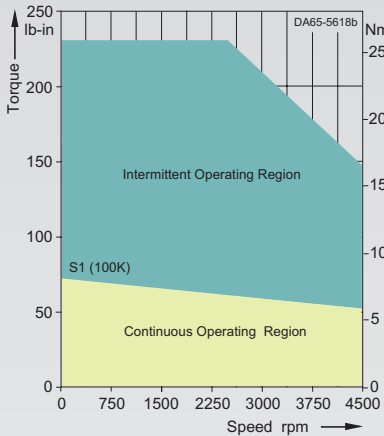

1FT6064-6AH7.-....

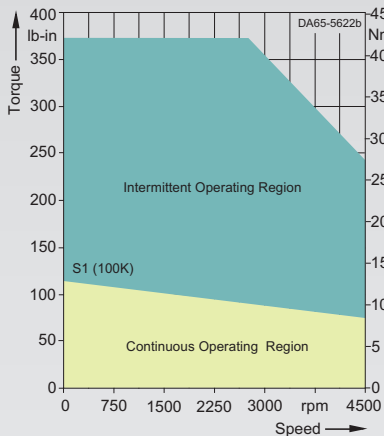

1FT6082-8AH7.-....

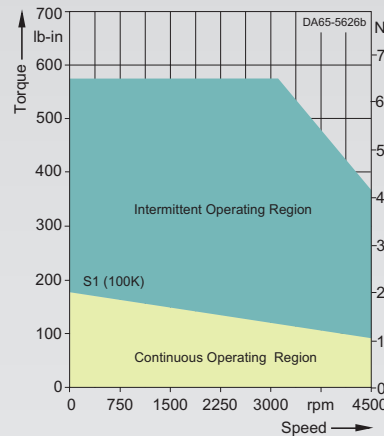

1FT6084-8AH7.-....

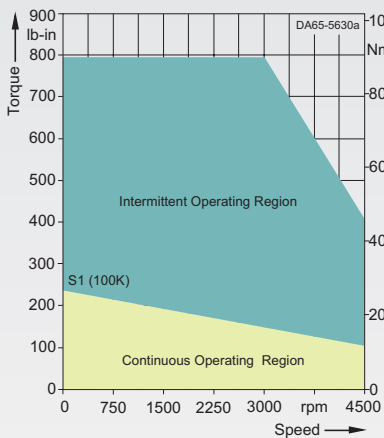

1FT6086-8AH7.-....

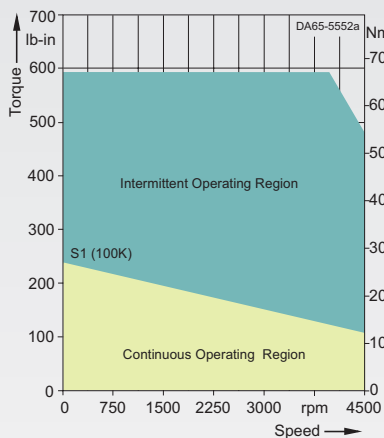

1FT6102-8AH7.-....



Servomotors Configuration Aids

1FT6 servomotors



Speed-Torque curves for 1FT6

Rated speed n_n 4500 rpm, blower-ventilated

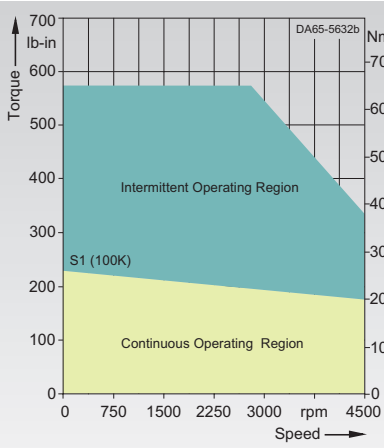

1FT6084-8SH7.-....

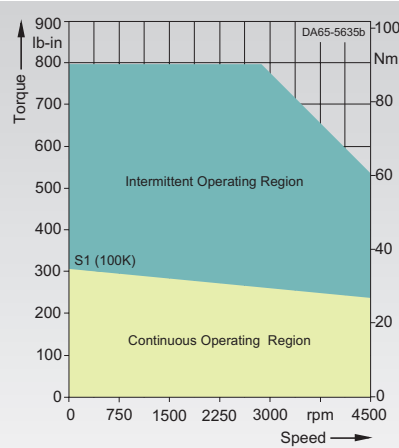

1FT6086-8SH7.-....

Rated speed n_n 6000 rpm, non-ventilated

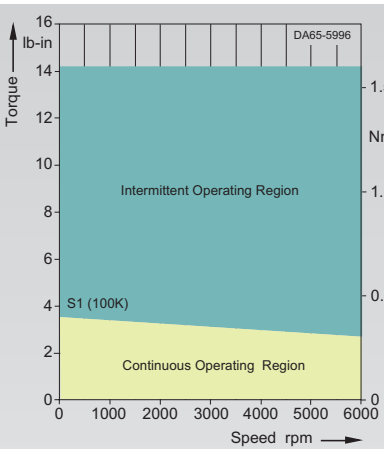

1FT6021-6AK7.-....

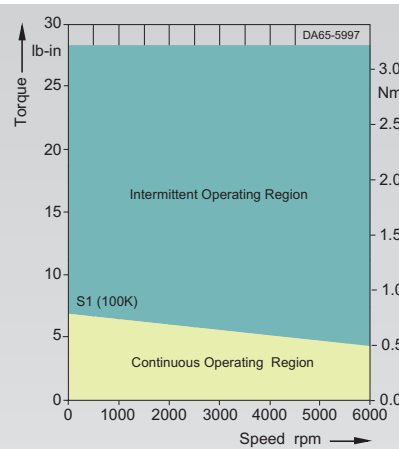

1FT6024-6AK7.-....

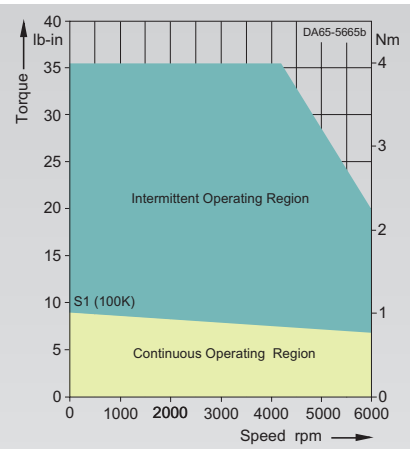

1FT6031-4AK7.-....

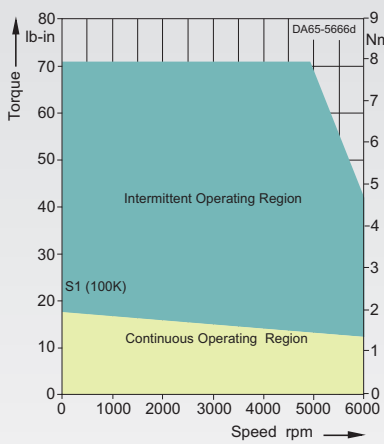

1FT6034-4AK7.-....

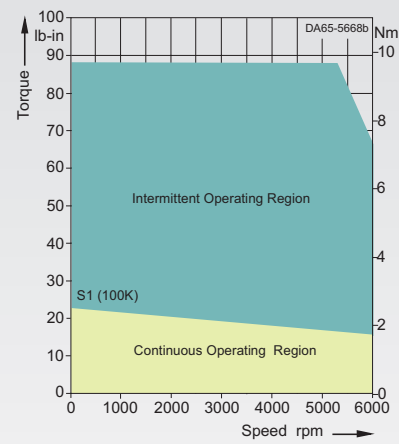

1FT6041-4AK7.-....

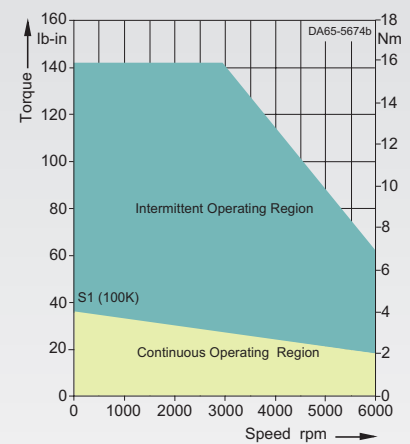

1FT6061-6AK7.-....

7

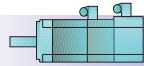

Synchronous
Servomotors

1FT6 servomotors

Speed-Torque curves for 1FT6

Rated speed n_n 6000 rpm, non-ventilated

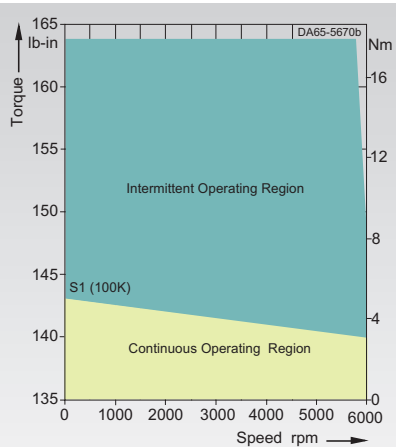

1FT6044-4AK7.-....

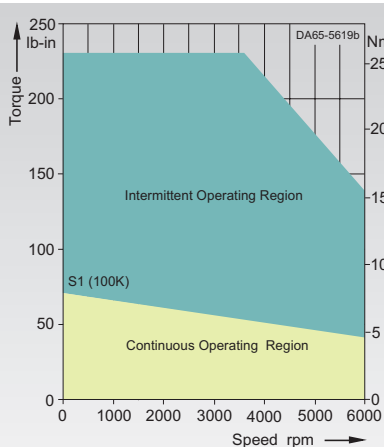

1FT6081-8AK7.-....

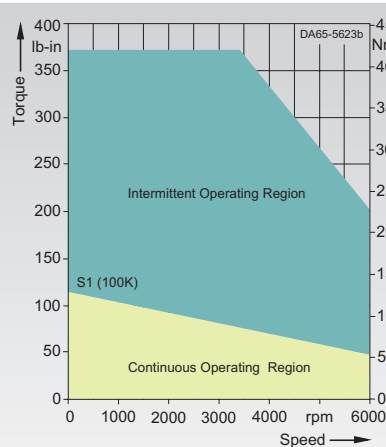

1FT6082-8AK7.-....

Rated speed n_n 6000 rpm, blower-ventilated

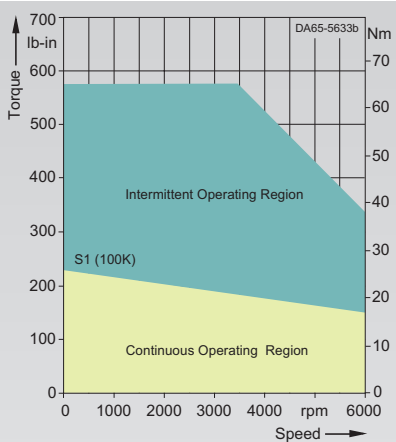

1FT6084-8SK7.-....

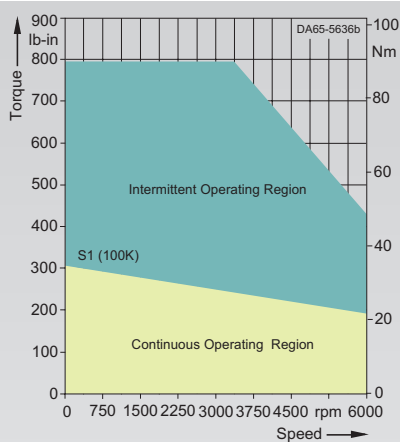

1FT6086-8SK7.-....

Servomotors Configuration Aids

1FT6 servomotors



Speed-Torque curves for 1FT6

Rated speed n_n 1500 rpm, water-cooled

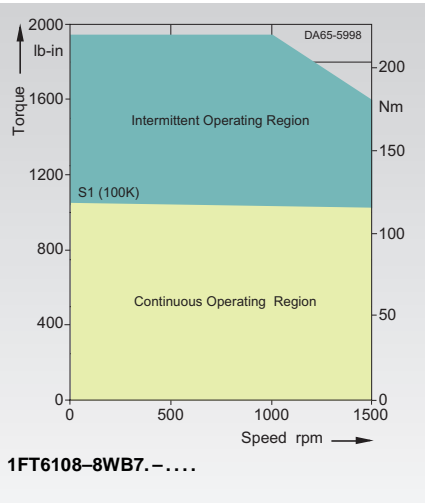

Rated speed n_n 2000 rpm, water-cooled

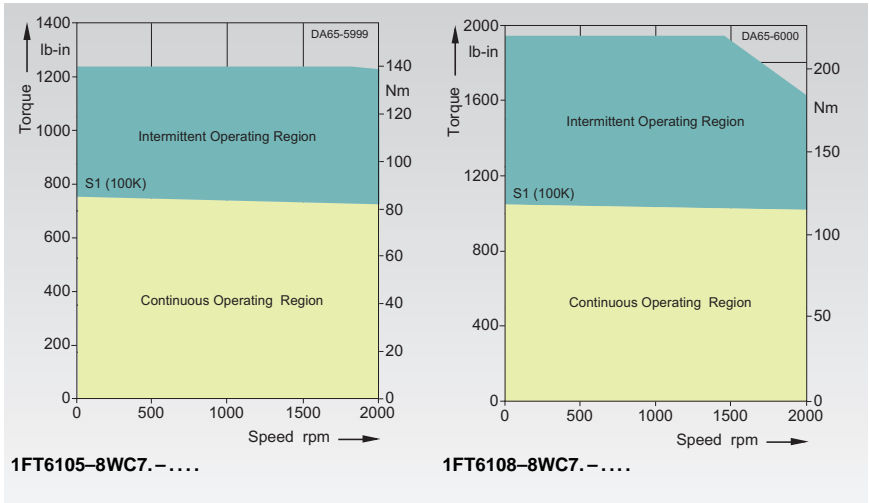

Rated speed n_n 3000 rpm, water-cooled

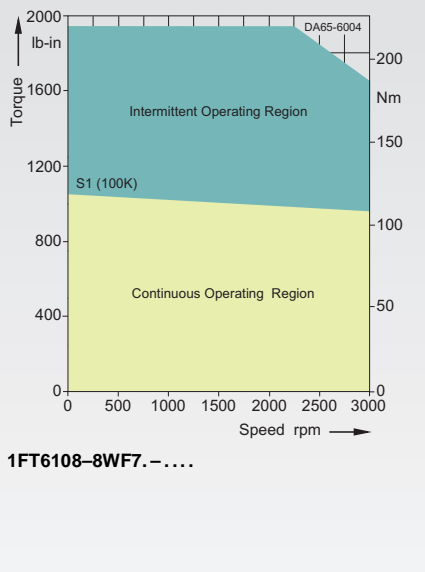
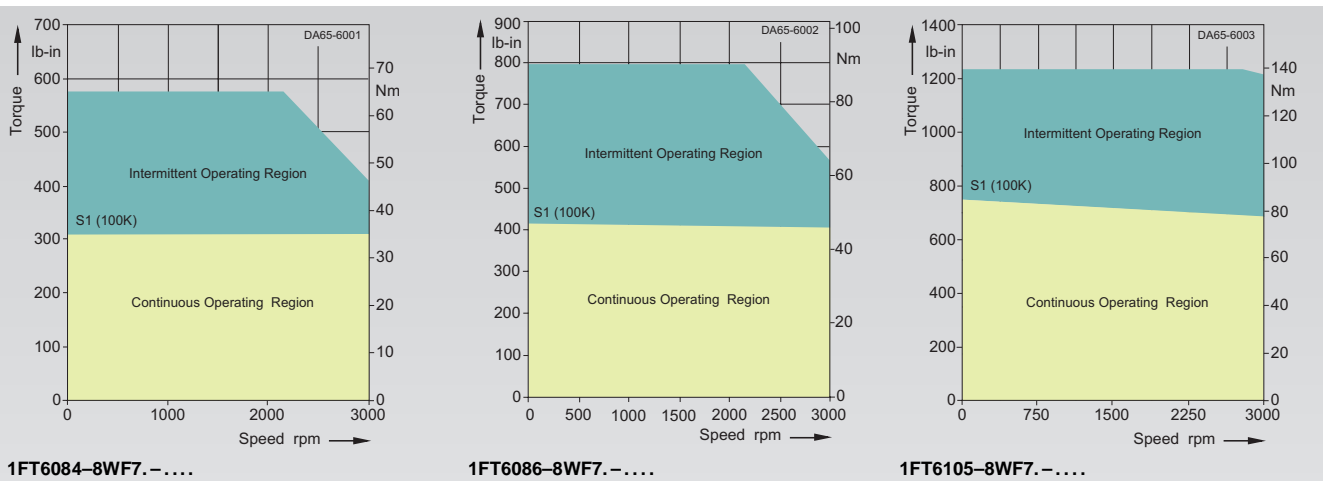

7



Speed-Torque curves for 1FT6

Rated speed n_n 4500 rpm, water-cooled

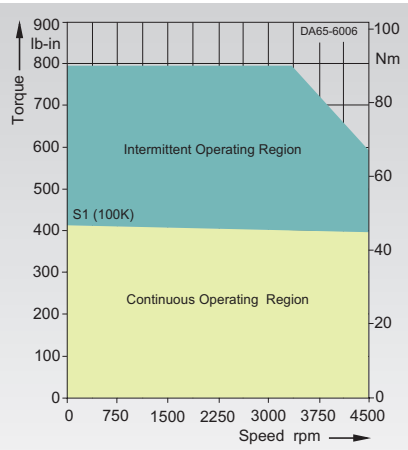
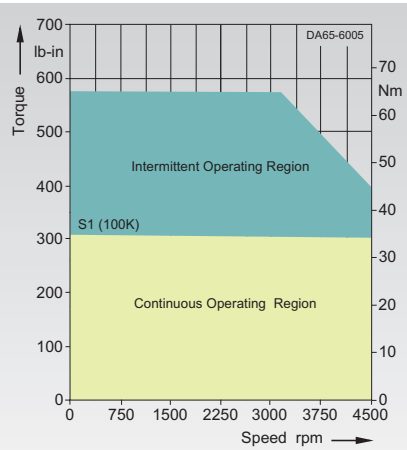

Rated speed n_n 6000 rpm, water-cooled

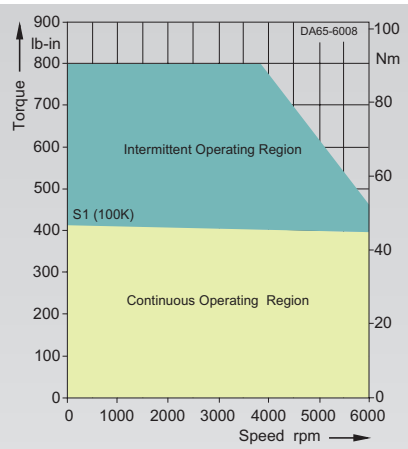
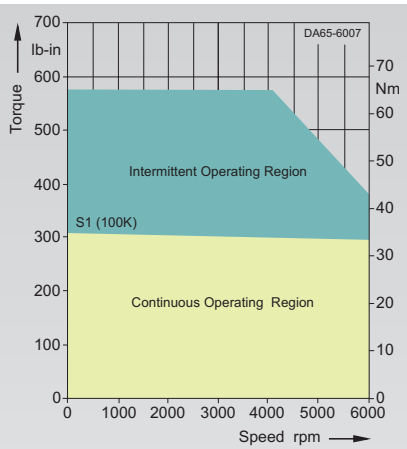

Servomotors Configuration Aids

1PH7 servomotors

Asynchronous
Servomotors



Speed-Torque curves for 1PH7 · 3 AC 480 V SIMOVERT MASTERDRIVES Vector Control converters

Rated speed n_n 500 rpm

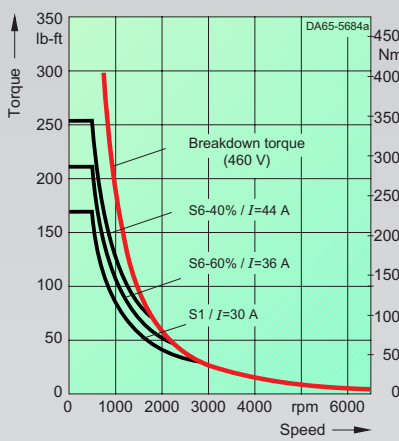

1PH7163-2.B.-...
max. breakdown torque: 537 lb-ft/728 Nm

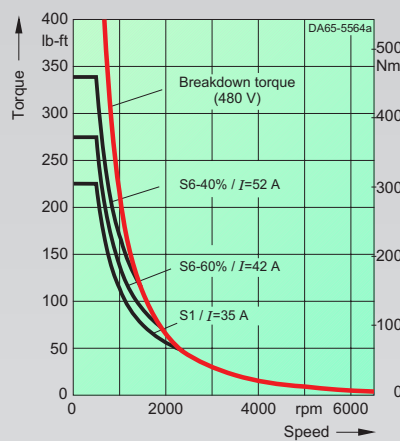

1PH7167-2.B.-...
max. breakdown torque: 673 lb-ft/913 Nm

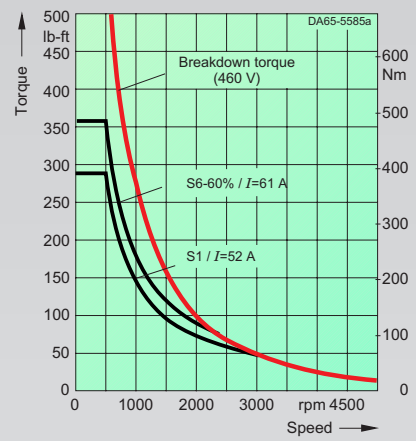

1PH7184-2.B.-...
max. breakdown torque: 567 lb-ft/769 Nm

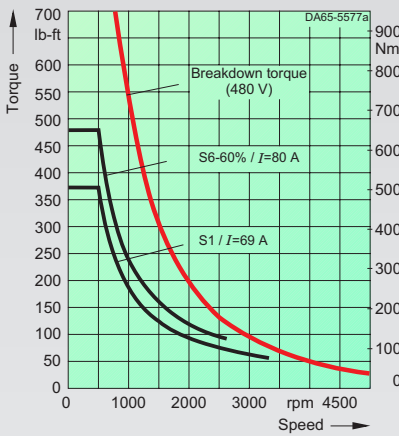

1PH7186-2.B.-...
max. breakdown torque: 818 lb-ft/1109 Nm

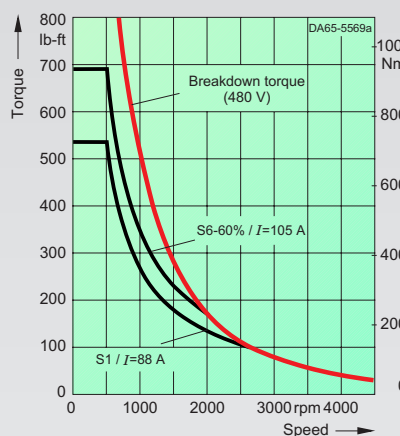

1PH7224-2.B.-...
max. breakdown torque: 1116 lb-ft/1513 Nm

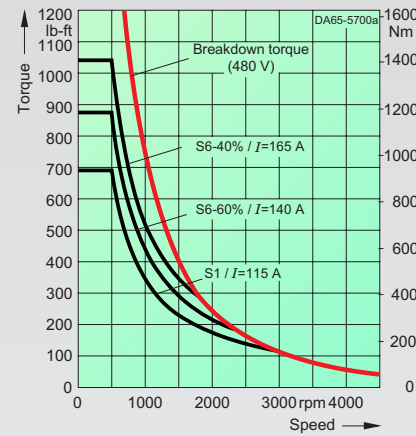

1PH7226-2.B.-...
max. breakdown torque: 1674 lb-ft/2269 Nm

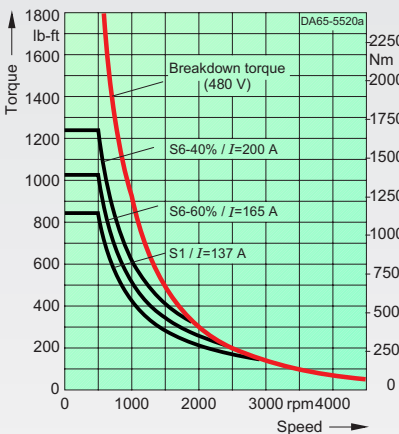

1PH7228-2.B.-...
max. breakdown torque: 2054 lb-ft/2785 Nm

7



Asynchronous
Servomotors

Servomotors Configuration Aids

1PH7 servomotors

Speed-Torque curves for 1PH7 · 3 AC 480 V SIMOVERT MASTERDRIVES Vector Control converters

Rated speed n_n 1350 rpm

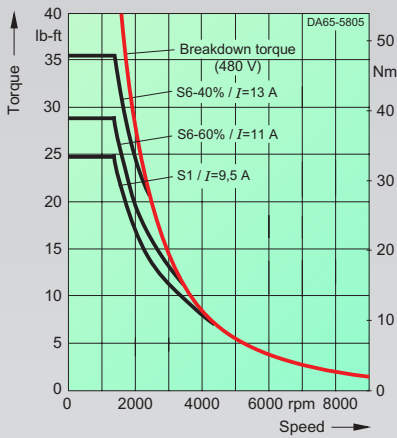

1PH7103-2.D...-....
max. breakdown torque: 53 lb-ft/73 Nm

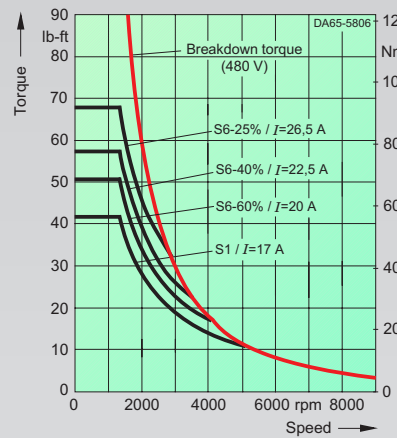

1PH7107-2.D...-....
max. breakdown torque: 100 lb-ft/135 Nm

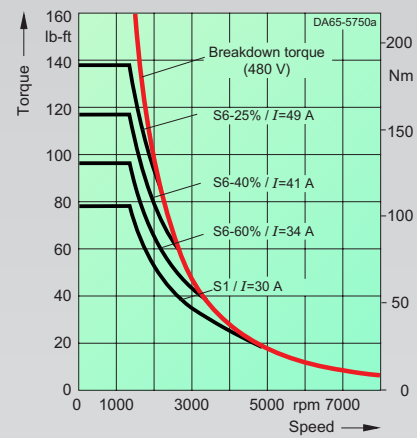

1PH7133-2.D...-....
max. breakdown torque: 207 lb-ft/282 Nm

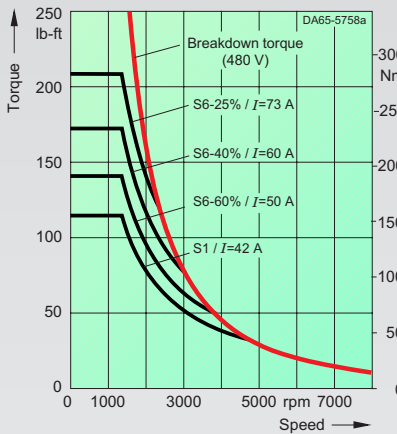

1PH7137-2.D...-....
max. breakdown torque: 347 lb-ft/471 Nm

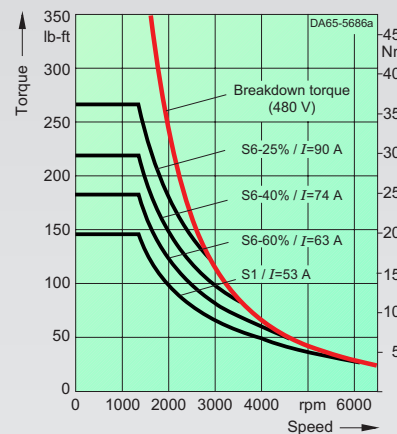

1PH7163-2.D...-....
max. breakdown torque: 538 lb-ft/730 Nm

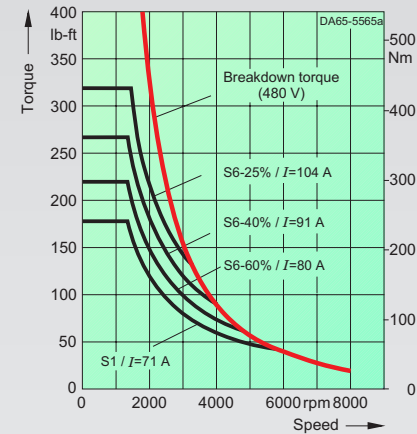

1PH7167-2.D...-....
max. breakdown torque: 740 lb-ft/1004 Nm

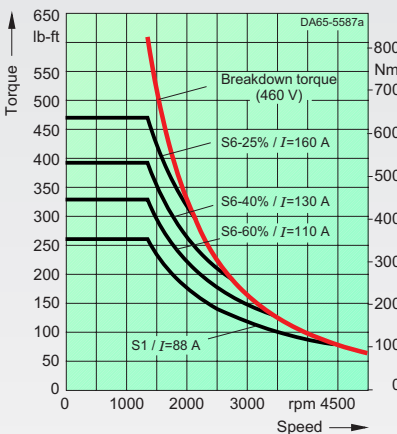

1PH7184-2.D...-....
max. breakdown torque: 607 lb-ft/823 Nm

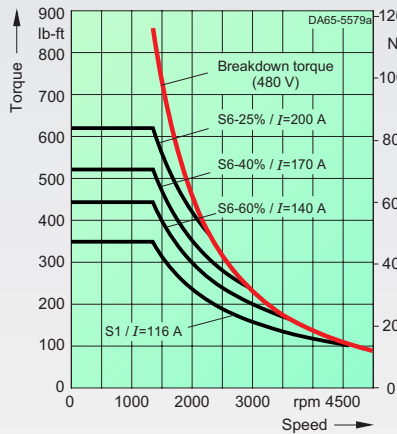

1PH7186-2.D...-....
max. breakdown torque: 858 lb-ft/1163 Nm

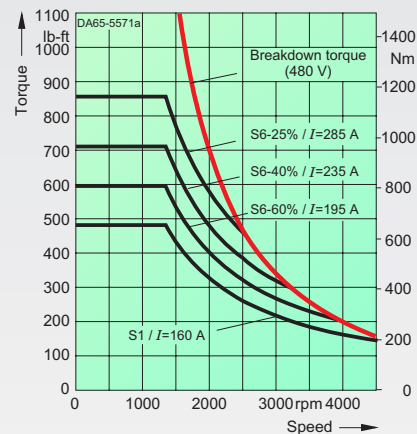

1PH7224-2.D...-....
max. breakdown torque: 1383 lb-ft/1875 Nm

7

Servomotors Configuration Aids

1PH7 servomotors

Asynchronous
Servomotors



Speed-Torque curves for 1PH7 · 3 AC 480 V SIMOVERT MASTERDRIVES Vector Control converters

Rated speed n_n 1350 rpm

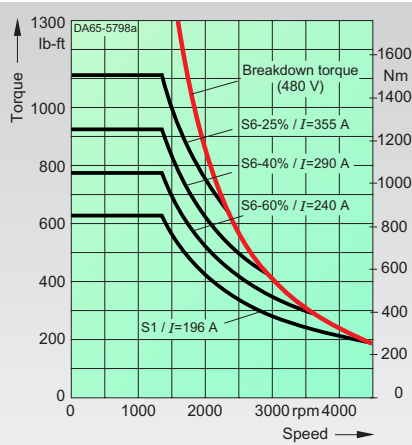

1PH7226-2.D...-....
max. breakdown torque: 1733 lb-ft/2350 Nm

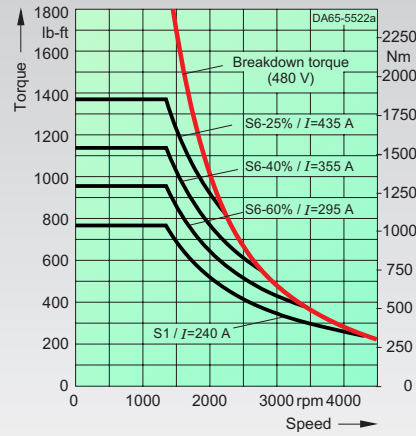

1PH7228-2.D...-....
max. breakdown torque: 2083 lb-ft/2824 Nm

Rated speed n_n 2000 rpm

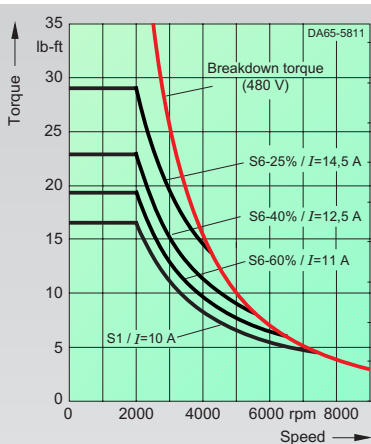

1PH7101-2.F...-....
max. breakdown torque: 49.4 lb-ft/67 Nm

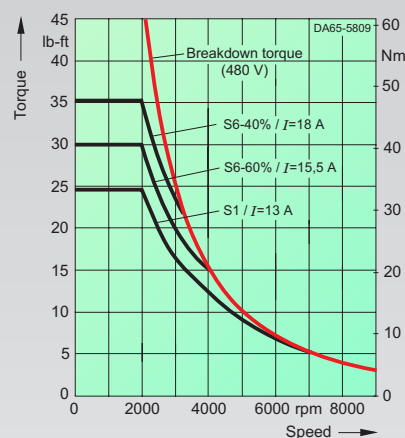

1PH7103-2.F...-....
max. breakdown torque: 49 lb-ft/66 Nm

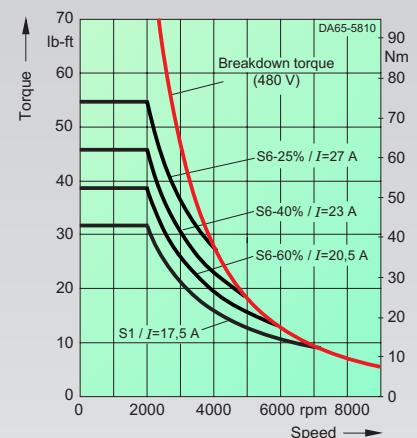

1PH7105-2.F...-....
max. breakdown torque: 93 lb-ft/126 Nm

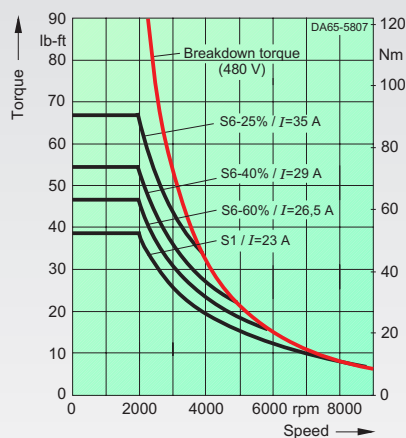

1PH7107-2.F...-....
max. breakdown torque: 113 lb-ft/154 Nm

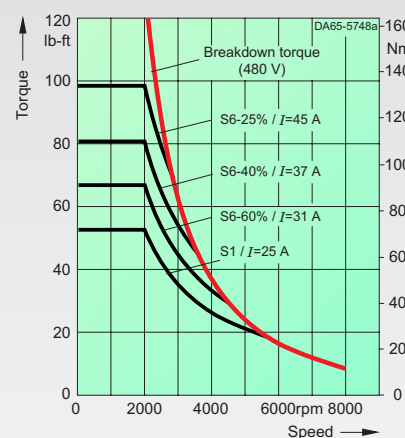

1PH7131-2.F...-....
max. breakdown torque: 143 lb-ft/194 Nm

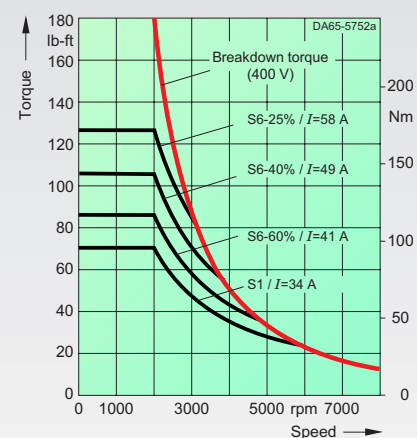

1PH7133-2.F...-....
max. breakdown torque: 197 lb-ft/267 Nm

7



Asynchronous
Servomotors

Servomotors Configuration Aids

1PH7 servomotors

Speed-Torque curves for 1PH7 · 3 AC 480 V SIMOVERT MASTERDRIVES Vector Control converters

Rated speed n_n 2000 rpm

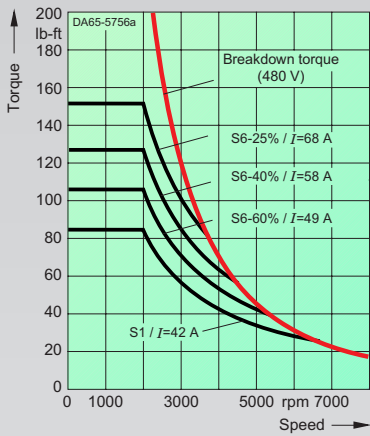

1PH7135-2.F.-....
max. breakdown torque: 275 lb-ft/373 Nm

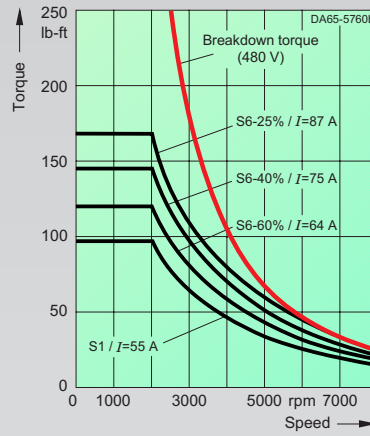

1PH7137-2.F.-....
max. breakdown torque: 392 lb-ft/531 Nm

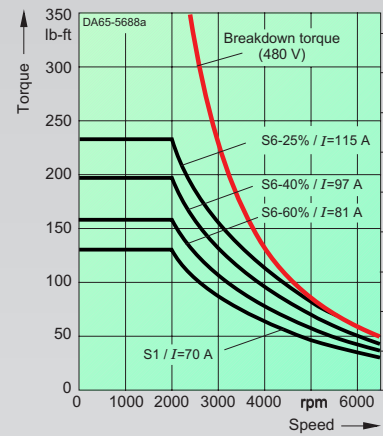

1PH7163-2.F.-....
max. breakdown torque: 542 lb-ft/735 Nm

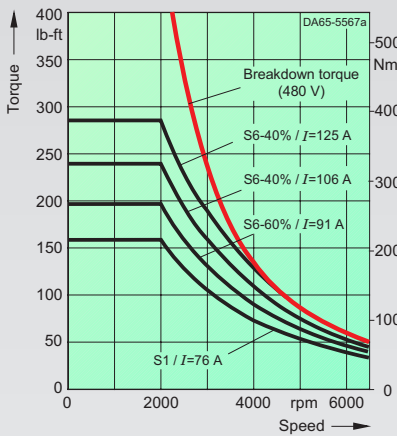

1PH7167-2.F.-....
max. breakdown torque: 553 lb-ft/750 Nm

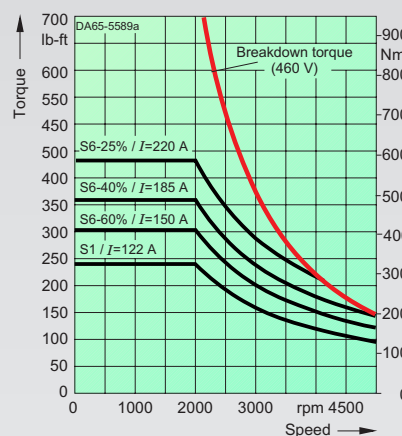

1PH7184-2.F.-....
max. breakdown torque: 780 lb-ft/1058 Nm

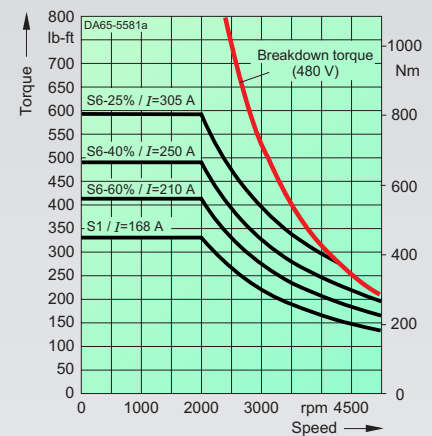

1PH7186-2.F.-....
max. breakdown torque: 1112 lb-ft/1507 Nm

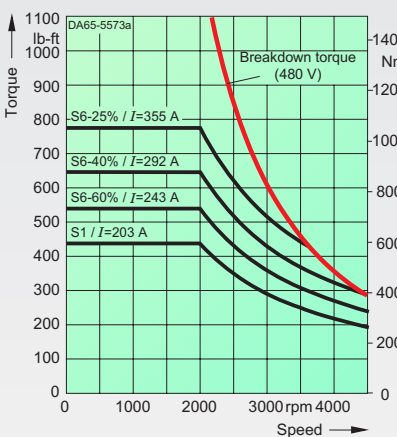

1PH7224-2.U.-....
max. breakdown torque: 1274 lb-ft/1727 Nm

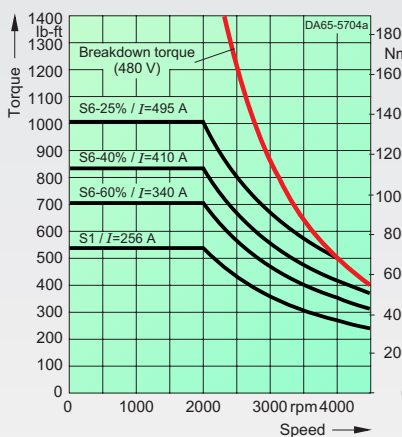

1PH7226-2.F.-....
max. breakdown torque: 1845 lb-ft/2502 Nm

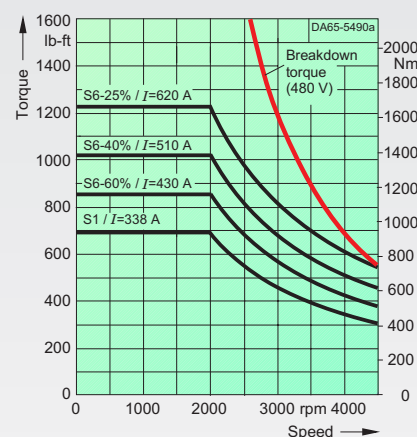

1PH7228-2.F.-....
max. breakdown torque: 2607 lb-ft/3535 Nm

Servomotors Configuration Aids

1PH7 servomotors

Asynchronous
Servomotors



Speed-Torque curves for 1PH7 · 3 AC 480 V SIMOVERT MASTERDRIVES Vector Control converters

Rated speed n_n 2650 rpm

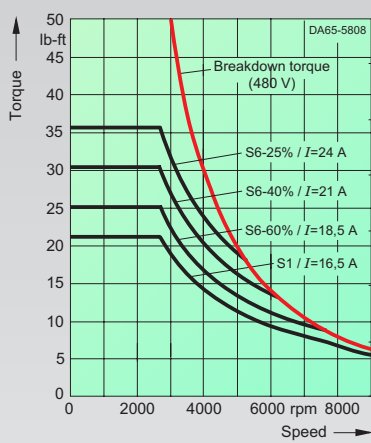

1PH7103-2.G...
max. breakdown torque: 61 lb-ft/83 Nm

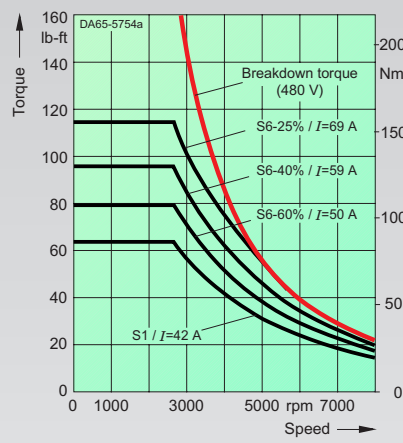

1PH7133-2.G...
max. breakdown torque: 202 lb-ft/274 Nm

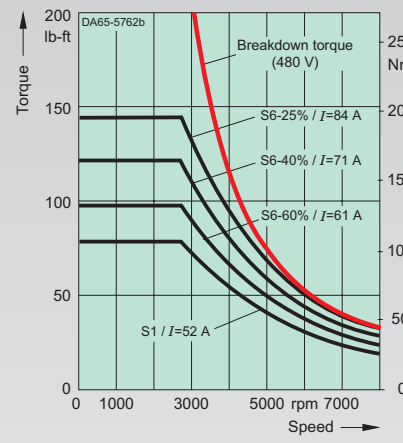

1PH7137-2.G...
max. breakdown torque: 287 lb-ft/390 Nm

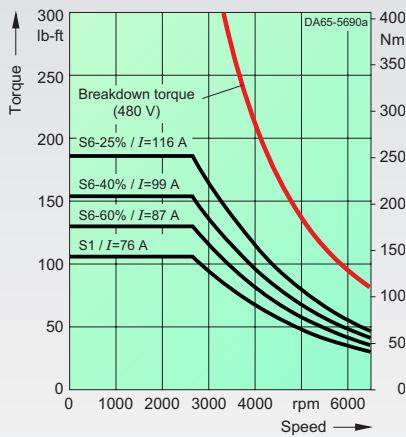

1PH7163-2.G...
max. breakdown torque: 513 lb-ft/696 Nm

Rated speed n_n 2900 rpm

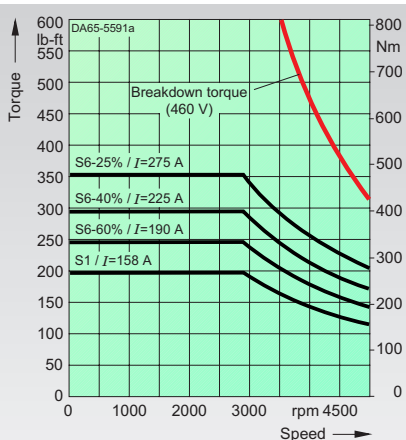

1PH7184-2.L...
max. breakdown torque: 780 lb-ft/1058 Nm

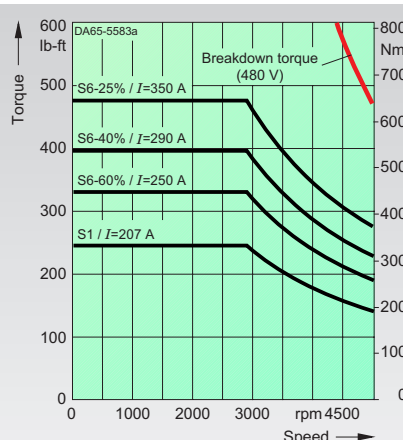

1PH7186-2.L...
max. breakdown torque: 1320 lb-ft/1790 Nm

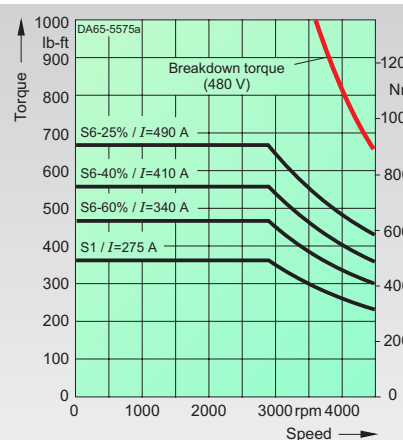

1PH7224-2.L...
max. breakdown torque: 1516 lb-ft/2055 Nm

7



Asynchronous
Servomotors

Speed-Torque curves for 1PH7 · 3 AC 480 V SIMOVERT MASTERDRIVES Vector Control converters

Rated speed n_n 2900 rpm

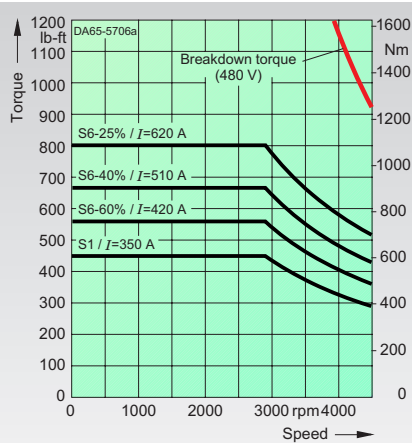

1PH7226-2.L.-.....
max. breakdown torque: 2168 lb-ft/2939 Nm

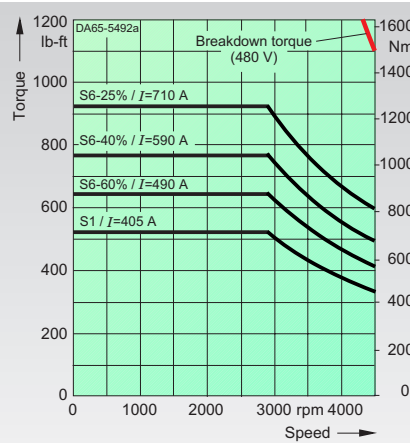

1PH7228-2.L.-.....
max. breakdown torque: 2621 lb-ft/3553 Nm

Speed-Torque curves for 1PH7 · 3 AC 480 V SIMOVERT MASTERDRIVES Motion Control converters and 3 AC 400 V SIMOVERT MASTERDRIVES Vector Control converters

Rated speed n_n 400 rpm

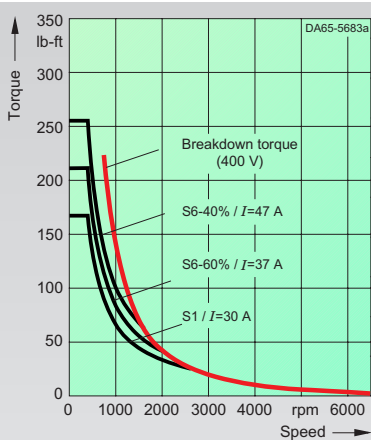

1PH7163-2.B.-.....
max. breakdown torque: 458 lb-ft/621 Nm

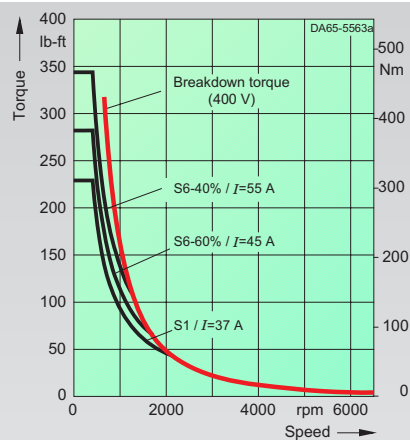

1PH7167-2.B.-.....
max. breakdown torque: 587 lb-ft/796 Nm

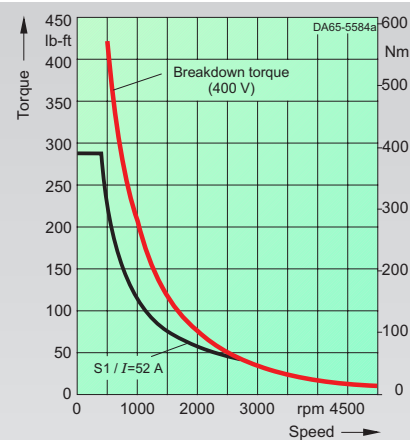

1PH7184-2.B.-.....
max. breakdown torque: 480 lb-ft/650 Nm

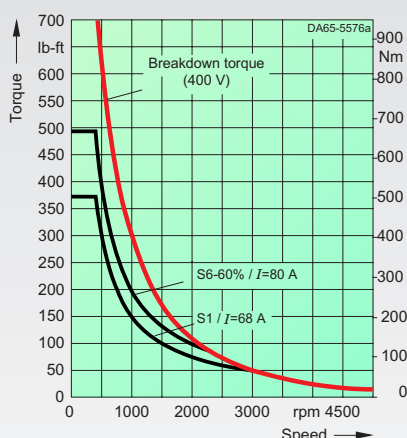

1PH7186-2.B.-.....
max. breakdown torque: 779 lb-ft/1056 Nm

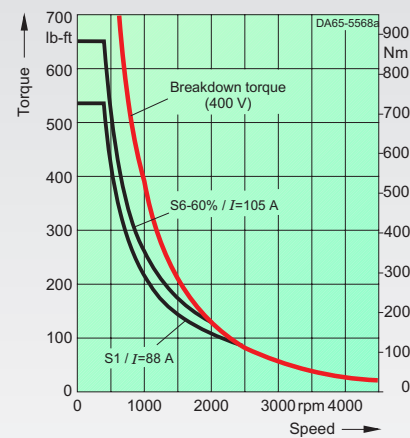

1PH7224-2.B.-.....
max. breakdown torque: 1153 lb-ft/1563 Nm

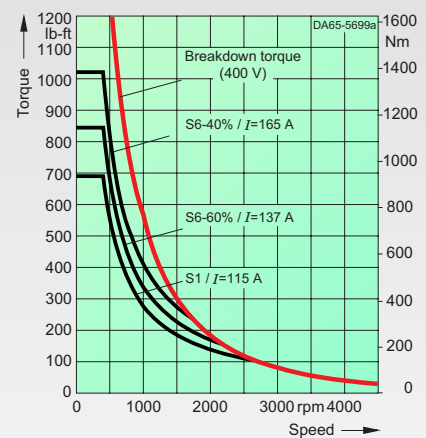

1PH7226-2.B.-.....
max. breakdown torque: 1661 lb-ft/2252 Nm

7

Servomotors Configuration Aids

1PH7 servomotors

Asynchronous
Servomotors



Speed-Torque curves for 1PH7 · 3 AC 480 V SIMOVERT MASTERDRIVES Motion Control converters and 3 AC 400 V SIMOVERT MASTERDRIVES Vector Control converters

Rated speed n_n 400 rpm

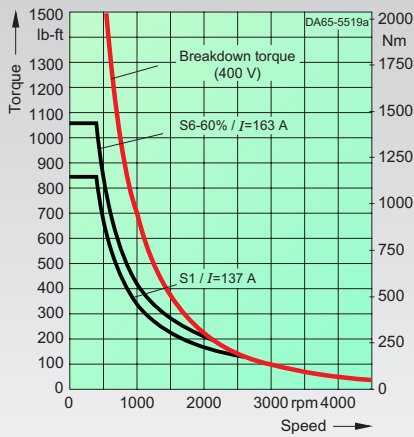

1PH7228-2.B...-....
max. breakdown torque: 2152 lb-ft/2917 Nm

Rated speed n_n 1150 rpm

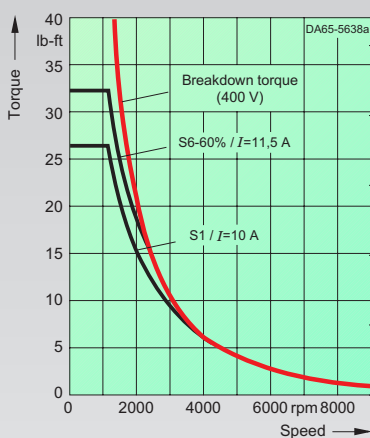

1PH7103-2.D...-....
max. breakdown torque: 51 lb-ft/69 Nm

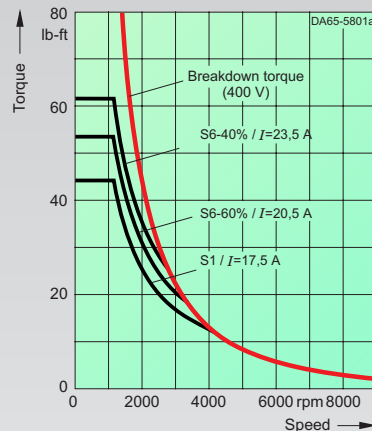

1PH7107-2.D...-....
max. breakdown torque: 96 lb-ft/130 Nm

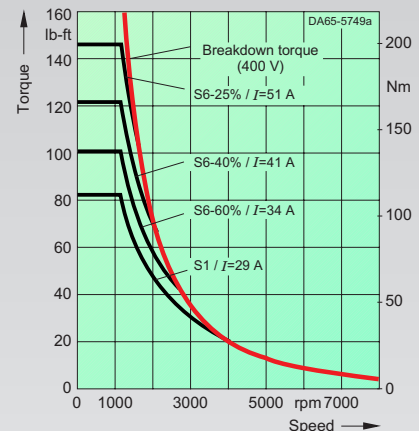

1PH7133-2.D...-....
max. breakdown torque: 200 lb-ft/271 Nm

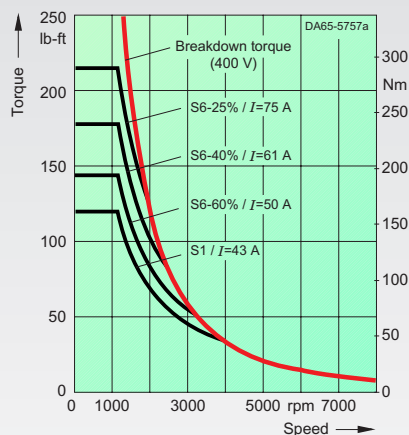

1PH7137-2.D...-....
max. breakdown torque: 335 lb-ft/454 Nm

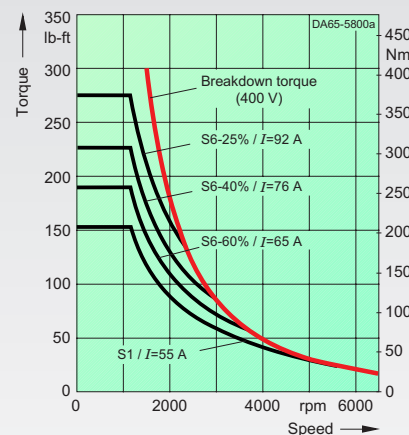

1PH7163-2.D...-....
max. breakdown torque: 525 lb-ft/712 Nm

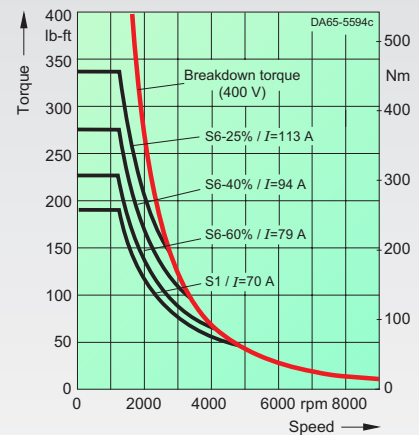

1PH7167-2.D...-....
max. breakdown torque: 724 lb-ft/981 Nm

7



Asynchronous
Servomotors

Servomotors Configuration Aids

1PH7 servomotors

Speed-Torque curves for 1PH7 · 3 AC 480 V SIMOVERT MASTERDRIVES Motion Control converters and
3 AC 400 V SIMOVERT MASTERDRIVES Vector Control converters

Rated speed n_n 1150 rpm

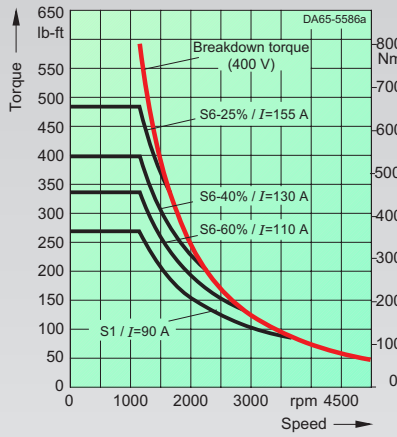

1PH7184-2.D.-.....
max. breakdown torque: 593 lb-ft/804 Nm

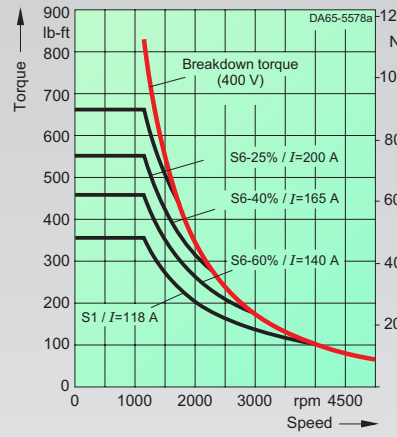

1PH7186-2.D.-.....
max. breakdown torque: 829 lb-ft/1124 Nm

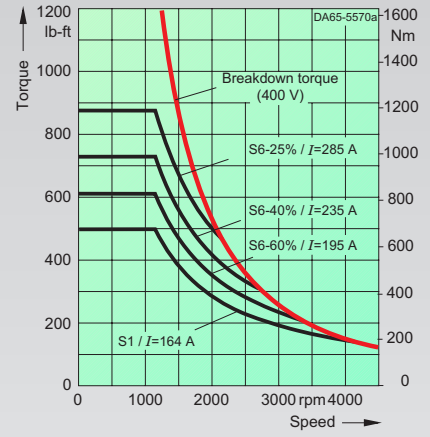

1PH7224-2.D.-.....
max. breakdown torque: 1371 lb-ft/1859 Nm

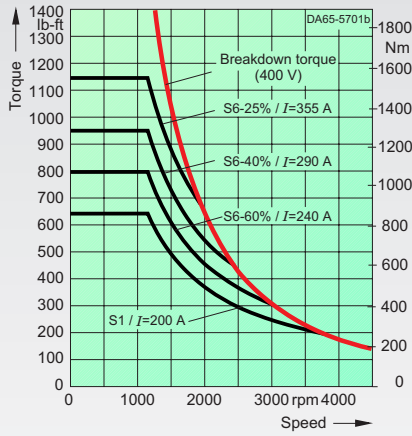

1PH7226-2.D.-.....
max. breakdown torque: 1619 lb-ft/2195 Nm

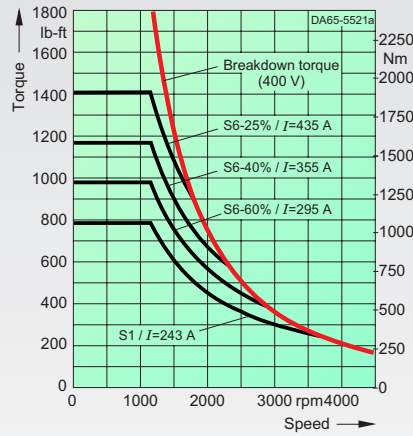

1PH7228-2.D.-.....
max. breakdown torque: 1899 lb-ft/2574 Nm

Rated speed n_n 1750 rpm

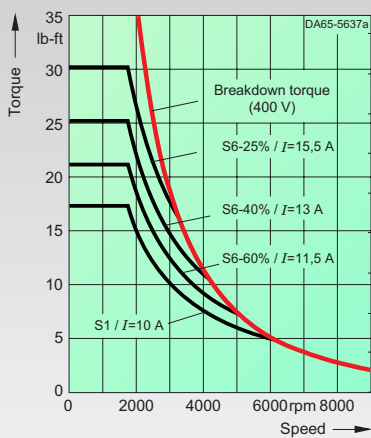

1PH7101-2.F.-.....
max. breakdown torque: 45 lb-ft/61 Nm

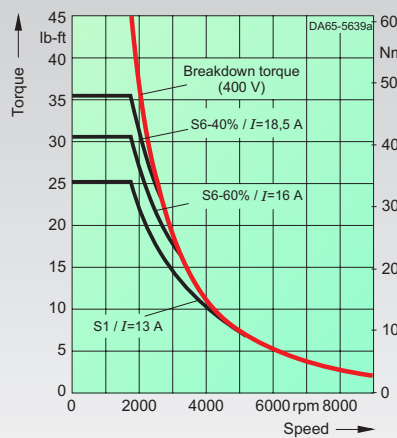

1PH7103-2.F.-.....
max. breakdown torque: 46 lb-ft/63 Nm

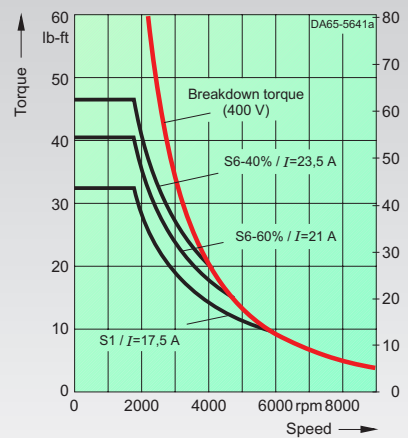

1PH7105-2.F.-.....
max. breakdown torque: 85 lb-ft/115 Nm

7

Servomotors Configuration Aids

1PH7 servomotors

Asynchronous
Servomotors



Speed-Torque curves for 1PH7 · 3 AC 480 V SIMOVERT MASTERDRIVES Motion Control converters and
3 AC 400 V SIMOVERT MASTERDRIVES Vector Control converters

Rated speed n_n 1750 rpm

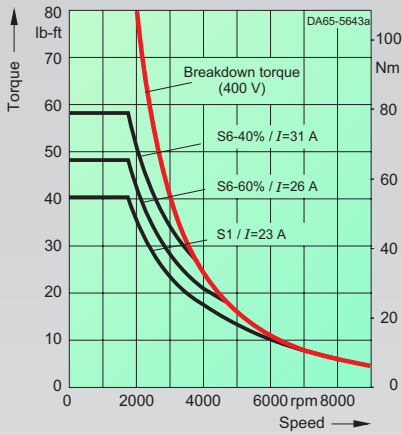

1PH7107-2.F.-.....
max. breakdown torque: 105 lb-ft/142 Nm

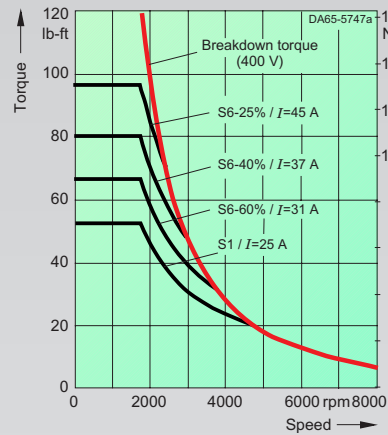

1PH7131-2.F.-.....
max. breakdown torque: 134 lb-ft/182 Nm

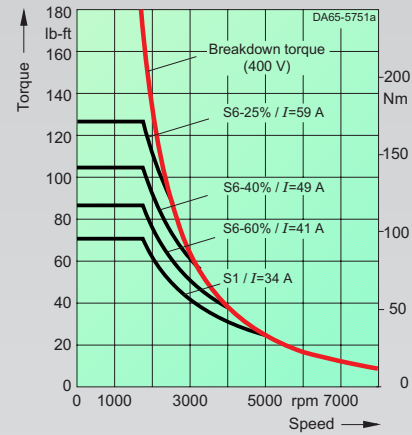

1PH7133-2.F.-.....
max. breakdown torque: 184 lb-ft/250 Nm

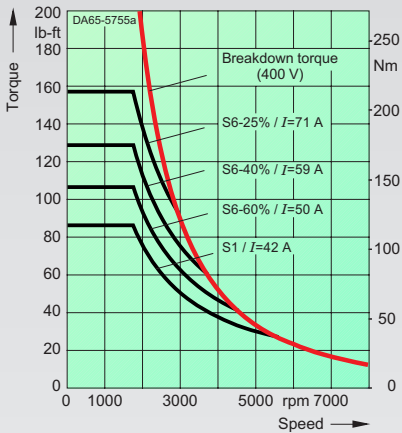

1PH7135-2.F.-.....
max. breakdown torque: 258 lb-ft/350 Nm

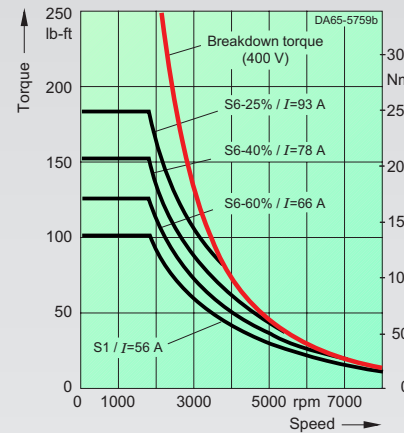

1PH7137-2.F.-.....
max. breakdown torque: 366 lb-ft/496 Nm

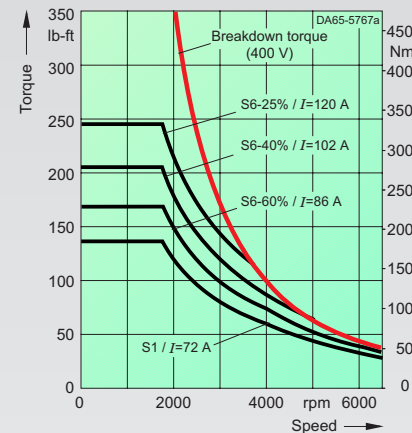

1PH7163-2.F.-.....
max. breakdown torque: 512 lb-ft/694 Nm

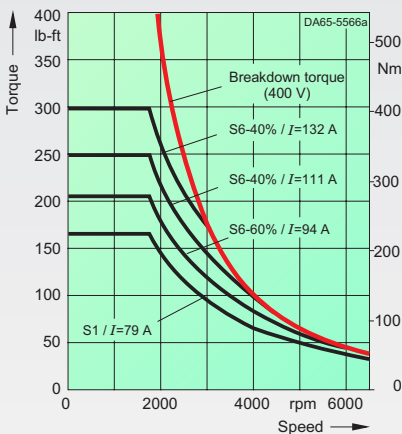

1PH7167-2.F.-.....
max. breakdown torque: 524 lb-ft/710 Nm

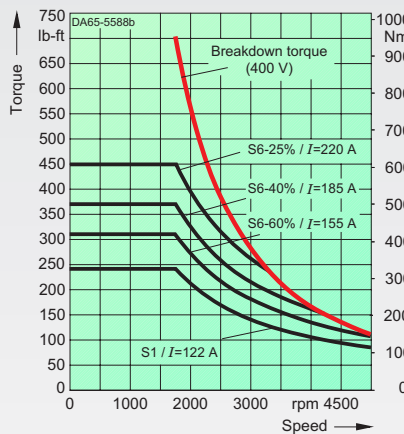

1PH7184-2.F.-.....
max. breakdown torque: 703 lb-ft/953 Nm

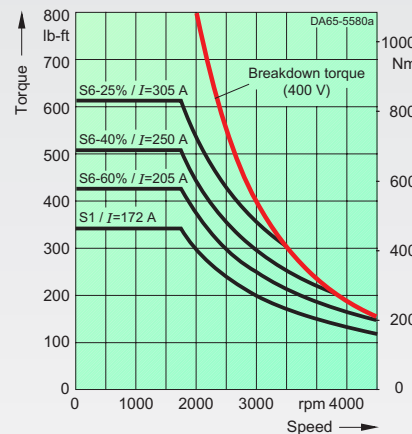

1PH7186-2.F.-.....
max. breakdown torque: 1014 lb-ft/1375 Nm

7

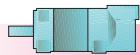

Asynchronous
Servomotors

1PH7 servomotors

**Speed-Torque curves for 1PH7 · 3 AC 480 V SIMOVERT MASTERDRIVES Motion Control converters and
3 AC 400 V SIMOVERT MASTERDRIVES Vector Control converters**

Rated speed n_n 1750 rpm

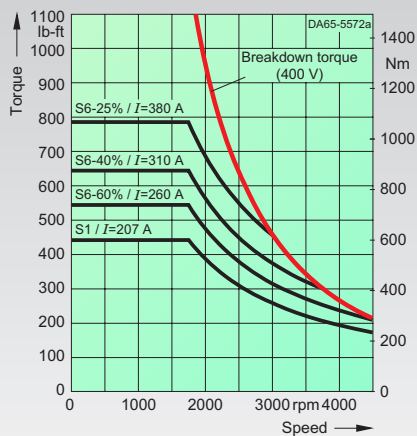

1PH7224-2.U...-....
max. breakdown torque: 1220 lb-ft/1654 Nm

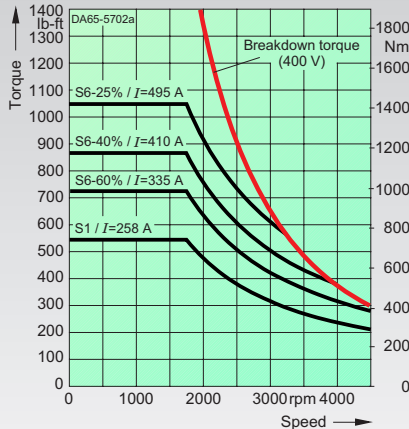

1PH7226-2.F...-....
max. breakdown torque: 1717 lb-ft/2328 Nm

Rated speed n_n 2300 rpm

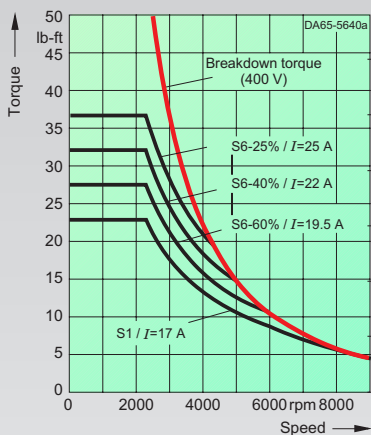

1PH7103-2.G...-....
max. breakdown torque: 58 lb-ft/79 Nm

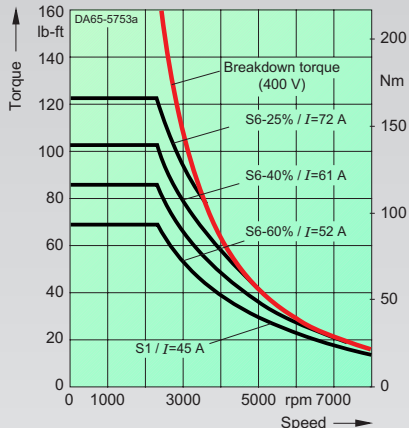

1PH7133-2.G...-....
max. breakdown torque: 193 lb-ft/262 Nm

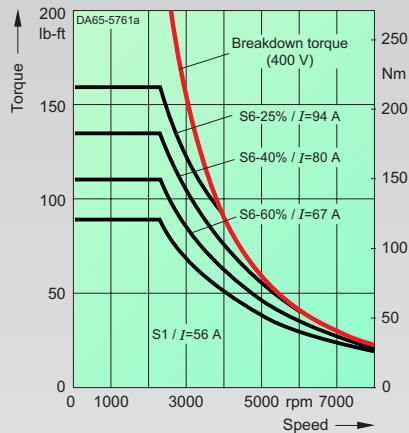

1PH7137-2.G...-....
max. breakdown torque: 276 lb-ft/375 Nm

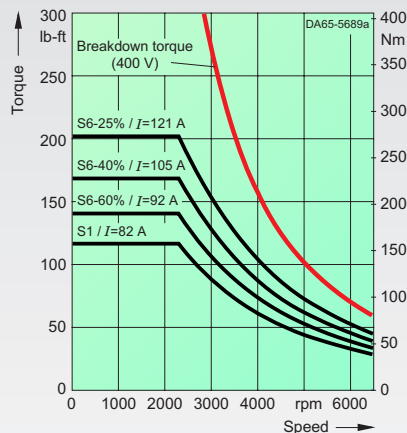

1PH7163-2.G...-....
max. breakdown torque: 496 lb-ft/672 Nm

Servomotors Configuration Aids

1PH7 and 1PL6 servomotors

Asynchronous
Servomotors



Speed-Torque curves for 1PH7 · 3 AC 480 V SIMOVERT MASTERDRIVES Motion Control converters and 3 AC 400 V SIMOVERT MASTERDRIVES Vector Control converters

Rated speed n_n 2900 rpm

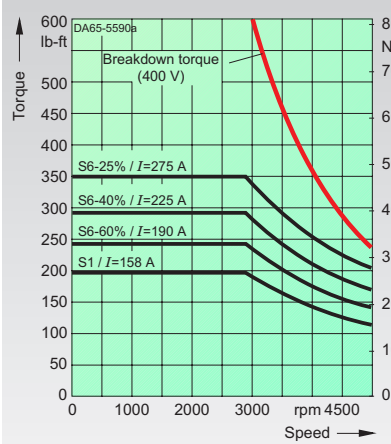

1PH7184-2.L.-.....
max. breakdown torque: 640 lb-ft/868 Nm

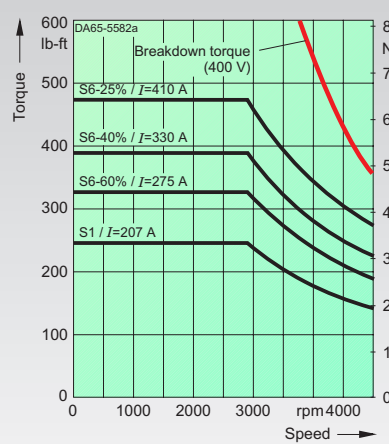

1PH7186-2.L.-.....
max. breakdown torque: 968 lb-ft/1313 Nm

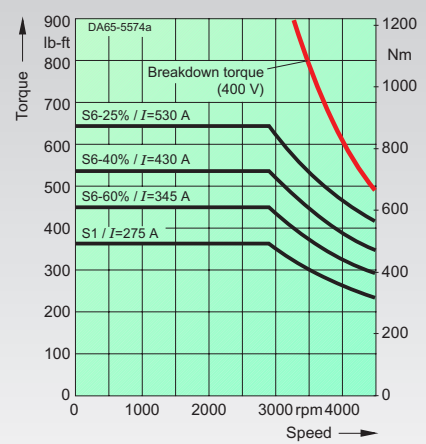

1PH7224-2.L.-.....
max. breakdown torque: 1121 lb-ft/1520 Nm

Speed-Torque curves for 1PL6 · 3 AC 480 V SIMOVERT MASTERDRIVES Motion Control converters and 3 AC 400 V SIMOVERT MASTERDRIVES Vector Control converters

Rated speed n_n 400 rpm

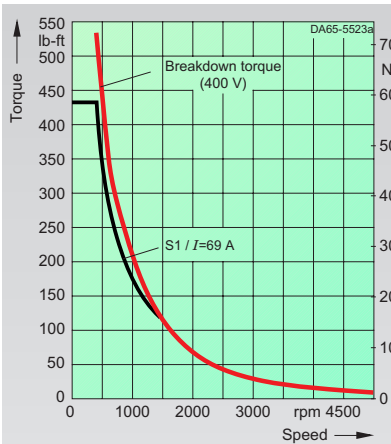

1PL6184-4.B.
max. breakdown torque: 534 lb-ft/724 Nm

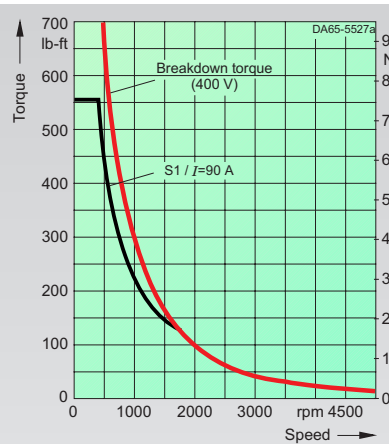

1PL6186-4.B.
max. breakdown torque: 833 lb-ft/1130 Nm

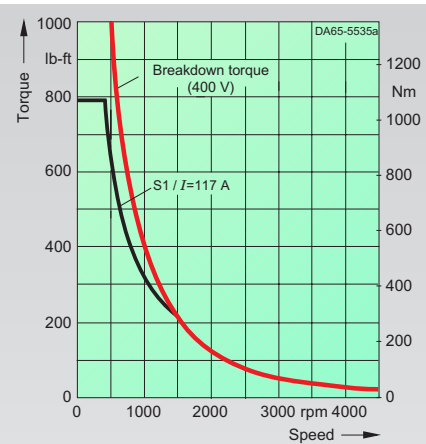

1PL6224-4.B.
max. breakdown torque: 1289 lb-ft/1748 Nm

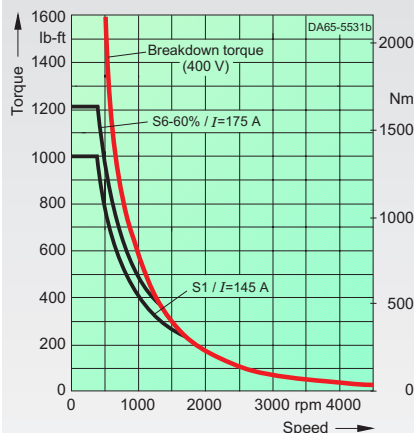

1PL6226-4.B.
max. breakdown torque: 1773 lb-ft/2404 Nm

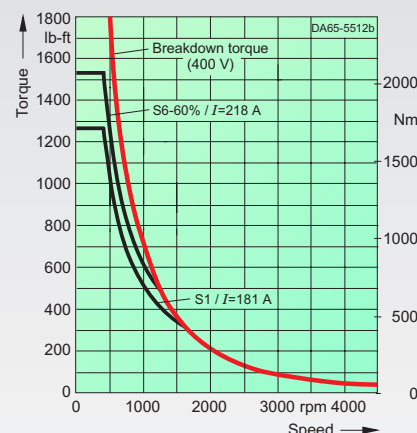

1PL6228-4.B.
max. breakdown torque: 2273 lb-ft/3082 Nm

7



Asynchronous
Servomotors

**Speed-Torque curves for 1PL6 · 3 AC 480 V SIMOVERT MASTERDRIVES Motion Control converters and
3 AC 400 V SIMOVERT MASTERDRIVES Vector Control converters**

Rated speed n_n 1150 rpm

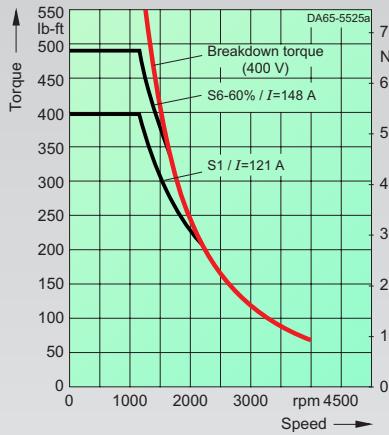

1PL6184-4.D.
max. breakdown torque: 636 lb-ft/862 Nm

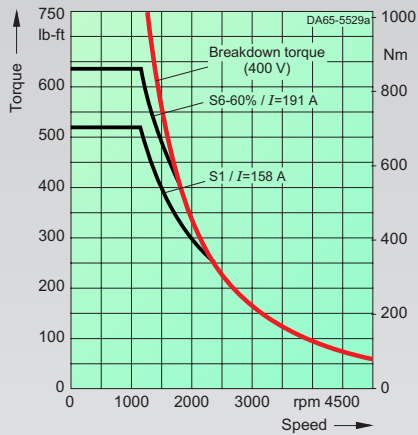

1PL6186-4.D.
max. breakdown torque: 871 lb-ft/1181 Nm

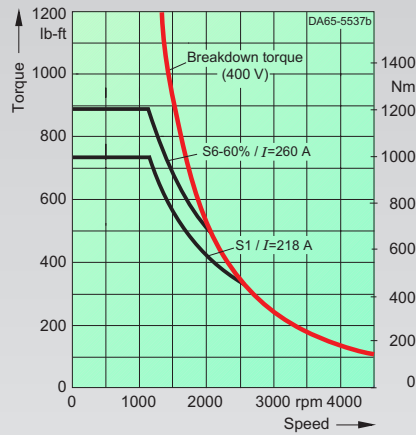

1PL6224-4.D.
max. breakdown torque: 1532 lb-ft/2077 Nm

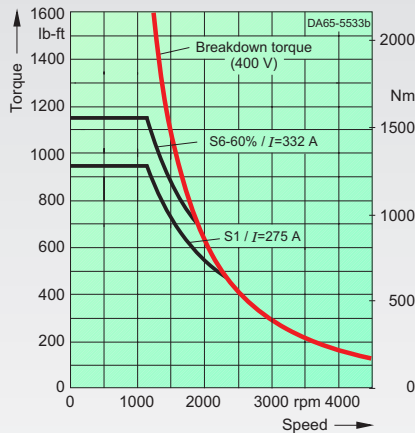

1PL6226-4.D.
max. breakdown torque: 1848 lb-ft/2505 Nm

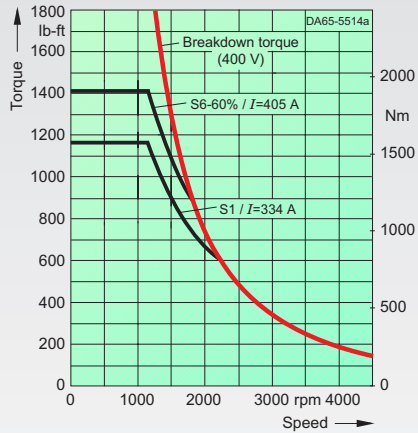

1PL6228-4.D.
max. breakdown torque: 2127 lb-ft/2884 Nm

Rated speed n_n 1750 rpm

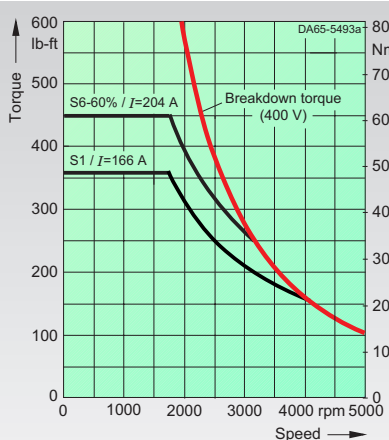

1PL6184-4.F.
max. breakdown torque: 730 lb-ft/989 Nm

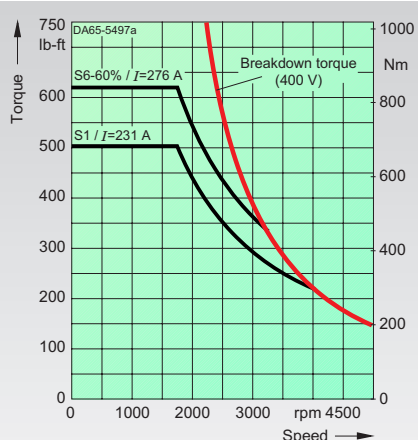

1PL6186-4.F.
max. breakdown torque: 1210 lb-ft/1640 Nm

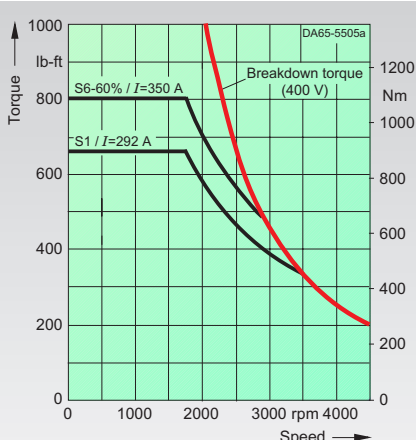

1PL6224-4.F.
max. breakdown torque: 1257 lb-ft/1704 Nm



Servomotors Configuration Aids

1PL6 servomotors

Asynchronous
Servomotors



Speed-Torque curves for 1PL6 · 3 AC 480 V SIMOVERT MASTERDRIVES Motion Control converters and 3 AC 400 V SIMOVERT MASTERDRIVES Vector Control converters

Rated speed n_n 1750 rpm

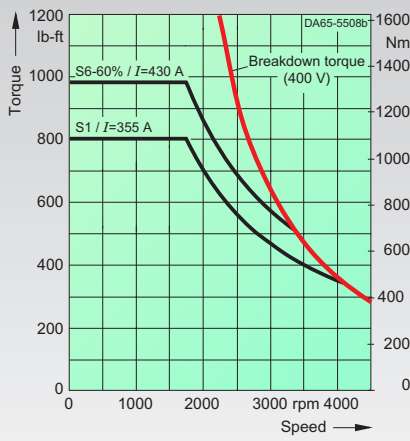

1PL6226-4.F.
max. breakdown torque: 1850 lb-ft/2509 Nm

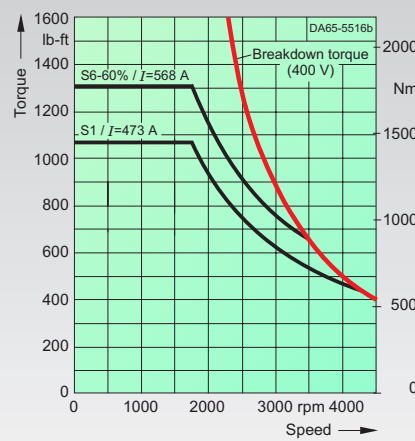

1PL6228-4.F.¹⁾
max. breakdown torque: 2630 lb-ft/3566 Nm

Rated speed n_n 2900 rpm

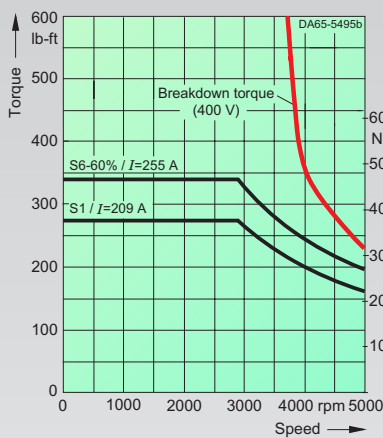

1PL6184-4.L.
max. breakdown torque: 851 lb-ft/1154 Nm

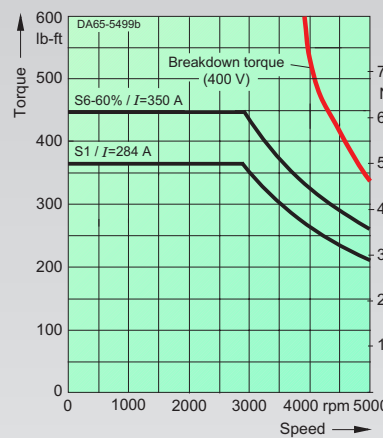

1PL6186-4.L.
max. breakdown torque: 1258 lb-ft/1706 Nm

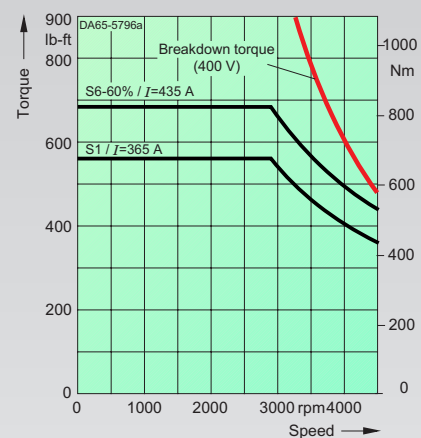

1PL6224-4.L.
max. breakdown torque: 1125 lb-ft/1526 Nm

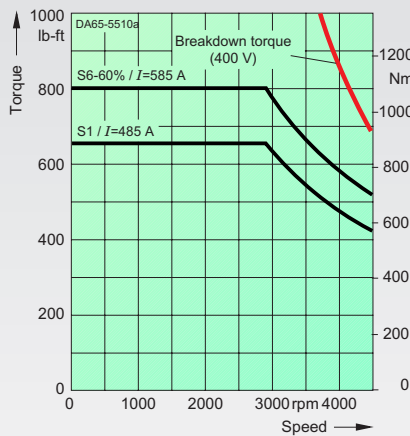

1PL6226-4.L.¹⁾
max. breakdown torque: 1635 lb-ft/2217 Nm

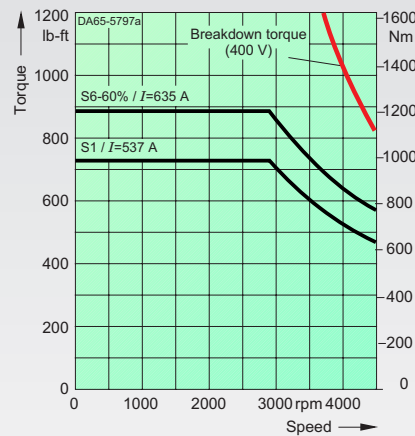

1PL6228-4.L.¹⁾
max. breakdown torque: 1960 lb-ft/2658 Nm

1) Motor exceeds MC power range.

7



Asynchronous
Servomotors

Servomotors Configuration Aids

1PL6 servomotors

Speed-Torque curves for 1PL6 · 3 AC 480 V SIMOVERT MASTERDRIVES Vector Control converters

Rated speed n_n 500 rpm

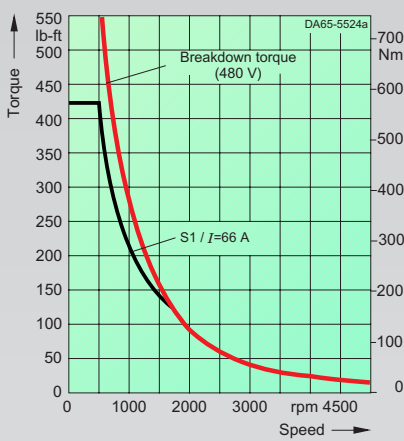

1PL6184-4.B.
max. breakdown torque: 762 lb-ft/1033 Nm

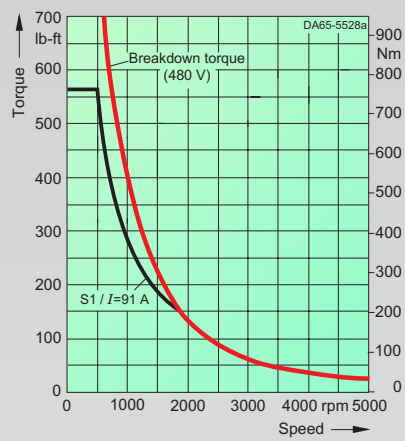

1PL6186-4.B.
max. breakdown torque: 870 lb-ft/1179 Nm

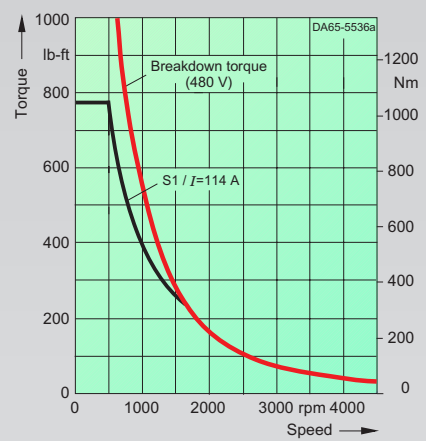

1PL6224-4.B.
max. breakdown torque: 1295 lb-ft/1756 Nm

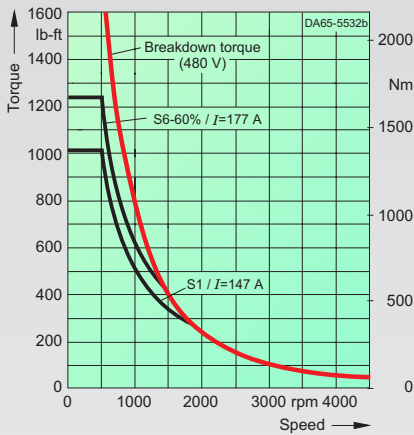

1PL6226-4.B.
max. breakdown torque: 1831 lb-ft/2483 Nm

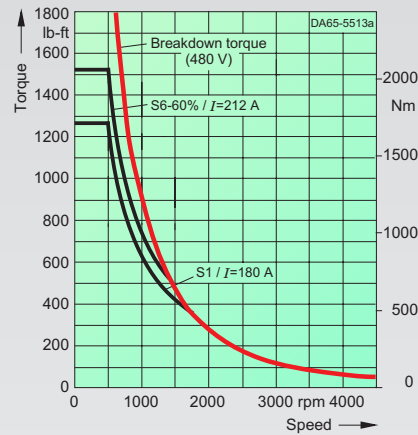

1PL6228-4.B.
max. breakdown torque: 2177 lb-ft/2952 Nm

Servomotors Configuration Aids

1PL6 servomotors

Asynchronous
Servomotors



Speed-Torque curves for 1PL6 · 3 AC 480 V SIMOVERT MASTERDRIVES Vector Control converters

Rated speed n_n 1350 rpm

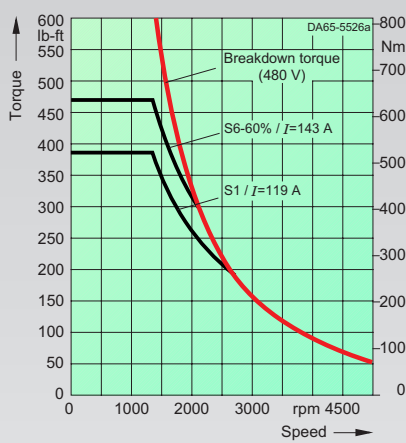

1PL6184-4.D.
max. breakdown torque: 648 lb-ft/879 Nm

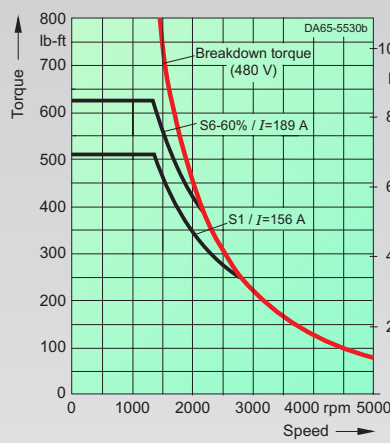

1PL6186-4.D.
max. breakdown torque: 872 lb-ft/1183 Nm

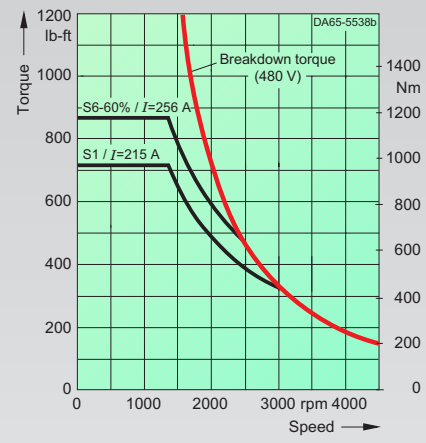

1PL6224-4.D.
max. breakdown torque: 1503 lb-ft/2038 Nm

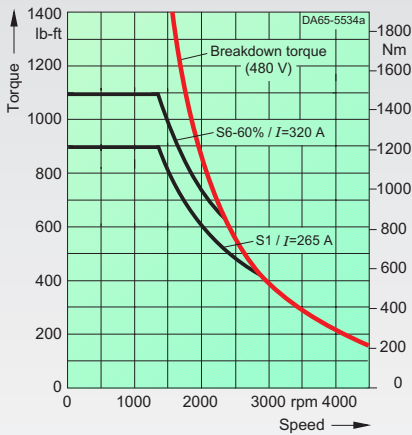

1PL6226-4.D.
max. breakdown torque: 1846 lb-ft/2503 Nm

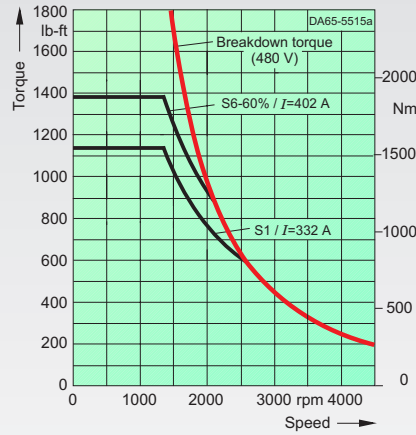

1PL6228-4.D.
max. breakdown torque: 2068 lb-ft/2804 Nm

Rated speed n_n 2000 rpm

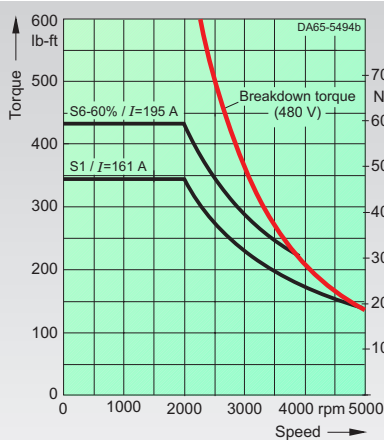

1PL6184-4.F.
max. breakdown torque: 755 lb-ft/1023 Nm

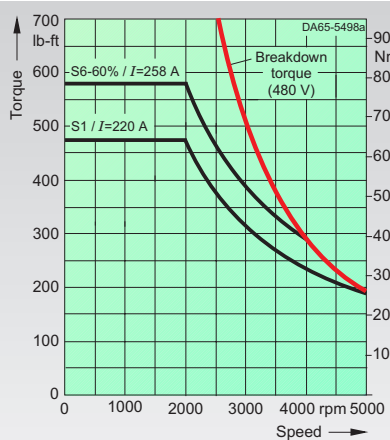

1PL6186-4.F.
max. breakdown torque: 1108 lb-ft/1503 Nm

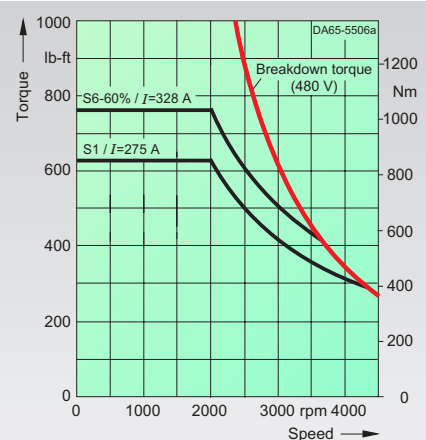

1PL6224-4.F.
max. breakdown torque: 1394 lb-ft/1890 Nm

7



Asynchronous
Servomotors

Speed-Torque curves for 1PL6 · 3 AC 480 V SIMOVERT MASTERDRIVES Vector Control converters

Rated speed n_n 2000 rpm

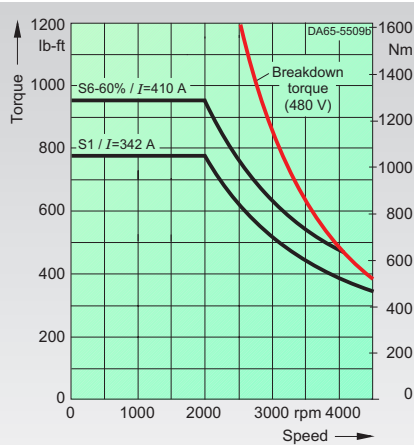

1PL6226-4.F.
max. breakdown torque: 1928 lb-ft/2614 Nm

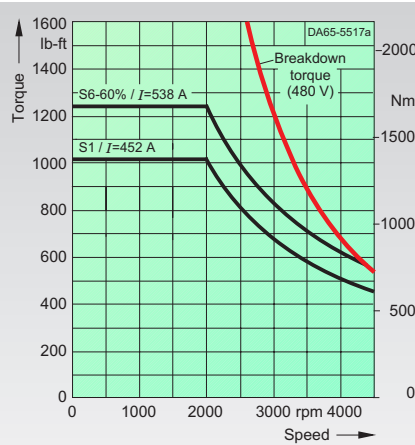

1PL6228-4.F.
max. breakdown torque: 2646 lb-ft/3687 Nm

Rated speed n_n 2900 rpm

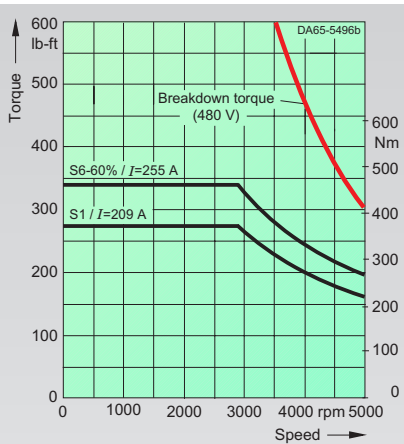

1PL6184-4.L.
max. breakdown torque: 904 lb-ft/1226 Nm

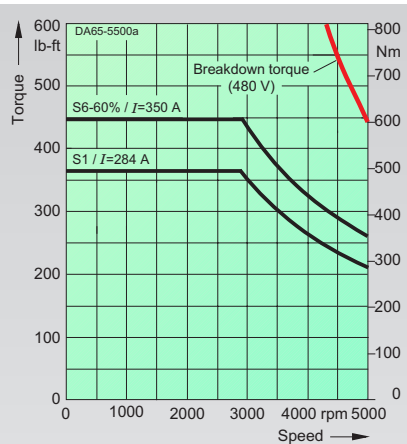

1PL6186-4.L.
max. breakdown torque: 1330 lb-ft/1803 Nm

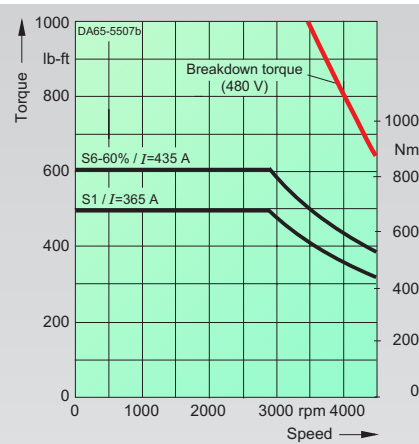

1PL6224-4.L.
max. breakdown torque: 1490 lb-ft/2021 Nm

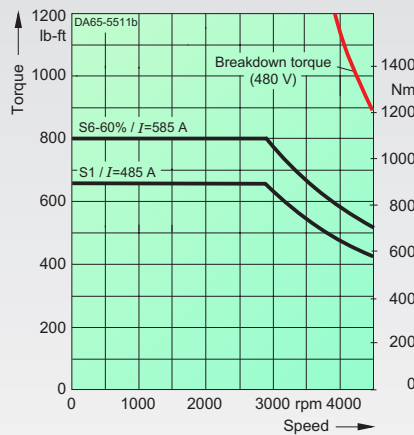

1PL6226-4.L.
max. breakdown torque: 2156 lb-ft/2923 Nm

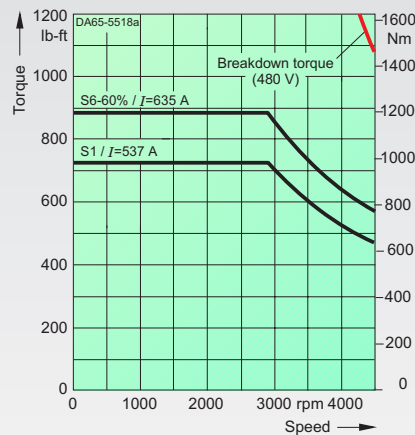

1PL6228-4.L.
max. breakdown torque: 2578 lb-ft/3495 Nm

Servomotors Configuration Aids

Additional data for 1PH7 and 1PL6 motors

Asynchronous
Servomotors



Ventilation data and sound pressure levels

Size	Fan motor: Current and power consumption at						Air-flow-direction Standard	Sound pressure level LpA Motor and separate fan Rated load, 50 Hz Tolerance + 3 dB (A) dB (A)	Air-flow rate at	
	400 V/50 Hz (±10%)		400 V/60 Hz (±10%)		480 V/60 Hz (±5%, -10%)				50 Hz approx. cft/s (m ³ /s)	60 Hz approx. cft/s (m ³ /s)
	A	HP (W)	A	HP (W)	A	HP (W)				
1PH7 motors										
100	0.13	0.05 (37)	0.08	0.04 (35)	0.14	0.07 (51)	ND-end → D-end	70	1.43 (0.04)	1.79 (0.05)
132	0.26	0.11 (85)	0.19	0.13 (100)	0.26	1.67 (125)	ND-end → D-end	70	3.57 (0.1)	4.64 (0.13)
160	0.24	0.18 (135)	0.31	0.27 (200)	0.3	0.31 (230)	ND-end → D-end	72	5.36 (0.15)	6.78 (0.19)
180	1.4	1.14 (850)	–	–	1.4	1.31 (980)	D-end → ND-end	75 (70) ³⁾	6.78 (0.19)	7.86 (0.22)
225	1.8	1.34 (1000)	–	–	2.4	1.74 (1300)	D-end → ND-end ND-end → D-end	76 (72) ³⁾	11.79 (0.33)	13.9 (0.39)
280	6.4	4.02 (3000)	–	–	on request		ND-end → D-end D-end → ND-end	74	16.08 (0.45)	on request
1PL6 motors										
180	1.7	1.21 (900)	–	–	2.1	1.88 (1400)	D-end → ND-end	75 ¹⁾	9.64 (0.27)	11.43 (0.32)
225	2.1	1.61 (1200)	–	–	2.3	2.82 (2100)	D-end → ND-end	76 ¹⁾	13.21 (0.37)	13.6 (0.38)
280	data on request									

Bearing design / type of drive and maximum speeds

Size/ Motor type	Bearing design/ Type of drive	Type of bearings		Max. continuous speed in S1 operation		Max. limiting speed ⁴⁾		Max. permissible lateral force ²⁾ F _{Qmax} lbf (N)
		Motor end	Bearing designation	n _{s1} rpm	n _{s1} ⁵⁾ rpm	n _{max} rpm	n _{max} ⁵⁾ rpm	
100	Deep-groove ball bearings for coupling or belt output	D-end ND-end	6308 C4 6208 C4	5500	10000	9000	12000	630 (2800)
132	Deep-groove ball bearings for coupling or belt output	D-end ND-end	6310 C4 6210 C4	4500	8500	8000	10000	900 (4000)
160	Deep-groove ball bearings for coupling or belt output	D-end ND-end	6312 C4 6212 C4	3700	7000	6500	8000	1888 (8400)
180	Deep-groove ball bearings for coupling output	D-end ND-end	6214 C3 6214 C3	3500	4500	5000	7000	1102 (4900)
180	Cylindrical roller bearings for belt output	D-end ND-end	NU2 14E + 6214 C3 6214 C3	3500	–	5000	–	2878 (12800)
180	Cylindrical roller bearings for increased lateral forces	D-end ND-end	NU22 14E + 6214 C3 6214 C3	3000	–	5000	–	3709 (16500)
225	Deep-groove ball bearings for coupling output	D-end ND-end	6216 C3 6216 C3	3100	3600 (for 1PH7224)	4500	5500 (for 1PH7224)	1169 (5200)
225	Cylindrical roller bearings for belt output	D-end ND-end	NU2 16E + 6216 C3 6216 C3	3100	–	4500	–	3372 (15000)
Types 224, 226	Cylindrical roller bearings for increased lateral forces	D-end ND-end	NU22 16E + 6216 C3 6216 C3	2700	–	4500	–	4496 (20000)
Type 228	Cylindrical roller bearings for increased lateral forces	D-end ND-end	NU22 16E + 6216 C3 6216 C3	2500	–	4000	–	4496 (20000)
280	Deep-groove ball bearings for coupling output	D-end ND-end	6220 C3 6220 C3	–	–	3300	–	approx. 8700
280	Cylindrical roller bearings for belt output	D-end ND-end	NU22 OE 6220 C3	–	–	3300	–	approx. 26700

1) At speeds of 3000 to 5000 rpm, LpA rises to a max. of 85 dB (A).

2) Max. permissible lateral force when X = 50 shaft-extension length and n = 1000 rpm. For further values, see lateral-force diagrams.

3) Values are valid for a version with silencer (can also be mounted at a later time).

4) In disengage mode (with 30% n_{max}, 60% 2/3 n_{max}, 10% standstill) for a duration of 10 min.

5) For version for increased maximum speed, see order option in chapter 3 (only for 1PH7).



Lateral-force diagrams

Permissible lateral forces for 1PH7 motors, size 100

Bearings D-end: 6308 C4
ND-end: 6208 C4

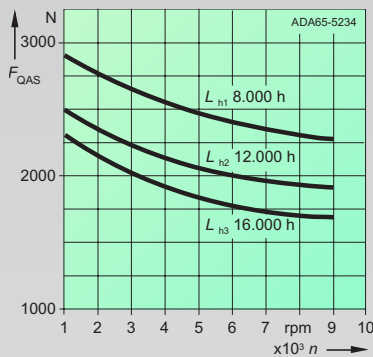
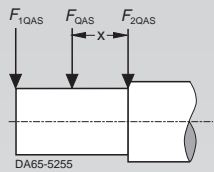

$x = 1.575$ in (40 mm)
 $F_{1QAS} = 0.9 F_{QAS}$
 $F_{2QAS} = 1.1 F_{QAS}$

L_{h1}, L_{h2}, L_{h3} = Estimate of useful life under changing operating conditions ($F_{QAS}; n$)

q = Operating duration [%] under constant conditions

$$L_{hges} = \frac{100}{\frac{q_1}{L_{h1}} + \frac{q_2}{L_{h2}} + \frac{q_3}{L_{h3}}}$$

Permissible lateral forces for 1PH77 motors, size 132

Bearings D-end: 6310 C4
ND-end: 6210 C4

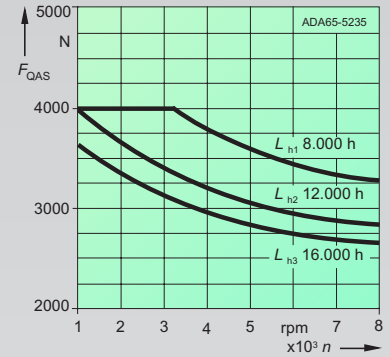
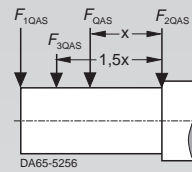

$x = 2.17$ in (55 mm)
 $F_{1QAS} = \max. 450 \text{ lb}_f$ (max. 2000 N)
 $F_{2QAS} = 1.1 F_{QAS}$
 $F_{3QAS} = \max. 560 \text{ lb}_f$ (max. 2500 N)

L_{h1}, L_{h2}, L_{h3} = Estimate of useful life under changing operating conditions ($F_{QAS}; n$)

q = Operating duration [%] under constant conditions

$$L_{hges} = \frac{100}{\frac{q_1}{L_{h1}} + \frac{q_2}{L_{h2}} + \frac{q_3}{L_{h3}}}$$

Permissible lateral forces for 1PH7 motors, size 160

Bearings D-end: 6312 C4
ND-end: 6212 C4

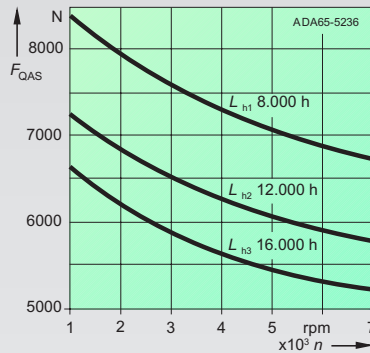
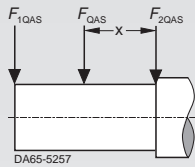

$x = 2.17$ in (55 mm)

$F_{1QAS} = 0.9 F_{QAS}$
 $F_{2QAS} = 1.1 F_{QAS}$

L_{h1}, L_{h2}, L_{h3} = Estimate of useful life under changing operating conditions ($F_{QAS}; n$)

q = Operating duration [%] under constant conditions

$$L_{hges} = \frac{100}{\frac{q_1}{L_{h1}} + \frac{q_2}{L_{h2}} + \frac{q_3}{L_{h3}}}$$

Permissible lateral forces for 1PH718 . and 1PL618 . motors Size 180 for coupling output

Bearings D-end: 6214 C3
ND-end: 6214 C3

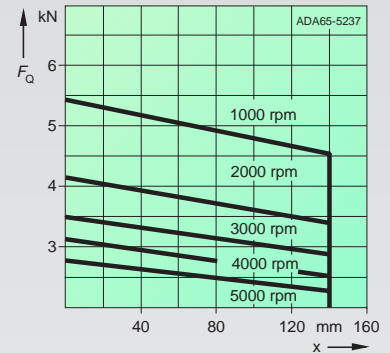
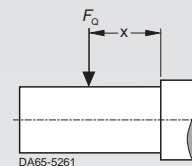

$L_H = 20000$ h

Permissible lateral forces for 1PH722 . and 1PL622 . motors Size 225 for coupling output

Bearings D-end: 6216 C3
ND-end: 6216 C3

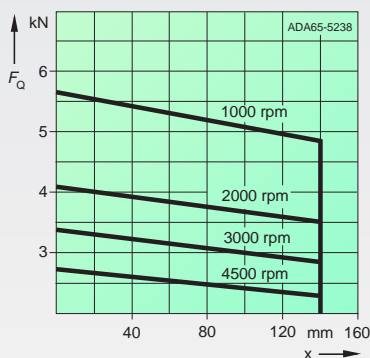
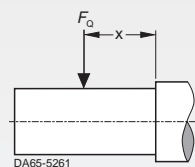

$L_H = 20000$ h

Permissible lateral forces for 1PH728 . and 1PL628 . motors Size 280 for coupling output

Bearings D-end: 6220 C3
ND-end: 6220 C3

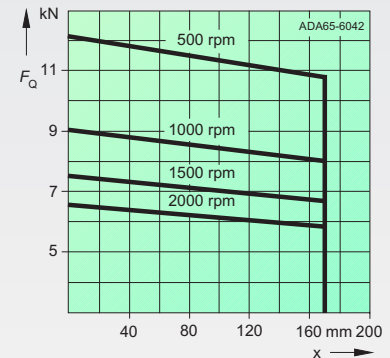
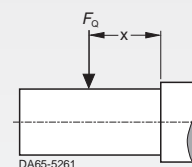

$L_H > 24000$ h with relubrication

Minimum lateral force 2025 lb_f (9 kN)

If the roller bearings used here are operated without load, damage may occur to the bearings. Minimum lateral forces must be complied with!

Servomotors Configuration Aids

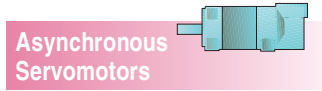

Additional data for 1PH7 and 1PL6 motors

Lateral-force diagrams

Permissible lateral forces for 1PH718. and 1PL6218. motors Size 180 for belt output

Bearings D-end: NU2 14 E + 6214 C3
ND-end: 6214 C3

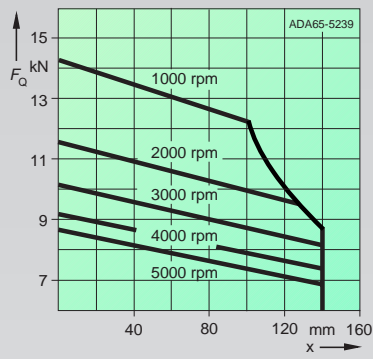
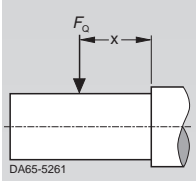

$L_H = 12000$ h

Minimum lateral force 675 lb_f (3 kN)

Permissible lateral forces for 1PH722. and 1PL622. motors Size 225 for belt output

Bearings D-end: NU2 16 E + 6216 C3
ND-end: 6216 C3

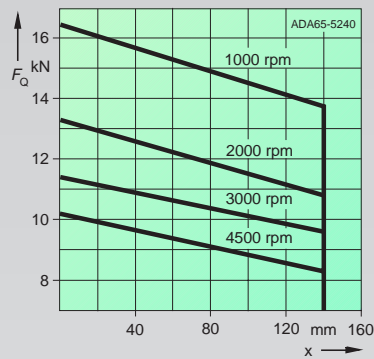
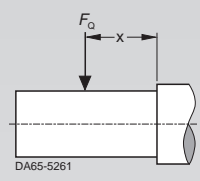

$L_H = 12000$ h

Minimum lateral force 900 lb_f (4 kN)

Permissible lateral forces for 1PH718. and 1PL618. motors Size 180 for belt output with increased lateral force

Bearings D-end: NU22 14 E + 6214 C3
ND-end: 6214 C3

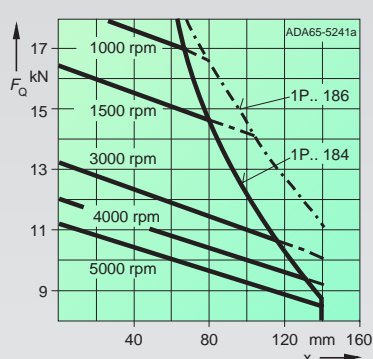
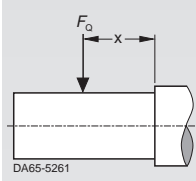

$L_H = 12000$ h

Minimum lateral force 900 lb_f (4 kN)

Permissible lateral forces for 1PH722. and 1PL622. motors Size 225 for belt output with increased lateral force

Bearings D-end: NU22 16 E + 6216 C3
ND-end: 6216 C3

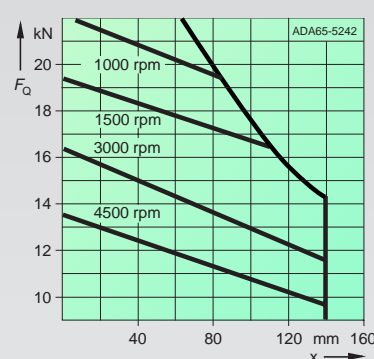
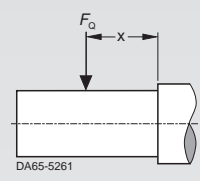

$L_H = 12000$ h

Minimum lateral force 1125 lb_f (5 kN)

Permissible lateral forces for 1PH728. and 1PL628. motors Size 280 for belt output with increased lateral force

Bearings D-end: NU22 0E
ND-end: 6220 C3

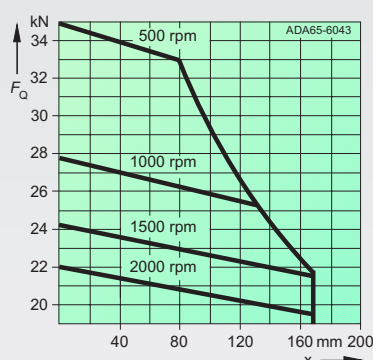
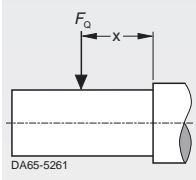

$L_H = 24000$ h with relubrication

Minimum lateral force 1125 lb_f (5 kN)

If the roller bearings used here are operated without load, damage may occur to the bearings. Minimum lateral forces must be complied with!

7



Terminal box assignment, max. cable cross-sections

Frame size	Motor type	Terminal-box type	Cable entry	Max. possible outer cable diameter in (mm)	Number of main terminals	Max. cable cross-section per terminal mm ²	Max. possible current per terminal (red. factor 0.75) A	
1PH7 motors, sizes 100 to 280								
100	1PH710.-2..	integrated	PG 29	1.1 (28)	6 × M 5	25	67	
132	1PH713.-2..	integrated	PG 36	1.34 (34)	6 × M 6	35	83	
160	1PH716.-2..	integrated	PG 42	1.57 (40)	6 × M 6	50	123	
180	1PH7184-2..	1XB7322	2 × PG 42	1.57 (40)	3 × M 12	2 × 50	191	
	1PH7186-2.B	1XB7322	2 × PG 42	1.57 (40)	3 × M 12	2 × 50	191	
	1PH7186-2.D	1XB7322	2 × PG 42	1.57 (40)	3 × M 12	2 × 50	191	
	1PH7186-2.F	1XB7422	2 × M72 × 2	2.2 (56)	3 × M 12	2 × 70	242	
	1PH7186-2.L	1XB7422	2 × M72 × 2	2.2 (56)	3 × M 12	2 × 70	242	
	225	1PH7224-2.B	1XB7322	2 × PG 42	1.57 (40)	3 × M 12	2 × 50	191
		1PH7224-2.D	1XB7322	2 × PG 42	1.57 (40)	3 × M 12	2 × 50	191
1PH7224-2.U		1XB7422	2 × M72 × 2	2.2 (56)	3 × M 12	2 × 70	242	
1PH7224-2.L		1XB7700	3 × M72 × 2	2.2 (56)	3 × 2 × M 12	3 × 150	583	
1PH7226-2.B		1XB7322	2 × PG 42	1.57 (40)	3 × M 12	2 × 50	191	
1PH7226-2.D		1XB7422	2 × M72 × 2	2.2 (56)	3 × M 12	2 × 70	242	
1PH7226-2.F		1XB7700	3 × M72 × 2	2.2 (56)	3 × 2 × M 12	3 × 150	583	
1PH7226-2.L		1XB7700	3 × M72 × 2	2.2 (56)	3 × 2 × M 12	3 × 150	583	
1PH7228-2.B		1XB7322	2 × PG 42	1.57 (40)	3 × M 12	2 × 50	191	
1PH7228-2.D		1XB7700	3 × M72 × 2	2.2 (56)	3 × 2 × M 12	3 × 150	583	
1PH7228-2.F		1XB7700	3 × M72 × 2	2.2 (56)	3 × 2 × M 12	3 × 150	583	
1PH7228-2.L		1XB7700	3 × M72 × 2	2.2 (56)	3 × 2 × M 12	3 × 150	583	
280		1PH728.	1XB7712	on request				
1PL6 motors, sizes 180 to 280								
180	1PL6184-4.B	1XB7322	2 × PG 42	1.57 (40)	3 × M 12	2 × 50	191	
	1PL6184-4.D	1XB7322	2 × PG 42	1.57 (40)	3 × M 12	2 × 50	191	
	1PL6184-4.F	1XB7322	2 × PG 42	1.57 (40)	3 × M 12	2 × 50	191	
	1PL6184-4.L	1XB7422	2 × M72 × 2	2.2 (56)	3 × M 12	2 × 70	242	
	1PL6186-4.B	1XB7322	2 × PG 42	1.57 (40)	3 × M 12	2 × 50	191	
	1PL6186-4.D	1XB7322	2 × PG 42	1.57 (40)	3 × M 12	2 × 50	191	
	1PL6186-4.F	1XB7422	2 × M72 × 2	2.2 (56)	3 × M 12	2 × 70	242	
	1PL6186-4.L	1XB7700	3 × M72 × 2	2.2 (56)	3 × 2 × M 12	3 × 150	583	
	225	1PL6224-4.B	1XB7322	2 × PG 42	1.57 (40)	3 × M 12	2 × 50	191
		1PL6224-4.D	1XB7422	2 × M72 × 2	2.2 (56)	3 × M 12	2 × 70	242
1PL6224-4.F		1XB7700	3 × M72 × 2	2.2 (56)	3 × 2 × M 12	3 × 150	583	
1PL6224-4.L		1XB7700	3 × M72 × 2	2.2 (56)	3 × 2 × M 12	3 × 150	583	
1PL6226-4.B		1XB7322	2 × PG 42	1.57 (40)	3 × M 12	2 × 50	191	
1PL6226-4.D		1XB7700	3 × M72 × 2	2.2 (56)	3 × 2 × M 12	3 × 150	583	
1PL6226-4.F		1XB7700	3 × M72 × 2	2.2 (56)	3 × 2 × M 12	3 × 150	583	
1PL6226-4.L		1XB7700	3 × M72 × 2	2.2 (56)	3 × 2 × M 12	3 × 150	583	
1PL6228-4.B		1XB7322	2 × PG 42	1.57 (40)	3 × M 12	2 × 50	191	
1PL6228-4.D		1XB7700	3 × M72 × 2	2.2 (56)	3 × 2 × M 12	3 × 150	583	
1PL6228-4.F		1XB7700	3 × M72 × 2	2.2 (56)	3 × 2 × M 12	3 × 150	583	
1PL6228-4.L		1XB7700	3 × M72 × 2	2.2 (56)	3 × 2 × M 12	3 × 150	583	
280		1PL628.	1XB7712	on request				

Notes on cable glands

Cable glands and EMC cable glands for shielded cables with PG thread or metric thread and adapter element between PG and metric thread can be obtained from the following companies:

Contact Electronics, Inc.
38 Fairfield Place
West Caldwell, NJ 07006
Tel. +1 800-221-1451
Fax +1 973-575-7208
www.contactelectronics.com

Fa. Pflitsch GmbH & Co. KG
Postfach 100351
D-42492 Hückeswagen
Tel. ++49 21 92-91 10
Fax ++49 21 92-91 12 11

- Cable glands up to PG 42
- Locking screws/filler plugs

AGRO AG
CH-5502 Hunzenschwil
Tel. ++41 (0) 6 28 89 47 47
Fax ++41 (0) 6 28 89 47 50

- EMC cable glands
- Cable glands with heavy-gauge conduit thread
- Metric cable glands
- Adapter elements
- Heavy-gauge conduit thread ↔ metric

Fa. Ernst Heinrich GmbH
Postfach 45 09 48
D-22509 Hamburg
Tel. ++49 40-8 50 10 83
Fax ++49 40-8 50 01 97

- Cable glands M72 × 2
- Locking screws M72 × 2

1) Frame sizes 100 to 160: reduction factor 0.75
Frame sizes 180 and 225: reduction factor 0.60.

Servomotors Configuration Aids

Additional data for 1PH7 and 1PL6 motors

Asynchronous
Servomotors



Overview of types of construction

The types of construction available for 1PH7 motors are IM B 3 (normal design), IM B 5 and IM B 35.

Other types of construction (IM V 15, IM V 36, IM B 6, IM B 7, IM B 8 etc.) are also possible. Depending on how and where the motor is installed, the motor (sizes 180 and 225) should be ordered so that the lifting eyebolts for the intended type of installation are suitably positioned on the motor by the supplying factory (12th data digit of the Order No. for the motor). For motor sizes 100 to 160, the screwed-in lifting eyebolts can be repositioned at a later date for different methods and types of installation.

Note: There are no condensation holes in the machine. An anti-condensation heater is not necessary.

Type of construction	Type of construction	1 2 3 4 5 6 7 8 9 10 11 12	1PH7 <input type="checkbox"/>	1PL6 <input type="checkbox"/>	
 IM B 3	 IM B 6				Foot-mounting type (△ IM B 3)
 IM B 7	 IM B 8				
 IM V 6	 IM V 5				
 IM V 36 ¹⁾	 IM V 15 ¹⁾				Foot-flange mounting type (△ IM B 35)
 IM B 35 ¹⁾					
 IM B 5	 IM V 3				Flange type (△ IM B 5)
	 IM V 1				

1) Foot-mounting and flange-mounting necessary for size 160 and larger.

7

Servomotors

Dimension Drawings

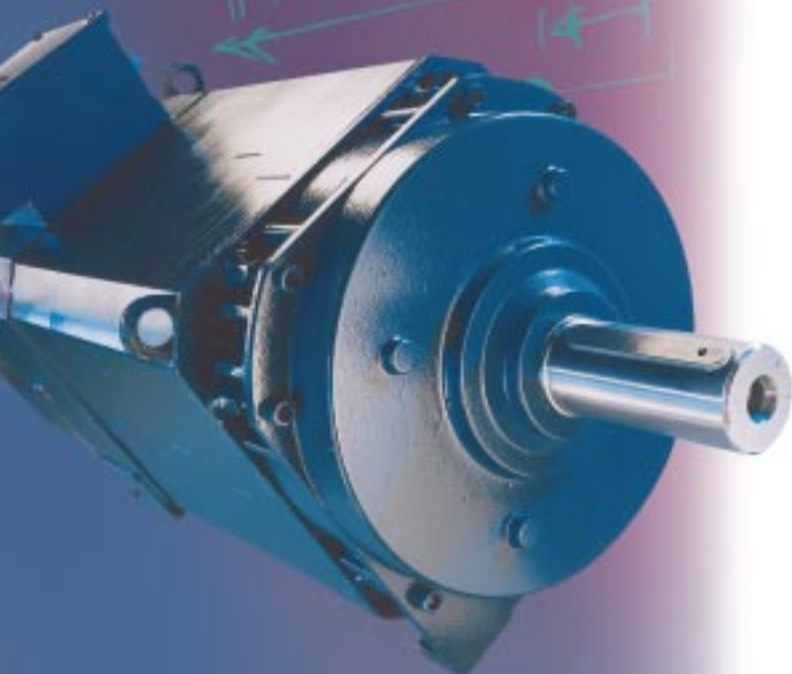

Synchronous servomotors

8/2	1FK6 motors, self-cooled
8/3	1FK7 (CT) motors, self-cooled
8/5	1FK7 (HD) motors, self-cooled
8/6	1FK6 motors, self-cooled, with planetary gear
8/7	1FK7 (CT) motors, self-cooled, with planetary gear
8/8	1FK7 (HD) motors, self-cooled, with planetary gear
8/9	1FT6 motors, self-cooled
8/14	1FT6 motors, blower-ventilated
8/17	1FT6 motors, self-cooled, with planetary gear
8/19	1FT6 motors, water-cooled
8/21	1FS6 motors, self-cooled
8/22	1FN3 AC linear motors

Asynchronous servomotors

8/23	1PH7 motors
8/30	1PH7 motors with brake module
8/33	1PH7 motors with pipe connection
8/36	1PL6 motors
8/39	1PH4 motors, water-cooled
8/40	1PH7 motors with 2-gear unit
8/42	1PH4 motors with 2-gear unit

Notes

Siemens reserves the right to alter technical data without advanced notice. The dimensions in this catalog can become out of date. Current dimension drawings can be supplied free-of-charge on request.

Servomotors Dimension Drawings

1FK6 motors, self-cooled

Synchronous
Servomotors

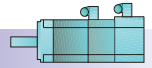

For motor	Dimension in inches (mm)																	Re- solver	sin/cos in- cre- men- tal en- cod- er	D-end of shaft		
Size	Type	DIN IEC	a ₁ P	b ₁ N	c ₁ LA	e ₁ M	f AB	f ₁ T	g ₂ -	h H	i ₂ -	o ₁ -	o ₂ -	p HD	s ₂ S	k LB	k LB	d D	d ₆ -	l E	t GA	u F
Type of construction IM B 5, self-cooled, with angled plug, with/without brake																						
36	1FK6032		3.6 (92)	2.3 (60)	0.31 (8)	2.9 (75)	2.8 (72)	0.11 (3)	3.11 (79)	1.41 (36)	1.18 (30)	3.7 (95.5)	6.1 (154)	3.1 (78)	0.26 (6.5)	7.05 (179)	-	0.55 (14)	M 5	1.18 (30)	0.62 (16)	0.19 (5)
48	1FK6040 1FK6042		4.7 (120)	3.1 (80)	0.39 (10)	3.9 (100)	3.7 (96)	0.11 (3)	3.34 (85)	1.88 (48)	1.57 (40)	3.2 (83)	5.2 (134)	-	0.27 (7)	6.3 (160)	8.01 (203.5)	0.74 (19)	M 6	1.57 (40)	0.84 (21.5)	0.23 (6)
63	1FK6060 1FK6063		6.1 (155)	4.3 (110)	0.39 (10)	5.1 (130)	4.9 (126)	0.13 (3.5)	3.93 (100)	2.48 (63)	1.96 (50)	4.1 (104)	6.6 (170)	-	0.35 (9)	7.9 (200)	9.4 (238)	0.94 (24)	M 8	1.96 (50)	1.06 (27)	0.31 (8)
80	1FK6080 1FK6083		7.3 (186)	5.1 (130)	0.51 (13)	6.4 (165)	6.1 (155)	0.13 (3.5)	4.5 (114.5)	3.05 (77.5)	2.28 (58)	3.8 (97)	6.4 (165)	-	0.43 (11)	7.7 (195)	9.5 (242)	1.25 (32)	M 12	2.28 (58)	1.37 (35)	0.39 (10)
100	1FK6100 1FK6101 1FK6103		9.4 (240)	7 (180)	0.51 (13)	8.4 (215)	7.5 (192)	0.15 (4)	5.19 (132)	3.77 (96)	3.14 (80)	4.4 (113)	7.4 (188)	6.1 (155)	0.5 (14)	8.6 (218)	10.4 (265)	1.49 (38)	M 12	3.14 (80)	1.61 (41)	0.39 (10)

1FK6032

Shaft
with featherkey

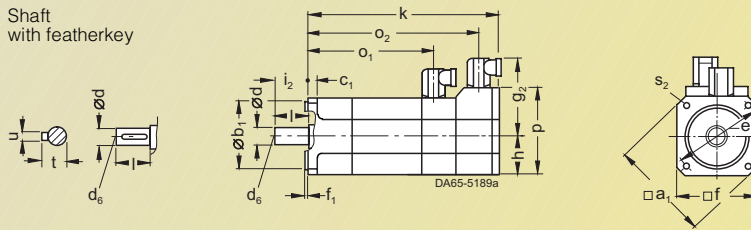

1FK604 . 1FK606 . 1FK608 .

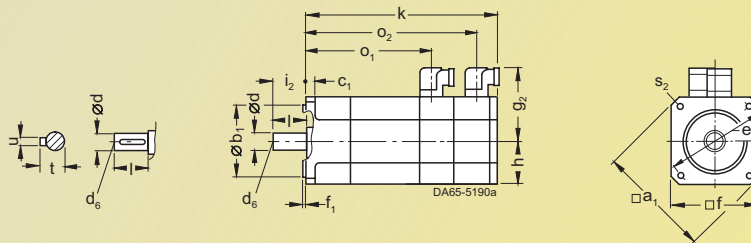

1FK6100

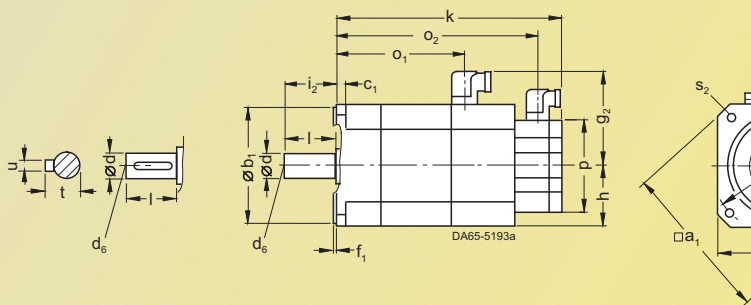

1FK6101 1FK6103

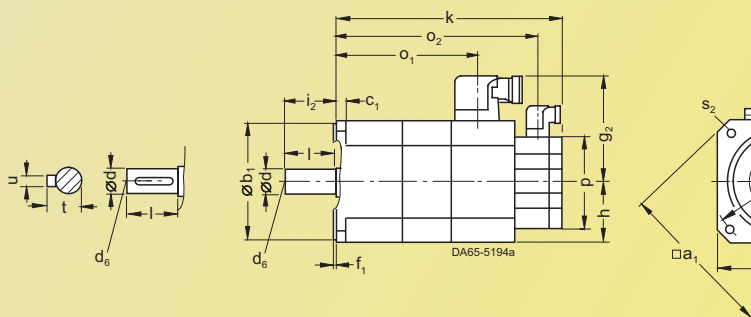

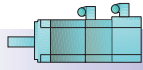

Synchronous Servomotors

Servomotors Dimension Drawings

1FK7 (CT) motors, self-cooled

For motor		Dimension in inches (mm)											Resolver					
Size	Type	DIN IEC	a ₁ P	b ₁ N	c ₁ LA	e ₁ M	f AB	f ₁ T	g ₂ -	h H	i ₂ -	s ₂ S	without brake			with brake		
													k LB	o ₁ -	o ₂ -	k LB	o ₁ -	o ₂ -
1FK7 CT (compact), type of construction IM B 5, self-cooled, with angled plug, with/without brake																		
28	1FK7022-5	-	-	1.57 (40)	0.28 (7)	2.48 (63)	2.17 (55)	0.1 (2.5)	2.74 (69.5)	1.08 (27.5)	0.79 (20)	0.23 (5.8)	5.91 (150)	2.97 (75.5)	4.92 (125)	7.01 (178)	4.11 (104.5)	6.06 (154)
36	1FK7032-5	3.66 (93)	2.36 (60)	0.31 (8)	2.95 (75)	2.83 (72)	0.12 (3)	3.07 (78)	1.42 (36)	1.18 (30)	0.26 (6.5)	5.91 (150)	2.97 (75.5)	4.92 (125)	7.01 (178)	4.11 (104.5)	6.06 (154)	
48	1FK7040-5	4.72 (120)	3.15 (80)	0.39 (10)	3.94 (100)	3.78 (96)	0.12 (3)	3.54 (90)	1.89 (48)	1.57 (40)	0.28 (7)	5.31 (135)	2.91 (74)	4.21 (107)	6.46 (164)	2.91 (74)	5.35 (136)	
	1FK7042-5	4.72 (120)	3.15 (80)	0.39 (10)	3.94 (100)	3.78 (96)	0.12 (3)	3.54 (90)	1.89 (48)	1.57 (40)	0.28 (7)	6.38 (162)	3.98 (101)	5.28 (134)	7.52 (191)	3.98 (101)	6.42 (163)	
63	1FK7060-5	6.1 (155)	4.33 (110)	0.39 (10)	5.12 (130)	4.96 (126)	0.14 (3.5)	4.13 (105)	2.48 (63)	1.97 (50)	0.35 (9)	6.18 (157)	3.66 (93)	4.92 (125)	7.87 (200)	3.66 (93)	6.61 (168)	
	1FK7063-5	6.1 (155)	4.33 (110)	0.39 (10)	5.12 (130)	4.96 (126)	0.14 (3.5)	4.13 (105)	2.48 (63)	1.97 (50)	0.35 (9)	7.95 (202)	5.43 (138)	6.69 (170)	9.65 (245)	5.43 (138)	8.39 (213)	

Size	Type	Basic absolute-value encoder (EnDat), from size 48 on sin/cos incremental encoder 1 V _{pp}						Absolute-value encoder (EnDat)						d D	d ₆ -	l E	t GA	u F
		without brake			with brake			without brake			with brake							
		k LB	o ₁ -	o ₂ -	k LB	o ₁ -	o ₂ -	k LB	o ₁ -	o ₂ -	k LB	o ₁ -	o ₂ -					
28	1FK7022-5	7.17 (182)	3.35 (85)	5.3 (134.5)	8.27 (210)	4.45 (113)	6.4 (162.5)	7.17 (182)	3.35 (85)	5.3 (134.5)	8.27 (210)	4.45 (113)	6.4 (162.5)	0.35 (9)	M 3	0.79 (20)	0.4 (10.2)	0.12 (3)
36	1FK7032-5	7.17 (182)	3.35 (85)	5.3 (134.5)	8.31 (211)	4.49 (114)	6.44 (163.5)	7.17 (182)	3.35 (85)	5.3 (134.5)	8.31 (211)	4.49 (114)	6.44 (163.5)	0.55 (14)	M 5	1.18 (30)	0.63 (16)	0.2 (5)
48	1FK7040-5	6.1 (155)	2.52 (64)	4.17 (106)	7.24 (184)	2.87 (73)	5.31 (135)	6.46 (164)	2.56 (65)	4.21 (107)	7.6 (193)	2.91 (74)	5.35 (136)	0.75 (19)	M 6	1.57 (40)	0.85 (21.5)	0.24 (6)
	1FK7042-5	7.2 (183)	3.62 (92)	5.28 (134)	8.35 (212)	3.98 (101)	6.42 (163)	7.52 (191)	3.62 (92)	5.28 (134)	8.66 (220)	4.02 (102)	6.46 (164)	0.75 (19)	M 6	1.57 (40)	0.85 (21.5)	0.24 (6)
63	1FK7060-5	7.09 (180)	3.66 (93)	4.92 (125)	8.78 (223)	3.66 (93)	6.61 (168)	7.4 (188)	3.66 (93)	4.92 (125)	9.09 (231)	3.64 (92.5)	6.59 (167.5)	0.94 (24)	M 8	1.97 (50)	1.06 (27)	0.31 (8)
	1FK7063-5	8.86 (225)	5.43 (138)	5.51 (140)	10.55 (268)	5.43 (138)	8.39 (213)	9.17 (233)	5.43 (138)	6.69 (170)	10.87 (276)	5.41 (137.5)	8.37 (212.5)	0.94 (24)	M 8	1.97 (50)	1.06 (27)	0.31 (8)

1FK702.-5
1FK703.-5
1FK704.-5
1FK706.-5

Shaft with featherkey

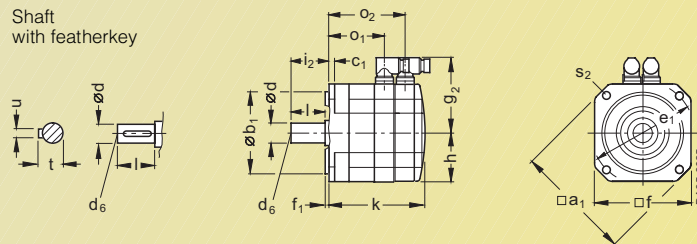

Servomotors

Dimension Drawings

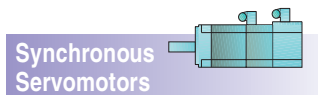

1FK7 (CT) motors, self-cooled

For motor		Dimension in inches (mm)											Resolver					
Size	Type	DIN	a ₁	b ₁	c ₁	e ₁	f	f ₁	g ₂	h	i ₂	s ₂	without brake			with brake		
		IEC	P	N	LA	M	AB	T	-	H	-	S	k	o ₁	o ₂	k	o ₁	o ₂
1FK7 CT (compact), type of construction IM B 5, self-cooled, with angled plug, with/without brake																		
80	1FK7080-5		7.32 (186)	5.12 (130)	0.51 (13)	6.5 (165)	6.1 (155)	0.14 (3.5)	4.7 (119.5)	3.05 (77.5)	2.28 (58)	0.43 (11)	6.14 (156)	3.58 (91)	4.88 (124)	7.24 (184)	3.58 (91)	5.98 (152)
	1FK7083-5		7.32 (186)	5.12 (130)	0.51 (13)	6.5 (165)	6.1 (155)	0.14 (3.5)	4.7 (119.5)	3.05 (77.5)	2.28 (58)	0.43 (11)	7.64 (194)	5.08 (129)	6.38 (162)	9.65 (245)	5.98 (152)	8.39 (213)
100	1FK7100-5		9.45 (240)	7.09 (180)	0.51 (13)	8.46 (215)	7.56 (192)	0.16 (4)	5.43 (138)	3.78 (96)	3.15 (80)	0.55 (14)	7.28 (185)	4.45 (113)	6.02 (153)	8.03 (204)	4.45 (113)	6.77 (172)
	1FK7101-5		9.45 (240)	7.09 (180)	0.51 (13)	8.46 (215)	7.56 (192)	0.16 (4)	6.3 (160)	3.78 (96)	3.15 (80)	0.55 (14)	8.31 (211)	5.47 (139)	7.05 (179)	9.45 (240)	5.47 (139)	8.19 (208)
	1FK7103-5		9.45 (240)	7.09 (180)	0.51 (13)	8.46 (215)	7.56 (192)	0.16 (4)	6.3 (160)	3.78 (96)	3.15 (80)	0.55 (14)	9.33 (237)	6.5 (165)	8.07 (205)	10.47 (266)	6.5 (165)	9.21 (234)

Size	Type	Basic absolute-value encoder (EnDat), from size 48 on sin/cos incremental encoder 1 V _{pp}						Absolute-value encoder (EnDat)						d D	d ₆	l E	t GA	u F
		without brake			with brake			without brake			with brake							
		k LB	o ₁	o ₂	k LB	o ₁	o ₂	k LB	o ₁	o ₂	k LB	o ₁	o ₂					
80	1FK7080-5	7.05 (179)	3.58 (91)	4.88 (124)	8.11 (206)	3.58 (91)	5.94 (151)	7.36 (187)	3.58 (91)	4.88 (124)	8.46 (215)	3.54 (90)	5.94 (151)	1.26 (32)	M 12	2.28 (58)	1.38 (35)	0.39 (10)
	1FK7083-5	8.54 (217)	5.08 (129)	6.38 (162)	10.55 (268)	6.02 (153)	8.39 (213)	8.86 (225)	5.08 (129)	6.38 (162)	10.87 (276)	5.96 (151.5)	8.37 (212.5)	1.26 (32)	M 12	2.28 (58)	1.38 (35)	0.39 (10)
100	1FK7100-5	8.19 (208)	4.45 (113)	6.02 (153)	8.94 (227)	4.45 (113)	6.77 (172)	8.5 (216)	4.45 (113)	6.02 (153)	9.25 (235)	4.43 (112.5)	6.75 (171.5)	1.5 (38)	M 12	3.15 (80)	1.61 (41)	0.39 (10)
	1FK7101-5	9.21 (234)	5.47 (139)	7.05 (179)	10.35 (263)	5.47 (139)	8.19 (208)	9.53 (242)	5.47 (139)	7.05 (179)	10.67 (271)	5.06 (128.5)	7.78 (197.5)	1.5 (38)	M 12	3.15 (80)	1.61 (41)	0.39 (10)
	1FK7103-5	10.24 (260)	6.5 (165)	8.07 (205)	11.38 (289)	6.5 (165)	9.21 (234)	10.55 (268)	6.5 (165)	8.07 (205)	11.69 (297)	6.08 (154.5)	8.8 (223.5)	1.5 (38)	M 12	3.15 (80)	1.61 (41)	0.39 (10)

1FK708 . -5

Shaft with featherkey

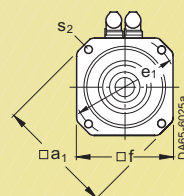
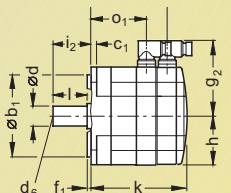
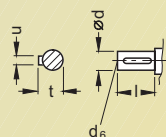

1FK7100-5 1FK7101-5 1FK7103-5

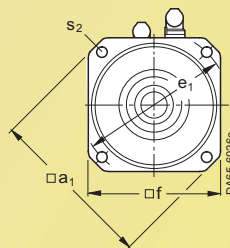
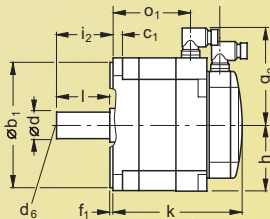
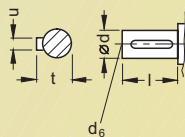

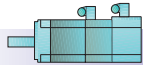

Synchronous Servomotors

Servomotors Dimension Drawings

1FK7 (HD) motors, self-cooled

For motor		Dimension in inches (mm)													Resolver	
Size	Type	DIN IEC	without/with brake													k LB
			a ₁ P	b ₁ N	c ₁ LA	e ₁ M	f AB	f ₁ T	g ₂ -	h H	i ₂ -	o ₁ -	o ₂ -	s ₂ S		
1FK7 HD (High Dynamic), type of construction IM B 5, self-cooled, with angled plug, with/without brake																
36	1FK7033-7		3.62 (92)	2.36 (60)	0.31 (8)	2.95 (75)	2.83 (72)	0.12 (3)	3.07 (78)	1.42 (36)	1.18 (30)	4.51 (114.5)	6.46/6.46 (164/164)	0.26 (6.5)	6.75/7.58 (171.5/192.5)	
48	1FK7043-7		4.72 (120)	3.15 (80)	0.39 (10)	3.94 (100)	3.78 (96)	0.12 (3)	3.54 (90)	1.89 (48)	1.57 (40)	5.31 (135)	6.97/7.87 (177/200)	0.28 (7)	7.54/8.68 (191.5/220.5)	
	1FK7044-7												7.95/8.86 (202/225)	0.35 (9)	8.52/9.67 (216.5/245.5)	
63	1FK7061-7		6.10 (155)	4.33 (110)	0.39 (10)	5.12 (130)	4.96 (126)	0.14 (3.5)	4.13 (105)	2.48 (63)	1.97 (50)	4.84 (123)	6.54/7.24 (166/184)	0.43 (11)	7.34/9 (186.5/228.5)	
	1FK7064-7												9.06/9.76 (230/248)		9.86/11.52 (250.5/292.5)	
80	1FK7082-7		7.32 (186)	5.12 (130)	0.51 (13)	6.5 (165)	6.1 (155)	0.14 (3.5)	4.7 (119.5)	3.05 (77.5)	2.28 (58)	5.61 (142.5)	7.32/8.98 (186/228)	0.43 (11)	8.29/10 (210.5/253)	
	1FK7085-7								5.22 (132.5)			7.58 (192.5)	9.29/10.94 (236/278)		10.26/11.93 (260.5/303)	

Size	Type	DIN IEC	sin/cos incremental encoder 1 V _{pp} without/with brake		Absolute-value encoder (EnDat)		D-end of shaft		
			k LB	k LB	d D	d ₆ -	l E	t GA	u F
36	1FK7033-7		7.74/8.54 (196.5/217)	-/-	0.55 (14)	M 5	1.18 (30)	0.63 (16)	0.2 (5)
48	1FK7043-7		8.35/9.49 (212/241)	8.68/9.82 (220.5/249.5)	0.75 (19)	M 6	1.57 (40)	0.85 (21.5)	0.24 (6)
	1FK7044-7		9.33/10.47 (237/266)	9.67/10.81 (245.5/274.5)					
63	1FK7061-7		8.25/9.9 (209.5/251.5)	8.58/10.24 (218/260)	0.94 (24)	M 8	1.97 (50)	1.06 (27)	0.8 (8)
	1FK7064-7		10.77/12.42 (273.5/315.5)	11.1/12.76 (282/324)					
80	1FK7082-7		9.19/10.87 (233.5/276)	9.53/11.2 (242/284.5)	1.26 (32)	M 12	2.28 (58)	1.38 (35)	0.39 (10)
	1FK7085-7		11.16/12.83 (283.5/326)	11.5/13.17 (292/334.5)					

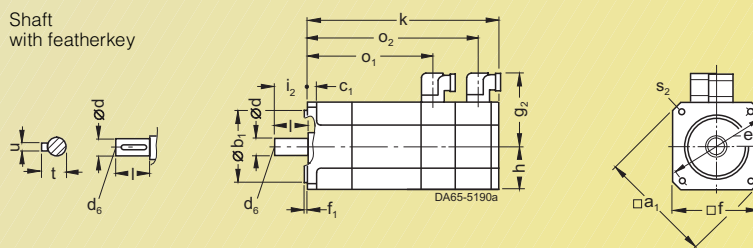

Servomotors Dimension Drawings

1FK6 motors
self-cooled, with planetary gear

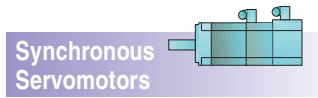

For motor	Dimension in inches (mm)		Planetary gear single-stage																	Re-solver	sin/cos incremental encoder 1 V _{pp}				
	Re-solver	sin/cos incremental encoder 1 V _{pp}	DIN IEC	k LB	k LB	l E	d D	a ₁ P	Type	D ₁	D ₂	D ₃	D ₄	D ₅	L ₂	L ₃	L ₄	L ₅	L ₈			L ₉	L ₁₀	L ₁₆	K
Type of construction IM B 5, self-cooled, with plug, with/without brake, with planetary gear (LP series), 1-stage																									
36	1FK6032	–	7.05 (179)	–	1.18 (30)	0.55 (14)	3.62 (92)		LP070-M01	2.76 (70)	2.05 (52)	0.63 (16)	2.44 (62)	M 5	1.1 (28)	0.2 (5)	0.31 (8)	0.39 (10)	0.71 (18)	0.2 (5)	2.76 (70)	4.96 (126)	10.59 (269)	–	–
48	1FK6040	–	6.3 (160)	8.03 (204)	1.57 (40)	0.75 (19)	4.72 (120)		LP090-M01	3.54 (90)	2.68 (68)	0.87 (22)	3.15 (80)	M 6	1.42 (36)	0.2 (5)	0.39 (10)	0.47 (12)	0.96 (25)	0.24 (6)	3.54 (90)	6.22 (158)	10.71 (272)	12.44 (316)	–
	1FK6042	–	7.56 (192)	9.29 (236)																			11.97 (304)	13.7 (348)	–
63	1FK6060	–	7.87 (200)	9.37 (238)	1.97 (50)	0.94 (24)	6.1 (155)		LP120-M01	4.72 (120)	3.54 (90)	1.26 (32)	4.25 (108)	M 8	2.28 (58)	0.24 (6)	0.47 (12)	0.63 (16)	1.38 (35)	0.39 (10)	4.72 (120)	8.27 (210)	13.39 (340)	14.88 (378)	–
	1FK6063	–	9.84 (250)	11.34 (288)																			15.35 (390)	16.85 (428)	–
80	1FK6080	–	7.68 (195)	9.53 (242)	2.28 (58)	1.26 (32)	7.3 (186)		LP155-M01	6.1 (155)	4.72 (120)	1.57 (40)	5.51 (140)	M 10	3.23 (82)	0.31 (8)	0.59 (15)	0.79 (20)	1.69 (43)	0.47 (12)	5.91 (150)	10.43 (265)	14.29 (363)	16.14 (411)	–
	1FK6083	–	9.17 (233)	11.02 (280)																			15.79 (401)	17.64 (448)	–
100	1FK6100	–	8.58 (218)	10.43 (265)	3.15 (80)	1.5 (38)	9.45 (240)		LP155-M01	6.1 (155)	4.72 (120)	1.57 (40)	5.51 (140)	M 10	3.23 (82)	0.31 (8)	0.59 (15)	0.79 (20)	1.69 (43)	0.47 (12)	7.56 (192)	10.43 (265)	15.2 (386)	17.05 (433)	–
	1FK6101	–	9.61 (244)	11.46 (291)																			16.22 (412)	18.07 (459)	–
	1FK6103	–	10.63 (270)	12.48 (317)																			17.24 (438)	19.09 (485)	–

1FK6032
1FK6040
1FK6060
1FK6080

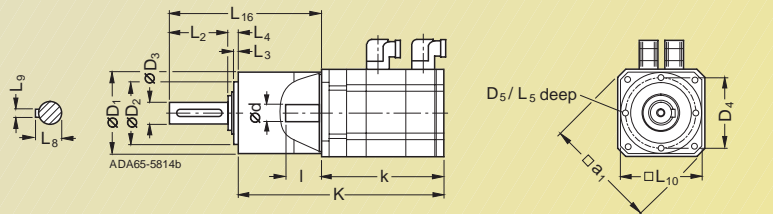

1FK6100

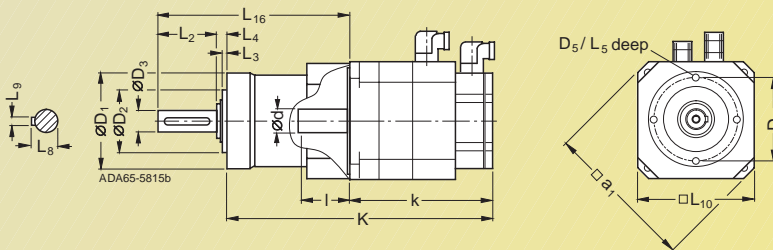



Synchronous Servomotors

Servomotors Dimension Drawings

1FK7 (CT) motors
self-cooled, with planetary gear

For motor		Dimension in inches (mm)																	
Size	Type	DIN IEC	Resolver without brake		Resolver with brake		Basic absolute-value encoder (EnDat) sin/cos incremental encoder 1 V _{pp}				Absolute-value encoder (EnDat)				l	d	a ₁		
			k	K	k	K	k	K	k	K	k	K	k	K				k	K
			LB	-	LB	-	LB	-	LB	-	LB	-	LB	-				LB	-
Type of construction IM B 5, self-cooled, with plug, with/without brake, with planetary gear (LP series), 1-stage																			
48	1FK7040-5		5.24 (133)	9.65 (245)	6.38 (162)	10.79 (274)	6.18 (157)	10.59 (269)	7.36 (187)	11.77 (299)	6.46 (164)	10.87 (276)	7.6 (193)	12.01 (305)	1.57 (40)	0.75 (19)	4.72 (120)		
	1FK7042-5		6.3 (160)	10.71 (272)	7.44 (189)	11.85 (301)	7.28 (185)	11.69 (297)	8.43 (214)	12.83 (326)	7.56 (192)	11.97 (304)	8.7 (221)	13.11 (333)					
63	1FK7060-5		6.12 (155.5)	11.65 (296)	7.17 (198.5)	13.35 (339)	7.07 (179.5)	12.6 (320)	8.76 (222.5)	14.29 (363)	7.38 (187.5)	12.91 (328)	9.07 (230.5)	14.61 (371)	1.97 (50)	0.94 (24)	6.1 (155)		
	1FK7063-5		7.89 (200.5)	13.43 (341)	9.59 (243.5)	15.12 (384)	8.84 (224.5)	14.37 (365)	10.53 (267.5)	16.06 (408)	9.15 (232.5)	14.69 (373)	10.85 (275.5)	16.38 (416)					
80	1FK7080-5		6.08 (154.5)	12.68 (322)	7.17 (182)	13.78 (350)	7.03 (178.5)	13.62 (346)	8.11 (206)	14.72 (374)	7.34 (186.5)	13.94 (354)	8.43 (214)	15.04 (382)	2.28 (58)	1.26 (32)	7.32 (186)		
	1FK7083-5		7.58 (192.5)	14.17 (360)	9.59 (243.5)	16.18 (411)	8.52 (216.5)	15.12 (384)	10.53 (267.5)	17.13 (435)	8.84 (224.5)	15.43 (392)	10.85 (275.5)	17.44 (443)					
100	1FK7100-5		7.22 (183.5)	13.82 (351)	7.97 (202.5)	14.57 (370)	8.17 (207.5)	14.76 (375)	8.92 (226.5)	15.51 (394)	8.48 (215.5)	15.08 (383)	9.23 (234.5)	15.83 (402)	3.15 (80)	1.5 (38)	9.45 (240)		
	1FK7101-5		8.25 (209.5)	14.84 (377)	9 (228.5)	15.59 (396)	9.19 (233.5)	15.79 (401)	9.94 (252.5)	16.54 (420)	9.51 (241.5)	16.1 (409)	10.26 (260.5)	16.85 (428)					
	1FK7103-5		9.27 (235.5)	15.87 (403)	10.02 (254.5)	16.61 (422)	10.22 (259.5)	16.81 (427)	10.96 (278.5)	17.56 (446)	10.53 (267.5)	17.13 (435)	11.28 (286.5)	17.87 (454)					

Size	Type	Planetary gear single-stage Type	Planetary gear single-stage												
			D ₁	D ₂	D ₃	D ₄	D ₅	L ₂	L ₃	L ₄	L ₅	L ₈	L ₉	L ₁₀	L ₁₆
48	1FK7040-5	LP090-M01	3.54 (90)	2.68 (68)	0.87 (22)	3.15 (80)	M 6	1.42 (36)	0.2 (5)	0.39 (10)	0.47 (12)	0.98 (25)	0.24 (6)	3.54 (90)	6.22 (158)
	1FK7042-5														
63	1FK7060-5	LP120-M01	4.72 (120)	3.54 (90)	1.26 (32)	4.25 (108)	M 8	2.28 (58)	0.24 (6)	0.47 (12)	0.63 (16)	1.38 (35)	0.39 (10)	4.72 (120)	8.27 (210)
	1FK7063-5														
80	1FK7080-5	LP155-M01	6.1 (155)	4.72 (120)	1.57 (40)	5.51 (140)	M 10	3.23 (82)	0.31 (8)	0.59 (15)	0.79 (20)	1.69 (43)	0.47 (12)	5.91 (150)	10.43 (265)
	1FK7083-5														
100	1FK7100-5	LP155-M01	6.1 (155)	4.72 (120)	1.57 (40)	5.51 (140)	M 10	3.23 (82)	0.31 (8)	0.59 (15)	0.79 (20)	1.69 (43)	0.47 (12)	7.56 (192)	10.43 (265)
	1FK7101-5														
	1FK7103-5														

1FK704 -5
1FK706 -5
1FK708 -5

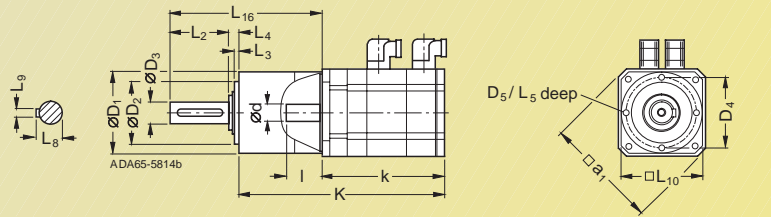

1FK710 -5

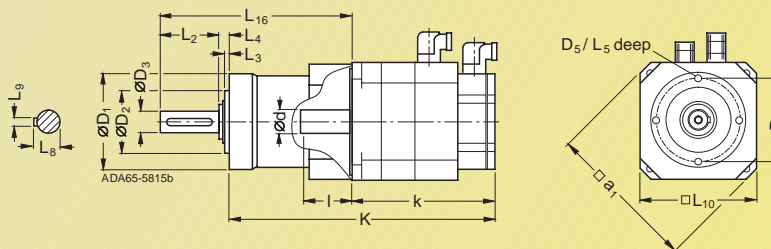

Servomotors Dimension Drawings

1FK7 (HD) motors
self-cooled, with planetary gear

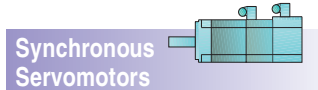

Size	Type	Dimension in inches (mm)																
		DIN IEC	Resolver				Basic absolute-value encoder (EnDat) sin/cos incremental encoder 1 V _{pp}				Absolute-value encoder (EnDat)				l	d	a ₁	
			without brake		with brake		without brake		with brake		without brake		with brake					
k	K	k	K	k	K	k	K	k	K	k	K	k	K	k	K			
Type of construction IM B 5, self-cooled, with plug, with/without brake, with planetary gear (LP series), 1-stage																		
36	1FK7033-7	6.75 (171.5)	11.71 (297.5)	7.58 (192.5)	12.54 (318.5)	7.74 (196.5)	12.7 (322.5)	8.56 (217.5)	13.52 (343.5)	-	-	-	-	-	-	1.18 (30)	0.55 (14)	3.62 (92)
48	1FK7043-7	7.54 (191.5)	13.76 (349.5)	8.68 (220.5)	14.9 (378.5)	8.35 (212)	14.57 (370)	9.49 (241)	15.71 (399)	8.68 (220.5)	14.9 (378.5)	9.82 (249.5)	16.04 (407.5)	1.57 (40)	0.75 (19)	4.72 (120)		
	1FK7044-7	8.52 (216.5)	14.74 (374.5)	9.67 (245.5)	15.89 (403.5)	9.33 (237)	15.55 (395)	10.47 (266)	16.69 (424)	9.67 (245.5)	15.89 (403.5)	10.81 (274.5)	17.03 (432.5)					
63	1FK7061-7	7.34 (186.5)	15.61 (396.5)	9 (228.5)	17.26 (438.5)	8.25 (209.5)	16.52 (419.5)	9.9 (251.5)	18.17 (461.5)	8.58 (218)	16.85 (428)	10.24 (260)	18.5 (470)	1.97 (50)	0.94 (24)	6.1 (155)		
	1FK7064-7	9.86 (250.5)	18.13 (460.5)	11.52 (292.5)	19.78 (502.5)	10.77 (273.5)	19.04 (483.5)	12.42 (315.5)	20.69 (525.5)	11.1 (282)	19.37 (492)	12.76 (324)	21.02 (534)					
80	1FK7082-7	8.29 (210.5)	18.70 (475)	9.96 (253)	20.37 (517.5)	9.19 (233.5)	19.61 (498)	10.87 (276)	21.28 (540.5)	9.53 (242)	19.94 (506.5)	11.18 (284)	21.59 (548.5)	2.28 (58)	1.26 (32)	7.32 (186)		
	1FK7085-7	10.26 (260.5)	20.67 (525)	11.93 (303)	22.34 (567.5)	11.16 (283.5)	21.57 (548)	12.83 (326)	23.25 (590.5)	11.5 (292)	21.91 (556.5)	13.17 (334.5)	23.58 (599)					

Size	Type	Planetary gear single-stage Type	Planetary gear single-stage												
			D ₁	D ₂	D ₃	D ₄	D ₅	L ₂	L ₃	L ₄	L ₅	L ₈	L ₉	L ₁₀	L ₁₆
36	1FK7033-7	LP070-M01	2.76 (70)	2.05 (52)	0.63 (16)	2.44 (62)	M 5	1.1 (28)	0.2 (5)	0.31 (8)	0.39 (10)	0.71 (18)	0.2 (5)	2.76 (70)	4.96 (126)
48	1FK7043-7	LP090-M01	3.54 (90)	2.68 (68)	0.87 (22)	3.15 (80)	M 6	1.42 (36)	0.2 (5)	0.39 (10)	0.47 (12)	0.98 (25)	0.24 (6)	3.54 (90)	6.22 (158)
	1FK7044-7														
63	1FK7061-7	LP120-M01	4.72 (120)	3.54 (90)	1.26 (32)	4.25 (108)	M 8	2.28 (58)	0.24 (6)	0.47 (12)	0.63 (16)	1.38 (35)	0.39 (10)	4.72 (120)	8.27 (210)
	1FK7064-7														
80	1FK7082-7	LP155-M01	6.1 (155)	4.72 (120)	1.57 (40)	5.51 (140)	M 10	3.23 (82)	0.31 (8)	0.59 (15)	0.79 (20)	1.69 (43)	0.47 (12)	5.91 (150)	10.43 (265)
	1FK7085-7														

1FK7033-7
1FK704 .-7
1FK706 .-7
1FK708 .-7

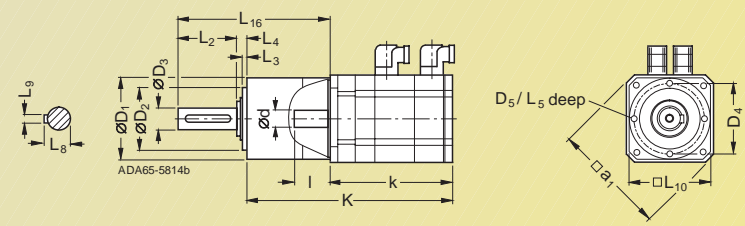

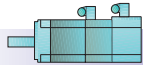

Synchronous Servomotors

Servomotors Dimension Drawings

1FT6 motors, self-cooled

For motor		Dimension in inches (mm)													Resolver			
Size	Type	DIN	a ₁	b ₁	c ₁	e ₁	f	f ₁	g ₂	h	i ₂	s ₂ ¹⁾	s ₂ ²⁾	o ₁	without brake		with brake	
		IEC	P	N	LA	M	AB	T	-	H	-	S	S	-	k	o	k	o
Type of construction IM B 5, self-cooled, with plug, with/without brake																		
28	1FT6021	-	1.57 (40)	0.39 (10)	2.48 (63)	2.17 (55)	0.1 (2.5)	2.48 (63)	1.1 (28)	0.79 (20)	0.23 (5.8)	-	1.36 (34.5)	7.6 (193)	4.8 (122)	8.58 (218)	5.79 (147)	
	1FT6024													9.17 (233)	6.38 (162)	10.16 (258)	7.36 (187)	
36	1FT6031		3.62 (92)	2.36 (60)	0.31 (8)	2.95 (75)	2.83 (72)	0.12 (3)	3.03 (77)	1.42 (36)	1.18 (30)	0.24 (6)	-	7.09 (180)	5.94 (151)	7.87 (200)	6.73 (171)	
	1FT6034													8.66 (220)	7.52 (191)	9.45 (240)	8.31 (211)	

Size	Type	DIN IEC	sin/cos incremental encoder 1 V _{pp}				D-end of shaft				
			without brake		with brake		d	d ₆	l	t	u
			k	o	k	o	D	-	E	GA	F
28	1FT6021		7.6 (193)	4.8 (122)	8.58 (218)	5.79 (147)	0.35 (9)	M 3	0.79 (20)	0.4 (10.2)	0.12 (3)
	1FT6024		9.17 (233)	6.38 (162)	10.16 (258)	7.36 (187)					
36	1FT6031		8.66 (220)	5.94 (151)	9.45 (240)	6.73 (171)	0.55 (14)	M 5	1.18 (30)	0.63 (16)	0.2 (5)
	1FT6034		10.24 (260)	7.52 (191)	11.02 (280)	8.31 (211)					

1FT602 .

Shaft with featherkey

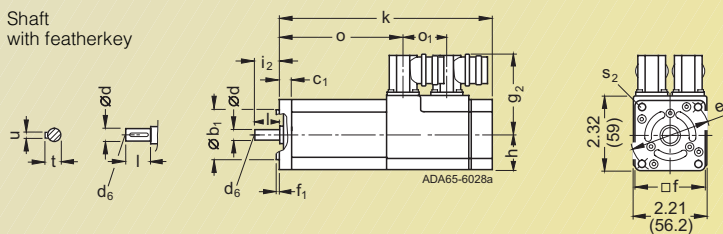

1FT603 .

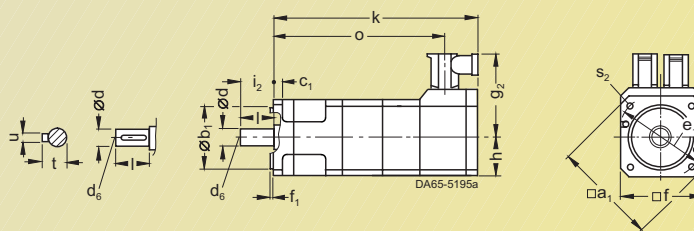

1) IM B 5. 2) IM B 14.

Servomotors Dimension Drawings

1FT6 motors, self-cooled

Synchronous
Servomotors

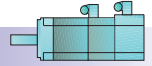

For motor		Dimension in inches (mm)													Resolver				
Size	Type	DIN IEC	a ₁	b ₁	c ₁	e ₁	f	f ₁	g ₂	h	i ₂	s ₂ ¹⁾	s ₂ ²⁾	o ₁	without brake		with brake		
			P	N	LA	M	AB	T	-	H	-	S	S	-	k LB	o -	k LB	o -	
Type of construction IM B 5, self-cooled, with plug, with/without brake																			
48	1FT6041		4.72 (120)	3.15 (80)	0.39 (10)	3.94 (100)	3.78 (96)	0.12 (3)	3.19 (81)	1.89 (48)	1.57 (40)	0.28 (7)	-	-	-	7.36 (187)	6.18 (157)	8.74 (222)	7.56 (192)
	1FT6044															9.33 (237)	8.15 (207)	10.71 (272)	9.53 (242)
63	1FT6061		5.71 (145)	4.33 (110)	0.39 (10)	5.12 (130)	4.57 (116)	0.14 (3.5)	3.58 (91)	2.28 (58)	1.97 (50)	0.35 (9)	M 8	-	7.8 (198)	6.77 (172)	8.98 (228)	7.95 (202)	
	1FT6062														8.78 (223)	7.76 (197)	9.96 (253)	8.94 (227)	
	1FT6064														10.75 (273)	9.72 (247)	11.93 (303)	10.91 (277)	

Size	Type	DIN IEC	sin/cos incremental encoder 1 V _{pp}				D-end of shaft				
			without brake		with brake		d	d ₆	l	t	u
			k LB	o -	k LB	o -	D	-	E	GA	F
48	1FT6041		8.98 (228)	6.18 (157)	10.35 (263)	7.56 (192)	0.75 (19)	M 6	1.57 (40)	0.85 (21.5)	0.24 (6)
	1FT6044		10.94 (278)	8.15 (207)	12.32 (313)	9.53 (242)					
63	1FT6061		8.98 (228)	6.77 (172)	10.16 (258)	7.95 (202)	0.94 (24)	M 8	1.97 (50)	1.06 (27)	0.31 (8)
	1FT6062		9.96 (253)	7.76 (197)	11.14 (283)	8.94 (227)					
	1FT6064		11.93 (303)	9.72 (247)	13.11 (333)	10.91 (277)					

1FT604 .
1FT606 .

Shaft
with featherkey

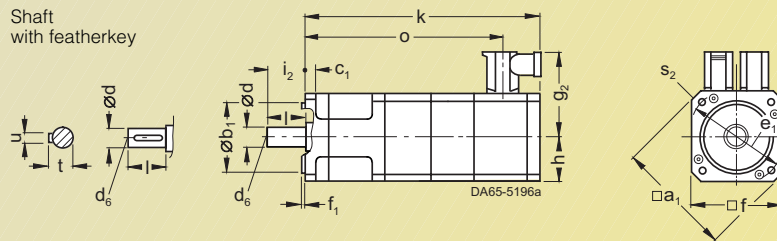

1) IM B 5. 2) IM B 14.

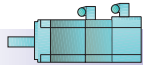

Synchronous
Servomotors

1FT6 motors, self-cooled

For motor		Dimension in inches (mm)														Resolver			
Size	Type	DIN	a ₁	b ₁	c ₁	e ₁	f	f ₁	g ₂	h	i ₂	p	s ₂ ¹⁾	s ₂ ²⁾	o ₁	without brake		with brake	
		IEC	P	N	LA	M	AB	T	-	H	-	HD	S	S	-	k	o	k	o
Type of construction IM B 5, with plug, with/without brake																			
80	1FT6081		7.64 (194)	5.12 (130)	0.47 (12)	6.5 (165)	6.1 (155)	0.14 (4)	5.02 (127.5)	3.05 (77.5)	2.28 (58)	-	0.43 (11)	M 10	2.99 (76)	8.7 (221)	4.45 (113)	9.76 (248)	5.51 (140)
	1FT6082															9.69 (246)	5.43 (138)	10.75 (273)	6.5 (165)
	1FT6084															11.65 (296)	7.4 (188)	13.46 (342)	9.21 (234)
	1FT6086															13.62 (346)	9.37 (238)	15.43 (392)	11.18 (284)

Size	Type	DIN IEC	sin/cos incremental encoder 1 V _{pp}		D-end of shaft						
			without brake	with brake	k	o	d	d ₆	l	t	u
			LB	-	LB	-	D	-	E	GA	F
80	1FT6081		8.7 (221)	4.45 (113)	9.76 (248)	5.51 (140)	1.26 (32)	M 12	2.28 (58)	1.38 (35)	0.39 (10)
	1FT6082		9.69 (246)	5.43 (138)	10.75 (273)	6.5 (165)					
	1FT6084		11.65 (296)	7.4 (188)	13.46 (342)	9.21 (234)					
	1FT6086		13.62 (346)	9.37 (238)	15.43 (392)	11.18 (284)					

1FT608 .

Shaft
with featherkey

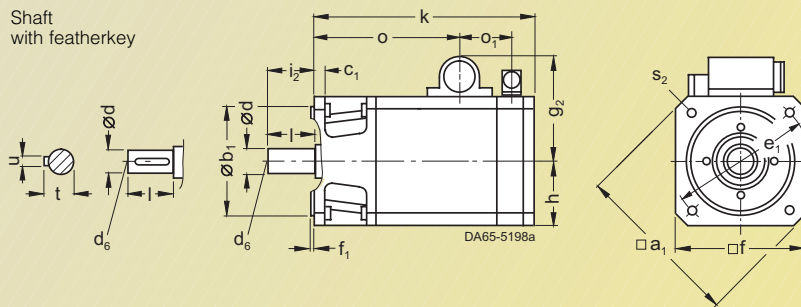

1) IM B 5. 2) IM B 14.

Servomotors Dimension Drawings

Synchronous
Servomotors

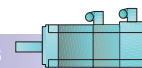

1FT6 motors, self-cooled

For motor		Dimension in inches (mm)														Resolver			
Size	Type	DIN IEC	a ₁ P	b ₁ N	c ₁ LA	e ₁ M	f AB	f ₁ T	g ₂ -	h H	i ₂ -	p HD	s ₂ ¹⁾ S	s ₂ ²⁾ S	o ₁ -	k LB	o -	k LB	o -
Type of construction IM B 5, with plug, with/without brake																			
100	1FT6102		9.45 (240)	7.09 (180)	0.51 (13)	8.46 (215)	7.56 (192)	0.16 (4)	5.75 (146)	3.78 (96)	3.15 (80)	6.1 (155)	0.55 (14)	M 12	2.99 (76)	11.61 (295)	7.32 (186)	13.43 (341)	9.13 (232)
	1FT6105															14.57 (370)	10.28 (261)	16.38 (416)	12.09 (307)
	1FT6108															18.5 (470)	14.21 (361)	20.31 (516)	16.02 (407)
132	1FT6132		-	9.84 (250)	0.71 (18)	11.81 (300)	10.24 (260)	0.2 (5)	6.79 (172.5)	5.2 (132)	3.23 (82)	9.65 (245)	0.71 (18)	-	2.6 (66)	16.65 (423)	11.34 (288)	18.62 (473)	13.31 (338)
	1FT6134															18.62 (473)	13.31 (338)	20.59 (523)	15.28 (388)
	1FT6136															20.59 (523)	15.28 (388)	22.56 (573)	17.24 (438)

Size	Type	DIN IEC	sin/cos incremental encoder 1 V _{pp}		D-end of shaft						
			without brake	with brake	k LB	o -	d D	d ₆ -	l E	t GA	u F
100	1FT6102		11.61 (295)	7.32 (186)	13.43 (341)	9.13 (232)	1.5 (38)	M 12	3.15 (80)	1.61 (41)	0.39 (10)
	1FT6105		14.57 (370)	10.28 (261)	16.38 (416)	12.09 (307)					
	1FT6108		18.5 (470)	14.21 (361)	20.31 (516)	16.02 (407)					
132	1FT6132		16.65 (423)	11.34 (288)	18.62 (473)	13.31 (338)	1.89 (48)	M 16	3.23 (82)	2.03 (52)	0.55 (14)
	1FT6134		18.62 (473)	13.31 (338)	20.59 (523)	15.28 (388)					
	1FT6136		20.59 (523)	15.28 (388)	22.56 (573)	17.24 (438)					

1FT610 .

Shaft with featherkey

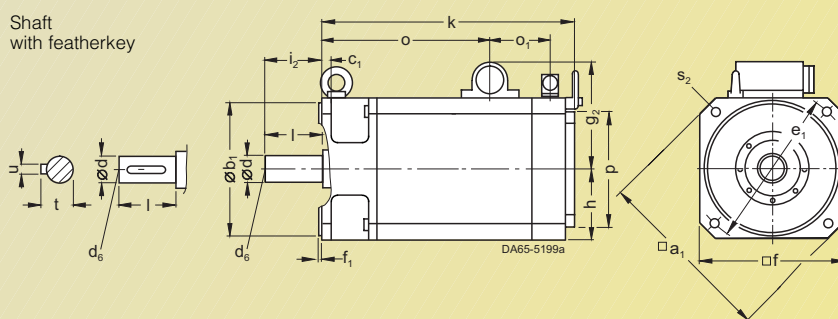

1FT613 .

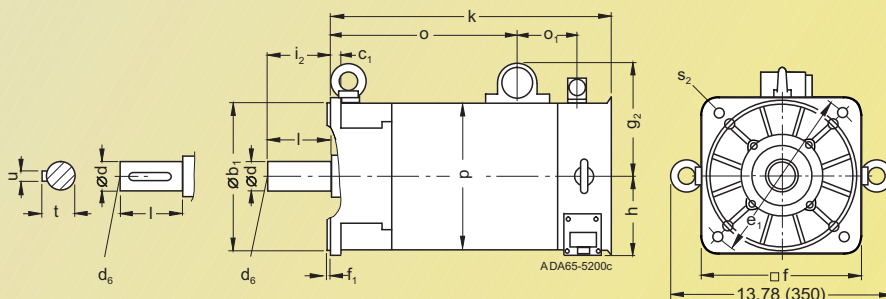

1) IM B 5. 2) IM B 14.

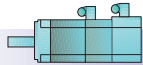

Synchronous Servomotors

Servomotors Dimension Drawings

1FT6 motors, self-cooled

For motor		Dimension in inches (mm)														Resolver				
Size	Type	DIN	a ₁	b ₁	c ₁	e ₁	f	f ₁	g ₂	h	i ₂	p	s ₂ ¹⁾	s ₂ ²⁾	o ₁	without brake		with brake		
		IEC	P	N	LA	M	AB	T	-	H	-	HD	S	S	-	k	o	k	o	
Type of construction IM B 5, self-cooled, with terminal box, with/without brake																				
100	1FT6102		9.45 (240)	7.09 (180)	0.51 (13)	8.46 (215)	7.56 (192)	0.16 (4)	6.1 (155)	3.78 (96)	3.15 (80)	6.1 (155)	0.55 (14)	M 12	2.99 (76)	11.61 (295)	7.32 (186)	13.43 (341)	9.13 (232)	
	1FT6105															14.57 (370)	10.28 (261)	16.38 (416)	12.09 (307)	
	1FT6108															18.5 (470)	14.21 (361)	20.31 (516)	16.02 (407)	
132	1FT6132	-		9.84 (250)	0.71 (18)	11.81 (300)	10.24 (260)	0.2 (5)	7.34 (186.5)	5.2 (132)	3.23 (82)	9.65 (245)	0.71 (18)	-	-	16.65 (423)	11.34 (288)	18.62 (473)	13.31 (338)	
	1FT6134															18.62 (473)	13.31 (338)	20.59 (523)	15.28 (388)	
	1FT6136															20.59 (523)	15.28 (388)	22.56 (573)	17.24 (438)	

Size	Type	DIN IEC	sin/cos incremental encoder 1 V _{pp}				D-end of shaft				
			without brake		with brake		d	d ₆	l	t	u
k	o	k	o	d	d ₆	l	t	u			
LB	-	LB	-	D	-	E	GA	F			
100	1FT6102		11.61 (295)	7.32 (186)	13.43 (341)	9.13 (232)	1.5 (38)	M 12	3.15 (80)	1.61 (41)	0.39 (10)
	1FT6105		14.57 (370)	10.28 (261)	16.38 (416)	12.09 (307)					
	1FT6108		18.5 (470)	14.21 (361)	20.31 (516)	16.02 (407)					
132	1FT6132		16.65 (423)	11.34 (288)	18.62 (473)	13.31 (338)	1.89 (48)	M 16	3.23 (82)	2.03 (51.5)	0.55 (14)
	1FT6134		18.62 (473)	13.31 (338)	20.59 (523)	15.28 (388)					
	1FT6136		20.59 (523)	15.28 (388)	22.56 (573)	17.24 (438)					

1FT610 .

Shaft with featherkey

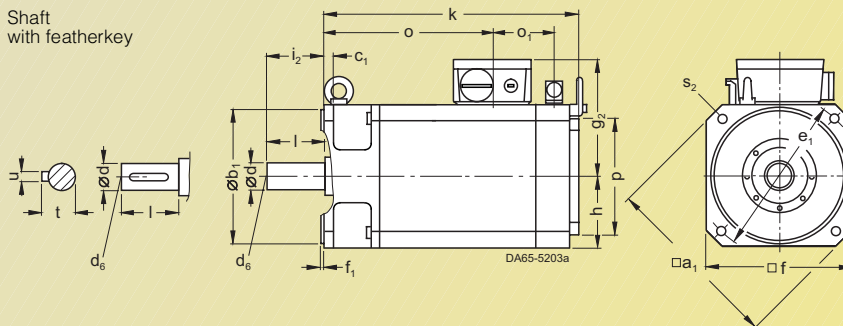

1FT613 .

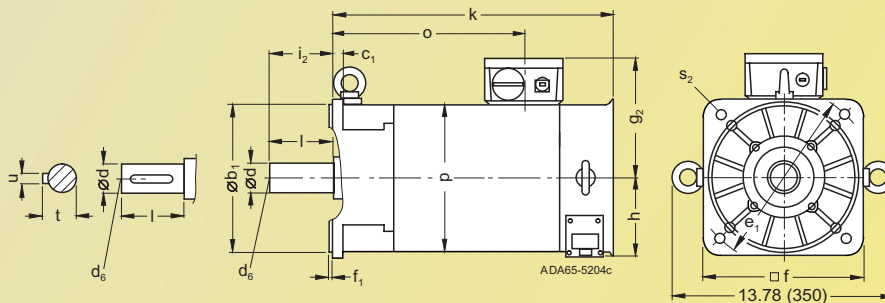

1) IM B 5. 2) IM B 14.

Servomotors Dimension Drawings

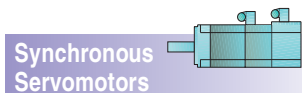

1FT6 motors, blower-ventilated

For motor	Dimension in inches (mm)	Plug															
		Size 1.5	3														
Size	Type	DIN IEC	a ₁ P	b ₁ N	c ₁ LA	e ₁ M	f AB	f ₁ T	g ₂ -	g ₂ -	h H	i ₂ -	p HD	s ₂ ¹⁾ S	s ₂ ²⁾ S	o ₁ -	o ₂ -

Type of construction IM B 5, blower-ventilated, with plug, with/without brake																		
80	1FT6084	7.64 (194)	5.12 (130)	0.47 (12)	6.5 (165)	7.28 (185)	0.14 (3.5)	5.49 (139.5)	6.04 (153.5)	3.64 (92.5)	2.28 (58)	6.89 (175)	0.43 (11)	M 10	2.99 (76)	6.65 (169)		
	1FT6086																	
100	1FT6105	9.45 (240)	7.09 (180)	0.51 (13)	8.46 (215)	8.7 (221)	0.16 (4)	6.22 (158)	6.77 (172)	4.35 (110.5)	3.15 (80)	8.35 (212)	0.55 (14)	M 12	- (76.5)	6.69 (170)		
	1FT6108																	

Size	Type	DIN IEC	Resolver/sin/cos incremental encoder 1 V _{pp}				D-end of shaft											
			without brake		with brake		d	d ₆	l	t	u							
			k LB	o -	k LB	o -	D	-	E	GA	F							
80	1FT6084		15.71 (399)	7.4 (188)	17.52 (445)	9.21 (234)	1.26 (32)	M 12	2.28 (58)	1.38 (35)	0.39 (10)							
	1FT6086		17.68 (449)	9.37 (238)	19.49 (495)	11.18 (284)												
100	1FT6105		18.62 (473)	10.28 (261)	20.43 (519)	12.09 (307)	1.5 (38)	M 12	3.15 (80)	1.61 (41)	0.39 (10)							
	1FT6108		22.56 (573)	14.21 (361)	24.37 (619)	16.02 (407)												

1FT608 .

Shaft with featherkey

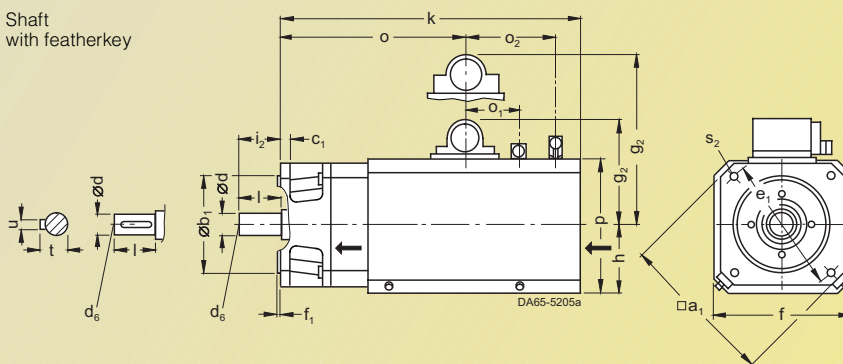

1FT610 .

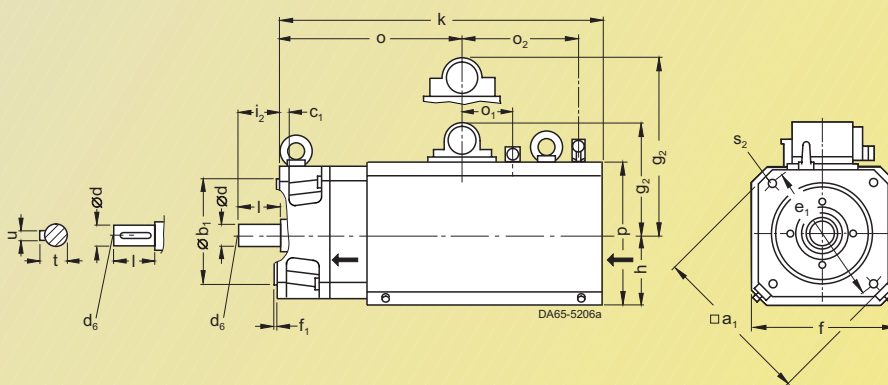

1) IM B 5. 2) IM B 14.

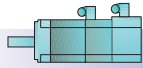

Synchronous Servomotors

Servomotors Dimension Drawings

1FT6 motors, blower-ventilated

For motor		Dimension in inches (mm)														Plug Size		
Size	Type	DIN IEC	a ₁	b ₁	c ₁	e ₁	f	f ₁	g ₂	g ₂	h	i ₂	p	s ₂ ¹⁾	s ₂ ²⁾	o ₁	o ₂	
			P	N	LA	M	AB	T	-	-	H	-	HD	S	S	-	-	
Type of construction IM B 5, blower-ventilated, with plug, with/without brake																		
132	1FT6132	-	9.84 (250)	0.71 (18)	11.81 (300)	10.24 (260)	0.2 (5)	-	7.34 (186.5)	5.2 (132)	3.23 (82)	9.65 (245)	0.71 (18)	-	2.6 (66)	-	-	
	1FT6134																	
	1FT6136																	
Size	Type	DIN IEC	Resolver/sin/cos incremental encoder 1 V _{pp}				D-end of shaft											
			without brake		with brake		d	d ₆	l	t	u							
			k	o	k	o	D	-	E	GA	F							
132	1FT6132		21.3 (541)	11.34 (288)	23.27 (591)	13.31 (338)	1.89 (48)	M 16	3.23 (82)	2.03 (51.5)	0.55 (14)							
	1FT6134		23.27 (591)	13.31 (338)	25.24 (641)	15.28 (388)												
	1FT6136		25.24 (641)	15.28 (388)	27.2 (691)	17.24 (438)												

1FT613 .

Shaft with featherkey

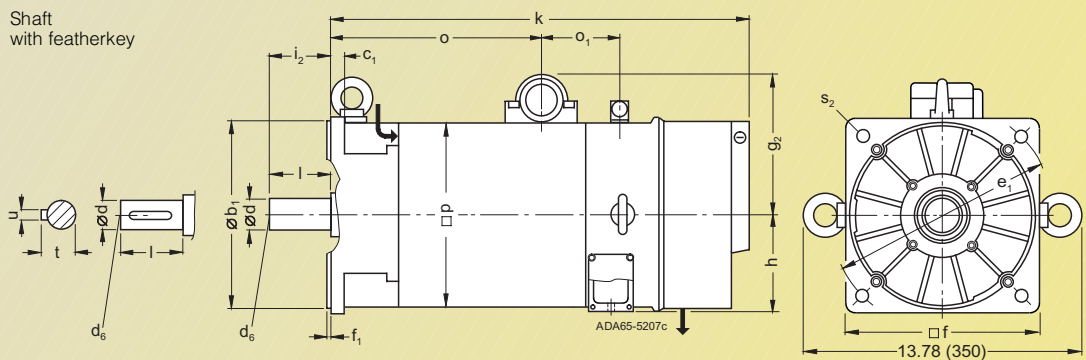

1) IM B 5. 2) IM B 14.

Servomotors Dimension Drawings

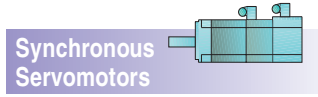

1FT6 motors, blower-ventilated

For motor Dimension in inches (mm) Terminal box gk 130
*gk 420 gk 230

Size	Type	DIN IEC	a ₁ P	b ₁ N	c ₁ LA	e ₁ M	f AB	f ₁ T	g ₂ -	g ₂ -	h H	i ₂ -	p HD	s ₂ ¹⁾ S	s ₂ ²⁾ S	o ₁ -	o ₂ -
Type of construction IM B 5, blower-ventilated, with terminal box, with/without brake																	
100	1FT6105		9.45 (240)	7.09 (180)	0.51 (13)	8.46 (215)	8.7 (221)	0.16 (4)	-	6.77 (172)	4.35 (110.5)	3.15 (80)	8.35 (212)	0.55 (14)	M 12	-	6.69 (170)
	1FT6108																
132	1FT6132		-	9.84 (250)	0.71 (18)	11.81 (300)	10.24 (260)	0.2 (5)	7.95* (202)*	7.34 (186.5)	5.2 (132)	3.23 (82)	9.65 (245)	0.71 (18)	-	-	-
	1FT6134																
	1FT6136																

Size	Type	DIN IEC	Resolver/sin/cos incremental encoder 1 V _{pp}		D-end of shaft						
			without brake	with brake	k LB	o -	d D	d ₆ -	l E	t GA	u F
100	1FT6105		18.62 (473)	10.28 (261)	20.43 (519)	12.09 (307)	1.5 (38)	M 12	3.15 (80)	1.61 (41)	0.39 (10)
	1FT6108		22.56 (573)	14.21 (361)	24.37 (619)	16.02 (407)					
132	1FT6132		21.3 (541)	11.34 (288)	23.27 (591)	13.31 (338)	1.89 (48)	M 16	3.23 (82)	2.03 (51.5)	0.55 (14)
	1FT6134		23.27 (591)	13.31 (338)	25.24 (641)	15.28 (388)					
	1FT6136		25.24 (641)	15.28 (388)	27.2 (691)	17.24 (438)					

1FT610 .

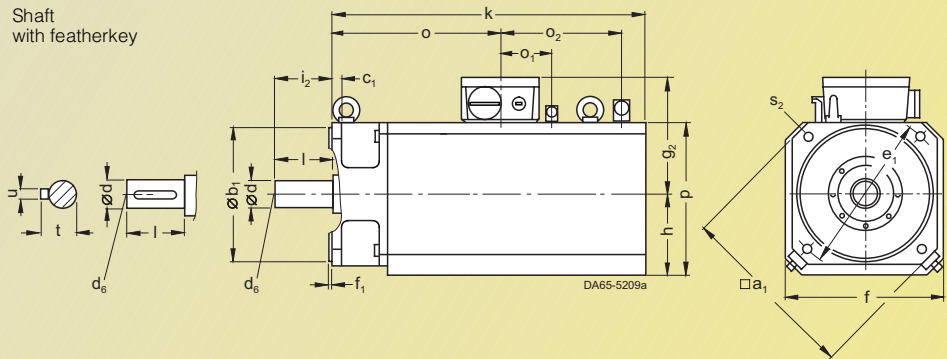

1FT613 .

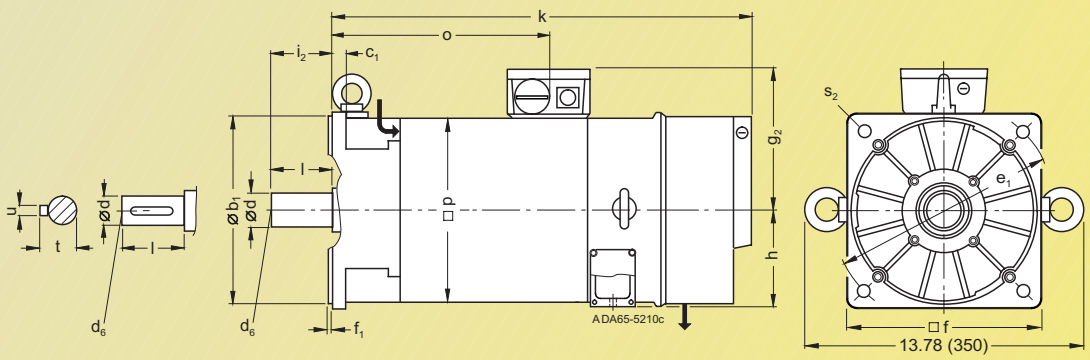

1) IM B 5. 2) IM B 14.

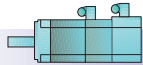

Synchronous Servomotors

Servomotors Dimension Drawings

1FT6 motors, self-cooled,
with planetary gear

For motor Size	Type	With planetary gear-box, single-stage Type	Dimension in inches (mm)							without brake		with brake		D-end of shaft		For motor dimensions, see dimension drawings on pages 8/9 to 8/12	
			DIN IEC	b ₁ N	c ₁ LA	e ₁ M	f AB	k ¹⁾ LB	k ¹⁾ LB	s ₂ S	d D	l E					
Type of construction IM B 5, self-cooled, with plug, with/without brake, with planetary gear (SPG series), single-stage																	
28	1FT6024	SPG 060-MF1	2.36 (60)	0.78 (20)	2.68 (68)	2.44 (62)	12.36 (314)	13.35 (339)	0.21 (5.5)	0.62 (16)	1.1 (28)						
36	1FT6031	SPG 060-MF1	2.36 (60)	0.78 (20)	2.67 (68)	2.44 (62)	11.85 (301)	12.64 (321)	0.21 (5.5)	0.62 (16)	1.1 (28)						
	1FT6034	SPG 060-MF1					13.43 (341)	14.21 (361)									
		SPG 075-MF1	2.75 (70)		3.34 (85)	2.99 (76)	14.17 (360)	14.96 (380)	0.25 (6.6)	0.86 (22)	1.41 (36)						
48	1FT6041	SPG 075-MF1	2.75 (70)	0.78 (20)	3.34 (85)	2.99 (76)	12.91 (328)	14.29 (363)	0.25 (6.6)	0.86 (22)	1.41 (36)						
	1FT6044	SPG 075-MF1					14.88 (378)	16.26 (413)									
		SPG 100-MF1	3.54 (90)	1.18 (30)	4.72 (120)	3.97 (101)	15.43 (392)	16.81 (427)	0.35 (9)	1.25 (32)	2.28 (58)						
63	1FT6061	SPG 100-MF1	3.54 (90)	1.18 (30)	4.72 (120)	3.97 (101)	13.46 (342)	14.65 (372)	0.35 (9)	1.25 (32)	2.28 (58)						
	1FT6062	SPG 100-MF1					14.45 (367)	15.63 (397)									
	1FT6064	SPG 100-MF1					16.42 (417)	17.6 (447)									
80	1FT6081	SPG 140-MF1	5.11 (130)	1.18 (30)	6.49 (165)	5.55 (141)	14.37 (365)	15.47 (393)	0.43 (11)	1.57 (40)	3.22 (82)						
	1FT6082	SPG 140-MF1					15.39 (391)	16.46 (418)									
	1FT6084	SPG 140-MF1					17.36 (441)	19.17 (487)									
	1FT6086	SPG 140-MF1					19.33 (491)	21.14 (537)									
			SPG 180-MF1	6.29 (160)		8.46 (215)	7.16 (182)	20.91 (531)	22.72 (577)	0.51 (13)	2.16 (55)						
100	1FT6102	SPG 180-MF1	6.29 (160)	1.18 (30)	8.46 (215)	7.16 (182)	18.9 (480)	20.71 (526)	0.51 (13)	2.16 (55)	3.22 (82)						
	1FT6105	SPG 180-MF1					21.85 (555)	23.66 (601)									
			SPG 210-MF1	7.08 (180)	1.49 (38)	9.84 (250)	8.34 (212)	22.72 (577)	24.53 (623)	0.66 (17)	2.95 (75)	4.13 (105)					
	1FT6108	SPG 180-MF1	6.29 (160)	1.18 (30)	8.46 (215)	7.16 (182)	25.79 (655)	27.6 (701)	0.51 (13)	2.16 (55)	3.22 (82)						
			SPG 210-MF1	7.08 (180)	1.49 (38)	9.84 (250)	8.34 (212)	26.65 (677)	28.46 (723)	0.66 (17)	2.95 (75)	4.13 (105)					
132	1FT6132	SPG 210-MF1	7.08 (180)	1.49 (38)	9.84 (250)	8.34 (212)	24.8 (630)	26.77 (680)	0.66 (17)	2.95 (75)	4.13 (105)						
	1FT6134	SPG 210-MF1					27.13 (689)	29.09 (739)									
	1FT6136	SPG 210-MF1					26.77 (680)	28.74 (730)									
	1FT6132	SPG 240-MF1	7.87 (200)	1.57 (40)	11.42 (290)	9.44 (242)	29.09 (739)	31.06 (789)	0.66 (17)	3.34 (85)	5.12 (130)						
	1FT6134	SPG 240-MF1					28.74 (730)	30.71 (780)									
			SPG 240-MF1					31.06 (789)	33.03 (839)								

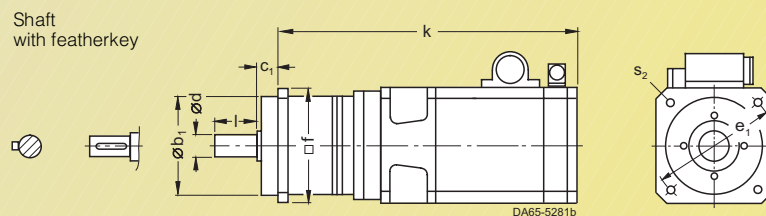

1) Motors with encoder.

Servomotors Dimension Drawings

1FT6 motors, self-cooled,
with planetary gear

Synchronous
Servomotors

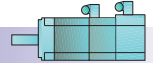

For motor Size	Type	With planetary gear-box, 2-stage Type	Dimension in inches (mm)							without brake	with brake	D-end of shaft		For motor dimensions, see dimension drawings on pages 8/9 to 8/12	
			DIN IEC	b ₁ N	c ₁ LA	e ₁ M	f AB	k ¹⁾ LB	k ¹⁾ LB	s ₂ S	d D	l E			
Type of construction IM B 5, self-cooled, with plug, with/without brake, with planetary gear (SPG series), 2-stage															
28	1FT6024	SPG 075-MF2	2.75 (70)	0.78 (20)	3.34 (85)	2.99 (76)	14.17 (360)	15.16 (385)	0.25 (6.6)	0.86 (22)	1.41 (36)				
36	1FT6031	SPG 075-MF2	2.75 (70)	0.78 (20)	3.34 (85)	2.99 (76)	13.66 (347)	14.45 (367)	0.25 (6.6)	0.86 (22)	1.41 (36)				
	1FT6034	SPG 075-MF2					15.24 (387)	15.91 (404)							
48	1FT6041	SPG 100-MF2	3.54 (90)	1.18 (30)	4.72 (120)	3.97 (101)	16.02 (407)	16.81 (427)	0.35 (9)	1.25 (32)	2.28 (58)				
		SPG 140-MF2	5.11 (130)		6.49 (165)	5.55 (141)	16.26 (413)	17.64 (448)	0.43 (11)	1.57 (40)	3.22 (82)				
	1FT6044	SPG 100-MF2	3.54 (90)		4.72 (120)	3.97 (101)	16.73 (425)	18.11 (460)	0.35 (9)	1.25 (32)	2.28 (58)				
		SPG 140-MF2	5.11 (130)		6.49 (165)	5.55 (141)	18.23 (463)	19.61 (498)	0.43 (11)	1.57 (40)	3.22 (82)				
63	1FT6061	SPG 100-MF2	3.54 (90)	1.18 (30)	4.72 (120)	3.97 (101)	14.76 (375)	15.94 (405)	0.35 (9)	1.25 (32)	2.28 (58)				
		SPG 140-MF2	5.11 (130)		6.49 (165)	5.55 (141)	16.26 (413)	17.44 (443)	0.43 (11)	1.57 (40)	3.22 (82)				
	1FT6062	SPG 100-MF2	3.54 (90)		4.72 (120)	3.97 (101)	15.75 (400)	16.93 (430)	0.35 (9)	1.25 (32)	2.28 (58)				
		SPG 140-MF2	5.11 (130)		6.49 (165)	5.55 (141)	17.24 (438)	18.43 (468)	0.43 (11)	1.57 (40)	3.22 (82)				
	1FT6064	SPG 180-MF2	6.29 (160)		8.46 (215)	7.16 (182)	17.99 (457)	19.17 (487)	0.51 (13)	2.16 (55)					
		SPG 140-MF2	5.11 (130)		6.49 (165)	5.55 (141)	19.21 (488)	20.39 (518)	0.43 (11)	1.57 (40)					
	1FT6064	SPG 180-MF2	6.29 (160)		8.46 (215)	7.16 (182)	19.96 (507)	21.14 (537)	0.51 (13)	2.16 (55)					
		SPG 140-MF2	5.11 (130)		6.49 (165)	5.55 (141)	20.39 (518)	21.57 (548)	0.43 (11)	1.57 (40)					
80	1FT6081	SPG 180-MF2	6.29 (160)	1.18 (30)	8.46 (215)	7.16 (182)	16.73 (425)	17.8 (452)	0.51 (13)	2.16 (55)	3.22 (82)				
		SPG 210-MF2	7.08 (180)	1.49 (38)	9.84 (250)	8.34 (212)	19.69 (500)	20.75 (527)	0.66 (17)	2.95 (75)	4.13 (105)				
	1FT6084	SPG 180-MF2	6.29 (160)	1.18 (30)	8.46 (215)	7.16 (182)	19.69 (500)	21.5 (546)	0.51 (13)	2.16 (55)	3.22 (82)				
		SPG 210-MF2	7.08 (180)	1.49 (38)	9.84 (250)	8.34 (212)	21.65 (550)	23.46 (596)	0.66 (17)	2.95 (75)	4.13 (105)				
	1FT6086	SPG 240-MF2	7.87 (200)	1.57 (40)	11.41 (290)	9.53 (242)	22.83 (580)	24.65 (626)		3.34 (85)	5.11 (130)				
		SPG 180-MF2	6.29 (160)	1.18 (30)	8.46 (215)	7.16 (182)	21.65 (550)	23.46 (596)	0.51 (13)	2.16 (55)	3.22 (82)				
	1FT6086	SPG 210-MF2	7.08 (180)	1.49 (38)	9.84 (250)	8.34 (212)	23.62 (600)	25.43 (646)	0.66 (17)	2.95 (75)	4.13 (105)				
		SPG 240-MF2	7.87 (200)	1.57 (40)	11.41 (290)	9.53 (242)	24.80 (630)	26.61 (676)		3.34 (85)	5.11 (130)				
100	1FT6102	SPG 210-MF2	7.08 (180)	1.49 (38)	9.84 (250)	8.34 (212)	21.61 (549)	23.43 (595)	0.66 (17)	2.95 (75)	4.13 (105)				
		SPG 240-MF2	7.87 (200)	1.57 (40)	11.41 (290)	9.53 (242)	22.80 (579)	24.65 (626)		3.34 (85)	5.11 (130)				
	1FT6105	SPG 210-MF2	7.08 (180)	1.49 (38)	9.84 (250)	8.34 (212)	24.57 (624)	26.38 (670)		2.95 (75)	4.13 (105)				
		SPG 240-MF2	7.87 (200)	1.57 (40)	11.41 (290)	9.53 (242)	25.75 (654)	27.56 (700)		3.34 (85)	5.11 (130)				
	1FT6108	SPG 240-MF2					29.69 (754)	31.5 (800)							

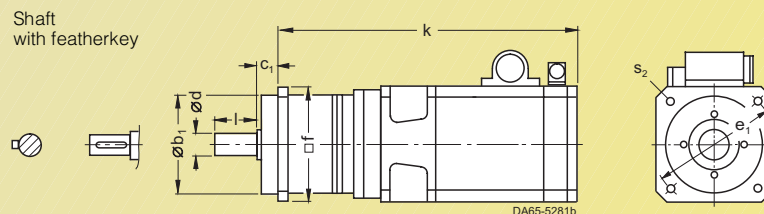

1) Motors with encoder.



Synchronous Servomotors

Servomotors Dimension Drawings

1FT6 motors, water-cooled

For motor		Dimension in inches (mm)									Plug						
Size	Type	DIN	a ₁	b ₁	c ₁	e ₁	f	f ₁	g ₂	g ₂	g ₂	h	i ₂	p	s ₂ ¹⁾	s ₂ ²⁾	o
		IEC	P	N	LA	M	AB	T	-	-	-	H	-	HD	S	S	-
Type of construction IM B 5, water-cooled, with plug, with/without brake																	
63	1FT6062 1FT6064		5.75 (146)	4.33 (110)	0.39 (10)	5.12 (130)	4.57 (116)	0.14 (3.5)	10.8 (99)	-	-	2.28 (58)	1.97 (50)	-	0.35 (9)	M 8	-
80	1FT6084 1FT6086		7.64 (194)	5.12 (130)	0.47 (12)	6.5 (165)	6.1 (155)	0.14 (3.5)	-	5.49 (139.5)	6.04 (153.5)	3.05 (77.5)	2.28 (58)	-	0.43 (11)	M 10	2.99 (76)

Size	Type	DIN IEC	sin/cos incremental encoder 1 V _{pp} /Resolver without brake		with brake		Re-solver with/without brake		En-coder		D-end of shaft			
			k LB	o ₁ -	k LB	o ₁ -	k LB	k LB	o ₁ -	d D	d ₆ -	l E	t GA	u F
63	1FT6062 1FT6064		-	-	-	-	9.96 (253)	11.14 (283)	8.94 (227)	0.94 (24)	M 8	1.97 (50)	1.06 (27)	0.31 (8)
80	1FT6084 1FT6086		11.65 (296)	7.4 (188)	13.46 (342)	9.21 (234)	-	-	-	1.26 (32)	M 12	2.28 (58)	1.38 (35)	0.39 (10)

1FT606 .

Shaft with featherkey

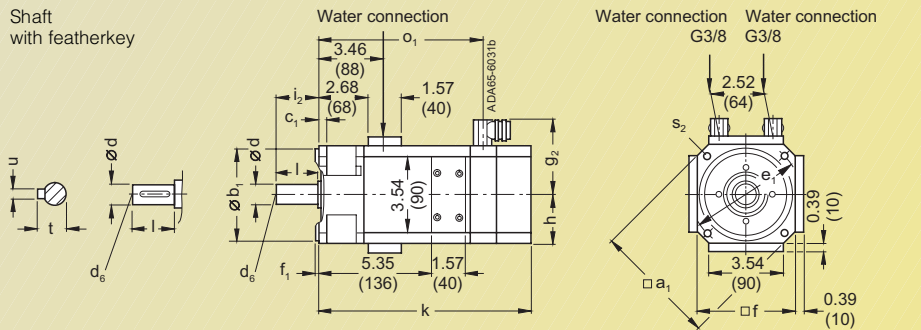

1FT608 .

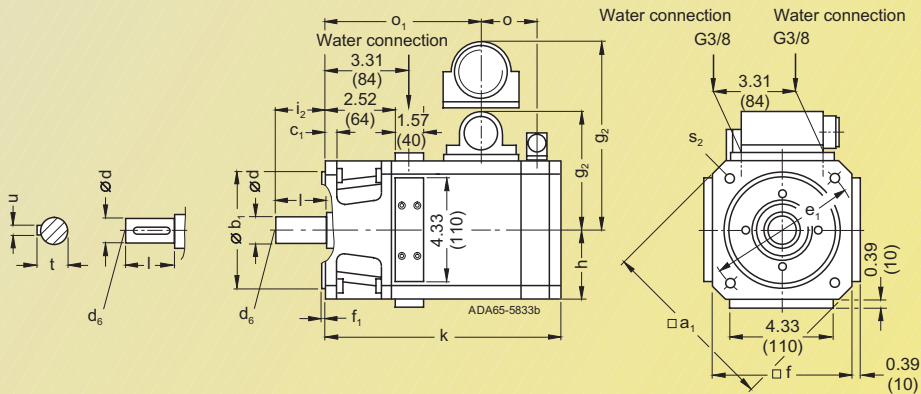

1) IM B 5. 2) IM B 14.

Servomotors Dimension Drawings

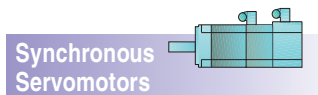

1FT6 motors, water-cooled

For motor		Dimension in inches (mm)								Plug								
Size	Type	DIN IEC							Size 1	1.5	3							
			a ₁ P	b ₁ N	c ₁ LA	e ₁ M	f AB	f ₁ T	g ₂ -	g ₂ -	g ₂ -	h H	i ₂ -	p HD	s ₂ ¹⁾ S	s ₂ ²⁾ S	o -	

Type of construction IM B 5, water-cooled, with plug, with/without brake																		
100	1FT6105		9.45 (240)	7.09 (180)	0.51 (13)	8.46 (215)	7.56 (192)	0.16 (4)	-	6.22 (158)	6.77 (172)	3.78 (96)	3.15 (80)	6.1 (155)	0.55 (14)	M12	2.99 (76)	
	1FT6108																	

Size	Type	DIN IEC	sin/cos incremental encoder 1 V _{pp} /Resolver				Re-solver			En-coder			D-end of shaft					
			without brake		with brake		with/without brake			with/without brake			d	d ₆	l	t	u	
			k LB	o ₁ -	k LB	o ₁ -	k LB	k LB	o ₁ -	d D	d ₆ -	l E	t GA	u F				
100	1FT6105		14.57 (370)	10.28 (261)	16.38 (416)	12.09 (307)	-	-	-	1.5 (38)	M 12	3.15 (80)	1.61 (41)	0.39 (10)				
	1FT6108		18.5 (470)	14.21 (361)	20.31 (516)	16.02 (407)	-	-	-									

1FT610 .

Shaft with featherkey

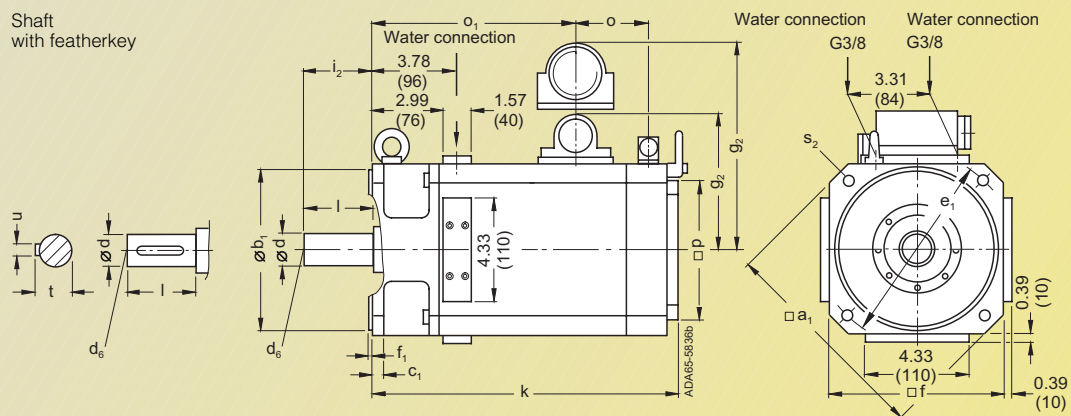

1) IM B 5. 2) IM B 14.

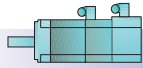

For motor		Dimension in inches (mm)														D-end of shaft	
Size	Type	DIN IEC	a ₁ P	b ₁ N	c ₁ LA	e ₁ M	f AB	f ₁ T	g AC	g ₂ -	h H	i ₂ LE	k LB	s ₂ S	d D	d ₆ DB	l E
Type of construction IM B 5 (sizes 71, 90) IM B 35 (sizes 112, 132), self-cooled, with terminal box																	
71	1FS6074		5.75 (146)	4.33 (110)	0.47 (12)	5.12 (130)	-	0.14 (3.5)	5.04 (128)	5.87 (149)	2.52 (64)	1.97 (50)	16.3 (414)	0.35 (9)	0.94 (24)	M 8	1.97 (50)
90	1FS6096		7.64 (194)	5.12 (130)	0.47 (12)	6.5 (165)	-	0.14 (3.5)	6.54 (166)	6.61 (168)	3.27 (83)	2.28 (58)	18.74 (476)	0.43 (11)	1.26 (32)	M 12	2.28 (58)
112	1FS6115		9.45 (240)	7.09 (180)	0.55 (14)	8.46 (215)	9.25 (235)	0.16 (4)	7.87 (200)	7.24 (184)	4.41 (112)	3.15 (80)	20.28 (515)	0.55 (14)	1.5 (38)	M 12	3.15 (80)
132	1FS6134		-	9.84 (250)	0.71 (18)	11.81 (300)	10.24 (260)	0.2 (5)	10.08 (256)	8.39 (213)	5.2 (132)	3.23 (82)	22.01 (559)	0.71 (18)	1.89 (48)	M 12	3.23 (82)

**1FS6074
1FS6096**

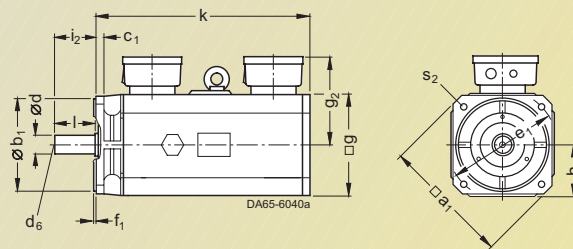

1FS6115

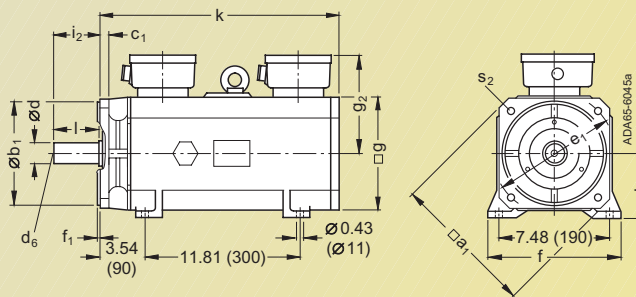

1FS6134

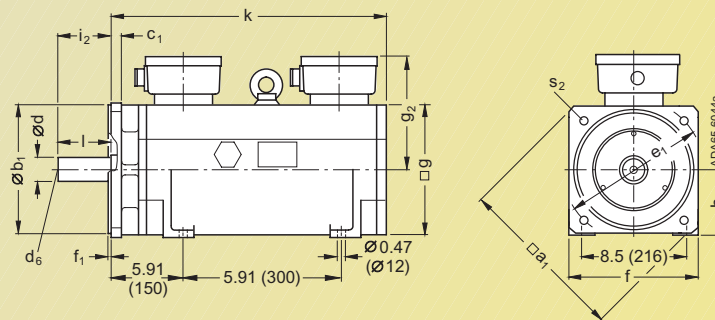

Servomotors Dimension Drawings

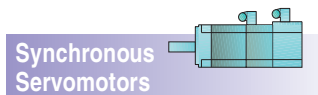

1FN3 AC linear motors

Primary section	Without precision cooling in (mm)		Without precision cooling		Length of primary side	Secondary section	Without precision cooling in (mm)		With precision cooling and cover		Length of secondary side
	Type	b_M	h_M	b_M			h_M	Type	b_S	h_S	
1FN3 AC linear motors, water-cooled											
1FN3 050-2W	2.64 (67)	1.91 (48.5)	2.99 (76)	2.5 (63.4)	10.4 (255)	1FN3 050-4SA00-0AA0	2.28 (58)	0.46 (11.8)	2.95 (75)	0.58 (14.8)	4.72 (120)
1FN3 100-2W	3.78 (96)	1.91 (48.5)	4.13 (105)	2.5 (63.4)	10.04 (255)	1FN3 100-4SA00-0AA0	3.46 (88)	0.46 (11.8)	4.13 (105)	0.58 (14.8)	4.72 (120)
1FN3 100-3W	3.78 (96)	1.91 (48.5)	4.13 (105)	2.5 (63.4)	14.17 (360)						
1FN3 100-4W	3.78 (96)	1.91 (48.5)	4.13 (105)	2.5 (63.4)	18.31 (465)						
1FN3 100-5W	3.78 (96)	1.91 (48.5)	4.13 (105)	2.5 (63.4)	22.44 (570)						
1FN3 150-2W	4.96 (126)	1.99 (50.5)	5.31 (135)	2.57 (65.4)	10.04 (25)	1FN3 150-4SA00-0AA0	4.65 (118)	0.54 (13.8)	5.31 (135)	0.66 (16.8)	4.72 (120)
1FN3 150-3W	4.96 (126)	1.99 (50.5)	5.31 (135)	2.57 (65.4)	14.17 (360)						
1FN3 150-4W	4.96 (126)	1.99 (50.5)	5.31 (135)	2.57 (65.4)	18.31 (465)						
1FN3 150-5W	4.96 (126)	1.99 (50.5)	5.31 (135)	2.57 (65.4)	22.44 (570)						
1FN3 300-2W	5.55 (141)	2.52 (64.1)	5.94 (151)	3.11 (79)	15.04 (382)	1FN3 300-4SA00-0AA0	5.28 (134)	0.65 (16.5)	5.94 (151)	0.77 (19.5)	7.24 (184)
1FN3 300-3W	5.55 (141)	2.52 (64.1)	5.94 (151)	3.11 (79)	21.38 (543)						
1FN3 300-4W	5.55 (141)	2.52 (64.1)	5.94 (151)	3.11 (79)	27.72 (704)						
1FN3 450-2W	7.4 (188)	2.6 (66.1)	7.76 (197)	3.19 (81)	15.04 (382)	1FN3 450-4SA00-0AA0	7.09 (180)	0.73 (18.5)	7.76 (197)	0.85 (21.5)	7.24 (184)
1FN3 450-3W	7.4 (188)	2.6 (66.1)	7.76 (197)	3.19 (81)	21.38 (543)						
1FN3 450-4W	7.4 (188)	2.6 (66.1)	7.76 (197)	3.19 (81)	27.72 (704)						
1FN3 600-3W	9.76 (248)	2.52 (64.1)	10.12 (257)	3.39 (86)	21.38 (543)	1FN3 600-4SA00-0AA0	9.45 (240)	0.65 (16.5)	9.72 (247)	1.04 (26.5)	7.24 (184)
1FN3 600-4W	9.76 (248)	2.52 (64.1)	10.12 (257)	3.39 (86)	27.72 (704)						
1FN3 900-2W	13.46 (342)	2.6 (66.1)	13.82 (351)	3.46 (88)	15.04 (382)	1FN3 900-4SA00-0AA0	13.15 (334)	0.73 (18.5)	13.43 (341)	1.12 (28.5)	7.24 (184)
1FN3 900-4W	13.46 (342)	2.6 (66.1)	13.82 (351)	3.46 (88)	27.72 (704)						

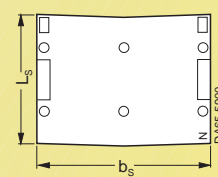
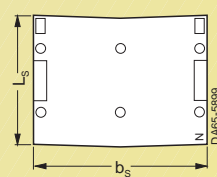
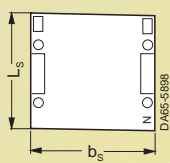
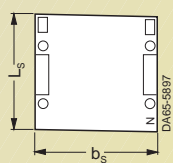
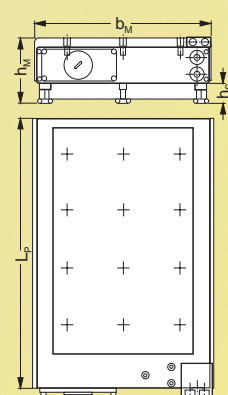
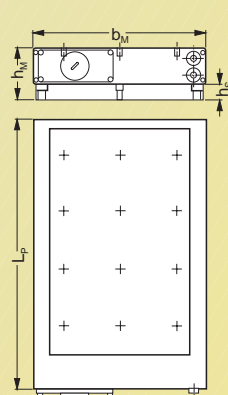
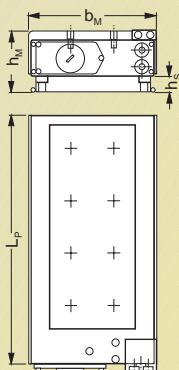
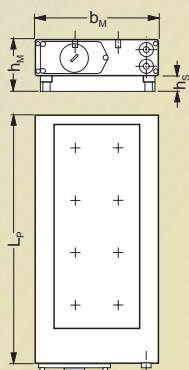

Without precision cooling

With precision cooling

Without precision cooling

With precision cooling

Sizes 1FN3 050 through 1FN3 450

Sizes 1FN3 600 through 1FN3 900

Note: 4-row drilling plate for 1FN3 900 for primary section fitting



Asynchronous
Servomotors

For motor		Dimension in inches (mm)																	D-end of shaft				
Size	Type	DIN IEC	a B	b A	c LA	e M	f AB	h H	k LB	k ₁ -	m BA	m ₁ -	m ₂ -	n AA	p HD	s K	s ₃ -	w ₁ C	d D	d ₆ -	l E	t GA	u F
Type of construction IM B 3																							
100	1PH7101		7.97 (202.5)	6.2 (160)	0.43 (11)	10.35 (263)	7.7 (196)	3.9 (100)	16.18 (411)	17.09 (434)	2.04 (52)	2.51 (64)	1.06 (27)	1.53 (39)	8.6 (220)	0.47 (12)	Pg 29	1.57 (40)	1.49 (38)	M 12	3.14 (80)	1.61 (41)	0.39 (10)
	1PH7103																						
	1PH7105		11.71 (297.5)			14.09 (358)			19.92 (506)	20.83 (529)													
	1PH7107																						
132	1PH7131		10.45 (265.5)	8.5 (216)	0.55 (14)	13.42 (341)	10.2 (260)	5.1 (132)	21.18 (538)	22.09 (561)	2.48 (63)	2.95 (75)	1.29 (33)	2.04 (52)	10.8 (275)	0.47 (12)	Pg 36	1.96 (50)	1.65 (42)	M 16	4.33 (110)	1.77 (45)	0.47 (12)
	1PH7133																						
	1PH7135		13.79 (350.5)			16.77 (426)			24.53 (623)	25.43 (646)													
	1PH7137																						
160	1PH7163		13.64 (346.5)	10 (254)	0.66 (17)	17.24 (438)	12.3 (314)	6.2 (160)	25.2 (640)	26.1 (663)	3.07 (78)	3.18 (81)	1.65 (42)	2.44 (62)	12.9 (330)	0.47 (14)	Pg 42	2.51 (64)	2.16 (55)	M 20	4.33 (110)	2.32 (59)	0.62 (16)
	1PH7167		16 (406.5)			19.6 (498)			27.56 (700)	28.46 (723)													

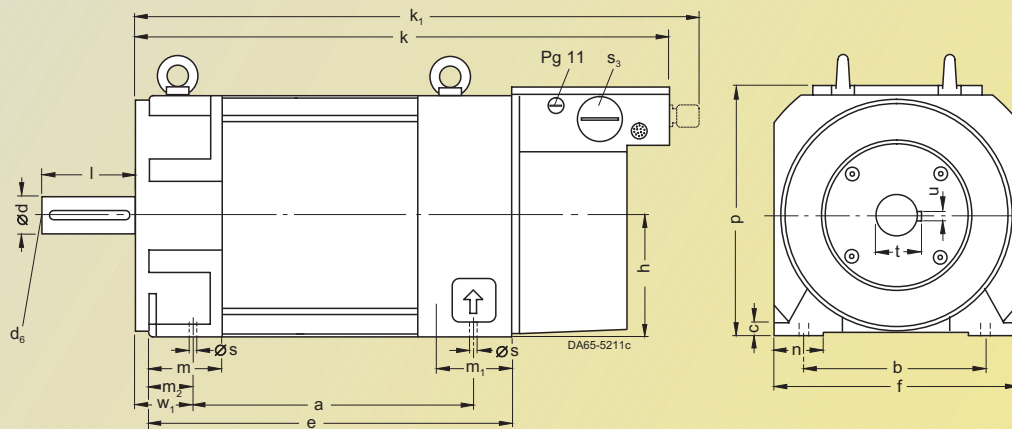

Servomotors

Dimension Drawings

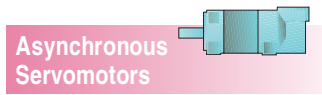

1PH7 motors

For motor		Dimension in inches (mm)																		
Size	Type	DIN IEC	a B	b A	c LA	e M	f AB	g AC	h H	k LB	k ₁ -	m BA	m ₁ -	m ₂ -	n AA	o -	p ¹⁾ HD	s K	w ₁ C	
Type of construction IM B 3, air flow from D-end to ND-end																				
180	1PH7184		16.9 (430)	10.9 (279)	0.55 (14)	20 (510)	14.1 (360)	15.5 (395)	7 (180)	32.28 (820)	-	2.04 (52)	4.3 (110)	1.37 (35)	2.55 (65)	21.2 (541)	19.6 (500)	0.57 (14.5)	4.7 (121)	
	1PH7186		20.4 (520)			23.6 (600)				35.83 (910)						24.8 (631)	22.1 (560)			
225	1PH7224		17.5 (445)	14 (356)	0.7 (18)	21.2 (540)	17.7 (450)	19.4 (495)	8.8 (225)	-	43.31 (1100)	2.36 (60)	4.3 (110)	1.57 (40)	3.34 (85)	24.7 (629)	26.8 (680)	0.72 (18.5)	5.8 (149)	
	1PH7226		21.4 (545)			25.1 (640)					47.24 (1200)					28.7 (729)				
	1PH7228		25 (635)			28.7 (730)					50.79 (1290)					32.2 (819)				

		D-end of shaft					
Size	Type	DIN IEC	d D	d ₆ -	l E	t GA	u F
180	1PH7184		2.36 (60)	M 20	5.5 (140)	2.5 (64)	0.7 (18)
	1PH7186		2.55 (65)			2.7 (69)	
225	1PH7224		2.95 (75)	M 20	5.5 (140)	3.1 (79.5)	0.8 (20)
	1PH7226						
	1PH7228						

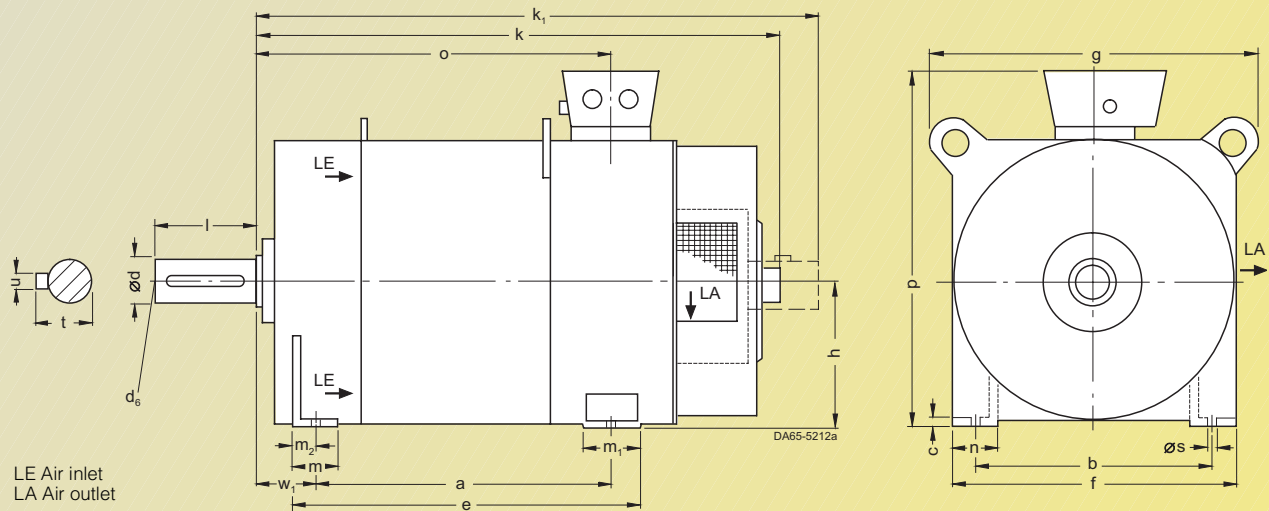

1) Maximum dimensions. Depending on the electrical design (terminal box type) smaller dimensions are also possible.



Asynchronous Servomotors

For motor		Dimension in inches (mm)																	
Size	Type	DIN IEC	a B	b A	c LA	e M	f AB	g AC	h H	k LB	m BA	m ₁ -	m ₂ -	n AA	o -	p ¹⁾ HD	s K	w ₁ C	
Type of construction IM B 3, air flow from ND-end to D-end																			
180	1PH7184		16.93 (430)	10.98 (279)	0.55 (14)	20.08 (510)	14.17 (360)	15.55 (395)	7.09 (180)	39.76 (1010)	2.05 (52)	4.33 (110)	1.38 (35)	2.55 (65)	21.3 (541)	19.69 (500)	0.57 (14.5)	4.76 (121)	
	1PH7186		20.47 (520)			23.62 (600)				43.31 (1100)					24.84 (631)	22.05 (560)			
225	1PH7224		17.52 (445)	14.02 (356)	0.71 (18)	21.26 (540)	17.72 (450)	19.49 (495)	8.86 (225)	43.7 (1110)	2.36 (60)	4.33 (110)	3.35 (85)	3.35 (85)	24.76 (629)	26.77 (680)	0.73 (18.5)	5.87 (149)	
	1PH7226		21.46 (545)			25.2 (640)				47.64 (1210)					28.7 (729)				
	1PH7228		25 (635)			28.74 (730)				51.18 (1300)					32.24 (819)				

For motor		D-end of shaft					
Size	Type	DIN IEC	d D	d ₆ -	l E	t GA	u F
180	1PH7184		2.36 (60)	M 20	5.51 (140)	2.52 (64)	0.71 (18)
	1PH7186		2.56 (65)			2.72 (69)	
225	1PH7224		2.95 (75)	M 20	5.51 (140)	3.13 (79.5)	0.79 (20)
	1PH7226						
	1PH7228						

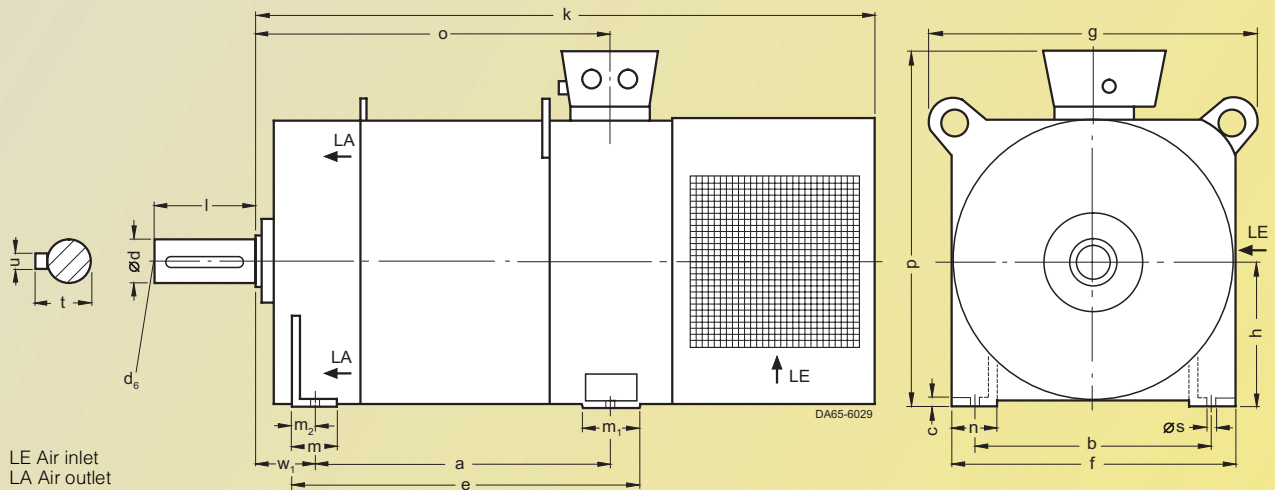

1) Maximum dimensions. Depending on the electrical design (terminal box type) smaller dimensions are also possible.

Servomotors Dimension Drawings

Asynchronous
Servomotors



1PH7 motors

For motor Dimension in inches (mm)

Size	Type	DIN IEC	a B	b A	c HA	e BB	f AB	g ₂ AD	g ₄ -	h H	k LB	k ₁ -	k ₂ -	m ₁ -	m ₂ -	n AA	o -	p ₂ -	s K	w ₁ C
Type of construction IM B 3																				
280	1PH7284		26.93 (684)	17.99 (457)	0.87 (22)	33.07 (840)	22.05 (560)	20.47 (520)	17.68 (449)	11.02 (280)	45.28 (1150)	19.29 (490)	21.06 (535)	4.25 (108)	3.15 (80)	3.94 (100)	28.74 (730)	41.02 (1042)	0.94 (24)	7.48 (190)
	1PH7286		31.26 (794)			37.4 (950)					49.61 (1260)	23.62 (600)					33.07 (840)			
	1PH7288		36.38 (924)			42.52 (1080)					54.72 (1390)	28.74 (730)					38.19 (970)			

D-end of shaft

Size	Type	DIN IEC	d D	l E	t GA	u FA
280	1PH7284		3.74 (95)	6.69 (170)	3.94 (100)	0.98 (25)
	1PH7286					
	1PH7288					

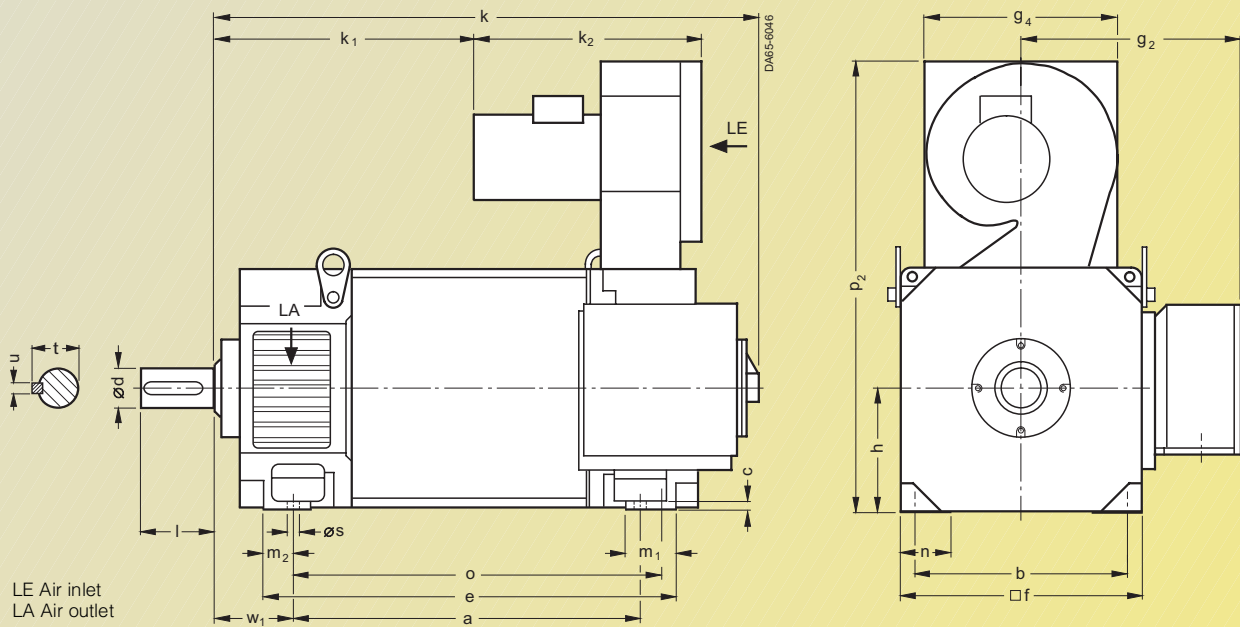



Asynchronous Servomotors

For motor		Dimension in inches (mm)													D-end of shaft				
Size	Type	DIN IEC	a ₁ P	b ₁ N	c ₁ LA	e ₁ M	f AB	f ₁ T	i ₂ -	k LB	k ₁ -	p HD	s ₂ S	s ₃ -	d D	d ₆ -	l E	t GA	u F
Type of construction IM B 5																			
100	1PH7101		9.84 (250)	7.08 (180)	0.39 (10)	8.46 (215)	7.71 (196)	0.15 (4)	3.14 (80)	16.18 (411)	17.13 (435)	8.58 (218)	0.55 (14)	Pg 29	1.49 (38)	M 12	3.14 (80)	1.61 (419)	0.38 (10)
	1PH7103																		
	1PH7105									19.92 (506)	20.83 (529)								
	1PH7107																		
132	1PH7131		13.77 (350)	9.84 (250)	0.62 (16)	11.81 (300)	10.23 (260)	0.19 (5)	4.33 (110)	21.18 (538)	20.09 (561)	10.74 (273)	0.7 (18)	Pg 36	1.65 (42)	M 16	4.33 (110)	1.77 (45)	0.47 (12)
	1PH7133																		
	1PH7135									24.53 (623)	25.43 (646)								
	1PH7137																		

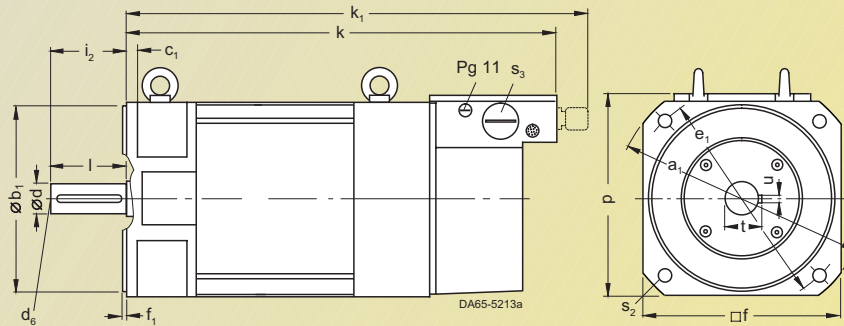

Servomotors Dimension Drawings

Asynchronous
Servomotors



1PH7 motors

For motor Dimension in inches (mm)

Size	Type	DIN IEC	a B	a ₁ P	b A	b ₁ N	c LA	e ₁ M	f AB	f ₁ T	h H	i ₂ -	k LB	k ₁ -	m BA	m ₁ -	m ₂ -	n AA	p HD
Type of construction IM B 35																			
100	1PH7101		7.97 (202.5)	9.84 (250)	6.29 (160)	7.08 (180)	0.4 (11)	8.4 (215)	7.7 (196)	0.1 (4)	3.93 (100)	3.14 (80)	16.18 (411)	17.13 (435)	2.04 (52)	2.5 (64)	1.06 (27)	1.53 (39)	8.66 (220)
	1PH7103																		
	1PH7105		11.71 (297.5)											19.92 (506)	20.83 (529)				
	1PH7107																		
132	1PH7131		10.45 (265.5)	13.77 (350)	8.5 (216)	9.84 (250)	0.5 (14)	11.8 (300)	10.2 (260)	0.2 (5)	5.19 (132)	4.33 (110)	21.18 (538)	22.09 (561)	2.48 (63)	2.9 (75)	1.29 (33)	2.04 (52)	10.8 (275)
	1PH7133																		
	1PH7135		13.79 (350.5)											24.53 (623)	25.43 (646)				
	1PH7137																		
160	1PH7163		13.64 (346.5)	15.74 (400)	10 (254)	11.8 (300)	0.6 (17)	13.7 (350)	12.3 (314)	0.2 (5)	6.29 (160)	4.33 (110)	25.2 (640)	26.1 (663)	3.07 (78)	3.1 (81)	1.65 (42)	2.44 (62)	12.9 (330)
	1PH7167		16 (406.5)										27.56 (700)	28.46 (723)					

D-end of shaft

Size	Type	DIN IEC	s K	s ₂ S	s ₃ -	w ₁ C	d D	d ₆ -	l E	t GA	u F
100	1PH7101		0.47 (12)	0.55 (14)	Pg 29	1.57 (40)	1.49 (38)	M 12	3.14 (80)	1.61 (41)	0.39 (10)
	1PH7103										
	1PH7105										
	1PH7107										
132	1PH7131		0.47 (12)	0.7 (18)	Pg 36	1.96 (50)	1.65 (42)	M 16	4.33 (110)	1.77 (45)	0.47 (12)
	1PH7133										
	1PH7135										
	1PH7137										
160	1PH7163		0.47 (14)	0.7 (18)	Pg 42	2.51 (64)	2.16 (55)	M 20	4.33 (110)	2.32 (59)	0.62 (16)
	1PH7167										

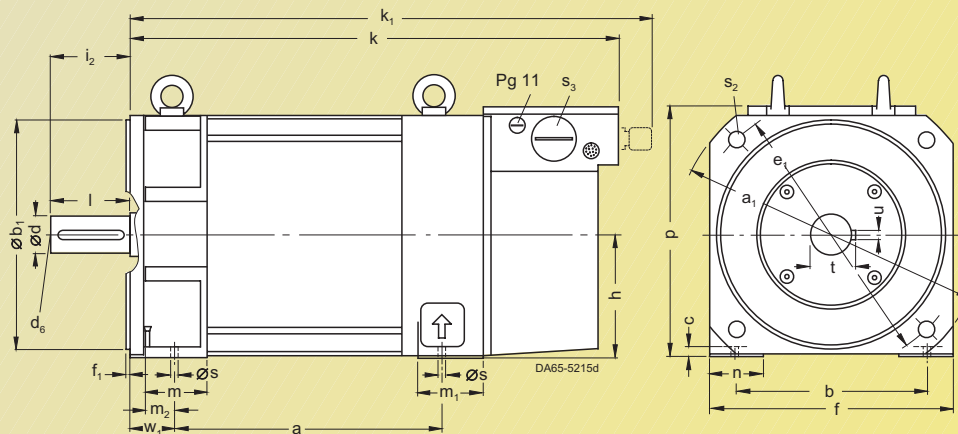



Asynchronous
Servomotors

For motor		Dimension in inches (mm)											For dimensions for foot mounting, shaft and terminal box, see dimension drawing of 1PH718. and 1PH722. motors, type of construction IM B 3, on page 8/24.	
Size	Type	DIN IEC	a ₁ P	b ₁ N	c ₁ LA	e ₁ M	f ₁ T	h H	k LB	k ₁ -	p ¹⁾ HD	z -	α -	
Type of construction IM B 35, air flow from D-end to ND-end														
180	1PH7184 ²⁾		15.75 (400)	11.8 (300)	0.59 (15)	13.77 (350)	0.19 (5)	7.08 (180)	32.28 (820)	-	19.68 (500)	0.16 (4)	45°	
	1PH7184 ²⁾		17.71 (450)	13.77 (350)	0.62 (16)	15.74 (400)			32.28 (820)		19.68 (500)	0.31 (8)	22.5°	
	1PH7186								35.83 (910)		22.05 (560)			
225	1PH7224		21.65 (550)	17.71 (450)	0.7 (18)	19.68 (500)	0.19 (5)	8.85 (225)	-	43.31 (1100)	25.59 (680)	0.31 (8)	22.5°	
	1PH7226									47.24 (1200)				
	1PH7228									50.79 (1290)				

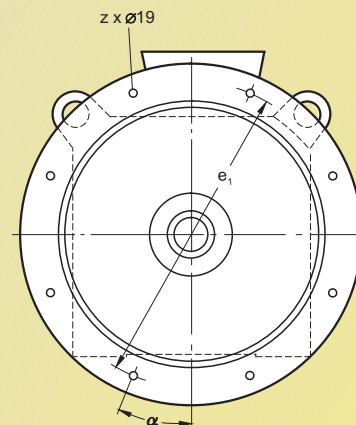
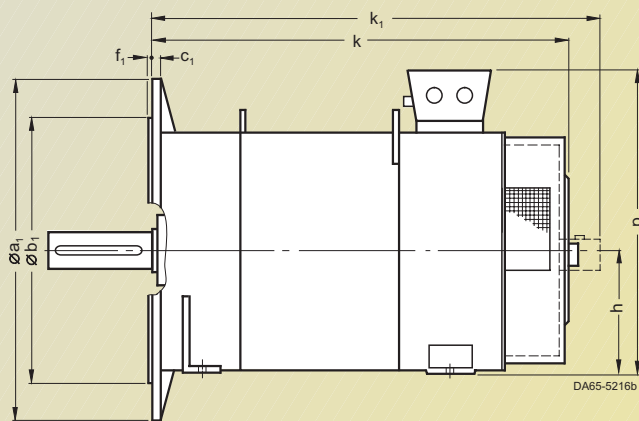

For motor		Dimension in inches (mm)											For dimensions for foot mounting, shaft and terminal box, see dimension drawing of 1PH718. and 1PH722. motors, type of construction IM B 3, on page 8/25.	
Size	Type	DIN IEC	a ₁ P	b ₁ N	c ₁ LA	e ₁ M	f ₁ T	h H	k LB	p ¹⁾ HD	z -	α -		
Type of construction IM B 35, air flow from ND-end to D-end														
180	1PH7184 ²⁾		15.75 (400)	11.81 (300)	0.59 (15)	13.78 (350)	0.2 (5)	7.09 (180)	39.76 (1010)	19.69 (500)	0.16 (4)	45°		
	1PH7184 ²⁾		17.72 (450)	13.78 (350)	0.63 (16)	15.75 (400)	0.2 (5)	7.09 (180)	39.76 (1010)	19.69 (500)	0.31 (8)	22.5°		
	1PH7186								43.31 (1100)	22.05 (560)				
225	1PH7224		21.65 (550)	17.72 (450)	0.71 (18)	19.69 (500)	0.2 (5)	8.86 (225)	43.7 (1110)	26.77 (680)	0.31 (8)	22.5°		
	1PH7226								47.64 (1210)					
	1PH7228								51.18 (1300)					

LE Air inlet
LA Air outlet

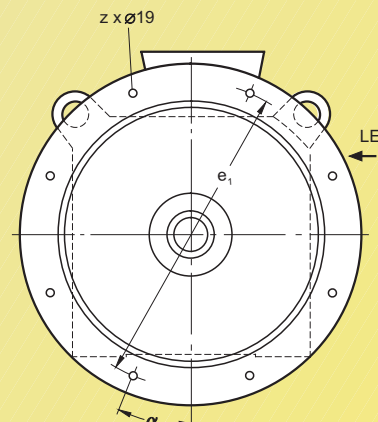
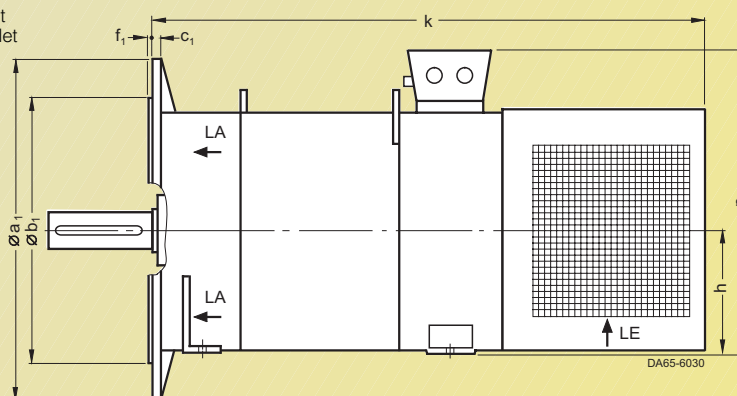

1) Maximum dimensions. Depending on the electrical design (terminal box type) smaller dimensions are also possible.

2) See Order No. suffix on page 3/17.

Servomotors Dimension Drawings

1PH7 motors

Asynchronous
Servomotors

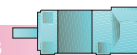

For motor Dimension in inches (mm)

For dimensions for foot mounting, shaft and terminal box, see dimension drawing of 1PH728. motors, type of construction IM B 3, on page 8/26.

Size	Type	DIN IEC	a ₁ P	b ₁ N	c ₁ LA	e ₁ M	f ₁ T	h H	i ₂ -	k LB	k ₁ -	p ₂ -
Type of construction IM B 35												
280	1PH7284		25.98 (660)	21.65 (550)	0.94 (24)	23.62 (600)	0.24 (6)	11.02 (280)	6.69 (170)	45.28 (1150)	19.29 (490)	41.02 (1042)
	1PH7286									49.61 (1260)	23.62 (600)	
	1PH7288									54.72 (1390)	28.74 (730)	

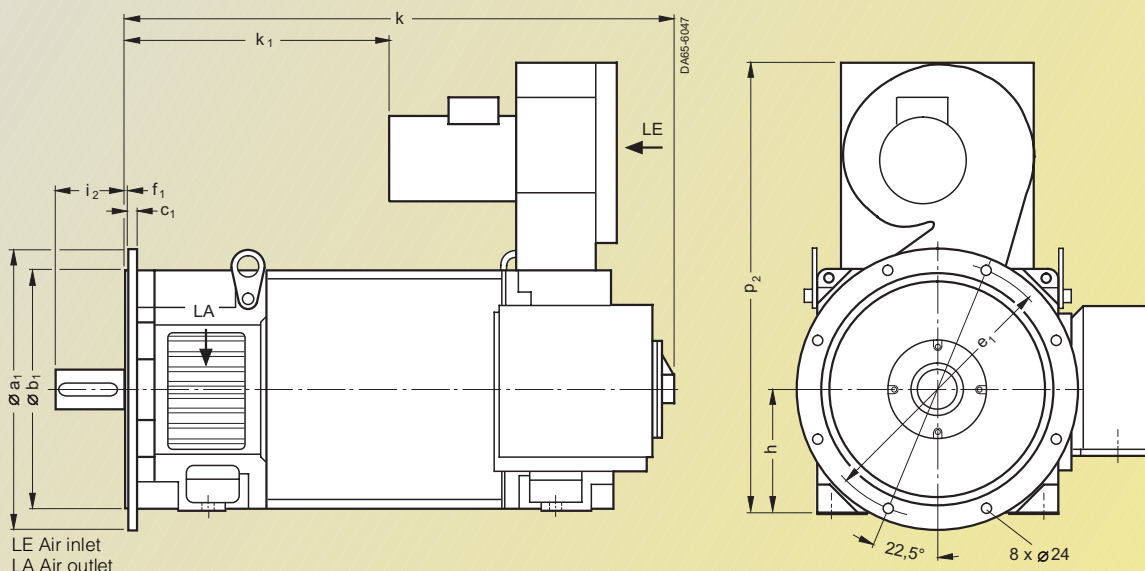

For motor Dimension in inches (mm)

D-end of shaft

Size	Type	DIN IEC	a ₁ P	b ₁ N	c ₁ LA	e ₁ M	f AB	f ₁ T	f ₂ -	g ₂ AB	g ₃ T	i ₂ -	k LB	k ₁ -	p HD	s ₂ S	s ₃ S	d D	d ₆ -	l E	t GA	u F
Type of construction IM B 5 with brake module																						
100	1PH7101		9.84 (250)	7.08 (180)	0.51 (13)	8.46 (215)	7.71 (196)	0.15 (4)	8.66 (220)	5.86 (149)	8.81 (224)	3.14 (80)	21.3 (541)	22.2 (564)	4.72 (120)	0.55 (14)	Pg 29	1.49 (38)	M 12	3.14 (80)	1.61 (41)	0.39 (10)
	1PH7103																					
	1PH7105												25.04 (636)	25.94 (659)								
	1PH7107																					
132	1PH7131		-	9.84 (250)	0.7 (18)	11.81 (300)	10.23 (260)	0.19 (5)	10.94 (278)	6.85 (174)	10.59 (269)	4.33 (110)	27.56 (700)	28.46 (723)	5.62 (143)	0.7 (18)	Pg 36	1.65 (42)	M 16	4.33 (110)	1.77 (45)	0.47 (12)
	1PH7133																					
	1PH7135												30.9 (785)	31.81 (808)								
	1PH7137																					

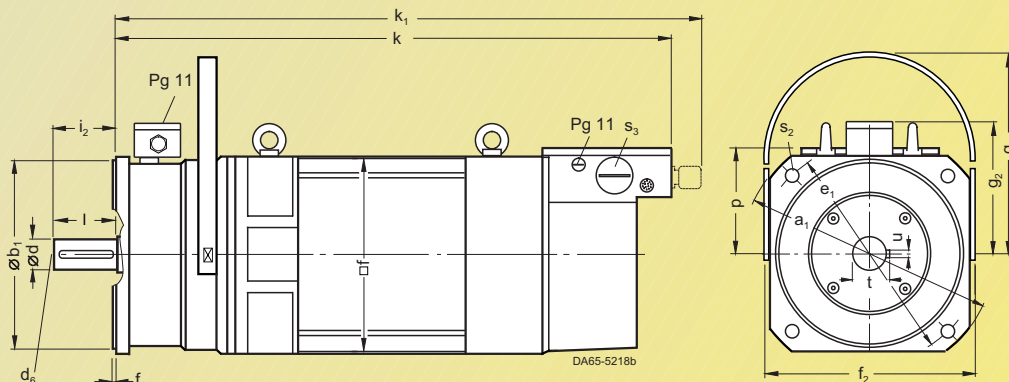



Asynchronous
Servomotors

For motor		Dimension in inches (mm)																
Size	Type	DIN IEC	a B	a ₁ P	b A	b ₁ N	c LA	e ₁ M	f AB	f ₁ T	f ₂ -	g ₂ -	g ₃ -	h H	i ₂ -	k LB	k ₁ -	
Type of construction IM B 35, with brake module																		
100	1PH7101		7.97 (202.5)	9.84 (250)	6.29 (160)	(180)	0.4 (11)	8.46 (215)	7.71 (196)	0.5 (4)	8.66 (220)	5.86 (149)	8.81 (224)	3.93 (100)	3.15 (80)	21.3 (541)	22.2 (564)	
	1PH7103																	
	1PH7105		11.71 (297.5)														25.04 (636)	25.94 (659)
	1PH7107																	
132	1PH7131		10.43 (265)	-	8.5 (216)	9.84 (250)	0.5 (14)	11.8 (300)	10.2 (260)	0.2 (5)	10.9 (278)	6.85 (174)	10.59 (269)	5.19 (132)	4.33 (110)	27.56 (700)	28.46 (723)	
	1PH7133																	
	1PH7135		13.79 (350.5)														30.91 (785)	31.81 (808)
	1PH7137																	
160	1PH7163		13.64 (346.5)	15.7 (400)	10 (254)	11.8 (300)	0.6 (17)	13.78 (350)	12.3 (314)	0.21 (5)	12.87 (327)	7.83 (199)	12.9 (328)	6.29 (160)	4.33 (110)	31.81 (808)	32.72 (831)	
	1PH7167		16 (406.5)													34.17 (868)	35.08 (891)	

		D-end of shaft															
Size	Type	DIN IEC	m BA	m ₁ -	m ₂ -	n AA	p -	s K	s ₂ -	s ₃ -	w ₁ C	d D	d ₆ -	l E	t GA	u F	
100	1PH7101		2.1 (52)	2.5 (64)	1.1 (27)	1.5 (39)	8.66 (220)	0.5 (12)	0.6 (14)	Pg 29	6.69 (170)	1.5 (38)	M 12	3.14 (80)	1.6 (41)	0.4 (10)	
	1PH7103																
	1PH7105																
	1PH7107																
132	1PH7131		2.5 (63)	2.9 (75)	1.3 (33)	2 (52)	10.8 (275)	0.5 (12)	0.7 (18)	Pg 36	8.34 (212)	1.6 (42)	M 16	4.33 (110)	1.7 (45)	0.5 (12)	
	1PH7133																
	1PH7135																
	1PH7137																
160	1PH7163		3 (78)	3.1 (81)	1.6 (42)	2.4 (62)	12.9 (330)	0.6 (14)	0.7 (18)	Pg 42	9.13 (232)	2.1 (55)	M 20	4.33 (110)	2.3 (59)	0.6 (16)	
	1PH7167																

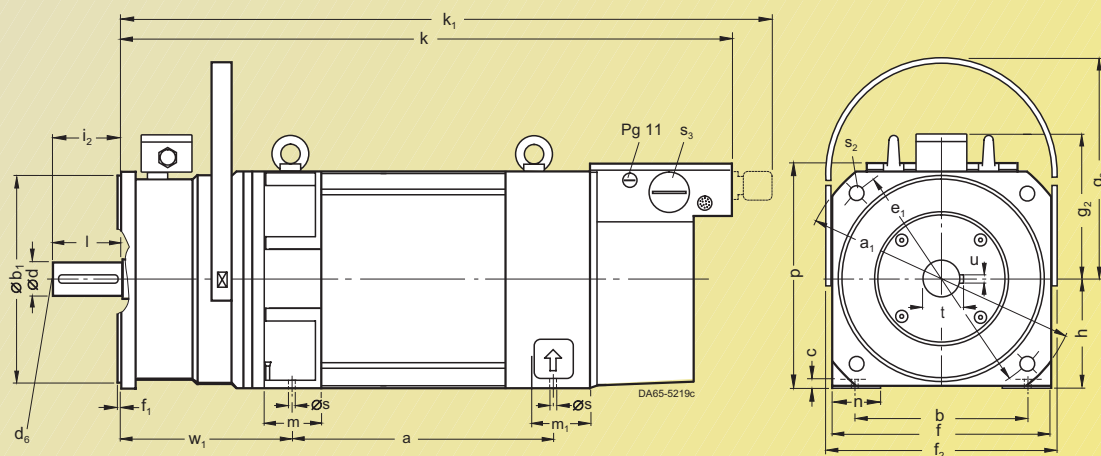

Servomotors Dimension Drawings

Asynchronous
Servomotors



1PH7 motors

For motor		Dimension in inches (mm)																		D-end of shaft				
Size	Type	DIN IEC	a B	b A	c LA	e M	f AB	g AC	h H	k LB	m BA	m ₁ -	m ₂ -	n AA	o -	p ¹⁾ -	p _B -	s K	w ₁ C	d D	d ₆ -	l E	t GA	u F
Type of construction IM B 3, with brake module																								
180	1PH7184		16.9 (430)	10.9 (279)	0.55 (14)	20 (510)	14.1 (360)	15.5 (395)	7.1 (180)	36.6 (930)	2.04 (52)	4.3 (110)	1.4 (35)	2.5 (65)	25.3 (644)	19.7 (500)	15.3 (390)	0.6 (14.5)	8.8 (224)	3.5 (90)	M 20	3.5 (90)	3.7 (95)	0.98 (25)
	1PH7186		20.4 (520)			23.6 (600)				40.16 (1020)					28.9 (734)	22 (560)								
225	1PH7224		17.5 (445)	14 (356)	0.7 (18)	21.2 (540)	17.7 (450)	19.5 (495)	8.8 (225)	48.43 (1230)	2.34 (60)	4.3 (110)	1.6 (40)	3.1 (80)	30.9 (785)	26.8 (680)	17.7 (450)	0.7 (18.5)	10.9 (278)	3.9 (100)	M 20	3.9 (100)	4.2 (106)	1.1 (28)
	1PH7226		21.4 (545)			25.2 (640)				52.36 (1330)					33.8 (858)									
	1PH7228		25 (635)			28.7 (730)				55.9 (1420)					37.3 (948)									

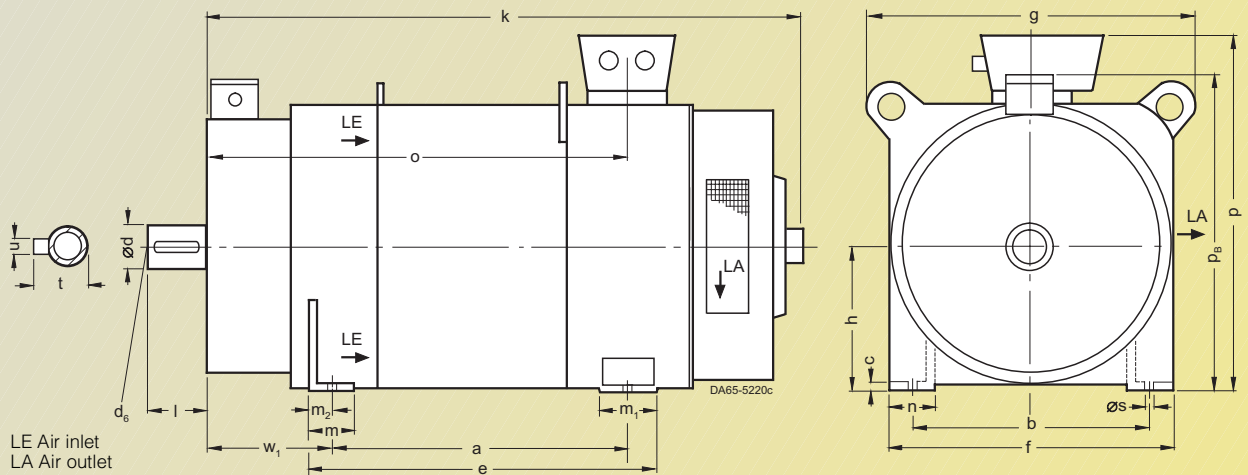

1) Maximum dimensions. Depending on the electrical design (terminal box type) smaller dimensions are also possible.



Asynchronous
Servomotors

For motor		Dimension in inches (mm)														
Size	Type	DIN IEC	a B	b A	c LA	e M	f AB	h H	k LB	k ₁ -	m BA	m ₁ -	m ₂ -	n AA	o -	p HD
Type of construction IM B 3, with pipe connection at ND-end																
100	1PH7101		7.9 (202.5)	6.3 (160)	0.4 (11)	10.3 (263)	7.7 (196)	3.9 (100)	16.18 (411)	17.36 (441)	2 (52)	2.5 (64)	1.1 (27)	1.5 (39)	6.3 (161)	8.6 (220)
	1PH7103															
	1PH7105		11.7 (297.5)				14.1 (358)			19.92 (506)	21.1 (536)					
132	1PH7131		10.4 (265.5)	8.5 (216)	0.5 (14)	13.4 (341)	10.2 (260)	5.1 (132)	21.18 (538)	22.56 (573)	2.5 (63)	2.9 (75)	1.3 (33)	2 (52)	8.3 (211.5)	10.8 (275)
	1PH7133															
	1PH7135		13.8 (350.5)				16.7 (426)			24.53 (623)	25.91 (658)					
160	1PH7163		13.6 (346.5)	10 (254)	0.6 (17)	17.2 (438)	12.3 (314)	6.3 (160)	25.2 (640)	26.54 (674)	3.1 (78)	3.2 (81)	1.6 (42)	2.4 (62)	9.9 (253)	12.9 (330)
	1PH7167		16 (406.5)			19.6 (498)			27.56 (700)	28.9 (734)						

		D-end of shaft									
Size	Type	DIN IEC	s K	s ₃ -	v -	w ₁ C	d D	d ₆ -	l E	t GA	u F
100	1PH7101		0.5 (12)	Pg 29	0.4 (10.5)	1.6 (40)	1.5 (38)	M 12	3.1 (80)	1.6 (41)	0.4 (10)
	1PH7103										
	1PH7105										
132	1PH7131		0.5 (12)	Pg 36	0.7 (17)	1.9 (50)	1.6 (42)	M 16	4.3 (110)	1.7 (45)	0.5 (12)
	1PH7133										
	1PH7135										
160	1PH7163		0.6 (14)	Pg 42	0.7 (17)	2.5 (64)	2.2 (55)	M 20	4.3 (110)	2.2 (56)	0.6 (16)
	1PH7167										

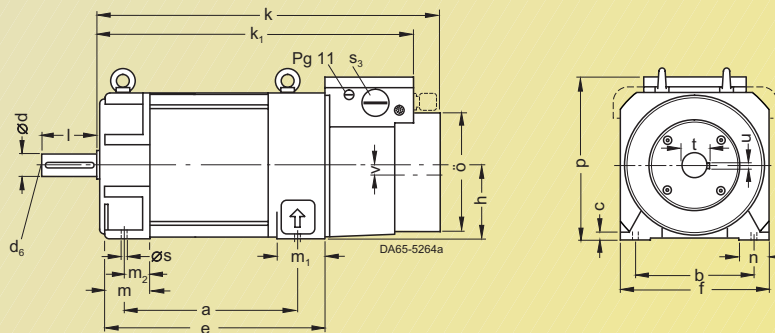

Servomotors Dimension Drawings

Asynchronous
Servomotors

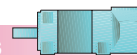

1PH7 motors

For motor		Dimension in inches (mm)															D-end of shaft							
Size	Type	DIN IEC	a B	b A	c LA	e M	f AB	g AC	h H	k LB	m BA	m ₁ -	m ₂ -	n AA	o -	p ¹⁾ -	s K	w ₁ C	d D	d ₆ -	l E	t GA	u F	
Type of construction IM B 3, with pipe connection at ND-end																								
180	1PH7184	16.9 (430)	10.9 (279)	0.5 (14)	20.1 (510)	14.2 (360)	15.5 (395)	7.1 (180)	32.68 (830)	2 (52)	4.3 (110)	1.4 (35)	2.5 (65)	21.3 (541)	19.7 (500)	0.6 (14.5)	4.8 (121)	2.4 (60)	M 20	5.5 (140)	2.5 (64)	0.7 (18)		
	1PH7186	20.5 (520)			23.6 (600)				36.22 (920)									2.5 (65)			2.7 (69)			
225	1PH7224	17.5 (445)	14 (356)	0.7 (18)	21.2 (540)	17.7 (450)	19.5 (495)	8.8 (225)	37.4 (950)	2.4 (60)	4.3 (110)	1.6 (40)	3.1 (80)	24.7 (629)	26.77 (680)	0.7 (18.5)	5.9 (149)	2.9 (75)	M 20	5.5 (140)	3.1 (79.5)	0.8 (20)		
	1PH7226	21.4 (545)			25.1 (640)				41.34 (1050)									28.7 (729)						
	1PH7228	25 (635)			28.7 (730)				44.88 (1140)									32.2 (819)						

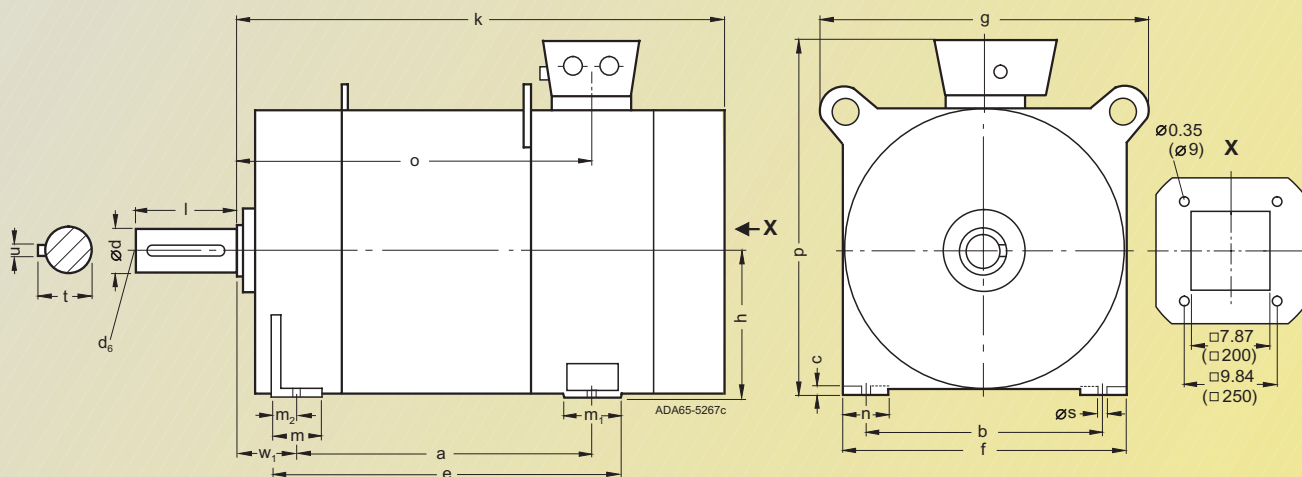

1) Maximum dimensions. Depending on the electrical design (terminal box type) smaller dimensions are also possible.



Asynchronous
Servomotors

For motor		Dimension in inches (mm)																
Size	Type	DIN IEC	a B	a ₁ P	b A	b ₁ N	c LA	c ₁ -	e ₁ -	f AB	f ₁ T	h H	k LB	k ₁ -	m BA	m ₁ -	m ₂ -	
Type of construction IM B 35, with pipe connection at ND-end																		
100	1PH7101		7.9 (202.5)	9.8 (250)	6.3 (160)	7.1 (180)	0.4 (11)	0.5 (13)	8.5 (215)	7.7 (196)	0.14 (4)	3.9 (100)	16.18 (411)	17.36 (441)	2 (52)	2.5 (64)	1.1 (27)	
	1PH7103												19.92 (506)	21.1 (536)				
	1PH7105		11.7 (297.5)															
	1PH7107																	
132	1PH7131		10.4 (265.5)	13.8 (350)	8.5 (216)	9.8 (250)	0.5 (14)	0.6 (17)	11.8 (300)	10.2 (260)	0.25 (5)	5.2 (132)	21.18 (538)	22.56 (573)	2.5 (63)	3.2 (75)	1.3 (33)	
	1PH7133												24.53 (623)	25.91 (658)				
	1PH7135		13.8 (350.5)															
	1PH7137																	
160	1PH7163		13.6 (346.5)	15.7 (400)	10 (254)	11.8 (300)	0.6 (17)	0.9 (22)	13.8 (350)	12.4 (314)	0.25 (5)	6.3 (160)	25.2 (640)	26.54 (674)	3.1 (78)	3.2 (81)	1.6 (42)	
	1PH7167		16 (406.5)										27.56 (700)	28.9 (734)				

		D-end of shaft														
Size	Type	DIN IEC	n AA	o -	p HD	s K	s ₂ K	s ₃ -	v -	w ₁ C	d D	d ₆ -	l E	t GA	u F	
100	1PH7101		1.5 (39)	6.3 (161)	8.7 (220)	0.5 (12)	0.6 (14)	Pg 29	0.4 (10.5)	1.6 (40)	1.5 (38)	M 12	3.1 (80)	1.6 (41)	0.4 (10)	
	1PH7103															
	1PH7105															
	1PH7107															
132	1PH7131		2 (52)	8.3 (211.5)	10.8 (275)	0.5 (12)	0.7 (18)	Pg 36	0.7 (17)	1.9 (50)	1.6 (42)	M 16	4.3 (110)	1.8 (45)	0.5 (12)	
	1PH7133															
	1PH7135															
	1PH7137															
160	1PH7163		2.4 (62)	9.9 (253)	12.9 (330)	0.6 (14)	0.7 (18)	Pg 42	0.7 (17)	2.5 (64)	2.2 (55)	M 20	4.3 (110)	2.3 (59)	0.6 (16)	
	1PH7167															

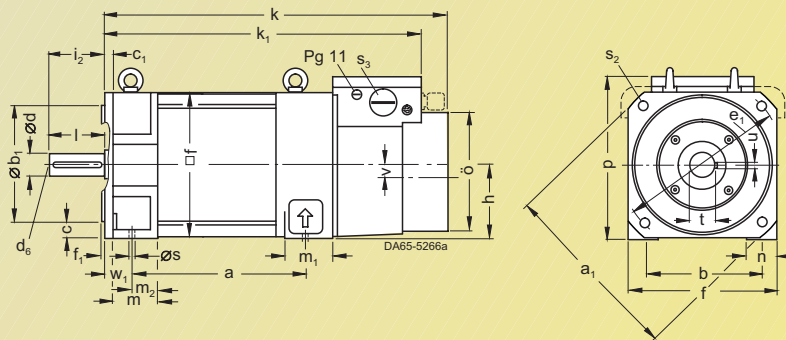

Servomotors

Dimension Drawings

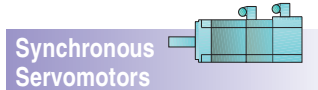

1PH7 motors

For motor		Dimension in inches (mm)															D-end of shaft					
Size	Type	DIN IEC	a ₁ P	b ₁ N	c ₁ LA	e ₁ M	f AB	f ₁ T	i ₂ -	k LB	k ₁ -	o -	p HD	s ₂ S	s ₃ -	v -	d D	d ₆ -	l E	t GA	u F	
Type of construction IM B 5, with pipe connection at ND-end																						
100	1PH7101		9.8 (250)	7.1 (180)	0.4 (10)	8.5 (215)	7.7 (196)	0.1 (4)	3.1 (80)	16.18 (411)	17.36 (441)	6.3 (161)	4.7 (120)	0.5 (14)	Pg 29	0.4 (10.5)	1.5 (38)	M 12	3.1 (80)	1.6 (41)	0.4 (10)	
	1PH7103									19.92 (506)	21.1 (536)											
	1PH7105																					
	1PH7107																					
132	1PH7131		13.8 (350)	9.8 (250)	0.6 (16)	11.8 (300)	10.2 (260)	0.2 (5)	4.3 (110)	21.18 (538)	22.56 (573)	8.3 (211.5)	5.6 (143)	0.7 (18)	Pg 36	0.7 (17)	1.6 (42)	M 16	4.3 (110)	1.8 (45)	0.5 (12)	
	1PH7133									24.53 (623)	25.91 (658)											
	1PH7135																					
	1PH7137																					

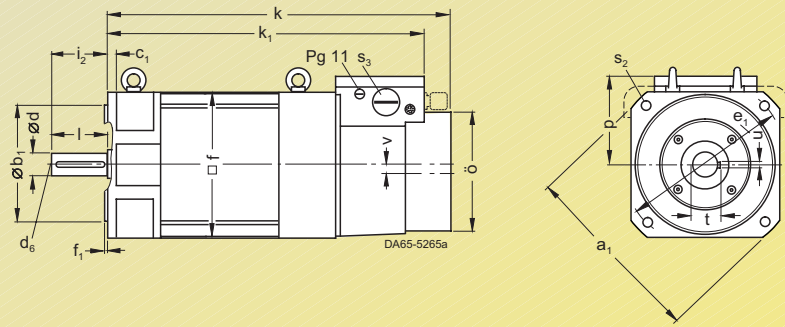

1PL6 motors

For motor		Dimension in inches (mm)															D-end of shaft						
Size	Type	DIN IEC	a B	b A	c LA	e M	f AB	g AC	h H	k LB	m BA	m ₁ -	m ₂ -	n AA	o -	p ¹⁾ -	s K	w ₁ C	d D	d ₆ -	l E	t GA	u F
Type of construction IM B 3																							
180	1PL6184		16.92 (430)	10.9 (279)	0.55 (14)	20.66 (525)	14.17 (360)	15.55 (395)	7.08 (180)	38.98 (990)	3.14 (80)	4.33 (110)	1.57 (40)	2.55 (65)	21.29 (541)	22.04 (560)	0.57 (14.5)	4.76 (121)	2.36 (60)	M 20	5.51 (140)	2.51 (64)	0.7 (18)
	1PL6186		20.47 (520)			24.21 (615)				42.52 (1080)					24.84 (631)	22.83 (580)			2.55 (65)			2.71 (69)	
225	1PL6224		17.51 (445)	14 (356)	0.7 (18)	21.85 (555)	17.71 (450)	19.48 (495)	8.85 (225)	43.31 (1100)	3.14 (80)	4.33 (110)	2.36 (60)	3.14 (80)	24.76 (629)	26.77 (680)	0.72 (18.5)	5.86 (149)	2.95 (75)	M 20	5.51 (140)	3.12 (79.5)	0.78 (20)
	1PL6226		21.45 (545)			25.98 (660)				47.24 (1200)					28.7 (729)								
	1PL6228		25 (635)			29.33 (745)				50.79 (1290)					32.24 (819)								

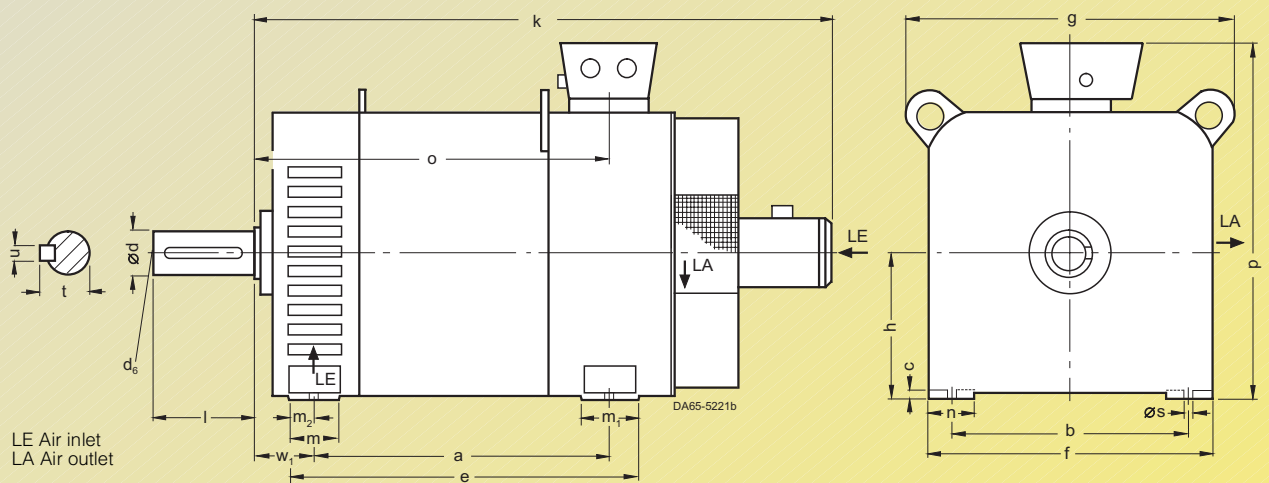

1) Maximum dimensions. Depending on the electrical design (terminal box type) smaller dimensions are also possible.



Asynchronous Servomotors

For motor		Dimension in inches (mm)															
Size	Type	DIN IEC	a B	b A	c HA	e BB	f AB	g ₂ AD	g ₄ -	h H	k LB	k ₁ -	k ₂ -	m ₁ -	m ₂ -	n AA	
Type of construction IM B 3																	
280	1PL6284		26.93 (684)	17.99 (457)	0.87 (22)	33.07 (840)	22.05 (560)	20.47 (520)	17.68 (449)	11.02 (280)	45.28 (1150)	19.29 (490)	21.06 (535)	4.25 (108)	3.15 (80)	3.94 (100)	
	1PL6286		31.26 (794)			37.4 (950)					49.61 (1260)	23.62 (600)					
	1PL6288		36.38 (924)			42.52 (1080)					54.72 (1390)	28.74 (730)					

		D-end of shaft									
Size	Type	DIN IEC	o -	p ₂ -	s K	w ₁ C	d D	l E	t GA	u F	
280	1PL6284		28.74 (730)	41.02 (1042)	0.94 (24)	7.48 (190)	3.74 (95)	6.69 (170)	3.94 (100)	0.98 (25)	
	1PL6286		33.07 (840)								
	1PL6288		38.19 (970)								

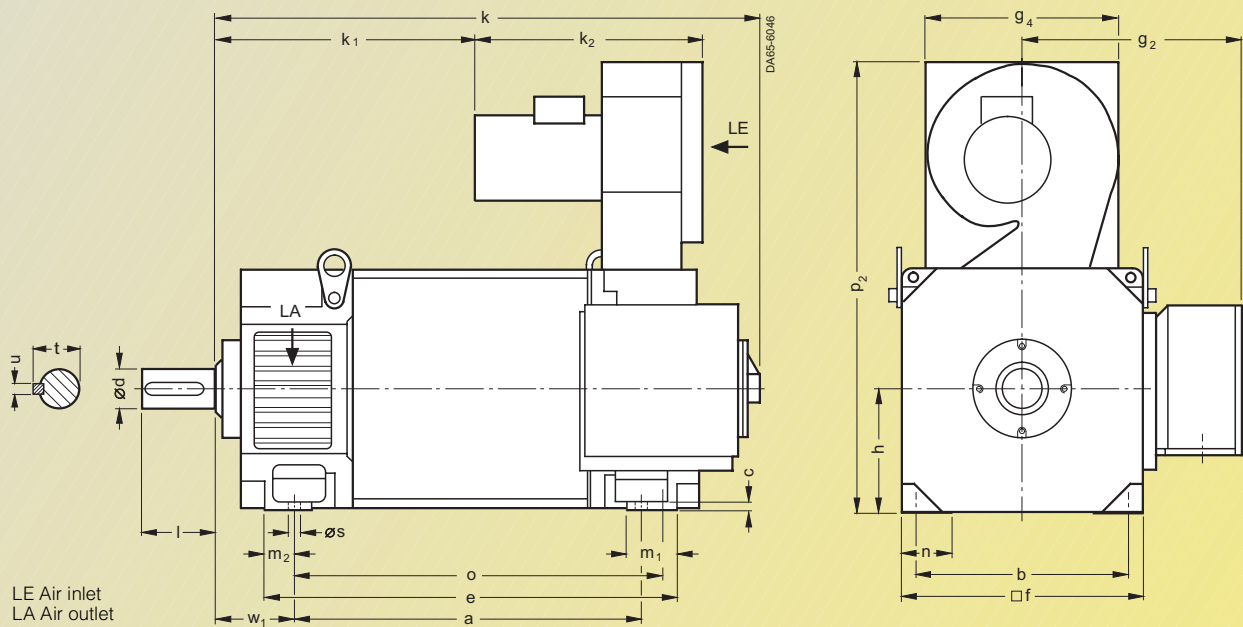

Servomotors Dimension Drawings

Asynchronous
Servomotors



1PL6 motors

For motor Dimension in inches (mm) For dimensions for foot mounting, shaft and terminal box, see dimension drawing of 1PL618. and 1PL622. motors, type of construction IM B 3, at page 8/36.

Size	Type	DIN IEC	a ₁ P	b ₁ N	c ₁ LA	e ₁ M	f ₁ T	i ₂ -	s ₂ S	z -	w ₁ -
Type of construction IM B 35											
180	1PL6184		17.71 (450)	13.77 (350)	0.62 (16)	15.74 (400)	0.19 (5)	5.51 (140)	0.74 (19)	0.31 (8)	4.76 (121)
	1PL6186										
225	1PL6224		21.65 (550)	17.71 (450)	0.7 (18)	19.68 (500)	0.19 (5)	5.51 (140)	0.74 (19)	0.31 (8)	5.86 (149)
	1PL6226										
	1PL6228										

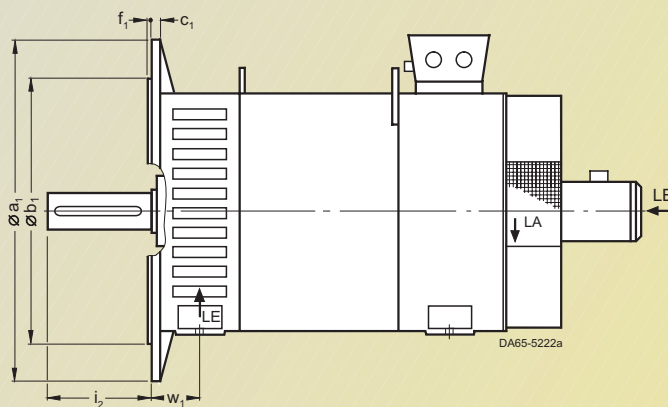

LE Air inlet
LA Air outlet

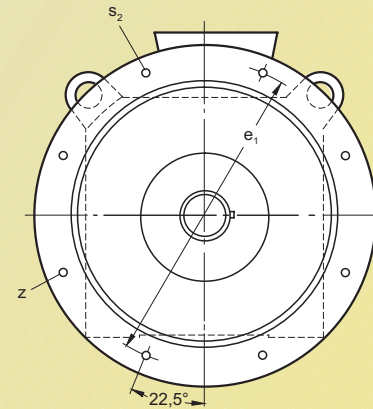

For motor Dimension in inches (mm) For dimensions for foot mounting, shaft and terminal box, see dimension drawing of 1PL628. motors, type of construction IM B 3, at page 8/37.

Size	Type	DIN IEC	a ₁ P	b ₁ N	c ₁ LA	e ₁ M	f ₁ T	h H	i ₂ -	k LB	k ₁ -	p ₂ -
Type of construction IM B 35												
280	1PL6284		25.98 (660)	21.65 (550)	0.94 (24)	23.62 (600)	0.24 (6)	11.02 (280)	6.69 (170)	45.28 (1150)	19.29 (490)	41.02 (1042)
	1PL6286									49.61 (1260)	23.62 (600)	
	1PL6288									54.72 (1390)	28.74 (730)	

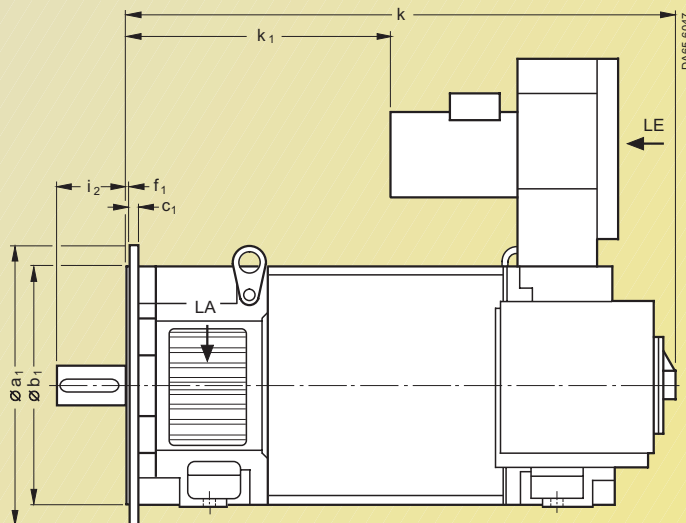

LE Air inlet
LA Air outlet

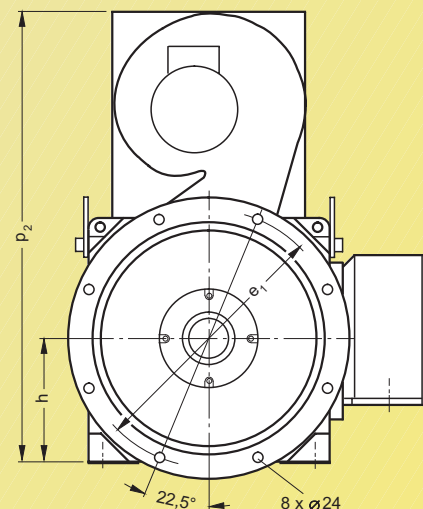



Asynchronous
Servomotors

For motor Dimension in inches (mm)

Size	Type	DIN IEC	a B	a ₁ P	b A	b ₁ N	c LA	c ₁ -	e ₁ -	f AB	f ₁ T	h H	i ₂ -	k LB	m BA	m ₁ -	m ₂ -	n AA
Type of construction IM B 35, water-cooled																		
100	1PH4103		13.7 (349)	9.8 (250)	6.3 (160)	7.1 (180)	0.4 (11)	0.5 (12)	8.5 (215)	7.5 (190)	0.1 (4)	3.9 (100)	3.1 (80)	16.38 (416)	1.4 (35)	2.4 (60)	0.9 (24)	1.6 (40)
	1PH4105		16.1 (409)											18.74 (476)				
	1PH4107		18.7 (474)											21.3 (541)				
132	1PH4133		14.8 (377)	13.8 (350)	8.5 (216)	9.8 (250)	0.5 (14)	0.6 (16)	11.8 (300)	9.7 (246)	0.2 (5)	5.2 (132)	4.3 (110)	18.03 (458)	1.4 (36)	3.3 (85)	1 (25)	1.8 (46)
	1PH4135		17.6 (447)											20.79 (528)				
	1PH4137		19.6 (497)											22.76 (578)				
160	1PH4163		20 (508)	15.7 (400)	10 (254)	11.8 (300)	0.6 (15)	0.7 (18)	13.8 (350)	11.4 (290)	0.2 (5)	6.3 (160)	4.3 (110)	23.27 (591)	1.6 (42)	3 (77)	1.1 (29)	2 (52)
	1PH4167		22.2 (563)											25.43 (646)				
	1PH4168		23.9 (608)											27.2 (691)				

D-end of shaft

Size	Type	DIN IEC	o -	p HD	s K	s ₂ K	s ₃ -	w ₁ C	d D	d ₆ -	l E	t GA	u F
100	1PH4103		9.6 (245)	10.2 (259)	0.5 (12)	0.6 (14)	Pg 29	1.7 (44)	1.5 (38)	M 12	3.1 (80)	1.6 (41)	0.4 (10)
	1PH4105		12 (305)										
	1PH4107		14.7 (370)										
132	1PH4133		10.4 (264)	13.2 (334.5)	0.5 (12)	0.7 (18)	Pg 36	2.1 (53)	1.7 (42)	M 16	4.3 (110)	1.8 (45)	0.5 (12)
	1PH4135		13.1 (334)										
	1PH4137		15.1 (384)										
160	1PH4163		16 (407)	15.3 (388)	0.6 (14)	0.7 (18)	Pg 36	2.2 (56)	2.2 (55)	M 20	4.3 (110)	2.3 (59)	0.6 (16)
	1PH4167		18.2 (462)										
	1PH4168		19.9 (507)										

**1PH410 .
1PH413 .**

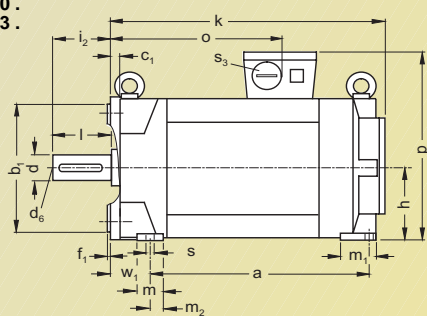

Water connection
G 1/4 by 1PH410.
G 3/8 by 1PH413.

Water connection
G 1/4 by 1PH410.
G 3/8 by 1PH413.

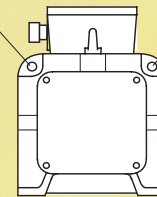
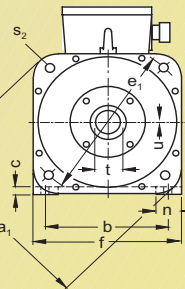

1PH416 .

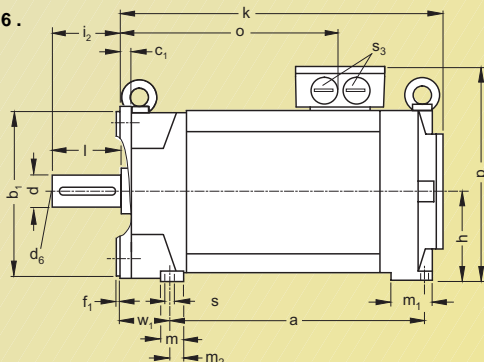

Water connection G 1/2

Water connection G 1/2

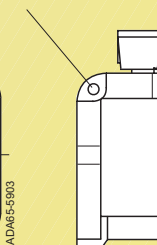
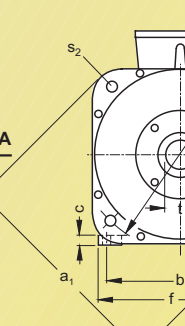

Servomotors

Dimension Drawings

Asynchronous
Servomotors



1PH7 motors with 2-gear units

Motor		Gear unit Dimension in inches (mm)											
Size	Type	A	B	C	C ₁	D ₁	D ₂	D ₃	D ₄	E ₁	E ₂	F	H
1PH7 motors, type of construction IM B 35, with 2-gear units													
100	1PH7101	2.17 (55)	7.24 (184)	0.47 (12)	0.71 (18)	3.94 (100)	3.94 (100)	7.4 (188)	7.48 (190)	8.46 (215)	3.15 (80)	8.19 (208)	4.25 (108)
	1PH7103												
	1PH7105												
	1PH7107												
132	1PH7131	2.28 (58)	9.21 (234)	0.47 (12)	0.79 (20)	4.57 (116)	4.65 (118)	9.8 (249)	9.84 (250)	11.81 (300)	3.94 (100)	10.63 (270)	5.35 (136)
	1PH7133												
	1PH7135												
	1PH7137												
160	1PH7163	2.28 (58)	11.42 (290)	0.67 (17)	0.79 (20)	5.51 (140)	5.12 (130)	9.8 (249)	9.84 (250)	13.78 (350)	3.94 (100)	12.83 (326)	6.46 (164)
	1PH7167												

Motor		Gear unit Dimension in inches (mm)									Total length motor with gear unit K
Size	Type	K ₁	L ₁	L ₂	P	S	S ₂	S ₃	Z	W	
100	1PH7101	11.73 (298)	–	4.57 (116)	11.85 (301)	0.55 (14)	0.55 (14)	M 8	0.31 (8)	2.48 (63)	27.91 (709)
	1PH7103										27.91 (709)
	1PH7105										31.65 (804)
	1PH7107										31.65 (804)
132	1PH7131	13.64 (346.5)	5.1 (129.5)	5.61 (142.5)	13.62 (346)	0.55 (14)	0.71 (18)	M 12	0.47 (12)	2.8 (71)	34.84 (885)
	1PH7133										34.84 (885)
	1PH7135										38.19 (970)
	1PH7137										38.19 (970)
160	1PH7163	13.64 (346.5)	–	5.61 (142.5)	15.83 (402)	0.55 (14)	0.71 (18)	M 12	0.47 (12)	2.8 (71)	38.86 (987)
	1PH7167										40.31 (1024)

Dimensions for 1PH7184, 1PH7186 and 1PH7224 on request.

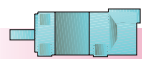

Asynchronous Servomotors

Servomotors Dimension Drawings

1PH7 motors with 2-gear units

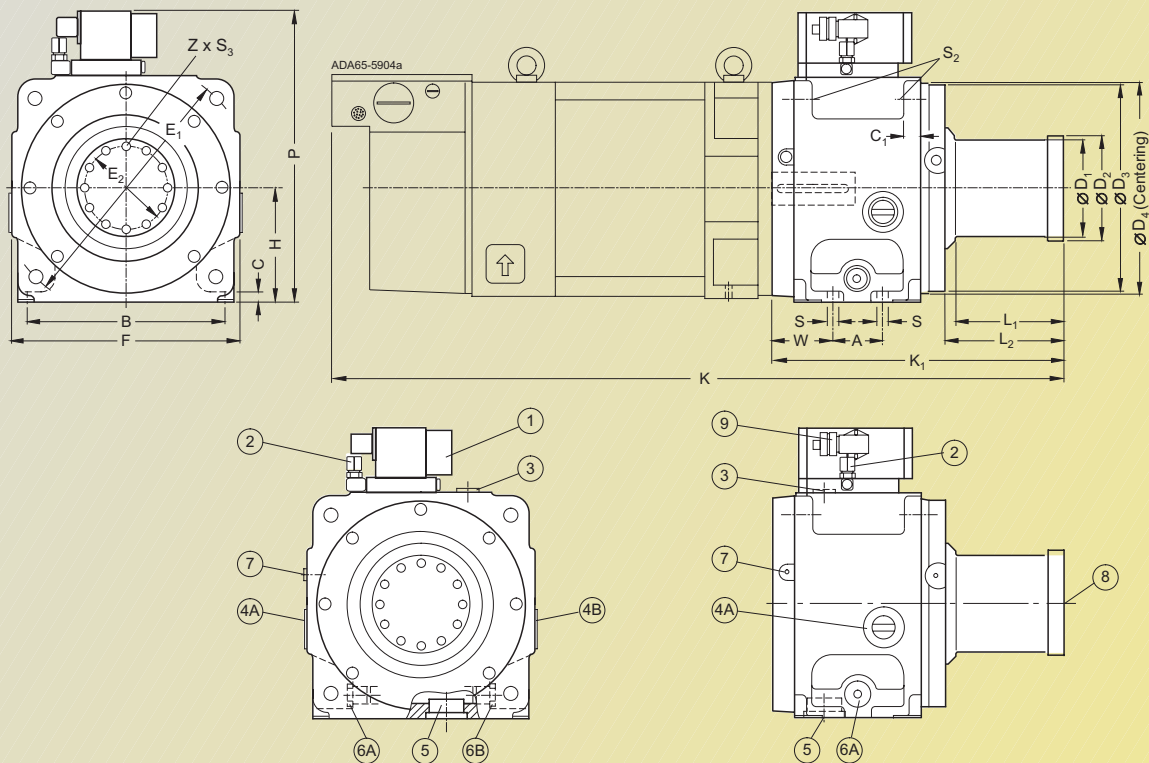

① Switching unit (lifting solenoid 24 V DC, 5 A).

② Ventilation valve.

③ Oil filling bolt.

④A Oil level inspection window or oil return for counterclockwise rotation and greasing around the circumference.

④B Oil level inspection window or oil return for clockwise rotation and greasing around the circumference.

⑤ Oil drain bolt for type IM B 35.

⑥A Oil inlet for clockwise rotation and greasing around the circumference.

⑥B Oil inlet for anticlockwise rotation and greasing around the circumference.

⑦ Oil inlet for type IM V 15 (must be connected).

⑧ Oil inlet for type IM V 36.

⑨ Connector, manufacture: Harting, type HAN 8 U.

Servomotors

Dimension Drawings

Asynchronous
Servomotors

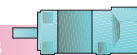

1PH4 motors with 2-gear units

Motor		Gear unit											
Size	Type	A	B	C	C ₁	D ₁	D ₂	D ₃	D ₄	E ₁	E ₂	F	H
1PH4 motors, type of construction IM B 35, with 2-gear units													
100	1PH4103 1PH4105 1PH4107	2.17 (55)	7.24 (184)	0.47 (12)	0.71 (18)	3.94 (100)	3.94 (100)	7.4 (188)	7.48 (190)	8.46 (215)	3.15 (80)	8.19 (208)	4.25 (108)
132	1PH4133 1PH4135 1PH4137 1PH4138	2.28 (58)	9.21 (234)	0.47 (12)	0.79 (20)	4.57 (116)	4.65 (118)	9.8 (249)	9.84 (250)	11.81 (300)	3.94 (100)	10.63 (270)	5.35 (136)
160	1PH4163 1PH4167 1PH4168	2.28 (58)	11.42 (290)	0.67 (17)	0.79 (20)	5.51 (140)	5.12 (130)	9.8 (249)	9.84 (250)	13.78 (350)	4.33 (110)	12.83 (326)	6.46 (164)

Motor		Gear unit										Total length motor with gear unit
Size	Type	K ₁	L ₁	L ₂	P	S	S ₂	S ₃	Z	W	K	
100	1PH4103 1PH4105 1PH4107	11.73 (298)	–	4.57 (116)	11.85 (301)	0.55 (14)	0.55 (14)	M 8	0.31 (8)	2.48 (63)	28.11 (714) 30.47 (774) 33.03 (839)	
132	1PH4133 1PH4135 1PH4137 1PH4138	13.64 (346.5)	5.1 (129.5)	5.61 (142.5)	13.62 (346)	0.55 (14)	0.71 (18)	M 12	0.47 (12)	2.8 (71)	31.69 (805) 34.45 (875) 36.42 (925) 37.8 (960)	
160	1PH4163 1PH4167 1PH4168	13.64 (346.5)	–	5.61 (142.5)	15.83 (402)	0.55 (14)	0.71 (18)	M 12	0.47 (12)	2.8 (71)	36.93 (938) 39.09 (993) 40.87 (1038)	

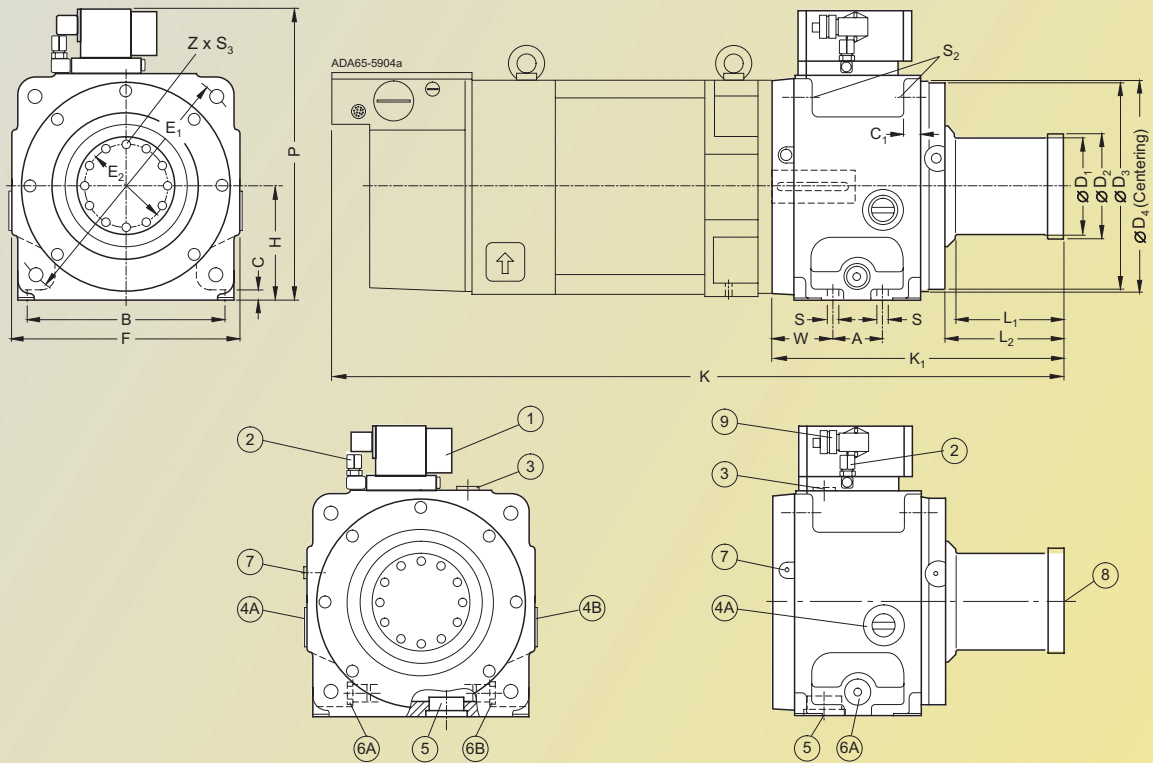

① Switching unit (lifting solenoid 24 V DC, 5 A).

② Ventilation valve.

③ Oil filling bolt.

④A Oil level inspection window or oil return for counterclockwise rotation and greasing around the circumference.

④B Oil level inspection window or oil return for clockwise rotation and greasing around the circumference.

⑤ Oil drain bolt for type IM B 35.

⑥A Oil inlet for clockwise rotation and greasing around the circumference.

⑥B Oil inlet for anticlockwise rotation and greasing around the circumference.

⑦ Oil inlet for type IM V 15 (must be connected).

⑧ Oil inlet for type IM V 36.

⑨ Connector, manufacture: Harting, type HAN 8 U.

Servomotors

Dimension Drawings

Notes

Synchronous
Servomotors

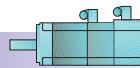

Asynchronous
Servomotors



Servomotors

Appendix

A/2	Environment, resources and recycling, EC declaration of manufacture
A/4	Index
A/5	Order number index
A/6	Customer service
A/10	Conversion tables
A/12	Standard terms and conditions of sale

A

Servomotors

Appendix

Environment, resources and recycling, EC declaration of manufacture

Siemens AG is very much aware of the fact that it has an important role to play in protecting the environment and conserving valuable natural resources. This applies to both manufacturing and the products we sell.

As early as the development phase, the possible impact of future products/systems on the environment is taken into consideration. Our aim is to prevent environmental pollution or, at least, reduce it to a minimum and, in doing so, look beyond existing regulations and legislation.

Below are some of the most important environment-related factors which are taken into account:

The use of dangerous substances (such as arsenic, asbestos, beryllium, cadmium, CFC, halogens and many more) is avoided as early as the development phase.

Easy to disconnect connections have been designed and materials are selected carefully with preference being given to recyclable materials or materials which can be disposed without causing problems.

Synchronous Servomotors

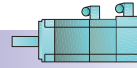

Asynchronous Servomotors



Materials for manufacturing purposes are identified in accordance with their recyclability. This applies, in particular, to components which contain unavoidable, dangerous materials. These components are installed or mounted in such a way that they can be easily separated, thus facilitating disposal in an environmentally-friendly manner. Wherever possible, recycled components are used.

Environmentally-compatible packaging materials (pressed board and PE foils) are used for shipping and storage; we also try to keep the amount of packaging material used to a minimum.

If possible, we pack our products in reusable packaging.

We have already made preparations to enable the converters to be disposed of after use in accordance with the regulations governing the disposal of electronic equipment (not yet in force).

This catalog is printed on chlorine-free bleached paper.

On the back of the German EC of conformity declarations there are English, French, Spanish, Italian and Swedish translations.

Example for EC declaration of manufacture

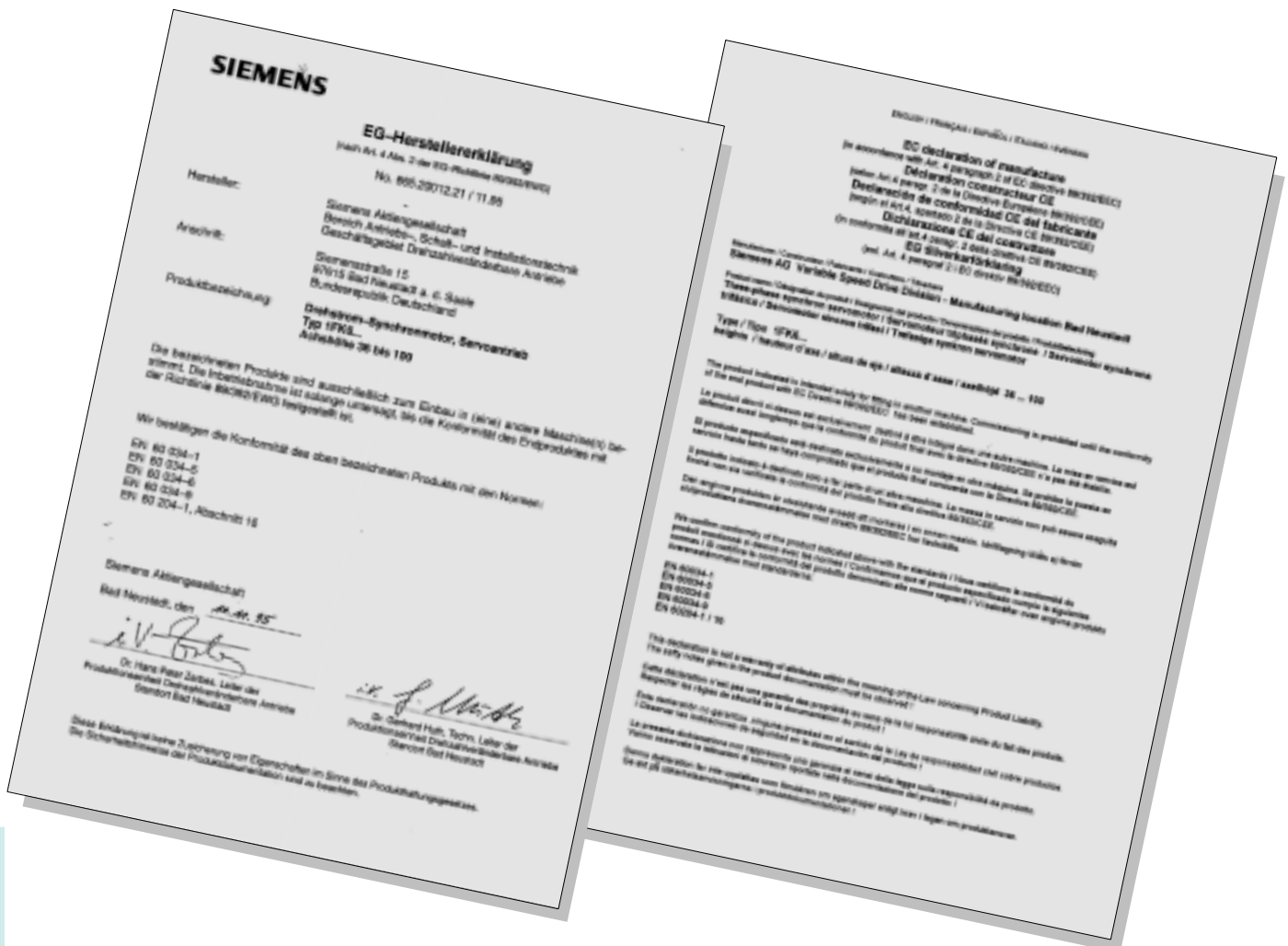

A



Asynchronous
Servomotors

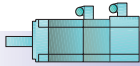

Synchronous
Servomotors

EC declaration of manufacture

SIEMENS

EG-Herstellererklärung
nach Art. 4 Abs. 2 der EG-Richtlinie 89/332/EWG
No. 965.20011.21 / 12.04

Hersteller:
Siemens Aktiengesellschaft
Bereich Antrieb-, Schalt- und Installations Technik
Geschäftsbereich Antriebstechnik
Geschäftsbereich Niederspannungsmotoren

Anschrift:
Siemensstraße 15
81765 Bad Neustadt a. d. Saale
Bundesrepublik Deutschland

Produktbezeichnung:
Drehstrom-Synchronmotor, Servoantrieb
Typ 1FT8...
Achshöhe 28 bis 132

Die bezeichneten Produkte sind ausschließlich zum Einbau in (eine) andere Maschine(n) bestimmt. Die Inbetriebnahme ist solange untersagt, bis die Konformität des Endprodukts mit der Richtlinie 89/332/EWG festgestellt ist.

Wir bestätigen die Konformität des oben bezeichneten Produkts mit den Normen:
EN 60034-5
EN 60034-6
EN 60034-9
EN 60034-1, Abschnitt 18
DIN VDE 0530-1

Siemens Aktiengesellschaft
Bad Neustadt, den 20.02.04

Dr. Hans Peter Zerbe, Leiter der
Produktentwicklung Antriebstechnik

Dr. Siegfried Hüll, Techn. Leiter der
Produktentwicklung Antriebstechnik

Diese Erklärung ist keine Zusicherung von Eigenart oder im Sinne der Produkthaftungsgesetze. Die Sicherheitsrisiko der Produktanwendung sind zu beachten.

ENGLISH / FRANCAIS / ESPAÑOL / ITALIANO / BULGARSKO

EC declaration of manufacture
Déclaration constructeur CE
Declaración de conformidad CE del fabricante
Dichiarazione CE del costruttore
EG Sivekvalifikering
Art. 4, paragraf 2 af EC direktiv 89/332/EWG

Manufacturer / Constructeur / Fabricante / Costruttore / Изготовител
Siemens AG Antrieb und Drive System Division - Low-Voltage Motors
Three-phase synchronous / Servomotorul trifazat / Servomotori trifazni / Servomotori trifazi / Servomotori trifazni

Product name / Désignation de produit / Designazione del prodotto / Produktbezeichnung
Three-phase synchronous / Servomotorul trifazat / Servomotori trifazni / Servomotori trifazi / Servomotori trifazi

Type / Tipo / Tipus...
Synchronous / Sincron / Sincron / Sincron / Sincron

The product indicated is intended solely for fitting in another machine. Commissioning is prohibited until conformity of the end-product with EC Directive 89/332/EWG has been established.

Le produit décrit n'est pas un assemblage destiné à être intégré dans une autre machine. La mise en service est interdite avant l'établissement de la conformité du produit final avec la directive 89/332/EWG.

El producto especificado está destinado exclusivamente a su montaje en otra máquina. La puesta en servicio está prohibida hasta tanto se verifique la conformidad del producto final con la Directiva 89/332/EWG.

Il prodotto indicato è destinato solo a far parte di un'altra macchina. La messa in servizio può essere eseguita soltanto dopo aver verificato la conformità del prodotto finale alla direttiva 89/332/EWG.

Съвкупните продукти са предназначени само за монтаж в друга машина. Използването е строго забранено до установяването на съответствието на крайния продукт с директивата 89/332/EWG.

We confirm conformity of the product indicated above with the standards / nous confirmons la conformité du produit mentionné ci-dessus avec les normes / Confirmamos que el producto especificado está en conformidad con los estándares de conformidad con la documentación del producto / Conformiamo che il prodotto specificato sia in conformità con gli standard / Съвкупните продукти са предназначени само за монтаж в друга машина. Използването е строго забранено до установяването на съответствието на крайния продукт с директивата 89/332/EWG.

EN 60034-5
EN 60034-6
EN 60034-9
EN 60034-1 / 18
DIN VDE 0530-1

This declaration is not a warranty of absolute value for the meaning of the Law concerning Product Liability.
Cette déclaration n'est pas une garantie des propriétés au sens de la responsabilité civile de fait des produits.
Este declaración no garantiza ningún propiedad en el sentido de la Ley de responsabilidad civil sobre productos.
Questo avvertimento di esclusione di responsabilità non è da intendersi come garanzia del prodotto.
Съвкупните продукти са предназначени само за монтаж в друга машина. Използването е строго забранено до установяването на съответствието на крайния продукт с директивата 89/332/EWG.

SIEMENS

EG-Herstellererklärung
nach Art. 4 Abs. 2 der EG-Richtlinie 89/332/EWG
No. A1A 3435.H002 DE / 05.01

Hersteller:
Siemens Aktiengesellschaft
Bereich Automatisierungs- und Antriebstechnik
Geschäftsbereich Large Drives
Geschäftsbereich Industrie

Anschrift:
Wipplingerstraße 1 - 10
90441 Nürnberg
Bundesrepublik Deutschland

Produktbezeichnung:
Drehstromservomotor IPMT...
Achshöhe 18 bis 22.

Das bezeichnete Produkt ist ausschließlich zum Einbau in eine andere Maschine bestimmt. Die Inbetriebnahme ist solange untersagt, bis die Konformität des Endprodukts mit der Richtlinie 89/332/EWG festgestellt ist.

Wir bestätigen die Konformität des oben bezeichneten Produkts mit den Normen:
EN 60034-1
EN 60034-5
EN 60034-6
EN 60034-9
EN 60034-1, Abschnitt 18

Siemens Aktiengesellschaft
Nürnberg, den 11.05.01

Dr. V. Bruns
Abt. LD / Leiter der
Produktentwicklung Industrie

Dr. Alfred Titz
Abt. LD / Leiter der
Produktentwicklung Industrie

Diese Erklärung ist keine Zusicherung von Eigenart oder im Sinne der Produkthaftungsgesetze. Die Sicherheitsrisiko der Produktanwendung sind zu beachten.

ENGLISH / FRANCAIS / ESPAÑOL / ITALIANO / BULGARSKO

EC declaration of manufacture
Déclaration constructeur CE
Declaración de conformidad CE del fabricante
Dichiarazione CE del costruttore
EG Sivekvalifikering
Art. 4, paragraf 2 af EC direktiv 89/332/EWG

Manufacturer / Constructeur / Fabricante / Costruttore / Изготовител
Siemens AG Automation and Drives, Large Drives, Subdivision Industry

The product indicated is intended solely for fitting in another machine. Commissioning is prohibited until the conformity of the end-product with EC Directive 89/332/EWG has been established.

Le produit décrit n'est pas un assemblage destiné à être intégré dans une autre machine. La mise en service est interdite avant l'établissement de la conformité du produit final avec la directive 89/332/EWG.

El producto especificado está destinado exclusivamente a su montaje en otra máquina. La puesta en servicio está prohibida hasta tanto se verifique la conformidad del producto final con la Directiva 89/332/EWG.

Il prodotto indicato è destinato solo a far parte di un'altra macchina. La messa in servizio può essere eseguita soltanto dopo aver verificato la conformità del prodotto finale alla direttiva 89/332/EWG.

Съвкупните продукти са предназначени само за монтаж в друга машина. Използването е строго забранено до установяването на съответствието на крайния продукт с директивата 89/332/EWG.

We confirm conformity of the product indicated above with the standards / nous confirmons la conformité du produit mentionné ci-dessus avec les normes / Confirmamos que el producto especificado está en conformidad con los estándares de conformidad con la documentación del producto / Conformiamo che il prodotto specificato sia in conformità con gli standard / Съвкупните продукти са предназначени само за монтаж в друга машина. Използването е строго забранено до установяването на съответствието на крайния продукт с директивата 89/332/EWG.

EN 60034-1
EN 60034-5
EN 60034-6
EN 60034-9
EN 60034-1, Abschnitt 18

This declaration is not a warranty of absolute value for the meaning of the Law concerning Product Liability.
Cette déclaration n'est pas une garantie des propriétés au sens de la responsabilité civile de fait des produits.
Este declaración no garantiza ningún propiedad en el sentido de la Ley de responsabilidad civil sobre productos.
Questo avvertimento di esclusione di responsabilità non è da intendersi come garanzia del prodotto.
Съвкупните продукти са предназначени само за монтаж в друга машина. Използването е строго забранено до установяването на съответствието на крайния продукт с директивата 89/332/EWG.



Servomotors

Appendix

Index

	Page
2	
2-gear units from ZF	4/15
A	
Absolute-value encoders	4/3
Additional data for 1PH7 and 1PL6 motors	7
Asynchronous servomotors	3
Asynchronous servomotors, 1PH4	3/27
Asynchronous servomotors, 1PH7	3/2
Asynchronous servomotors, 1PL6	3/19
B	
Balancing	1/10
Bearing design	7/32
Brakes	4/6 to 4/9
Built-on accessories	4
Built-on gears	4/10 to 4/17
Built-on holding brakes	4/8
C	
Cable cross-sections, max. connectable sizes	7/35
Cables	5
Cables for SIMODRIVE POSMO CD/CA, SI	5/15
Cable structure and pin assignment for encoder cables	5/8 to 5/16
Cable structure and pin assignment for 6FX5 and 6FX8 power cables	5/4 to 5/7
Change-speed gear unit	4/15
Coating	1/12
Combination adapter	4/23
Combination end piece	4/23
Compact servomotors	2/5
Configuration notes	7
Connecting systems	5
Conversion table	A/10, A/11
Cooling profiles	4/20
Customer service	A/6 to A/9
D	
Declaration of conformity	A/2
Degree of protection	7/2
Dimension drawings	8
Dimension drawings for	
1FK6 motors	8/2
1FT6 motors	8/3 to 8/7
1PH7 motors	8/8 to 8/14, 8/17 to 8/20
1PH4 motors	8/21
1PL6 motors	8/15, 8/16
Documentation	6
Documentation CD-ROM	6/2
Drive type	7/32
Duty types	1/11
E	
Encoder cables	5/12 to 5/16
Encoder cables for 1FN3 AC linear motors	5/12
Encoder cables for SIMODRIVE 611 universal	5/14
Encoder cables for connection to motors with an absolute-value encoder	5/11
Encoder cables for connection to motors with an incremental encoder HTL	5/8
Encoder cables for connection to motors with an incremental encoder 1 V _{pp}	5/10
Encoder cables for connection to motors with a resolver	5/9
Encoders	4/2, 4/3
Encoder systems	4/2, 4/3
Environment	A/2
EC declaration of conformity	A/2
Explosion-proof motors	2/16
F	
Flow diagram for selection process	1/4, 1/5
G	
Gear installation	4/7 to 4/16
General information	
Degree of protection	7/2
H	
Hall-effect sensor box	4/5
High dynamic servomotors	2/5
Holding brakes	4/6 to 4/9
Holding brakes for 1FK ₆ and 1FT6 motors	4/6
Holding brakes for 1FT6	4/7
Holding brakes for 1PH7 motors	4/8
I	
Incremental encoder	4/2
L	
Lateral-force diagrams	7/33, 7/34
Linear motors	4/4, 4/18

Synchronous Servomotors

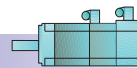

Asynchronous Servomotors



	Page
M	
Maximum speeds	7/32
Measuring systems	4/4
MOTION-CONNECT	5
Motor protection	1/12
N	
Noise pressure level	7/32
O	
Optional cooler	4/18
Order No. codes for 1PH7 motors with holding brake	4/9
Brief description	1/2, 1/3
Overview	1
Overview of possible types of construction	7/36
Overview of types	1/6, 1/7
Overview of types and ratings	1/6, 1/7
P	
Planetary gears from alpha	4/10 to 4/14
Planetary gears from Bayside Motion	4/17
Planetary gears from other manufacturers	4/17
Planetary gears from ZF Friedrichshafen	4/15
Power cables 6FX5, 6FX8	5/4
Power cables 6FX7	5/6
Power cables connection overview	5/3
Precision cooler	4/19
PROTOFLEX-EMV power cables, sold by the metre	5/7
R	
Radial eccentricity tolerance	1/9
Ratings	1/6, 1/7
Recycling	A/2
Resolvers	4/2
Resources	A/2
Rotary pulse encoder	4/2
S	
Secondary section cover	4/24
Secondary section end pieces	4/23
Selection and ordering data	
1FK6	2/2 to 2/4
1FN3	2/20
1FK7	2/6 to 2/7
1FS6	2/17
1FT6	2/9 to 2/15
1PH7	3/5 to 3/18
1PH4	3/28, 3/29
1PL6	3/21 to 3/26
Encoder cables	5/8 to 5/12
6FX5 and 6FX8 power cables	5/4 to 5/6
Planetary gears	4/10 to 4/17
PROTOFLEX-EMV power cables	5/7
SimoSize	6/2
sin/cos incremental encoder	4/3
Sizing and selection tool	6/2
Sound pressure level	7/32
Speed-Torque curves	
1FK6	7/3, 7/4
1FT6	7/5 to 7/15
1PH7	7/16 to 7/26
1PL6	7/26 to 7/31
Standard terms and conditions of sale	A/12
Synchronous servomotors	2
Synchronous servomotors, 1FT6	2/5 to 2/10
T	
Technical data	
1PH7 asynchronous servomotors	3/2 to 3/4
1PH4 asynchronous servomotors	3/27
1PL6 asynchronous servomotors	3/19, 3/20
Encoder	4/2
Encoder cables	5/2
Holding brake	4/6, 4/7
6FX5 and 6FX8 power cables	5/2
PROTOFLEX-EMV power cables	5/7
Resolver	4/2
1FK6 synchronous servomotors	2/2
1FK7 synchronous servomotors	2/5
1FN3 synchronous servomotors	2/19
1FS6 synchronous servomotors	2/16
1FT6 synchronous servomotors	2/8
Technical explanation	1/8
Terminal box assignment	7/35
Types of construction	7/36
V	
Ventilation data	7/32
Vibration severity	1/9
Vibration stress	1/9
W	
Water-cooled 1PH4 asynchronous servomotors	3/19, 3/20



Asynchronous Servomotors

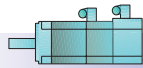

Synchronous Servomotors

Order number index

	Page
1FK	
1FK6	2/3
1FK603.	2/3
1FK604.	2/3
1FK606.	2/3, 4/8
1FK608.	2/3, 4/8
1FK610.	2/3, 4/8
1FK7	2/6
1FK702.	2/6
1FK703.	2/6, 4/8
1FK704.	2/6, 4/8
1FK706.	2/6, 4/8
1FK708.	2/6, 4/8
1FK710.	2/6, 4/8
1FN	
1FN3 002	4/5, 4/20, 4/22
1FN3 003	4/5, 4/20, 4/22
1FN3 004	4/5, 4/20, 4/22
1FN3 005	4/5, 4/20, 4/22
1FN3 050	2/20, 4/19, 4/20, 4/25
1FN3 100	2/20, 4/19, 4/20, 4/25
1FN3 150	2/20, 4/19, 4/20, 4/25
1FN3 300	2/20, 4/19, 4/20, 4/25
1FN3 450	2/20, 4/19, 4/20, 4/25
1FN3 600	2/20, 4/19, 4/20, 4/25
1FN3 900	2/20, 4/19, 4/20, 4/25
1FS	
1FS6	2/17
1FS6074	2/17
1FS6096	2/17
1FS6115	2/17
1FS6134	2/17
1FT	
1FT6	2/9
1FT604.	2/9
1FT606.	2/9
1FT608.	2/9
1FT610.	2/9
1FT613.	2/9
1PH	
1PH4	3/28
1PH410.	3/28
1PH413.	3/28
1PH416.	3/28
1PH7	3/5, 4/6
1PH710.	3/5
1PH713.	3/5
1PH716.	3/5
1PH718.	3/5
1PH722.	3/5
1PH728.	3/5

	Page
1PL	
1PL6	3/21
1PL618.	3/21
1PL622.	3/21
1PL628.	3/21
6ES	
6ES7	5/15, 5/16, 5/17
6FC	
6FC9348	5/7 to 5/9
6FX	
6FX.002	5/4, 5/5
6FX.008	5/4, 5/5
6FX1	5/15, 5/16, 5/17
6FX2003	5/4, 5/7
6FX5002	5/4, 5/14
6FX5008	5/4, 5/5
6FX7002	5/6
6FX8002	5/4, 5/5, 5/14
6FX8008	5/3 to 5/9
6XV1	5/15, 5/16, 5/17
2LG	
2LG4250	4/16
2LG4260	4/16
2LG4312	4/16
2LG4315	4/16
2LG4320	4/16
D	
DRMS-02055	6/2
E	
EBD	4/6, 4/7

Servomotors

Appendix

Customer service

Welcome to Siemens US

If you are a new Siemens Drive Products customer, we thank you for doing business with us. We will work hard to earn your trust and serve your company as if it were our own! If you are currently doing business with us, we thank you for the opportunity to grow with you.

Your primary contact point in the United States for the servomotors and all other Siemens drive products are the Regional Sales Offices in the following locations:

Atlanta

5405 Metric Place
Suite 100
Norcross, GA 30092
Phone: 770-452-3400
Fax: 678-297-8409

Dallas

501 Fountain Parkway
2nd Floor
Grand Prairie, TX 75050
Phone: 817-640-4929
Fax: 817-640-9640

Chicago

1901 N. Roselle Road
Suite 210
Schaumburg, IL 60195
Phone: 800-333-7732
Fax: 888-333-8206

Houston

13105 NW Freeway
Suite 950
Houston, TX 77040
Phone: 713-690-3000
Fax: 713-690-1210

Kansas City

6201 College Blvd
Suite 385
Overland Park, KS 66211
Phone: 913-498-4200
Fax: 913-498-4240

Los Angeles

10655 Business Center Dr
Suite C1
Cypress, CA 90630
Phone: 714-252-3000
Fax: 714-527-7230

Philadelphia

323 Norristown Road
Suite 210
Amber, PA 19002
Phone: 800-388-8067
Fax: 215-283-4702

Synchronous Servomotors

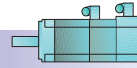

Siemens policies/protocols

Minimum order

SE&A will assess a \$25 handling fee on all orders valued at less than \$400.

Freight

All of our original product shipments are F.O.B. point of shipment. For standard product orders greater than \$1000 shipping from SE&A distribution centers, charges are freight allowed via method selected by SE&A. For orders less than \$1000, motors, and non-standard product freight charges are pre-paid and added to the invoice. All air freight charges are the responsibility of the customer. Also, a customer account number is required for third party billing of freight charges.

Emergency/Expedite fees

When customers require urgent delivery, several methods of expedited delivery are available. Each is noted below along with the associated charges:

NEXT FLIGHT OUT –

This service provides same day service where possible. In all cases, the expedited surcharge is \$300. The customer is responsible for the associated freight charges.

AFTER HOUR SERVICE –

Orders placed for same day shipment after 5:00 pm eastern time and weekends/holidays are subject to a \$300 surcharge. The customer is responsible for the associated freight charges.

Asynchronous Servomotors

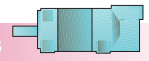

SPARE PARTS FROM INTERNATIONAL LOCATIONS – Siemens Energy & Automation supports all Siemens Drive Products in the USA, regardless of their country of origin. However, certain products may require shipment from an international emergency warehouse to meet customer delivery requirements. In such cases the minimum order value for such items is \$300 net. If the order does not total \$300, an additional charge will be added to bring the total order to \$300. (The normal \$25 surcharge will not apply). Siemens features an international emergency warehouse that can ship many parts within 24 hours. Most parts can arrive in the United States within 2 – 4 days. Your Customer Service or Sales Representative can check to see if your part is in stock in the emergency warehouse.

CUSTOMER PICK UP –

All customer pick up orders will be ready 2 hours after order is received, and must be picked up within 24 hours. There is no additional charge for this service.

Returns

Standard products fall under the SE&A standard product return guidelines (below). Drive systems in cabinets, built to specification, motors, or other non-standard items do not fall under this policy. Contact your Sales or Customer Service Representative should you have questions regarding return policy.

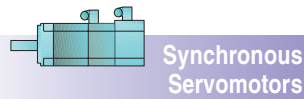

Siemens return goods policy

A Return Goods Request/ Authorization (RGA) is required to accompany all products returned to Siemens Energy & Automation, Inc. (Siemens). This insures that the returned product is properly identified and credited to your account. Unauthorized returns will be refused and returned to the customer with no liability to Siemens.

To provide our customers maximum opportunity for inventory control, we have established three classes of product returns:

- Accommodation return
- Siemens error return
- Non-Conforming product warranty return

Product built to a customer's specifications cannot be returned for credit or exchange, subject to return only when material in Siemens' opinion has express economic value for potential resale. If returned product is a result of error(s) on the part of Siemens, a full credit to your account will be allowed including freight charges. All other returns, freight and handling will be prepaid by customer.

In all cases except when alleged personal injury/product liability is involved, your account will be credited and a credit memo will be issued within 15 working days from receipt of material. Credit is determined either from the original invoice if referenced, or current stock pricing – less restocking charges, cash discount application and repack-

aging fees where applicable. Shipments returned without referencing a returned goods authorization (RGA) number will be refused by Siemens. Siemens reserves the right to rebill within 90 days from our receipt of material based on results of a physical inspection of the product.

All claims for loss, damage or delays in transit are to be transacted by the consignee directly with the carrier. The issuance of this RETURN GOODS AUTHORIZATION shall not be construed as an acceptance of any responsibility or liability on the part of the Company or as a waiver of any right to make a determination as to the Company's responsibility.

Return goods authorizations will be automatically cancelled and have no further effect unless the returned goods are received by the Company within 60 days after the date of issuance.

Accommodation return

Accommodation returns provide Siemens customers the opportunity to return product ordered in error or in excessive quantities. Products eligible for return must be of current design and revision level, unopened, unused, undamaged, in the original "as-shipped" package and securely packed to be received by Siemens without damage. Software may only be returned when the seal has not been broken. Customized, engineered and/or energized products may not be returned without prior approval and in Siemens' opinion have express economic value for potential resale.

Accommodation returns are subject to a 10 % restocking charge. If cleaning or repackaging is necessary, an additional 15 % per item repackaging charge will be deducted from any credit issued. After inspection of the returned product, your account will be credited for the full invoice value of the merchandise, less applicable charges.

Customer should not deduct credit for products returned from payments. Credit will be processed within 15 days of receipt of material. The customer is responsible for costs, including freight and handling, for returned product to Siemens.

Siemens error return

Siemens error returns provide customers the opportunity to return material within 60 days of shipment in the event of a Siemens order or shipment error. Original purchase order, invoice number and date must be referenced. Products must be unopened, unused, undamaged, in the original "as-shipped" package or in static protection, and securely packed to be received by Siemens without damage. Software may only be returned when seal has not been broken.

A return goods authorization (RGA) number will be issued as authorization to return the product(s) to Siemens. After receipt and inspection of the returned product, a credit will be issued for the full invoice value of the merchandise, or a replacement part provided. If the returned product(s) packaging is deemed not saleable, a 15 % per item charge will be deducted from the credit issued.

Product should be returned collect by a Siemens approved freight carrier or freight charges may be assessed. Freight charges will be credited if the entire shipment is returned due to Siemens error.

Non-Conforming product warranty return

Non-Conforming product warranty returns enable Siemens customers to return product to the factory for replacement, exchange or credit if found to be non-conforming in accordance with the conditions of the Company's product warranty.

It is at Siemens discretion whether to replace, repair or issue a credit for non-conforming products. The warranty at no cost is conditional, and will be determined by a technical validation of the warranty once the non-conforming item is received in our repair department or authorized service center. Please note, if you should fail to return the non-conforming part within 10 days upon instructions from Siemens, you will be invoiced in full for the replacement part.

Product should be returned collect by a Siemens approved freight carrier, or freight charges may be assessed.

Servomotors

Appendix

Customer service

Siemens return goods process – Accommodation

A Return Goods Request/ Authorization (RGA) is required to accompany all products returned to Siemens. This insures that the returned product is properly identified and credited to your account. Unauthorized returns will be refused and returned to the customer with no liability to Siemens.

Accommodation return

Accommodation returns provide Siemens customers the opportunity to return product ordered in error or in excessive quantities.

Procedures

- A. Customer contacts Customer Service or inside sales person to initiate return of material.
- B. Products must be unopened, unused, undamaged, in the original "as-shipped" package or in static protection, and securely packed to be received by Siemens without damage. Software may only be returned when seal has not been broken.
- C. Siemens Energy & Automation will process your request and a return goods authorization (RGA) number will be issued as authorization to return the product(s) to Siemens.
- D. A copy of your approved RGA and shipping instructions will be faxed to you.
- E. Customer ships product to designated Siemens location. A Return Goods Request/Authorization (RGA) is required to accompany all material returned to Siemens.
- F. The customer is responsible for costs, including freight and handling, for returned product to Siemens.
- G. For all material returned in conformance with this policy, a credit will be issued promptly by Siemens within 15 days of receipt of material.
- H. Customers should not take a deduction for material returned until Siemens has issued the above mentioned credit.
- I. All returned materials are subject to inspection by Siemens. Returns not complying with this policy will be returned to their sending location.

- J. Stock products are subject to a 10 % restocking charge. Customized and engineered products are subject to a negotiated restocking charge.
- K. An additional 15 % re-packaging charge will be applied for returned material not suitable for resale, or returned in broken inner cartons requiring inspection and re-packaging. No re-packaging charge of any kind will be applied when material is returned in undamaged, original inner/outer cartons suitable for resale.

Siemens return goods process – Siemens error

A Return Goods Request/ Authorization (RAG) is required to accompany all products returned to Siemens. This insures that the returned product is properly identified and credited to your account. Unauthorized returns will be refused and returned to the customer with no liability to Siemens.

Siemens error return

Siemens error returns provide customers the opportunity to return material within 60 days of shipment in the event of a Siemens order or shipment error.

Procedures

- A. Customer contacts Customer Service or inside sales person to initiate return of material. Original purchase order number or invoice number must be available for reference.
- B. Products must be unopened, unused, undamaged, in the original "as-shipped" package or in static protection, and securely packed to be received by Siemens without damage. Software may only be returned when seal has not been broken.
- C. Siemens will process your request and a return goods authorization (RGA) number will be issued as authorization to return the product(s) to Siemens.
- D. A copy of your approved RGA and shipping instructions will be faxed to you.
- E. Customer ships product to designated Siemens location. A Return Goods Request/Authorization (RGA) is required to accompany all material returned to Siemens.

Synchronous Servomotors

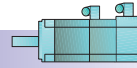

- F. Material should be returned following the Routing/Preferred Carrier instructions located on the shipping instructions. If these instructions are not followed freight charges may be assessed.
- G. For all material returned in conformance with this policy, a credit will be issued within 15 days of receipt of material or a replacement part provided.
- H. Customers should not take a deduction for material returned. Siemens will issue a credit within 15 days of receipt of material.
- I. All returned materials are subject to inspection by Siemens. Returns not complying with this policy will be returned to their sending location.
- J. An additional 15 % re-packaging charge will be applied for returned material not suitable for resale, or returned in broken inner cartons requiring inspection and re-packaging. No re-packaging charge of any kind will be applied when material is returned in undamaged, original inner/outer cartons suitable for resale.

Siemens return goods process – Non-Conforming (Warranty)

A Return Goods Request/ Authorization (RAG) is required to accompany all products returned to Siemens. This insures that the returned product is properly identified and credited to your account. Unauthorized returns will be refused and returned to the customer with no liability to Siemens.

Non-Conforming product return (Drives)

Non-Conforming product warranty returns enable Siemens customers to return product to the factory for replacement, exchange or credit if found to be non-conforming in accordance with the conditions of the Company's product warranty.

Procedures

- A. Customer contacts Technical Support (1-800-333-7421) to initiate return of material. A list of products requested to return and alleged failure scenarios are communicated to Siemens for processing.

Asynchronous Servomotors



- B. Siemens will process your request and a return goods authorization (RGA) number will be issued as authorization to return the product(s) to Siemens.
- C. If the return is an emergency, e.g. your equipment is down, and the warranty can be validated commercially, for approved product categories Siemens will ship a replacement part to you at no charge. If you should fail to return the non-conforming part within 10 days upon instructions from Siemens, you will be invoiced in full for the replacement part.
- D. A copy of your approved RGA and shipping instructions will be faxed to you.
- E. Customer ships product to designated Siemens location. A Return Goods Request/Authorization (RGA) is required to accompany all material returned to Siemens.
- F. Material should be returned following the Routing/Preferred Carrier instructions located on the shipping instructions. If these instructions are not followed freight charges may be assessed.
- G. Conforming products will be shipped back to the customer.
- H. For all material returned in conformance with this policy, a credit will be issued by Siemens after an evaluation of the received material or a replacement part provided.
- I. Customers should not take a deduction for material returned.
- J. All returned materials are subject to inspection by Siemens. Returns not complying with this agreement will be returned to their sending location.



Asynchronous Servomotors

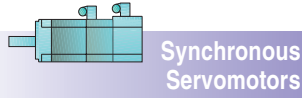

Synchronous Servomotors

Optional warranties

Repair, replacement, and warranty service

All claims for warranty repair or replacement must initially be made to Drives Technical Service at 1-800-333-7421. Should the problem not be solved over the phone, an RGA will be issued to return the defective part. If the warranty can be validated commercially (ship date falls within warranty period) a replacement part can be shipped if available. SE&A will pay for best way freight on such replacements. The customer is responsible for expedited freight delivery.

Once the defective product has been returned, a technical evaluation will be performed to validate the warranty. Should the unit be found to not meet warranty requirements, and purchase order will be requested from the customer.

If your warranty has expired, you may still want to take advantage of our excellent repair and replacement service. Highly trained technicians perform incoming tests to determine the exact failure, repair the equipment, and fully test prior to shipment back to the customer. However, if you elect, we may be able to send you a remanufactured part for 60 % of the list price of a new part less your applicable discount on an exchange basis. Remanufactured parts carry a ninety (90) day warranty. Your Sales or Customer Service Representative can tell you which parts are included in our repair and replacement program. Should you take advan-

tage of this program, please note that the original part must be returned to SE&A within ten (10) days, or an invoice will be issued for the additional 40 %.

Replacement warranty

Should a remanufactured replacement of a defective item be the solution to a warranty claim, the remanufactured part shall be under warranty for the duration of the warranty of the original item or ninety (90) days, whichever is longer. A remanufactured part (other than original warranty replacement) carries a ninety (90) day warranty.

Extended warranty

Drive products offers an extended warranty for all products sold. An extended warranty of 12 months is offered with a surcharge of 5 % of the net price of the product. This extended warranty offer is only available if ordered prior to time of original shipment from Siemens.

Deferred warranty

Siemens also offers a deferred warranty for all products sold. Commissioning must also be purchased to inspect the condition of the drive and supervise the start up. This deferred warranty offer is only available if ordered prior to time of original shipment from Siemens. The deferred warranty is offered for those applications that will have a delayed installation period, but only require a 12 month warranty from the date of commissioning. The chart below is a listing of the warranty periods and fees for the deferred warranty and the extended warranty programs.

Months from	Standard warranty	6 month deferred warranty	12 month deferred warranty
Installation	12	12	12
Manufacturing	18	24	30
% of net	0 %	1 %	2 %

Siemens technical services

The Technical Service Group is responsible for technical service support for customers, field service, and sales engineers. Requests for parts, equipment commissioning, emergency service, or routine maintenance are coordinated and scheduled through this group.

Service coordination and technical support for a wide variety of drive products, including both domestic and international supplied units, are available from this team. Interfacing with the Siemens Service Organization, other Siemens Divisions, and supplier service facilities, this group is the single point of contact in effectively providing remote technical and field service support.

Over the past year, an internal survey showed that greater than 95 % of the problems called in were resolved over the telephone. This level of technical expertise has significantly reduced the number of on-site service calls.

Technical Service is available 24-hours, 7 days a week by dialing 1-800-333-7421; ask for Drives Technical Services and the call will be channeled automatically through a call center which activates the appropriate personnel for both parts and technical support.

Siemens emergency access

The Drive Products Business Unit has an emergency spare parts depot at Atlanta Hartsfield International Airport. Same day delivery requirements are often serviced out of this Depot as well as after hour shipments including weekends and holidays. This has allowed us to expedite emergency shipment, saving several hours in the process.

To activate our Emergency/After Hours Service, simply dial 1-800-333-7421 and ask for Drives Technical Service and the call will be automatically transferred to our message service, who will in turn page the On-Call Representative.

Tell the operator there is an emergency and you would like to contact after hour's personnel for spare parts or technical service, and we will return your call immediately.

Servomotors

Appendix

Conversion tables

Synchronous Servomotors

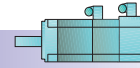

Asynchronous Servomotors



Rotary inertia (to convert from A to B, multiply by entry in table)

A \ B	lb-in ²	lb-ft ²	lb-in-s ²	lb-ft-s ² slug-ft ²	Kg-cm ²	Kg-cm-s ²	gm-cm ²	gm-cm-s ²	oz-in ²	oz-in-s ²
lb-in ²	1	6.94×10^{-3}	2.59×10^{-3}	2.15×10^{-4}	2.926	2.98×10^{-3}	2.92×10^3	2.984	16	4.14×10^{-2}
lb-ft ²	144	1	0.3729	3.10×10^{-2}	421.40	0.4297	4.21×10^5	429.71	2304	5.967
lb-in-s ²	386.08	2.681	1	8.33×10^{-2}	1.129×10^{-3}	1.152	1.129×10^6	1.152×10^3	6.177×10^3	16
lb-ft-s ² slug-ft ²	4.63×10^3	32.17	12	1	1.35×10^{-4}	13.825	1.355×10^7	1.38×10^4	7.41×10^{-4}	192
Kg-cm ²	0.3417	2.37×10^{-3}	8.85×10^{-4}	7.37×10^{-5}	1	1.019×10^{-3}	1000	1.019	5.46	1.42×10^{-2}
Kg-cm-s ²	335.1	2.327	0.8679	7.23×10^{-2}	980.66	1	9.8×10^5	1000	5.36×10^3	13.887
gm-cm ²	3.417×10^{-4}	2.37×10^{-6}	8.85×10^{-7}	7.37×10^{-8}	1×10^{-3}	1.01×10^{-6}	1	1.01×10^{-3}	5.46×10^{-3}	1.41×10^{-5}
gm-cm-s ²	0.335	2.32×10^{-3}	8.67×10^{-4}	7.23×10^{-5}	0.9806	1×10^{-3}	980.6	1	5.36	1.38×10^{-2}
oz-in ²	0.0625	4.34×10^{-4}	1.61×10^{-4}	1.34×10^{-5}	0.182	1.86×10^{-4}	182.9	0.186	1	2.59×10^{-3}
oz-in-s ²	24.13	0.1675	6.25×10^{-2}	5.20×10^{-3}	70.615	7.20×10^{-2}	7.09×10^4	72.0	386.08	1

Torque (to convert from A to B, multiply by entry in table)

A \ B	lb-in	lb-ft	oz-in	N-m	Kg-cm	Kg-m	gm-cm	dyne-cm
lb-in	1	8.333×10^{-2}	16	0.113	1.152	1.152×10^{-2}	1.152×10^3	1.129×10^6
lb-ft	12	1	192	1.355	13.825	0.138	1.382×10^4	1.355×10^7
oz-in	6.25×10^{-2}	5.208×10^{-3}	1	7.061×10^{-3}	7.200×10^{-2}	7.200×10^{-4}	72.007	7.061×10^7
N-m	8.850	0.737	141.612	1	10.197	0.102	1.019×10^4	1×10^7
Kg-cm	0.8679	7.233×10^{-2}	13.877	9.806×10^{-2}	1	10^{-2}	1000	9.806×10^5
Kg-m	86.796	7.233	1.388×10^3	9.806	100	1	1×10^5	9.806×10^7
gm-cm	8.679×10^{-4}	7.233×10^{-5}	1.388×10^{-2}	9.806×10^{-5}	1×10^{-3}	1×10^{-5}	1	980.665
dyne-cm	8.850×10^{-7}	7.375×10^{-8}	1.416×10^{-5}	10^{-7}	1.0197×10^{-6}	1.019×10^{-8}	1.019×10^{-3}	1

Length (to convert from A to B, multiply by entry in table)

A \ B	Inches	feet	cm	yd	mm	m
Inches	1	0.0833	2.54	0.028	25.4	0.0254
feet	12	1	30.48	0.333	304.8	0.3048
cm	0.3937	0.03281	1	1.09×10^{-2}	10	0.01
yd	36	3	91.44	1	914.4	0.914
mm	0.03937	0.00328	0.1	1.09×10^{-3}	1	0.001
m	39.37	3.281	100	1.09	1000	1

Mass (to convert from A to B, multiply by entry in table)

A \ B	lb	oz	gm	slug
lb	1	16	453.6	0.0311
oz	6.25×10^{-2}	1	28.35	1.93×10^{-3}
gm	2.205×10^{-3}	3.527×10^{-3}	1	6.852×10^{-5}
slug	32.17	514.8	1.459×10^4	1

Power (to convert from A to B, multiply by entry in table)

A \ B	H.P.	Watts
H.P. (English)	1	745.7
(lb-in)(deg./sec)	2.645×10^{-6}	1.972×10^{-3}
(lb-in)(RPM)	1.587×10^{-5}	1.183×10^{-2}
(lb-ft)(deg./sec)	3.173×10^{-5}	2.366×10^{-2}
(lb-ft)(RPM)	1.904×10^{-4}	0.1420
Watts	1.341×10^{-3}	1

Rotation (to convert from A to B, multiply by entry in table)

A \ B	RPM	rad/sec.	degrees/sec.
RPM	1	0.105	6.0
rad/sec.	9.55	1	57.30
degrees/sec.	0.167	1.745×10^{-2}	1

Temperature conversion

°F	°C	°C	°F
0	-17.8	-10	14
32	0	0	32
50	10	10	50
70	21.1	20	68
90	32.2	30	86
98.4	37	37	98.4
212	100	100	212
subtract 32 and multiply by $\frac{5}{9}$		multiply by $\frac{5}{9}$ and add 32	

Force (to convert from A to B, multiply by entry in table)

A \ B	lb	oz	gm	dyne	N
lb	1	16	453.6	4.448×10^{-5}	4.4482
oz	0.0625	1	28.35	2.780×10^{-4}	0.27801
gm	2.205×10^{-3}	0.03527	1	1.02×10^{-3}	N.A.
dyne	2.248×10^{-6}	3.59×10^{-5}	890.7	1	0.00001
N	0.22481	3.5967	N.A.	100.000	1

A



Asynchronous
Servomotors

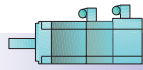

Synchronous
Servomotors

Conversion tables

Mechanism Efficiencies

Acme-screw with brass nut	~0.35–0.65
Acme-screw with plastic nut	~0.50–0.85
Ball-screw	~0.85–0.95
Chain and Sprocket	~0.95–0.98
Preloaded Ball-screw	~0.75–0.85
Spur or Bevel-gears	~0.90
Timing Belts	~0.96–0.98
Worm Gears	~0.45–0.85
Helical Gear (1 reduction)	~0.92

Friction Coefficients

Materials	μ
Steel on Steel (greased)	~0.15
Plastic on Steel	~0.15–0.25
Copper on Steel	~0.30
Brass on Steel	~0.35
Aluminium on Steel	~0.45
Steel on Steel	~0.58

Mechanism	μ
Ball Bushings	<0.001
Linear Bearings	<0.001
Dove-tail slides	~0.2++
Gibb Ways	~0.5++

Material Densities

Material	lb-in ³	gm-cm ³
Aluminium	0.096	2.66
Brass	0.299	8.30
Bronze	0.295	8.17
Copper	0.322	8.91
Hard Wood	0.029	0.80
Soft Wood	0.018	0.48
Plastic	0.040	1.11
Glass	0.079–0.090	2.2–2.5
Titanium	0.163	4.51
Paper	0.025–0.043	0.7–1.2
Polyvinyl chloride	0.047–0.050	1.3–1.4
Rubber	0.033–0.036	0.92–0.99
Silicone rubber, without filler	0.043	1.2
Cast iron, grey	0.274	7.6
Steel	0.280	7.75

Servomotors

Appendix

Standard terms and conditions of sale

Synchronous Servomotors

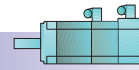

Asynchronous Servomotors

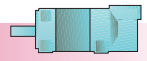

Standard terms and conditions of sale (9/1/2001)

Siemens Energy & Automation, Inc. ("Seller")

1. WARRANTY

- (a) Seller warrants that on the date of shipment the goods are of the kind and quality described herein and are free of nonconformities in workmanship and material. This warranty does not apply to goods delivered by Seller but manufactured by others.
- (b) Buyer's exclusive remedy for a nonconformity in any item of the goods shall be the repair or the replacement (at Seller's option) of the item and any affected part of the goods. Seller's obligation to repair or replace shall be in effect for a period of one (1) year from initial operation of the goods but not more than eighteen (18) months from Seller's shipment of the goods, provided Buyer has sent written notice within that period of time to Seller that the goods do not conform to the above warranty. Repaired and replacement parts shall be warranted for the remainder of the original period of notification set forth above, but in no event less than 12 months from repair or replacement. At its expense, Buyer shall remove and ship to Seller any such nonconforming items and shall reinstall the repaired or replaced parts. Buyer shall grant Seller access to the goods at all reasonable times in order for Seller to determine any nonconformity in the goods. Seller shall have the right of disposal of items replaced by it. If Seller is unable or unwilling to repair or replace, or if repair or replacement does not remedy the nonconformity, Seller and Buyer shall negotiate an equitable adjustment in the contract price, which may include a full refund of the contract price for the nonconforming goods.
- (c) SELLER HEREBY DISCLAIMS ALL OTHER WARRANTIES, EXPRESS OR IMPLIED, EXCEPT THAT OF TITLE. SPECIFICALLY, IT DISCLAIMS THE IMPLIED WARRANTIES OF MERCHANTABILITY, FITNESS FOR A PARTICULAR PURPOSE, COURSE OF DEALING AND USAGE OF TRADE.
- (d) Buyer and successors of Buyer are limited to the remedies specified in this article and shall have no others for a nonconformity in the goods. Buyer agrees that these remedies provide Buyer and its successors with a minimum adequate remedy and are their exclusive remedies, whether Buyer's or its successors' remedies are based on contract, warranty, tort (including negligence), strict liability, indemnity, or any other legal theory, and whether arising out of warranties, representations, instructions, installations, or nonconformities from any cause.
- (e) Note: This article 1 does not apply to any software which may be furnished by Seller. In such cases, the attached Software License Addendum applies.

2. PATENTS

Seller shall pay costs and damages finally awarded in any suit against Buyer or its vendees to the extent based upon a finding that the design or construction of the goods as furnished infringes a United States patent (except infringement occurring as a result of incorporating a design or modification at Buyer's request), provided that Buyer promptly notifies Seller of any charge of infringement, and Seller is given the right at its expense to settle such charge and to defend or control the defense of any suit based upon such charge. Seller shall have no obligation hereunder with respect to claims, suits or proceedings, resulting from or related to, in whole or in part, (i) the use of software or software documentation, (ii) compliance with Buyer's specifications, (iii) the combination with, or modification of, the goods after delivery by Seller, or (iv) the use of the goods, or any part thereof, in the practice of a process. THIS ARTICLE SETS FORTH SELLER'S ENTIRE LIABILITY WITH RESPECT TO PATENTS.

3. PERFORMANCE; DELAYS

Timely performance by Seller is contingent upon Buyer's supplying to Seller, when needed, all required technical information and data, including drawing approvals, and all required commercial documentation. If Seller suffers delay in performance due to any cause beyond its reasonable control, the time of performance shall be extended a period of time equal to the period of the delay and its consequences. Seller will give to Buyer notice within a reasonable time after Seller becomes aware of any such delay.

4. SHIPMENT, TITLE AND RISK OF LOSS

Unless the delivery terms of this contract expressly provide for F.O.B. destination, shipping/delivery will be F.O.B. Seller's point of shipment with title to the goods and risk of loss or damage passing to Buyer at that point. Buyer will be responsible for shipment during transit and for filing any damage or loss claims directly with the carrier. Seller may make partial shipments.

5. TAXES

Any applicable duties or sales, use, excise, value-added or similar taxes will be added to the price and invoiced separately (unless an acceptable exemption certificate is furnished).

6. TERMS OF PAYMENT

- (a) Unless otherwise stated, all payments shall be in United States dollars, and a pro rata payment shall become due as each shipment is made. If shipment is delayed by Buyer, date of notice of readiness for shipment shall be deemed to be date of shipment for payment purposes.
- (b) On late payments, the contract price shall, without prejudice to Seller's right to immediate payment, be increased by 1 1/2 % per month on the unpaid balance, but not to exceed the maximum permitted by law.
- (c) If any time in Seller's judgment Buyer is unable or unwilling to meet the terms specified, Seller may require satisfactory assurance or full or partial payment as a condition to commencing or continuing manufacture or making shipment, and may, if shipment has been made, recover the goods from the carrier, pending receipt of such assurances.

7. NONCANCELLATION

Buyer may not cancel or terminate for convenience, or direct suspension of manufacture, except with Seller's written consent and then only upon terms that will compensate Seller for its engineering, fabrication and purchasing charges and any other costs relating to such cancellation, termination or suspension, plus a reasonable amount for profit.

8. NUCLEAR

Buyer represents and warrants that the goods covered by this contract shall not be used in or in connection with a nuclear facility or application. If Buyer is unable to make such representation and warranty, then Buyer agrees to indemnify and hold harmless Seller and to waive and require its insurers to waive all right of recovery against Seller for any damage, loss, destruction, injury or death resulting from a "nuclear incident", as that term is defined in the Atomic Energy Act of 1954, as amended, whether or not due to Seller's negligence.

9. LIMITATION OF LIABILITY

Neither Seller, nor its suppliers shall be liable, whether in contract, warranty, failure of a remedy to achieve its intended or essential purposes, tort (including negligence), strict liability, indemnity or any other legal theory, for loss of use, revenue or profit, or for costs of capital or of substitute use or performance, or for indirect, special, liquidated, incidental or consequential damages, or for any other loss or cost of a similar type, or for claims by Buyer for damages of Buyer's customers. Seller's maximum liability under this contract shall be the contract price. Buyer and Seller agree that the exclusions and limitations set forth in this article are separate and independent from any remedies which Buyer may have hereunder and shall be given full force and effect whether or not any or all such remedies shall be deemed to have failed of their essential purpose.

10. GOVERNING LAW AND ASSIGNMENT

The laws of the State of Georgia shall govern the validity, interpretation and enforcement of this contract, without regard to its conflicts of law principles. The application of the United Nations Convention on Contracts for the International Sale of Goods shall be excluded. Assignment may be made only with written consent of both parties; provided, however, Seller may assign to its affiliate without Buyer's consent.

11. ATTORNEY FEES

Buyer shall be liable to Seller for any attorney fees and costs incurred by Seller in enforcing any of its rights hereunder.

12. DISPUTES

Either party may give the other party written notice of any dispute arising out of or relating to this contract and not resolved in the normal course of business. The parties shall attempt in good faith to resolve such dispute promptly by negotiations between executives who have authority to settle the dispute. If the matter has not been resolved within 60 days of the notice, either party may initiate non-binding mediation of the dispute.

13. STATUTE OF LIMITATIONS

To the extent permitted by applicable law, any lawsuit for breach of contract, including breach of warranty, arising out of the transactions covered by this contract, must be commenced not later than twelve (12) months from the date the cause of action accrued.

14. PRICES

In the event of a price increase or decrease, the price of goods on order will be adjusted to reflect such increase or decrease. This does not apply to a shipment held by request of Buyer. Goods already shipped are not subject to price increase or decrease. Orders on a bid or contract basis are not subject to this article. Seller's prices include the costs of standard domestic packing only. Any deviation from this standard packing (domestic or export), including U.S. Government sealed packing, will result in extra charges. To determine such extra charges, consult Seller's sales offices. Orders of less than \$400 will be charged a \$25 handling fee.

15. ADDITIONAL TERMS OF PAYMENT

- (a) Invoice payment terms are as shown on latest discount sheets as issued from time to time. Cash discounts are not applicable to notes or trade acceptances, to prepaid transportation charges when added to Seller's invoices or to discountable items if there are undisputed past due items on the account. Portions of an invoice in dispute should be deducted and the balance remitted with a detailed explanation of the deduction. Cash discounts will only be allowed on that portion of the invoice paid within the normal discount period.
- (b) Freight will be allowed to any common-carrier free-delivery point within the United States, excluding Alaska and Hawaii, on shipments exceeding \$1000 net or more providing Seller selects the carrier. On shipments to Alaska and Hawaii, freight will be allowed to dockside at the listed port of debarkation nearest the destination point on shipments of \$1000 net or more. Buyer shall pay all special costs such as cartage, stevedoring and insurance. Special freight allowances are as shown on latest discount sheets as issued from time to time. Cataloged weights are estimated, not guaranteed. Seller assumes no responsibility for tariff classifications on carriers.

16. CHANGES IN LAWS AND REGULATIONS

Seller's prices and timely performance are based on all applicable laws, rules, regulations, orders, codes, standards or requirements of governmental authorities effective on the date of Seller's proposal. Any change to any law, rule, regulation, order, code, standard or requirement which requires any change hereunder shall entitle Seller to an equitable adjustment in the prices and any time of performance.



Siemens Energy & Automation, Inc.

Automation and Drives
Motion Control Systems
5300 Triangle Parkway
Norcross, GA 30092

siemens world wide: www.siemens.com

Siemens Energy & Automation: www.sea.siemens.com

Order No.: DRSP-02062