

Electric capacitive type proximity sensor

■ Features



- Sensing of iron, metal, plastic, water, stone, wood etc.
- Long life cycle and high reliability
- Integrated surge protection circuit
- Integrated reverse polarity protection circuit (DC type)
- Easy to adjust of the sensing distance with sensitivity adjuster
- Red LED status indication
- Easy to control of level and position



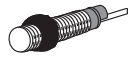

⚠ Please read "Caution for your safety" in operation manual before using.

■ Type

◎ DC 3-wire type

Appearances	Model
M18 	CR18-8DN
	CR18-8DP
	CR18-8DN2 ※
M30 	CR30-15DN
	CR30-15DP
	CR30-15DN2 ※

◎ AC 2-wire type

Appearances	Model
M18 	CR18-8AO
	CR18-8AC
M30 	CR30-15AO
	CR30-15AC

▶ "※" mark can be customized.

■ Specifications

Model	CR18-8DN CR18-8DP CR18-8DN2	CR30-15DN CR30-15DP CR30-15DN2	CR18-8AO CR18-8AC	CR30-15AO CR30-15AC
Sensing distance	8mm	15mm	8mm	15mm
Hysteresis	Max. 20% of sensing distance			
Standard sensing target	50×50×1mm (Iron)			
Setting distance	0 to 5.6mm	0 to 10.5mm	0 to 5.6mm	0 to 10.5mm
Power supply (Operating voltage)	12-24VDC (10-30VDC)		100-240VAC (85-264VAC)	
Current consumption	Max. 15mA		—	
Leakage consumption	—		Max. 2.2mA	
Response frequency(*1)	50Hz		20Hz	
Residual voltage	Max. 1.5V		Max. 20V	
Affection by Temp.	±10% Max. for sensing distance at 20°C within temperature range of -25 to 70°C			
Control output	Max. 200mA		Max. 5 to 200mA	
Insulation resistance	Min. 50MΩ (at 500VDC megger)			
Dielectric strength	1500VAC 50/60Hz for 1 minute			
Vibration	1mm amplitude at frequency of 10 to 55Hz in each of X, Y, Z directions for 2 hours			
Shock	500m/s ² (50G) in X, Y, Z direction for 3 times			
Indicator	Output operation indicator (Red LED)			
Ambient temperature	-25 to 70°C (at non-freezing status)			
Storage temperature	-30 to 80°C (at non-freezing status)			
Ambient humidity	35 to 95%RH			
Protection circuit	Surge protection circuit, Reverse polarity protection circuit		Overload & Short protection circuit	
Protection	IP66 (IEC standard)	IP65 (IEC standard)	IP66 (IEC standard)	IP65 (IEC standard)
Cable	φ 4 × 3P, 2m		φ 4 × 2P, 2m	
Material	CR18 Series ☞ Case and nut : PA6, General cable (Black) : Polyvinyl chloride (PVC) CR30 Series ☞ Case and nut : Nickel-plated brass, Washer : Nickel-plated steel, Sensing part : Heat-resistant ABS, General cable (Black) L Polyvinyl chloride (PVC)			
Unit weight	Approx. 72g	Approx. 212g	Approx. 63g	Approx. 220g

※ (*1) The response frequency is the average value. The standard sensing target is used and the width is set as 2 times of the standard sensing target, 1/2 of the sensing distance for the distance.

(A) Photo electric sensor
(B) Fiber optic sensor
(C) Door/Area sensor
(D) Proximity sensor
(E) Pressure sensor
(F) Rotary encoder
(G) Connector/Socket
(H) Temp. controller
(I) SSR/Power controller
(J) Counter
(K) Timer
(L) Panel meter
(M) Tacho/Speed/Pulse meter
(N) Display unit
(O) Sensor controller
(P) Switching power supply
(Q) Stepping motor & Driver & Controller
(R) Graphic/Logic panel
(S) Field network device
(T) Production stoppage models & replacement

CR Series

Dimensions

● CR18-8D□

● CR18-8A□

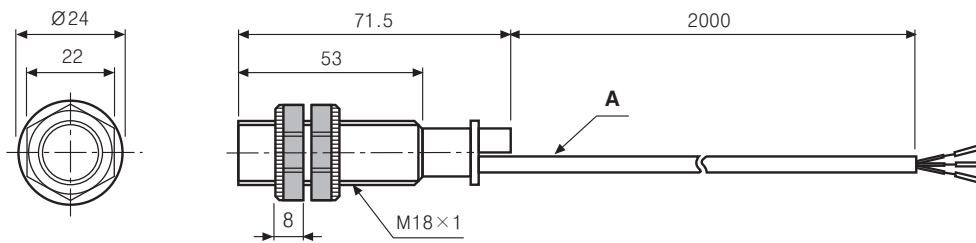

● CR30-15D□

● CR30-15A□

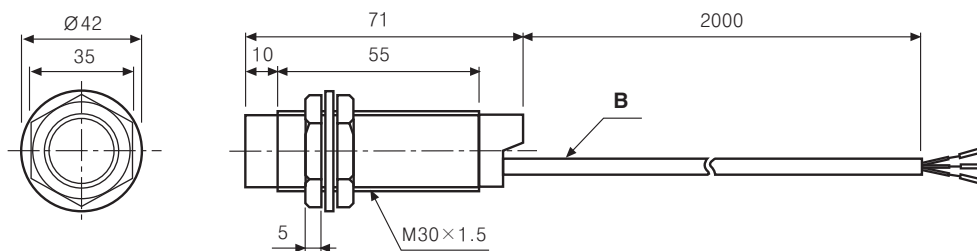

※ "A" type : $\phi 4$, 2 cores / $\phi 4$, 3 cores (Conductor cross section: 0.3mm^2 , Insulator diameter: $\phi 1.25$)

※ "B" type : $\phi 5$, 2 cores / $\phi 5$, 3 cores (Conductor cross section: 0.3mm^2 , Insulator diameter: $\phi 1.25$)

(Unit:mm)

Control output diagram

DC 3-wire type

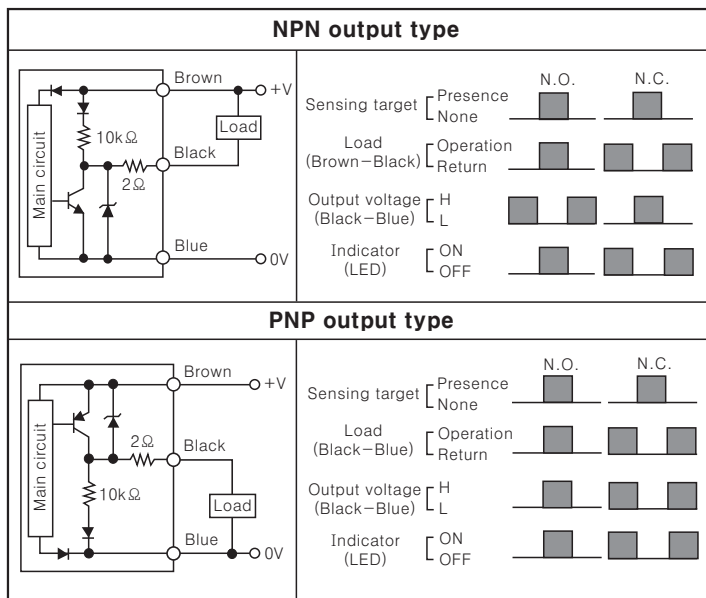

AC 2-wire type

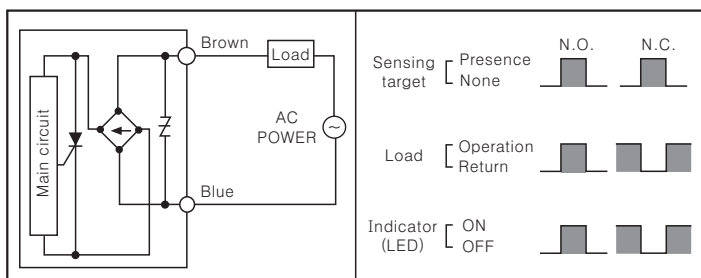

Connections

DC 3-wire type

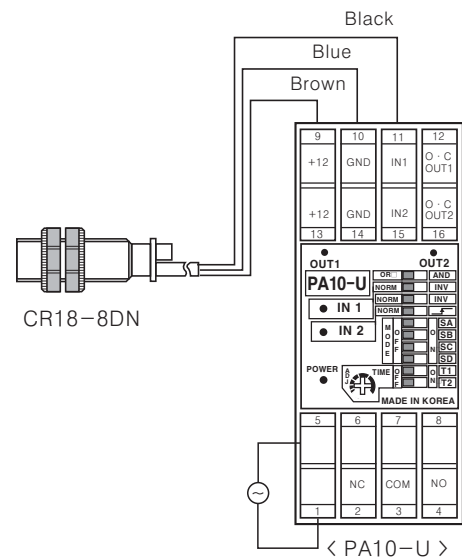

AC 2-wire type

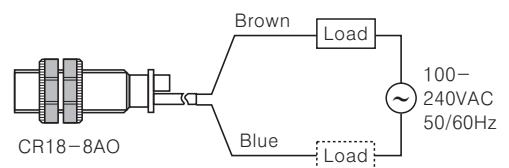

※ The load can be connected to either wire.

Electric Capacitive Type

■ Sensitivity adjustment

Please turn potentio VR to set sensitivity as below procedure.

- 1 Without a sensing object, turn the potentio VR to the right and stop at the proximity sensor is ON(OFF).
- 2 Put the object in right sensing position, turn the potentio VR to the left and stop at the proximity sensor is OFF(ON).

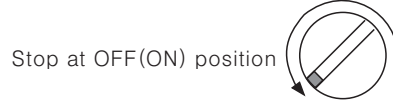
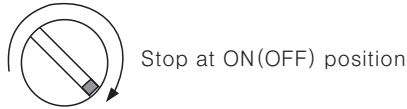

- 3 If the difference of the number of potentio VR rotation between the ON(OFF) point and the OFF(ON) point is more than 1.5 turns, the sensing operation will be stable.
- 4 If it is set in sensitivity adjustment position of potentio VR at center between 1 and 2, sensitivity setting will be completed.

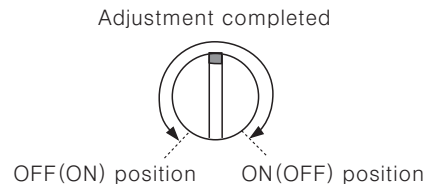
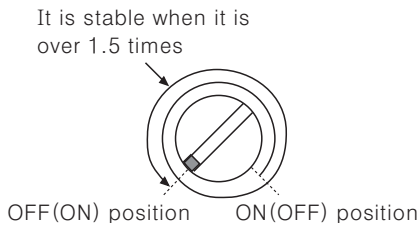

- ※ When there is distance fluctuation between proximity sensor and the target, please adjust 2 at the farthest distance from this unit.
- ※ Turning potentio VR toward clockwise, it will be max. and turning toward counter clockwise, it will be min. the number of adjustment should be 15 ± 3 revolution and if it is turned to the right or left excessively, it will not stop, but it idles without breakdown.
- ※ () is for Normally closed type.

■ Grounding

The sensing distance will be changed by grounding status of capacitive proximity sensor and the target [50×50×1mm (Iron)]. Please check the material when installing it on panel.

● CR18 Series

Ground condition (Switch b)	ON	OFF
Operating distance (mm)	8	4

● CR30 Series

Ground condition	Switch a	ON	OFF	ON	OFF
	Switch b	ON	ON	OFF	OFF
Operating distance (mm)		15	18	6	6

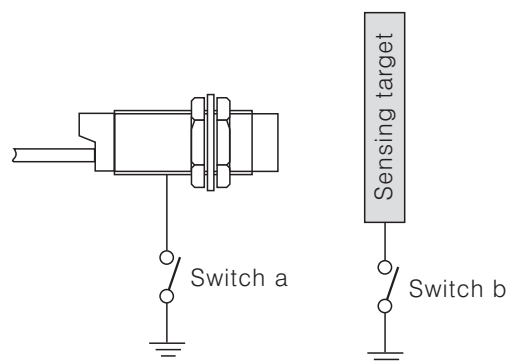
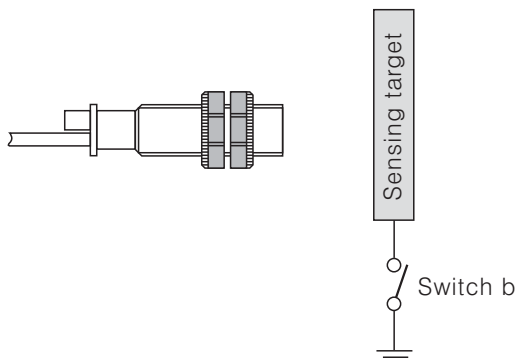

(A)	Photo electric sensor
(B)	Fiber optic sensor
(C)	Door/Area sensor
(D)	Proximity sensor
(E)	Pressure sensor
(F)	Rotary encoder
(G)	Connector/Socket
(H)	Temp. controller
(I)	SSR/Power controller
(J)	Counter
(K)	Timer
(L)	Panel meter
(M)	Tacho/Speed/Pulse meter
(N)	Display unit
(O)	Sensor controller
(P)	Switching power supply
(Q)	Stepping motor & Driver & Controller
(R)	Graphic/Logic panel
(S)	Field network device
(T)	Production stoppage models & replacement

CR Series

■ Mutual-interference & Influence by surrounding metals

When several proximity sensors are mounted close to one another a malfunction of the sensor may be caused due to mutual interference. Therefore, be sure to provide a minimum distance between the two sensors as below chart indicates.

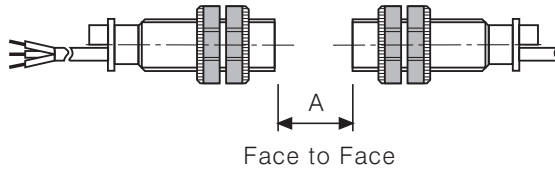

Face to Face

Model Item	CR18	CR30
A	48	90
B	54	90

(Unit:mm)

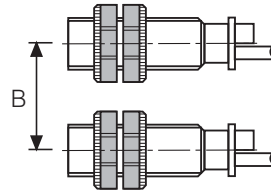

Parallel

When sensors are mounted on metallic panel, you must prevent the sensors from being affected by any metallic object except target. Therefore, be sure to provide a minimum distance as below chart indicates.

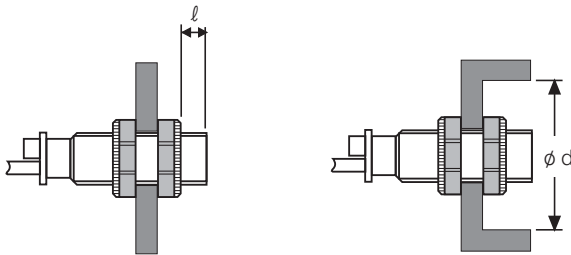

Model Item	CR18	CR30
l	20	10
ϕd	54	90
m	24	45
n	54	90

(Unit:mm)

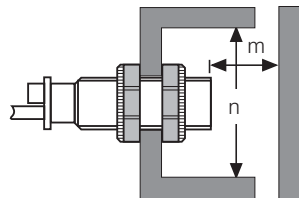

■ Materials

○ Materials of sensing targets

Sensing distance may be different by electrical characteristic of sensing target (conductivity, non dielectric constant) and status of water absorption, size etc.

○ Effect by high frequency electrical field

It may cause malfunction by machinery which generate high frequency of electrical field such as a washing machine etc.

○ Surrounding environment

There is water or oil on surface of sensing part, it may cause malfunction.

If the bottle for sensing of level is coated by oil etc., it may cause malfunction.

Especially, 15mm type has high sensitivity for induced objects, please be careful of waterdrops.

○ Oil

Do not let the oil or oil liquid is flowed into the sensor, the case is made by plastic.