

Features

2, 3 & 4 Pole relay interface modules,
27 mm wide.

Ideal interface for PLC and electronic systems

- 58.32 - 2 Pole 10 A**
- 58.33 - 3 Pole 10 A**
- 58.34 - 4 Pole 7 A**

- AC coils and DC coils
- Supply status indication and coil suppression module as standard
- Identification label
- Cadmium Free contacts
- UL Listed
- 35 mm rail (EN 50022) mounting

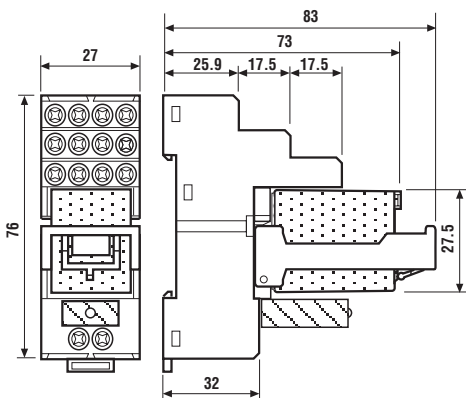

58.32



- 2 pole 10 A
- 35 mm rail mounting

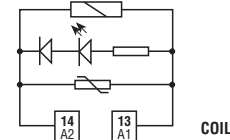
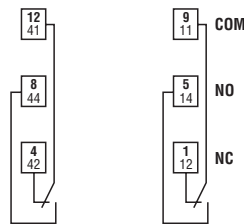

Example: AC

58.33



- 3 pole 10 A
- 35 mm rail mounting

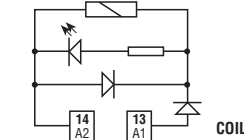
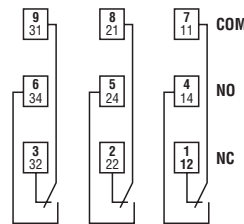

Example: DC

58.34



- 4 pole 7 A
- 35 mm rail mounting

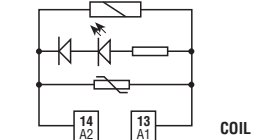
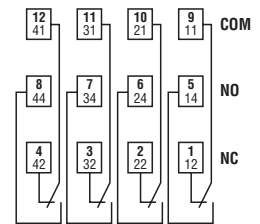

Example: AC

Contact specification

Contact configuration		2 CO (DPDT)	3 CO (3PDT)	4 CO (4PDT)
Rated current/Maximum peak current	A	10/20	10/20	7/15
Rated voltage/Maximum switching voltage	V AC	250/400	250/400	250/250
Rated load AC1	VA	2,500	2,500	1,750
Rated load AC15 (230 V AC)	VA	500	500	350
Single phase motor rating (230 V AC)	kW	0.37	0.37	0.125
Breaking capacity DC1: 30/110/220V	A	10/0.25/0.12	10/0.25/0.12	7/0.25/0.12
Minimum switching load	mW (V/mA)	300 (5/5)	300 (5/5)	300 (5/5)
Standard contact material		AgNi	AgNi	AgNi

Coil specification

Nominal voltage (U _N)	V AC (50/60 Hz)	12 - 24 - 48 - 110 - 120 - 230	12 - 24 - 48 - 110 - 120 - 230	12 - 24 - 48 - 110 - 120 - 230
	V DC	12 - 24 - 48	12 - 24 - 48	12 - 24 - 48
Rated power AC/DC	VA (50 Hz)/W	1.5/1	1.5/1	1.5/1
Operating range	AC	(0.8...1.1)U _N	(0.8...1.1)U _N	(0.8...1.1)U _N
	DC	(0.8...1.1)U _N	(0.8...1.1)U _N	(0.8...1.1)U _N
Holding voltage	AC/DC	0.8 U _N /0.5 U _N	0.8 U _N /0.5 U _N	0.8 U _N /0.5 U _N
Must drop-out voltage	AC/DC	0.2 U _N /0.1 U _N	0.2 U _N /0.1 U _N	0.2 U _N /0.1 U _N

Technical data

Mechanical life AC/DC	cycles	20 · 10 ⁶ /50 · 10 ⁶	20 · 10 ⁶ /50 · 10 ⁶	20 · 10 ⁶ /50 · 10 ⁶
Electrical life at rated load AC1	cycles	200 · 10 ³	200 · 10 ³	150 · 10 ³
Operate/release time	ms	9/3 (AC) - 9/15 (DC)	9/3 (AC) - 9/15 (DC)	9/3 (AC) - 9/15 (DC)
Insulation between coil and contacts (1.2/50 μs)	kV	3.6	3.6	3.6
Dielectric strength between open contacts	V AC	1,000	1,000	1,000
Ambient temperature range	°C	-40...+70	-40...+70	-40...+70
Protection category		IP 20	IP 20	IP 20

Approvals relay (according to type)



Ordering information

Example: 58 series 35 mm rail (EN 55022) mounting interface module, 4 CO (4PDT), 24 V DC coil, green LED + diode.

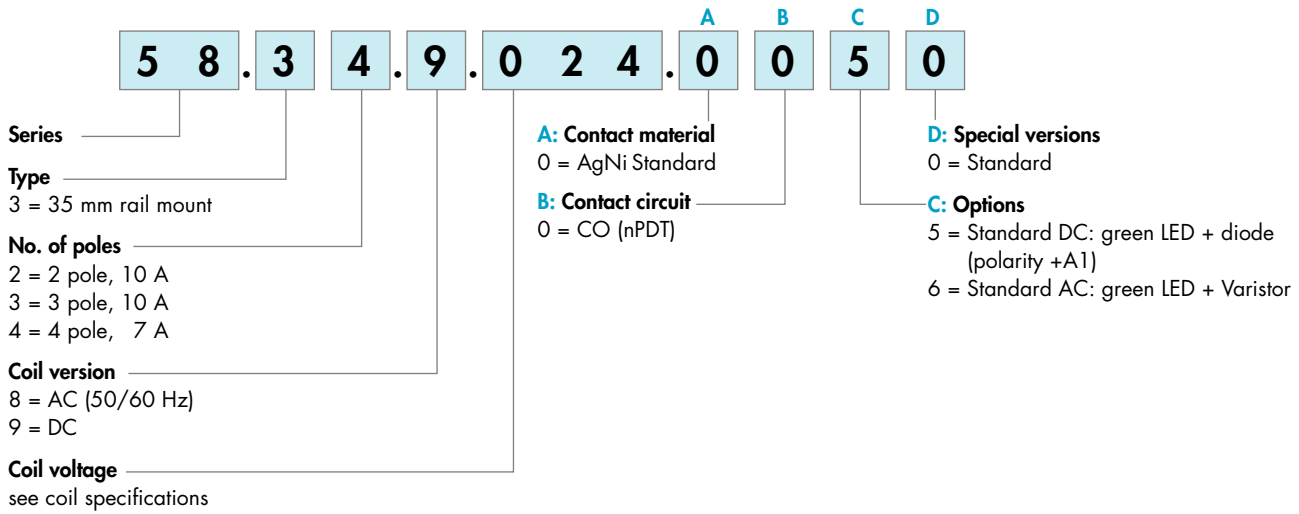

Technical data

Insulation

Insulation according to EN 61810-1 ed. 2	insulation rated voltage	V	400 (2-3 pole)	250 (4 pole)
	rated impulse withstand voltage	kV	3.6 (2-3 pole)	2.5 (4 pole)
	pollution degree		2	
	overvoltage category		III	

Insulation between coil and contacts (1.2/50 μs)	kV	3.6
--	----	-----

Dielectric strength between open contacts	V AC	1,000
---	------	-------

Dielectric strength between adjacent contacts	V AC	2,000 (58.32, 58.33)	1,550 (58.34)
---	------	----------------------	---------------

Conducted disturbance immunity

Burst (5...50)ns, 5 kHz, on A1 - A2	EN 61000-4-4	level 4 (4 kV)
-------------------------------------	--------------	----------------

Surge (1.2/50 μs) on A1 - A2 (differential mode)	EN 61000-4-5	level 4 (4 kV)
--	--------------	----------------

Other data

Bounce time: NO/NC	ms	1/4
--------------------	----	-----

Vibration resistance (10...55)Hz, max. ± 1 mm: NO/NC	g/g	6/6
--	-----	-----

Power lost to the environment	without contact current	W	1
	with rated current	W	3 (58.32, 58.34) 4 (58.33)

Wire strip length	mm	8
-------------------	----	---

Screw torque	Nm	0.5
--------------	----	-----

Max. wire size		solid cable	stranded cable
	mm ²	1x6 / 2x2.5	1x4 / 2x2.5
	AWG	1x10 / 2x14	1x12 / 2x14

Contact specification

F 58 - Electrical life (AC) v contact current
2 & 3 pole relays

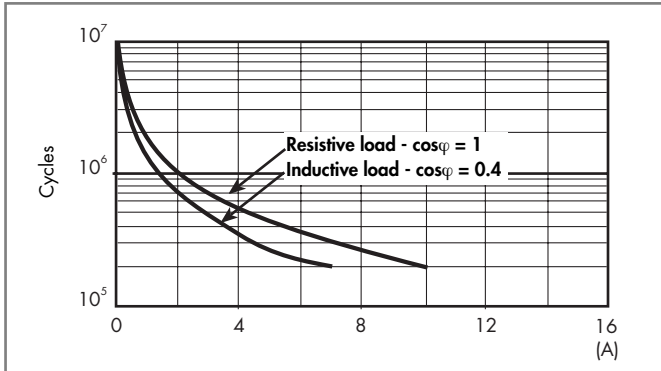

F 58 - Electrical life (AC) v contact current
4 pole relay

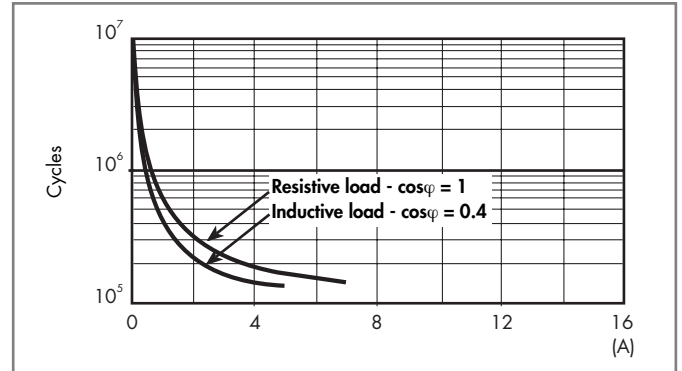

H 58 - Maximum DC1 breaking capacity

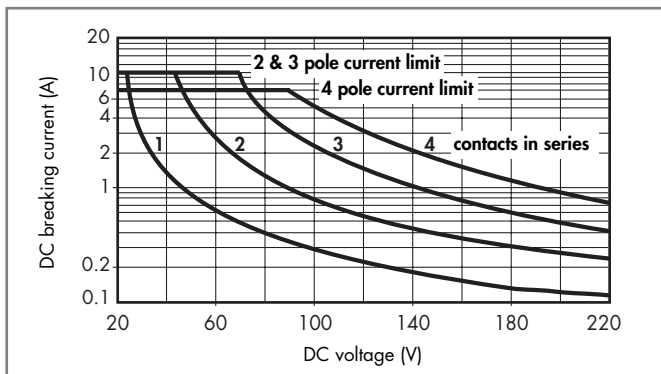

- When switching a resistive load (DC1) having voltage and current values under the curve, an electrical life of $\geq 100 \cdot 10^3$ can be expected.
- In the case of DC13 loads, the connection of a diode in parallel with the load will permit a similar electrical life as for a DC1 load. Note: the release time for the load will be increased.

58

Coil specifications

DC coil data

Nominal voltage U_N V	Coil code	Operating range		Resistance R Ω	Rated coil absorption I at U_N mA
		U_{min} V	U_{max} V		
12	9.012	9.6	13.2	140	86
24	9.024	19.2	26.4	600	40
48	9.048	38.4	52.8	2,400	20

AC coil data

Nominal voltage U_N V	Coil code	Operating range		Resistance R Ω	Rated coil absorption I at U_N (50Hz) mA
		U_{min} V	U_{max} V		
12	8.012	9.6	13.2	50	97
24	8.024	19.2	26.4	190	53
48	8.048	38.4	52.8	770	25
110	8.110	88	121	4,000	12.5
120	8.120	96	132	4,700	12
230	8.230	184	253	17,000	6

R 58 - DC coil operating range v ambient temperature

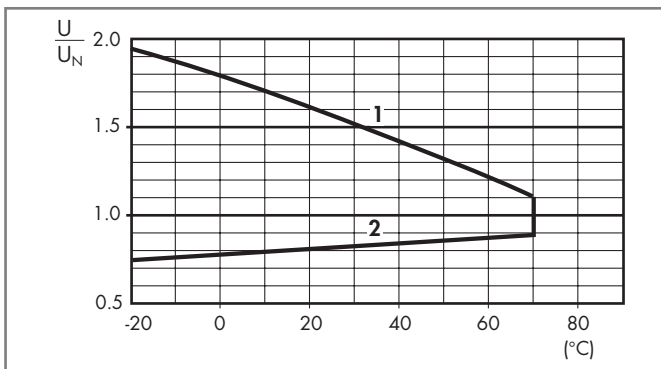

- 1 - Max. permitted coil voltage.
2 - Min. pick-up voltage with coil at ambient temperature.

R 58 - AC coil operating range v ambient temperature

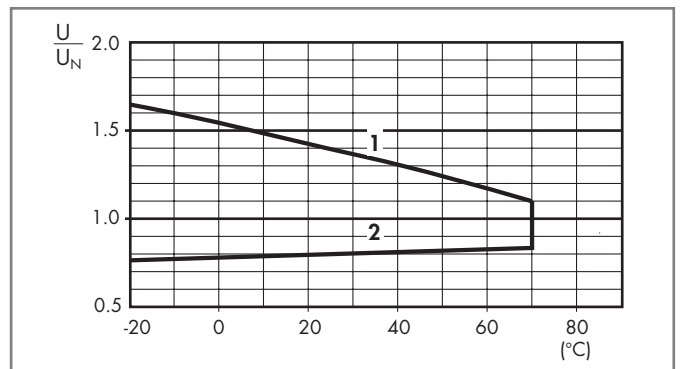

- 1 - Max. permitted coil voltage.
2 - Min. pick-up voltage with coil at ambient temperature.

Combinations

Code	Type of socket	Type of relay	Module	Retaining clip
58.32	94.02	55.32	99.02	094.01
58.33	94.03	55.33	99.02	094.01
58.34	94.04	55.34	99.02	094.01

Accessories



094.06

6-way jumper link	094.06
Rated values	10 A - 250 V

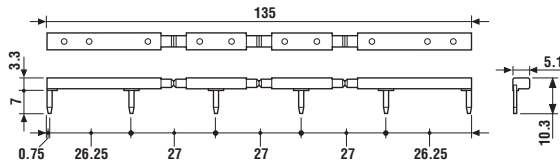

060.72

Sheet of marker tags, plastic, 72 tags, 6x12 mm	060.72
--	--------

58

Packaging codes

How to code and identify retaining clip and packaging options for relay interface module.

Code options according to the last three letters:

