

**IEC62055-31 UC3 compliant
1 Form A 90A power
latching relays**

DZ-S RELAYS (ADZS)

New

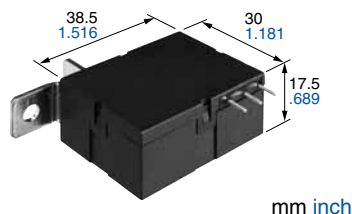

RoHS compliant

FEATURES

- IEC62055-31 UC3 compliant**
- High switching capacity**
90 A 250 VAC (Resistive load)
- Low operating power**
1 coil latching: 1.5 W
2 coil latching: 3.0 W
- Small size:**
W: 38.5 x L: 30 x H: 17.5 mm
W: 1.516 x L: 1.181 x H: .689 inch

TYPICAL APPLICATIONS

- Smart meters
- Charge station
- Time switch
- Other industrial equipment

Protective construction: Dust cover type

ORDERING INFORMATION

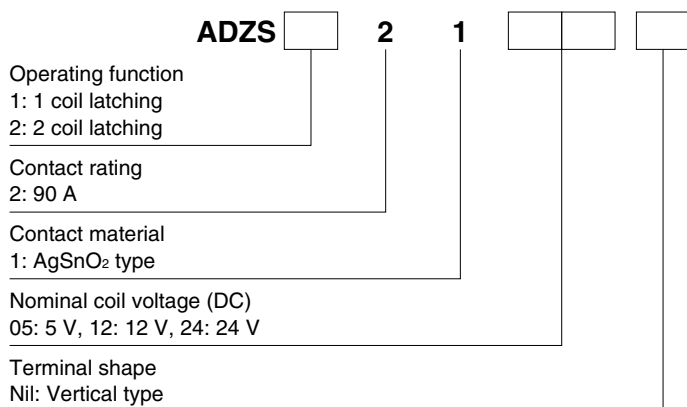

* Horizontal type and harness attached type are also available. Please consult us for details.

TYPES

Contact arrangement	Rated voltage	Part No.		Standard packing	
		1 coil latching	2 coil latching	Carton	Case
1 Form A	5V DC	ADZS12105	ADZS22105	20 pcs.	200 pcs.
	12V DC	ADZS12112	ADZS22112		
	24V DC	ADZS12124	ADZS22124		

RATING

1. Coil data

1) 1 coil latching type

Rated voltage	Set voltage *1 (at 20°C 68°F)	Reset voltage*1 (at 20°C 68°F)	Rated operating current (DC, ±10%, at 20°C 68°F)	Coil resistance (±10%, at 20°C 68°F)	Rated operating power	Max. allowable voltage (at 20°C 68°F)
5V DC	70%V or less of nominal voltage (Initial)	70%V or less of nominal voltage (Initial)	300 mA	16.7Ω	1.5W	130%V of rated voltage
12V DC			125 mA	96 Ω		
24V DC			62.5 mA	384 Ω		

*1: Square, pulse drive

2) 2 coil latching type

Rated voltage	Set voltage *1 (at 20°C 68°F)	Reset voltage*1 (at 20°C 68°F)	Rated operating current (DC, ±10%, at 20°C 68°F)	Coil resistance (±10%, at 20°C 68°F)	Rated operating power	Max. allowable voltage (at 20°C 68°F)
5V DC	70%V or less of nominal voltage (Initial)	70%V or less of nominal voltage (Initial)	600 mA	8.3Ω	3.0W	130%V of rated voltage
12V DC			250 mA	48 Ω		
24V DC			125 mA	192 Ω		

*1: Square, pulse drive

2. Specifications

Characteristics	Item	Specifications
Contact data	Arrangement	1 Form A
	Contact voltage drop (initial)	Max. 0.09V (at 90A), Max. 0.05V (at 10A)
	Contact material	AgSnO ₂ alloy
	Contact rating (resistive)	90 A 250 V AC
	Max. switching power (resistive)	24,840 VA
	Max. switching voltage	276 V AC
	Max. switching current	90 A AC
	Min. switching load (reference value)*1	100 mA 125 V AC
Insulation resistance (initial)		Min. 1,000MΩ (at 500V DC) Measured portion is the same as the case of dielectric voltage.
Dielectric strength (initial)	Between open contacts	2,000 Vrms for 1 min. (detection current: 10 mA)
	Between contact and coil	4,000 Vrms for 1 min. (detection current: 10 mA)
Surge withstand voltage (initial)*2	Between contact and coil	12,000 V
Operate time (initial)		Max. 20 ms (at rated voltage, at 20°C 68°F, without bounce)
Release time (initial)		Max. 20 ms (at rated voltage, at 20°C 68°F, without bounce)
Shock resistance	Functional	300 m/s ² (half-wave pulse of sine wave: 11 ms; detection time: 10 μs)
	Destructive	1,000 m/s ² (half-wave pulse of sine wave: 6 ms.)
Vibration resistance	Functional	10 to 55 Hz at double amplitude of 1.5 mm (detection time: 10 μs)
	Destructive	10 to 55 Hz at double amplitude of 2.0 mm
Expected life	Mechanical	Min. 10 ⁵ (at 180 times/min.)
Conditions	Conditions for operation, transport and storage*3 *4	Ambient temperature: -40 to +85°C -40 to +185°F Humidity: 5 to 85% R.H. (Not freezing and condensing at low temperature)
Unit weight		Approx. 45 g .14 oz

Notes: *1. This value can change due to the switching frequency, environmental conditions, and desired reliability level, therefore it is recommended to check this with the actual load.

*2. Wave is standard shock voltage of ±1.2×50 μs according to JEC-212-1981

*3. The upper limit of the ambient temperature is the maximum temperature that can satisfy the coil temperature rise value. Refer to Usage, transport and storage conditions in NOTES.

*4. Allowable current when ambient temperature over 70°C 158°F is 70A

3. Expected electrical life

Type	Load	Switching capacity	Number of operations
1 Form A	Resistive	90 A 250V AC	Min. 1×10 ⁴ (ON:OFF=2s:4s)
	UC2 Class (IEC62055-31)*	90 A 276V AC (COSφ=1.0:5,000 cycles, COSφ=0.5:5,000 cycles)	Min. 1×10 ⁴ (ON:OFF=10s:20s)

*Based on IEC62055-31 UC2, inductive load test was conducted after resistive load test, and expressed as total.

DIMENSIONS (mm inch)

The CAD data of the products with a **CAD Data** mark can be downloaded from: <http://industrial.panasonic.com/ac/e/>

Vertical terminal type

CAD Data



External dimensions

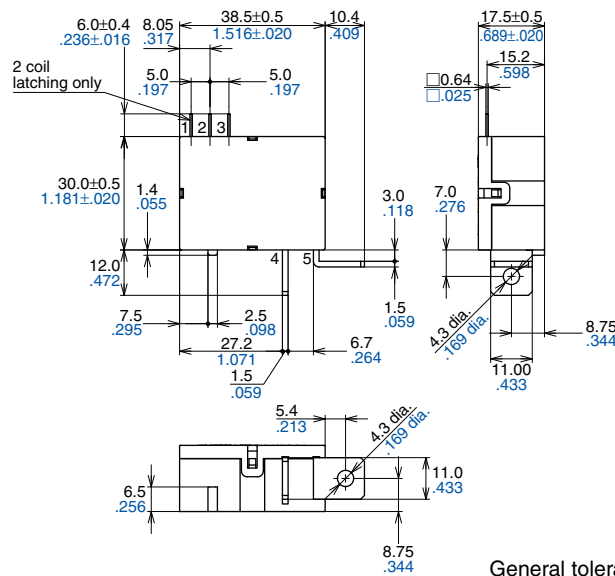

Schematic (Top view)
(Set condition)

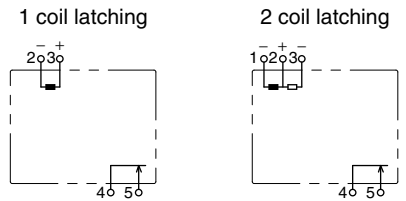

General tolerance: $\pm 0.3 \pm 0.12$

Terminal arrangement example

Design 1

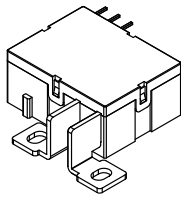

Design 2

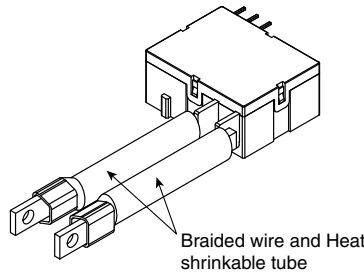

Braided wire and Heat shrinkable tube

Design 3

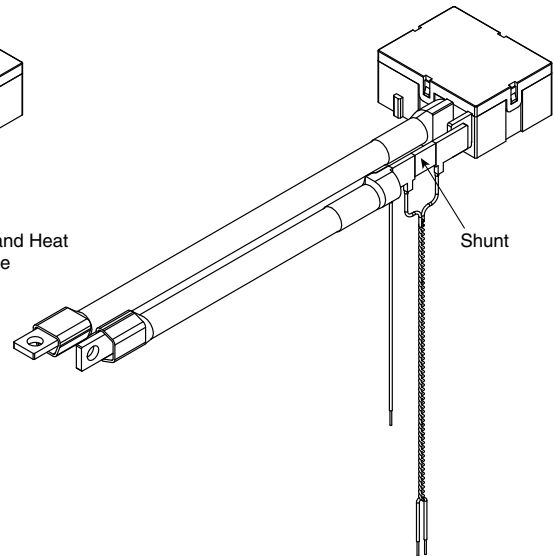

Shunt

* Special orders such as, terminal shape, braided wire length, with/without shunt etc. are available.

SAFETY STANDARDS

This relay is IEC/EN 62055-31 UC3 certified by VDE

NOTES

1. For cautions for use, please read "GENERAL APPLICATION GUIDELINES".

2. This relay is designed to dust cover type. Malfunction and contact failure may result if small insects get inside the relay.

3. Do not apply excessive pressure on the terminals. This could adversely affect relay performance. Use a washer in order to prevent deformation. Keep the installation torque to within 1.2 to 1.4 N·m (12 to 14 kgf·cm). Also, use a spring washer to prevent it from loosening.

4. It is recommended to apply rated coil voltage for Min. 100ms pulse across the ambient temperature and condition change through service life. the coil to secure the sure operation considering

5. Please do not continuously energize to coil over 10 seconds.

Please contact

Panasonic Corporation

Electromechanical Control Business Division

■ 1006, Oaza Kadoma, Kadoma-shi, Osaka 571-8506, Japan
industrial.panasonic.com/ac/e/

Panasonic[®]

©Panasonic Corporation 2017