

Dimensions

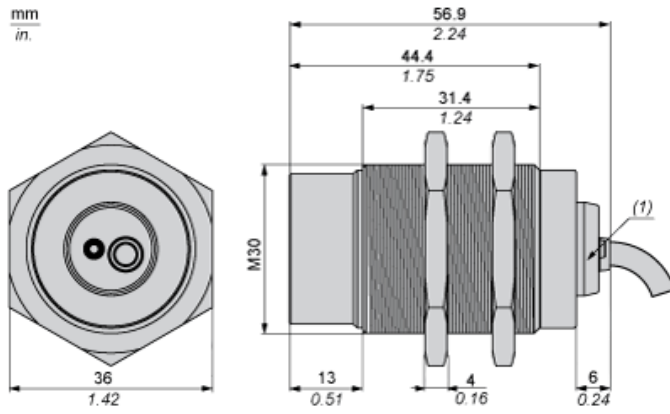

(1) LED

Minimum Mounting Distances

Side by side



$e (1) \geq 60 \text{ mm}/2.36 \text{ in.}$

\geq

Face to face



$e (2) \geq 180 \text{ mm}/7.09 \text{ in.}$

\geq

Facing a metal object

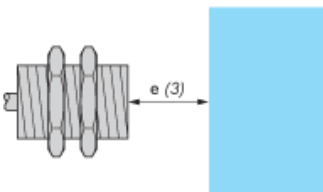

$e (3) \geq 45 \text{ mm}/1.77 \text{ in.}$

\geq

Mounted in a metal support



$d \geq 90 \text{ mm}/3.54 \text{ in.}$

$h \geq 30 \text{ mm}/1.18 \text{ in.}$