

Dimensions

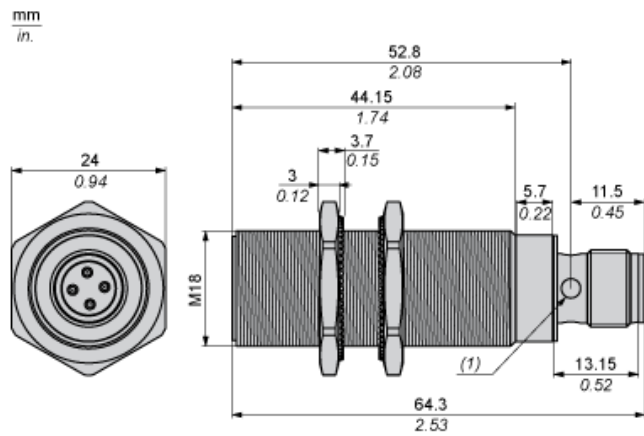

(1) LED

Minimum Mounting Distances

Side by side



e (1) 32 mm/1.26 in.

≥

Face to face



e (2) 96 mm/3.78 in.

≥

Facing a metal object

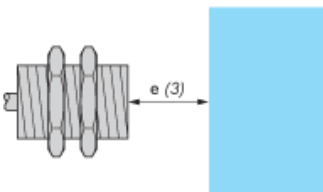

e (3) 24 mm/0.94 in.

≥

Mounted in a metal support



d ≥ 56 mm/2.20 in.

h ≥ 16 mm/0.63 in.