

Dimensions

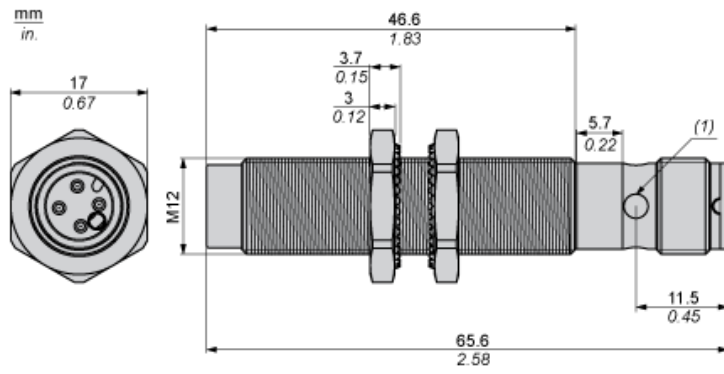

(1) LED

---

Minimum Mounting Distances in mm

---

Side by side



$e (1) \geq 48 \text{ mm}/1.89 \text{ in.}$

Face to face



$e (2) \geq 84 \text{ mm}/3.31 \text{ in.}$

Facing a metal object



$e (3) \geq 21 \text{ mm}/0.83 \text{ in.}$

(1) Metal

(2) Object to be detected