

Dimensions

mm
in.

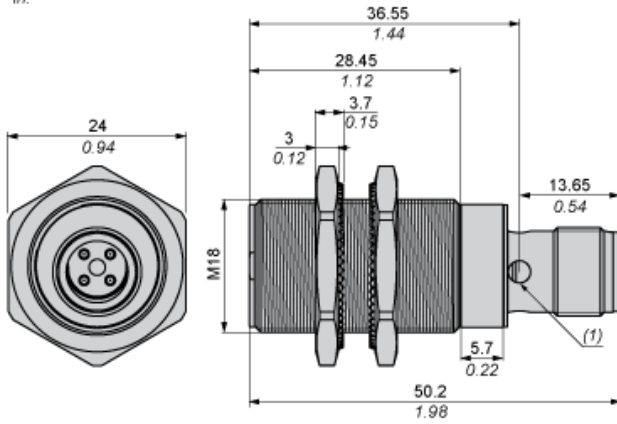

(1) LED

Minimum Mounting Distances

Side by side



$e (1) \geq 32 \text{ mm}/1.26 \text{ in.}$

Face to face



$e (2) \geq 96 \text{ mm}/3.78 \text{ in.}$

Facing a metal object



$e (3) \geq 24 \text{ mm}/0.94 \text{ in.}$

Mounted in a metal support



$d \geq 56 \text{ mm}/2.20 \text{ in.}$

$h \geq 16 \text{ mm}/0.63 \text{ in.}$