

Power PCB Relay RT1 Inrush Power

- 1 pole 16A, 1 form A (NO) contact (W pre-make contact + AgSnO₂)
- 10A/250VAC making and breaking capacity acc. to IEC 60669-1
- 165A/20ms inrush peak current
- Mono- or bistable coil
- 5kV/10mm coil-contact
- Reinforced insulation
- Test tab (manual operator) optional

Typical applications

Lighting systems, movement sensors, filament and incandescent lamp loads, motors



F0272-B



Approvals

VDE REG.-Nr. 6106, UL E214025, cCSAus 14385
Technical data of approved types on request

| Contact Data | RT.3T | RTS3L |
|--|---|--------------------|
| Contact arrangement | 1 form A (NO) contact | |
| Rated voltage | 250VAC | |
| Max. switching voltage | 400VAC | |
| Rated current | 16A | |
| Limiting continuous current | 16A, UL: 20A (RTS3L) | |
| Limiting making current, max. 20ms (incand. lamps) | 165A | 120A |
| max. 200µs (fluorescent lamps) | 800A | - |
| Breaking capacity max. | 4000VA | |
| Contact material | W (pre-make cont.) + AgSnO ₂ | AgSnO ₂ |
| Contact style | pre-make contact | single contact |
| Frequency of operation, with/without load | 360/3600h ⁻¹ | |
| Operate/release time max., DC coil | 10/5ms | |
| Operate/Reset time max., bistable version | 10/10ms | |
| Bounce time max. | 4ms | |

Contact ratings

| Type | Contact | Load | Cycles |
|------------------|-------------------|--|---------------------|
| IEC 61810 | | | |
| RTS3L | A (NO) | 20A, 250VAC resistive, 70°C | 20x10 ³ |
| RTS3L | monostable A (NO) | 16A, 250VAC resistive, 85°C | 100x10 ³ |
| RTS3T | A (NO) | 16A, 250VAC resistive, 85°C | 5x10 ³ |
| UL 508 | | | |
| RTS3L | A (NO) | 20A, 250VAC, general purpose, 70°C | 20x10 ³ |
| RTS3L | A (NO) | 16A, 250VAC, resistive, 85°C | 50x10 ³ |
| RTS3L | A (NO) | TV8, 240VAC, 40°C | 25x10 ³ |
| RTS3L | A (NO) | 1.5hp, 240VAC, 70°C | 30x10 ³ |
| RTS3T | A (NO) | 1200W Tungsten, 120VAC/277VAC, 60Hz, 50°C | 6x10 ³ |
| RTS3T | A (NO) | 620W Discharge lamps (standard ballast), 120VAC/277VAC, 60Hz, 50°C | 6x10 ³ |

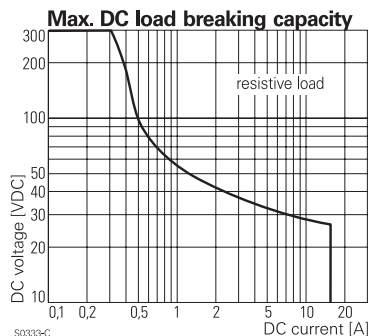

Contact Data (continued)

| | | |
|-----------------------|-------------------------|--------------------------|
| Mechanical endurance | | |
| DC coil | >5x10 ⁶ ops. | >10x10 ⁶ ops. |
| bistable version | >3x10 ⁶ ops. | >5x10 ⁶ ops. |
| tab manually operated | >1x10 ³ ops. | - |

Coil Data, monostable DC coil

| | |
|---|-------------|
| Coil voltage range | 5 to 110VDC |
| Operative range, IEC 61810 | 2 |
| Coil insulation system according UL1446 | class F |

Coil versions, monostable DC coil

| Coil code | Rated voltage VDC | Operate voltage VDC | Release voltage VDC | Coil resistance Ω±10% ¹⁾ | Rated coil power mW |
|-----------|-------------------|---------------------|---------------------|-------------------------------------|---------------------|
| 005 | 5 | 3.5 | 0.5 | 62 | 403 |
| 006 | 6 | 4.2 | 0.6 | 90 | 400 |
| 012 | 12 | 8.4 | 1.2 | 360 | 400 |
| 024 | 24 | 16.8 | 2.4 | 1440 | 400 |
| 048 | 48 | 33.6 | 4.8 | 5520 | 417 |
| 060 | 60 | 42.0 | 6.0 | 8570 ¹⁾ | 420 |
| 110 | 110 | 77.0 | 11.0 | 28800 ¹⁾ | 420 |

1) Coil resistance ±12%.

All figures are given for coil without pre-energization, at ambient temperature +23°C. Other coil voltages on request.

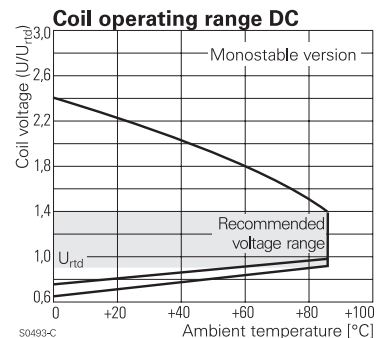

Coil Data, bistable coils

| | 1 coil | 2 coils |
|---|-------------------------------|---------|
| Magnetic system | polarized, bistable | |
| Coil voltage range | 3 to 24VDC | |
| Operative range, IEC 61810 | 2 | |
| Limiting voltage, % of rated coil voltage | 120% | 150% |
| Min./Max. energization duration | 30ms/1min at <10% duty factor | |
| Coil insulation system according UL1446 | class F | |

Power PCB Relay RT1 Inrush Power (Continued)

Coil Data (continued)

Coil versions, bistable

| Coil code | Rated voltage VDC | Set voltage VDC | Reset voltage VDC | Coil resistance $\Omega \pm 10\%$ | Rated coil power mW |
|-----------|-------------------|-----------------|-------------------|-----------------------------------|---------------------|
|-----------|-------------------|-----------------|-------------------|-----------------------------------|---------------------|

Coil versions, bistable 1 coil

| | | | | | |
|-----|----|------|------|------|-----|
| A03 | 3 | 2.1 | 1.7 | 21 | 429 |
| A12 | 12 | 8.4 | 6.6 | 360 | 400 |
| A24 | 24 | 16.8 | 13.2 | 1440 | 400 |

Coil versions, bistable 2 coils

| | | | | | |
|-----|----|------|------|-----|-----|
| F03 | 3 | 2.1 | 1.7 | 15 | 600 |
| F12 | 12 | 8.4 | 6.6 | 240 | 600 |
| F24 | 24 | 16.8 | 13.2 | 886 | 650 |

All figures are given for coil without pre-energization, at ambient temperature +23°C.

Other coil voltages on request.

Bistable coils - operation

| Version | 1 coil | | 2 coils | | |
|----------------|--------|----|---------|----|----|
| Coil terminals | A1 | A2 | A1 | A3 | A2 |
| Operate | + | - | + | + | - |
| Reset | - | + | - | + | - |

Contact position not defined at delivery

Other Data

RT.3T **RTS3L**
Material compliance: EU RoHS/ELV, China RoHS, REACH, Halogen content refer to the Product Compliance Support Center at www.te.com/customer-support/rohssupportcenter

| | | |
|---|--------------------------------|----------------------------|
| Ambient temperature | | |
| monostable DC coil | -40 to 85°C | |
| bistable 1 coil | -10 to 85°C | |
| bistable 2 coils | -40 to 85°C | |
| Category of environmental protection | RTII - flux proof | |
| IEC 61810 | | |
| Vibration resistance (functional), monostable version | 10g | 20g |
| Shock resistance (destructive) | 100g | |
| Terminal type | PCB-THT, plug-in ²⁾ | |
| Weight, without / with test tab | 14/16g | 14g/- |
| Resistance to soldering heat THT | 270°C/10s | |
| IEC 60068-2-20 | | |
| Packaging/unit | | |
| without test tab | tube/20 pcs., box/500 pcs. | tube/20 pcs., box/500 pcs. |
| with test tab | tray/25 pcs., box/100 pcs. | - |

2) RTT3T or bistable 2 coil version: pcb mounting only. See Accessories

Accessories RTS3.

For details see datasheet [Accessories Industrial Power Relay RT](#)

Socket available for 1 coil version only.

NOTE: indicated contact ratings and electrical endurance data for direct wiring of relays (according IEC 61810-1); for relays mounted on sockets deratings may apply.

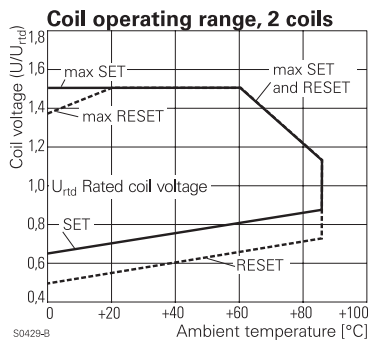
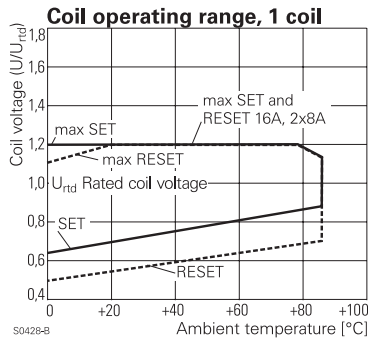

Insulation Data

| | |
|------------------------------------|----------------------|
| Initial dielectric strength | |
| between open contacts | 1250V _{rms} |
| between contact and coil | 5000V _{rms} |
| Clearance/creepage | |
| between contact and coil | ≥10/10mm |
| Material group of insulation parts | IIIa |
| Tracking index of relay base | PTI 250V |

Power PCB Relay RT1 Inrush Power (Continued)

Terminal assignment

Bottom view on solder pins

monostable version

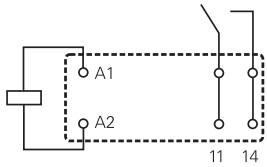

S0163-BF

bistable version

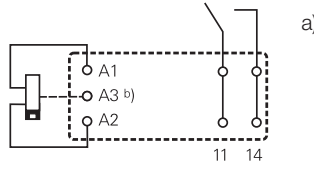

S0163-DPS

a) Indicated contact position during or after coil energization with reset voltage.

b) for 2 coil version only

Dimensions / PCB layout

version without test tab

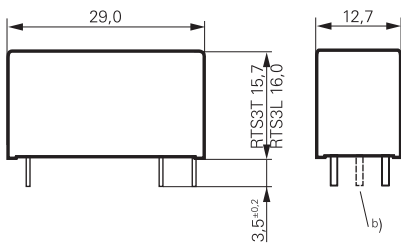

S0272-BW

S0272-BC

16A, pinning 5mm

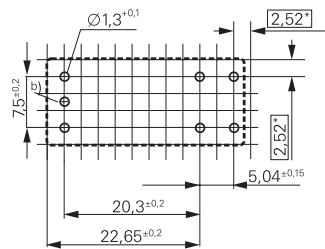

S0418-CV

b) for 2 coil version only

version with test tab

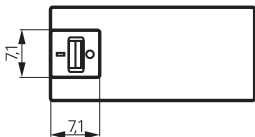

S0491-B

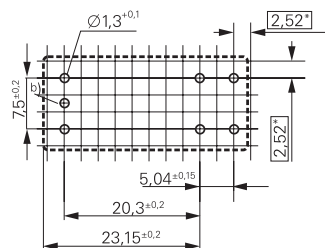
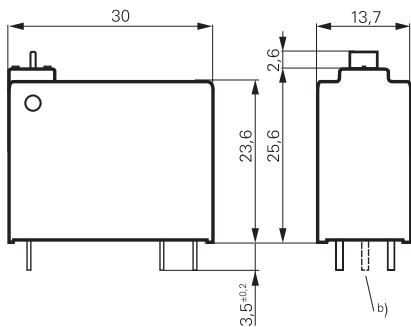

S0492-CU

*) With the recommended PCB hole sizes a grid pattern from 2.5mm to 2.54mm can be used.

Power PCB Relay RT1 Inrush Power (Continued)

| | | | | | | | | | |
|--|--|--|--|--|--|----------|----------|----------|------------|
| Product code structure | | | | | Typical product code | | | | |
| | | | | | RT | S | 3 | T | A12 |
| Type | | | | | | | | | |
| RT Power PCB Relay RT1 Inrush Power | | | | | | | | | |
| Version | | | | | | | | | |
| S Without test tab | | | | | T With test tab (manual operator) for contact material ,T' and bistable coil only | | | | |
| Contact configuration | | | | | | | | | |
| 3 1 form A (NO) contact | | | | | | | | | |
| Contact material | | | | | | | | | |
| L AgSnO ₂ | | | | | T Tungsten (W) pre-make + AgSnO ₂ | | | | |
| Coil | | | | | | | | | |
| Coil code: please refer to coil versions table | | | | | | | | | |

| Product code | Version | Contacts | Contact material | Coil version | Coil | Part number | |
|--------------|----------------------------------|--------------------------|---------------------------------|------------------|-------------------|-------------|-------------|
| RTS3L005 | Without test tab, 16mm high | 1 form A (NO) contact | AgSnO ₂ | Monostable | 5VDC | 1-1415898-8 | |
| RTS3L006 | | | | | 6VDC | 4-1415898-4 | |
| RTS3L012 | | | | | 12VDC | 1-1415898-9 | |
| RTS3L024 | | | | | 24VDC | 1-1415898-4 | |
| RTS3LA12 | | | | | Bistable, 1 coil | 12VDC | 2-1415898-3 |
| RTS3LF12 | Without test tab, 15.7mm high | | W pre-make + AgSnO ₂ | Monostable | Bistable, 2 coils | 2-1415898-5 | |
| RTS3T005 | | | | | 5VDC | 1-1415898-6 | |
| RTS3T012 | | | | | 12VDC | 1415898 | |
| RTS3T024 | | | | | 24VDC | 1415898-1 | |
| RTS3T048 | | | | | 48VDC | 1-1415898-1 | |
| RTS3T060 | | | | | 60VDC | 1-1415898-2 | |
| RTS3TA05 | | | | | Bistable, 1 coil | 5VDC | 1-1415898-5 |
| RTS3TA06 | | | | | | 6VDC | 3-1415898-1 |
| RTS3TA12 | | | | | | 12VDC | 1415898-2 |
| RTS3TF03 | | | | | Bistable, 2 coils | 3VDC | 1415898-4 |
| RTS3TF12 | 12VDC | 1415898-5 | | | | | |
| RTS3TF24 | 24VDC | 1415898-6 | | | | | |
| RTT3TA12 | With test tab, 23.6mm high | | | Bistable, 1 coil | 12VDC | 1415898-7 | |
| RTT3TF24 | | | | | Bistable, 2 coils | 24VDC | 1-1415898-0 |

This list represents the most common types and does not show all variants covered by this datasheet.
Other types on request