

DM-100

Installation manual

Preface

This manual contains information necessary for installation of Delem DM-100 modules on a pressbrake control system. It is meant for service people who are authorised for service and installation of the machine.

Limited guarantee

- The equipment is supplied by Delem without safety features. The machine manufacturer has to ensure a safe environment.
- This equipment must be installed and used in accordance with Delem's specifications. The guarantee on the equipment is invalidated in the event of improper installation and/or use of this equipment.
- The General Terms and Conditions of Delivery of Delem shall apply to this product. These conditions are available from Delem on request.
- This manual does not entitle you to any rights. Delem reserves the right to change this manual without prior warning.
- All rights reserved. The copyright is held by Delem. No part of this publication may be copied or reproduced without written permission from Delem BV.

Table of contents

1. General information	4
1.1. Introduction.....	4
1.2. General specifications.....	5
2. Connector specifications.....	6
2.1. Introduction.....	6
2.2. Power supply.....	7
2.3. Digital I/O.....	8
2.4. Valve.....	10
2.5. Analog A.....	12
2.6. Analog B.....	13
2.7. Encoders.....	15
2.8. HSB interface.....	16
3. The modules.....	17
3.1. Introduction.....	17
3.2. DM-103VA.....	18
3.3. DM-102VA.....	19
3.4. DM-102.....	20
3.5. DM-101.....	21
4. Software settings and diagnostics.....	22
4.1. DM identification.....	22
4.2. DM-103VA.....	23
4.3. DM-102VA.....	23
4.4. DM-102.....	23
4.5. DM-101.....	25
4.6. Status display.....	26

1. General information

1.1. Introduction

This manual contains specifications of the DM-100 series.

The DM-100 module is part of a modular pressbrake control system, with a DAonWindows front-end control as the main unit. There are modules for single axis control, dual axes control and for synchronised Y-axis control.

Via a HSB connection the modules are connected to a DAonWindows control.

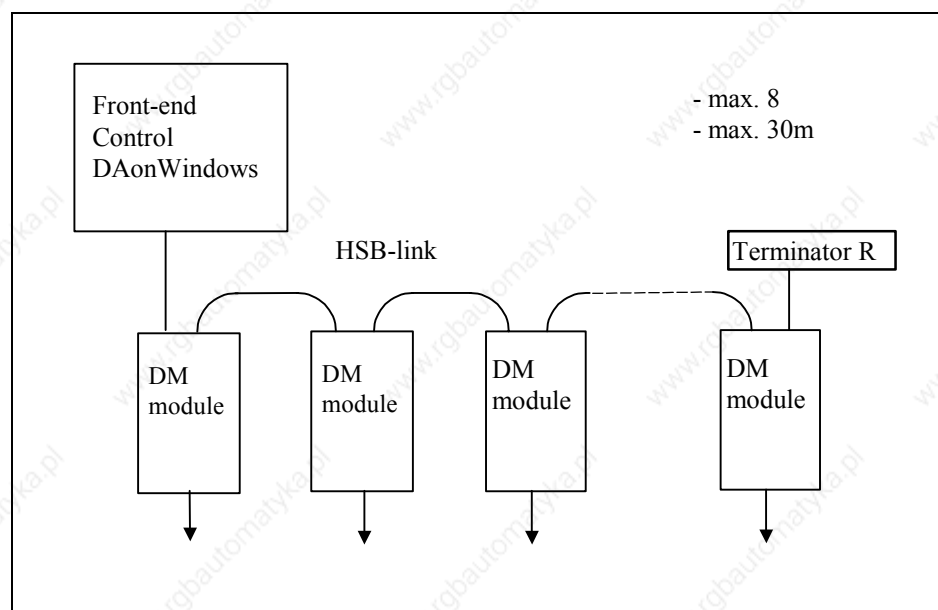

Figure 1.a

1.2. General specifications

The following environment specification values are valid for all DM-modules:

Ambient temperature	5 - 50°C
Storage temperature	min. -40°C max. 70°C
Relative humidity	90 % non-condensing
EMC	designed and built to meet the following standards: IEC61000-4 (immunity) IEC61000-6 (emission)

For ventilation purposes, the module should have a free air space of 50 mm above and below the mounted module and 10 mm on each side.

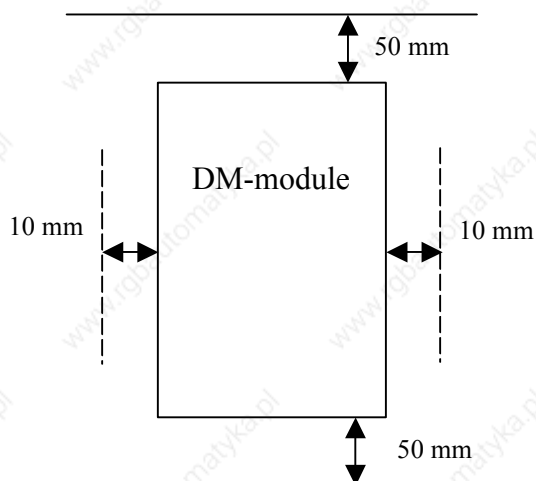

2. Connector specifications

2.1. Introduction

In this chapter all connectors on a DM-100 module are described.

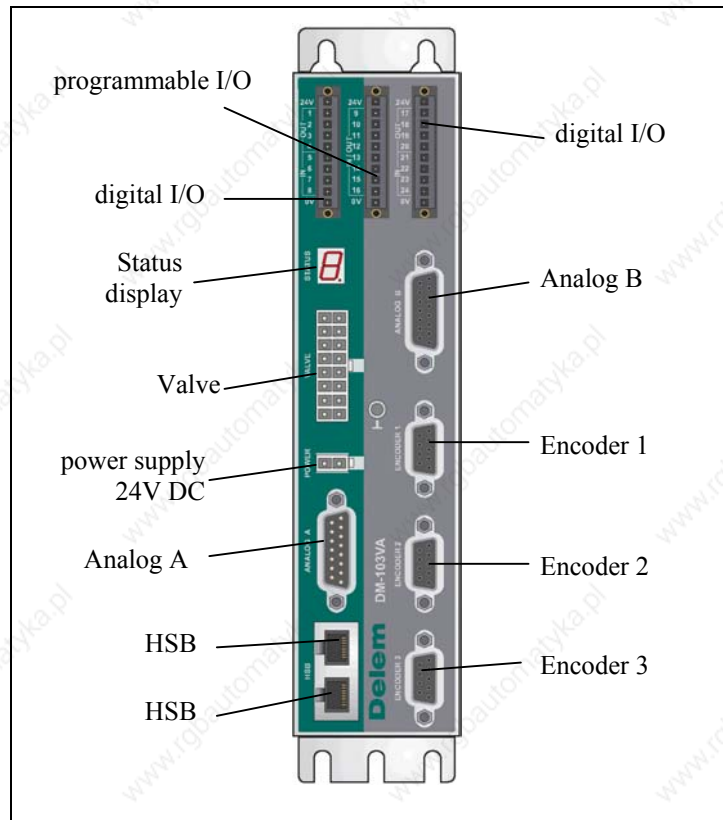

Figure 2.a

Not all connectors are available on each module. For each connector is mentioned on which modules it is implemented. See also chapter 3.

This chapter will focus on the specification of all available connectors.

See also drawing 9084-502 for an overview of the DM-100 series. This drawing is included in the back of this manual.

2.2. Power supply

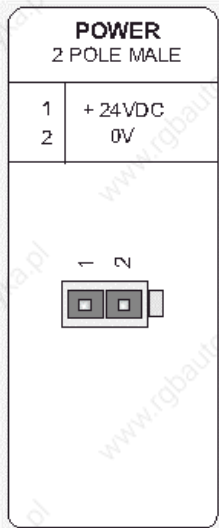

Power supply: 24 V DC \pm 20%
ripple \pm 2V

Module	Nominal current
DM-101	0.4 A
DM-102	0.6 A
DM-102VA	0.6 A
DM-103VA	0.7 A

The 'power' connector is meant for the power supply for the module only.
The I/O systems (valve, analog and digital I/O) have their own power supply connectors. It is recommended to connect the I/O systems to a different power supply.

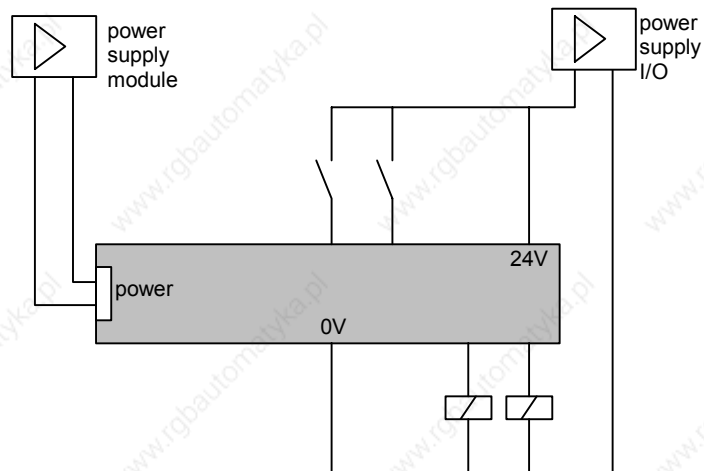

Programmable Digital In-/Outputs (8x):

Digital Output	Voltage	Current
ON state	20-28 V DC	0.5 A max.
OFF state	-	0.1 mA max. (leakage current)

Digital Input	Voltage	Current
ON state	9-28 V DC	20mA max.
OFF state	0-4 V DC	1 mA max.

Pins 17 - 24

Digital Outputs (4x)	Voltage	Current
ON state	20-28 V DC	0.5 A max.
OFF state	-	0.1 mA max. (leakage current)

Digital Inputs (4x)	Voltage	Current
ON state	9-28 V DC	20mA max.
OFF state	0 - 4 V DC	1 mA max.

2.4. Valve

Module	connector present
DM-101	-
DM-102	-
DM-102VA	+
DM-103VA	+

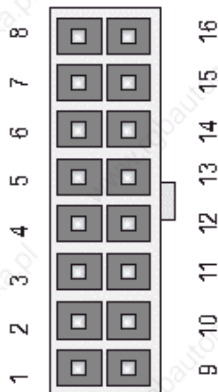

The VA modules have a 16-pin connector for the integrated valve amplifier. This connector is reserved for direct control of proportional valves Y1 and Y2 and for a pressure valve.

The following table gives an overview of connections for a system with directly connected valves. Also, the pin connections for pressure control are mentioned, depending on which method has been implemented.

Pin description for direct valve control:

Pin	Label	Function
1	Y1 0V	GND (power supply)
2	Y1 A-	Y1 valve signal A-
3	Y1 B-	Y1 valve signal B-
4	Y2 0V	GND (power supply)
5	Y2 A-	Y2 valve signal A-
6	Y2 B-	Y2 valve signal B-
7	P 0V	GND for pressure valve (power supply)
8	P -	pressure signal P-
9	Y1 24V	24 V DC for Y1 valve (power supply)
10	Y1 A+	Y1 valve signal A+
11	Y1 B+	Y1 valve signal B+
12	Y2 24V	24 V DC for Y2 valve (power supply)
13	Y2 A+	Y2 valve signal A+
14	Y2 B+	Y2 valve signal B+
15	P 24V	24 V DC for pressure valve (power supply)
16	P +	pressure signal P+

An example of the required wiring for direct valve control is given in drawing number 8576-101.

The position feedback from the valve transducers (LVDT) is connected to connector Analog B. If no direct valve control is implemented but external valve amplifiers are used instead, the valve connection block is not used. All analog signals for the valve amplifiers run through connector Analog B. See section 2.6 for more information about this connector.

Analogue outputs:

Prop. Valve:	Y1/Y2	4 x 3A max.
Pressure valve:	P	1.5 A max.

Analogue inputs:

24V Power Supply	18-30V DC ripple +/- 2V max. max. 8A
------------------	--

Shielding of cables should be connected to the available M3 ground plug on the front of the module.

2.5. Analog A

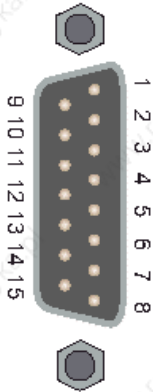

This connector is implemented on all DM-100 modules. Connector Analog A provides several analog signals on the module, two analog outputs and four analog inputs.

Pin description Analog A connector:

Pin	Description	Function
1	OUTAN1 -10V...+10V	AN1 Analog output voltage +/-10V
2	OUTAN1 0V	AN1 Analog output common
3	REF1 10V	10V reference voltage for analog input IN1A
4	IN1A	input signal analog input IN1A
5	IN1A 0V	common analog input IN1A
6	IN1B	input signal analog input IN1B
7	IN1B 0V	common analog input IN1B
8	N.C.	Not connected
9	OUTAN2 -10V...+10V	AN2 Analog output voltage +/-10V
10	OUTAN2 0V	AN2 Analog output common
11	REF2 10V	10V reference voltage for analog input IN2A
12	IN2A	input signal analog input IN2A
13	IN2A 0V	common analog input IN2A
14	IN2B	input signal analog input IN2B
15	IN2B 0V	common analog input IN2B

Specifications for Analog I/O

Analogue inputs (4x) 0-10V, input impedance 44 kΩ

Reference voltage (2x) 10V ± 2%

Analogue outputs (2x) +/- 10V
 10mA max.
 minimal resistance 1 kΩ

On the DM-101, pin 8-15 are not connected.

If necessary, shielding of cables can be connected to the available M3 ground plug on the front of the module.

2.6. Analog B

Module	connector present
DM-101	-
DM-102	-
DM-102VA	+
DM-103VA	+

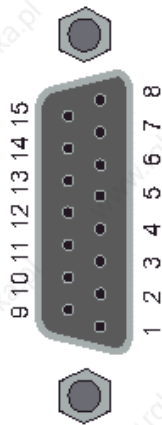

Connector Analog B provides several analog signals on the module, two analog outputs and two analog inputs. It also includes power supply for possible valve position transducers (LVDT).

Pin description Analog B connector:

Pin	Label	Function
1	Y1 -12V	-12V power for Y1 transducer
2	Y1 +12V	12V power for Y1 transducer
3	Y1 24V	24V power for Y1 transducer
4	Y1 LVDT	input signal Y1 transducer
5	Y1 0V	0V common Y1 transducer
6	Y1 +/- 10V	+/-10 V for external valve amplifier Y1
7	P 0V	GND for pressure valve
8	P 0-10V	pressure signal for pressure valve
9	Y2 -12V	-12V power for Y2 transducer
10	Y2 +12V	12V power for Y2 transducer
11	Y2 24V	24V power for Y2 transducer
12	Y2 LVDT	input signal Y2 transducer
13	Y2 0V	0V common Y2 transducer
14	Y2 +/- 10V	+/-10 V for external valve amplifier Y2
15	Valve enable	Enable the prop. valve amplifiers

Specifications for Analog I/O

Analogue inputs (2x)	0-12V / -10V ... +10V, input impedance 44 k Ω Supply voltage 24V \pm 2%
Analogue outputs (2x)	+/- 10V 10mA max. minimal resistance 1 k Ω
Analogue output (1x)	0 - 10V (ext. pressure amplifier)
Power outputs (6x)	2x -12V 2x +12V 2x 24V 100 mA max. for each transducer

Notes:

- Used power supply depends on transducer specifications (+/-12V or 24V).
- If necessary, shielding of cables can be connected to the available M3 ground plug on the front of the module.

2.7. Encoders

Module	connector present
DM-101	1 x
DM-102	2 x
DM-102VA	2 x
DM-103VA	3 x

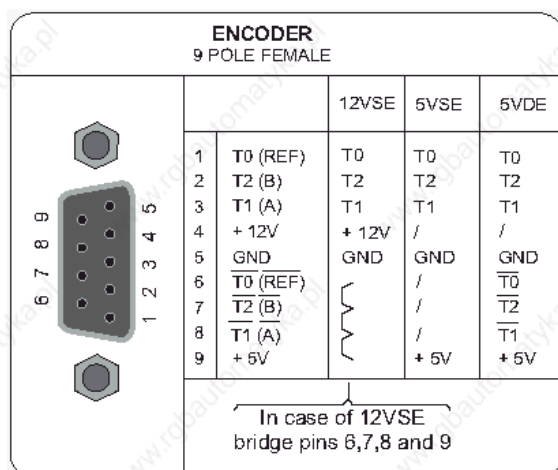

9-pole SUBD male encoder interface

5V DC/250 mA or 12V DC/200 mA

12 V or 5 V single ended or 5 V differential

Max. count frequency 1 MHz

Pin description quadrature Encoder connector:

Pin nr.	Name	Function	Comment
1	T0	Reference	-
2	T2	Phase B	-
3	T1	Phase A	-
4	+12V	12V supply (output)	only for 12V
5	GND	return	-
6	!T0	inverted reference	only for diff. ended
7	!T2	inverted phase B	only for diff. ended
8	!T1	inverted phase A	only for diff. ended
9	+5V	5V supply (output)	only for 5V

Notes:

- In case of 12VSE encoder, connect pins 6, 7, 8 and 9 with eachother.
- If necessary, shielding of cables can be connected to the available M3 ground plug on the front of the module.

2.8. HSB interface

Implemented on all modules.

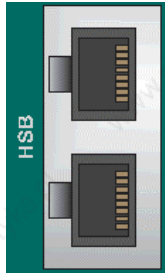

The HSB interface (High Speed Bus) is configured according to the international standard for CAN-interfaces (Controller Area Network), ISO 11898.

Both connectors are implemented as an RJ-45 connector.

The total length of the bus (the sum of all connections between modules) may not exceed 30 metres.

Maximal eight modules may be connected to one HSB-bus.

The HSB line must be closed with a termination resistor of 120 ohm.

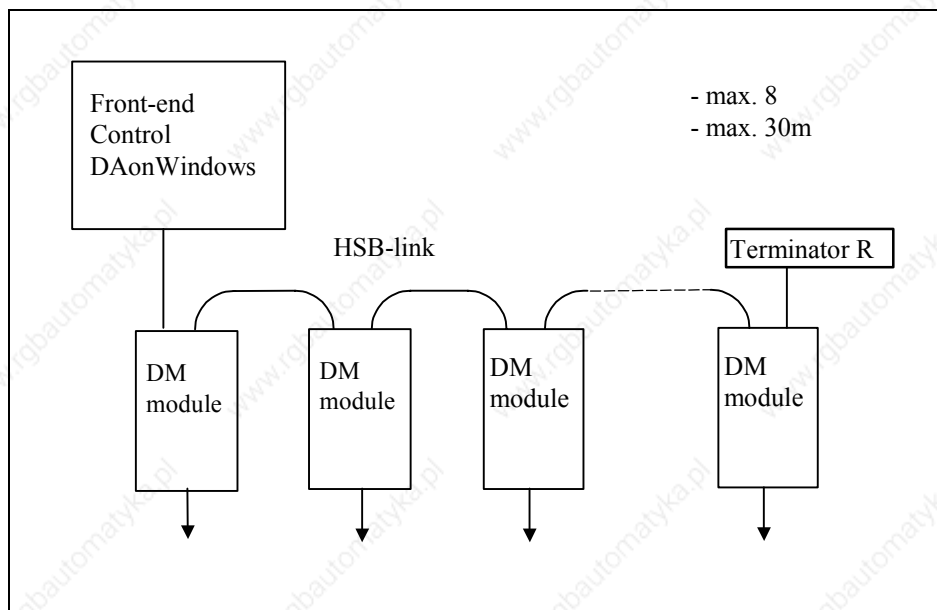

Figure 2.c

3. The modules

3.1. Introduction

In this chapter all DM-100 modules are mentioned with their appearance and features. Connector specifications are listed in chapter 2.

The following table gives an overview of the modules and available connectors.

	DM-103VA	DM-102VA	DM-102	DM-101
I/O 1 - 8	+	+	+	+
I/O 9 - 16	+	+	+	-
I/O 17 - 24	+	+	+	-
Valve	+	+	-	-
Analog A	+	+	+	+
Analog B	+	+	-	-
Encoder 1	+	+	+	+
Encoder 2	+	+	+	-
Encoder 3	+	-	-	-
HSB	+	+	+	+

3.2. DM-103VA

The DM-103VA is designed for synchronised control of a Y-axis and one servo axis (the X-axis).

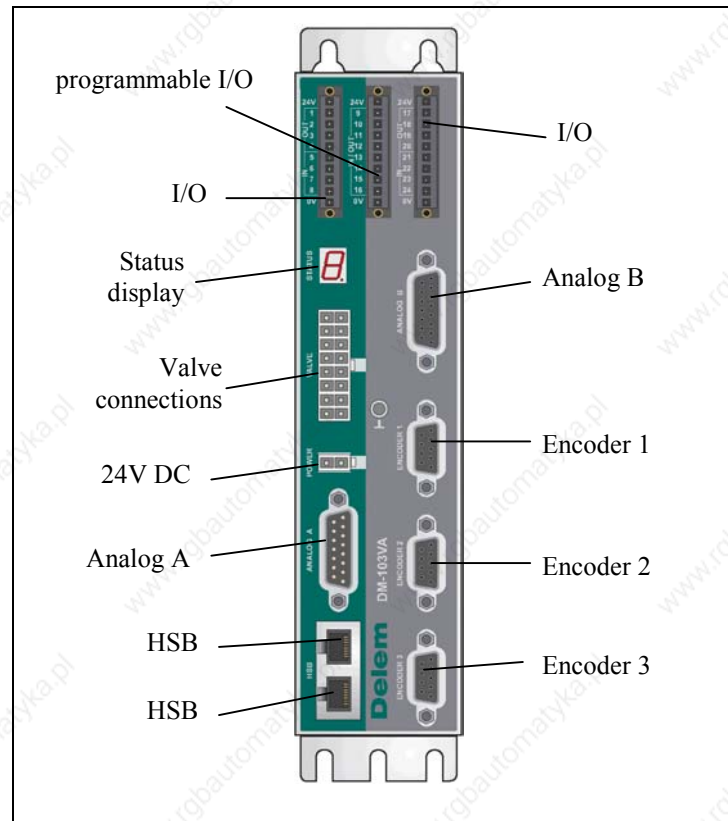

Figure 3.a

For a wiring example of the module, reference is made to the following drawing:

- 8576-101 example connections DM-103VA

3.3. DM-102VA

The DM-102VA is designed for synchronised control of a Y-axis.

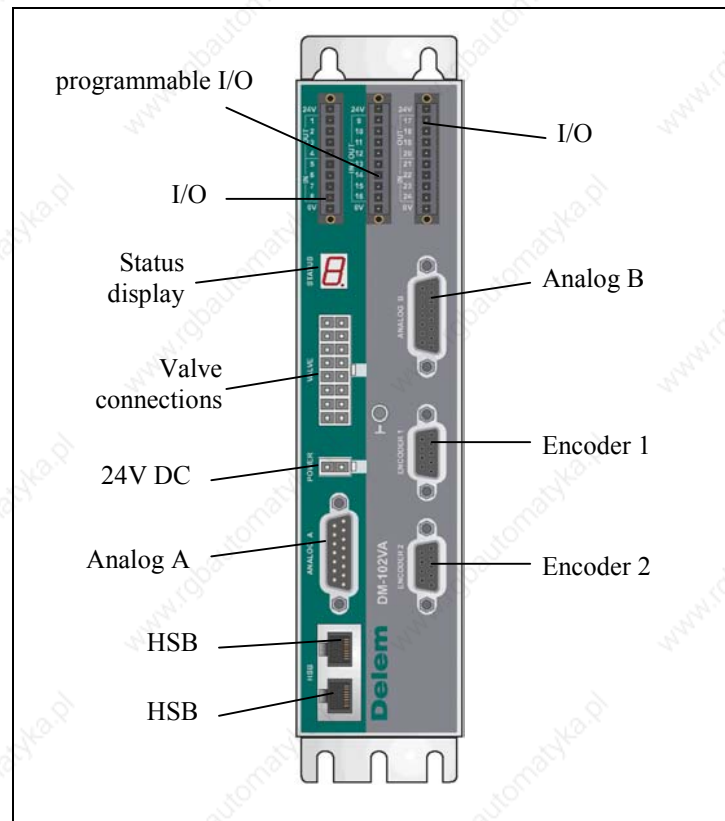

Figure 3.b

For wiring example of the module, reference is made to the following drawing:

- 8562-101 example connections DM-102VA

3.4. DM-102

The DM-102 can control 2 axes. It is designed for control of two servo or AC axes.

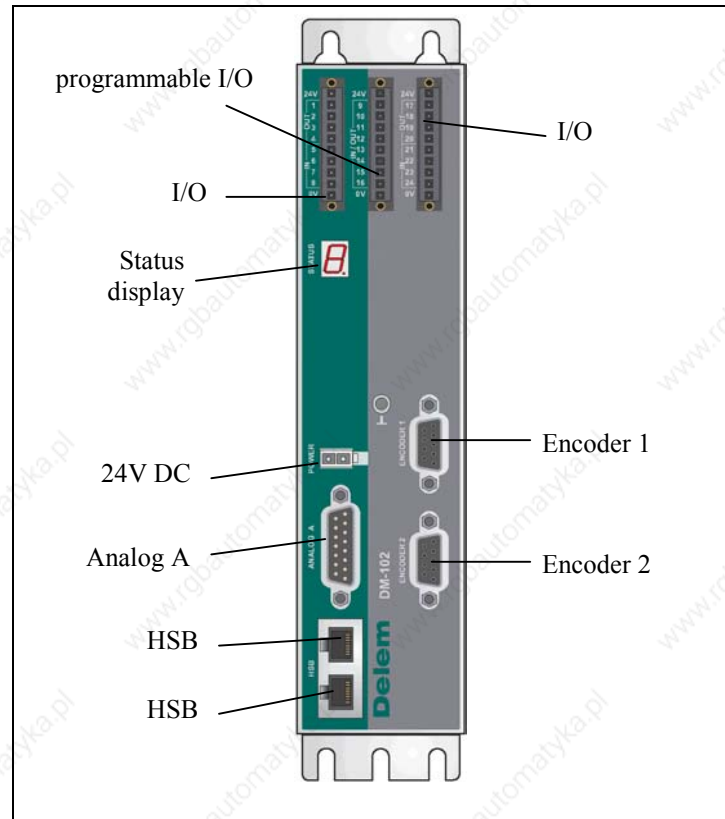

Figure 3.c

For wiring example of the module, reference is made to the following drawing:

- 8562-109 example connections DM-102

3.5. DM-101

The DM-101 can control 1 axis. It is designed for control of a servo or AC axis.

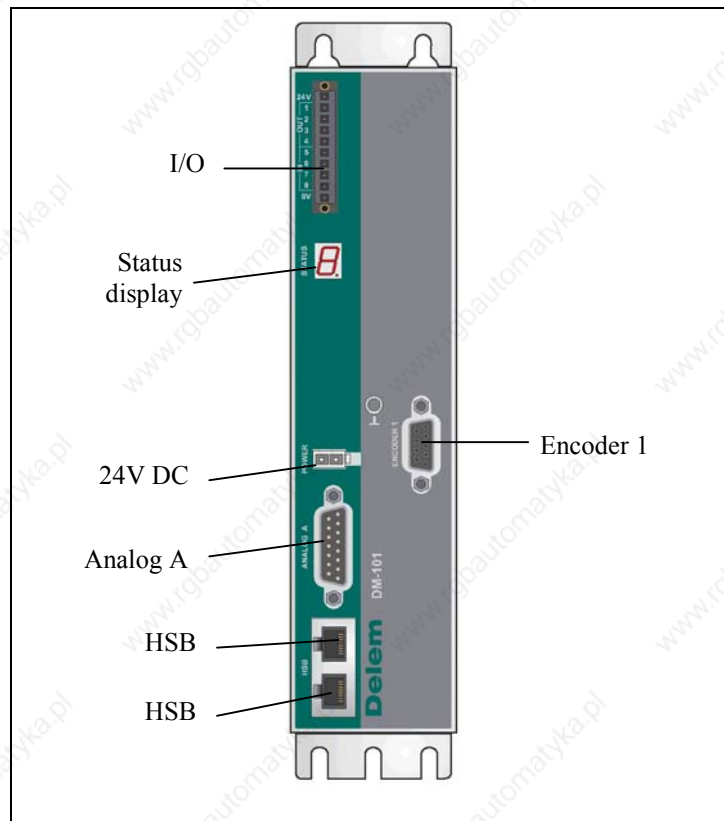



Figure 3.d

For example wiring of the module, reference is made to the following drawing:

- 8575-101 example connections DM-101

4.2. DM-103VA

 Module configuration							
Type	Module ID	Boot	Flash	Axis 1	Axis 2	Axis 3	Axis 4
DM103	2020957		Y	X	CROWN	—	

Since the DM-103VA is meant for Y-axis control, it will normally be configured as shown above: Y-X-CROWN. Whether or not crowning is configured depends on the application. If necessary, an FD axis could be added. Then the configuration would be Y-X-CROWN-FD. Consider the number of available outputs.

The DM-103VA is **not** suitable to drive three servo/AC axes, for instance X1-X2-R.

4.3. DM-102VA

 Module configuration							
Type	Module ID	Boot	Flash	Axis 1	Axis 2	Axis 3	Axis 4
DM102	2020957		Y	CROWN	—	—	

Since the DM-102VA is meant for Y-axis control, it will normally be configured as shown above: Y-CROWN. The X-axis will have to be configured on a separate module. It is possible to add an FD axis to this configuration if required.

4.4. DM-102

 Module configuration							
Type	Module ID	Boot	Flash	Axis 1	Axis 2	Axis 3	Axis 4
DM102	2020957		X	R	—	—	

The DM-102 can drive two separate servo/AC axes. In the first column the left part of the module is assigned, in the second column the right part. This is repeated for the third and the fourth column. The configuration shown above is correct.

If column 1 and 2 are already assigned to two servo/AC axes, column 3 and 4 can no longer be assigned to additional axes of that type. But it would be allowed to program two servo axes and one digital axis on a module. Let's look at some examples:

Module configuration							
Type	Module ID	Boot	Flash	Axis 1	Axis 2	Axis 3	Axis 4
DM102	2020957			X	R	FD	ID

Correct. When the digital axis (FD or ID) is installed, the control will issue a warning that there is already an axis installed on the relevant module segment, but you are allowed to accept the definition.

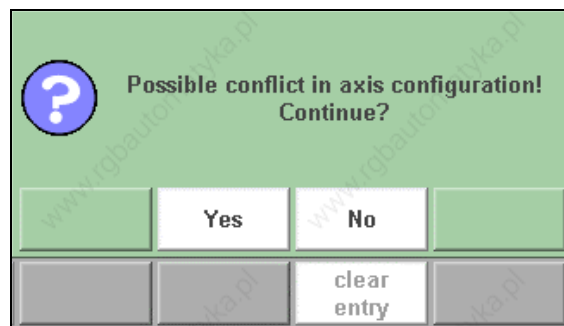

If one segment must drive an AC axis and a digital axis, you should check your sequencer to prevent I/O conflicts between the two axes.

Module configuration							
Type	Module ID	Boot	Flash	Axis 1	Axis 2	Axis 3	Axis 4
DM102	2020957			X	R	Z1	Z2

Incorrect. A DM-102 consists of two segments, each of which can drive one positioning axis (servo or AC). If you try to configure this, the control will issue the same warning. In this case it should not be accepted.

Module configuration							
Type	Module ID	Boot	Flash	Axis 1	Axis 2	Axis 3	Axis 4
DM102	2020957			X	—	R	—

Incorrect. This is an attempt to assign two positioning axes to the left module segment.

4.5. DM-101

Module configuration							
Type	Module ID	Boot	Flash	Axis 1	Axis 2	Axis 3	Axis 4
DM101	2020957		R	—	—	—	

The DM-101 is meant for control of one servo/AC axis, so the configuration shown above is correct. If necessary, an FD axis can be added.

4.6. Status display

The DM-100 module contains a 7-segment display that can show error and status codes.

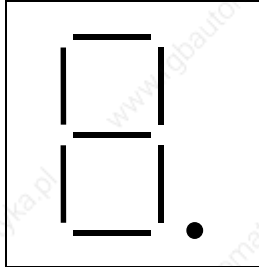

Messages can originate from three sources:

- the module hardware initialisation ('bootrom'): the decimal point is lit continuously
- the module software: the decimal point is off
- the diagnostic program: the decimal point is flashing

If a problem occurs and the display shows a character, write it down. Then check the following table for an explanation of the message code. If an error persists, write down the number of the error and contact Delem. Refer to the module type, the module software version and the error number.

Bootrom messages:

Msg	Description
	A. - Assert (fatal error: switch module off/on)
	E. - Exception, not blinking (fatal error: switch module off/on)
	E./x. - Blinking errors. The display will show E / x in succession, where 'x' is one of the following numbers. 1 Error while initialising HSB controller. 2 Error in flash parameters. 3 No ModId available. 4 Application not found. 5 Application checksum error.
	8. - Module reset (all LED's on)

	u. - Software update in progress.
	U. - Software update finished.
	b. - Boot start.
	c. - HSB address received.
	L. - VaLidate application.
	P. - Start aPplication.

Software messages:

Message	Description
	A - Assert (fatal error: switch module off/on)
	E - Exception, not blinking (fatal error: switch module off/on)
	<p>E/xy - Blinking errors. The display will show E / x / y in succession, where 'xy' is one of the following numbers.</p> <p><i>1?: resource errors</i></p> <p><i>2?: electrical errors</i></p> <p>21. Power failure.</p> <p>22. Not used.</p> <p>23. Encoder signal error on encoder 1.</p> <p>24. Encoder signal error on encoder 2.</p> <p>25. Overcurrent detected on valve outputs.</p> <p>26. HSB bus warning.</p>

- 27. HSB bus error.
- 28. Encoder signal error on encoder 3.
- 29. Encoder signal error on encoder 4.

3?: communication errors/warnings

4?: Valve application errors

- 41. Wrong valve type.
- 42. Wrong parameters.
- 43. LVDT 1 check failed
- 44. Not used
- 45. LVDT 2 check failed
- 46. Control 1 saturated
- 47. Control 2 saturated

5?: X axis errors

- 51. Encoder 1st axis connected wrong.
- 52. Encoder 2nd axis connected wrong.
- 53. Wrong parameters.
- 54. Not used.
- 55. Not used.
- 56. No movement on 1st axis.
- 57. No movement on 2nd axis.

6?: Y axis errors

- 61. Wrong parameters.

7?: Pressure valve application errors

- 71. No pressure valve connected.
- 72. Wrong parameters.
- 73. Unhandled Pressure command.

8?: CAP errors

- 81. Wrong parameters.
- 82. Error downloading deflection compensation table.

9?: Miscellaneous errors

- 91. Module configuration error.
- 92. Burn-in error.
- 93. Time based scheduler overload.
- 94. NULL-pointer exception detected.

The '?' can be any digit. If the error persists, write down the number of the error and contact Delem. Refer to the module type, the module software version and the error number.

Delem

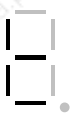
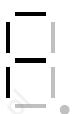
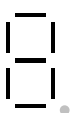
	-- Module started
	t/. – VAP test mode
	F/. - Axis simulator activated
	8/. - Diagnostic mode entered

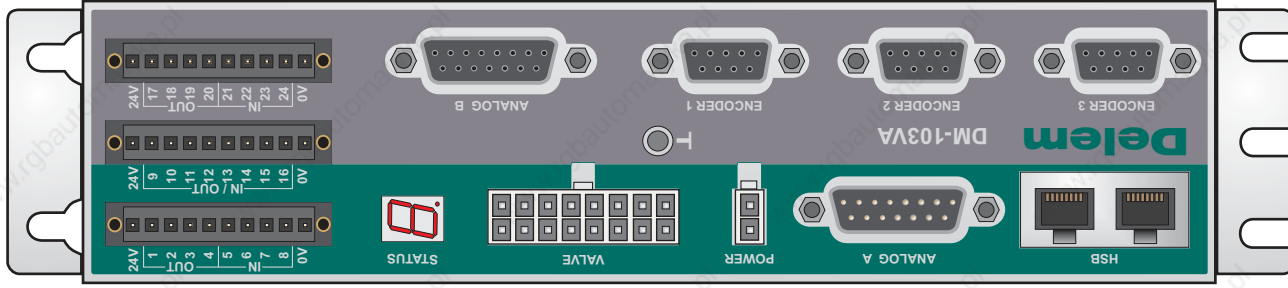
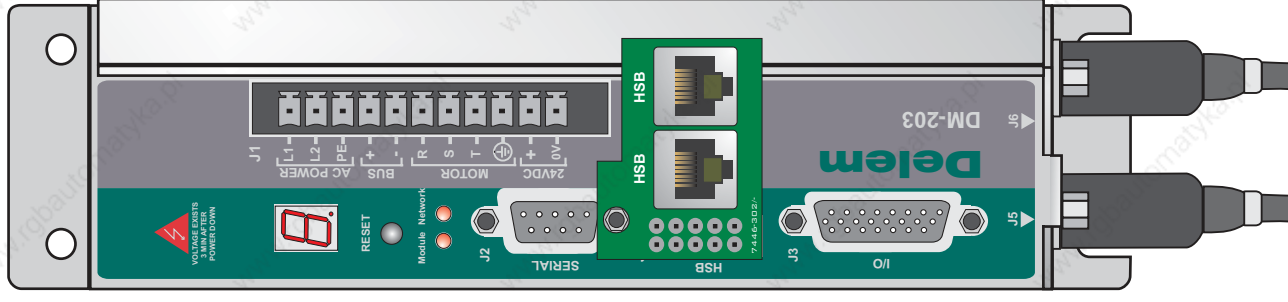
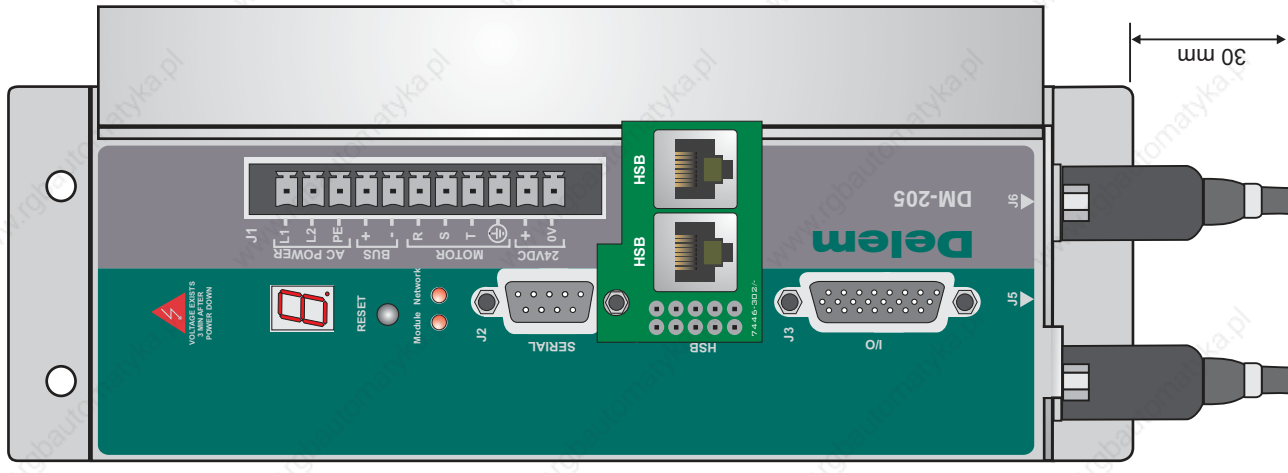

DM-103VA

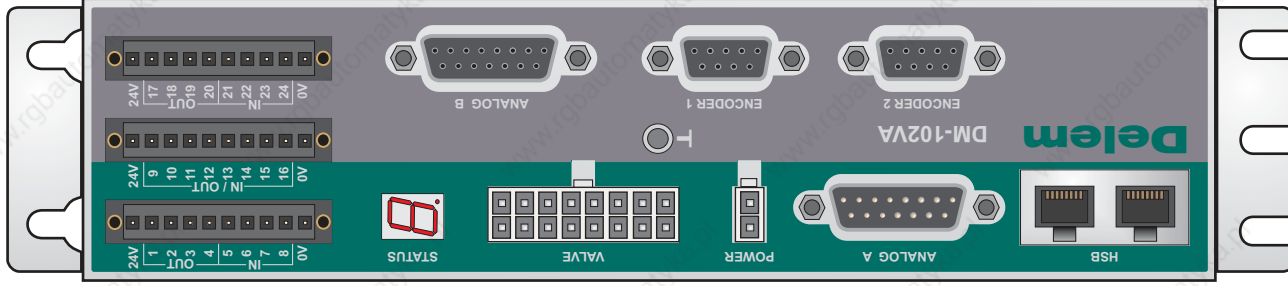

DM-102VA



DM-102



DM-101

Note		Date	Delem	
Description		Date	Inchthavenweg 42, 5657 BB Eindhoven, the NETHERLANDS	
Note		Date	DM-101, 102, 102VA, 103VA	
Description		Date	DM-203, 205	
Measure in mm unless otherwise specified	Scale	Drawn	Base	Part No.
HNF	07-07-2004			9084-502
A3		No unauthorised copying allowed		-

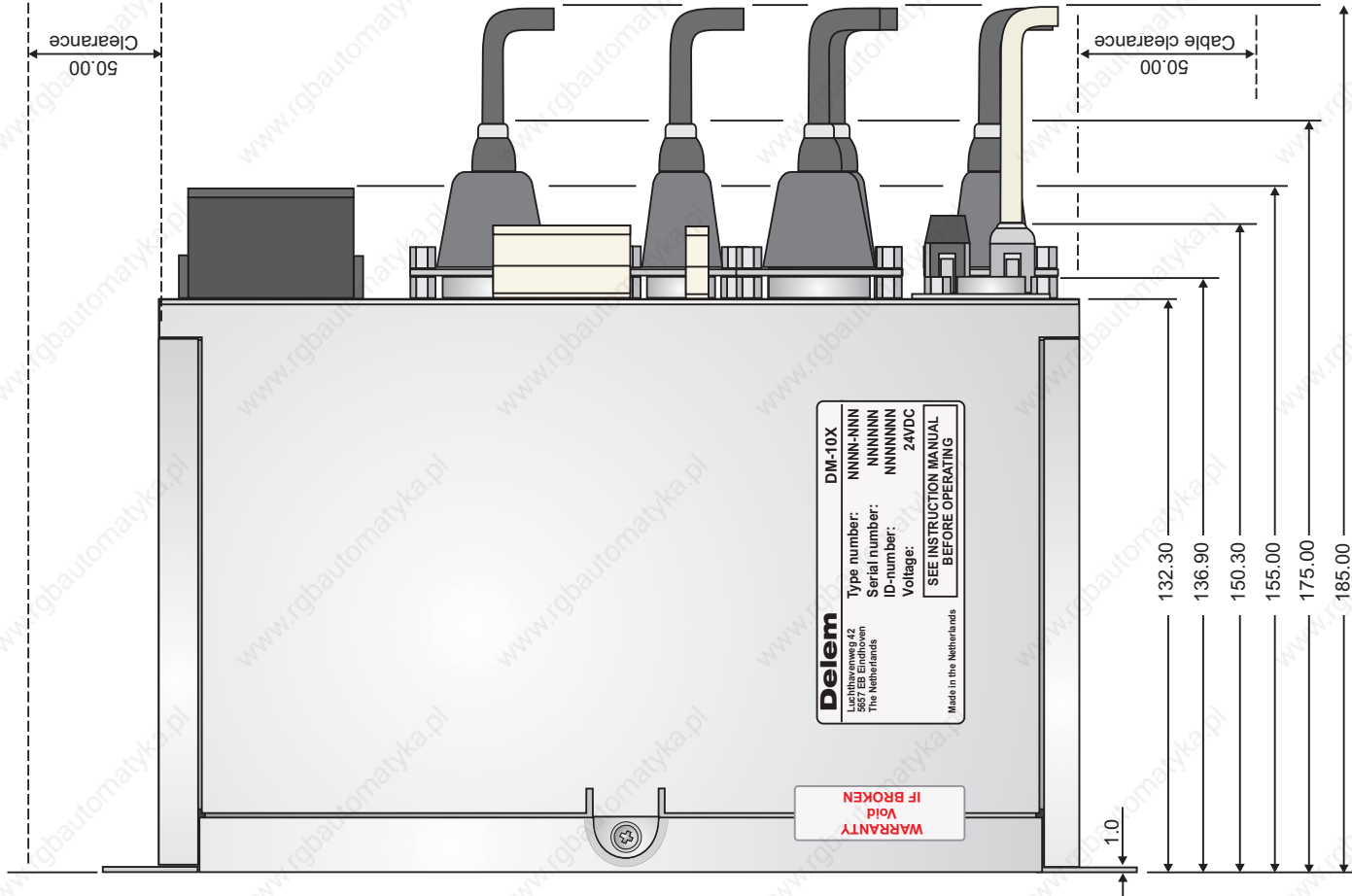
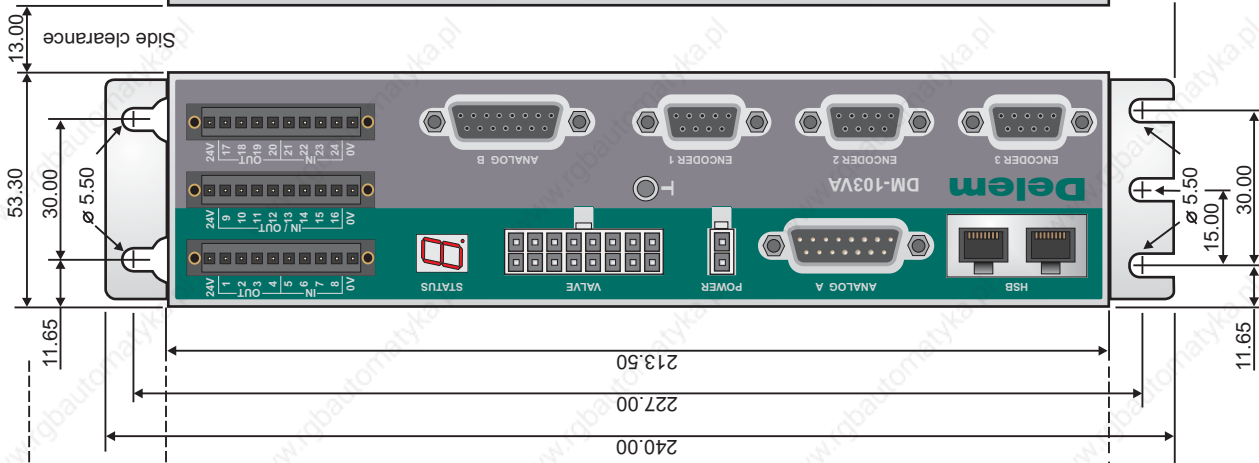

Delem
Luchthavenweg 42
Eindhoven, the Netherlands
Made in the Netherlands

DM-10X
Type number: NNNN-MNN
Serial number: NNNNNN
ID-number: NNNNNN
Voltage: 24VDC
SEE INSTRUCTION MANUAL
BEFORE OPERATING

- 132.30
- 136.90
- 150.30
- 155.00
- 175.00
- 185.00

- 8575-001 DM-101
- 8562-005 DM-102
- 8562-006 DM-102VA
- 8562-007 DM-102VA SSI
- 8576-001 DM-103VA
- 8576-002 DM-103VA SSI
- 8577-001 DM-104

Delem Luchthavenweg 42, 5657 RB Eindhoven, the NETHERLANDS		Dimensions DM-10X	
Note	Redrawn	Date	
Description			
Note A	Redrawn HNF	Date	14-02-2007
Description MOD#555: 8577-001 DM-104 added			
Measures in mm, unless otherwise specified		Drawn	HNF
Date		16-11-2004	
Format	A3	Number	8576-601
Issue			A
No unauthorized copying allowed Scale			

DC-SET-10X



DC-161586

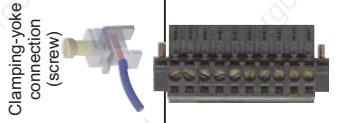

DC-SET-10X-S

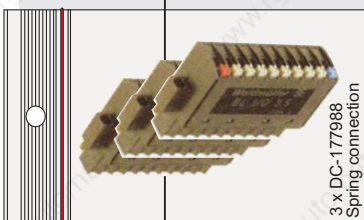

DC-177988

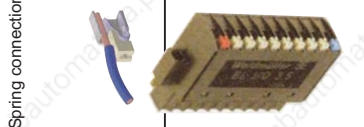

DC-SET-10X-SL

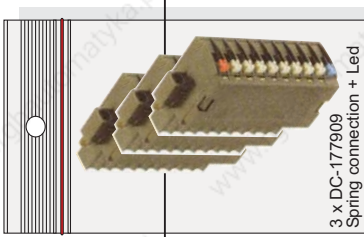

DC-178909



ANALOG A

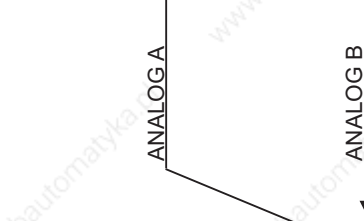

ANALOG B

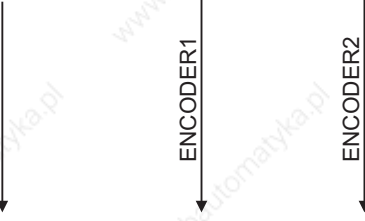

ENCODER1

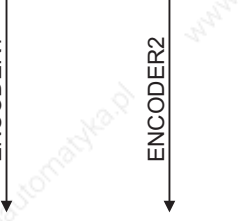

ENCODER2

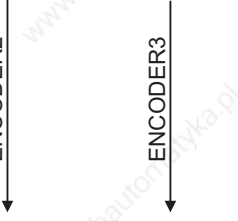

ENCODER3

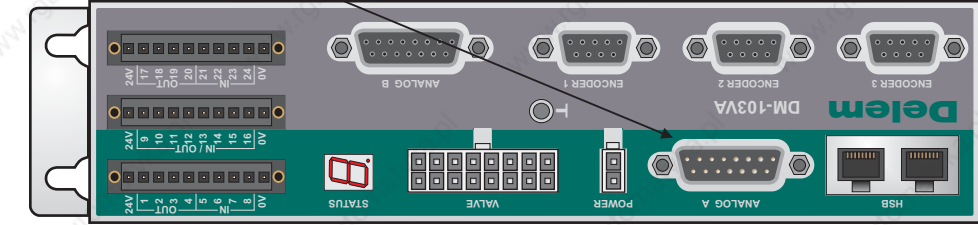

- 8575-001 DM-101
- 8575-002 DM-101RS
- 8562-005 DM-102
- 8562-006 DM-102VA
- 8562-007 DM-102VA-SSI
- 8577-001 DM-104
- 8576-001 DM-103VA**
- 8576-002 DM-103VA-SSI

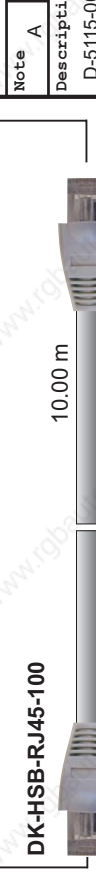
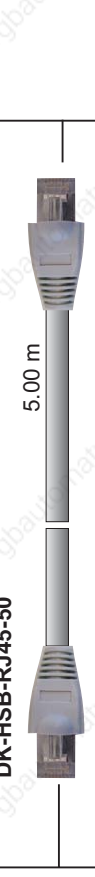
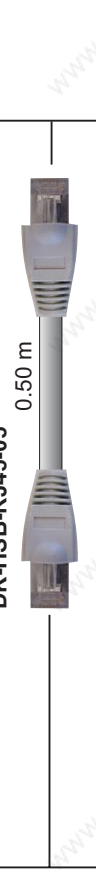
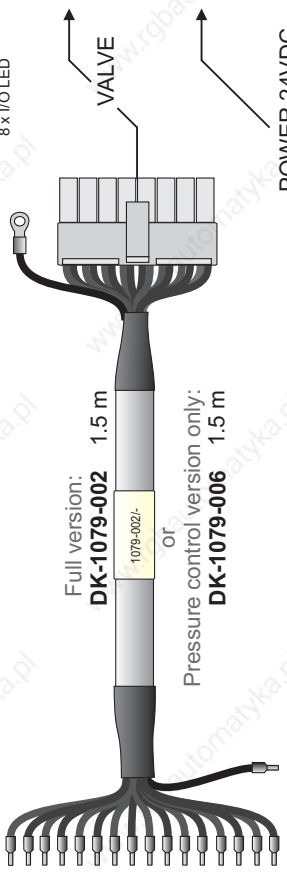

DA-66W & DA-69W :
D-5115-001

DA-63W & DA-65W :
D-5115-002



Note B	Redrawn	HNF	Date	19-04-2007
Description New versions modules added				
Note A	Redrawn	HNF	Date	23-05-2005
Description DC-1064-001, D-5115-001, D-5115-002 added				
Measures in mm, unless otherwise specified				
Drawn			HNF	Date
16-11-2004				
Delem Luchthavenweg 42, 5657 EB Eindhoven, the NETHERLANDS				
DM-10X cables & connectors				
Format	Number	Issue		
A3	8576-901	B		
No unauthorized copying allowed				

Note 1 : Leave unconnected pins open.
Note 2 : 24V relays supply must be separated from 24V supply
Note 3 : Do not place a diode across valves.

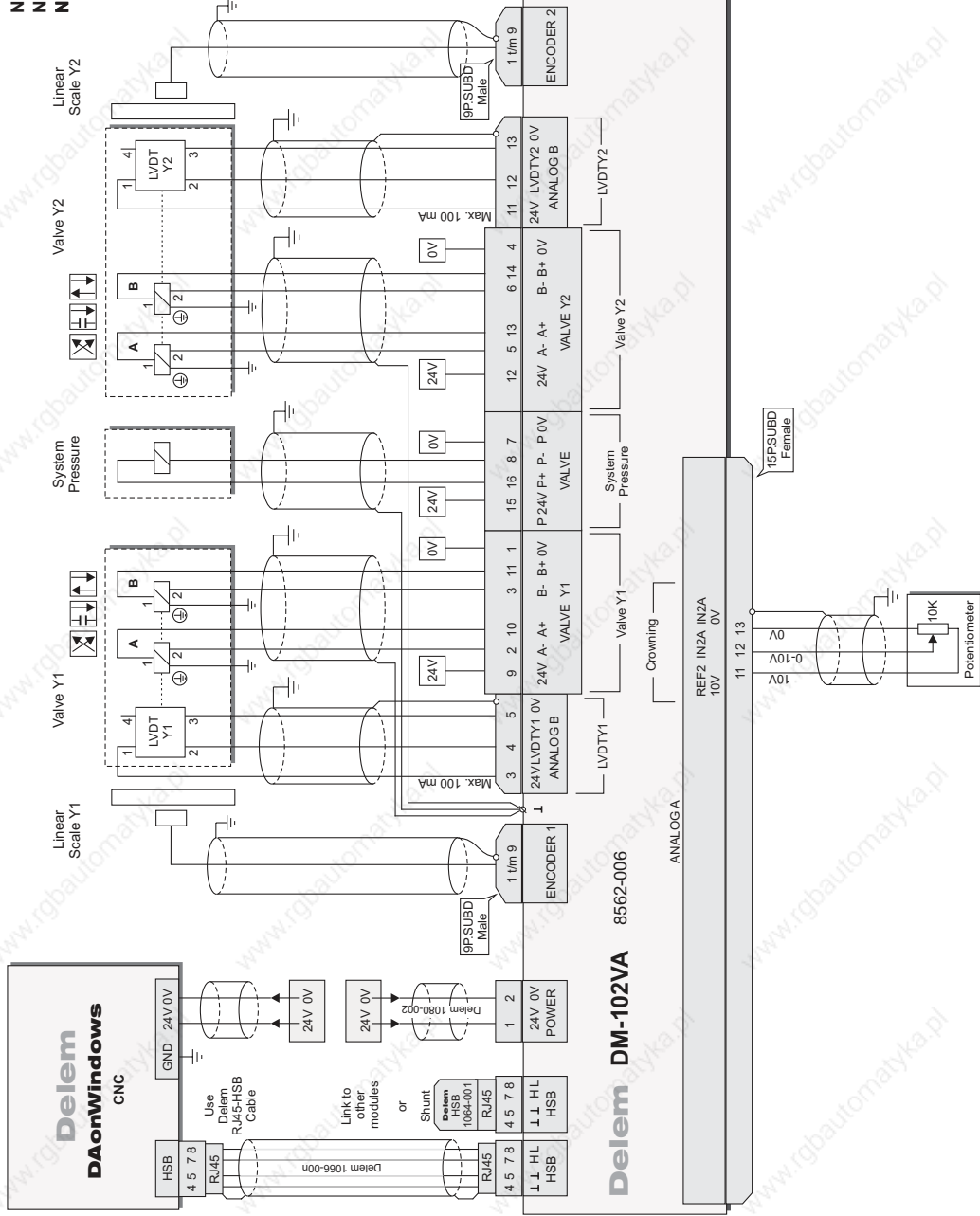

Delem DM-102VA 8562-006

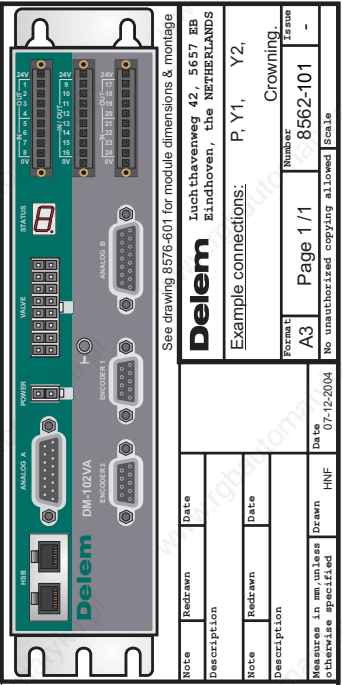

See drawing 8576-601 for module dimensions & montage

Delem
 Inchtovenweg 42, 5657 BB
 Inchtoven, the Netherlands

Example connections:
 P, Y1, Y2,
 Crowning.

Note	Redrawn	Date
Description		
Note	Redrawn	Date
Description		

Form 11
 A3 Page 1 / 1
 Number 8562-101
 Issue -

Measure in mm unless drawn otherwise specified
 Date 07-12-2004
 HNF

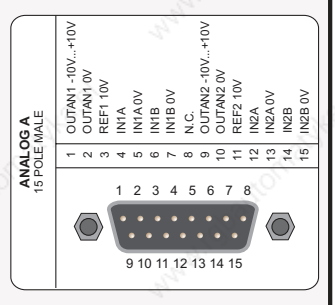
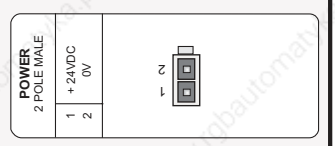
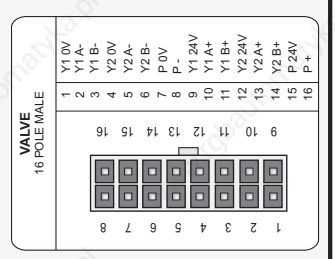
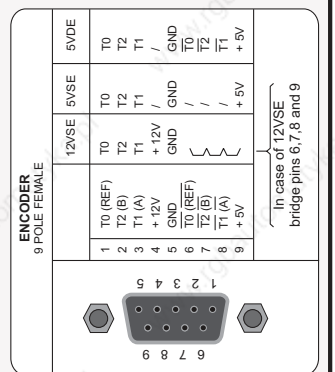
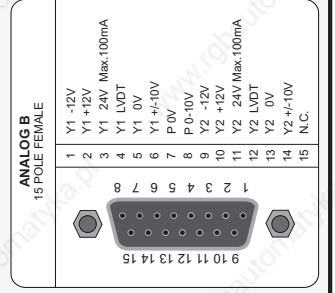

Note 1 : Leave unconnected pins open.
Note 2 : 24V relays supply must be separated from 24V supply
Note 3 : Do not place a diode across valves.

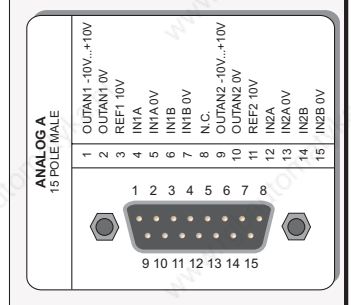
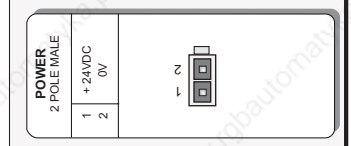
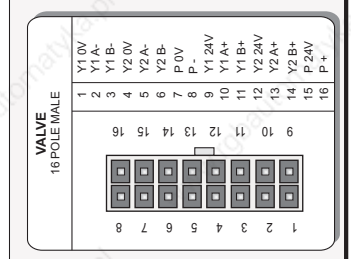
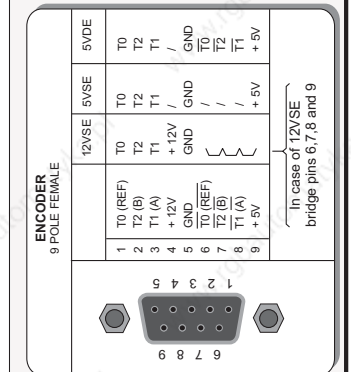
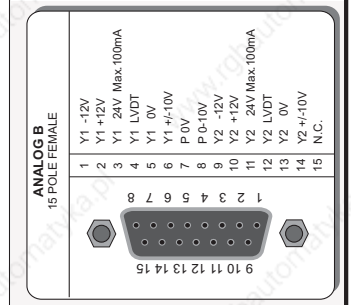
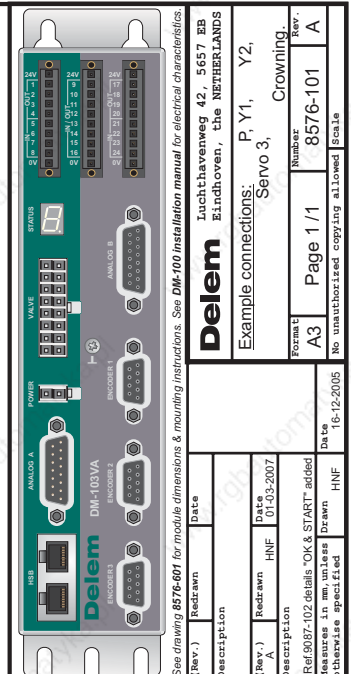
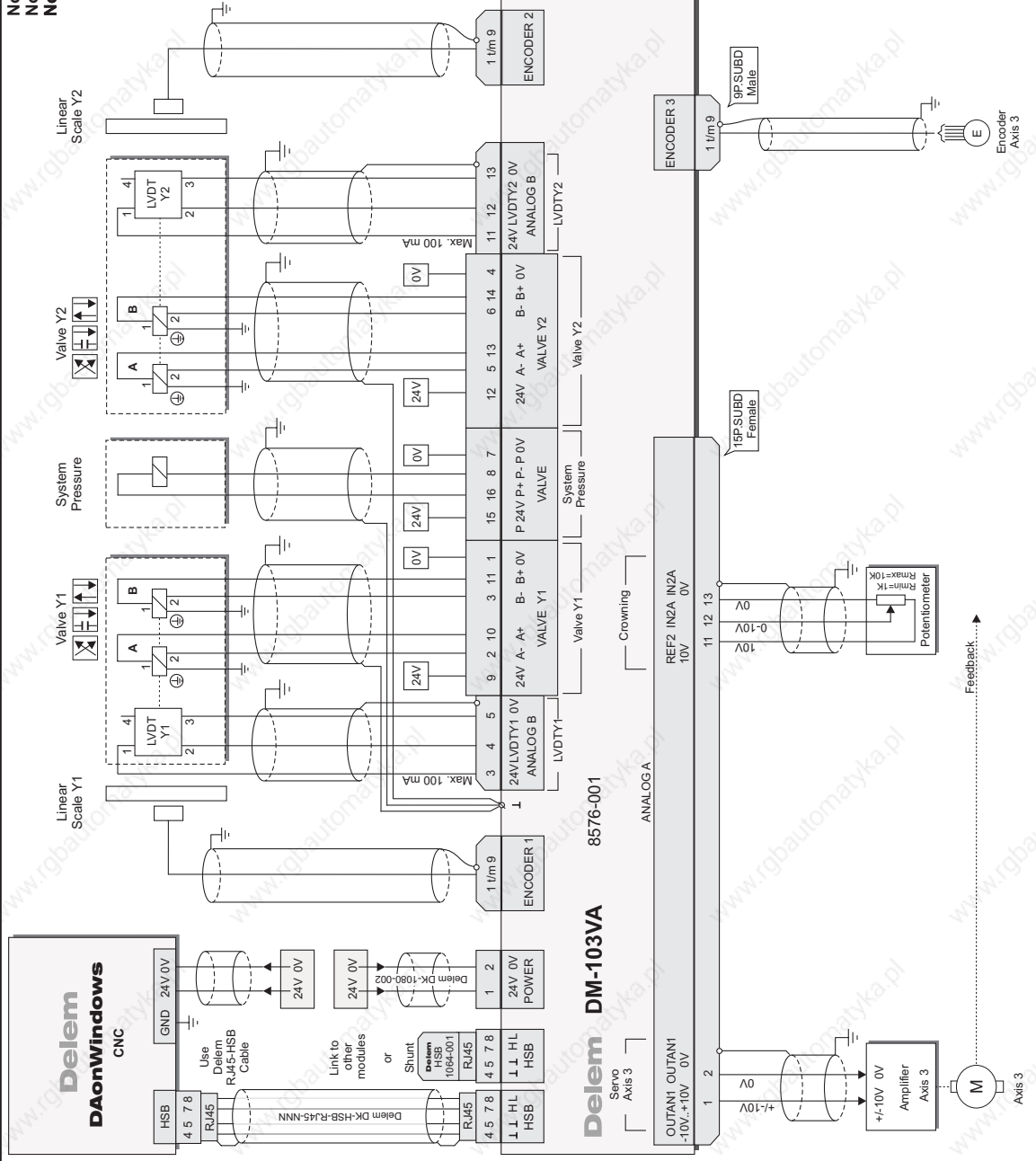

See drawing 8576-007 for module dimensions & mounting instructions. See DM-100 installation manual for electrical characteristics.
Delem Inchtaherweg 42, 5657 BB Zinchoven, the NETHERLANDS
 Example connections: Servo 3, P, Y1, Y2,
 Crowning.
 Form 1: A3 Page 1 / 1 Number: 8576-101 Rev.: A
 Date: 16-12-2005
 Drawn: HNF
 Checked: HNF
 Measure in mm unless otherwise specified
 No unauthorised copying allowed (Scale)

Note 1 : Leave unconnected pins open.
Note 2 : 24V supply must be separated from 24V supply

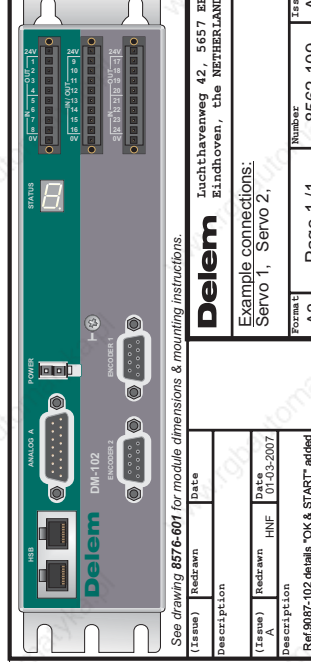
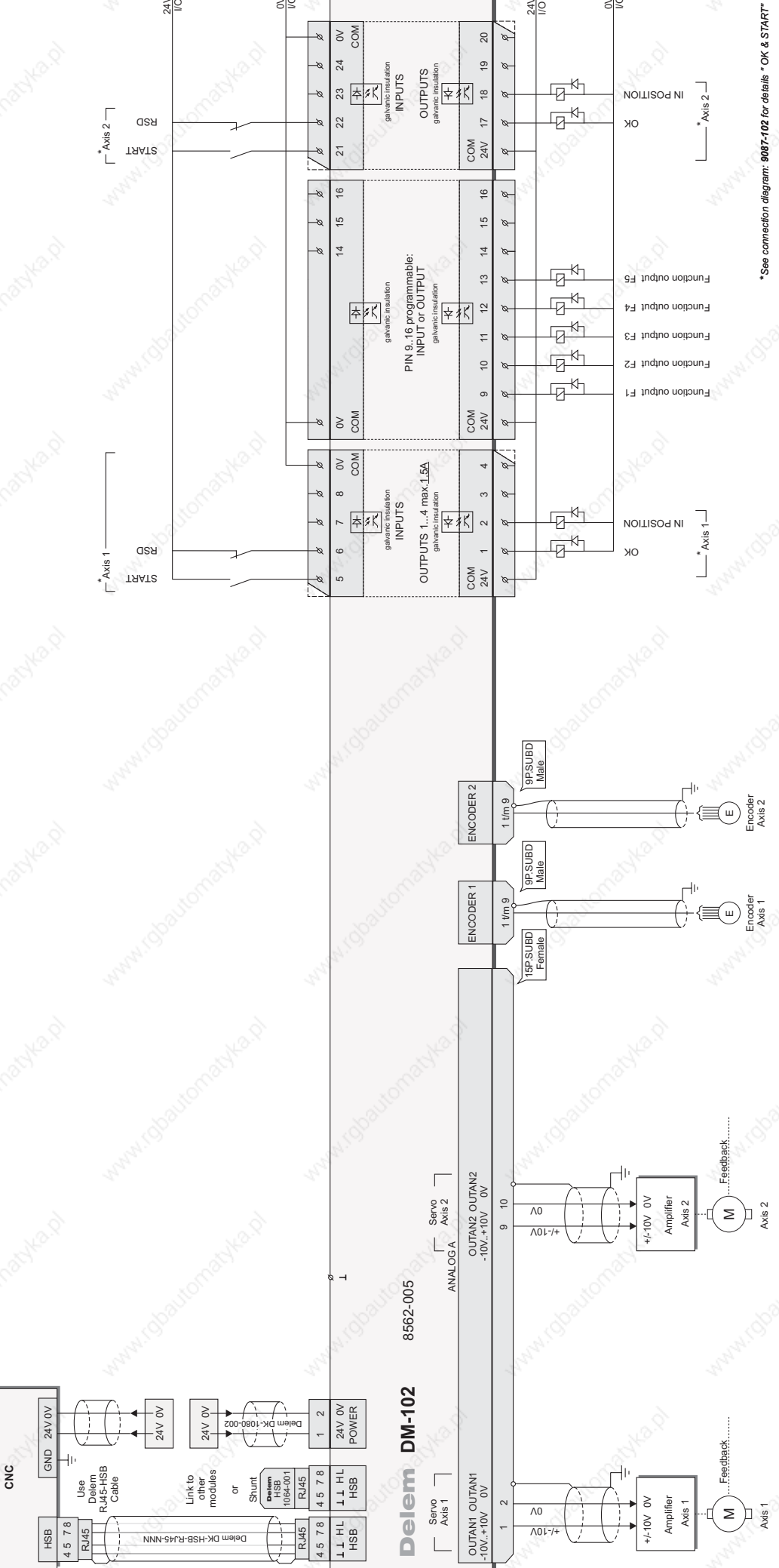

Delem
 Inchtahavenweg 42, 5657 BB
 Eindhoven, the NETHERLANDS

Example connections:
 Servo 1, Servo 2.

See drawing 8576-601 for module dimensions & mounting instructions.

Encoder	12VSE	5VSE	5VDE
1	T0 (REF)	T0	T0
2	T2 (B)	T2	T2
3	T1 (A)	T1	T1
4	+12V	/	/
5	GND	GND	GND
6	T0 (REF)	/	/
7	T2 (B)	/	/
8	T1 (A)	/	/
9	+5V	+5V	+5V

In case of 12VSE bridge pins 6,7,8 and 9

Power	1	2
2 POLE MALE	+24VDC	0V

Axis	1	2	3	4	5	6	7	8	9	10	11	12	13	14	15
ANALOG A 15 POLE MALE	OUTAN1 -10V	OUTAN1 0V	REF1 10V	IN1A	IN1A 0V	IN1B	IN1B 0V	N.C.	OUTAN2 -10V	OUTAN2 0V	REF2 10V	IN2A	IN2A 0V	IN2B	IN2B 0V