

SIEMENS

**SIMODRIVE
DC Main Spindle Drives**

Instruction manual

Edition 04.92

SIMODRIVE 270
digitally controlled
static converters with
current ratings from 30A . . . 600A

SIMODRIVE

DC Main Spindle Drives

**from 12 KW to 312 KW in Circulating-Current-Free
Back-to-Back Connection (B6)A(B6)C
Series 6RA27**

Instruction manual

Edition April 1992

Software status 3.3

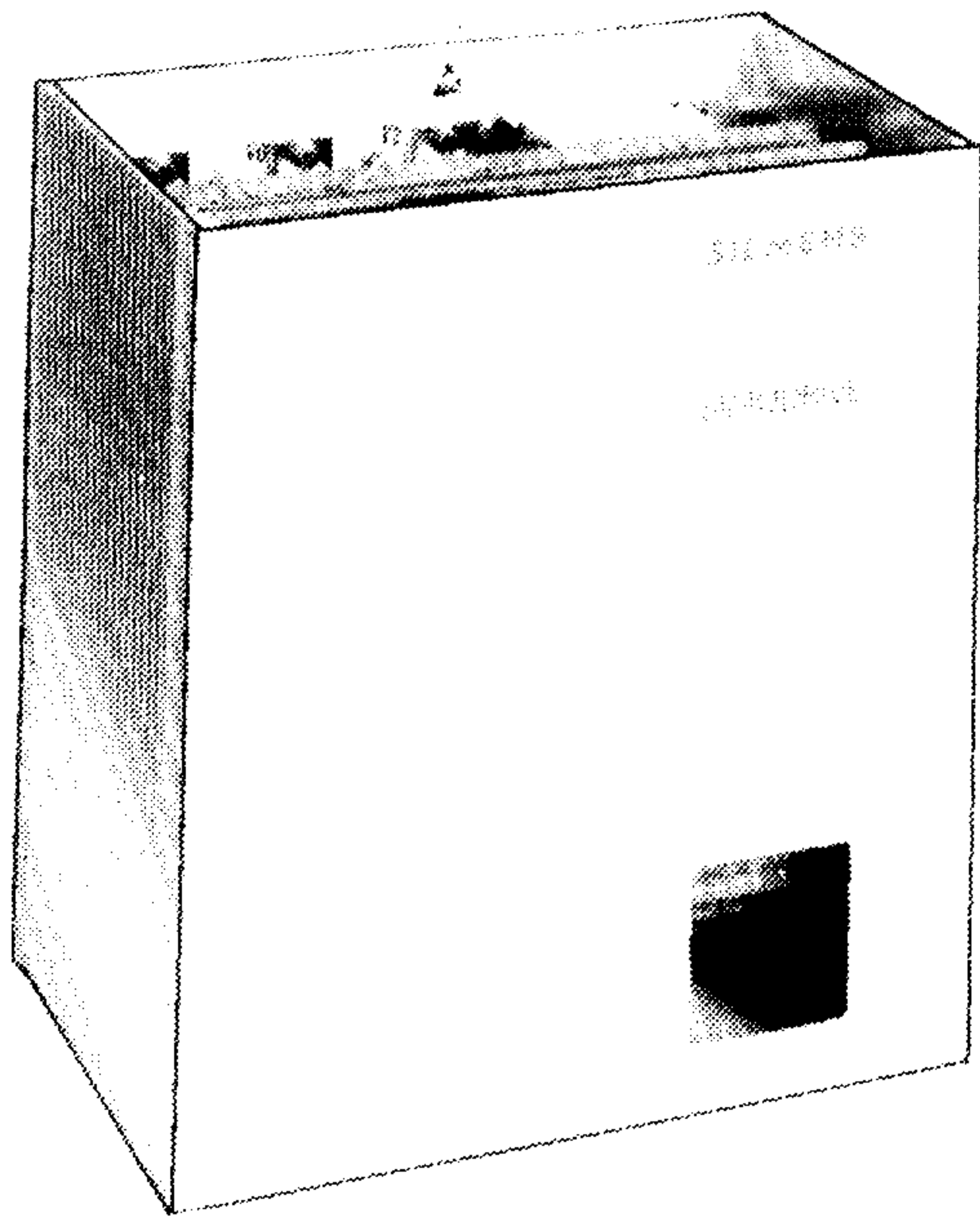

Unit without forced ventilation

MRPD

Type designation

6RA2718-6DV5.-0	D400 / 30 Mreq-GdG6V5. 1)
6RA2725-6DV5.-0	D400 / 60 Mreq-GdG6V5. 1)
6RA2728-6DV5.-0	D400 / 90 Mreq-GdG6V5. 1)
6RA2732-6DV5.-0	D400 / 130 Mreq-GdG6V5. 1)

6RA2718-6GV5.-0	D500 / 30 Mreq-GdG6V5. 2)
6RA2725-6GV5.-0	D500 / 60 Mreq-GdG6V5. 2)
6RA2728-6GV5.-0	D500 / 90 Mreq-GdG6V5. 2)
6RA2732-6GV5.-0	D500 / 130 Mreq-GdG6V5. 2)

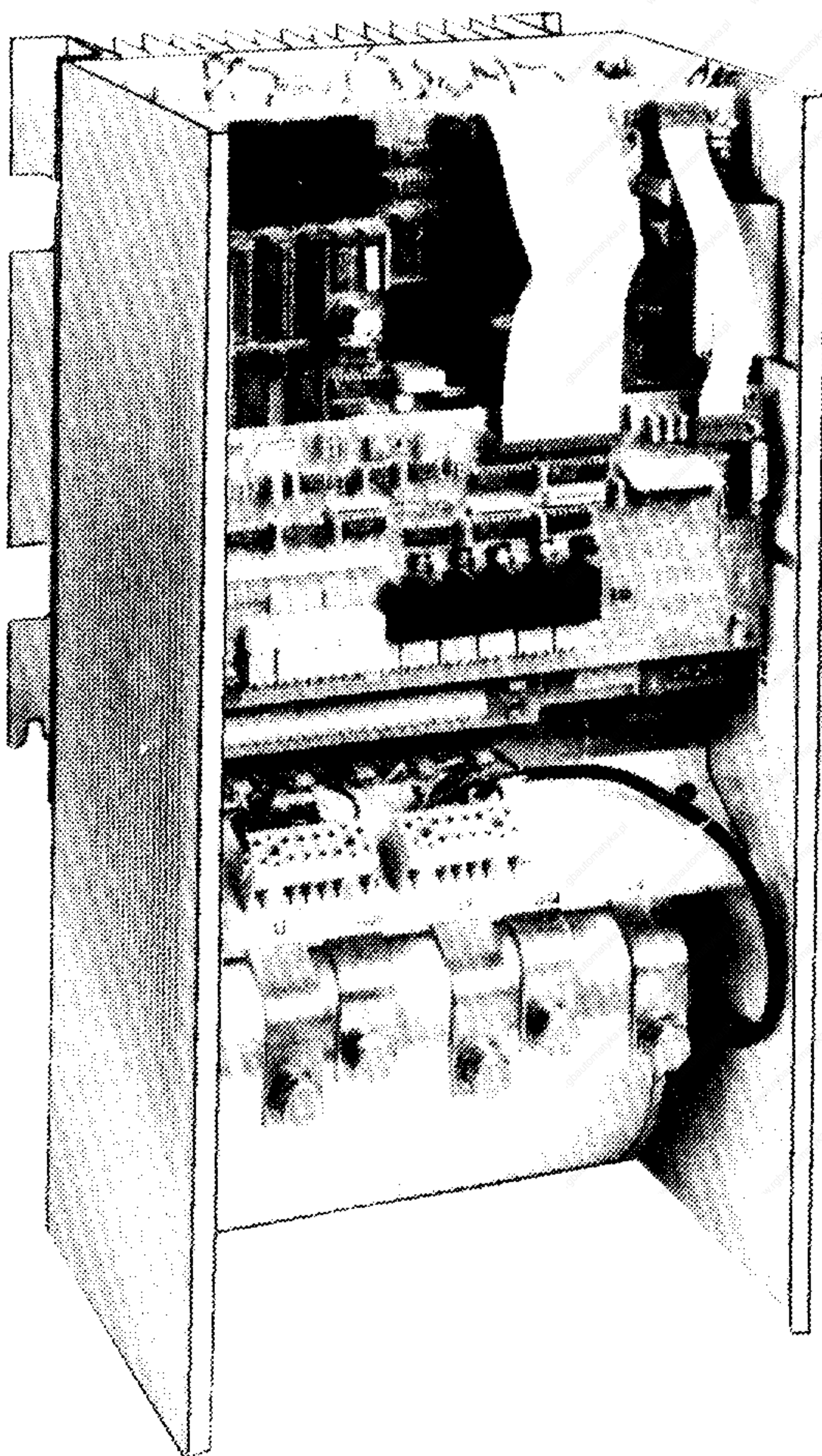

Unit with forced ventilation

6RA2775-6DV5.-0	D400 / 190 Mreq-GdGF6V5. 1)
6RA2777-6DV5.-0	D400 / 250 Mreq-GdGF6V5. 1)
6RA2781-6DV5.-0	D400 / 400 Mreq-GdGF6V5. 1)
6RA2785-6DV5.-0	D400 / 600 Mreq-GdGF6V5. 1)

6RA2775-6GV5.-0	D500 / 190 Mreq-GdGF6V5. 2)
6RA2777-6GV5.-0	D500 / 250 Mreq-GdGF6V5. 2)
6RA2781-6GV5.-0	D500 / 400 Mreq-GdGF6V5. 2)
6RA2785-6GV5.-0	D500 / 600 Mreq-GdGF6V5. 2)

V55. . . Basic unit
V57. . . Luxury unit

Supply connection: Armature circuit

- 1) 3AC 400V \pm 10%, 50 - 60Hz also suitable for
3AC 380V \pm 10%, 50 - 60Hz (in this case DC380V)
- 2) 3AC 500V \pm 10%, 50 - 60Hz

Supply connection: Electronics power supply, field circuit
and fan

- 1) 2) 2AC 400V \pm 10%, 50 - 60Hz also suitable for
2AC 380V \pm 10%, 50 - 60Hz

This document was produced on the Siemens 5822 Office System

Subject to change without prior notice.

The reproduction, transmission or use of this document or its contents is not permitted without express written authority. Offenders will be liable for damages. All rights, including rights created by patent grant or registration of a utility model or design, are reserved.

© Siemens AG 1989

Contents

	Page
0	Additional documentation 7
1	Introduction 7
1.1	General warning notes 8
1.2	Definitions 8
2	Description 10
3	Design 10
4	Installation 10
5	Reduction tables 11
5.1	Correction of load ratings for cooling medium temperature 11
5.2	Correction of load ratings for site altitude 11
6	Block diagrams 12
6.1	Block diagram with proposed connection for basic unit(V55) 12
6.2	Block diagram with proposed connection for luxury unit (V57) 13
7	Connection 14
7.1	General 14
7.2	Connection of shielded control cables 15
7.3	Power connection 16
7.4	Earth connection 16
7.5	Fan connection 16
7.6	Terminals on A2, trigger module C98043-A1203/A1204 17
7.7	Terminals on A1, controller module C98043-A1200 19
7.8	Terminals on A10, luxury supplementary module C98043-A1210 23
7.9	Hardware interface for connection of a printer 25
7.10	Hardware interface for connection of a PG635 / 675 / 685 programmer 26

8	Instructions for use	27
9	Operating states	29
10	Notes on startup	31
10.1	General warning notes on startup	31
10.2	General	32
10.3	Speed-related current limit	33
10.3.1	Motors with safe-commutation limit	33
10.3.2	Motors without safe-commutation limit	34
10.3.3	Calculation of the relevant parameters	35
10.4	Thermal overload protection (I ² t monitor)	37
10.5	Startup instructions	38
11	Fault indications	60
12	Maintenance	64
13	Parameter lists	65
	Measured value indications	65
	Code parameters	68
	Operating mode selection	70
	Setting values for A1210 module	73
	Setting values for technology functions	74
	Setting values for spindle positioning control	76
14	Parameter description (selection of operating modes and functions)	83
15	Appendix	134
15.1	Field characteristic	134
15.2	Master/Slave drives	136
15.2.1	Principal diagram	136
15.2.2	Implementation	136
15.3	Software changing procedure	141
15.4	Connection of electronics chassis	143
15.5	Load resistors	145
15.6	Fuses	146

NOTE

These instruction manual do not purport to cover all details or variations in equipment, nor to provide for every possible contingency to be met in connection with installation, operation or maintenance.

Should further information be desired or should particular problems arise which are not covered sufficiently for the Purchaser's purposes, the matter should be referred to the local Siemens Sales Office.

The contents of this instruction manual shall not become part or modify any prior or existing agreement, commitment or relationship. The Sales Contract contains the entire obligations of Siemens. The warranty contained in the contract between the parties is the sole warranty of Siemens. Any statements contained herein do not create new warranties or modify the existing warranty.

0 Additional documentation

Supplementary instructions, currents > 600A:

Order no.: C98130-A1073-A11-*-7619

Further information can be obtained from the following publications:

Description SIMODRIVE 270:

Order no.: C98130-A1073-A1-*-7619

Wiring Manual:

Order no.: C98130-A1073-A1-*-22

Wiring Manual, currents > 600A:

Order no.: C98130-A1073-A11-*-22

Serial interface, instructions:

Order no.: C98130-A1073-A3-*-7619

Positioning control, instructions:

Order no.: C98043-A1211-L1-*-7619

Positioning control, wiring manual:

Order no.: C98043-A1211-L1-*-22

Catalogue SD81 and SD82

The present instruction manual and all publications listed in this chapter are available in the following languages:

German, English, French and Spanish

1 Introduction

The present manual is part of the SIMODRIVE® documentation. All documents can be ordered separately. The applicable order numbers are listed in Chapter 0 "Additional documentation" of this manual and in Catalog IT16, Order No. E80850-G37-X-A2. For ordering, please contact your local Siemens Office.

IMPORTANT NOTICE

This instruction manual contains information describing the operation of the drive using software version 3.3. While generally applicable to all earlier software versions, certain parameter and fault code definitions in this manual may exceed or conflict with those available in earlier software version.

Contact your nearest Siemens representative should you require further details regarding software versions.

1.1 General warning notes



WARNING

Hazardous voltages are present in this electrical equipment during operation. The units rated at 130A and over moreover contain dangerous rotating parts (fans).



Non-observance of the safety instructions can result in severe personal injury or property damage.

Only qualified personnel should work on or around this equipment after becoming thoroughly familiar with all warnings, safety notices, and maintenance procedures contained herein.

The successful and safe operation of this equipment is dependent on proper handling, installation, operation and maintenance.

1.2 Definitions

QUALIFIED PERSON

for the purpose of this instruction manual and product labels, a "qualified person" is one who is familiar with the installation, construction and operation of the equipment and the hazards involved.

In addition, he has the following qualifications:

- a) Is trained and authorized to energize, de-energize, clear, ground and tag circuits and equipment in accordance with established safety practices.
- b) Is trained in the proper care and use of protective equipment in accordance with established safety practices.
- c) Is trained in rendering first aid.

DANGER

for the purpose of this instruction manual and product labels, "Danger" indicates death, severe personal injury or substantial property damage will result if proper precautions are not taken.

WARNING

for the purpose of this instruction manual and product labels, "Warning" indicates death, severe personal injury or substantial property damage can result if proper precautions are not taken.

CAUTION

for the purpose of this instruction manual and product labels, "Caution" indicates minor personal injury or property damage can result if proper precautions are not taken.

NOTE

for the purpose of this instruction manual, "Note" indicates information about the product or the respective part of the instruction manual which is essential to highlight.



DANGER

Hazardous voltages are used in the operation of this equipment, and will cause severe personal injury or loss of life. The following precautions should be followed to reduce risk of injury or death.



1. Only qualified personnel familiar with this equipment and the information supplied with it should be permitted to install, operate, troubleshoot or repair the apparatus.
2. Installation of the equipment must be done in accordance with the National Electrical Code and any other state or local codes. Proper grounding, conductor sizing and short circuit protection must be installed for safe operation.
3. During normal operation, keep all covers in place and cabinet doors shut.
4. Before carrying out visual inspections and maintenance operations, make sure that the AC supply has been switched off and locked in the "OFF" position and that no dangerous voltage is present at the signalling relay contacts. The drive and motor will have hazardous voltages present until the AC feed is turned off. The drive contactor does not remove hazardous voltages when it is opened.
5. When it is necessary to make measurements with the power turned on, do not touch any electrical connection points. Remove all jewelry from wrists and fingers. Make sure test equipment is in good, safe operating condition.
6. While servicing with the power on, stand on some type of insulation, being sure not to be grounded.
7. Follow the instructions given in this manual carefully and observe all danger, warning and caution notices.
8. This list does not represent an exhaustive survey of the steps necessary to insure safe operation of the equipment. Should further information be desired, or should particular problems arise which are not covered sufficiently for the purchasers' purposes, the matter should be referred to the local Siemens sales office.

2 Description

The SIMODRIVE converters in the 6RA27 series for 3-phase connection take the form of all-digital static converters for four-quadrant DC drives in which all open and closed-loop control functions - from the ramp-function generator to the trigger set - and almost all auxiliary functions are performed by a 16-bit microprocessor. The units operate autonomously with the aid of an integral keyboard and digital display, and no additional equipment is required for programming. The "luxury" units (6RA27...V57) include a serial interface for the connection of a programming unit, printer or plaintext display.

The speed setpoint and actual-speed value can nevertheless be input in analog form. A spindle positioning module which provides for an oriented spindle stop without NC equipment, or a remote diagnosis and limit-value module are available as optional extras.

The armature is supplied by means of two fully controlled 3-phase bridges in circulating-current-free back-to-back connection. The power sections for the armature and the field are equipped with electrically insulated thyristor modules, which means that the heat sink is potential-free. The side panels, the front cover and the power terminal covers provide protection against accidental contact when operations are performed in the vicinity of the units (shock hazard protection VDE 0106/Part 100). All terminals are dimensioned in accordance with VDE 0113 A2, and are accessible from the front.

The units may be operated in the temperature range between 0 and + 35° C (non-ventilated: 0 to 45° C) at the rated power. The permissible temperature range during storage and transportation is -30 to + 85° C.

The degree of protection of the units in accordance with DIN 40050 and IEC 144 is IP 00

The units automatically adapt to power frequencies between 45 and 65Hz.

3 Design

The SIMODRIVE converters are distinguished by their compact, space-saving design, which does not impair the necessary accessibility. The special heat sink design permits the device to be installed with the heat sink or with both the heat sink and the fan outside the cubicle, thereby ensuring excellent heat dissipation.

4 Installation



CAUTION

Improper lifting can cause loss of life, or serious personal injury.

Lift only with adequate equipment and trained personnel.



The user is responsible for the installation of the converter unit, the motor, the transformer and the remaining equipment in accordance with the safety regulations (e.g. DIN, VDE) and all other relevant national or local requirements regarding contactor sizing, protection, grounding and provision of isolators, overcurrent protection, etc.

The installation of the equipment must conform to the safety regulations (e.g. DIN, VDE) and all other relevant national or local requirements. Proper grounding, conductor sizing and short circuit protection must be installed for safe operation.

The SIMODRIVE converters are designed for upright installation in cubicles or machine frames. They should be installed with the terminal blocks or terminal bars facing downwards. Unobstructed entry and discharge of cooling air must be ensured. A clearance of at least 100 mm must be provided above and below the units. Units with a rated current of 60 A or more can be installed by simply hooking them in a removable mounting plate, which must be installed beforehand. This mounting plate is included in the scope of supply, and has the same mounting dimensions as the units in the previous 6RA26 series. The units with a rated current of 30 A may only be installed on a flat surface. If this is not possible, the units must be mounted on spacers, which must compensate for surface unevenness.

5 Reduction tables

5.1 Correction of load ratings for cooling medium temperature

Ambient or cooling medium temp.	Correction of load ratings	
	Units with AN cooling	Units with AF cooling
+ 30 °C	+ 13 %	+ 4 %
+ 35 °C	+ 8 %	0 %
+ 40 °C	+ 4 %	- 6 %
+ 45 °C	0 %	- 12 %
+ 50 °C	- 6 %	- 17 %
+ 55 °C	- 11 %	- 22 % ¹⁾
+ 60 °C	- 18 %	

1) Only if fan is connected to 400V + 5% / -15%, 50Hz

5.2 Correction of load ratings for site altitude

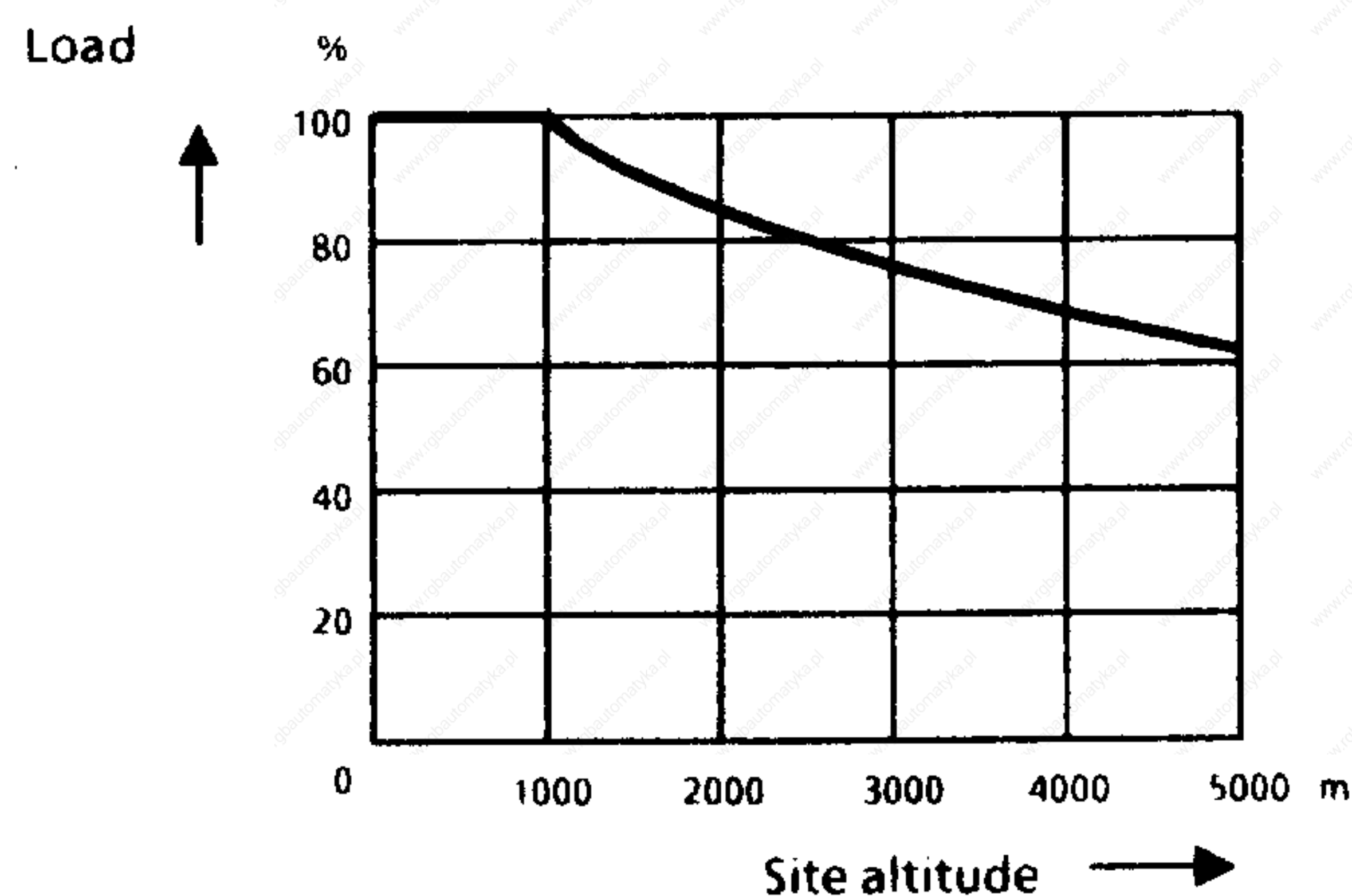

6 Block diagrams

6.1 Block diagram for basic unit (V55)

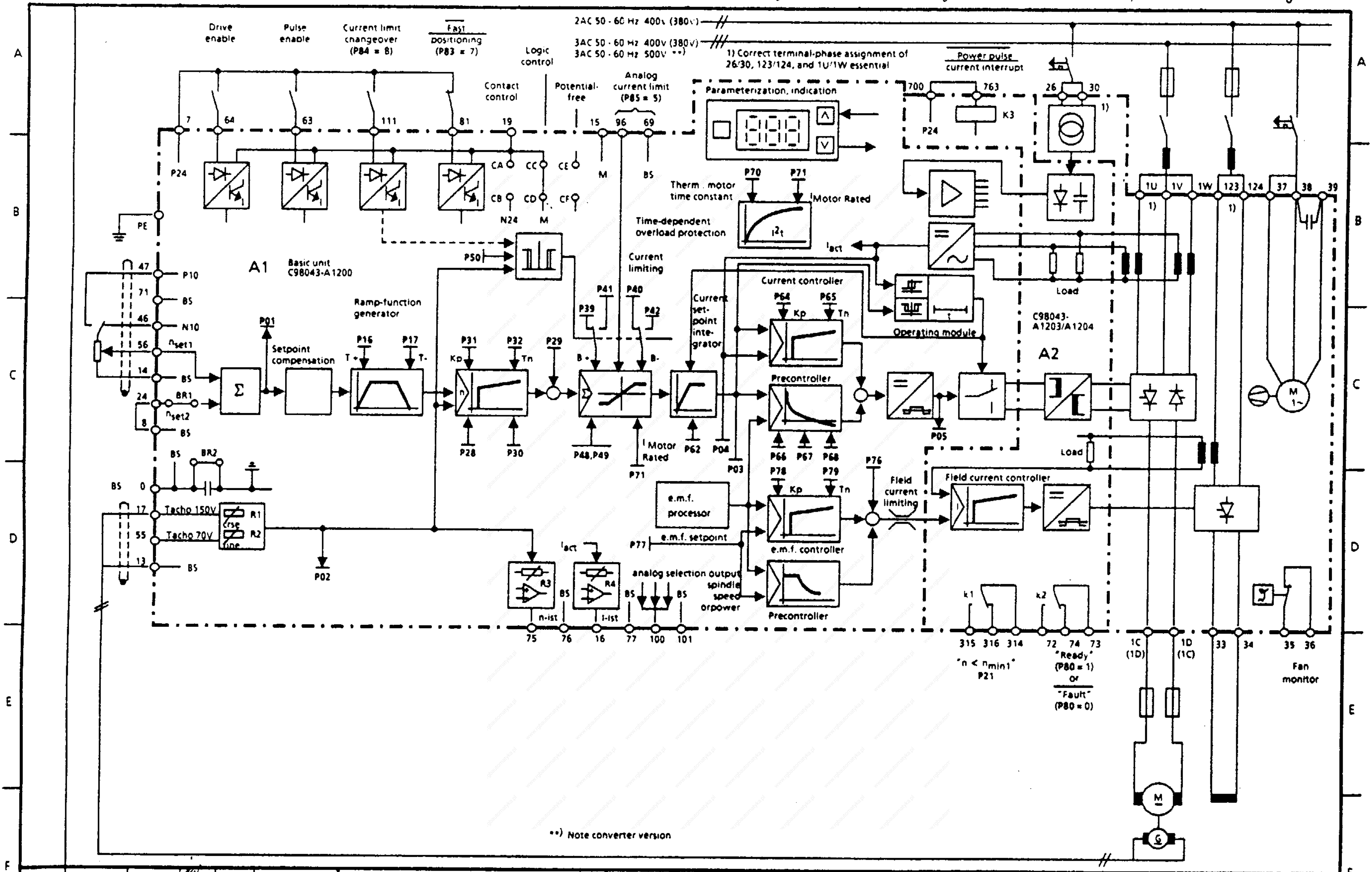

04	910036	31.10.90	Datum	25.04.86	SIMODRIVE Main spindle V55 (basic unit)	SIEMENS AG Austria	Static converter with digital servo control	Block diagram	C98130-A1073-A2-**-7612	Blatt 1 Bl.
03	900322	28.02.90	Bearb.	Witzmann						
02	90186	30.01.89	Gepr.		Urspr	Ers f	Ers.d			
Zustand	Änderung	Datum	Name	Norm						

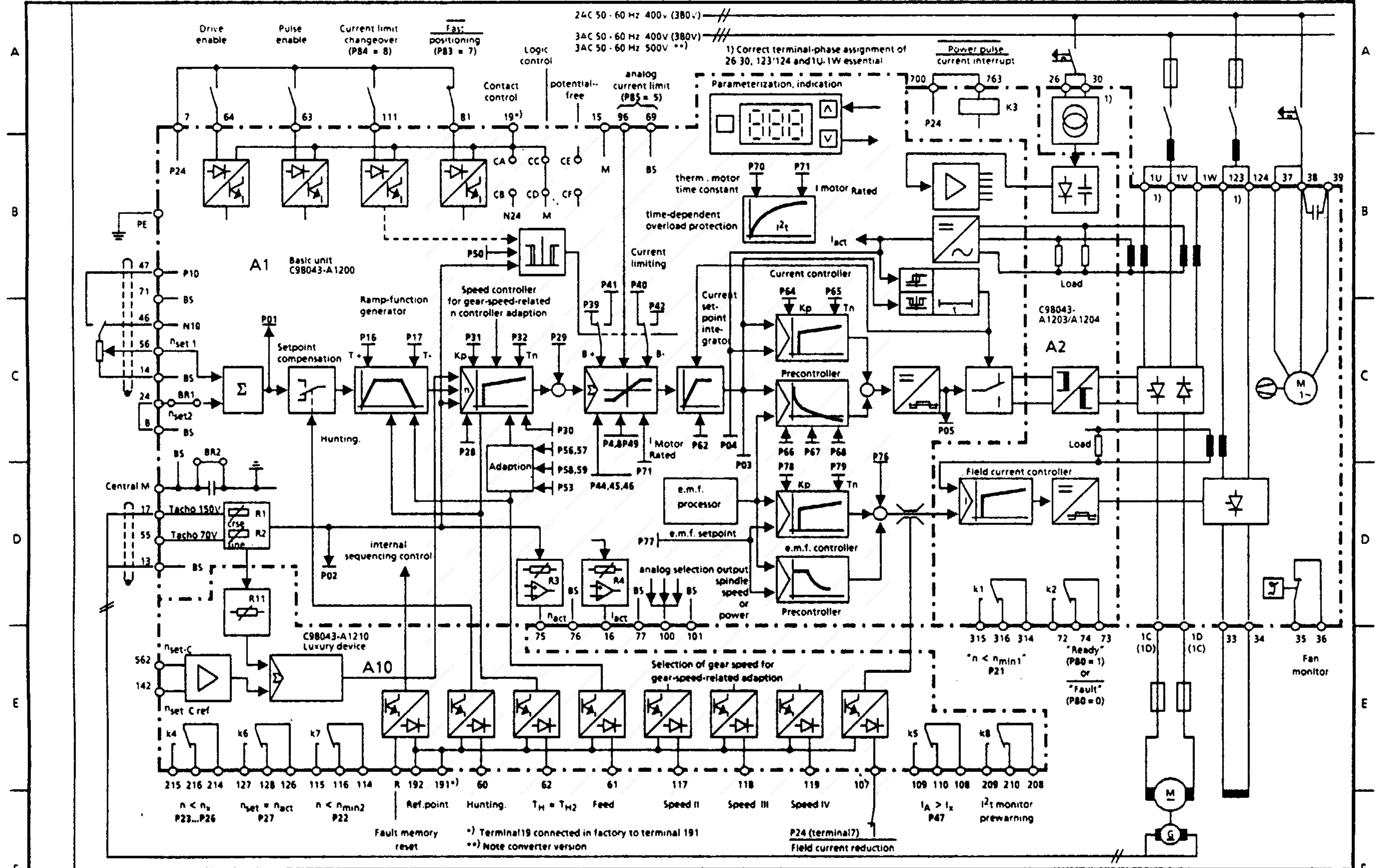

04	910036	31.10.90	Datum	25.04.86	SIMODRIVE Main spindle V57 (luxury unit)	SIEMENS AG Austria	Static converter with digital servo control	Block diagram	C98130-A1073-A1-**-7612	Blatt 1
03	900322	28.02.90	Bearb.	Witzmann						
02	90186	30.01.89	Gepr.		Urspr	Ers f	Ers d			BI
Zustand	Änderung	Datum	Name	Norm						

7 Connection

7.1 General



WARNING

This equipment contains hazardous voltages and hazardous rotating mechanical parts (Fan). Loss of life, severe personal injury or property damage can result if instructions contained in this manual are not followed.

The controller has hazardous voltages present even when the main drive contactor is open. The power and interface board, (bottom p.c. board), has many circuits that are at hazardous voltage.

The user is responsible for the installation of the converter unit, the motor, the transformer and the remaining equipment in accordance with the safety regulations (e.g. DIN, VDE) and all other relevant national or local requirements regarding conductor sizing, protection, grounding and provision of isolators, overcurrent protection, etc.

Hazardous voltages may be present on external surfaces of ungrounded controllers. This can result in loss of life, severe personal injury or substantial property.



If the drive cabinet or open chassis unit is mounted such that it is not grounded, a ground wire must be connected to the panel or enclosure frame for personnel safety. Also the motor frame, transformer enclosure and operator station must be connected to earth ground. For the specific requirements with regard to grounding of the equipment, refer to the safety regulations (e.g. DIN, VDE) and all other relevant national or local requirements.

Dangerous voltage from the customer installation can be connected to the signalling relay contacts.

The equipment may not be connected to a system protected by a residual-current device (VDE 0160, Section 6.5) because in the event of a short-circuit to frame or ground the operation of such a device can be hindered or prevented by a DC component present in the fault current. In such a case all other loads connected to the same residual-current device would also be without protection.

Without additional measures being taken, stopping of the drive via terminal 64 (drive enable), terminal 63 (pulse enable), terminal 81 (rapid stop) and / or terminal 763 (pulse current suppression) cannot be regarded as a safe stop in accordance with the applicable regulations (DIN VDE 0113, Part 1). This is because a fault in the converter electronics may result in unintentional starting of the motor.

Preparatory to work on or near the motor shaft and/or the machine spindle, the OEM must take appropriate additional safety measures (e.g. mechanical blocking of the spindle as a positive safeguard against unintentional starting of the motor and/or spindle in the event of a fault).

IMPORTANT NOTE

Incorrect connection of the equipment can lead to damage or destruction.

The devices must be connected up in accordance with the connection proposal (Chapter 6.1 and 6.2) and with the connection diagram provided by the customer.

NOTE

The following precautions must be taken to ensure interference immunity (EMC) in operation:

- Setpoint and actual value leads for analog signals must be shielded and routed separately from load voltage cables.
- Shielded cables must be directly mounted on the shield clamping bar by means of the shield clamps provided in the unit.
Exception: The setpoint cable shield must be connected at one end to the setpoint source (NC).
- Control leads for the digital inputs and the relay outputs must be laid separately from load voltage cables and contactor control leads.
- If contactors are located in the same cabinet, the contactor coils must be provided with RC elements or diodes.
- The electronics chassis potential (BS and M) of the SIMODRIVE unit may be tied to reference potential (chassis) at one point only (to prevent earth loops) (see Chapter 15.4).
- The earth-terminal screw of the unit must be conductively connected to the cabinet by the shortest possible route.

Converter units > 130A must be connected with twin parallel cables in order to comply with the conductor cross-sections called for in VDE0113.

NOTE

The correct terminal-phase connection of 1U/1W, 26/30 and 123/124 must be assured!

7.2 Connection of shielded control cables

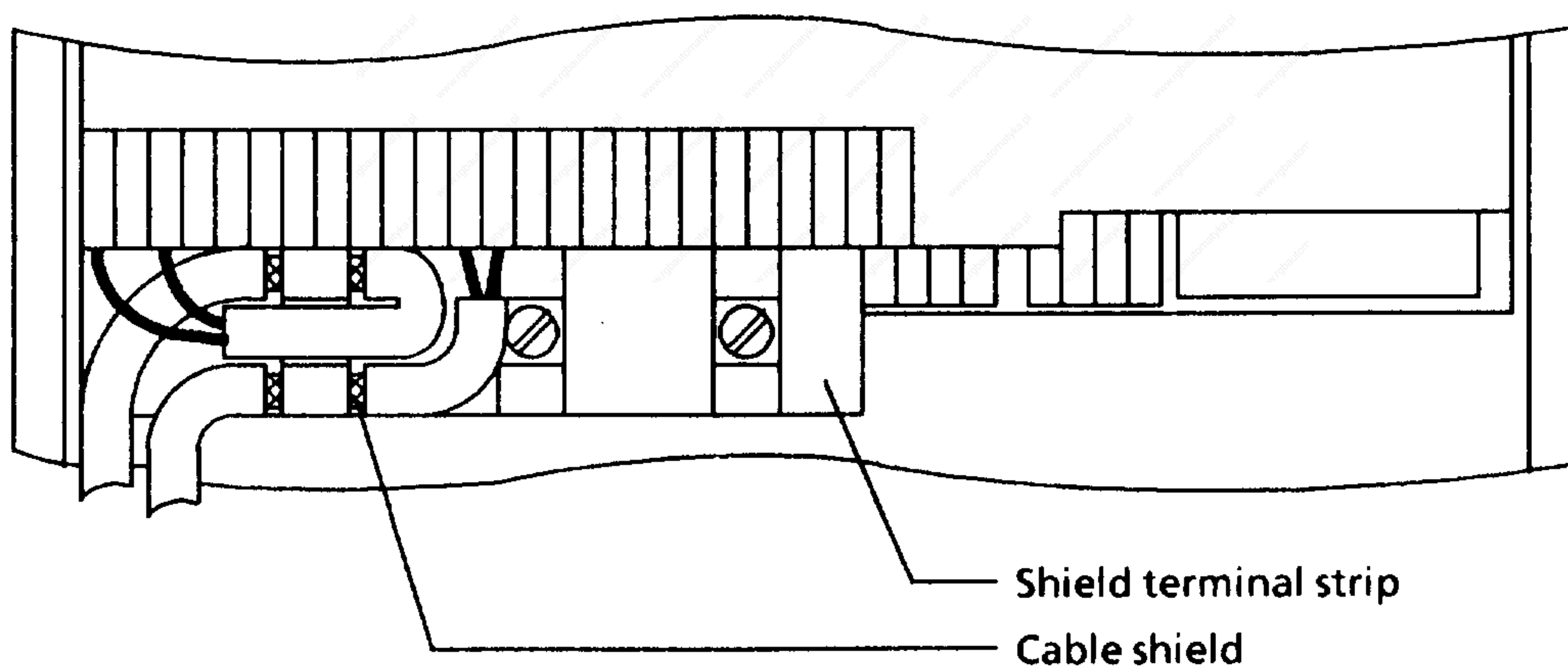

7.3 Power connection

Terminal types: Units for 30A Strip terminal BK16 (cross-section 10 mm²)
 Units for 60A to 250A Threaded bush M8 in 20mm wide copper bar
 Units for 400A to 600A Threaded bush M10 in 20mm wide copper bar

Terminal	Circuit diagram	Function
1U		Mains connection for armature circuit (rated AC voltage)
1V		3AC 400V ± 10%, 50 - 60Hz also suitable for 1)
1W		3AC 380V ± 10%, 50 - 60Hz 1)
		3AC 500V ± 10%, 50 - 60Hz also suitable for 2)
		3AC 380V ... 500V ± 10%, 50 - 60Hz
1C (1D)		Motor connection for armature circuit (rated DC voltage)
1D (1C)		DC 400V 1)
		DC 500V 2)
		DC 380V ... 500V depending on the AC supply voltage

- 1) Device type 6RA27 ... - 6DV5.
 2) Device type 6RA27 ... - 6GV5.

7.4 Earth connection

Terminal types: Units for 30A Threaded bolt M6
 Units for 60A to 130A Threaded bush M6 in heat sink
 Units for 190A to 250 A Threaded bush M8 in 55mm wide Al bar
 Units for 400A to 600 A Threaded bush M10 in 55mm wide Al bar

7.5 Fan connection for 190A to 600A devices with forced ventilation

X3

Terminal types: Unit terminals G5/6 (screw terminals) on the terminal block
 max. connectable cross-section: 4mm²

Terminal	Circuit diagramm	Function
37		Fan
38		2AC 400V (380V) + 10% -15%, 50 - 60Hz; 0,45A
39		Internally assigned, motor capacitor
-		Not used
35		Temperature monitor
36		(Relay contact opens in the event of heat sink overtemperature)

7.6 Terminals on modules A1203 and A1204

(Trigger module A1204: for units up to 250A
 Trigger module A1203: for 400A to 600A units)

X1

Terminal types: plug-in terminals combined to form blocks
 (the blocks are delimited by means of = in the list)
 max. connectable cross-section: 1,5 mm²

Terminal		Circuit diagram	Function
315	N.O. contact	$n < n_{min1}$	A Output relay K1; Function selectable with P21 P80 = 0: $n < n_{min1}$ ¹⁾ = 1: $n < n_{min1}$ (Relay energized at $n < n_{min1}$) ¹⁾ Delivery state = 2: $I < I_X$ (Relay energized at $I < I_X$) (I_X set with parameter P47) = 3: $I < I_X$ (Relay energized at $I < I_X$) (I_X set with parameter P47) = 4: Drive running (Relay energized at --, I or II) = 5: Speed controller monitoring (Relay energized at $n_{set} = n_{act}$)
316	N.C. contact		
314	Common point		
72	N.O. contact	<u>Ready / Fault</u>	Output relay K2; Function selectable P80 = 0: Fault (Relay de-energized in case of fault) = 1: Ready (Delivery state) = 2: Fault = 3: Ready = 4: Ready = 5: Ready
74	N.C. contact		
73	Common point		
700		P24	Non-stabilized power supply; may be ²⁾ only to activate terminal 763 + 18V to + 30V
763		<u>Power pulse current interrupt</u>	<u>Power pulse current interrupt</u> ²⁾ + 18V to + 30V, 25 mA : Power pulse current not interrupted

- 1) When there is no drive enable signal (terminal 64 = "LOW" or terminal 81 = "LOW"), the trigger pulses are blocked when the response value is reached.
- 2) In the delivery state terminal 700 is connected to terminal 763.
 Note: Terminal 763 must not be opened during operation ("Ready" active) since fuses may otherwise blow.

Current carrying capacity of relay contacts:

AC 50-60Hz ≤ 240V, 750VA resistive load, max. 3A (at 0.3 p.f.: 1A)
 DC ≤ 100V, max. 100W, max. 3A
 AC/DC ≥ 5V, 10mW

Recommended voltage for connection to the relay contacts:

AC/DC < 60V (for compliance with EMC standards)

X2

With 30A to 250A units on module A1204
400A to 600A units on terminal strip

Terminal types: Unit terminals G5/6 (Screw terminals)
max. connectable cross-section: 4mm²

Terminal	Circuit diagram	Function
26	2U	Electronics power supply 2AC 400V; $\pm 10\%$; $I_n = 0,1A$ or 2AC 380V; $\pm 10\%$; $I_n = 0,1A$ at 0.3 p.f.
30	2W	
123	3U	Field circuit Mains connection 2AC 400V; $\pm 10\%$, 50 - 60Hz or 2AC 380V; $\pm 10\%$, 50 - 60Hz
124	3W	
33	3C	Field circuit Field coil connection (Rated voltage) max. 310V =
34	3D	

NOTE

The correct terminal-phase assignment of 1U/1W, 26/30 and 123/124 is essential!

NOTE

In the case of units with a power section supply voltage outside the tolerance range of 380V + 20% -15% or 415V + 10% -22% (note max. permissible power section supply voltage, see Page 4!), the electronics power supply, the field circuit mains connection and the fan connection must be adjusted to AC 380V by means of a matching transformer (see also L34 in Chapter 14 "Parameter description").

The phase rotation must in this case be kept as low as possible (max. 1° electrical)! It is advisable to use a single-phase autotransformer.

The rated value of the power section supply voltage must be entered in parameter P98 (see P98 in Chapter 14 "Parameter description").

7.7 Terminals on module A1200

Terminal type: Plug-in terminals combined to form blocks
(the blocks are delimited by means of = in the list)
max. connectable cross-section: 1,5 mm²

Shields: Shields have a conductive electrical connection to the converter earth via the shielding strip.

Signal levels: High signal: + 10 ... 30V relative to the potential of terminal 19
Low signal: - 2 ... + 5V relative to the potential of terminal 19

Terminal	Circuit diagram	Function
17	Tacho 1	Speed actual value input max. 150V; 29,7kΩ (Jumper BR 7 inserted) max. 250V; 46,1kΩ (Jumper BR 7 open)
55	Tacho 2	Speed actual value input max. 70V; 13,3kΩ
13	BS	Reference potential for tacho 1 and tacho 2 0V
56	n _{set1}	Setpoint input 1 ± 10V; 10kΩ
14	BS	Reference potential for n _{set 1} 0V
24	n _{set2}	Setpoint input 2 ± 10V; 10kΩ
8	BS	Reference potential for n _{set 2} 0V
96	I _{LIMIT}	Analog input; function selectable ± 10V; 60kΩ P85 = 0: no function, works setting = 5: analog current limiting
69	BS	Reference potential for I _{LIMIT} 0V
75	n _{act} -indication	Speed actual value indication ± 10V set via R3; 2mA
76	BS	Reference potential for n _{act} - indication 0V

Terminal	Circuit diagram	Function
16	I_{act} -indication	Current actual indication (absolute value or output with sign) $\pm 10V$ set via R4; 2mA Setting range approx. 5 ... 13V $\hat{=}$ converter rated current P86 = 0: Current actual value indication with sign (+ - \rightarrow MI) = 1: Absolute current actual value indicated, works delivery state
77	BS	Reference potential for I_{act} -indication 0V
100	Analog selectable-function output	Analog output; function selectable $\pm 10V$; 2mA P82 = 0: no function, works delivery state
101	BS	Reference potential for analog selectable-function output 0V
7	P24	Non-stabilized power supply; may be used only to activate the binary input terminals + 18V to + 30V, max 100mA
64	DRIVE ENABLE	H-signal: + 10V ... + 30V; 4.8k Ω H-signal: run up to operating speed with ramp-function generator (if activated) if pulse enable signal is present simultaneously at terminal 63 L-signal: Deceleration to $n_{min 1}$ (P21) with ramp-function generator (if activated), controller disabled, $I = 0$, "Ready" relay de-energized.
63	PULSE ENABLE	H-signal: + 10V ... + 30V; 4.8k Ω H signal: Controller and trigger pulses enabled (only if terminals 64, 81 and 763 are activated). L signal: Controller disabled, α_W shifted, $I = 0$, trigger pulses disabled, "Ready" relay deenergized (motor coasts to standstill).



WARNING

Without additional measures being taken, stopping of the drive via terminal 64 (drive enable), terminal 63 (pulse enable), terminal 81 (rapid stop) and / or terminal 763 (pulse current suppression) cannot be regarded as a safe stop in accordance with the applicable regulations (DIN VDE 0113, Part 1). This is because a fault in the converter electronics may result in unintentional starting of the motor.



Preparatory to work on or near the motor shaft and/or the machine spindle, the OEM must take appropriate additional safety measures (e.g. mechanical blocking of the spindle as a positive safeguard against unintentional starting of the motor and/or spindle in the event of a fault).

Terminal	Circuit diagram	Function
81	<u>RAPID STOP</u>	Digital input; function selectable H-signal: + 10V ... + 30V; 4.8kΩ P83 = 0: no function, works delivery state = 7: <u>RAPID STOP</u> , deceleration at the current limit to n_{min1} (P21) "Ready" relay de-energized.
111	<u>I_{LIMIT} CHANGEOVER</u>	Digital input; function selectable H-signal: + 10V ... + 30V; 4.8kΩ P84 = 0: no function, works delivery state = 8: CURRENT LIMIT CHANGEOVER
19*)	REFERENCE POINT	Reference potential of external voltage source in conjunction with potential-free activation of terminals 64, 63, 81 and 111. Jumper in position CE - CF. Selectable reference potential in conjunction with activation with internal power supply (Terminal 7 = 24V) -24V: Jumper in position CA - CB (not recommended) 0V: Jumper in position CC - CD = delivery state
15	M	Chassis ground connection 0V
47	P10	Power supply output + 10V 10mA; ± 0,5%
71	BS	Reference voltage 0V
46	N10	Power supply output -10V 10mA; ± 0,5%

*) In luxury units terminal 19 of the basic device is connected in the factory to terminal 191. Terminal 192 on the luxury module can be used as a customer terminal.

The internal reference potential (BS) is brought out at a terminal with an M4 thread on module A1200 (as of hardware status A 1200-L13-04, D1, ...). In the delivery state the internal reference potential is connected via BR2 to the heat sink potential (ground).
If jumper BR2 is opened, the reference potential is connected to ground via 2 x 150nF.

NOTE

Any setpoint inputs not used (terminal 56 or terminal 24) must be connected to the reference potential (terminal 14 or terminal 8), and not left open.
Works delivery state; terminal 24 connected to terminal 8.

If terminal 96 is activated via P85 = 5, the terminal must also be activated.
[+ 10V or -10V ≙ current limit 1 (maximum values of P39 and P40)
0V ≙ 0A]

Enabling signals - pulse diagram

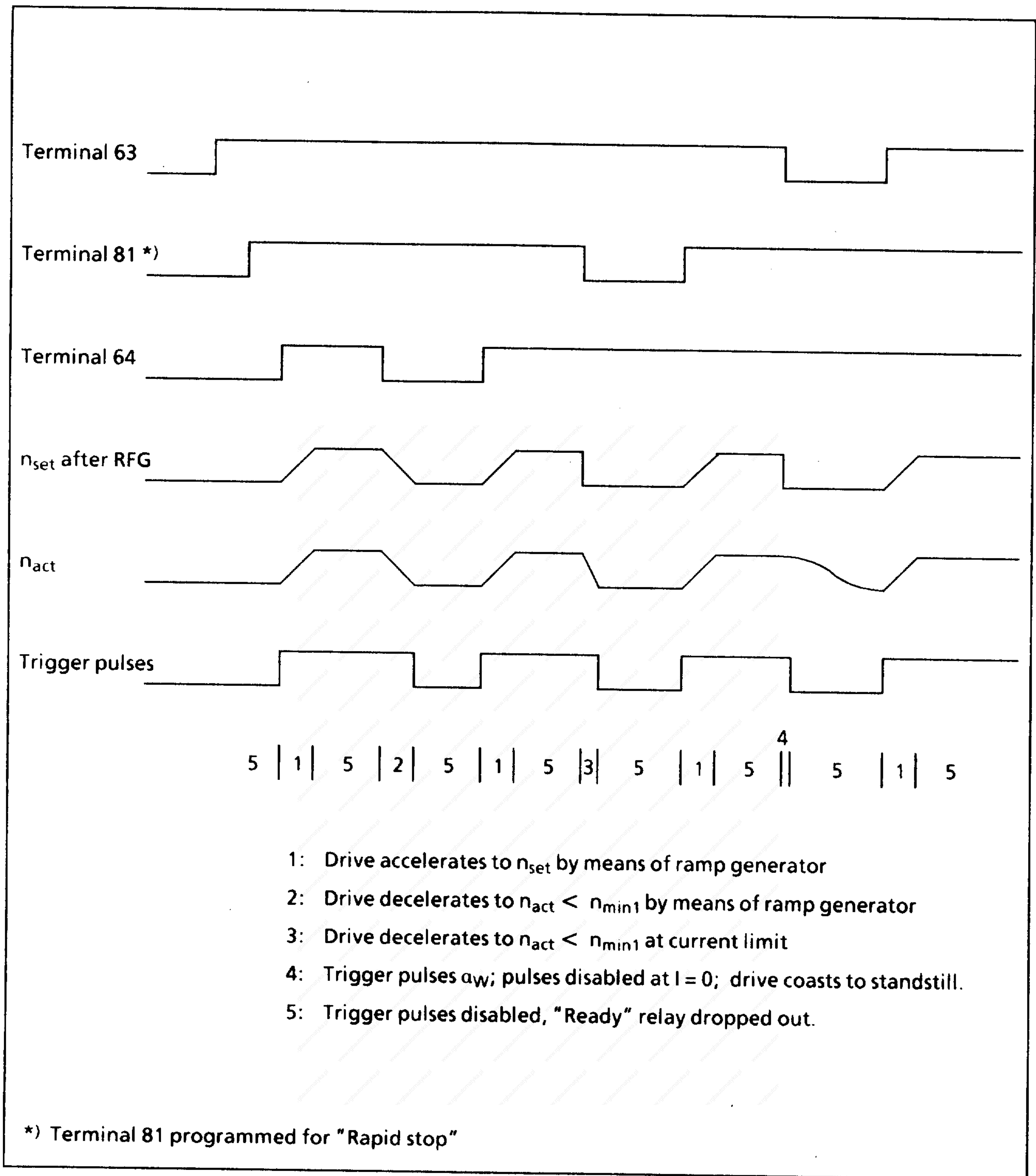

7.8 Terminals on module A1210 (Supplementary module for main spindle drives)

Terminal types: Plug-terminals connected to form blocks
(the blocks are delimited by means of = in the list)
max. connectable cross-section: 1,5 mm²

Shields: Shields have a conductive electrical connection
to the converter earth via the shielding strip.

Signal levels: High signal: + 10 ... 30V relative to potential of terminal 191
Low signal: - 2 ... + 5V relative to potential of terminal 191 or terminal open
Input resistance = 11kΩ; 4.8kΩ from product version A3 onwards

Terminal	Circuit diagram	Function
562	$n_{\text{set C}}$ analog input	Setpoint input for C-axis operation $\pm 10V$; 44kΩ to $n_{\text{set C ref}}$.
142	$n_{\text{set C ref}}$ analog input	Reference potential for $n_{\text{set C}}$
		3) Differential input
117	GEAR STEP II digital input	Selection of gear step II
118	GEAR STEP III digital input	Selection of gear step III
119	GEAR STEP IV digital input	Selection of gear step IV
60	OSCILLATING digital input	Selection of oscillation
61	FEED digital input	Selection of feed operation (C-axis)
62	$T_H = T_{H2}$ digital input	Selection of ramp-up time = ramp-up and ramp-down times 2 (E16 = HLZ2 und E17 = RLZ2) and speed controller adaption for NC postioning (parameters P60 and P61 are active)
107	$I_{\text{EXC min}}$ digital input	Selection of field current reduction (standstill field) (High signal $\hat{=}$ full field)
R	FAULT MEMORY RESET digital input	Fault memory reset + 10V ... + 30V; 11kΩ
192	REFERENCE POINT for digital inputs	Reference point for terminals 60, 61, 62, 107, 117, 118, 119, R
191		Terminal for reference point Terminal 19 of basic unit

Ref. potential: If it is desired that the input terminals of supplementary module A1210 (except terminal $n_{\text{set C}}$) and of electronics module A1200 are at a common reference potential, terminal 191 must be connected with terminal 19 (works delivery state).

Signalling relay			
Terminal		Circuit diagram	Function
215	N.O. contact	$n < n_x$	Output relay: Speed threshold value n_x (parameter P23 . . . P26) undershot Differential gap adjustable in Parameter E86
216	N.C. contact		
214	Common point		
109	N.O. contact	$I_A > I_x$	Output relay: 1) Current threshold value I_x (parameter P47) exceeded Differential gap adjustable in Parameter E86
110	N.C. contact		
108	Common point		
127	N.O. contact	$n_{set} = n_{act}$	Output relay: 2) Speed setpoint n_{set} reached Response threshold adjustable in Parameter P27
128	N.C. contact		
126	Common point		
115	N.O. contact	$n < n_{min2}$	Output relay: Minimum speed n_{min2} (parameter P22) undershot Differential gap adjustable in Parameter E86
116	N.C. contact		
114	Common point		
209	N.O. contact	2T monitor	Output relay: (Prewarning: time-dependent overload protection)
210	N.C. contact		
208	Common point		

- 1) Suppressed during parametrized ramp-up and ramp-down time + 300ms
- 2) Suppressed during parametrized ramp-up and ramp-down time and when pulse disable is operative
- 3) Scaling range of potentiometer R11: Jumper X2 in position 1 - 2: approx. 85 . . . 600min⁻¹
Jumper X2 in position 2 - 3: approx. 333 . . . 2350min⁻¹
(from product version A3 onwards)
when $n_{setC} = 10V$ and with 20mV / min⁻¹ tachometer
Jumper X1 must not be changed (delivery state 2 - 3)

Relay load capability:

AC 50-60Hz ≤ 60V, 180VA resistive load, max. 3A (at 0.3 p.f. : 1A)
DC ≤ 100V, max. 100W, max. 3A
AC/DC ≥ 5V, 10mW

7.9 Hardware interface for connection of a printer (on module A1210-L21 or -L41)

X500

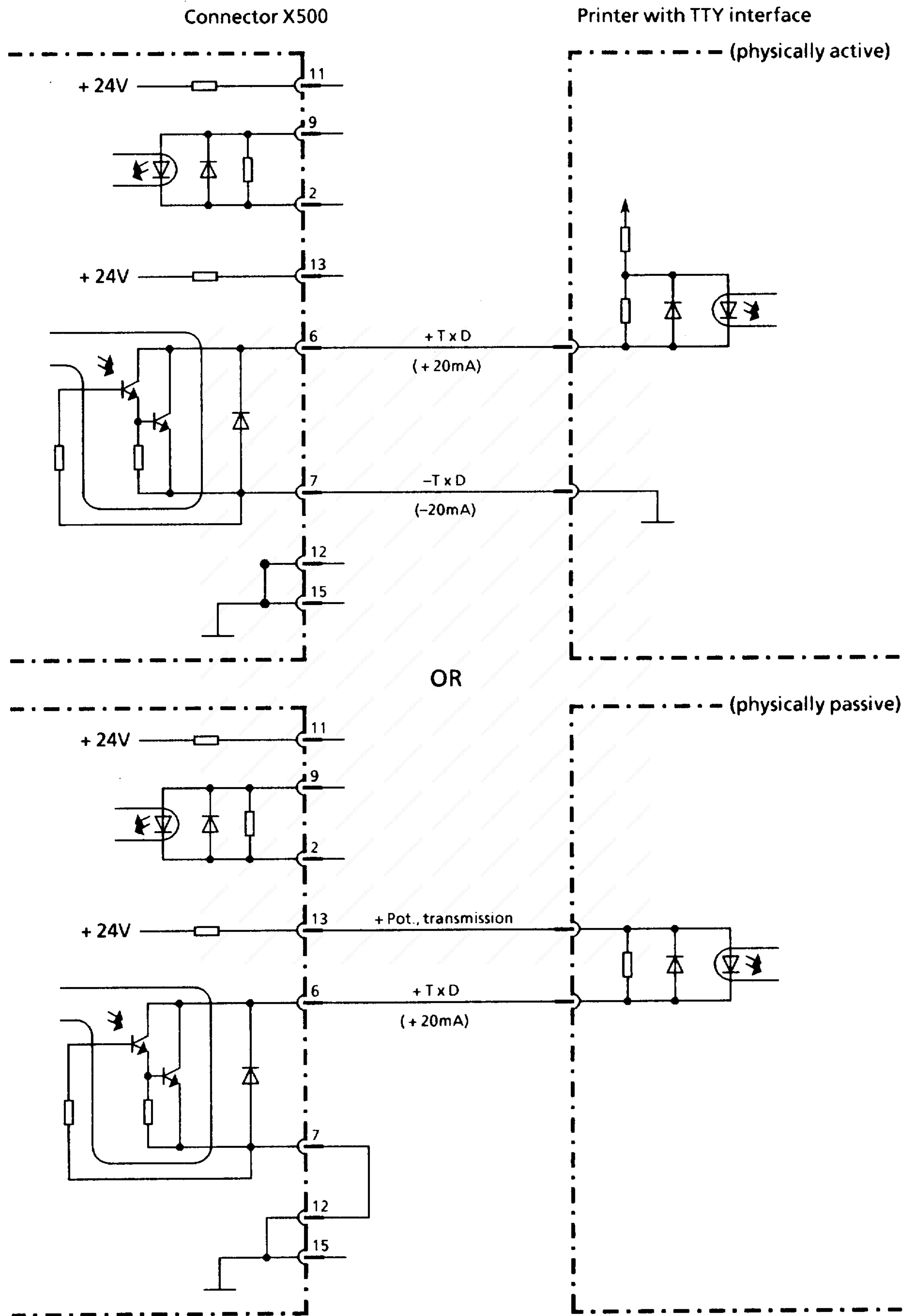

Subminiature D socket connector, 15-pole

**7.10 Hardware interface for connection of a PG 635 / 675 / 685
(on module A1210-L21 or -L41)**

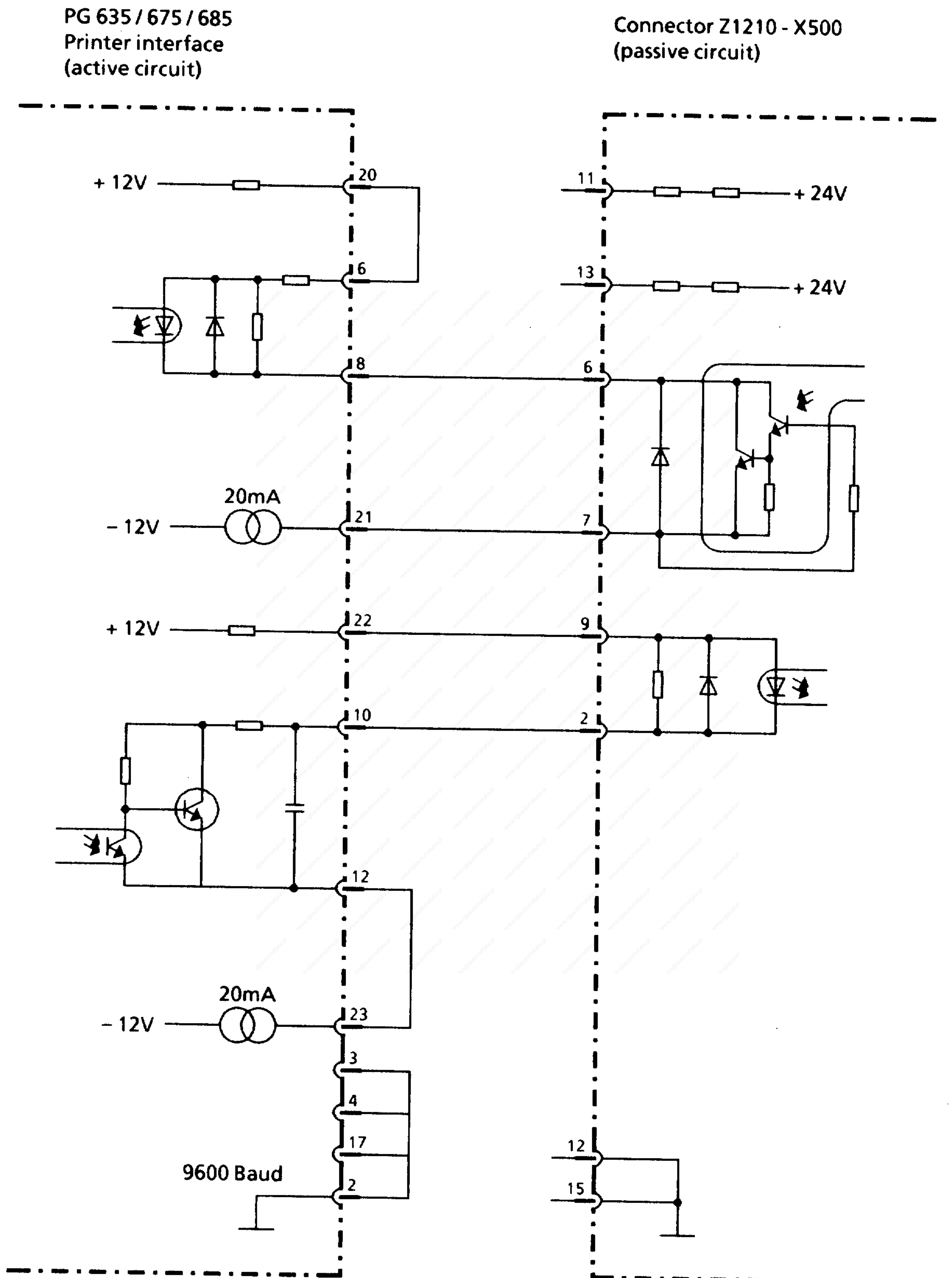

Order no. of cable:
6ES5731-1BD20 (3.20m length)
(Remove locking device on PG end!)

Subminiature D socket connector, 15-pole

8 Instructions for use

The units can be flexibly matched to different operating conditions.

Matching to 50 or 60 Hz mains frequency occurs automatically.

The matching operations, settings and measurements necessary for startup of the DC drives can be performed simply by pressing the pushbuttons. The operating status of the unit and any fault messages are indicated automatically. Automatic optimization programs can be selected.

Parameterization

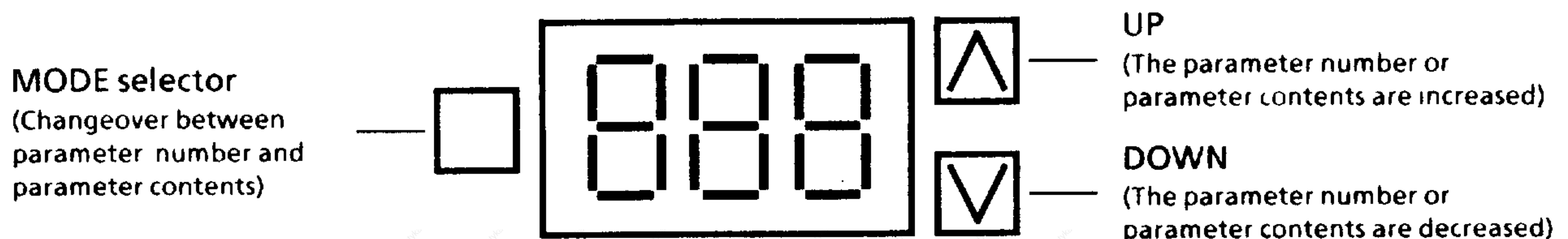

Parameter settings:

The parameterization device comprises three pushbuttons and three 7-segment displays.

When the unit is switched on (supply voltage connected), the operating status indication (see Chapter 9) will appear, provided no fault indications are present.

The operating status indication is stored under the parameter number P00.

The following parameters are assigned to the converter unit:

P00 to P99	(basic parameters)
E00 to E86	(extension parameters)
U00 to U89	(Parameters for options)

When the power supply is switched on, all parameter contents are disabled and cannot be modified. Authorization to modify parameter contents is granted when a code number is entered into the code parameter P51. Modifications to parameters take effect immediately, and are stored in a non-volatile memory (EEPROM).

P51: Code number	Function
0	No parameters can be modified (set automatically when the power supply is switched on)
2	Self-optimization of pilot controller / current controller selected
3	Automatic self-optimization of speed controller selected
4	Parameters P11 to P79, all E parameters and all U parameters can be modified
5	Automatic field characteristic measurement selected
6	Automatic calculation of speed-related current limit from motor rating plate data selected
10	Parameters P80 to P99 can be modified

Potentiometer settings:

- 1) The maximum speed of the main drive is matched with the aid of potentiometers.
Speed actual value adaption for DC tachogenerators

- Main spindle operation: Potentiometer R1 (coarse adjustment)
Potentiometer R2 (fine adjustment)
- Feed operation: (C axis) Scaling range of potentiometer R11
 - Jumper X2 in position 1 - 2: approx. 85 ... 600min⁻¹
 - Jumper X2 in position 2 - 3: approx. 333 ... 2350min⁻¹
(from product version A3 onwards)

when $n_{setC} = 10V$ and with 20mV / min⁻¹ tachogenerators
Jumper X1 must not be changed (delivery state 2 - 3)

- 2) The external instruments are normalized using the potentiometers





- R3 : Speed actual value indication
- R4 : Current actual value indication

NOTE

The rating plate data of the motor and SIMODRIVE unit must be recorded in Chapter 12.11 of the Description.







9 Operating states

Indications following startup or contents of parameter P00

Indication	Meaning
 ¹⁾	<p>QUICK STOP is set at terminal 81 (open or < 5V) Discontinuation of QUICK STOP command (10 to 30 V at terminal 81) and subsequent opening and closing of terminal 64 (DRIVE ENABLE) causes the waiting state to be exited and changeover to the next status indication.</p>
	<p>No DRIVE ENABLE set at terminal 64 (open or < 5V) If a DRIVE ENABLE signal is applied (10 to 30 V at terminal 64), the wait state will be exited and the next operation indication will appear.</p>
	<p>No PULSE ENABLE set at terminal 64 (open or < 5V) If a PULSE ENABLE signal is applied (10 to 30 V at terminal 64), the wait state will be exited and the next operation indication will appear.</p>
	<p>Not assigned (to be used for future applications)</p>

1) The QUICKSTOP function is also effective during current-controlled operation (P89 = 3)!
 If a QUICKSTOP command is given during current-controlled operation, the speed controller is switched in automatically and the QUICKSTOP function executed by it.

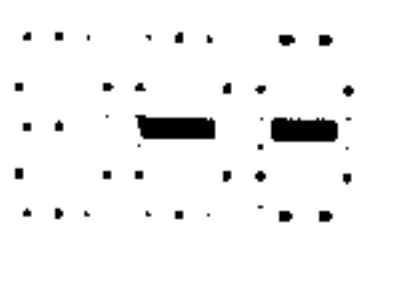
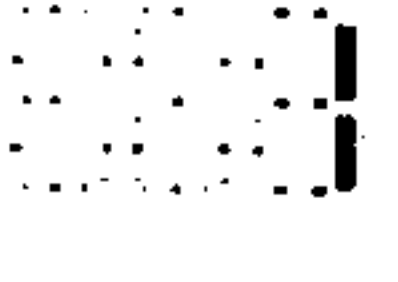
- IMPORTANT:** As a necessary prerequisite, the settings of the speed controller parameters must be reasonably correct!
- IMPORTANT:** The QUICKSTOP function is not available if P89 = 2 or P63 = 3!

Indication	Meaning
	2) 3) The field current actual value is < 50 % of the set field current setpoint P76. If P76 = 0, or if the field current actual value is in the region of the field current setpoint, the next operation indication will appear.
	2) 3) No voltage present at the power terminals (measured with the optocoupler) When a voltage is measured at the power terminals (power contactor switched on), the next operation indication will appear.
	3) Check of mains conditions (indication not continuous). If the mains voltage is in order, the next operation indication will appear automatically; if not, a fault indication will appear.
	3) Wait state in conjunction with disabled controllers (only appears if terminal 81 or 111 is programmed for inching function).
	3) No torque direction set
	3) Torque direction I set Bridge 1 is driven. A positive output current is obtained (converter terminal C is positive).
	3) Torque direction II set Bridge 2 is driven. A negative output current is obtained (converter terminal C is negative).

The hundreds position of the operating state display in Parameter P00 indicates whether the speed setpoint or the current setpoint is at one of its limit values.

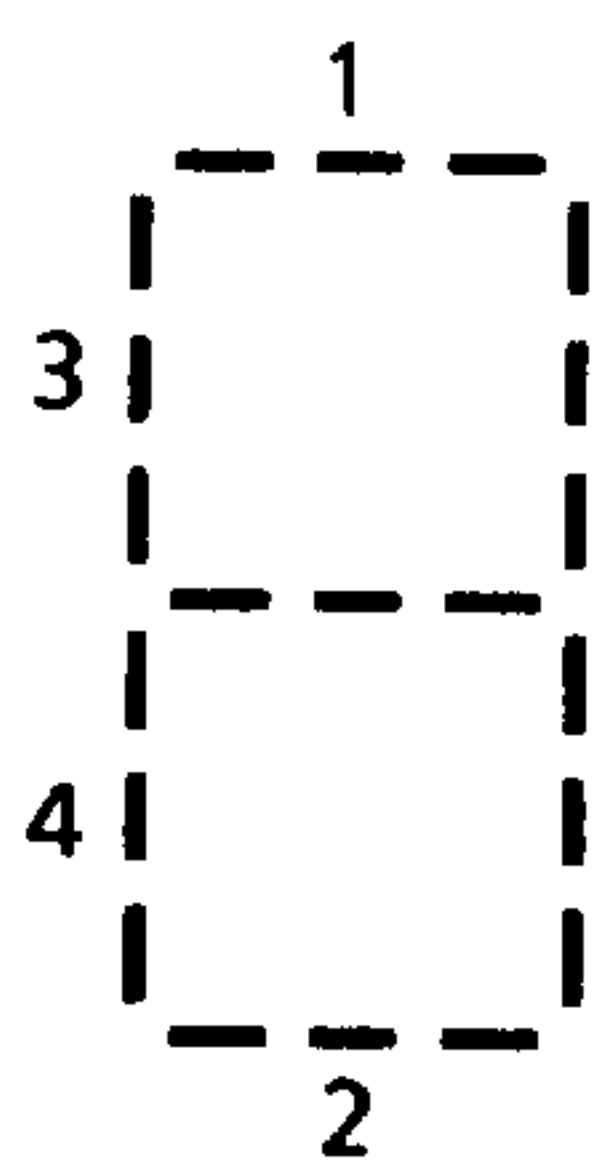

- Segment 1 lights up, if n controller setpoint is at positive limit (calling for torque direction I)
- Segment 2 lights up, if n controller setpoint is at negative limit (calling for torque direction II)
- Segment 3 lights up, if I controller setpoint is at positive limit (calling for torque direction I)
- Segment 4 lights up, if I controller setpoint is at negative limit (calling for torque direction II)

- 2) States o3 and 04 cannot remain present for a total of more than 2 s. If the time expires in state o3, fault F04 will be indicated; if the time expires in state o4, fault F14 will be indicated.
- 3) "Ready" signal is present.

10 Notes on startup

10.1 General warning notes on startup



DANGER



Before putting the unit into service, ensure that the clear plastic cover is in position over the power terminals.



WARNING

This equipment contains hazardous voltages and hazardous rotating mechanical parts (fan). Loss of life, severe personal injury or property damage can result if instructions contained in this manual are not followed.

Dangerous voltage from the customer installation may be present at the signalling relay contacts.

The equipment may not be connected to a system protected by a residual-current device (VDE 0160, Section 6.5) because in the event of a short-circuit to frame or ground the operation of such a device can be hindered or prevented by a DC components present in the fault current. In such a case all other loads connected to the same residual-current device would also be without protection.



Only qualified personnel should work on or around this equipment after becoming thoroughly familiar with all warnings, safety notices, and maintenance procedures contained herein.

The successful and safe operation of this equipment is dependent on proper handling, installation, operation and maintenance.

The controller has hazardous voltages present even when the main drive contactor is open. The power and interface board (bottom p. c. board) has many circuits that are at hazardous voltages. Turn off and lockout all power sources at the feeder to the drive before performing maintenance or repair.

This procedure does not represent an exhaustive survey of all steps necessary to ensure safe operation of the equipment. Particular applications may require further information or procedures. Contact the nearest Siemens sales office should particular problems arise which are not covered sufficiently for the purchaser's purpose.

The use of unauthorized parts in the repair of this equipment or tampering by unqualified personnel will result in dangerous conditions which can cause death, severe personnel injury or serious equipment damage. Follow all safety precautions contained in this manual and all safety warning labels on the product.

Refer to the full set of safety warnings on pages 1 and 2 of this manual.

10.2 General

10.2.1 The startup instructions below in the form of a flowchart presuppose that the unit is operated according to the principle shown in the connection diagram C98130-A1073-A1-*-7612 or C98130-A1073-A2-*-7612 Chapter 6. Before startup the external connections, the protective measures and additional devices such as the superfast special fuses must be checked. The SIMODRIVE unit must be matched to the motor in accordance with the startup instructions. Plant-specific requirements must be taken into account.

10.2.2 The following calculations must be performed:

$$\frac{\text{Motor rated current, armature}}{\text{Conv. rated current, armature}} = A = \quad \text{in percent}$$

$$\frac{\text{Motor rated current, field}}{\text{Conv. rated current, field}} = B = \quad \text{in percent}$$

It is advisable to match the converter unit to the motor data if $A < 40\%$ and $B < 20\%$. This is accomplished by disconnecting load resistors on the A1204 or A1203 module. The converter rated current can be reduced to approximately $\frac{1}{3}$ or $\frac{2}{3}$ of the original rated value; exact details can be found in Chapter 15.5.

Important: Measurements must be taken to check the actual field current.
P76 must be corrected if necessary.
Deviations by approx. ± 5 percent of the theoretical value are normal.

Arrangement of load resistors

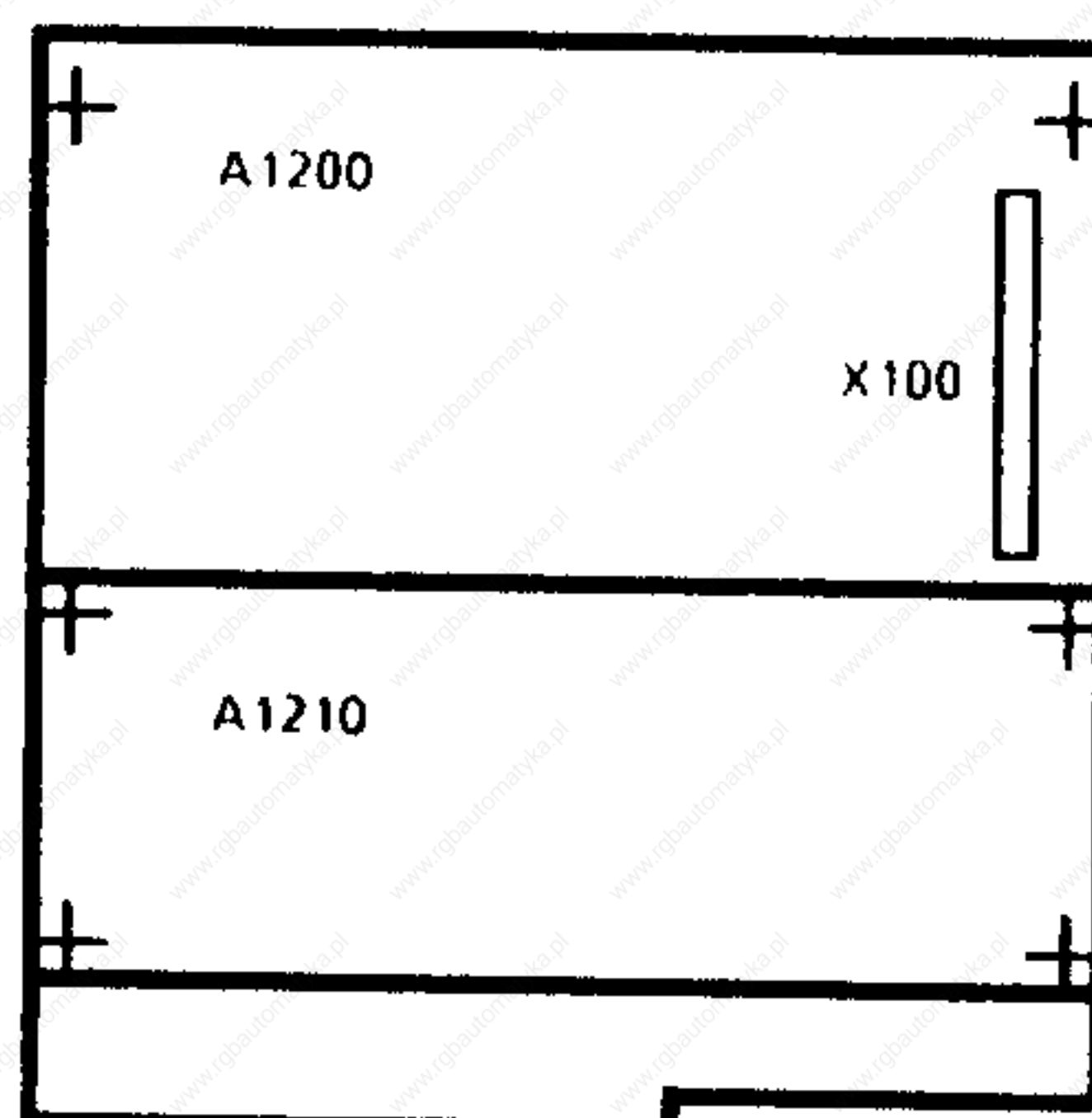

The load resistors are arranged as follows on soldered pins on the A1203 or A1204 module:

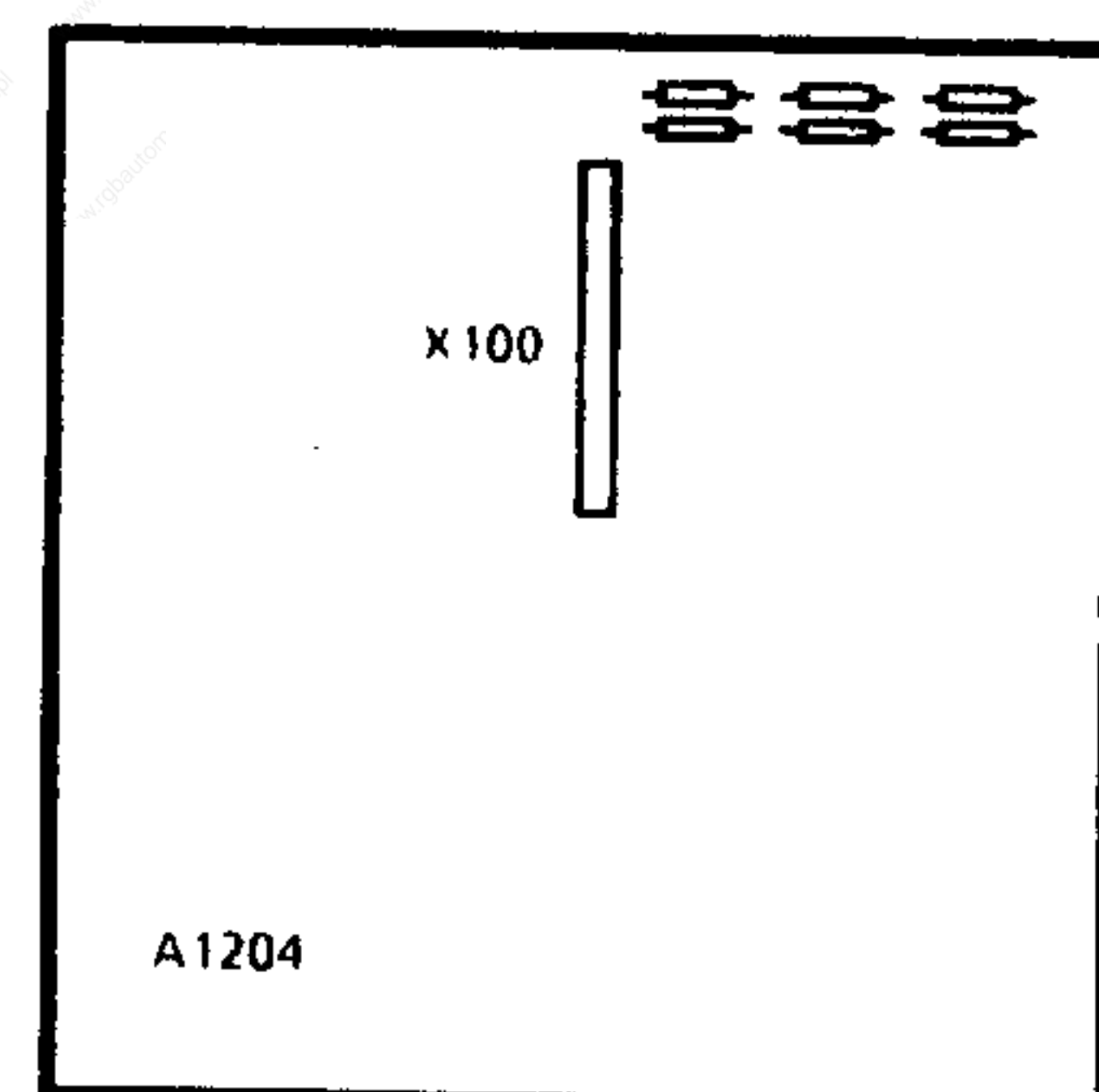
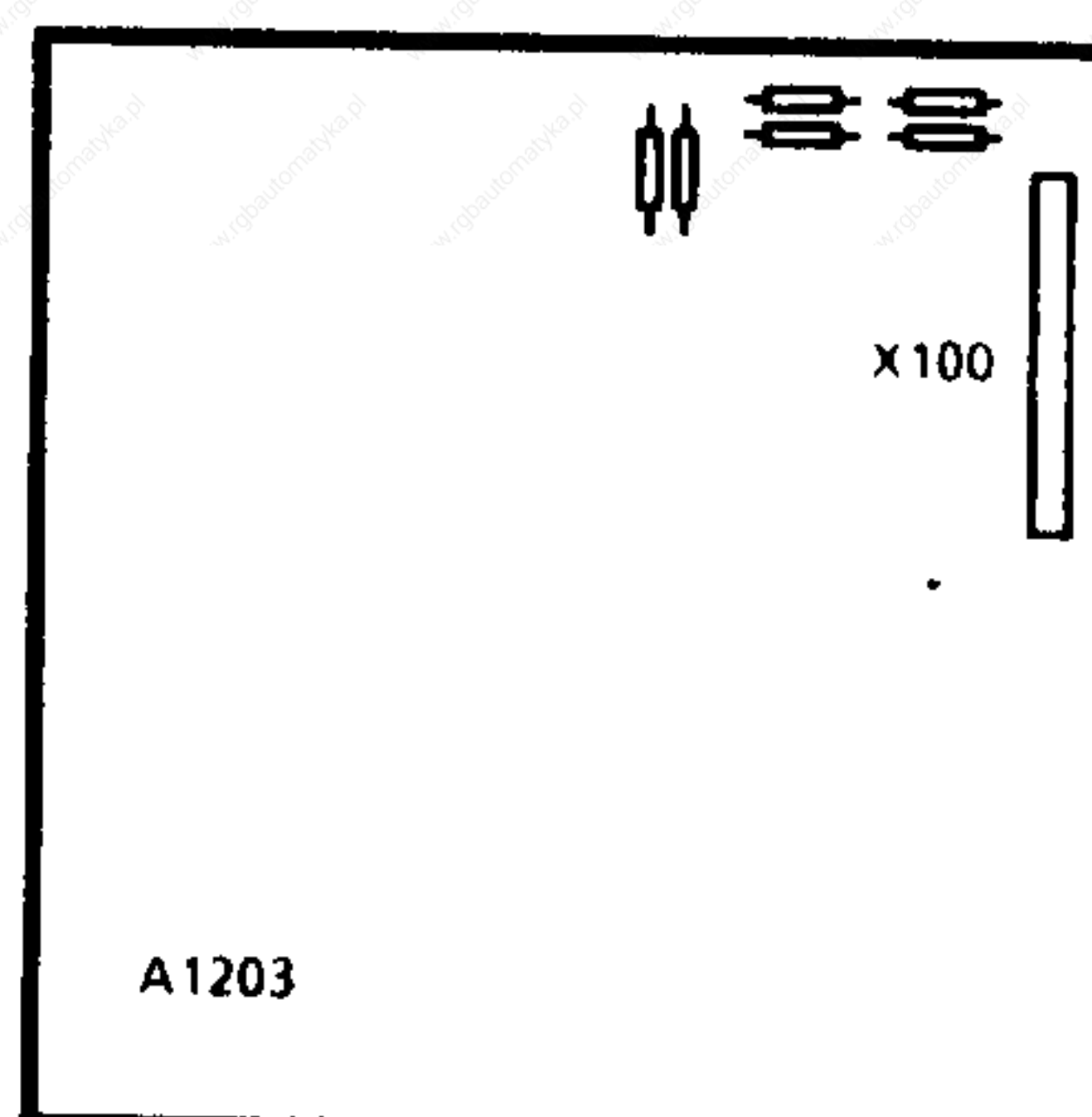

10.2.3 Parameters must be modified on startup. Authorization to modify the parameters is granted by means of the code parameter P51.

P51 = 4 authorizes modification of parameters P11 to 79 and of all E and U parameters;

P51 = 10 authorizes modification of parameters P80 to 99;

P51 = 0 prevents modification of all parameters.

Parameter P51 is set to 0 automatically when the electronics power supply is switched on.

10.3 Speed-related current limitation

10.3.1 Motors with safe-commutation limit

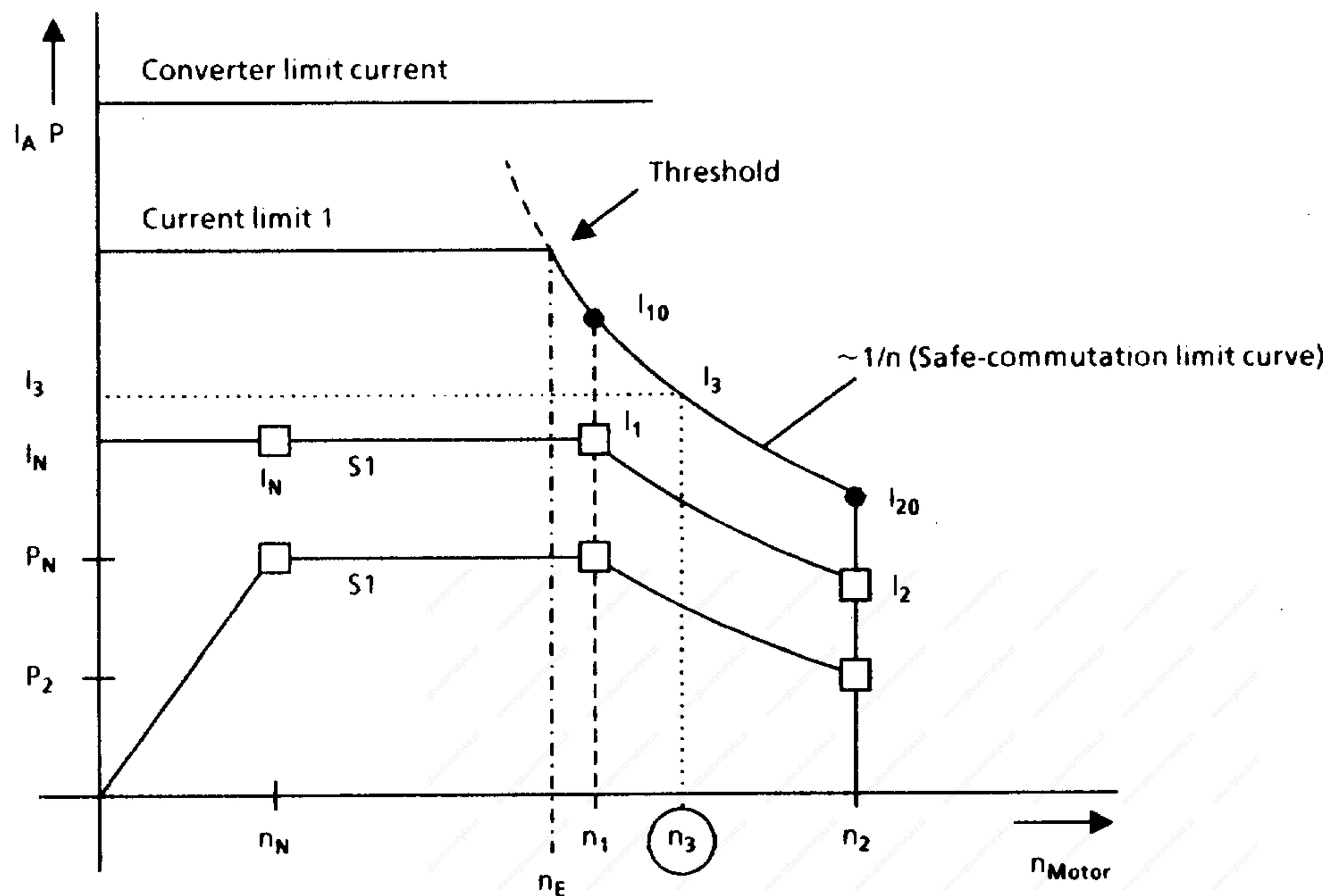

□ Motor rating plate data

n_E = Speed at which speed-related current limitation begins

● Permissible limit values

○ n_3 = Maximum motor speed

$$I_{10} = a \times I_1 \quad \text{Siemens-motors (1Gx5100 to 1Gx5166):} \quad a = 1 \quad ; \quad b = 1$$

$$I_{20} = b \times I_2 \quad \text{Siemens-motors (1Gx5182 to 1Gx5406):} \quad a = 1,4 \quad ; \quad b = 1,2$$

The speed-related current limit is defined by the following hyperbolic function:

Basic formula:

$$I_{A \text{ limit}} = \frac{K}{n_{Motor} - n_0}$$

Example of a motor rating plate:

* SHUNT-WOUND MOT. 1GG5162-0GG4 -6HU7					
IEC 160	NO.E	VDE 0530			
V	1/MIN	A	KW		
46-380	50-1490	78.0-78.0	0.880-26.0		
380	3400 / 4500	80.0 / 58.0	26.0 / 19.0		
SEPARATE	V	A	THYR.: B6C LV =	0MH 380V/ 50HZ	
EXCITATION	310	2.85	IP23	TYPE OF CONSTR.	
	77/51	0.87/0.60		I.CL. F	
Z:A11	G18	K01	K20		
SEPARATE VENT.	VIBRATION SEVERITY GRADE R				

10.3.2 Motoren ohne Kommutierungsknick

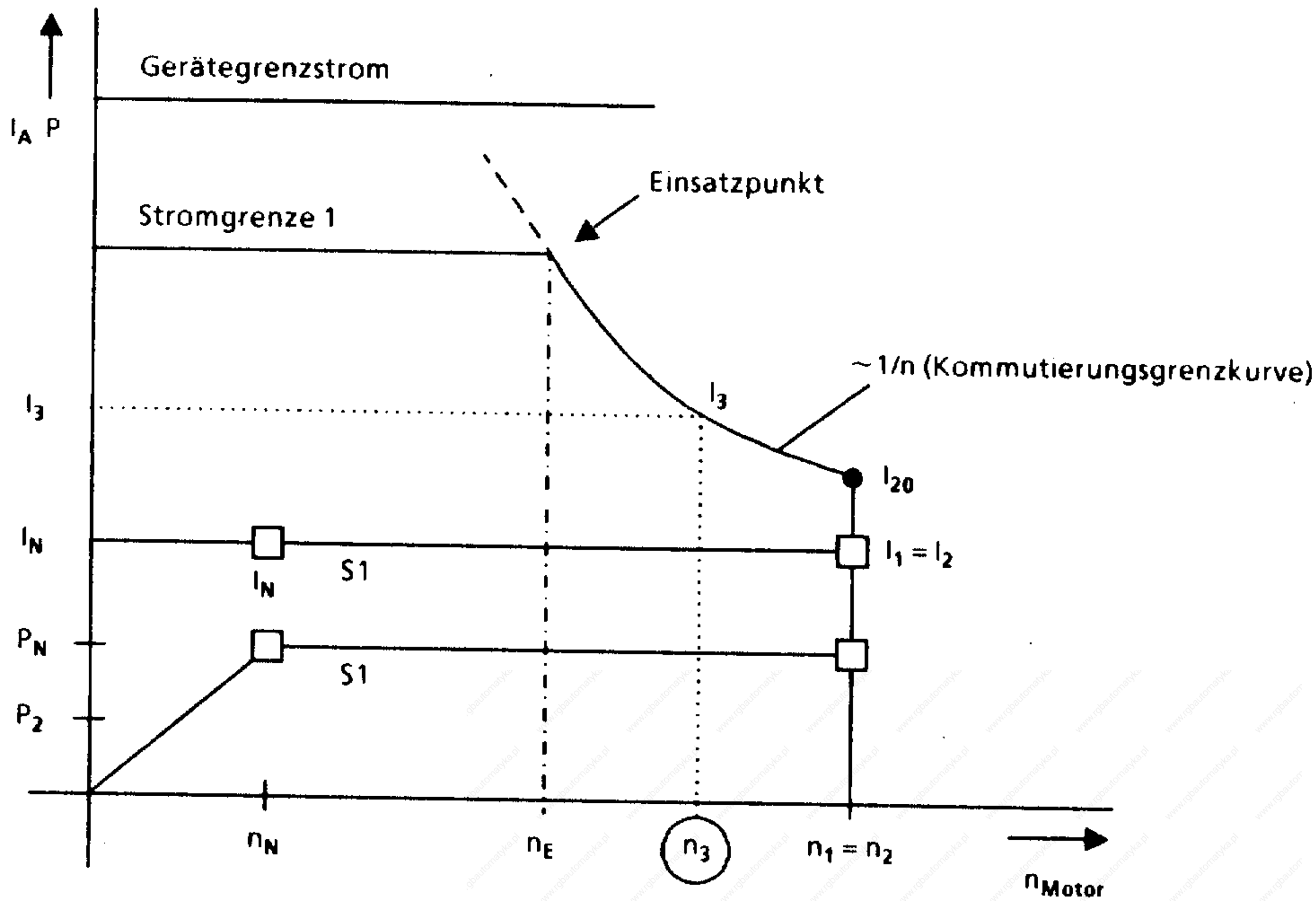

- Leistungsschilddaten des Motors
- zulässige Grenzwerte
- n_E = Einsatzpunkt der drehzahlabhängigen Strombegrenzung
- n_3 = Maximaldrehzahl Motor

$I_{20} = b \times I_2$ Siemens-Motoren (1Gx5100 bis 1Gx5166): $b = 1$
 Siemens-Motoren (1Gx5182 bis 1Gx5406): $b = 1,2$

Nachbildung der drehzahlabhängigen Strombegrenzung mit folgender Hyperbelfunktion:

Grundformel:

$$I_{A \text{ Grenz}} = \frac{K}{n_{\text{Motor}}}$$

Beispiel eines Motortypschildes:

* NEBENSCHL.-MOT. 1GG5116-0FH4 -6HU7			
IEC 160	NR.E	VDE 0530	
V	$n_2 = n_1$ 1/MIN	A	KW
39-380	50-2300	36.0-37.5	0.265-12.0
380	6000 REG.	38.5 — $I_2 = I_1$	12.0
ERR.	V	A	THYR.: B6C LV = 0MH 380V/ 50HZ
FREMD	310	1.45	IP23
	54	0.32	BAUF. I.CL. F
Z:A11 G18 K01 K20			
FREMDKUEHLUNG SCHWINGSTAERKESTUFE R			

10.3.3 Calculation of the relevant parameters

Parameterization of the speed-related current limitation involves parameters P48 and P49. The speed-related limitation must be matched to the particular main spindle motor.

The following data must be known:

- Motor rating plate data (I_1, I_2, n_1, n_2)
- Current limit 1 (Parameters P39 and P40)
- max. speed of the main spindle motor (tacho scaled for $n_{max} = n_3$)

Important: Changing of one of the values necessitates recalculation of Parameters P48 and P49!

Automatic calculation of P48 and P49 (speed-related current limitation) from the motor rating-plate data:

The necessary data are input by a menu-driven procedure.

- a) This menu can only be called up in operational states o8, o7 and o6.
- b) Activation of the calculation by setting key parameter P51 to 6.
- c) Pressing the MODE key sets the display to the start of the menu.
- d) The menu guides the operator through the following parameters:

Parameter	Meaning	value	
on2 (E93)	n2	n2/10	in rev/min (0 ... 999)
oi2 (E94)	i2	i2	in A (0 ... 999)
on1 (E95)	n1	n1/10	in rev/min (0 ... 999)
oi1 (E96)	i1	i1	in A (0 ... 999)
on3 (E97)	n3	n3/10	in rev/min (0 ... 999)
oAH (E98)	Motor type	≤ 1Gx5100 - 1Gx5166	(0) Siemens-Motor 1Gx5 AH 100 - 160
		≥ 1Gx5182 - 1Gx5406	(1) Siemens-Motor 1Gx5 AH 180 - 400

After inputting a parameter value and going into the P mode, pressing of the HIGHER or LOWER key calls up the next or previous parameter.

Important: With motor rated currents > 1000A the values for i1 and i2 must be input in 10A units. Always use the same unit when inputting i1 and i2, even if one value or both are smaller than 1000A. (Only the ratio of I_1 and I_2 is entered in the calculation).

- e) When the last parameter value has been input, pressing the HIGHER key in the P mode causes "OP_" to appear on the display.
- f) Pressing the HIGHER key thereupon starts the calculation run.
- g) After the calculation run the display goes to P51.
- h) The following fault indications are possible:
F39: Optimization not possible with EEPROM blocked (see under P87).
F40: Erroneous inputs: $n_2 < n_1$ or $i_1 < i_2$ or

$$\frac{i_{20}}{i_{10}} \geq \frac{n_3 + n_1}{n_3 + n_2} \quad (\text{i.e. the points entered do not lie on a hyperbolic curve}).$$

- i) P51 is invariably set to zero.
- j) The menu-driven parameter settings involve parameters E93 to E98. These parameters can only be accessed via the menu. The settings are not stored in the EEPROM and are lost when the power supply is switched off.

Calculation schema:

Motors with safe-commutation limit

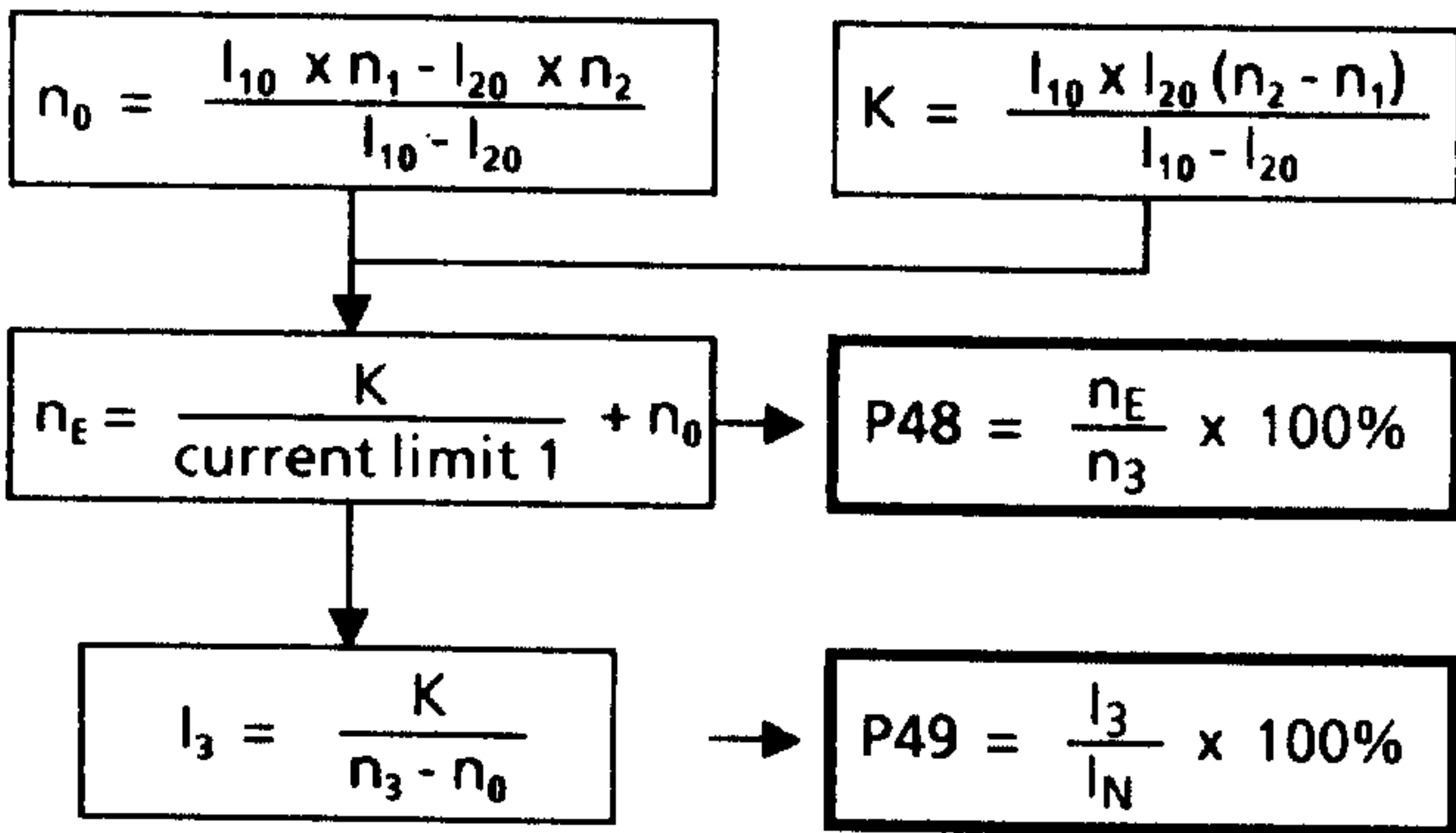

Motors without safe-commutation limit

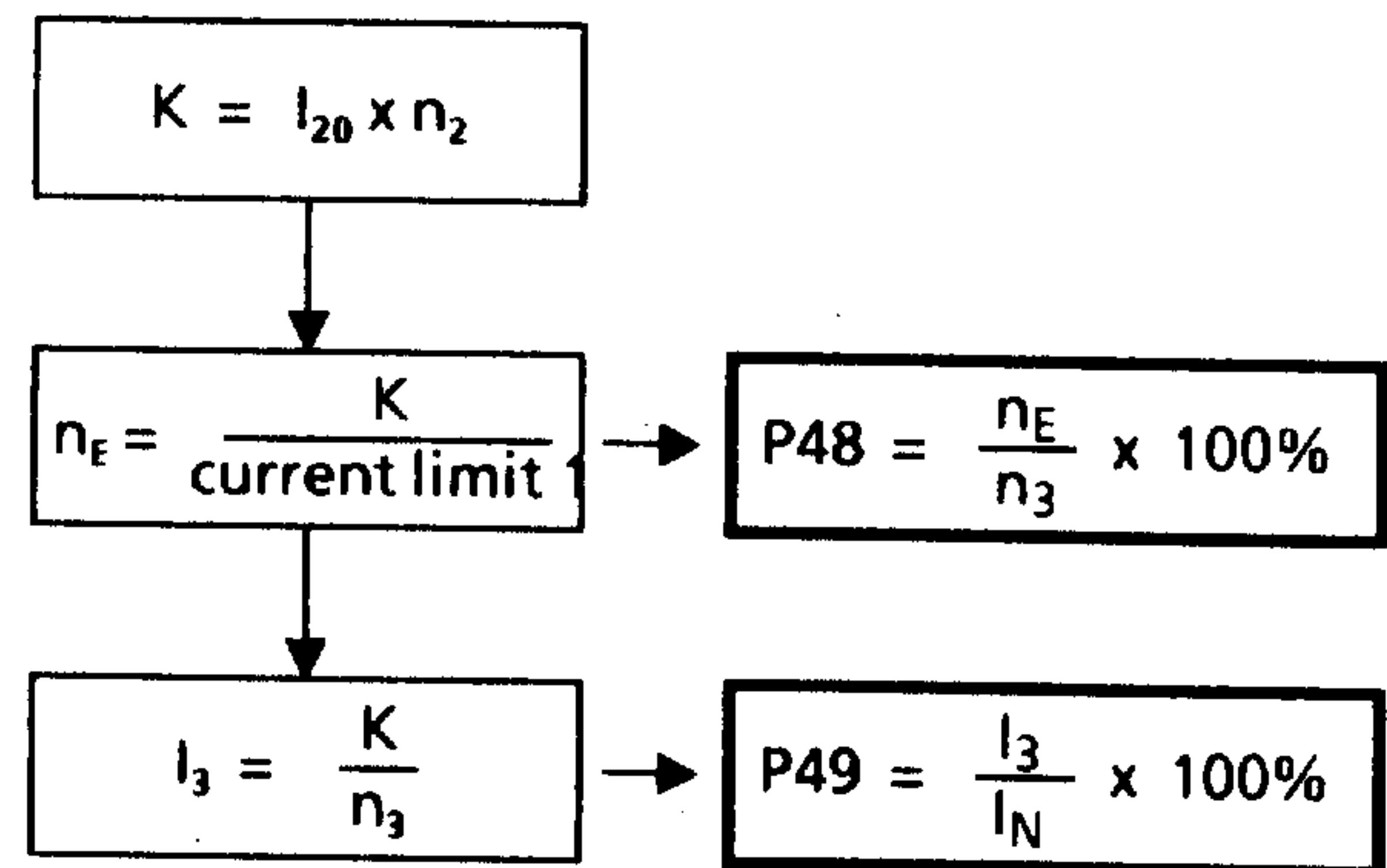

Important: "Current limit 1" is the limit value set in P39 and P40 (the highest of the two values must be used). This value must be entered in the same unit as I_{10} and I_{20} (normally in amperes). If the current limit value set in P39 and P40 is higher than the maximum converter current, then the maximum converter current must be entered for "Current limit 1".

10.4 Thermal overload protection of the main spindle motor (I²t monitor)

The I²t monitor is set with P70 and P71. When these are matched correctly, the main spindle motor is protected against excessive loads (no thermistor type motor protection).

Matching

- P70: Parameter P70 is used to enter a time constant T_{motor} in minutes with which the I²t monitor is required to operate
- P71: Parameter P71 is used to enter the ratio of the motor rated current to the converter limit current in % as shown on the rating plates (It may be necessary to observe Para. 10.2.2 above!)

Warning characteristic / Tripping characteristic

If the motor is constantly loaded by approximately 120% of the motor rated current, an alarm signal will appear (in V57 units only) after a delay of $1.19 \times T$ (T = thermal time constant of motor). If the load is not reduced, the drive torque is cut off when the tripping characteristic ($1.65 \times T$) is reached, and fault code F13 is displayed in flashing mode. The times to alarm/tripping for other load values are shown in the diagram.

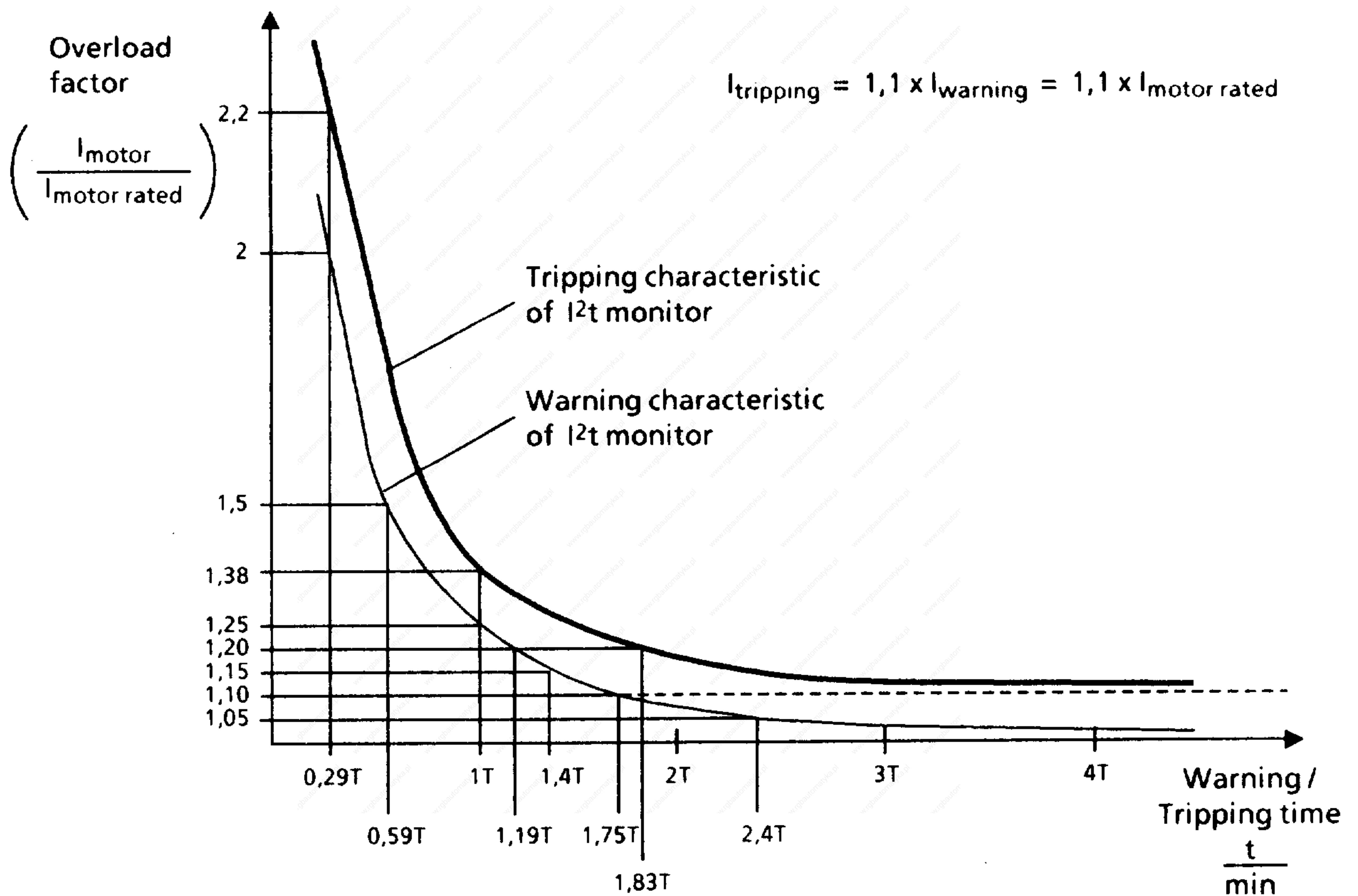

T = thermal time constant of the motor

- Notes:
- If the electronics power supply fails, the calculated prior load data of the main spindle motor will be lost. When the power supply is restored, the motor is assumed to have had no prior load!
 - The I²t monitor provides only a rough thermal replica of the main spindle motor (no thermistor type motor protection).
 - If the value 0 is set for P70 (T_{motor}), this causes the I²t monitor to be switched off.

10.5 Startup instructions

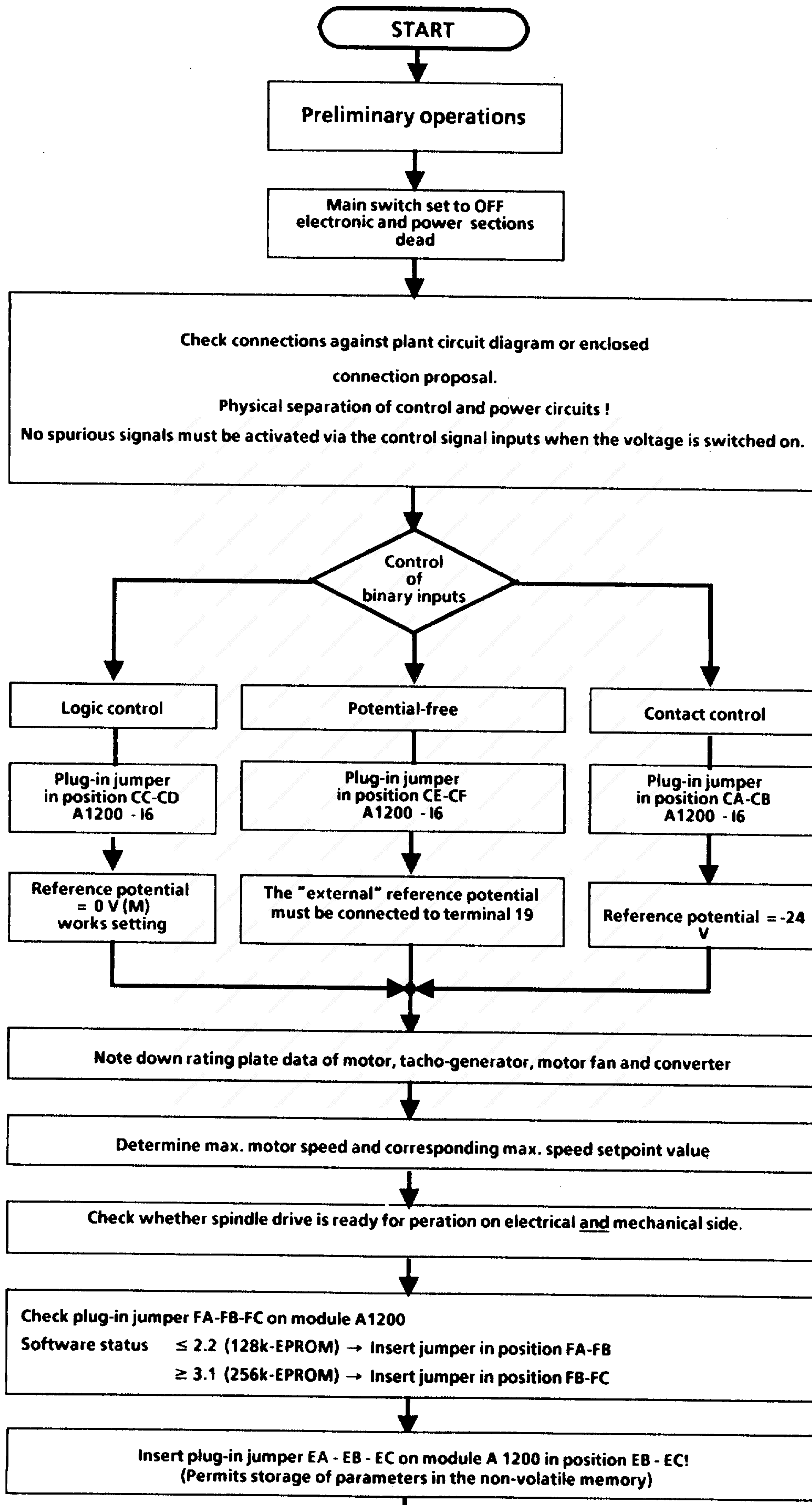

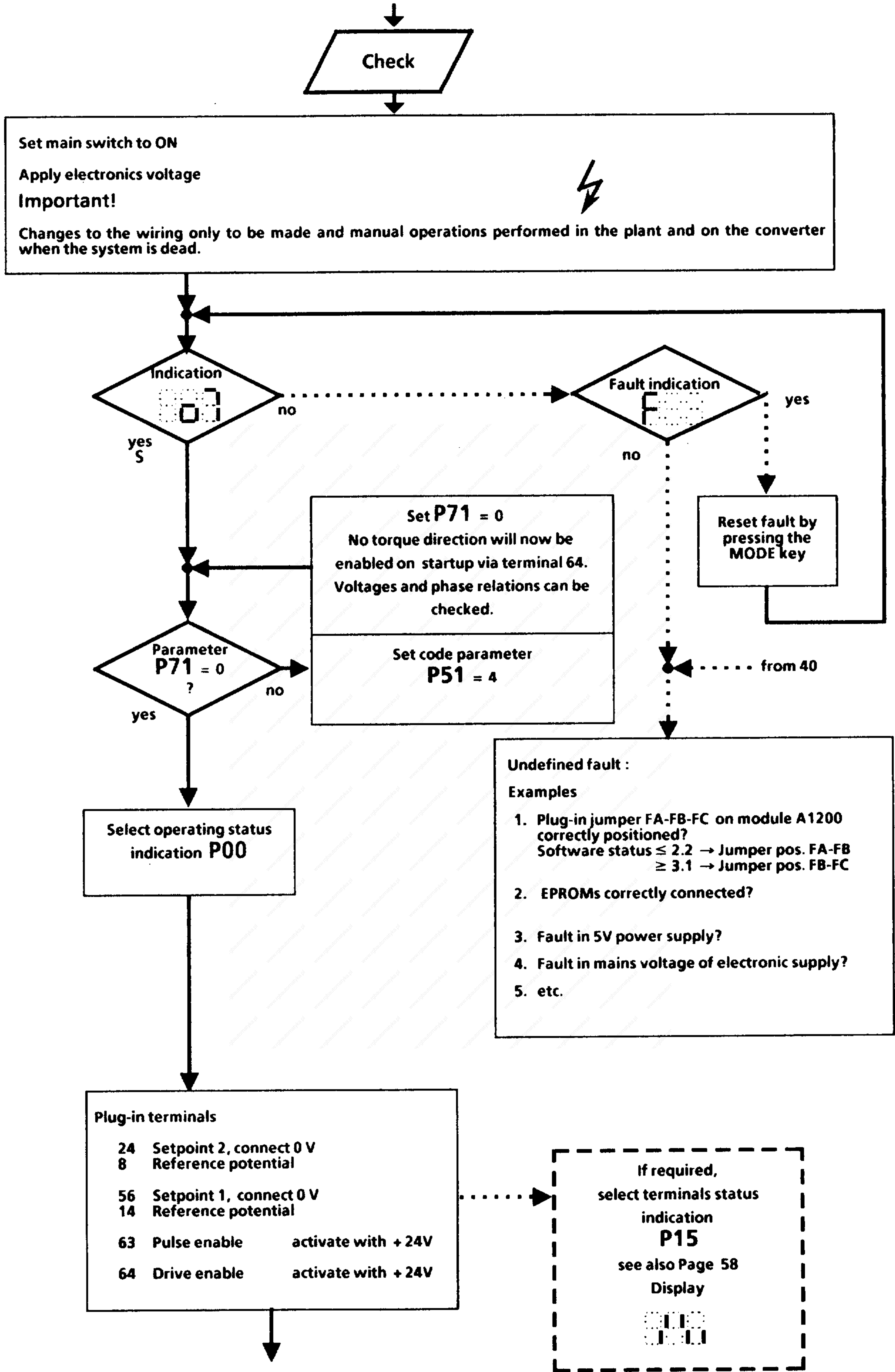

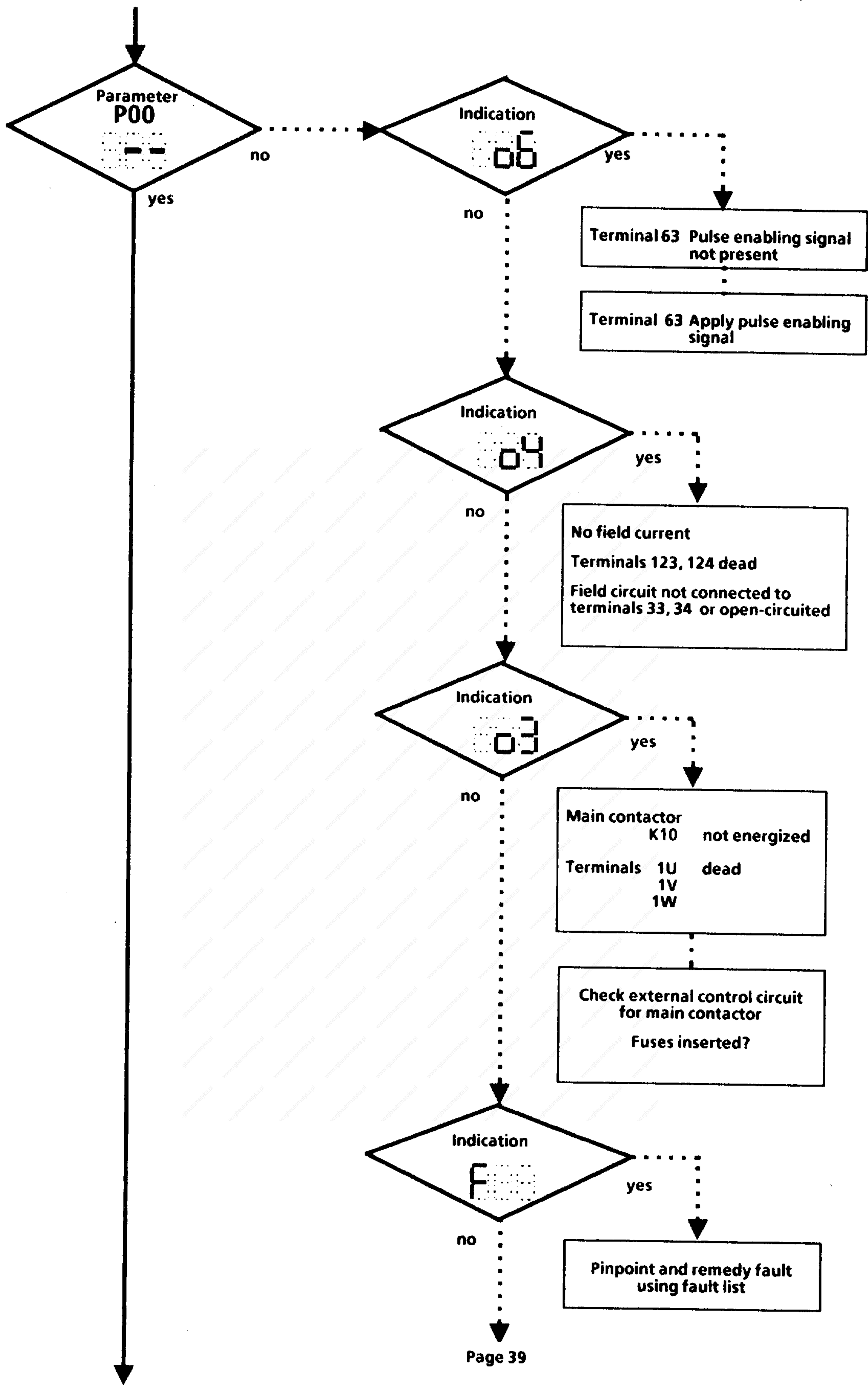

↓

1. Power supply					
Voltage between	Terminals	26	and	30	: 400 V AC
2. Load voltage	Terminals	1U	and	1V	: 400V AC
Voltage between	Terminals	1U	and	1W	: 400V AC
	Terminals	1V	and	1W	: 400V AC
					} or 500VAC with 500V units
3. Field supply					
Voltage between	Terminals	123	and	124	: 400V AC
4. Converter fan (if provided)					
Voltage between	Terminals	37	and	38	: 400V AC

↓

Check correct terminal-phase connections between power supply, field supply and load voltage.

Terminal-phase connections are correct if:

voltage between terminals 1U and 26 and 123 : 0V AC

voltage between terminals 1W and 30 and 124 : 0V AC

If a 500 V supply is used and the terminal phase connections are correct, approximately 100 V should be measured (only if a transformer for 400V/500V is used!).

Clockwise rotating field at power terminals
check terminals 1U, 1V, 1W
with phase rotation indicator.

When drive enabled with terminal 64, unit checks for clockwise rotating field automatically

⚡

Important:
Wiring changes may only be made and manual operations performed in the plant and on the converter when the system is dead.

↓

Check operation of and switch on separately driven motor fan.

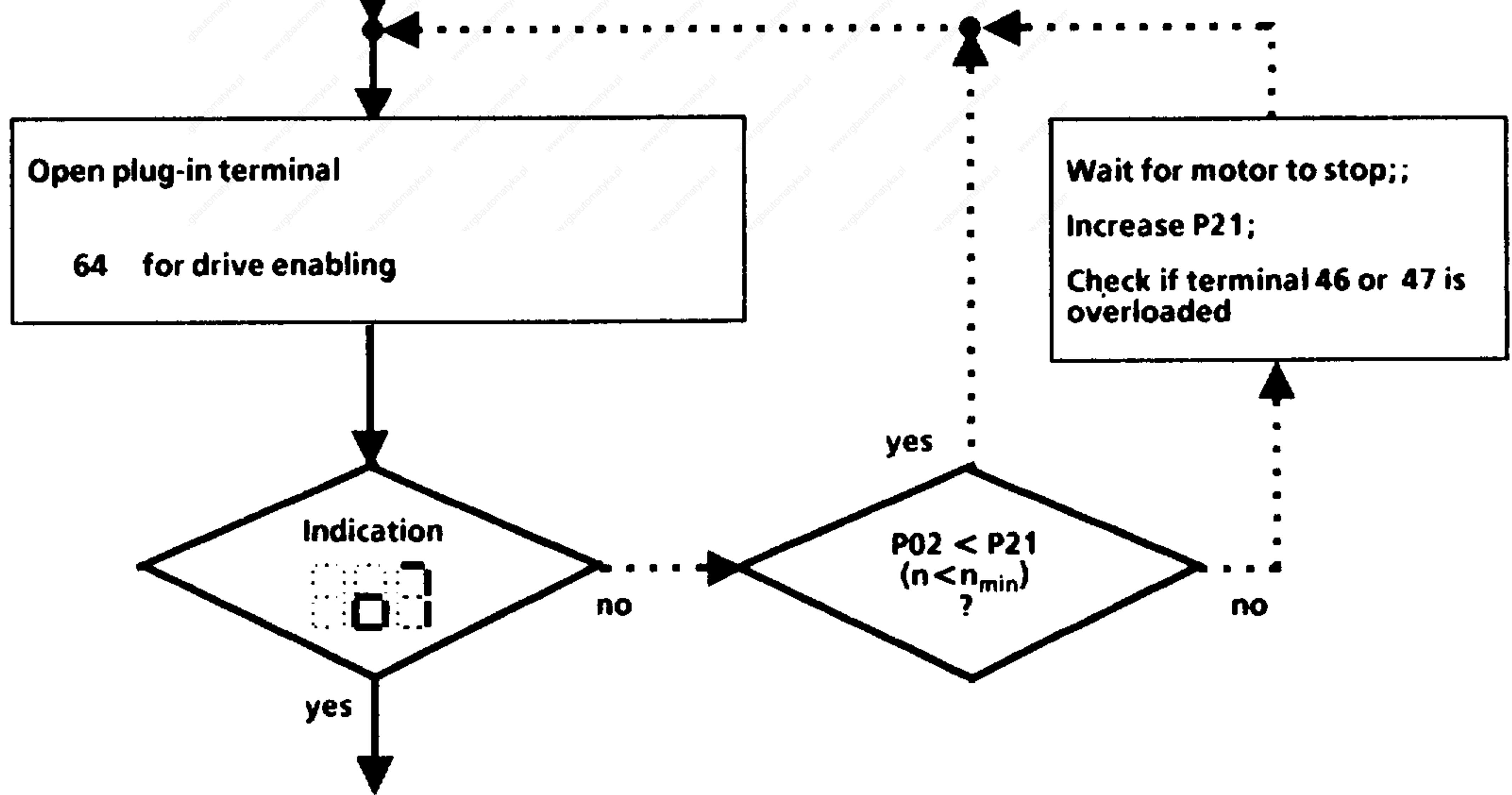

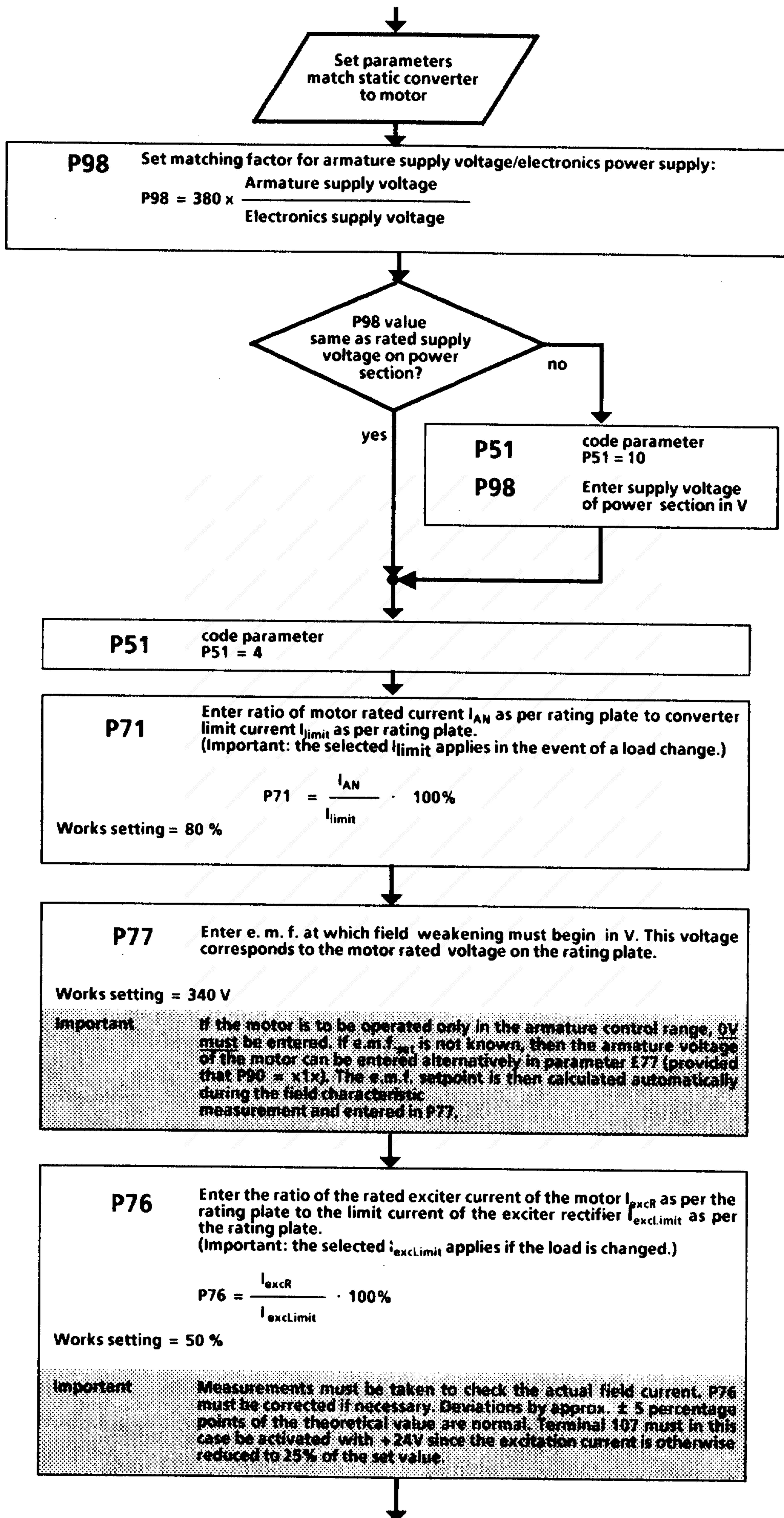



Current limits set separately for each torque direction

Current limit 1 (Gear speed I)

P39

Enter the positive maximum value of the armature current as a percentage of the motor rated current for torque direction I. If, for example, the maximum motor current is $1,5 \times I_R$, enter 150.

P40

Enter the negative maximum value of the armature current as a percentage of the rated motor current for torque direction II.

Works setting = 120%

Current limit 2 :

This current limitation applies to all gear speeds and becomes operative only if terminal 111 is activated and the actual speed value is greater than the changeover speed (P50).

P41

Enter the positive maximum value of the armature current as a percentage of the rated motor current for torque direction I.

P42

Enter the negative maximum value of the armature current as a percentage of the rated motor current for torque direction II.

Works setting = 100%



The current limit correction on gear speed changes can be set jointly for the two torque directions (absolute value) :

P44

Set the current limit for gear speed II as a percentage of the rated motor current

Works setting = 100%

P45

Set the current limit for gear speed III as a percentage of the rated motor current

Works setting = 100%

P46

Set the current limit for gear speed IV as a percentage of the rated motor current

Works setting = 100%



Speed-related current limiting :

P48

Enter the speed threshold n_{Thresh} , above which the maximum motor current stored with parameters P39 and P40 must be reduced, as a percentage of the maximum speed.

Works setting = 100%

P49

Enter the current limiting value permissible at the maximum motor speed n_{max} as a percentage of the rated motor current.

Works setting = 100%

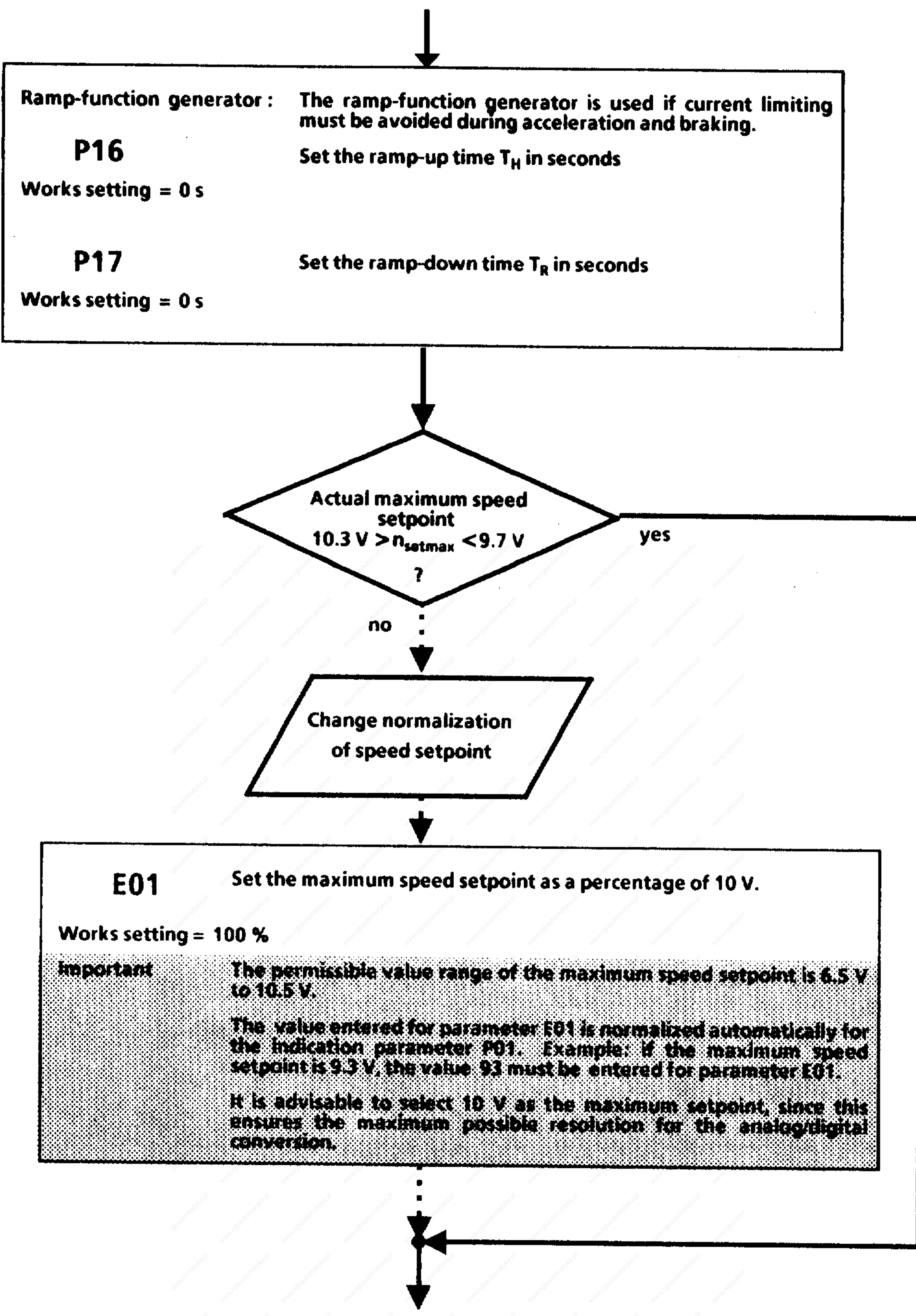

Note: The method of calculating P48 and P49 is explained in Chapter 10.3

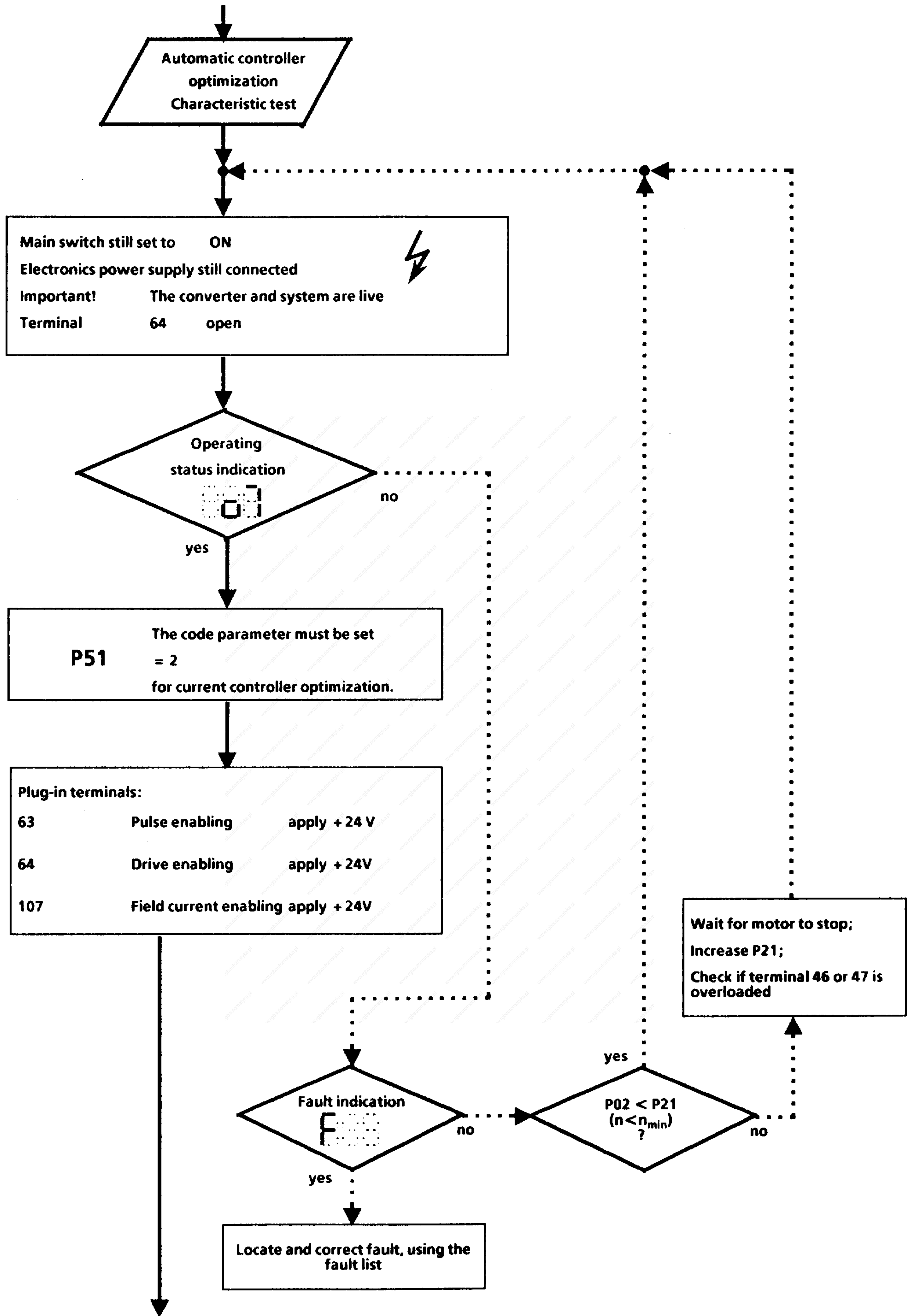

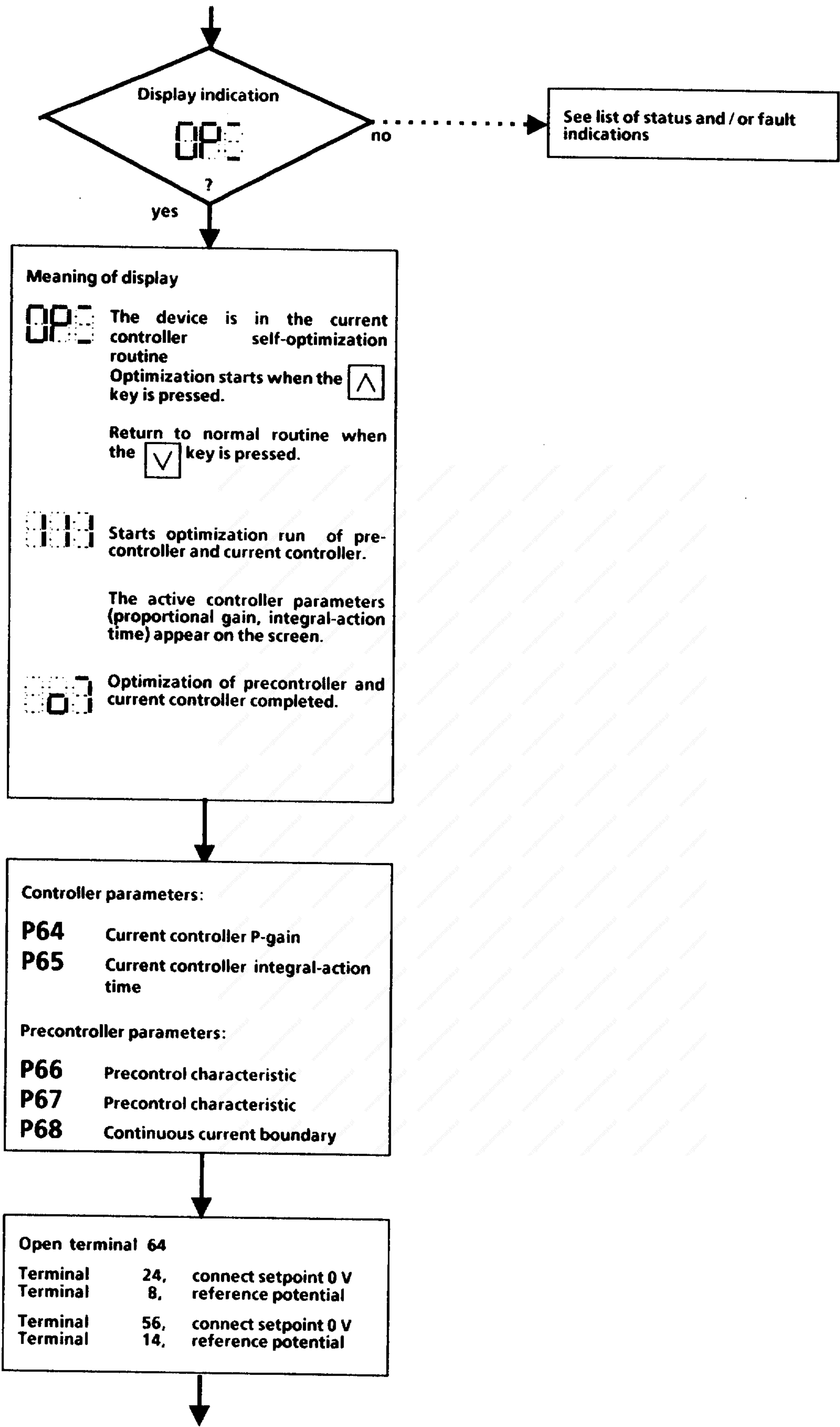



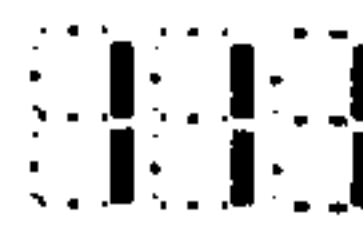

Meaning of display

OP? The device is in the current controller self-optimization routine
 Optimization starts when the  key is pressed.
 Return to normal routine when the  key is pressed.

 Starts optimization run of pre-controller and current controller.
 The active controller parameters (proportional gain, integral-action time) appear on the screen.

 Optimization of precontroller and current controller completed.

Controller parameters:

P64 Current controller P-gain
P65 Current controller integral-action time

Precontroller parameters:

P66 Precontrol characteristic
P67 Precontrol characteristic
P68 Continuous current boundary

Open terminal 64

Terminal	24,	connect setpoint 0 V
Terminal	8,	reference potential
Terminal	56,	connect setpoint 0 V
Terminal	14,	reference potential

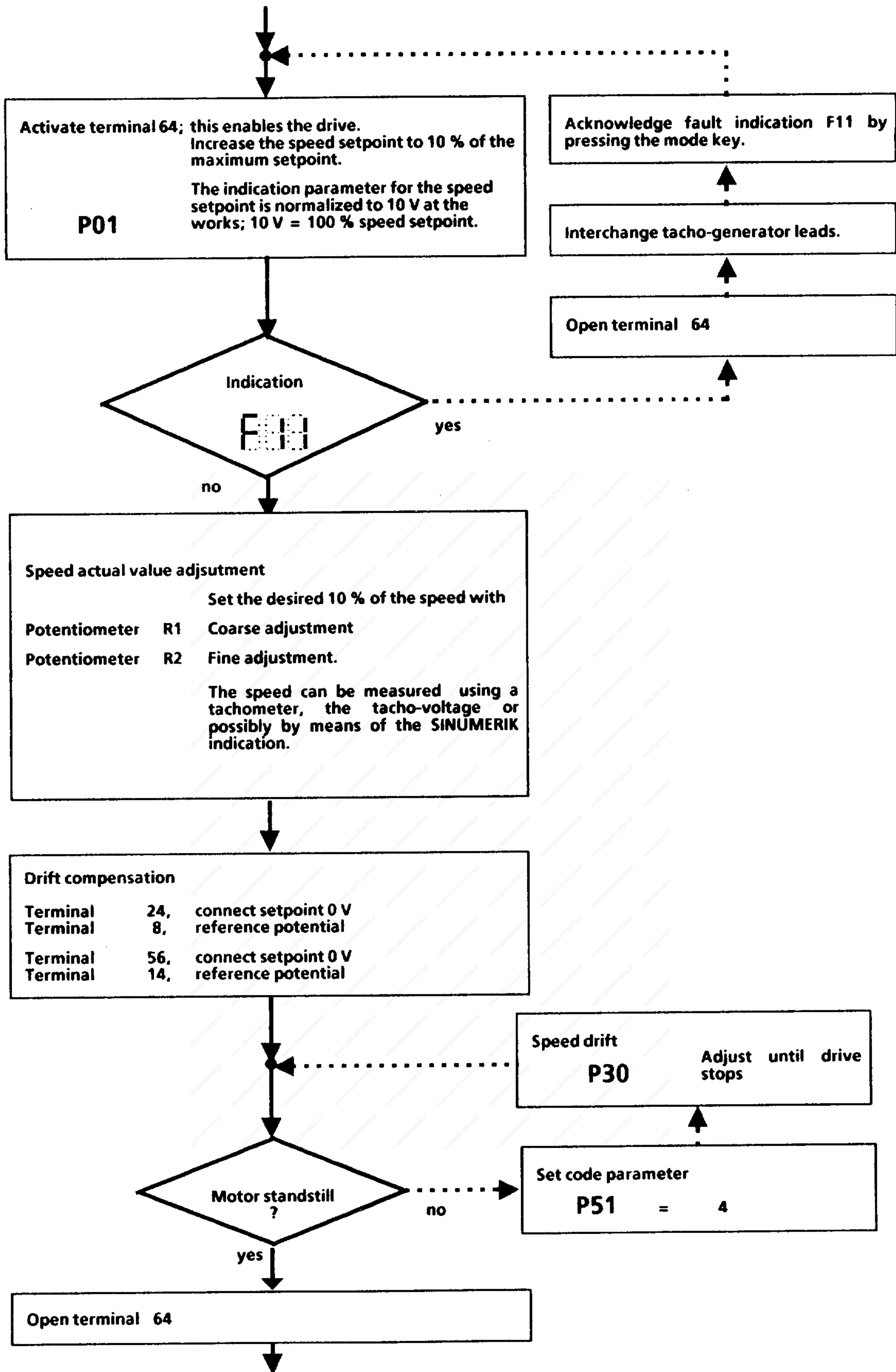

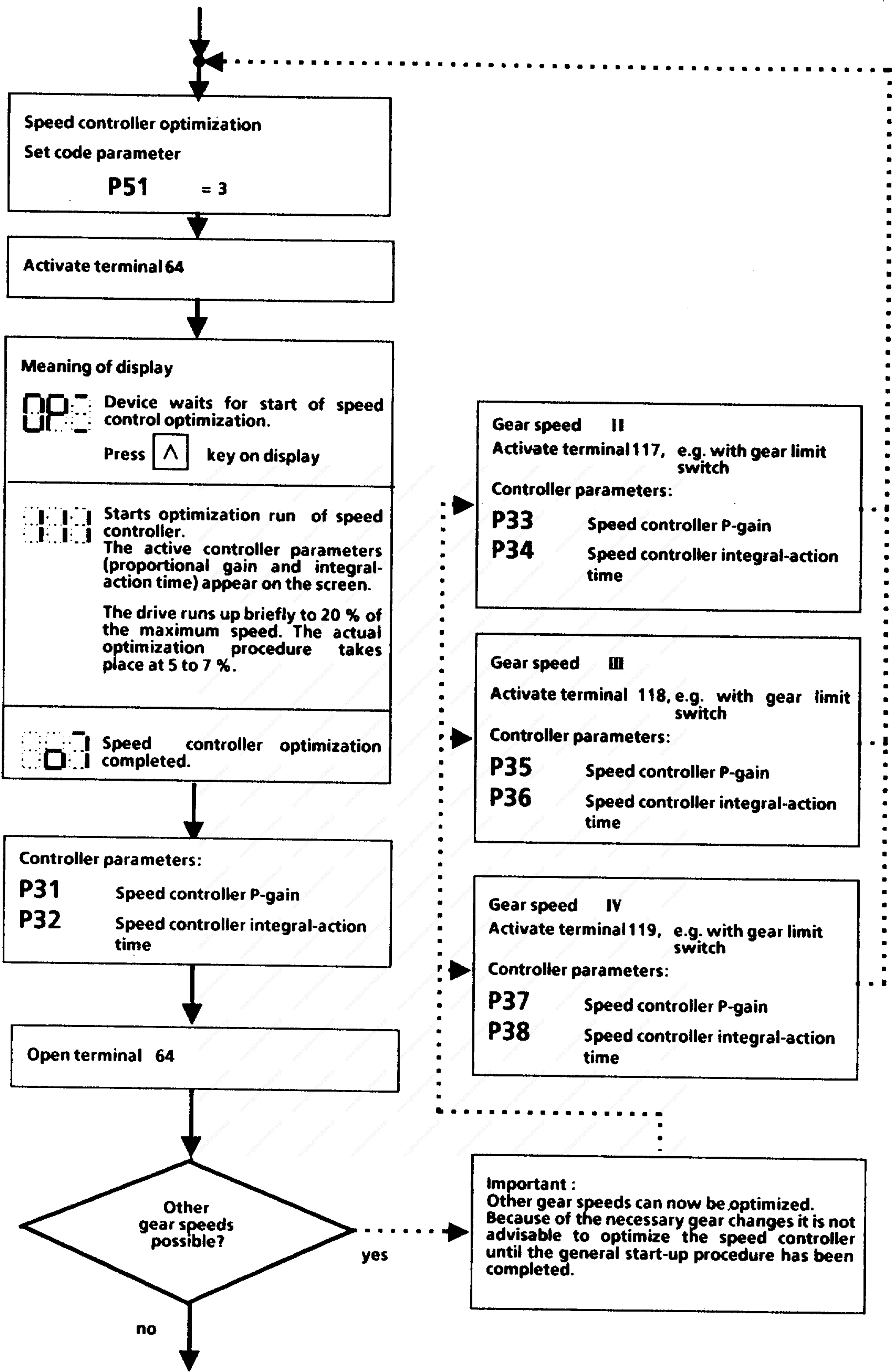

↓

Field characteristic measurement

Set code parameter



P51 = 5

↓

Activate terminal 64

↓

Meaning of display

 Device waits for start of field characteristic test.
Press  key on display

 Starts field characteristic test. Max. duration 2 min. One point of the characteristic is determined with the rated field at roughly 94 % of of the rated e. m. f. The remainder of the characteristic is determined at roughly 50 % of the rated e. m. f. Depending on the field weakening range, speeds higher than the rated speed may be encountered. The speed actual value will appear for a duration of 1 s for each measuring point in addition to the e. m. f.

 **Characteristic measurement completed**

↓

Open terminal 64

↓

E. m. f. controller optimization

Code parameter

P51 = 4

P78 = Proportional gain

Works setting : 0,5

p79 = Integral-action time

Works setting : 1 sec.

The standard works setting is generally adequate.

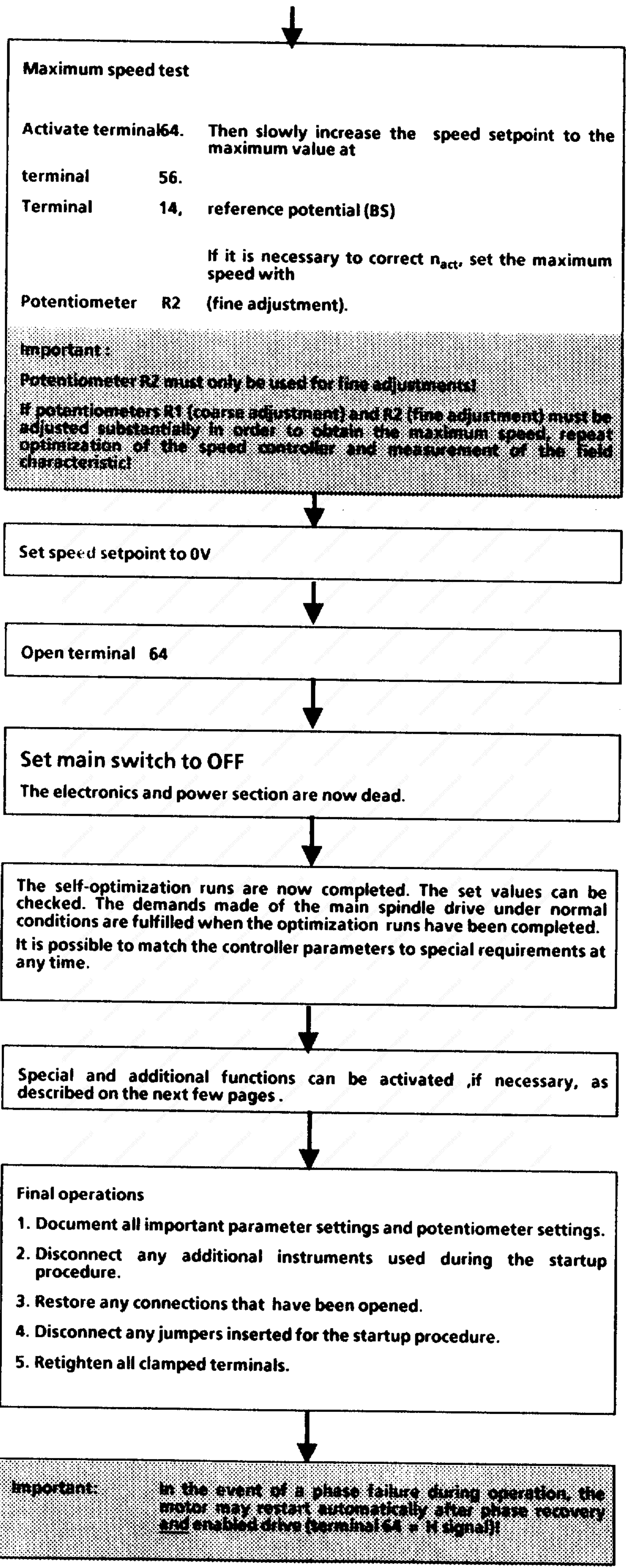

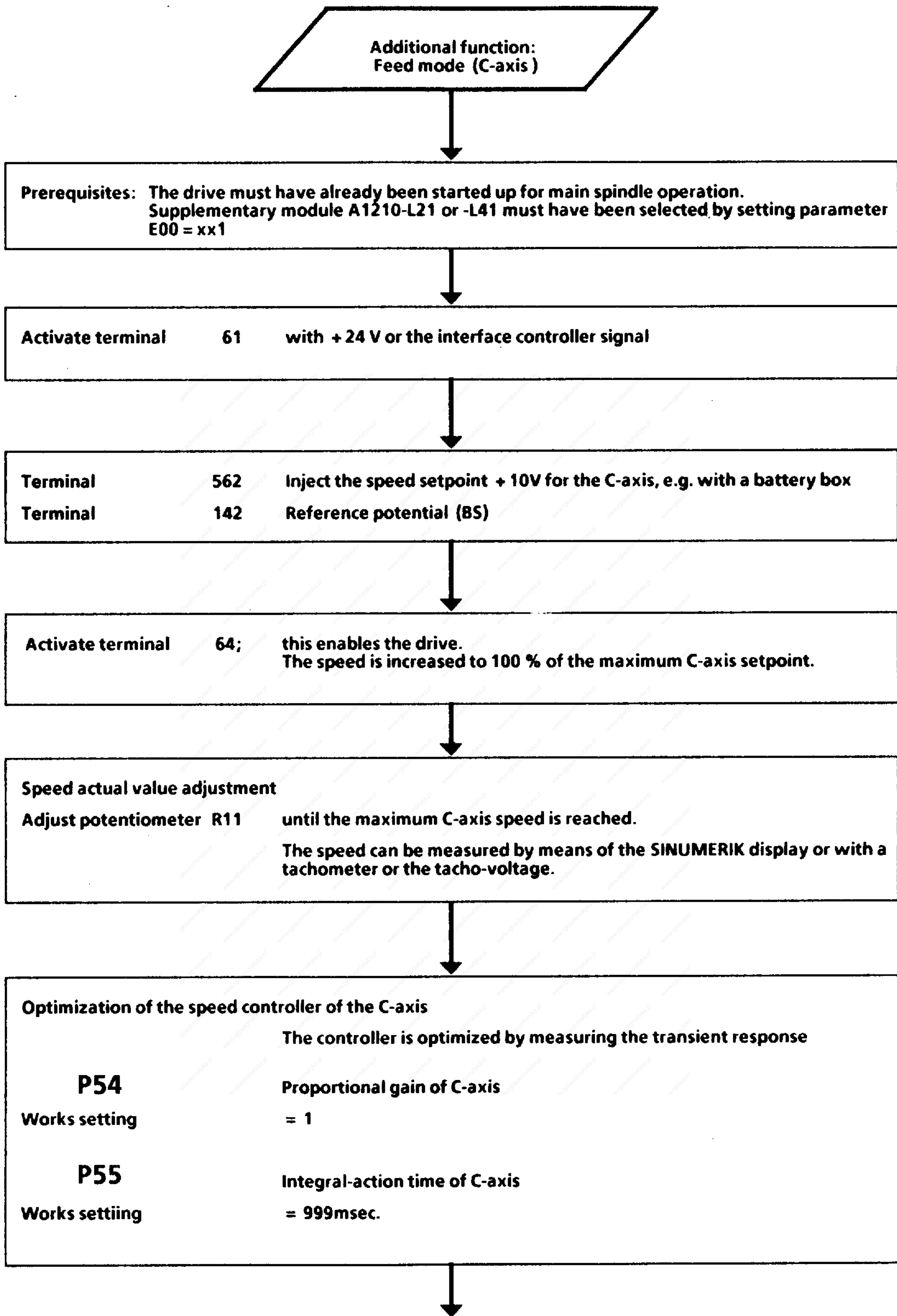

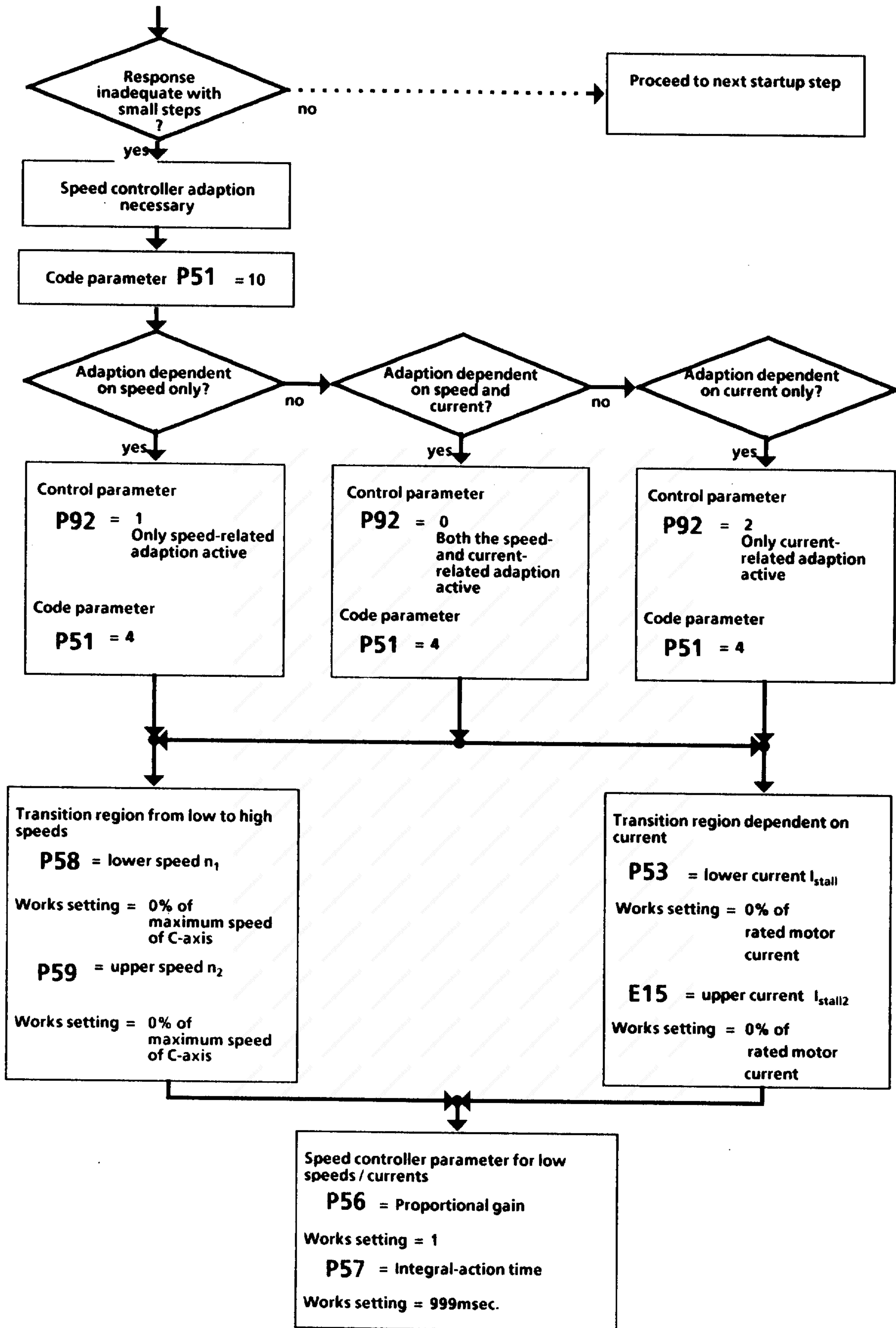

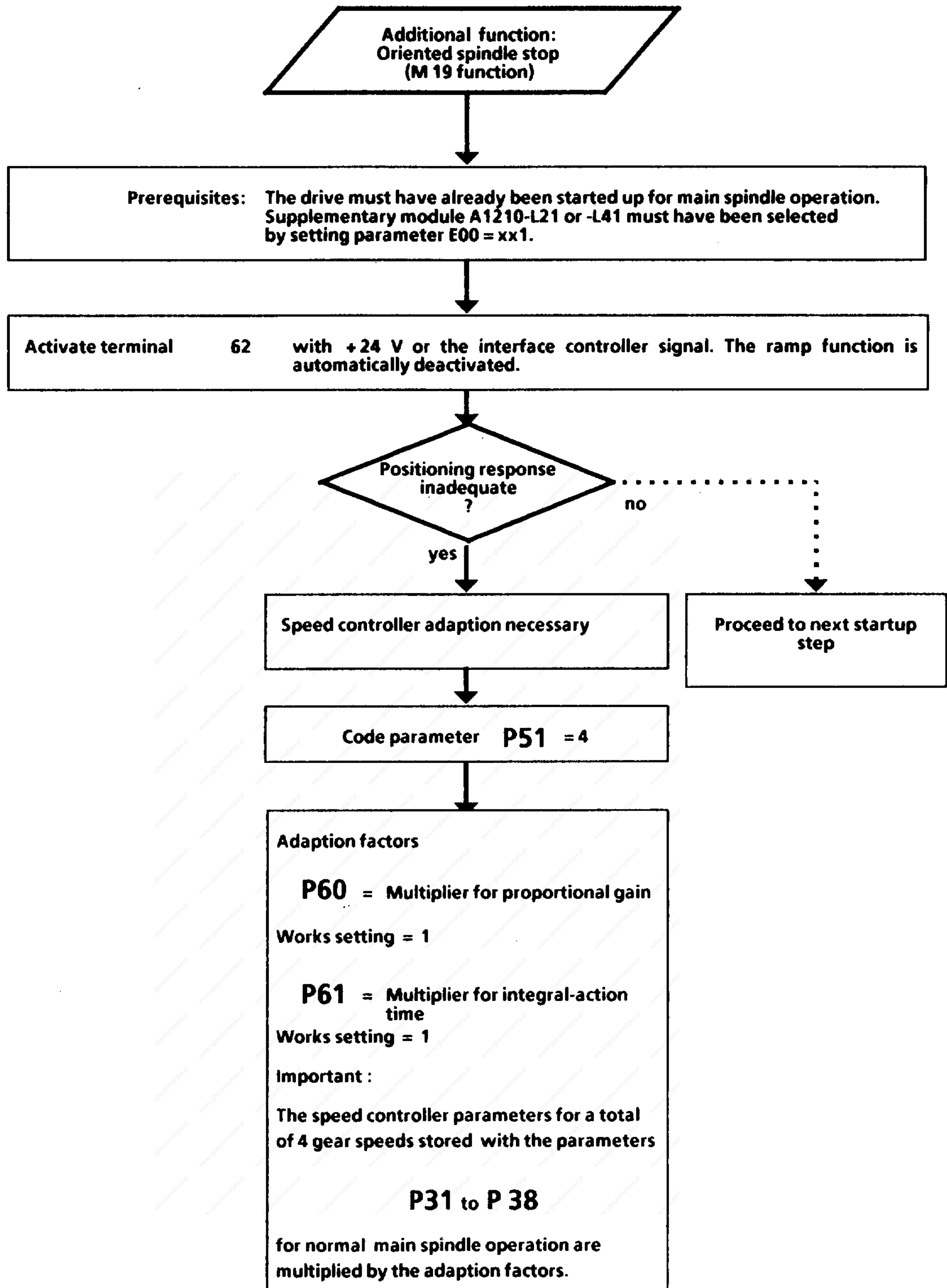

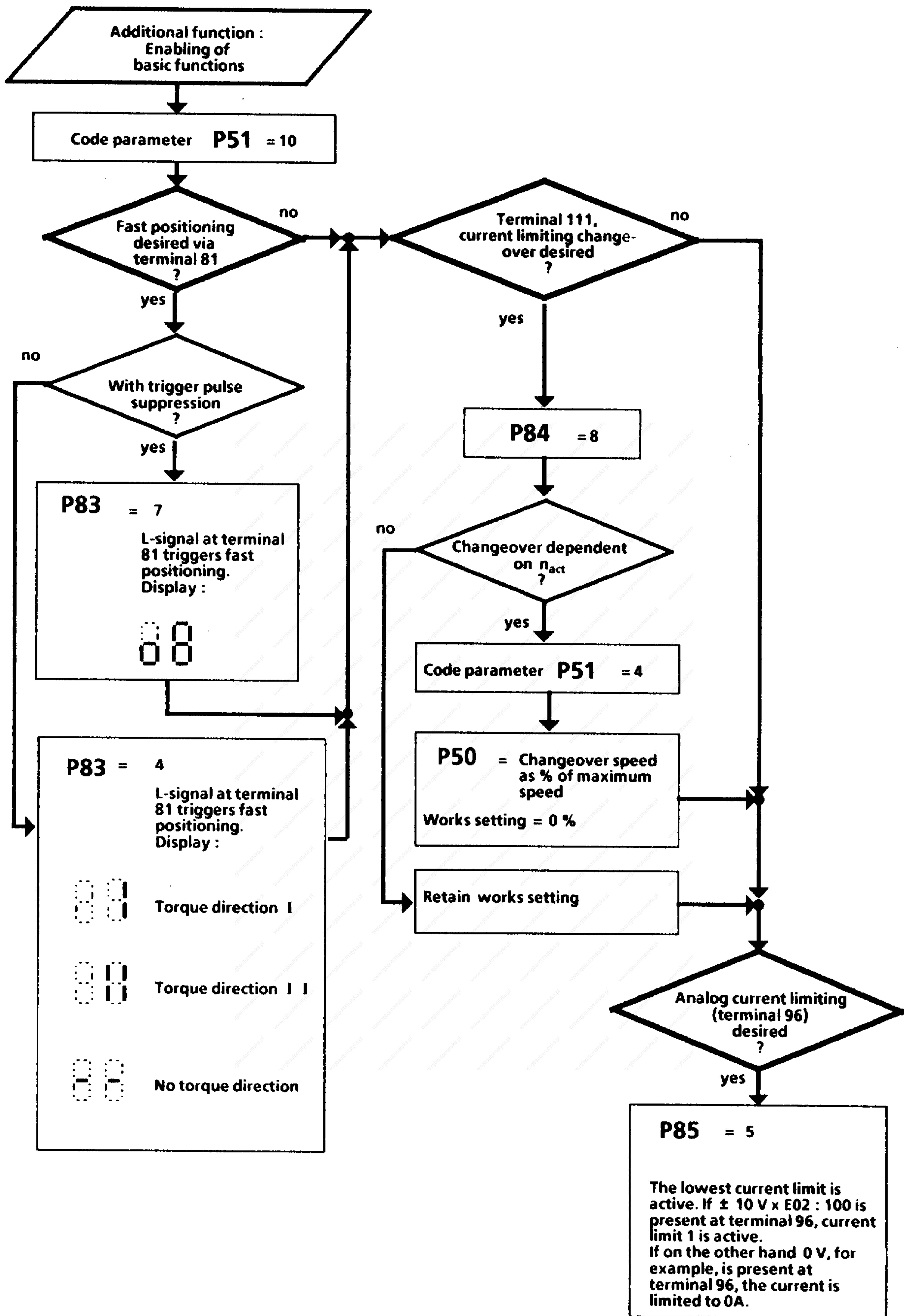

Additional function :
Relay outputs
in basic unit

Code parameter **P51** = 10 Only set for changes

Relay switchover from "Ready" to "Fault"

P80 ⁷²
 ⁷³
 ⁷⁴

P80 = 1 Relay K2 picks up when "Ready" indication appears

 = 0 Relay K2 picks up when "Fault" indication appears

Works setting P80 = 1

Code parameter **P51** = 4 Only set for changes

$n < n_{min} 1$

Terminals 314
 315
 316

P21 = Response threshold as % of maximum speed

Works setting = 0,1 %

If the response threshold is undershot when terminal 64 is open (drive enabling), the controller will be disabled.

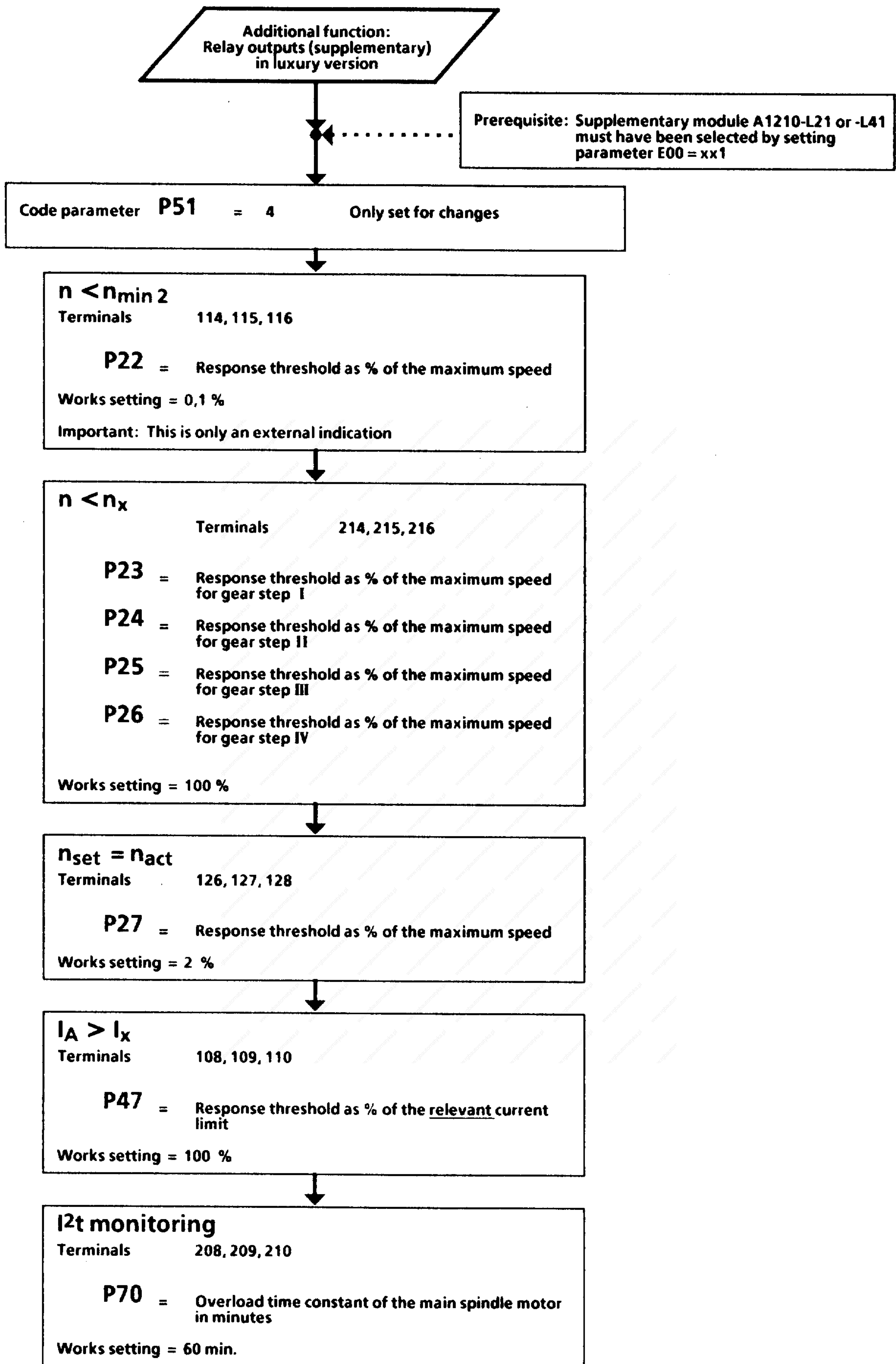

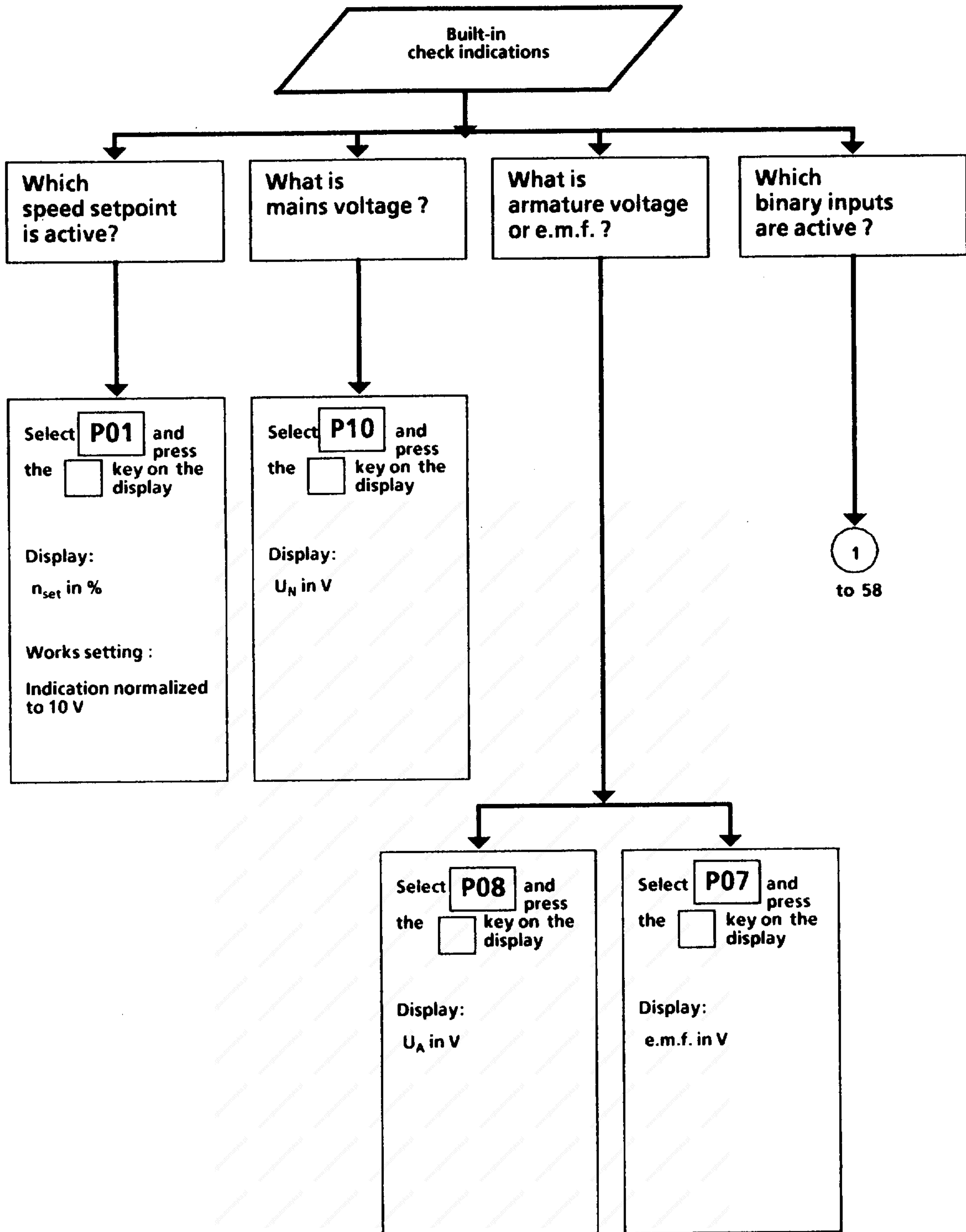

from 57



The 21 segments of the 3-position, 7-segment display permits 21 signal states of the converter terminal strip to be indicated. The signal states of the selected terminals are determined by the processor and indicated by the assigned segments lighting up. The assignment diagram is shown below.

Select **P15** and press the key

The indications then appear on the display unit as shown below:

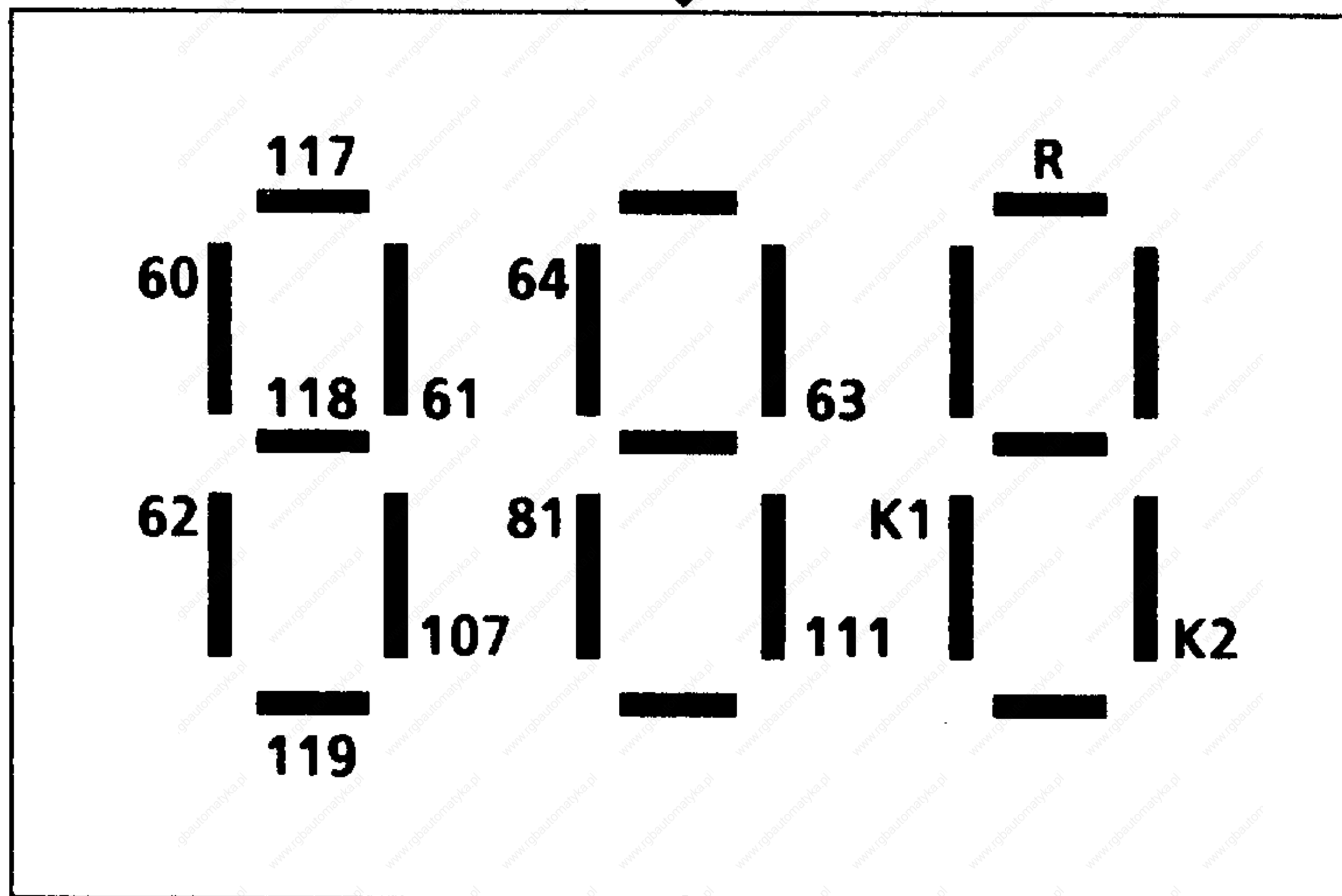

The numbers correspond to the terminals with the same numbers

	A1210	A1200	A1203/A1204
60 : Oscillating for gear changing	X		
61 : Feed mode (C-axis)	X		
62 : $T_H = 0$	X		
63 : Pulse enable		X	
64 : Drive enable		X	
81 : Fast positioning		X	
107 : Field current reduction	X		
111 : Current limit changeover		X	
117 : Gear speed II	X		
118 : Gear speed III	X		
119 : Gear speed IV	X		
K1 : Output relay for $n < n_{min1}$			X
K2 : Output relay for Ready/Fault			X
R : Fault memory reset	X		

If the segment lights up, either the terminal has an H signal or the corresponding relay is energized.

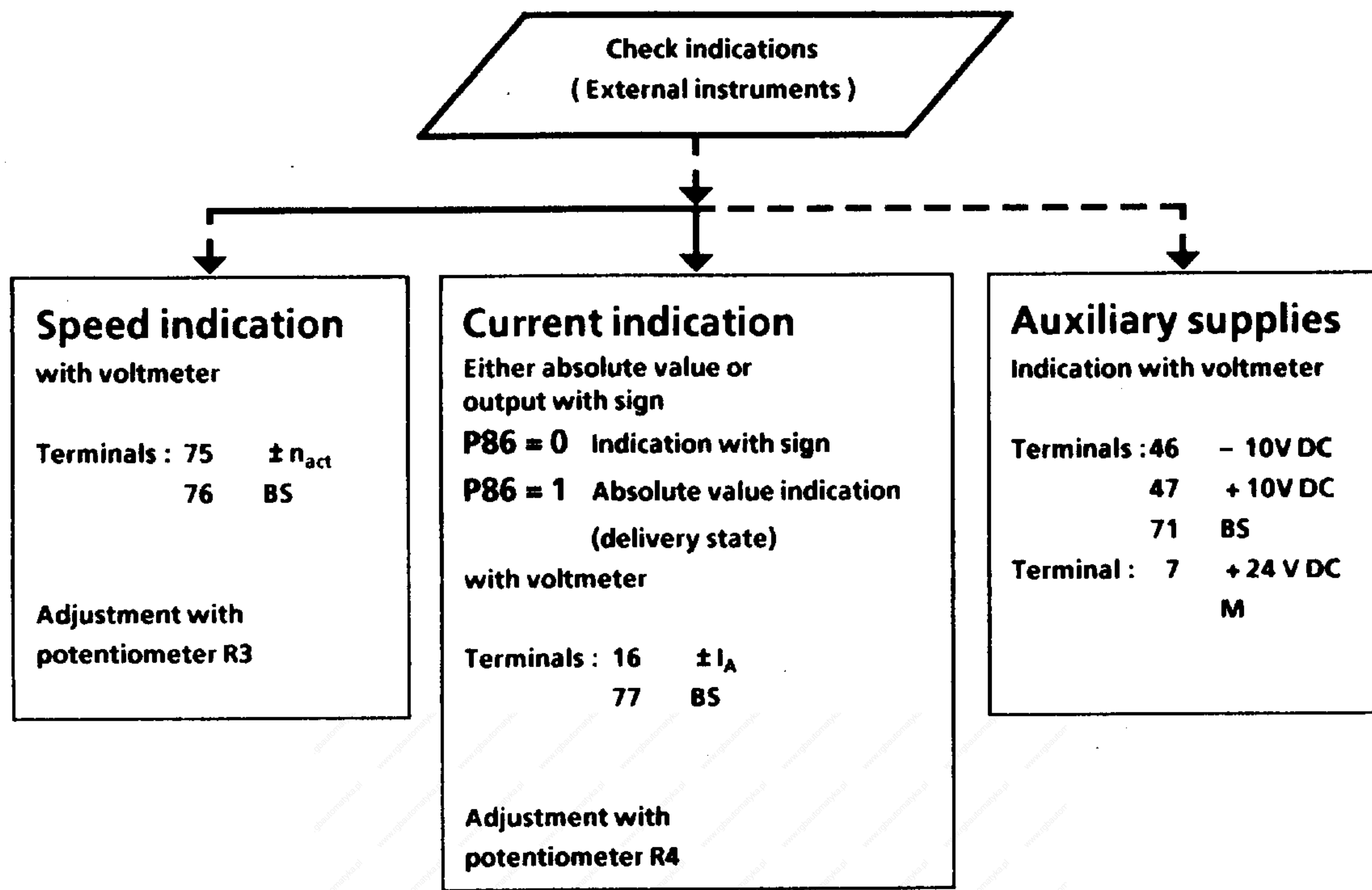

**Time characteristic
of internal signals**

A digital / analog converter (DAC) has an additional output for measuring the signals below.
Important:
Periodic scanning with low priority precludes real-time measurement.

Terminals: 100 Connection All measurements must be performed with high-impedance
 101 BS instruments (R ≥ 10kΩ/V).

Set code parameter
P51 = 10

- The signals are selected with the parameters below:
- P82 = 0** : DAC switched off
 - = 1** : P - component of speed controller
 - = 2** : Speed controller output
 - = 3** : Absolute value of current setpoint after current limiting
 - = 4** : Ramp-function generator output
 - = 5** : Spindle speed }
 - = 6** : Power
 - = 7** : Current controller integrator
 - = 8** : E.m.f.
 - = 9** : Diagnostic function

The gear ratio must be specified for spindle speed measurements

- P72** = Gear speed I
- P73** = Gear speed II
- P74** = Gear speed III
- P75** = Gear speed IV

Works setting for all speeds = 1

$$\text{Gear ratio} = \frac{\text{Motor speed}}{\text{Spindle speed}}$$

11 Fault indications

A fault indication is called automatically whenever a fault occurs. Faults are indicated by means of an F in the first position followed by a 2-digit number. The indication flashes (approximately 0.8 s bright, 0.2 s dark).

Mains faults

- F02** Incorrect rotating field or synchronization voltage does not correspond to phase voltage (incorrect terminal-phase connection of terminals 1U/1W and 26/30)
- F03** Mains frequency not in 45 Hz to 65 Hz range or frequency change > 1.5Hz/sec
- F04** Phase failure, mains fuse or electronics power supply was switched off in the presence of DRIVE ENABLE signal (at terminal 64)
- F05** Mains voltage outside tolerance range ($\pm 20\%$)

Interface fault

- F06** Parity error during data reception via serial interface (e.g. incorrect setting of P97; incorrect setting of PG635 / PG675 / PG685 data format)
- F07** Syntax error during data reception via serial interface (For details, see the "Serial interface" instruction manual)
- F08** Faulty position setpoint input via connector X305 (applies only to spindle positioning option)

Machine-related faults

- F10** Overspeed indication (Responds if the speed set via parameter E21 is exceeded)
- F11** Tacho-monitor (e.g. open circuit, incorrect tacho-polarity)
- F12** $I > 300\%$ (Current actual value > 300% of rated converter current)
- F13** I2t monitor tripped (Motor overtemperature)
Remedy: Reduce load on motor
- F14** Exciter current monitor ($I_{Exc_{act}} \leq 50\%$ of $I_{Exc_{set}}$)
- F15** Drive blocked ($I_A > I_x$ at standstill)

F17

Gear speed selection ambiguous
(e.g. more than one gear speed selected at a time)

F18

Drive does not reach speed despite maximum field weakening
(e.g. because threshold e.m.f. (P77) set too low)

F19

Armature circuit interrupted
(e.g. blown fuse, broken line, EMF_{set} (P77) set too high, line undervoltage, α_G too high ($> 30^\circ$), etc.)

Control section faults

F21

Firing pulses suppressed
(trigger module terminal 700 not connected to terminal 763)

Internal fault indications

F22

- 1) Coupling fault between SINEC-L1 interface module Z1001 and basic unit
(The Z1001 module is not intended for SIMODRIVE and must not therefore be selected in parameter E00)
Remedy: Check Parameter E00

F23

- 1) Coupling fault between supplementary modules Z1004 (technology module) or Z1011 (interface module) and basic unit
(These supplementary modules are not intended for SIMODRIVE and must not therefore be selected in parameter E00)
Remedy: Check Parameter E00

F24

- 1) Supplementary power supply (C98130-A1070-A1) faulty
(applies only to spindle positioning option)

F26

- 1) Current cannot be reduced
(e.m.f. too high)

F28

FIFO overflow

F34

- 1) EEPROM fault
(cyclic RAM / EEPROM comparison)
Check: Jumper 5 on module A1200-L13 must be inserted:
(Up to software version 03, C1, ...)
Plug-in jumper EA - EB - EC on module A1200-L13 must be inserted in position EB - EC (from software version 04, D1, ... onwards). See also P87.

1) This fault indication can also appear when there is no DRIVE ENABLE signal
(i.e. when terminal 64 is open and the firing pulses have already been blocked).

Faults during startup

F30

Fault during field characteristic
(e.g. load surge during measurement of field characteristic,
field current reaches limit)

F32

Optimization run:
Remanence too high (drive rotates when $I_{FIELD_SET} = 0$)
Remedy: stall shaft

F35

Field-weakening blocked
(the block is activated if e.m.f._{SET} is not 0 and no characteristic has been
measured; the fault indication is suppressed in the CMD FIELD P90 = 2 mode)
Remedy: carry out field characteristic measurement

F36

Optimization run:
Current limit too low; the current limit is reached during automatic
optimization
(if permitted: increase current limit)

F37

Optimization run:
Optimization run aborted for external reasons
(e.g. active signals at DRIVE ENABLE or PULSE ENABLE or QUICK STOP
terminals interrupted)
Remedy: repeat optimization run

F38

Hardware not compatible with the option set with E00
or
the options set in E00 are mutually exclusive.

F39

Optimization run not possible when EEPROM disable is operative.
Remedy: set P87 to x3x or x0x.

F40

Erroneous input for automatic calculation of the parameters for speed-related
current limitation.
Remedy: Ensure that $n2 \geq n1$ and $i1 \geq i2$ and repeat calculation run.

F41

to
F46

Fault messages from thyristor diagnosis (only for service purposes)
Works setting: Parameter E39 = 0

Acknowledging fault indications

Restart with acknowledgement

If a fault is indicated, it can be acknowledged when the DRIVE ENABLE terminal is open by pressing the MODE key on the unit. If the fault has been eliminated and acknowledged, the unit can be reconnected by activating the DRIVE ENABLE terminal.

If the electronics power supply is switched off while a fault indication is present without the fault having been acknowledged, the old fault indication will appear again when the power supply is switched back on.

External acknowledgement

With luxury units fitted with the A1210 module, every fault indication can be acknowledged by activating terminal R (reset fault memory) when the DRIVE ENABLE terminal is open.

Restart without acknowledgement

If 2 or 3 is set for parameter P87 (CMD REST), the converter can be restarted by activating the DRIVE ENABLE terminal in the case of the following faults (acknowledgement at converter NOT necessary):

F04	Phase failure, mains fuse
F05	Mains voltage outside tolerance range ($\pm 20\%$)
F12	I > 300% Current actual value > 300% of rated converter current
F13	I ² t monitor has operated
F14	Exciter current monitor
F21	Firing pulses suppressed (trigger module terminal 700 not connected to terminal 763)

The fault indication persists, but stops flashing. It must be acknowledged by pressing the MODE key on the device.

Automatic restart after the phase failure

If 1 or 3 is set for parameter P87 (CMD REST), the converter will be automatically restarted after a phase failure if the phase recovers within approx. 400 ms.

12 Maintenance



WARNING

Hazardous voltages are present in this electrical equipment during operation.

Dangerous voltage from the customer installation may be present at the signalling relay contacts.

Failure to properly maintain the equipment can result in death, severe personal injury or substantial property damage.



The instructions contained in this chapter and on product labels have to be followed.

- All personnel performing maintenance work on the equipment shall be duly qualified and familiar with all safety notices contained in this description manual and in the installation, operating and maintenance instructions.
- Before inspecting and maintaining the equipment, make sure that the AC supply has been switched off and interlocked and that the unit is properly grounded. Hazardous voltages exist in both the converter and the motor before disconnection. Dangerous voltage exists even when the contactor of the converter unit is open.
- Use only authorized spare parts in the repair of the equipment.

The static converters are fully electronic devices and maintenance-free.

The bearings of the fans have been lubricated for life.

It is, however, advisable to clean the converter occasionally, in order to prevent voltage flashover and impairment of the cooling system (e.g. blow out with dry compressed air, max. 1 bar).

13 Parameter list

	Abbreviation	Plain text	Range (Grading)	Unit	Factory setting	Set value
P00		Operating state indication (see Chapter 9)				
*** Measured value indications ***						
P01	N SOLL RG	Speed setpoint indication 100% at 10V x E01 : 100	-199 - + 999 of n_{max} (0,1)	%		
P02	N IST	Speed actual value indication 100% at 10V x E01 : 100	-199 - + 999 of n_{max} (0,1)	%		
P03	I SOLL B	Current setpoint indication (abs. value) 100% at conv. limit current	0 - 100 (0,1)	%		
P04	I MITTEL	Current actual value indication (abs. value) 100% at conv. limit current	0 - 100 (0,1)	%		
P05	KALPHA	Control angle indication	0 - 180 (0,1)	deg.		
P06	II ANZ	Current controller integrator (absolute value)	0 - 100 (0,01)	%		
P07	EMK	E.m.f. indication (absolute value)	0 - 999	V		
P08	UD ALPHA	Armature voltage indication (absolute value)	0 - 999	V		
P09	A IN	Analog input, Terminal 96 100% at 10V x E02 : 100	-199 - + 999 (0,1)	%		
P10	U NETZ EFF	Mains voltage rms indication	0 - 999	V		
*** Jogging settings ***						
P11	SOLLW TV ON	Jogging 1 setpoint	-100 - + 100 of n_{max} (0,1)	%	0,0	3)
P12	SOLLW TR ON	Jogging 2 setpoint	-100 - + 100 of n_{max} (0,1)	%	0,0	3)
P13	KR SOLLW ON	Creep setpoint	-100 - + 100 of n_{max} (0,1)	%	0,0	3)
P14	CMD HOCHL OFF	Selection of inching modes for the ramp-function generator	000 - 211	Hex	001	1) 3)
P15	KLEMMEN	Terminals status indication				1)

	Abbreviation	Plain text	Range (Grading)	Unit	Factory setting	Set value
*** Ramp-function generator settings ***						
P16	HLZ P1 ON	Ramp-function generator ramp-up time 1	0 - 300 (0,01)	s	0,00	
P17	RLZ P1 ON	Ramp-function generator ramp-down time 1	0 - 300 (0,01)	s	0,00	
P18	BZ P1 ON	Ramp-function generator start transition 1	0 - 10,0 (0,01)	s	0,00	3)
P19	VZ P1 ON	Ramp-function generator end transition 1	0 - 10,0 (0,01)	s	0,00	3)
P20	SZI SID ON	Setpoint - actual value difference filtering	0 - 300	ms	0	
*** Speed monitor settings ***						
P21	N MIN 1 ON	Minimum speed 1 (indication)	0,0 - 100 of n_{max} (0,1)	%	0,1	
P22	N MIN 2 ON	Minimum speed 2 (indication on supplementary module A1210)	0,0 - 10 of n_{max} (0,1)	%	0,1	
P23	NX1 ON	Speed threshold gear step I	0 - 100 of n_{max}	%	100	
P24	NX2 ON	Speed threshold gear step II	0 - 100 of n_{max}	%	100	
P25	NX3 ON	Speed threshold gear step III	0 - 100 of n_{max}	%	100	
P26	NX4 ON	Speed threshold gear step IV	0 - 100 of n_{max}	%	100	
P27	N DELTA ON	Response range Δn of N SET = N ACT signal	0 - 60,0 of n_{max} (0,1)	%	2,0	
*** Speed controller settings ***						
P28	ISW N ON	Integrator start value on speed controller enabling	-100 - + 100 of I_{rated}	%	0	
P29	AUSW N ON	Digital current additional setpoint	-100 - + 100 of I_{rated}	%	0	
P30	OFFS N ON	Digital offset adjustment of speed controller	-100 - + 100	$\frac{\%n_{max}}{163,84}$	0	

	Abbreviation	Plain text	Range (Grading)	Unit	Factory setting	Set value
P31	KP N ON	Speed controller P-gain	0,1 - 200 (0,1)		5,0	
P32	TN N ON	Speed controller integral-action time	0,00 - 10,0 (0,01)	s	1,00	
P33	KP N2 ON	Speed controller P-gain for gear step II	0,1 - 200 (0,1)		5,0	
P34	TN N2 ON	Speed controller integral-action time for gear step II	0,00 - 10,0 (0,01)	s	1,00	
P35	KP N3 ON	Speed controller P-gain for gear step III	0,1 - 200 (0,1)		5,0	
P36	TN N3 ON	Speed controller integral-action time for gear step III	0,00 - 10,0 (0,01)	s	1,00	
P37	KP N4 ON	Speed controller P-gain for gear step IV	0,1 - 200 (0,1)		5,0	
P38	TN N4 ON	Speed controller integral-action time for gear step IV	0,00 - 10,0 (0,01)	s	1,00	
*** Current limit values ***						
P39	I GRENZ P1 ON	positive current limit value 1	0 - 300 of $I_{mot rated}$	%	120	
P40	I GRENZ N1 ON	negative current limit value 1	0 - 300 of $I_{mot rated}$	%	120	
P41	I GRENZ P2 ON	positive current limit value 2	0 - 300 of $I_{mot rated}$	%	100	
P42	I GRENZ N2 ON	negative current limit value 2	0 - 300 of $I_{mot rated}$	%	100	
P43	ZEIT BL ON	Tripping delay for blocking protection 0: Blocking protection suppressed	0 - 60,0 (0,1)	s	0,5	
P44	I GRENZ PN2 ON	Current absolute limit value for gear step II	0 - 300 of $I_{mot rated}$	%	100	
P45	I GRENZ PN3 ON	Current absolute limit value for gear step III	0 - 300 of $I_{mot rated}$	%	100	
P46	I GRENZ PN4 ON	Current absolute limit value for gear step IV	0 - 300 of $I_{mot rated}$	%	100	

	Abbreviation	Plain text	Range (Grading)	Unit	Factory setting	Set value
P47	IX ON	Current threshold	0 - 200 of I _{limit}	%	100	
P48	N1 ON	Speed-related current limiting threshold	0 - 100 of n _{max}	%	100	
P49	I MAX2 ON	Current limit value at maximum speed	0 - 300 of I _{mot rated}	%	100	
P50	N UMSCHALT ON	Changeover speed (from current limit 1 to current limit 2)	0 - 100 of n _{max}	%	0	
Code and bootstrapping parameters						
P51	SCHLP ON	Code parameter	0 - 999		0	1)
P52	URLAD OFF	Bootstrap loading: transfer from EPROM to EEPROM	000 - FFF	Hex	A50	1)
*** Feed mode (C-axis) settings ***						
P53	I KIPP ON	Current threshold for adaption	0 - 100 of I _{rated}	%	0	
P54	KP N VS ON	Speed controller P-gain for feed operation	0,01 - 200 (0,01)		1,00	
P55	TN N VS ON	Speed controller integral-action time for feed operation	0 - 999	ms	999	
P56	KP N VS1 ON	P-gain for low speeds / currents / control deviations	0,01 - 200 (0,01)		1,00	
P57	TN N VS1 ON	Integral-action time for low speeds / currents / control deviations	0 - 999	ms	999	
P58	N1 VS ON	Speed threshold 1	0 - 100 of n _{max} (0,01)	%	0,00	
P59	N2 VS ON	Speed threshold 2	0 - 100 of n _{max} (0,01)	%	0,00	
*** Spindle NC positioning settings (via NC) ***						
P60	KP N FAK ON	Adaption factor for speed controller P-component during spindle positioning	0,1 - 10,0 (0,1)		1,0	
P61	TN N FAK ON	Adaption factor for speed controller integral-action time during spindle positioning	0,1 - 10,0 (0,1)		1,0	

	Abbreviation	Plain text	Range (Grading)	Unit	Factory setting	Set value
*** Current controller settings ***						
P62	TH SSWI ON	Ramp-up time for current setpoint integrator	0 - 100	ms	0	
P63	CMD I OFF	Selection of operating modes for current controller and precontroller	0 - 4	Hex	0	1)
P64	KP I ON	Current controller P-gain	0,01 - 5,0 (0,01)		0,05	
P65	TN I ON	Current controller integral-action time	0 - 50,0 (0,1)	ms	50,0	
*** Precontroller settings ***						
P66	K7 ON	Precontrol R component with intermittent flow	0 - 255		0	
P67	K9 ON	Precontrol R component with continuous flow	0 - 255		0	
P68	ILG ON	Continuous current boundary	0 - 100 of I_{ratad}	%	10	
P69	EMK BEW ON	Control parameter for E.M.F. precontrol	0 - 1	Hex	0	1)
*** Motor rated current / I²t settings ***						
P70	T THERM OFF	I ² t-monitoring Overload time constant	0 - 180 (0,1)	min	60,0	
P71	I MOTOR OFF	Rated motor current/rated converter current	0 - 100 of I_{ratad}	%	80	
*** Gear settings ***						
P72	Ü SPINDEL 1 ON	Gear ratio, speed I Motor speed / spindle speed	0,0 - 500 (0,1)		1,0	
P73	Ü SPINDEL 2 ON	Gear ratio, speed II Motor speed / spindle speed	0,0 - 500 (0,1)		1,0	
P74	Ü SPINDEL 3 ON	Gear ratio, speed III Motor speed / spindle speed	0,0 - 500 (0,1)		1,0	
P75	Ü SPINDEL 4 ON	Gear ratio, speed IV Motor speed / spindle speed	0,0 - 500 (0,1)		1,0	

	Abbreviation	Plain text	Range (Grading)	Unit	Factory setting	Set value
*** Field settings ***						
P76	I FELD SOLL OFF	<u>Rated field current (motor)</u> Field current limit (converter)	0 - 100 I _{F ratad}	%	50	
P77	EMK SOLL OFF	e.m.f. setpoint (0 = constant field current at P76)	0 - 900	V	340	1)
P78	KPE ON	e.m.f. controller P-gain	0,01 - 10,0 (0,01)		0,50	
P79	TNE ON	e.m.f. controller integral action time	0 - 3,00 (0,01)	s	1,00	
*** Selection of operating modes ***						
P80	CMD DIG AUS OFF	Selection of operating mode for output relays K2 (terminals 72,73,74) and K1 (terminals 315, 316, 314)	0 - 5	Hex	1	1)
P81	CMD KO OFF	Selection of operating mode for operating module	0 - 2	Hex	0	1)
P82	CMD AN AUS ON	Selection of operating mode for analog output (terminal 100)	0 - 17		0	1)
P83	CMD EIN3 OFF	Selection of operating mode for digital input 3 (terminal 81)	0 - 14		0	1)
P84	CMD EIN4 OFF	Selection of operating mode for digital input 4 (terminal 111)	0 - 14		0	1)
P85	CMD A IN OFF	Selection of operating mode for analog input (terminal 96)	0 - 11		0	1)
P86	CMD I AUSG OFF	Selection of operating mode for current actual value output (terminal 16)	0 - 3	Hex	1	1)
P87	CMD WEIN ON	Selection of operating mode for restart	00 - 33	Hex	32	1)
P88	CMD FELD RED OFF	Selection of operating mode for automatic field current reduction	0 - 1	Hex	0	1)
P89	CMD N OFF	Selection of operating mode for speed controller	00 - 73	Hex	00	1)
P90	CMD FELD OFF	Selection of operating mode for field	00 - 12	Hex	02	1)
P91	CMD FA OFF	Cancellation of fault indications	000 - FFF	Hex	000	1)

	Abbreviation	Plain text	Range (Grading)	Unit	Factory setting	Set value
P92	CMD VS OFF	Selection of operating mode for C-axis	000 - 114	Hex	000	1)
P93	SCHW KST ON	Switching threshold for operating module	0 - 10,0 of n-cont. (0,01)	%	0,10	
*** Firing angle limiting ***						
P94	ALPHAG OFF	Rectifying limit	0 - 180	deg.	30	
P95	ALPHAW OFF	Inverting limit	0 - 180	deg.	150	
*** Equipment matching parameters***						
P96	I FELD RED P ON	Minimum field current as % of I FIELD SET P76	0 - 100	%	25	
P97	CMD SER OFF	Selection of operating mode for serial interface	0 - 539	Hex	019	1)
P98	U ANSCHL OFF	Supply voltage matching factor Armature circuit Electronics x 380	0 - 900	V	380 (500)	1) 2)
P99	OFF	Software status	1x.x 2x.x 3x.x	Hex	3x.x	1) 2)
*** Setting for 1st control-deviation filter***						
E00	CMD VERSION ON	Converter version (Options)	000 - FFF	Hex		1) 2)
E01	NORM SOLL ON	System voltage Speed setpoint	0 - 105	0,1 V	100	
E02	NORM ZUS ON	System voltage for supplementary analog inputs, analog current limit terminal 96	0 - 999	0,1 V	100	
*** Setting for 1st control-deviation filter***						
E03	CMD SID OFF	Selection of filter type	00 - 11	Hex	10	1)
E04	CMD GÜTE ON	Suppression quality of 1st bandstop	0 - 3		0	1)

	Abbreviation	Plain text	Range (Grading)	Unit	Factory setting	Set value
E05	FREQUENZ I ON	Resonant frequencies of the 1st bandstop for gear speed I 0...7 = bandstop not active	0 - 140	Hz	0	
E06	FREQUENZ II ON	Resonant frequencies of the 1st bandstop for gear speed II 0...7 = bandstop not active	0 - 140	Hz	0	
E07	FREQUENZ III ON	Resonant frequencies of the 1st bandstop for gear speed III 0...7 = bandstop not active	0 - 140	Hz	0	
E08	FREQUENZ IV ON	Resonant frequencies of the 1st bandstop for gear speed IV 0...7 = bandstop not active	0 - 140	Hz	0	
*** Miscellaneous settings for feed operation (C-axes) ***						
E09	SID1 VS ON	Setpoint/act. speed value difference Threshold 1, $100\% \pm n_{max}$	0 - 100	%	0	
E10	SID2 VS ON	Setpoint/act. speed value difference Threshold 2, $100\% \pm n_{max}$	0 - 100	%	0	
E11	OFFS N VS ON	Digital offset adjustment of speed controller of C-axes	- 100 - + 100	$\frac{\%n_{max}}{163,84}$	0	
E12	KPI VS ON	Current limiting controller P-gain	0,01 - 5,00 (0,01)		0,16	
E13	TNI VS ON	Current limiting controller Integral-action time	0 - 50,0 (0,1)	ms	1,3	
E14	ALPHA 0 OFF	Alpha 0	0 - 180	deg.	120	
E15	IKIPP 2 ON	Current threshold 2 for adaption	0 - 100 of I_{rated}	%	0	
*** Miscellaneous settings for ramp-function generator ***						
E16	HLZ P2 ON	Ramp-function generator ramp-up time 2	0 - 300 (0,01)	s	0,00	
E17	RLZ P2 ON	Ramp-function generator ramp-down time 2	0 - 300 (0,01)	s	0,00	
E18	BZ P2 ON	Ramp-function generator start transition 2	0 - 10,0 (0,01)	s	0,00	3)
E19	VZ P2 ON	Ramp-function generator end transition 2	0 - 10,0 (0,01)	s	0,00	3)
E20	CMD MOTP OFF	Selection of operating mode for motor potentiometer function	0 - 1	Hex	0	1) 3)

	Abbreviation	Plain text	Range (Grading)	Unit	Factory setting	Set value
*** Setting for overspeed protection ***						
E20	NXUE ON	Tripping threshold for overspeed protection F10 (0:overspeed protection off)	0 - 120 of n_{max}	%	120	
*** Setting values for A1210 module ***						
E21	CMD 117 OFF	Selection of function for digital input terminal 117	0 - 24		10	1) 3)
E22	CMD 118 OFF	Selection of function for digital input terminal 118	0 - 24		11	1) 3)
E23	CMD 119 OFF	Selection of function for digital input terminal 119	0 - 24		12	1) 3)
E24	CMD 60 OFF	Selection of function for digital input terminal 60	0 - 24		13	1) 3)
E25	CMD 61 OFF	Selection of function for digital input terminal 61	0 - 24		14	1) 3)
E26	CMD 107 OFF	Selection of function for digital input terminal 107	0 - 24		3	1) 3)
E27	CMD REL A1210 OFF	Selection of function for relay outputs (K8, K6, K5)	000 - AAA	Hex	321	1) 3)
E28	CFG A1210 OFF	Selection of configuration for A1210 module	0 - 2	Hex	0	1) 3)
E29	CMD AIN A1210 OFF	Selection of function for analog input terminals 562/142	0 - 11		11	1) 3)
*** Setting for IxR compensation ***						
E30	R ARM ON	IxR compensation	-30 - +30 (0,1)	%	0,0	3)
*** Activation of thyristor diagnosis ***						
E31	CMD SEA6 OFF	Selection of operating mode for thyristor diagnosis	0 - 3		0	
*** Setting values for process-specific functions ***						
E40	N MIN CMD N ON	P / PI controller switchover threshold	0,0 - 10,0 of n_{max} (0,1)	%	0,0	1)

	Abbreviation	Plain text	Range (Grading)	Unit	Factory setting	Set value
*** Setting values for process-specific functions ***						
E51	SOLLW 117 ON	Setpoint for injection via terminal 117	-100 - +100 (0,1)	%	0,0	3)
E52	SOLLW 118 ON	Setpoint for injection via terminal 118	-100 - +100 (0,1)	%	0,0	3)
E53	SOLLW 119 ON	Setpoint for injection via terminal 119	-100 - +100 (0,1)	%	0,0	3)
E54	SOLLW 60 ON	Setpoint for injection via terminal 60	-100 - +100 (0,1)	%	0,0	3)
E55	SOLLW 61 ON	Setpoint for injection via terminal 61	-100 - +100 (0,1)	%	0,0	3)
E56	SOLLW 107 ON	Setpoint for injection via terminal 107	-100 - +100 (0,1)	%	0,0	3)
E57	N MIN 3 ON	n_{min3}	0,0 - 120 (0,1)	%	0,0	3)
E58	N MIN 4 ON	n_{min4}	0,0 - 120 (0,1)	%	0,0	3)
E59	N MIN 5 ON	n_{min5}	0,0 - 120 (0,1)	%	0,0	3)
E60	STATIK ON	Offset	0,0 - 10,0 (0,1)	%	0,0	3)
E61	SOLLW ABM ON	Setpoint reduction (pre-limit switch)	0,0 - 100 (0,1)	%	100	3)
E62	SOLLW PEND ON	Oscillating setpoint	0,1 - 10,0 of n_{max} (0,1)	%	0,4	
E63	F PEND ON	Oscillating frequency	0,1 - 5,0 (0,1)	Hz	5,0	
E64	A IN SIEB ON	Filter time for analog input on A1210 module	0 - 300	ms	0	3)
E65	NORM ZUS1 ON	Range selection for analog input	0 - 999	0,1 V	100	3)
E66	A IN1	Indication of A IN 1 for analog input on A1210 module	-199 - +999 (0,1)	%		3)

	Abbreviation	Plain text	Range (Grading)	Unit	Factory setting	Set value
E67	NORM AN AUS ON	Scaling factor for analog output terminal 100	-9,9 - +9,9 (0,1)		1,0	
E68	MOM BEGR ON	Torque limiting	0 - 300 of $M_{mot rated}$	%	300	
E69	BEGR P ON	Power limiting (0 = no power limitation)	0 - 300 of $P_{mot rated}$	%	0	
E70	CMD MOMREG OFF	Selection of operating mode for torque control function	00 - 11	Hex	00	1)
E71	CMD RÜCKM 1 ON	Selection of checkback signal 1	000 - AAA	Hex	000	3) 4)
E72	CMD RÜCKM 2 ON	Selection of checkback signal 2	0 - 2	Hex	000	3) 4)
E73	CMD WAHL 1 ON	User-assignable signal 1	0 - 17		0	3) 4)
E74	CMD WAHL 2 ON	User-assignable signal 2	0 - 17		0	3) 4)
E75	CMD AUSBL ON	Suppression parameter	00 - 3F	Hex	00	3) 4)
*** Setting of armature voltage ***						
E77	UA NENN OFF	Motor rated armature voltage	0 - 900	V	380	
*** Settings for speed controller adaptation in main-spindle mode ***						
E80	CMD HSA OFF	Selection of operating mode for adaptation in main-spindle mode	000 - 142	Hex	000	1)
E81	KP N1A ON	P gain for low speed deviations / currents	0 - 200 (0,1)		5,0	
E82	TN N1A ON	Reset time for low speed deviations / currents	0 - 10,0 (0,01)	s	1,00	
E83	SCHW 1 HSA ON	Speed deviation / current - threshold 1, $100\% \hat{=} n_{max} / I_{rated}$	0 - 100 (0,1)	%	0,0	
E84	SCHW 2 HSA ON	Speed deviation / current - threshold 2, $100\% \hat{=} n_{max} / I_{rated}$	0 - 100 (0,1)	%	0,0	
E85	SCHW N HSA ON	Speed limit for adaptation range	0 - 100 of n_{max} (0,1)	%	0,0	

	Abbreviation	Plain text	Range (Grading)	Unit	Factory setting	Set value	
*** Settings for limit monitors***							
888	HYST ON	Differential gap for $n < n_x$, $I_A > I_x, n < n_{min2, \dots 5}$	000 - 999	Hex	584		1)
*** Settings for spindle positioning module (option) ***							
000	POS 1 VZ ON	Sign for position setpoint 1	0 - 1		0		5)
001	POS 1 WG ON	Degrees for position setpoint 1	0 - 359	deg	0		5)
002	POS 1 ZG ON	1/10 degrees for position setpoint 1	0 - 9	1/10 deg	0		5)
003	POS 2 VZ ON	Sign for position setpoint 2	0 - 1		0		5)
004	POS 2 WG ON	Degrees for position setpoint 2	0 - 359	deg	0		5)
005	POS 2 ZG ON	1/10 degrees for position setpoint 2	0 - 9	1/10 deg	0		5)
006	NULLPKT GROB ON	Zero shift, coarse	0 - 359	deg	0		5)
007	NULLPKT FEIN ON	Zero shift, fine	-100 - + 100	pulses	0		5)
008	N GR I ON	Search speed for gear speed I	-100 - + 100 of n_{max} (0,1)	%	5,0		5)
009	K V I ON	Position controller gain for gear speed I	0,1 - 999 von $n_{max}/rev.$ (0,1)	%	7,0		5)
010	OFFS POS ON	Offset at n controller input	-100 - + 100	$\frac{\% n_{max}}{163,84}$	0		5)
011	SCHL DZ I ON	Creep speed for gear speed I	0,1 - 100 of n_{max} (0,1)	%	2,0		5)
012	REL UNG ON	Response threshold for relay K12 (Position reached signal II)	0 - 999	pulses	5		5)
013	REL GEN ON	Response threshold for relay K11 (Position reached signal I)	0 - 999	pulses	5		5)

	Abbreviation	Plain text	Range (Grading)	Unit	Factory setting	Set value
U14	CMD POS 1 OFF	CMD POS 1	000 - 111	Hex	000	5)
U15	CMD POS 2 OFF	CMD POS 2	000 - 011	Hex	000	5)
U16	CMD POS 3 OFF	CMD POS 3	000 - 213	Hex	000	5)
U17	CMD POS 4 ON	Transfer of zero shift	0 - 1		0	5)
U18	IMPUM TAUS OFF	Encoder pulses per revolution (thousands)	0 - 15	1000 pulses	1	5)
U19	IMPUM EIN OFF	Encoder pulses per revolution (hundreds, tens, units)	0 - 999	pulses	24	5)
U20	N GR II ON	Search speed for gear speed II	-100 - + 100 of n_{max} (0,1)	%	5,0	5)
U21	K V II ON	Position controller gain for speed II	0,1 - 999 von $n_{max} / rev.$ (0,1)	%	7,0	5)
U22	SCHL DZ II ON	Creep speed for gear speed II	0,1 - 100 of n_{max} (0,1)	%	2,0	5)
U23	N GR III ON	Search speed for gear speed III	-100 - + 100 of n_{max} (0,1)	%	5,0	5)
U24	K V III ON	Position controller gain for gear speed III	0,1 - 999 von $n_{max} / rev.$ (0,1)	%	7,0	5)
U25	SCHL DZ III ON	Creep speed for gear speed III	0,1 - 100 of n_{max} (0,1)	%	2,0	5)
U26	N GR IV ON	Search speed for gear speed IV	-100 - + 100 of n_{max} (0,1)	%	5,0	5)
U27	K V IV ON	Position controller gain for gear speed IV	0,1 - 999 von $n_{max} / rev.$ (0,1)	%	7,0	5)
U28	SCHL DZ IV ON	Creep speed for gear speed IV	0,1 - 100 of n_{max} (0,1)	%	2,0	5)
U29	NSP VZ	Indication of spindle direction of rotation	-1 - 0 - +1			5)

	Abbreviation	Plain text	Range (Grading)	Unit	Factory setting	Set value	
U30	DELTA PHI	Deviation from setpoint position	-199 - 0 - +999	pulses			5)
U31	Klemmen A1211	Indication of status of binary inputs on module A1211					5)
*** Settings for 2nd control deviation filter ***							
U50	CMD GÜTE ON	Suppression quality of 2nd bandstop	0 - 3		0		1)
U51	FREQUENZ I ON	Resonant frequency of 2nd bandstop for gear speed I 0...7 = bandstop not active	0 - 74		0		
U52	FREQUENZ II ON	Resonant frequency of 2nd bandstop for gear speed II 0...7 = bandstop not active	0 - 74	Hz	0		
U53	FREQUENZ III ON	Resonant frequency of 2nd bandstop for gear speed III 0...7 = bandstop not active	0 - 74	Hz	0		
U54	FREQUENZ IV ON	Resonant frequency of 2nd bandstop for gear speed IV 0...7 = bandstop not active	0 - 74	Hz	0		
*** Settings for dv/dt injection ***							
U55	T BESCHL I ON	Acceleration time for gear speed I	0,00 - 50,0	s	0,00		1)
U56	T BESCHL II ON	Acceleration time for gear speed II	0,00 - 50,0	s	0,00		1)
U57	T BESCHL III ON	Acceleration time for gear speed III	0,00 - 50,0	s	0,00		1)
U58	T BESCHL IV ON	Acceleration time for gear speed IV	0,00 - 50,0	s	0,00		1)
U59	CMD M BESCHL OFF	Control parameter for dv/dt injection	00 - 91		00		1)

If the code parameter P51 is set to 99, then the L parameters appear after the last U parameter. Values stored in the EEPROM and normally used only internally or defined by the field characteristic measurement (L08-L34) can be read out and also modified by means of the L parameters.

	Abbreviation	Plain text	Range (Grading)	Unit	Factory setting	Set value
L01	DIAG A L ON	Diagnostic address low byte	00 - FF	Hex	00	
L02	DIAG A H ON	Diagnostic address high byte	00 - FF	Hex	10	
L03	DIAG WERT	Contents of diagnostic memory location	00 - FF	Hex		
L04	DIAG SHI ON	Number of shifts for analog diagnostic function	0 - 15		0	
L05	CMD 5 P	Various flag bits	00 - FF	Hex	01	1)
L06	FNUM ON	Last fault to occur	00 - 99	Hex	00	
L07	HLG AUSG	Ramp-function generator output for motor potentiometer	-105 - + 105 (0,1)	%	0,0	3)
L08	K PHI	e.m.f. / n_{act} scaled	0 - 999 (0,01)			
L09	CMD KL ON	"Field characteristic measured" flag	0 - 1	Hex	0	1)
L10	EMK KENNL ON	E.m.f. setpoint at transition speed	0 - 999	V	340	1)
L11	TAB ANF N ON	Transition speed	0 - 199 of n_{max} (0,1)	%	100	1)
L12		1st characteristic point	0 - 199 of n_{max} (0,1)	%	199	1)
L13		2nd characteristic point	0 - 199 of n_{max} (0,1)	%	199	1)
L14		3rd characteristic point	0 - 199 of n_{max} (0,1)	%	199	1)
L15		4th characteristic point	0 - 199 of n_{max} (0,1)	%	199	1)

	Abbreviation	Plain text	Range (Grading)	Unit	Factory setting	Set value
L15	ON	5th characteristic point	0 - 199 of n_{max} (0,1)	%	199	1)
L16	ON	6th characteristic point	0 - 199 of n_{max} (0,1)	%	199	1)
L17	ON	7th characteristic point	0 - 199 of n_{max} (0,1)	%	199	1)
L18	ON	8th characteristic point	0 - 199 of n_{max} (0,1)	%	199	1)
L19	ON	9th characteristic point	0 - 199 of n_{max} (0,1)	%	199	1)
L20	ON	10th characteristic point	0 - 199 of n_{max} (0,1)	%	199	1)
L21	ON	11th characteristic point	0 - 199 of n_{max} (0,1)	%	199	1)
L22	ON	12th characteristic point	0 - 199 of n_{max} (0,1)	%	199	1)
L23	ON	13th characteristic point	0 - 199 of n_{max} (0,1)	%	199	1)
L24	ON	14th characteristic point	0 - 199 of n_{max} (0,1)	%	199	1)
L25	ON	15th characteristic point	0 - 199 of n_{max} (0,1)	%	199	1)
L26	ON	16th characteristic point	0 - 199 of n_{max} (0,1)	%	199	1)
L27	ON	17th characteristic point	0 - 199 of n_{max} (0,1)	%	199	1)
L28	ON	18th characteristic point	0 - 199 of n_{max} (0,1)	%	199	1)
L29	ON	19th characteristic point	0 - 199 of n_{max} (0,1)	%	199	1)
L30	ON	20th characteristic point	0 - 199 of n_{max} (0,1)	%	199	1)
L31	INDEX MAX ON	2x number of valid characteristic points	0 - 40		0	

	Abbreviation	Plain text	Range (Grading)	Unit	Factory setting	Set value
032	I FELD MIN ON	Minimum field current at n_{max} [255 = Rated field current (P76)]	0 - 255		13	
033	NETZ 0 SIEB ON	Power-frequency adaptation / response threshold for F11	00 - 33		00	1)
034	NETZ 0 OFF ON	Offset relative to line-voltage zero	-199 - + 199	10 μ s	0	1)

- 1) The meanings of the settings are listed in the description of the control registers
- 2) This parameter is set in the factory, and is not modified when "Bootstrap loading" command is given
- 3) Not provided for SIMODRIVE (the factory settings should be retained to ensure that no functions provided for other applications are activated)
- 4) Only effective if supplementary module Z1004 is provided
- 5) Required supplementary modules
 - Positioning control 6RA8271-1AB00
 - Supplementary power supply 6RA8220-1AA00
For the meanings of the spindle positioning parameters, please refer to the instruction manual "Positioning control for main spindles, 6RA27" Order No.: C98043-A1211-L1-*-7619

I_{rated} $\hat{=}$ Rated converter current according to rating plate of converter (converter limit current)

$I_{mot. rated}$ $\hat{=}$ Rated motor current according to rating plate

$I_{F rated}$ $\hat{=}$ Rated field current according to rating plate

I_{limit} $\hat{=}$ currently active current limit

$M_{mot. rated}$ $\hat{=}$ Rated motor torque ($\sim I_{MotN} \times I_{FN}$)

$P_{mot. rated}$ $\hat{=}$ Motor rated power ($\hat{=}$ EMF SETPOINT X I MOTOR N)

ON ... Parameter can be changed "on-line", i.e. even while the controller is enabled (operating states I, II and - -)

OFF ... Parameter can only be changed in operating states o1, o2 ... o8 (off-line)

14 Description of parameters

P14

Selection of operating mode for the ramp-function generator
CMD HOCHL

X X X

0

Function: The jogging setpoints are applied to the ramp-function generator input.

1

Function: The jogging setpoints are applied directly to the speed controller input, bypassing the ramp-function generator.

Disabling of the ramp-generator function

The ramp-function generator is prevented from "running away" as long as the drive operates at the current limit and is therefore unable to following the setpoint ramp.

0

Ramp generator active (works delivery state)

1

Ramp generator disabled

In operating states o8, o7, o6, (o5), o4, o3, o2 and o1 and, if a fault signal is present, also when P14 = x1x (ramp-generator function disabled), the ramp generator output is set to the actual-speed value.

Ramp-function integrator

The ramp-function generator parameters are changed automatically when the reference voltage (i.e. the setpoint at the ramp generator input) is reached for the first time after application of the DRIVE ENABLE signal at terminal 64.

0

Ramp generator (works delivery state)

1

Ramp-function integrator
The ramp-up and ramp-down times are set to 0.

2

Ramp-function integrator
Parameters E16, E17, E18 and E19 become operative.

When terminal 64 is open-circuited (no DRIVE ENABLE signal), the drive is ramped to standstill (Parameters P16 to P19).

Terminal 62 on the A1210 module (switchover to ramp generator 2) has priority over the ramp function integrator, i.e. parameters E16 to E19 are always effective as long as terminal 62 is activated!

The motor potentiometer function has priority over the ramp function integrator i.e. the ramp generator is always effective as long as the terminal "Motorpoti ON" (= manual mode) is activated!

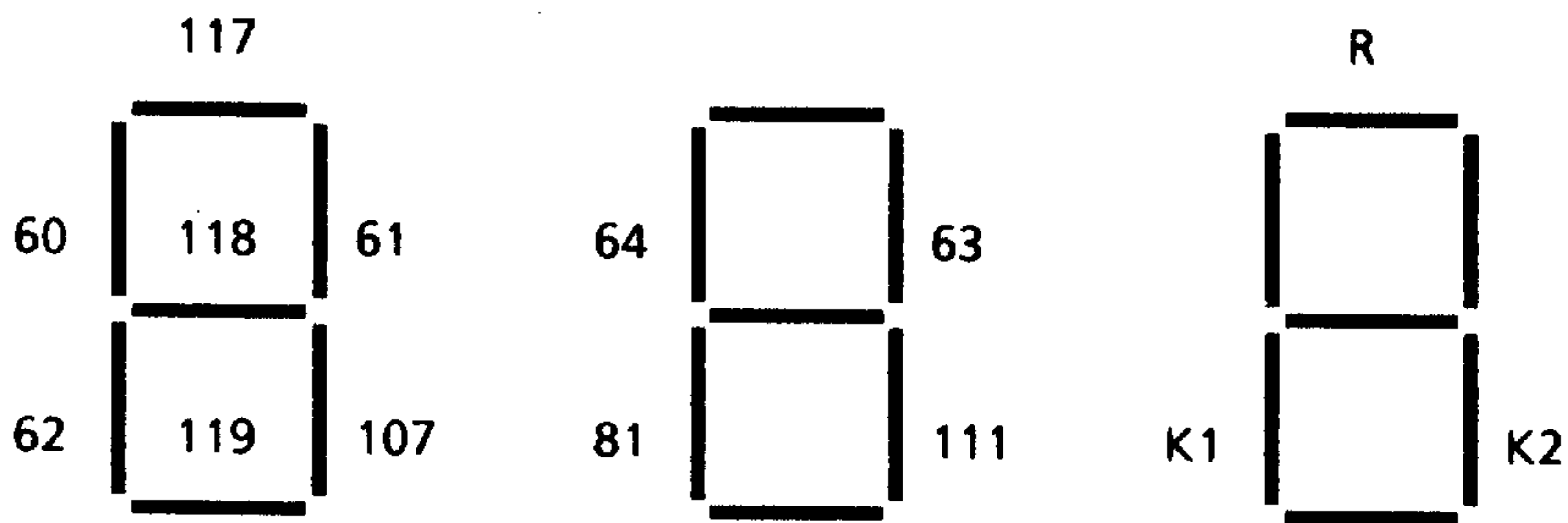

Every segment of the seven-segment display indicates a status of the binary input terminals or the output relays of the A1203 / A1204 module.

Segment illuminated → Terminal activated or relay picked up.

Segment	60: Terminal 60 on A1210	OSCILLATE
Segment	61: Terminal 61 on A1210	C AXIS
Segment	62: Terminal 62 on A1210	$T_H = 0$
Segment	107: Terminal 107 on A1210	<u>FIELD CURRENT REDUCTION</u>
Segment	117: Terminal 117 on A1210	GEAR SPEED II
Segment	118: Terminal 118 on A1210	GEAR SPEED III
Segment	119: Terminal 119 on A1210	GEAR SPEED IV
Segment	64: Terminal 64	DRIVE ENABLE
Segment	63: Terminal 63	<u>PULSE ENABLE</u>
Segment	81: Terminal 81 digital INPUT 3	(RAPID STOP)
Segment	111: Terminal 111 digital INPUT 4	(CURRENT LIMIT CHANGEOVER)
Segment	K1: Relay K1 has picked up	$(n < n_{min1})$
Segment	K2: Relay K2 has picked up	(Ready/Fault)
Segment	R: Terminal R on A1210	Reset fault memory

P50

Code parameter
CODEP

0

Function: Normal operation
No parameter (except code parameter) can be modified.

2

Function: When the unit is next switched on, an enquiry is made
as to whether the current controller self-optimization run is to be executed.

Display: OP

The "LOWER" key must be pressed if no self-optimization run is desired. The unit then switches automatically to normal operation. The self-optimization run is started by pressing the "HIGHER" key. During the current controller self-optimization run, the pre-controller parameters P66, P67 and P68 and the current controller parameters P64 and P65 (display: set value) are set when the field is deenergized.

The unit then switches to the status 07.

3

Function: As for 2 but with execution of the speed controller self-optimization run.

The speed controller parameters P31 and P32 (display: set value) are set after the "HIGHER" key has been pressed. The correct connection of the tachogenerator is also checked. 111 is displayed between the individual setting processes. The unit switches to the status 07 after completion of the self-optimization run.

4

Function: Parameters P11 to P79 and all
E and U parameters can be modified

5

Function: Field characteristic measurement

Units without field-weakening control (P77 = 0)

A single measuring point only is measured when e.m.f. = 100 V; Measurement time approx. 10 sec.

Units with field-weakening control (P77 ≥ 120 V)

Measurement time up to 2 min.; the characteristic is measured at approximately half the e.m.f. setpoint, but always between 90 V and 200 V. Speeds which exceed the rated speed can be reached depending on the field weakening range.

In addition, a characteristic point is measured at 94 % of the e.m.f. setpoint (P77) with the rated field which produces a speed of 94 % of the rated speed.

Possible fault indications:

F18: MAXIMUM NUMBER OF MEASURING POINTS EXCEEDED, i.e. in spite of maximum field weakening, the maximum speed cannot be reached or the set e.m.f. setpoint is too low (P77 < 120V)

F30: CHARACTERISTIC FAULT, i.e. no meaningful characteristic can be obtained from the measuring points converted to the e.m.f. setpoint (e.g. load surge during measurement of field characteristic, analog field current controller reaches limit, . . .)

The display indicates the e.m.f. and the actual speed value for 2 sec. with every measuring point.
After successful completion of the field characteristic measurement, P90 = x0 (normal operation) is set automatically and the unit switched to the status 07.

8

Function: Automatic calculation of Parameters P48 and P49 (speed-related current limitation) from the motor rating plate data. For details, see "Notes on startup".

10

Function: Parameters P80 to P99 can be modified

30

Function: Starting the output of a parameter log to a printer.
The transfer of a short parameter log to a printer via the TTY interface on the A1210-L21 supplementary module (luxury supplementary module for main spindle) can be started by pressing the MODE key.
See also P97

31

Function: Starting a once-only output of a parameter log to a PG635/PG675/PG685 via the TTY interface.
Pressing the MODE key starts the transmission. The transmission begins with the machine data code " %T E A 1 " and ends with 40x <NUL> otherwise the same data are transmitted as with P51 = 30. The data transfer is faster than in the case of P51 = 30 because printer output does not involve waiting times for carriage return.

35

Function: Reading-in of parameter data from a PG635/PG675/PG685 via the TTY interface.
Pressing the MODE key readies the basic unit for reception, indicated by III jumping from left to right on the display. During the transmission the parameter data will flit across the display.

60

Function: Starting of a once-only diagnostic output to a printer via the TTY interface.
Pressing the MODE key will start the transmission.
For works-internal purposes only.

61

Function: Starting of a once-only diagnostic output to a PG635/PG675/PG685 via the TTY interface.
Pressing the MODE key starts the transmission which ends with 40x <NUL>. There are no waiting times for carriage return.
For works-internal purposes only.

Function: Possibility of reading and defining L parameters.

In P mode, the display A - L (corresponds to parameter L00) appears when the "HIGHER" key is pressed after the highest parameter. After the unit has been switched over to W mode, the "HIGHER" and "LOWER" keys can be used to set the LOW byte of the address of which the contents are to be output (display xx).

The display A - H (corresponds to parameter L01) appears after the unit has been switched over to P mode (display A - L) and the "HIGHER" key pressed. The HIGH byte of the desired address can now be set (display xx) by switching over to W mode and pressing the "HIGHER" and "LOWER" keys.

The display $\equiv - \equiv$ (corresponds to parameter L03) appears after the unit has been switched over again to P mode (display A - H) and the "HIGHER" key pressed.

After the unit has been switched over to W mode, the contents of the previously selected memory location are displayed.

The address contents can now be increased or decreased by pressing the "HIGHER" and "LOWER" keys. The display now shows the contents of this memory location.

The software release date can be read out of the EPROM using this function.

Address: 9FFC Day
 9FFD Month
 9FFE Year
 9FFF Year

The display SHI [abbreviation for "Shift"] (corresponds to parameter L04) appears after the unit has been switched over again to P mode and the "HIGHER" key pressed.

After the unit has been switched over to W mode, the "HIGHER" and "LOWER" keys can be used to set the number of shifts by which the contents of the previously set address is to be shifted to the left.

The higher-order byte of the value calculated in this way can be applied to the analog output (terminal 100) by setting P82 = 9.

(Important: It is not meaningful to enter anything other than an even address).

The remaining L parameters appear when the "HIGHER" key is pressed again in P mode.

Important: With this setting of the key parameter, all parameter settings can be changed provided that the firing pulses are enabled.

It is advisable, therefore, that only trained personnel be authorized to use this setting!

P52

Bootstrap loading
BOOTS

A50

Function: Normal operation

No bootstrap loading routine is executed when the electronics power supply is connected.

XXX

Function: Bootstrap loading

When the power supply for the electronics is connected, the values for the parameters and the control register stored in the program memory are transferred to the EEPROM. After all the values have been transferred, the parameter BOOTS is set automatically to A50.

Important: The parameters P98, P99 and E00 are not changed during bootstrap loading. They must be set correctly by hand prior to bootstrap loading. (The first position of P99 is particularly important since this determines the selection of the corresponding IPL values!)

P83

Selection of operating modes for current controller and precontroller
CMD I

0

Function: The precontroller and current controller are both active.

1

Function: Disable current controller.

The current controller is disabled, the precontroller is enabled.

2

Function: Disable current controller integrator.

The current controller P component and the precontroller are enabled, the integrator of the current controller is disabled.

(The bit is also set internally when the inverter limits are reached)

3

Function: Disable precontroller and current controller.

α_w is preset.

4

Function: Disable precontroller.

The precontroller is disabled, the current controller enabled.

P69

Control parameter for E.M.F. precontrol
EMR EVAL

0

Function: Normal operation.
The calculated e.m.f. is utilized for the precontrol.

1

Function: For precontrol purposes the e.m.f. is assumed to be 0V regardless of the e.m.f. which is actually calculated.
This setting must be used only for the manual calculation of the precontrol parameters. The motor must in this case be at a standstill.

P70

E.M.F. setpoint in V

0

Function: No field-weakening operation.
The field current set via P76 is output irrespective of the speed.

1

These setting values are not permissible.
In this case, the field characteristic measurement would lead to fault indication F18.

to

119

120

to

900

E.m.f. to which the drive adjusts itself in the field-weakening range.

Important: The e.m.f. to be set here is calculated as follows:

$$\text{e.m.f.} = U_{AN} - R_A \times I_{AN}$$

where U_{AN} : Rated armature voltage (specified on rating plate)

I_{AN} : Rated armature current

R_A : Armature circuit resistance (warm, at 20°C ambient temperature)

If R_A is not known, see P90 (setting x1x)

Selection of operating mode for output relays K1 and K2 CMD DIG OUT

0

Function: The output relay K1 (terminals 315,316,314) on the trigger module operates as " $n < n_{min} - 1$ " signalling relay.
The output relay K2 (terminals 72,74,73) on the trigger module operates as fault-signalling relay.

1

Function: The output relay K1 (terminals 315,316,314) on the trigger module operates as " $n < n_{min} - 1$ " signalling relay.
The output relay K2 (terminals 72,74,73) on the trigger module is used for the "Ready" signal.

2

Function: The output relay K1 (terminals 315,316,314) on the trigger module is used for the " $I > I_x$ " signal (I_x : P47).
The output relay K2 (terminals 72,74,73) on the trigger module operates as fault-signalling relay.

3

Function: The output relay K1 (terminals 315,316,314) on the trigger module is used for the " $I < I_x$ " signal (I_x : P47).
The output relay K2 (terminals 72,74,73) on the trigger module is used for the "Ready" signal.

4

Function: The output relay K1 (terminals 315,316,314) on the trigger module is used for the "Drive running" signal. The relay is picked up when the drive is in operating state --, I or II.
The output relay K2 (terminals 72,74,73) on the trigger module is used for the "Ready" signal.

5

Function: The output relay K1 (terminals 315,316,314) on the trigger module is used for the "Speed controller monitor" signal. The speed monitor is a $n_{set} - n_{act}$ comparator and is active in all operating states. In all operating states other than -- or I or II the comparison is made with a zero setpoint signal.
Comparator threshold: P27, Differential gap: 2% of n_{max}
The relay picks up when $n_{set} = n_{act}$ (precisely: $|n_{set} - n_{act}| < P27$)
The relay drops out when $n_{set} \neq n_{act}$ (precisely: $|n_{set} - n_{act}| > P27 + 2\% \text{ of } n_{max}$)
Operation of the speed controller monitor (i.e. deenergizing of the relay) does not lead to a fault indication.
The output relay K2 (terminals 72,74,73) on the trigger module is used for the "Ready" signal.

P8.1

Selection of operating mode for auto-reversing module
CMD OP

0

Function: Auto-reversing module is active.

1

Function: Torque direction I is disabled.

2

Function: Torque direction II is disabled.



Selection of operating mode for the analog output (Terminal 100) CMD AN AUS (± 8bit resolution)

0

Function: None
The output supplies 0 V

1

Function: Terminal 100 = Speed controller setpoint/actual value difference
The analog signal at terminal 100 (± 10 V) corresponds to the setpoint/actual value difference of the speed controller.
10 V = 200 % of the maximum speed x parameter E67

2

Function: Terminal 100 = Speed controller output
The analog signal at terminal 100 (± 10 V) corresponds to the speed controller output.
8 V = 100 % of the converter rated current x parameter E67

3

Function: Terminal 100 = Absolute value of current setpoint.
The analog signal at terminal 100 (0 to + 10 V) corresponds to the absolute value of the current setpoint.
8 V = 100 % of the converter rated current x parameter E67

4

Function: Terminal 100 = Ramp-function generator output.
The analog signal at terminal 100 (± 10 V) corresponds to the ramp-function generator output (setpoint for the speed controller)
10 V = 100 % of the maximum speed x parameter E67

5

Function: Terminal 100 = Spindle speed
The analog signal at terminal 100 (± 10 V) corresponds to the spindle speed (gear ratios P72, P73, P74, P75).
8 V = 100 % of the maximum speed x parameter E67

6

Function: Terminal 100 = Motor utilization
The analog signal at terminal 100 corresponds to the motor utilization.
8 V = 100 % utilization x parameter E67

$$\text{Utilization} = \frac{|EMF_{act}|}{EMF_{set}} \times \frac{|I_{act}|}{I_{limit}} \times 8V \quad \begin{matrix} I_{limit} = \text{currently active current limit} \\ EMF_{set} = P77 \end{matrix}$$

7

Function: Terminal 100 = Current controller integrator
The analog signal at terminal 100 (± 10 V) corresponds to the status of the current controller integrator.
10 V = 5.62 deg. (firing angle) x parameter E67

8

Function: Terminal 100 = e.m.f.
The analog signal at terminal 100 (± 10 V) corresponds to the e.m.f.
10 V = 510 V e.m.f. x parameter E67

9

Function: Terminal 100 = Diagnostic output
The analog signal at terminal 100 (± 10V) corresponds to the memory location which can be set by means of the diagnostic function (P51 = 99).
(See also P51)

10

Function: Terminal 100 = Absolute value of relevant current limit
The analog signal at terminal 100 corresponds to the absolute value of the currently selected current limit.
 $8\text{ V} = 100\% \text{ of converter rated current} \times \text{parameter E67}$

11

Function: Terminal 100 = Absolute value of actual speed
The analog signal at terminal 100 corresponds to the absolute value of the actual speed.
 $10\text{ V} = 100\% \text{ of maximum speed} \times \text{parameter E67}$

12

Function: Terminal 100 = Field current setpoint
The analog signal at terminal 100 corresponds to the field current setpoint.
 $10\text{ V} = (100\% \text{ of P76}) \times \text{parameter E67}$

13

Function: Terminal 100 = Torque setpoint
The analog signal at terminal 100 corresponds to the torque setpoint.
 $-8\text{ V} \dots +8\text{ V} = -100\% \times \text{parameter E67} \dots +100\% \times \text{parameter E67}$ of the theoretical motor torque at rated converter current and at the field current set in P76.

14

Function: Terminal 100 = calculated motor temperature rise
The analog signal at terminal 100 provides a measure for the motor temperature rise
 $10\text{ V} = (\text{Threshold for F13}) \times \text{parameter E67}$

15

Function: Terminal 100 = Speed setpoint directly at the speed controller input
The analog signal at terminal 100 corresponds to the speed setpoint directly at the speed controller input.
(Ramp generator output signal + additional setpoint for speed controller)
 $10\text{ V} = 100\% \text{ of maximum speed} \times \text{parameter E67}$

16

Function: Terminal 100 = Current setpoint, correctly signed
The analog signal at terminal 100 corresponds to the current setpoint after all current limitations.
 $8\text{ V} = 100\% \text{ rated current} \times \text{parameter E67}$

17

Function: Terminal 100 = Actual-current value, correctly signed
The analog signal at terminal 100 corresponds to the actual current value.
 $8\text{ V} = 100\% \text{ converter rated current} \times \text{parameter E67}$

Selection of operating mode for digital input 3 (terminal 81) CMD IN3

0

Function: None. The terminal is not interrogated in the program.

1

1) 2)

Function: Terminal 81 = JOGGING 1

H signal (+ 10 V to + 30 V):

The drive accelerates via the ramp-function generator (P14 = 0) or the speed controller (P14 = 1) to the jogging speed set in parameter P11.

L signal (open or < 4.5 V):

The drive decelerates via the ramp-function generator (P14 = 0) or the speed controller to $n = 0$, the controllers are disabled and the "Ready" signal disappears after 10 sec.

2

1) 2)

Function: Terminal 81 = JOGGING 2

H signal (+ 10 V to + 30 V):

The drive accelerates via the ramp-function generator (P14 = 0) or the speed controller (P14 = 1) to the jogging speed set in parameter P12.

L signal (open or < 4.5V):

The drive decelerates via the ramp-function generator (P14 = 0) or the speed controller to $n = 0$, the controllers are disabled and the "Ready" signal disappears after 10 sec.

3

Function: None, terminal 81 is not interrogated in the program.

4

Function: Terminal 81 = Ramp-function generator enable.

H signal (+ 10 V to + 30 V) at terminal 81 enables the ramp-function generator.

L signal (< 4.5 V or open) disables the ramp-function generator. The generator output is set to 0.

5

Function: Terminal 81 = Ramp-function generator stop.

H signal (+ 10 V to + 30 V) at terminal 81 stops the ramp-function generator. The output of the generator remains unchanged until the "Ramp-function generator stop" signal disappears again.

6

Function: Terminal 81 = $\overline{\text{OFF}}$.

L signal (< 4,5 V or open) at terminal 81 switches off the converter (controllers are disabled, the control angle shifted to α_W and the pulses suppressed after current = 0).

1) Important: Jogging modes 1 and 2 can be activated only when terminal 64 (drive enable) is open. The "READY" signal relay has a 10 sec. dropout delay.

2) Function „Creep“ (P13): Simultaneous selection of Jogging 1 (terminal 81) and Jogging 2 (terminal 111).

Important: „Creep“ mode can be activated regardless of the state of terminal 64!

7

Function: Terminal 81 = RAPID STOP.

L signal (<4,5 V or open) at terminal 81 switches the speed controller setpoint input to 0 and disconnects the drive after $n < n_{min1}$ has been reached. The "Ready" relay drops out.

An L signal at terminal 81 is stored internally.
The memory is reset if terminal 64 is opened.

8

Function: Terminal 81 = CURRENT LIMIT CHANGEOVER

When L signal (<4,5 V or open) is applied at terminal 81, the current limit values set via parameters P39 and P40 are used for the current limitation.

When H signal is applied, the values set via P41 and P42 are used if $n > n_{changeover}$ (P50)

9

Function: Terminal 81 = Changeover from n control to I control

L signal means speed-control operation of drive (unless I control has been activated via P89).

H signal means current-controlled operation of the drive.
Ramp-function generator remains operative.

10

Function: Terminal 81 = Fault memory resetting

H signal resets an existing fault signal
(corresponds to pressing of MODE key on basic unit).

11

Function: Terminal 81 = Switchover between master/slave drive mode

L signal: The drive acts as a master drive (i.e. n-controlled operation). Setpoint at terminals 56 and 24 (only if I-control is not selected in parameter P89).
The ramp-function generator is operative.

H signal: The drive acts as a slave drive (i.e. I-controlled operation). Setpoint at terminals 56 and 24, except when parameter P85 = 11 in which case setpoint signal from terminal 8. The ramp-function generator is inoperative ($T_H = T_R = 0$). When terminal 64 is opened, a zero current setpoint is not input until $n < n_{min1}$ (P21) is reached (ramp-down braking by master drive).

12

Function: Terminal 81 = Enable for "P/PI controller switchover if $|n_{act}| < \text{parameter E41}$ "

L signal: "P/PI controller switchover" function is active.
H signal: "P/PI controller switchover" function is not active.

13

Function: None, terminal 81 is not interrogated in the program.

14

Function: Terminal 81 = Enable for dv/dt injection

L signal: "dv/dt injection" function is active.
H signal: "dv/dt injection" function is not active.

Selection of operating mode for digital input 4 (terminal 111) CMD IN4

0

Function: None. Terminal 111 is not interrogated in the program.

1

1) 2)

Function: Terminal 111 = JOGGING 1

H signal (+ 10 V to + 30 V):

The drive accelerates via the ramp-function generator (P14 = 0) or the speed controller (P14 = 1) to the jogging speed set in parameter P11.

L signal (open or < 4.5 V):

The drive decelerates via the ramp-function generator (P14 = 0) or the speed controller to $n = 0$, the controllers are disabled and the "Ready" signal disappears after 10 sec.

2

1) 2)

Function: Terminal 111 = JOGGING 2

H signal (+ 10 V to + 30 V):

The drive accelerates via the ramp-function generator (P14 = 0) or the speed controller (P14 = 1) to the jogging speed set in parameter P12.

L signal (open or < 4.5 V):

The drive decelerates via the ramp-function generator (P14 = 0) or the speed controller to $n = 0$, the controllers are disabled and the "Ready" signal disappears after 10 sec.

3

Function: None, terminal 111 is not interrogated in the program.

4

Function: Terminal 111 = Ramp-function generator enable.

H signal (+ 10 V to + 30 V) at terminal 111 enables the ramp-function generator.

L signal (< 4.5 V or open) disables the ramp-function generator. The generator output is set to 0.

5

Function: Terminal 111 = Ramp-function generator stop.

H signal (+ 10 V to + 30 V) at terminal 111 stops the ramp-function generator.

The output of the generator remains unchanged until the "Ramp-function generator stop" signal disappears again.

6

Function: Terminal 111 = $\overline{\text{OFF}}$.

L signal (< 4.5 V or open) at terminal 111 switches the converter off (controllers are disabled, the control angle shifted according to α_w and the pulses suppressed after current = 0).

1) Important: Jogging modes 1 and 2 can be activated only when terminal 64 (drive enable) is open. The "READY" signal relay has a 10 sec. dropout delay.

2) Function „Creep“ (P13): Simultaneous selection of Jogging 1 (terminal 81) and Jogging 2 (terminal 111).

Important: „Creep“ mode can be activated regardless of the state of terminal 64!

7

Function: Terminal 111 = RAPID STOP.

L signal (<4.5 V or open) at terminal 111 switches the speed controller setpoint input to 0 and disconnects the drive after $n < n_{min1}$ has been reached. The "Ready" relay drops out.

An L signal at terminal 111 is stored internally.
The memory is reset if terminal 64 is opened.

8

Function: Terminal 111 = CURRENT LIMIT CHANGEOVER

When L signal (<4.5 V or open) is applied at terminal 111 the current limit values set via parameters P39 and P40 are used for the current limitation.

When H signal is applied, the values set via P41 and P42 are used if $n > n_{changeover}$ (P50)

9

Function: Terminal 111 = Changeover from n control to I control

L signal means speed-control operation of drive
(unless I control has been activated via P89).

H signal means current-controlled operation of the drive

10

Function: Terminal 111 = Fault memory resetting

H signal resets an existing fault signal
(corresponds to pressing of MODE key on basic unit).

11

Function: Terminal 111 = Switchover between master/slave drive mode

L signal: The drive acts as a master drive (i.e. n-controlled operation). Setpoint at terminals 56 and 24 (only if I-control is not selected in parameter P89).
The ramp-function generator is operative.

H signal: The drive acts as a slave drive (i.e. I-controlled operation). Setpoint at terminals 56 and 24, except when parameter P85 = 11 in which case setpoint signal from terminal 8. The ramp-function generator is inoperative ($T_H = T_R = 0$). When terminal 64 is opened, a zero current setpoint is not input until $n < n_{min1}$ (P21) is reached (ramp-down braking by master drive).

12

Function: Terminal 111 = Enable for "P/PI controller switchover if $|n_{act}| < \text{parameter E41}$ "

L signal: "P/PI controller switchover" function is active.

H signal: "P/PI controller switchover" function is not active.

13

Function: None, terminal 111 is not interrogated in the program.

14

Function: Terminal 111 = Enable for dv/dt injection

L signal: "dv/dt injection" function is active.

H signal: "dv/dt injection" function is not active.

Selection of operating mode for analog input (terminal 96) CMD A IN

0

Function: None. The analog value applied at terminal 96 is not used in the program.

1

Function: Terminal 96 = ADDITIONAL SETPOINT FOR SPEED CONTROLLER
The analog value applied at terminal 96 is interpreted as an additional speed setpoint and added to the ramp-function generator output.
[$-10V \times E02 : 100 \dots + 10V \times E02 : 100 = -100\% \dots + 100\%$]

2

Function: Terminal 96 = ADDITIONAL SETPOINT FOR CURRENT CONTROLLER
The analog value applied at terminal 96 is interpreted as an additional current setpoint and added to the speed controller output.
[$-10V \times E02 : 100 \dots + 10V \times E02 : 100 = -100\% \dots + 100\%$]

3

Function: Terminal 96 = POSITIVE CURRENT LIMIT
The absolute analog value applied at terminal 96 is interpreted as a positive current limit [$10 V \times E02 : 100 = \text{current limit 1 (maximum of P39 and P40)}$].

4

Function: Terminal 96 = NEGATIVE CURRENT LIMIT
The absolute analog value applied at terminal 96 is interpreted as a negative current limit [$10 V \times E02 : 100 = \text{current limit 1 (maximum of P39 and P40)}$].

5

Function: Terminal 96 = CURRENT LIMIT
The absolute analog value applied at terminal 96 is interpreted as a current limit [$10 V \times E02 : 100 = \text{current limit 1 (maximum of P39 and P40)}$].
The positive and negative current limit values are changed together.

6

Function: None
The analog value applied at terminal 96 is not used in the program.

7

Function: Terminal 96 = POSITIVE CURRENT LIMIT
The analog value applied at terminal 96 is interpreted as a positive current limit [$+ 10 V \times E02 : 100 = \text{current limit 1 (maximum of P39 and P40)}$].
A negative value signifies a lower current limit for torque direction II.

8

Function: Terminal 96 = NEGATIVE CURRENT LIMIT

The analog value applied at terminal 96 is interpreted as a negative current limit [$10\text{ V} \times \text{E02} : 100 = \text{current limit 1 (maximum of P39 and P40)}$]. A negative value signifies a lower current limit for torque direction I.

9

Function: Terminal 96 = FIELD CURRENT SETPOINT

The absolute analog value applied at terminal 96 is used as the field current setpoint. It refers to P76.

[$10\text{V} \times \text{E02} : 100 = \text{field current as per P76}$]

Constant-EMF control is ineffective.

10

Function: Terminal 96 = ACTUAL E.M.F. VALUE

Input for external e.m.f. measurement

[$-10\text{V} \times \text{E02} : 100 \dots + 10\text{V} \times \text{E02} : 100 = -\text{EMF as per P98} \dots + \text{EMF as per P98}$]

11

Function: Terminal 96 = CURRENT SETPOINT [$10\text{V} \dots \text{Converter rated current}$]

If the drive has been set for current-controlled operation with a user-assignable terminal (e.g. terminal 81, see P83 = 9), the current setpoint signal is taken from terminal 96 while terminals 56 and 24 have no effect.

P85

Selection of operating mode for output of actual current value at terminal 16

CMD I OUT

0

Function: The actual current value output at terminal 16 is correctly signed.

1

Function: The absolute value of the actual current is output at terminal 16.

2

Function: The actual current value output at terminal 16 is correctly signed, but inverted.

3

Function: The absolute value of the actual current is output at terminal 16. but with a negative sign.

X X X

0

Function "Restart":

In the event of a phase failure, the fault is stored immediately and the drive tripped.

Function "Fault acknowledgement":

The fault indications must be acknowledged prior to restart by pressing the MODE key on the device.

1

Function "Restart":

Automatic restart in the event of phase failure. In this case, the unit is restarted automatically when the phase recovers within approx. 400 ms.

Function "Fault acknowledgement":

The fault indications must be acknowledged prior to restart by pressing the MODE key on the converter.

2

Function "Restart":

In the event of a phase failure, the fault is stored immediately and the drive tripped.

Function "Fault acknowledgement":

The unit can be restarted by activating the DRIVE ENABLE terminal in the case of the following faults

(Acknowledgement on the converter is NOT necessary):

F04 Phase failure, mains fuse

F05 Undervoltage

F12 $I > 300\%$

Actual current value $> 300\%$ of rated current

F13 I^2t monitoring system has operated

F14 Excitation current monitoring

F21 FIRING PULSE CURRENT INTERRUPTION

(A2-X1 trigger module: Terminal 700 not connected to terminal 763)

The fault indication remains on, but stops flashing. It must be cancelled by pressing the MODE key on the unit.

3

Function "Restart":

Automatic restart in the event of phase failure. In this case, the unit is restarted automatically when the phase recovers within approx. 400 ms.

Function "Fault acknowledgement":

As described for setting 2.

x x x

0

All parameter contents are transferred immediately to the EEPROM when a modification is made.

When a mains failure occurs during operation, the unit outputs fault indication F04 after recovery of the power supply.

This setting may be used only during commissioning in order to protect the EEPROM against damage caused by repeated writing.

Set P87 to x3x after commissioning!

1) 2)

Only the contents of parameters P87 and P52 are stored in the EEPROM when a modification is made. All other parameters and fault indications are not stored.

Fault indication F34 ("EEPROM fault") is suppressed.

2) 1) 2)

Only the contents of parameters P87 and P52 and fault indications are stored in the EEPROM when a modification is made.

Fault indication F34 ("EEPROM fault") is suppressed.

3) 1)

Parameter contents are stored immediately in the EEPROM when a modification is made; only fault indications F04 and F05 are not stored when the electronics supply voltage fails. Selection of this operating mode is recommended.

1) Important: In the event of failure of the electronics power supply voltage during operation (terminal 64 = 1), the motor may restart automatically after system recovery and active enabling signals.

2) Important: When the EEPROM disable is active (P87 = x1x or x2x), it is also possible to activate a hardware write protect function (no further modifications of any type are stored in the EEPROM).

To do this, make the following changes on A1200-L13 electronics module

Up to version 03, C1, ...: Open jumper BR 5

From version 04, D1, ... onwards: Insert plug-in jumper EA-EB-EC in position EA-EB.

The jumpers may be relocated only with the converter not connected to the supply.

When the EEPROM disable is active (P87 = x1x or x2x) and the electronics supply switched on, it is possible to modify the parameter contents. Such modifications also become effective immediately. The modified parameter contents are however stored only in the RAM and are lost when the electronics supply is disconnected.

P88

Selection of operating mode for automatic field current reduction CMD FIELD RED

0

Function: The field current setpoint set via parameter P76 is not reduced automatically.

1

Function: Automatic field current reduction (standstill excitation).
The excitation current is reduced to the value set via parameter P96 (% of P76) 10 sec. after the "Ready" signal has disappeared (terminal 63, terminal 64 open or fault).
If the drive is restarted, the field current automatically assumes the setpoint value selected in parameter P76.

P89

Selection of operating mode for speed controller CMD N

X X X

0

Function: The speed controller is active.

1

Function: Integrator disable
The speed controller P component is enabled and the integrator disabled. (The bit is also set internally when the current limit is reached).

2

Function: Disable
The speed controller is disabled. The value set via parameter P29 is output at the speed controller output.

3

Function: Current control (E70 = xx0) or torque control (E70 = xx1) selection
The speed controller is blocked. The setpoint applied at terminals 56 and 14 is interpreted as current setpoint or as torque setpoint (depending on the setting of parameter E70)
(positive setpoint = >MI = >positive actual-current value).
10V x E01 : 100 ≙ converter rated current if current control is active
10V x E01 : 100 ≙ Rated motor current x rated converter current: rated motor current if torque control is active

P89

Selection of operating mode for speed controller CMD N

X X X

Adaptation 1) of the speed controller reset time ($T_N \times$ factor x) during ramp-up/ramp-down 2)

0	Factor 1 (i.e. no adaptation)
3	Factor 3
2	Factor 10
3	Factor 30
9	Factor 100
5	Factor 300
6	Factor 1000
7	Factor 0 (i.e. the n controller integrator is set to 0)

- 1) In order to reduce the transient speed overshoot after a setpoint step change at the ramp generator input.
- 2)
 - Self-adaptation acts only if ramp generator is active ($P16 \neq 0, P17 \neq 0$).
 - The reset time is limited to 100 sec as a maximum.

P90

Selection of operating mode for field CMD FIELD

X X X

0

Function: Normal operation

Combination of operating modes 1 and 2; normal operating mode if the field characteristic measurement has been performed.

The field characteristic measurement sets this digit to zero automatically.

1

Function: Field with speed precontrol according to characteristic only.

2

Function: E.m.f.-controlled field only

If the armature current drops below 2 % of the rated converter current, the field is kept constant at its instantaneous value.

Important: The tachopotentiometer setting and the parameters E.M.F. SET (P77), $U_{A\text{ RATED}}$ (E77) and $I_{\text{FIELD SET}}$ (P76) must not be changed after the field characteristic measurement has been carried out.

3

Function: P77 (e.m.f. setpoint) is used as the e.m.f. setpoint in field-weakening mode. Parameter E77 is not operative.

4

Function: The e.m.f. setpoint is calculated from parameter E77 (armature voltage) during the characteristic measurement and stored in parameter P77.

It is advisable to use this setting if the armature resistance R_A is not known.

P91

Suspension of monitoring functions:

The fault indications of the SIMODRIVE unit can be switched off via parameter P91. Further information on request.

Selection of operating mode for C axis
CMD VS

X X X

Type of adaption

- 0 Function: The n-dependent and the I_A-dependent speed controller adaptations as well as the adaption based on the setpoint/actual value difference are active.
- 1 Function: Only the n-dependent speed controller adaption is active.
- 2 Function: Only the I_A-dependent speed controller adaption is active.
- 3 Function: Only the speed controller adaption based on the setpoint/actual value difference is active.
- 4 Parameters P56 and P57 are always operative.

Type of controller configuration in C axis mode

- 0 Speed controller with secondary current controller and e.m.f. precontrol
- 1 Speed controller with current-limiting take-over controller (Important: Parameters P62 and P93 are inoperative in this operating mode)

Type of n-dependent adaption

- 0 n-dependent adaption
Dependent on actual speed value of main spindle
(The speed thresholds P58 and P59 refer to n_{max} in the main spindle drive mode [adjustment with potentiometers R1 and R2])
- 1 n-dependent adaption
Dependent on C-axis setpoint (available only from version 05 onwards of A1210 module)
(The speed thresholds P58 and P59 refer to n_{max} in the C axis mode [adjustment with potentiometer R11])

Adaptation in C axis mode:

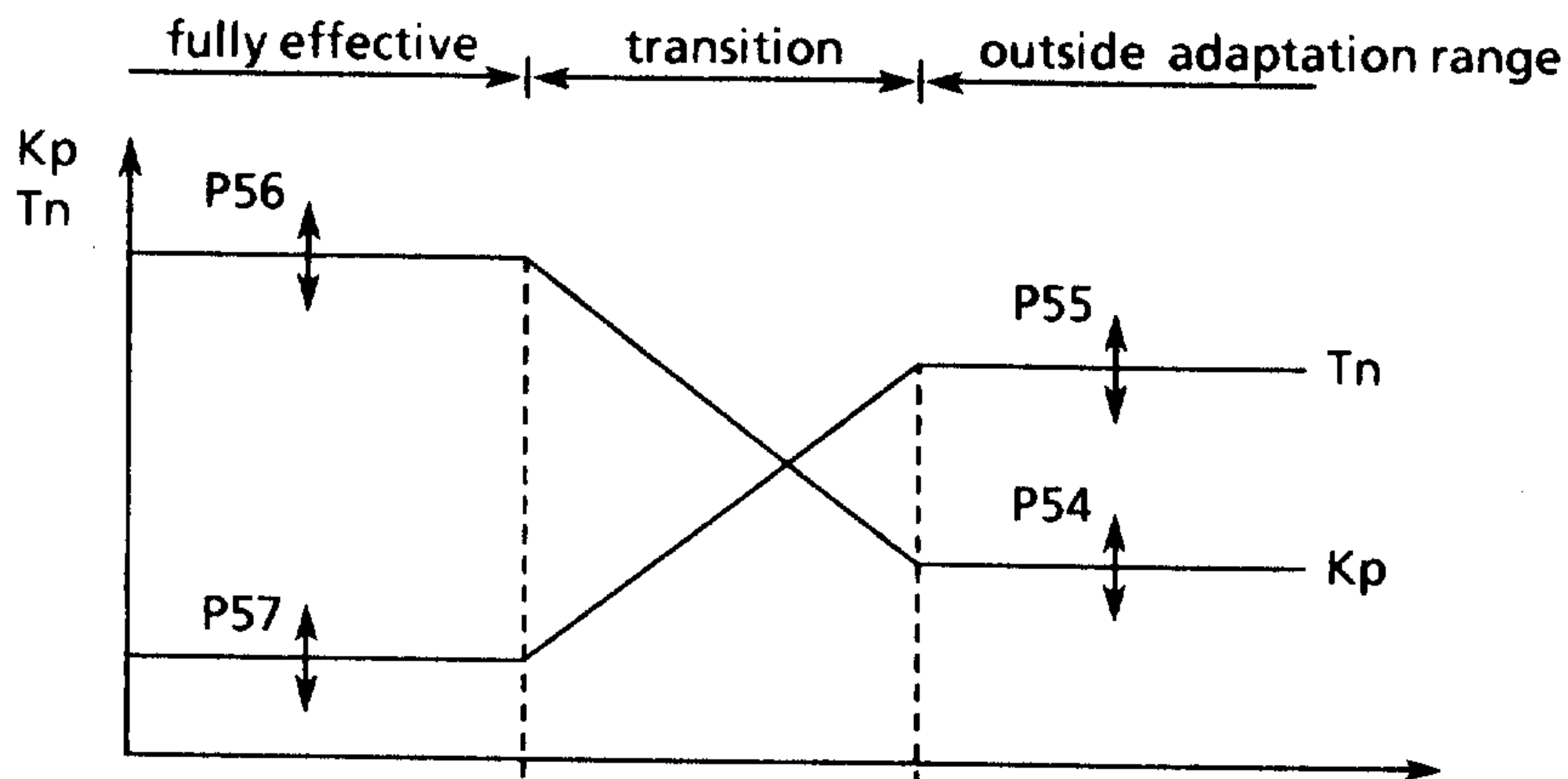

Actual-speed value	: n_1 (P58)	n_2 (P59)	n_{act}	$\leftarrow P92 = 0 X 1$
Actual-current value	: I_1 (P53)	I_2 (E15)	I_{act}	$\leftarrow P92 = X X 2$
Speed deviation	: Δn_1 (E09)	Δn_2 (E10)	Δn	$\leftarrow P92 = X X 3$
C axis speed setpoint	: n_{C1} (P58)	n_{C2} (P59)	n_{Cset}	$\leftarrow P92 = 1 X 1$

Control parameters

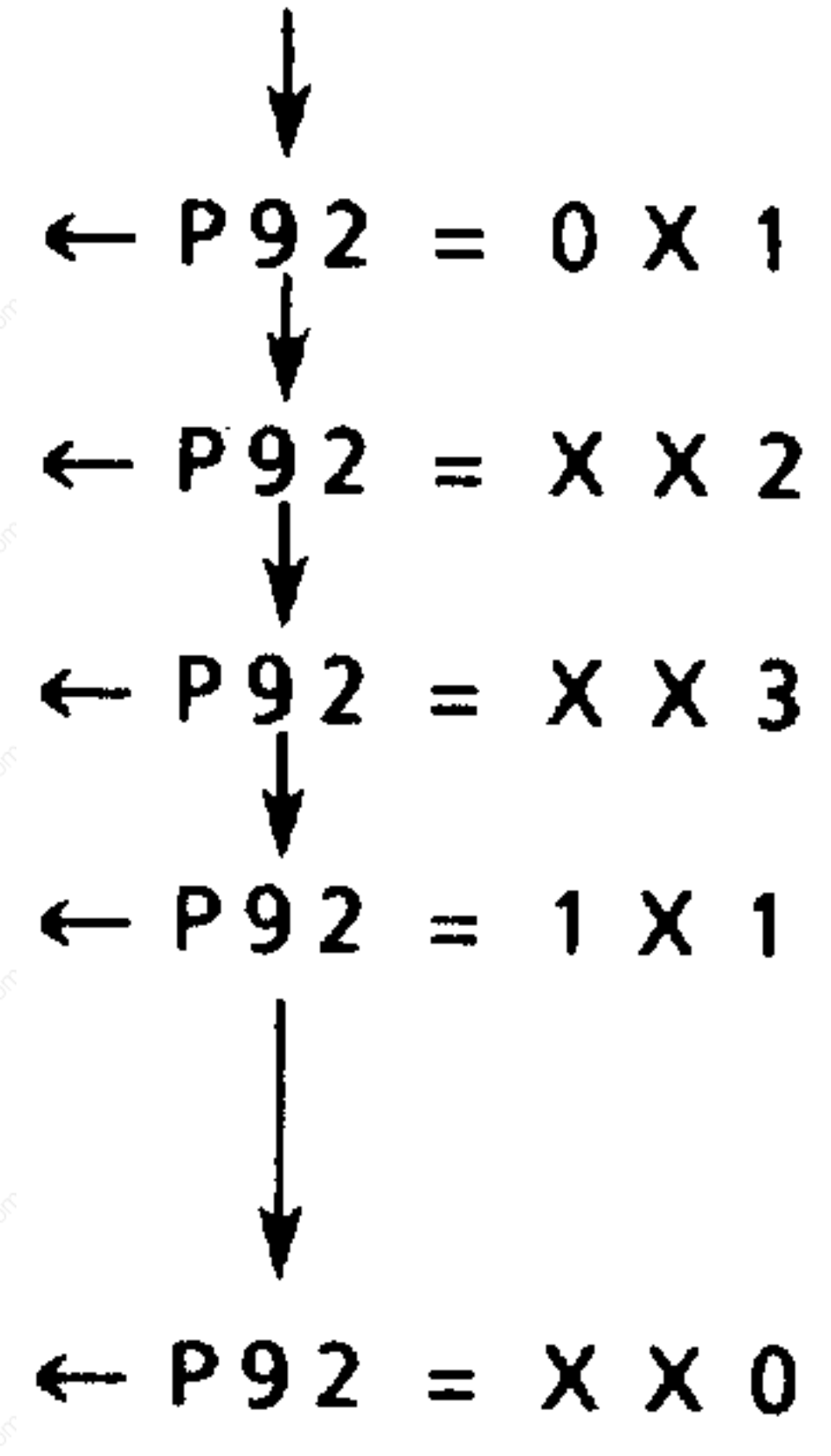

Adaptation

Combination of adaption

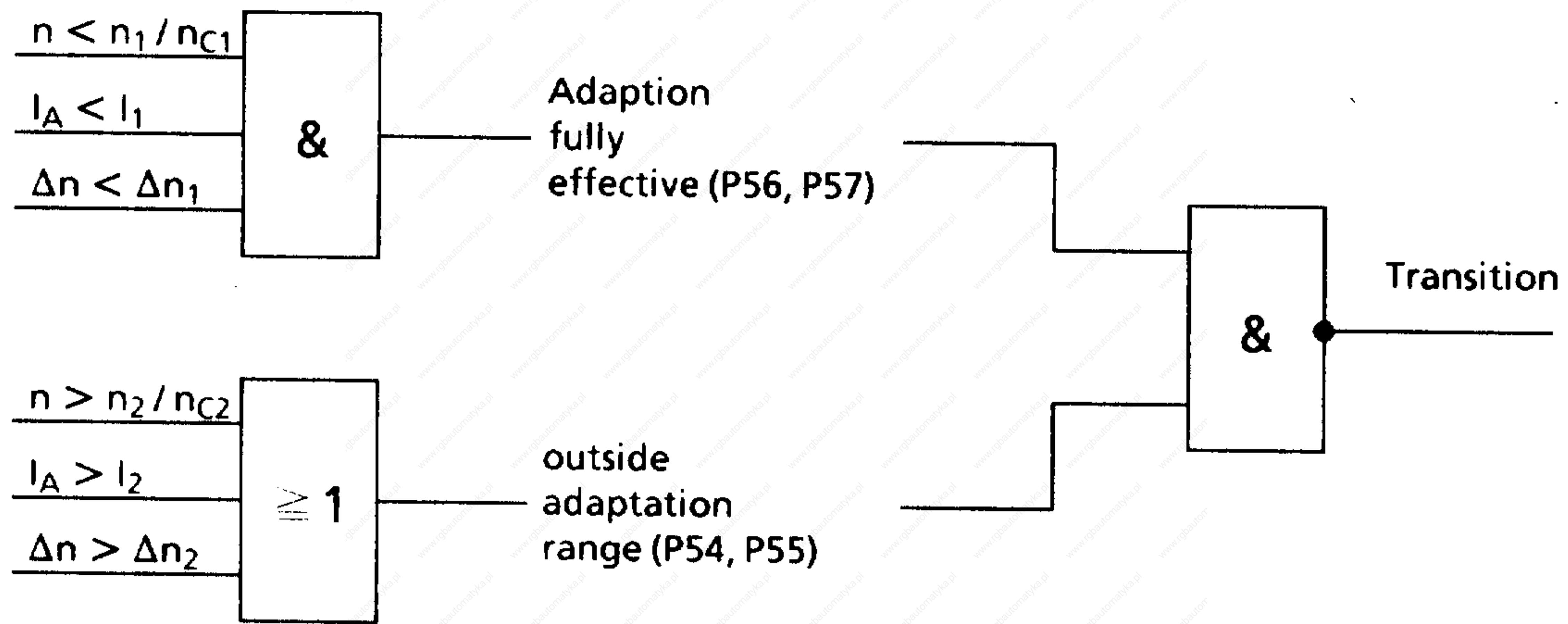

**Example: Schematic illustrating controller adaptation in C axis mode
Combination of speed-dependent and current-dependent adaptation**

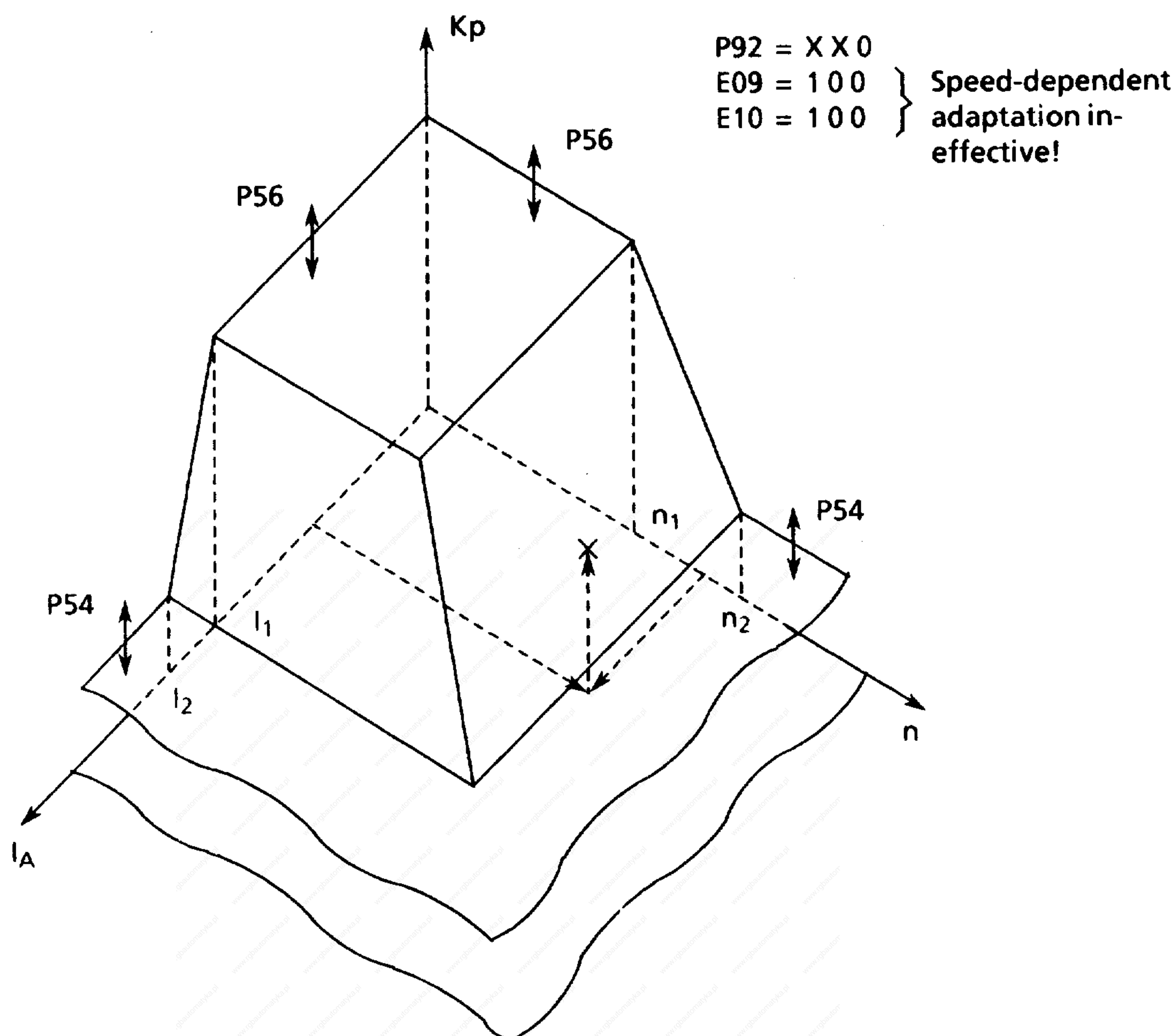

Notes on the C axis mode:

In the C axis mode, the EMF is always derived from the tacho voltage in order to prevent the break point that would otherwise occur on transition from the calculated EMF to that derived from the tacho voltage. Only in the weak-field range, the calculated EMF is used nevertheless. The following functions and parameters are ineffective if in the C axis mode:

P93 (changeover threshold for auto-reversing module), fixed value 0 is used instead

E68, E70 torque limitation, torque control

P16... P19, E16... E19 ramp-function generator; fixed value 0 is used instead

P60, P61 adaptation factors; fixed value 1.0 is used instead

All terminals influencing the ramp-function generator (e.g. terminal 62)

P62 Current build-up integrator; fixed value 0 is used instead

P29 Digital additional current setpoint; fixed value 0 is used instead

P89 = 2 or 3 (n controller inhibit or current control); fixed value 0 is used instead

Analog additional current setpoint applied at user-assignable terminal 100 if P85 = 1; fixed value 0 is used instead

Analog additional speed setpoint applied at user-assignable analog terminal 100 if P85 = 2; fixed value 0 is used instead

E41 (P/PI control switchover threshold); fixed value 0 is used instead

Selection of operating mode for serial interface
CMD SER

X X X

Baud rate: (asynchronous)

- 00 ... 110 Baud
- 01 ... 150 Baud
- 10 ... 300 Baud
- 11 ... 600 Baud
- 20 ... 1200 Baud
- 21 ... 1800 Baud
- 30 ... 2400 Baud
- 31 ... 3600 Baud
- 40 ... 4800 Baud
- 41 ... 9600 Baud

Transmission format:

- 00 ... 10-bit frame
(1 start bit, 8 data bits, 1 stop bit), no parity-bit generation
- 01 ... 10-bit frame
(1 start bit, 7 data bits + 1 parity bit, 1 stop bit), even parity
- 10 ... 11-bit frame
(1 start bit, 9 data bits, 1 stop bit), no parity-bit generation
- 11 ... 11-bit frame
(1 start bit, 8 data bits + 1 parity bit, 1 stop bit), even parity

Output:

- 00 ... Once-only transmission of parameters; start via P51
- 01 ... Continuous output of status and fault messages in plaintext to an alpha-numeric display (e.g. Text display S40-116-A of Messr. Siebert)
- 10 ... Continuous output of status and fault messages in plaintext to a PG635/PG675/PG685 or a printer
- 11 ... unassigned, for later use
- 20 ... unassigned, for later use
- 21 ... Parameter setting also possible on-line
(only for works-internal testing purposes)

P98

Input of the converter rated supply voltage

Scaling factor for the AC input voltage to the power section

$$P98 = 380 \times \ddot{u}$$

$$\ddot{u} = \frac{\text{AC input voltage to power section}}{\text{AC input voltage to electronic power supply}}$$

$1/\ddot{u}$ equals the ratio of a matching transformer for the input voltage to the electronics power supply.

This means:

- If the input voltages to the power section and to the electronics power supply are identical (which is only possible with 380V + 20%-15% or 415V + 10%-22%), P98 must always be set to 380V.
- If the AC input voltage to the power section differs from that to the electronics power supply (e.g. in the case of converters for 500 V armature circuit voltage), the value to be entered in P98 is $380 \times \ddot{u}$.

Works setting:

P98 = 380 bei 6RA27... - DV... (380V units)

P98 = 500 bei 6RA27... - GV... (500V units)

Note: This setting is not changed during bootstrap loading!
In case of a software change, the correct value must therefore be input by hand prior to bootstrap loading!

P99

Indication of software version:

The software version is indicated in Parameter P99.

X X . X

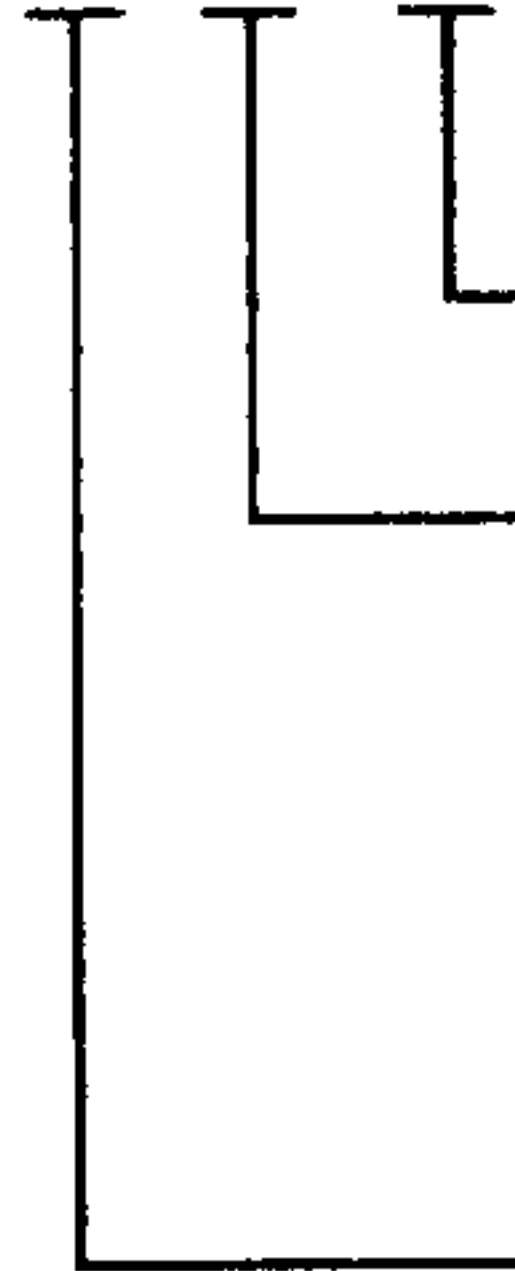

Software version number

Software version number

} These two digits cannot be changed by means of parameterization. They indicate the software version.

1 SIMOREG 1Q (6RA22xx-xxS2x)

2 SIMOREG 4Q (6RA22xx-xxV6x)

3 SIMODRIVE (6RA27...)

The parameter is set in the factory and is not changed during bootstrap loading. If this parameter is changed manually, then the electronics power supply must be switched off and switched on again afterwards.

Important: If a software change is carried out, this parameter must be set to the correct value prior to bootstrap loading!

800

**Equipment version (options)
CMD VERSION**

0

Basic unit without additional option

3

Basic unit with A1210-L20 . . . L23, -L41 supplementary module

2

Basic unit with spindle positioning
(A1211 supplementary module + C98130-A1070-A1 power supply module)

5

Not assigned (for subsequent applications)

5

Not assigned (for subsequent applications)

5¹⁾

Basic unit with SINEC-L1 interface module
(Z1001 supplementary module)

7¹⁾

Basic unit with SINEC-L1 interface module
(Z1001 supplementary module)

8¹⁾

Basic unit with supplementary module (Z1004, Z1011) coupled via dual port RAM;
transmission of a 4-word protocol

9¹⁾

Basic unit with supplementary module (Z1004) coupled via dual port RAM;
transmission of a 10-word protocol

1) Not provided for SIMODRIVE

8	Not assigned (for subsequent applications)
6	Not assigned (for subsequent applications)
0	Not assigned (for subsequent applications)
8	Not assigned (for subsequent applications)
0	Not assigned (for subsequent applications)
1	Basic unit with A1210-L1 supplementary module

Every digit on the three-digit seven-segment display signifies a hardware configuration in accordance with the above list. It is thus possible to combine a maximum of three different options.

Example: Display on E00 = 16
6 ... Z1001 SINEC-L1 interface module and
1 ... A1210 supplementary module

i.e. this is a unit with an A1210 supplementary module and Z1001 an interface module for linking to the SINEC-L1.

Important: This parameter is not changed during bootstrap loading!
When the software is changed, this parameter must therefore be set to the correct value by hand prior to bootstrap loading!

E03

Selection of filter type
CMD FILTER

X X X

0

Function: The input of the speed controller (setpoint/actual value difference) is taken through a first-order filter. Filter time constant adjustable via P20. Band-stop filters 1 and 2 are inoperative.

1

Function: The input to the speed controller (setpoint/actual value difference) is taken through two 2nd order band-stop filters which are adjustable via Parameters E04, E05, E06, E07, E08 (for band-stop 1) and U50, U51, U52, U53 (for band-stop 2). The band-stop filters are operative in the main spindle and C axis modes.

0

No meaning for SIMODRIVE converters

1

No meaning for SIMODRIVE converters

E04

Suppression quality of band-stop filter
CMD QUALITY

0

Function: Q factor of band-stop filter = 0.5

1

Function: Q factor of band-stop filter = 1

2

Function: Q factor of band-stop filter = 2

3

Function: Q factor of band-stop filter = 3

E20

Selection of operating mode for motor potentiometer function
CMD MOTP

0

Function: No storage of speed setpoint when the unit is switched off (i.e. terminal 64 open or RAPID STOP or response of a monitoring circuit)

1

Function: Storage of speed setpoint
(This parameter is operative only if E29 = 1)

822

Selection of function for the digital input (terminal 117) CMD 117

0	No function
1 ¹⁾	Jogging (setpoint of E51 is injected)
2	Setpoint (setpoint of E51 is injected)
3	Field current reduction
4	Ramp-function generator enable
5	Ramp-function generator stop
6	TH, TR = 0 (The ramp-up and ramp-down times become zero; parameters P60 and P61 become <u>inoperative</u>)
7	Setpoint reduction
8	Current limit changeover
9	Offset
10	Gear speed II (standard with main spindle applications)
11	Gear speed III
12	Gear speed IV
13	Oscillation
14	Feed mode (C axis)
15	Motor potentiometer manual/automatic
16	Motor potentiometer higher
17	Motor potentiometer lower
18	Motor potentiometer clockwise/anticlockwise
19	Changeover from n control to l control
20	Additive setpoint injection at ramp-generator input (Setpoint form E51 is injected)
21	Additive setpoint injection at speed controller input (Setpoint form E51 is injected)

1) Important: The jogging mode can be activated only when terminal 64 (drive enable) is open.
The "READY" signal relay has a 10 sec. dropout delay.

22

Function: Terminal 117 = Switchover between master/slave drive mode
 L signal: The drive acts as a master drive (i.e. n-controlled operation). Setpoint at terminals 56 and 24 (only if I-control is not selected in parameter P89). The ramp-function generator is operative.
 H signal: The drive acts as a slave drive (i.e. I-controlled operation). Setpoint at terminals 56 and 24, except when parameter P85 = 11 in which case setpoint signal from terminal 8. The ramp-function generator is inoperative ($T_H = T_R = 0$). When terminal 64 is opened, a zero current setpoint is not input until $n < n_{min1}$ (P21) is reached (ramp-down braking by master drive).

23

Function: Terminal 117 = Enable for "P/PI controller switchover if $|n_{act}| < \text{parameter E41}$ "
 L signal: "P/PI controller switchover" function is active.
 H signal: "P/PI controller switchover" function is not active.

24

Function: Terminal 117 = Enable for dv/dt injection
 L signal: "dv/dt injection" function is active.
 H signal: "dv/dt injection" function is not active.

E23

Selection of function for the digital input (terminal 118)
 CMD 118

0

No function

1)

Jogging (setpoint of E52 is injected)

2

Setpoint (setpoint of E52 is injected)

3

Field current reduction

4

Ramp-function generator enable

5

Ramp-function generator stop

6

$T_H, T_R = 0$ (The ramp-up and ramp-down times become zero; parameters P60 and P61 become inoperative)

7

Setpoint reduction

8

Current limit changeover

9

Offset

9

1) Important: The jogging mode can be activated only when terminal 64 (drive enable) is open. The "READY" signal relay has a 10 sec. dropout delay.

10	Gear speed II (standard with main spindle applications)
11	Gear speed III
12	Gear speed IV
13	Oscillation
14	Feed mode (C axis)
15	Motor potentiometer manual/automatic
16	Motor potentiometer higher
17	Motor potentiometer lower
18	Motor potentiometer clockwise/anticlockwise
19	Changeover from n control to I control
20	Additive setpoint injection at ramp-generator input (Setpoint form E52 is injected)
21	Additive setpoint injection at speed controller input (Setpoint form E52 is injected)
22	Function: Terminal 118 = Switchover between master/slave drive mode L signal: The drive acts as a master drive (i.e. n-controlled operation). Setpoint at terminals 56 and 24 (only if I-control is not selected in parameter P89). The ramp-function generator is operative. H signal: The drive acts as a slave drive (i.e. I-controlled operation). Setpoint at terminals 56 and 24, except when parameter P85 = 11 in which case setpoint signal from terminal 8. The ramp-function generator is inoperative ($T_H = T_R = 0$). When terminal 64 is opened, a zero current setpoint is not input until $n < n_{min1}$ (P21) is reached (ramp-down braking by master drive).
23	Function: Terminal 118 = Enable for "P/PI controller switchover if $ n_{act} < \text{parameter E41}$ " L signal: "P/PI controller switchover" function is active. H signal: "P/PI controller switchover" function is not active.
24	Function: Terminal 118 = Enable for dv/dt injection L signal: "dv/dt injection" function is active. H signal: "dv/dt injection" function is not active.

E24

Selection of function for the digital input (terminal 119) CMD 119

0	No function
1 ¹⁾	Jogging (setpoint of E53 is injected)
2	Setpoint (setpoint of E53 is injected)
3	Field current reduction
4	Ramp-function generator enable
5	Ramp-function generator stop
6	TH, TR = 0 (The ramp-up and ramp-down times become zero; parameters P60 and P61 become <u>inoperative</u>)
7	Setpoint reduction
8	Current limit changeover
9	Offset
10	Gear speed II (standard with main spindle applications)
11	Gear speed III
12	Gear speed IV
13	Oscillation
14	Feed mode (C axis)
15	Motor potentiometer manual/automatic
16	Motor potentiometer higher
17	Motor potentiometer lower
18	Motor potentiometer clockwise/anticlockwise
19	Changeover from n control to l control
20	Additive setpoint injection at ramp-generator input (Setpoint form E53 is injected)
21	Additive setpoint injection at speed controller input (Setpoint form E53 is injected)

1) Important: The jogging mode can be activated only when terminal 64 (drive enable) is open. The "READY" signal relay has a 10 sec. dropout delay.

22

Function: Terminal 119 = Switchover between master/slave drive mode

L signal: The drive acts as a master drive (i.e. n-controlled operation). Setpoint at terminals 56 and 24 (only if I-control is not selected in parameter P89). The ramp-function generator is operative.

H signal: The drive acts as a slave drive (i.e. I-controlled operation). Setpoint at terminals 56 and 24, except when parameter P85 = 11 in which case setpoint signal from terminal 8. The ramp-function generator is inoperative ($T_H = T_R = 0$). When terminal 64 is opened, a zero current setpoint is not input until $n < n_{min1}$ (P21) is reached (ramp-down braking by master drive).

23

Function: Terminal 119 = Enable for "P/PI controller switchover if $|n_{act}| < \text{parameter E41}$ "

L signal: "P/PI controller switchover" function is active.

H signal: "P/PI controller switchover" function is not active.

24

Function: Terminal 119 = Enable for dv/dt injection

L signal: "dv/dt injection" function is active.

H signal: "dv/dt injection" function is not active.

E25

Selection of function for the digital input (terminal 60)
CMD 60

0

No function

1¹⁾

Jogging (setpoint of E54 is injected)

2

Setpoint (setpoint of E54 is injected)

3

Field current reduction

4

Ramp-function generator enable

5

Ramp-function generator stop

6

$T_H, T_R = 0$ (The ramp-up and ramp-down times become zero; parameters P60 and P61 become inoperative)

7

Setpoint reduction

8

Current limit changeover

9

Offset

1) Important: The jogging mode can be activated only when terminal 64 (drive enable) is open. The "READY" signal relay has a 10 sec. dropout delay.

10	Gear speed II (standard with main spindle applications)
11	Gear speed III
12	Gear speed IV
13	Oscillation
14	Feed mode (C axis)
15	Motor potentiometer manual/automatic
16	Motor potentiometer higher
17	Motor potentiometer lower
18	Motor potentiometer clockwise/anticlockwise
19	Changeover from n control to I control
20	Additive setpoint injection at ramp-generator input (Setpoint form E54 is injected)
21	Additive setpoint injection at speed controller input (Setpoint form E54 is injected)
22	Function: Terminal 60 = Switchover between master/slave drive mode L signal: The drive acts as a master drive (i.e. n-controlled operation). Setpoint at terminals 56 and 24 (only if I-control is not selected in parameter P89). The ramp-function generator is operative. H signal: The drive acts as a slave drive (i.e. I-controlled operation). Setpoint at terminals 56 and 24, except when parameter P85 = 11 in which case setpoint signal from terminal 8. The ramp-function generator is inoperative ($T_H = T_R = 0$). When terminal 64 is opened, a zero current setpoint is not input until $n < n_{min1}$ (P21) is reached (ramp-down braking by master drive).
23	Function: Terminal 60 = Enable for "P/PI controller switchover if $ n_{act} < \text{parameter E41}$ " L signal: "P/PI controller switchover" function is active. H signal: "P/PI controller switchover" function is not active.
24	Function: Terminal 60 = Enable for dv/dt injection L signal: "dv/dt injection" function is active. H signal: "dv/dt injection" function is not active.

825

Selection of function for the digital input (terminal 61) CMD 61

0

No function

1¹⁾

Jogging (setpoint of E55 is injected)

2

Setpoint (setpoint of E55 is injected)

3

Field current reduction

4

Ramp-function generator enable

5

Ramp-function generator stop

6

TH, TR = 0 (The ramp-up and ramp-down times become zero; parameters P60 and P61 become inoperative)

7

Setpoint reduction

8

Current limit changeover

9

Offset

10

Gear speed II (standard with main spindle applications)

11

Gear speed III

12

Gear speed IV

13

Oscillation

14

Feed mode (C axis)

15

Motor potentiometer manual/automatic

16

Motor potentiometer higher

17

Motor potentiometer lower

18

Motor potentiometer clockwise/anticlockwise

19

Changeover from n control to I control

20

Additive setpoint injection at ramp-generator input
(Setpoint form E55 is injected)

21

Additive setpoint injection at speed controller input
(Setpoint form E55 is injected)

1) Important: The jogging mode can be activated only when terminal 64 (drive enable) is open.
The "READY" signal relay has a 10 sec. dropout delay.

22

Function: Terminal 61 = Switchover between master/slave drive mode
 L signal: The drive acts as a master drive (i.e. n-controlled operation). Setpoint at terminals 56 and 24 (only if I-control is not selected in parameter P89). The ramp-function generator is operative.
 H signal: The drive acts as a slave drive (i.e. I-controlled operation). Setpoint at terminals 56 and 24, except when parameter P85 = 11 in which case setpoint signal from terminal 8. The ramp-function generator is inoperative ($T_H = T_R = 0$). When terminal 64 is opened, a zero current setpoint is not input until $n < n_{min1}$ (P21) is reached (ramp-down braking by master drive).

23

Function: Terminal 61 = Enable for "P/PI controller switchover if $|n_{act}| < \text{parameter E41}$ "
 L signal: "P/PI controller switchover" function is active.
 H signal: "P/PI controller switchover" function is not active.

24

Function: Terminal 61 = Enable for dv/dt injection
 L signal: "dv/dt injection" function is active.
 H signal: "dv/dt injection" function is not active.

E27

Selection of function for the digital input (terminal 107)
 CMD 107

0

No function

1¹⁾

Jogging (setpoint of E56 is injected)

2

Setpoint (setpoint of E56 is injected)

3

Field current reduction

4

Ramp-function generator enable

5

Ramp-function generator stop

6

$T_H, T_R = 0$ (The ramp-up and ramp-down times become zero; parameters P60 and P61 become inoperative)

7

Setpoint reduction

8

Current limit changeover

9

Offset

1) Important: The jogging mode can be activated only when terminal 64 (drive enable) is open. The "READY" signal relay has a 10 sec. dropout delay.

20

Gear speed II (standard with main spindle applications)

21

Gear speed III

22

Gear speed IV

23

Oscillation

24

Feed mode (C axis)

25

Motor potentiometer manual/automatic

26

Motor potentiometer higher

27

Motor potentiometer lower

28

Motor potentiometer clockwise/anticlockwise

29

Changeover from n control to I control

20

Additive setpoint injection at ramp-generator input
(Setpoint from E56 is injected)

21

Additive setpoint injection at speed controller input
(Setpoint from E56 is injected)

22

Function: Terminal 107 = Switchover between master/slave drive mode
L signal: The drive acts as a master drive (i.e. n-controlled operation). Setpoint at terminals 56 and 24 (only if I-control is not selected in parameter P89). The ramp-function generator is operative.
H signal: The drive acts as a slave drive (i.e. I-controlled operation). Setpoint at terminals 56 and 24, except when parameter P85 = 11 in which case setpoint signal from terminal 8. The ramp-function generator is inoperative ($T_H = T_R = 0$). When terminal 64 is opened, a zero current setpoint is not input until $n < n_{min1}$ (P21) is reached (ramp-down braking by master drive).

23

Function: Terminal 107 = Enable for "P/PI controller switchover if $|n_{act}| < \text{parameter E41}$ "
L signal: "P/PI controller switchover" function is active.
H signal: "P/PI controller switchover" function is not active.

24

Function: Terminal 107 = Enable for dv/dt injection
L signal: "dv/dt injection" function is active.
H signal: "dv/dt injection" function is not active.

E28

Selection of function for the relay outputs (K5, K6, K8) CMD REL 1210

X X X

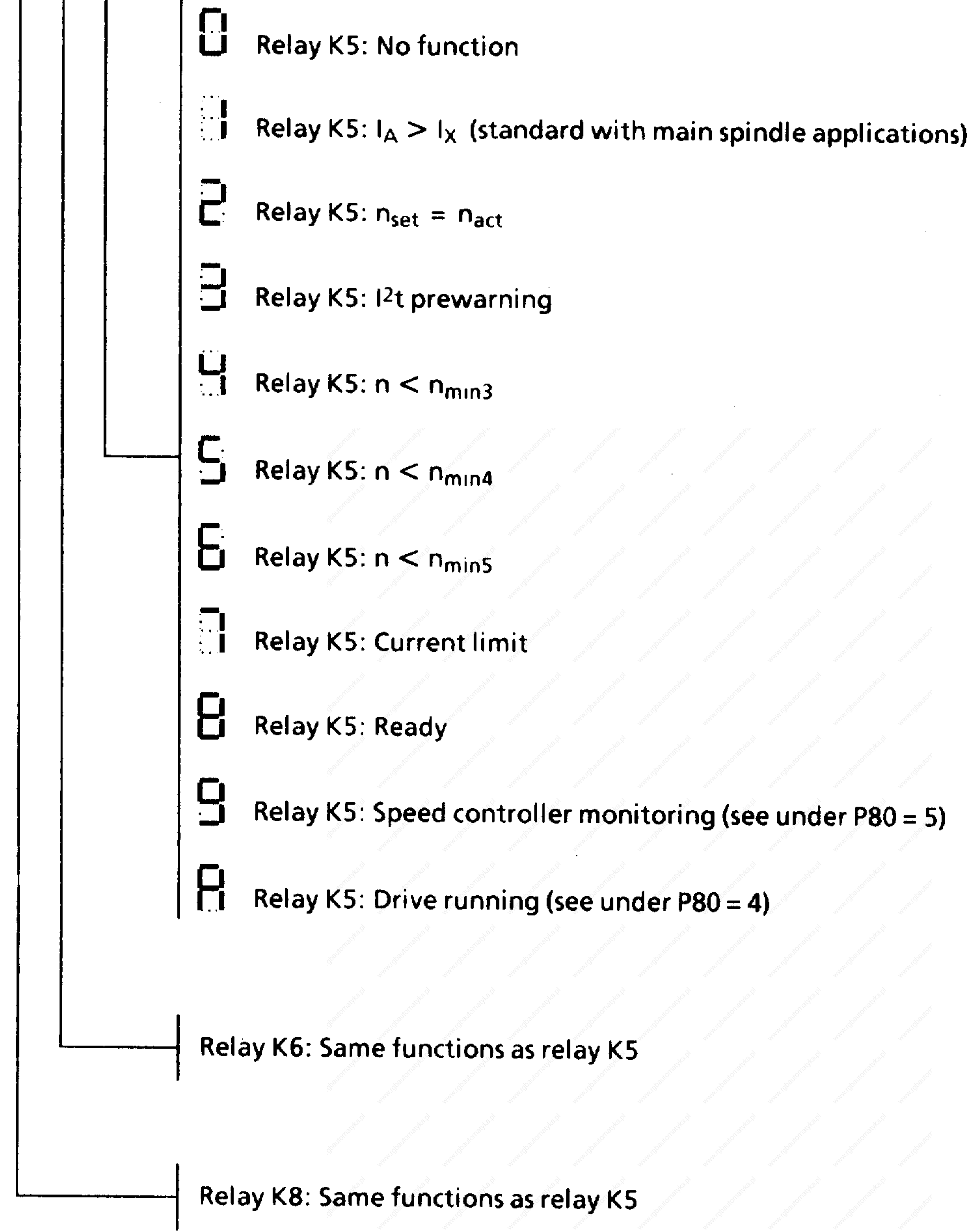

E29

Selection of configuration for A1210 module CFG A1210

0

Function: Standard configuration for main spindle applications

The parameters E22, E23, E24, E25, E26, E27, E28 and E30 are set at E22 = 10, E23 = 11, E24 = 12, E25 = 13, E26 = 14, E27 = 3, E28 = 321 and E30 = 11 and cannot be changed.

See pages 16 and 17 for function of A1210 module.

1

Function: Configuration for applications with motor potentiometer

The parameters E22, E23, E24, E25, E26, E27 and E28 are set at E22 = 10, E23 = 11, E24 = 15, E25 = 16, E26 = 17, E27 = 18 and E28 = 321 and cannot be changed.

The function of the analog input (terminals 562 / 142) can be selected via parameter E30.

2

Function: Function of terminals 117, 118, 119, 60, 61 and 107 selectable via the parameters E22, E23, E24, E25, E26 and E27.

Function of relay outputs, terminals 109, 110, 108 (relay K5), terminals 127, 128, 126 (relay K6) and terminals 209, 210, 208 (relay K8) selectable via parameter E28.

Function of analog input, terminals 562 / 142, selectable via parameter E30.

NOTE

If parameter E29 has been set to 2, it is absolutely necessary to individually set parameters E22 to E28 and E30 to the desired values because setting of parameter E29 to 2 may have changed all of them.

E30

Selection of function for the analog input (terminals 562, 142) CMD AIN 1210

- 0 No function
- 1 Additional setpoint for n-controller
- 2 Additional setpoint for I-controller
- 3 Current limitation in positive direction
- 4 Current limitation in negative direction
- 5 Current limitation in positive and negative directions
- 6 No function
- 7 Current limitation in positive direction, sign-dependent
- 8 Current limitation in negative direction, sign-dependent
- 9 Analog field current setpoint
- 10 Actual e.m.f. value
- 11 Setpoint input for C axis mode (standard for main spindle applications)

Important: In position 11 the resistor R9 must be fitted on the A1210 module (Delivery state).
In all other settings the resistor R9 must not be fitted on the A1210 module, i.e. it must be removed when one of these functions is used!

E39

Selection of operating mode for thyristor diagnosis CMD SEA6

- 0 Thyristor diagnosis switched off
 - 1
 - 2
 - 3
- } For service purposes only

E41

P controller / PI controller switchover threshold N MIN CMD N

Switchover from PI-action speed controller to P-action controller:

This switchover is possible via the gear speed selection if the I-action component of the active n controller is set to zero, i.e. if the reset time of the relevant gear speed is zero.

In gear speed I (terminal 117, 118 and 119 not activated) the PI/P switchover occurs if the speed drops below a value set in parameter E41. (The integrator is cut in again only when $n_{act} > E41 + 2\%$ of n_{max}). This permits pump-free stopping of the drive using the speed setpoint alone ($nset \rightarrow 0$), without interrupting the drive enable signal at terminal 64 (i.e. the motor remains under speed control).

This function is inactive if $E41 = 0$ (as delivered) and in the C axis mode.

E70

Selection of the operating mode for torque control CMD MOMREG

X X X

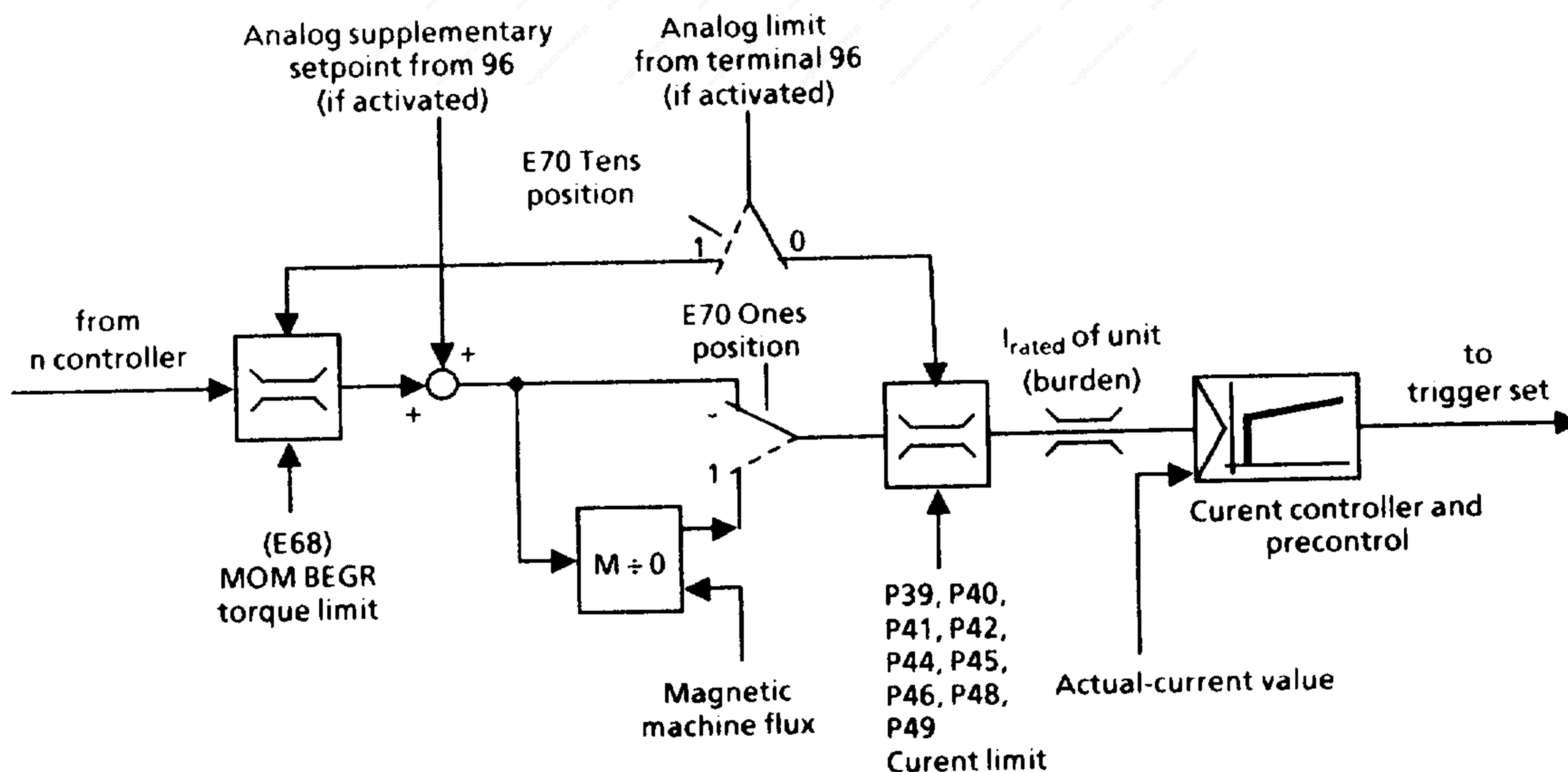
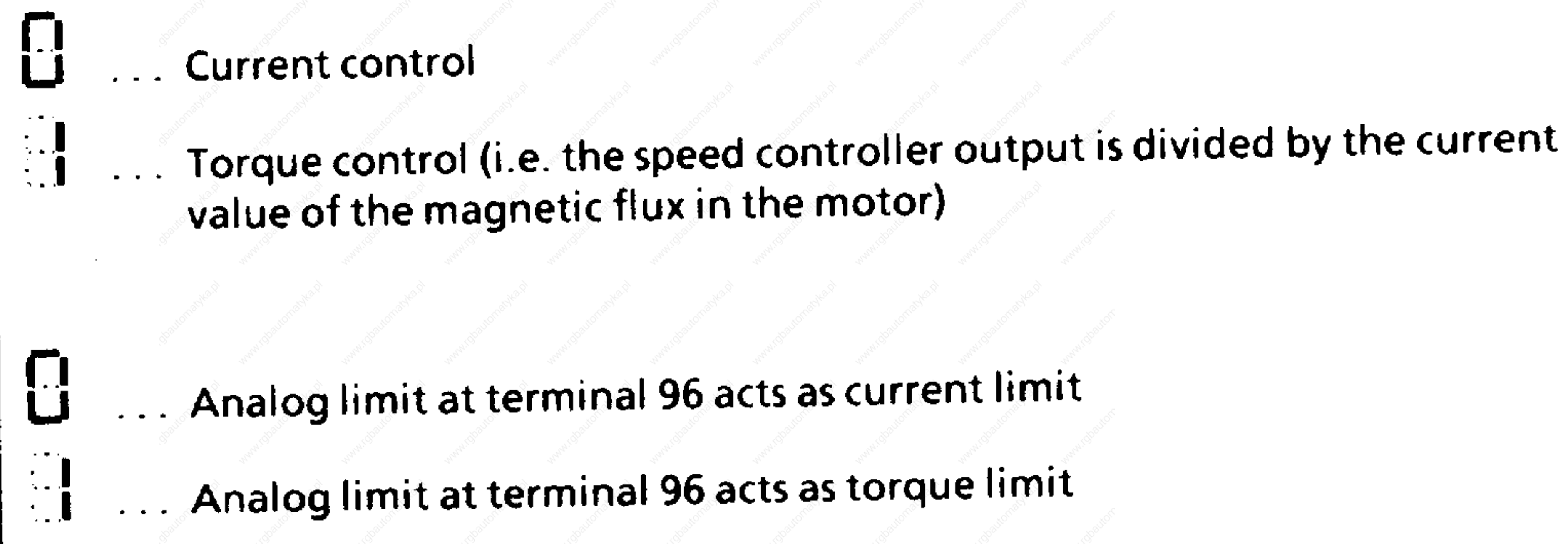

E80

Selection of the operating mode for the speed control adaptation in the main spindle drive mode (load adaption) CMD HSA

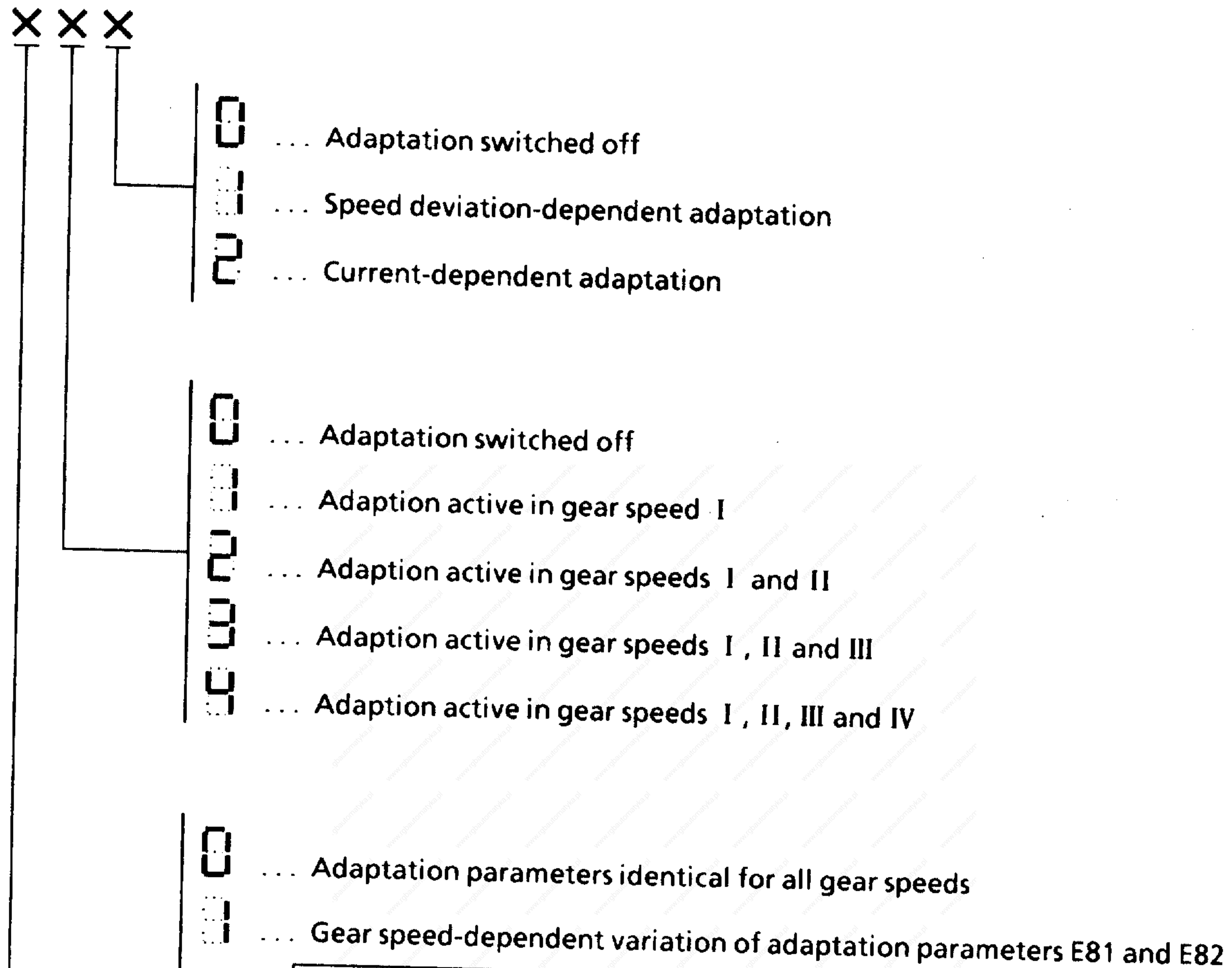

Gear step	I	II	III	IV
KPN = (P gain)	E81	$E81 \times \frac{P33}{P31}$	$E81 \times \frac{P35}{P31}$	$E81 \times \frac{P37}{P31}$
TNN = (reset time)	E82	$E82 \times \frac{P34}{P32}$	$E82 \times \frac{P36}{P32}$	$E82 \times \frac{P38}{P32}$

- Parameter E81: KPN1A (0... 200 in steps of 0.1)
P gain for speed deviation / I > threshold 2 and n < E85
- Parameter E82: TNN1A (0... 10.0 sec in steps of 0.1)
Reset time for speed deviation / I > threshold 2 and n < E85
- Parameter E83: SCHW1N (0... 100% speed deviation or current in steps of 0.1)
Threshold 1 (armature current or speed deviation)
- Parameter E84: SCHW2N (0... 100% speed deviation or current in steps of 0.1)
Threshold 2 (armature current or speed deviation)
- Parameter E85: SCHWNN (0... 100% of n_{max})
Speed limit for the adaptation range; the adaptation is inactive from this speed upwards; transition range from E85 to E85 + 5% of n_{max}

Schematic of "Load dependent adaptation"

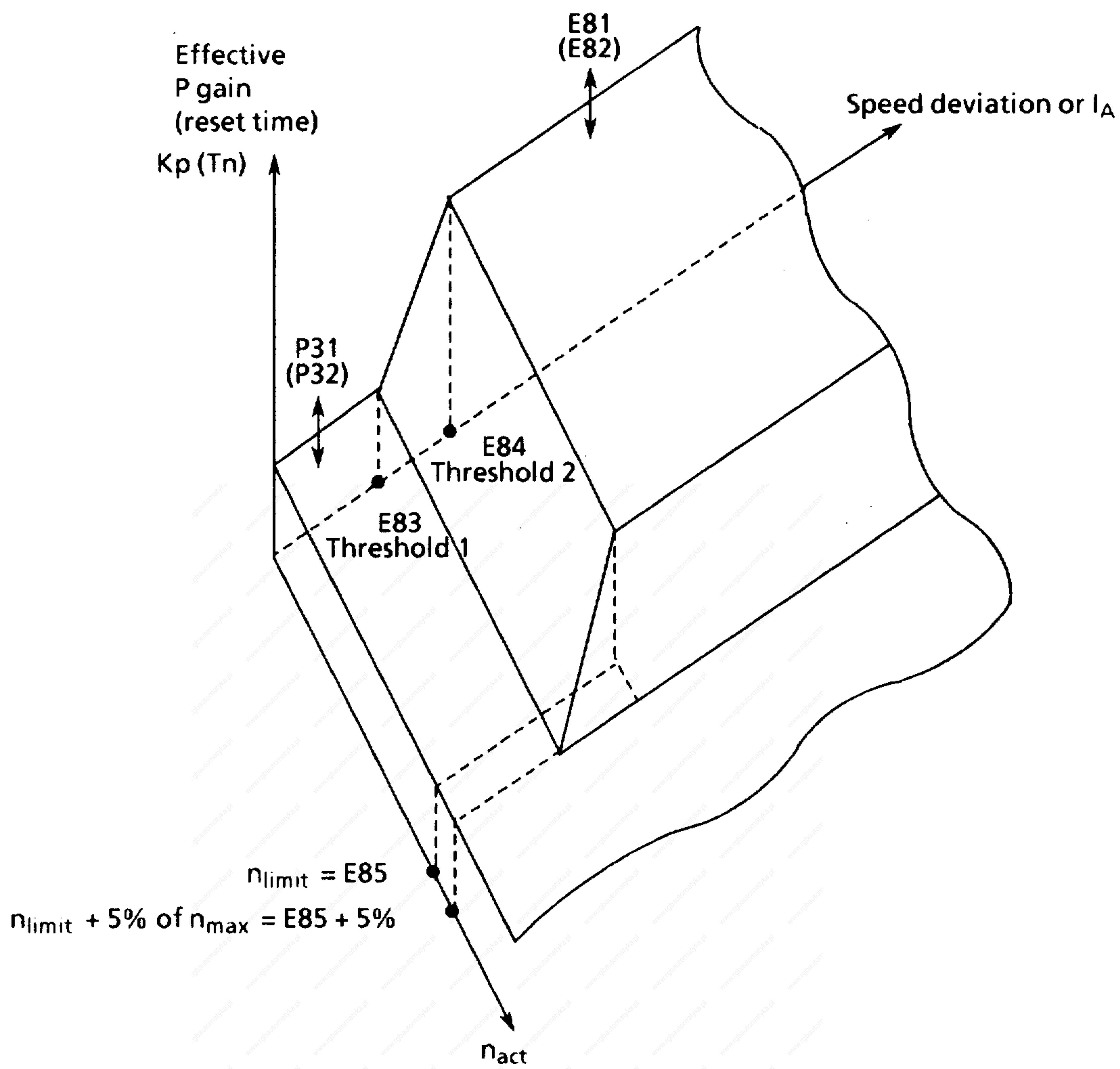

Differential gap of limit monitors
 $n < n_x, I_A > I_x$ and $n < n_{min2...min5}$
 CMD HYST

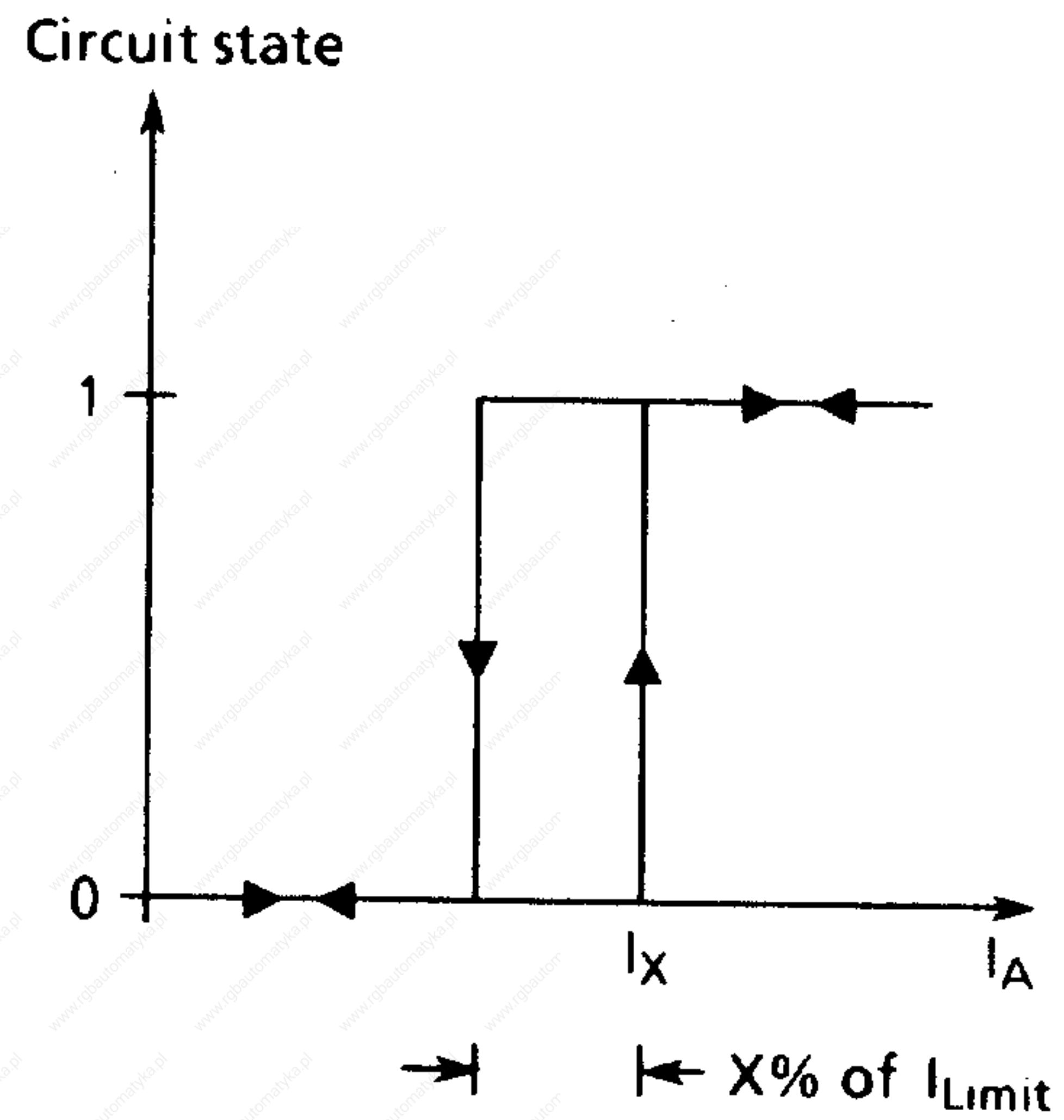
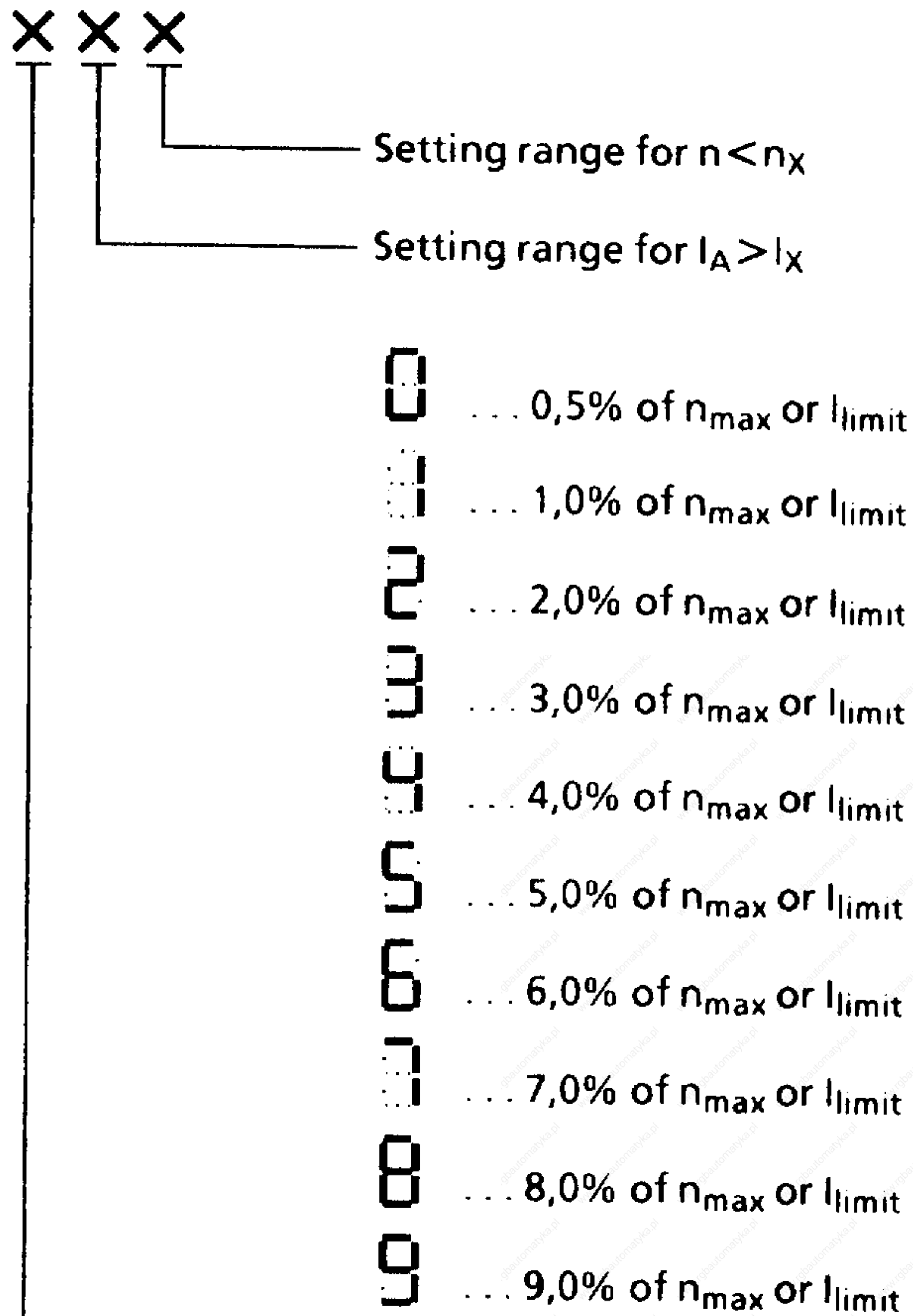

Setting range for $n < n_{min2...min5}$

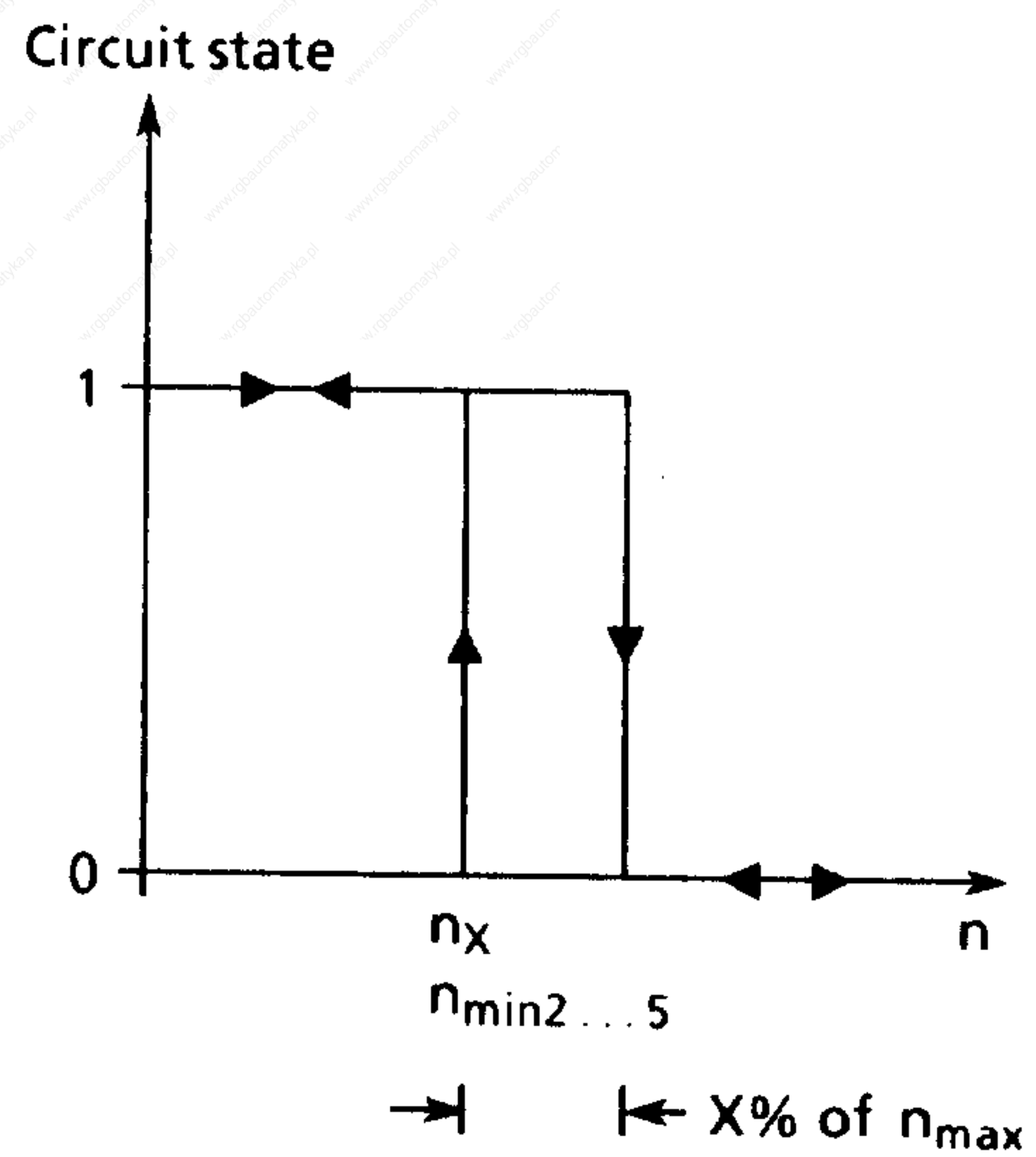
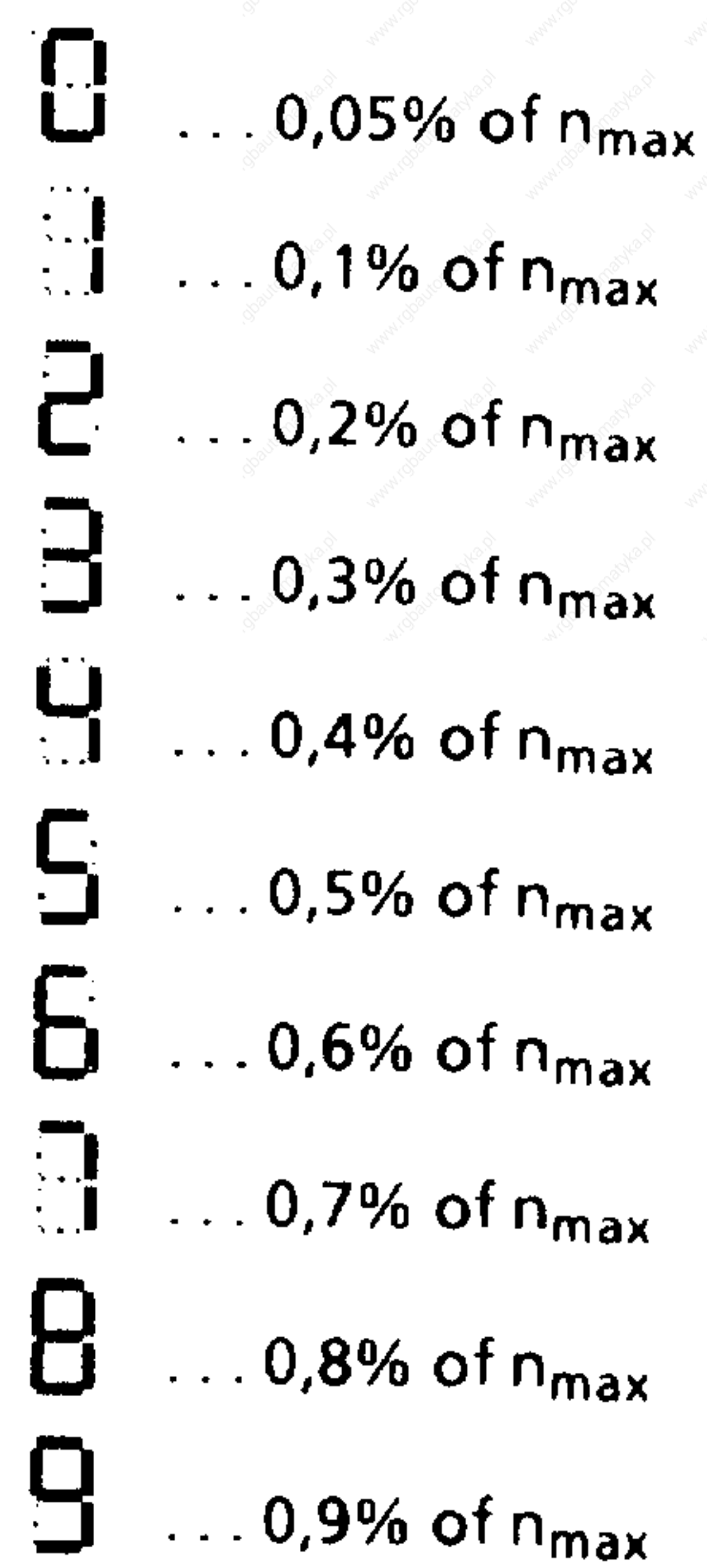

Note: The differential gap of the n_{min1} signal is 0.5% of n_{max}

050

Suppression quality of 2nd bandstop filter CMD GÜTE2

0

Function: Quality of 2nd bandstop = 0.5

1

Function: Quality of 2nd bandstop = 1

2

Function: Quality of 2nd bandstop = 2

3

Function: Quality of 2nd bandstop = 3

055

dv / dt injection

to

059

In order to prevent overshoot of the actual speed value when the ramp-function generator is used, an additional current setpoint (dependent on the ramp-up or ramp-down rate) is injected behind the speed controller. This setpoint prevents a charging of the speed controller integrator to a higher level which must be reduced again on completion of the ramping function owing to a setpoint/actual value deviation in the other direction (i.e. overshoot).

055

Gear speed I

Time required by the drive to accelerate from 0% to 100% n_{max} under the greatest external centrifugal load if it is operating at rated converter current and rated motor field current (as set in P76).

If this operating mode is not permissible, this time factor must be extrapolated linearly on the basis of values measured with partial currents and/or small speed step changes.

Setting range: 0.00 - 50.0 sec
0.00 Function deactivated

056

Gear speed II

Time required by the drive to accelerate from 0% to 100% n_{max} under the greatest external centrifugal load if it is operating at rated converter current and rated motor field current (as set in P76).

If this operating mode is not permissible, this time factor must be extrapolated linearly on the basis of values measured with partial currents and/or small speed step changes.

Setting range: 0.00 - 50.0 sec
0.00 Function deactivated

057

Gear speed III

Time required by the drive to accelerate from 0% to 100% n_{max} under the greatest external centrifugal load if it is operating at rated converter current and rated motor field current (as set in P76).

If this operating mode is not permissible, this time factor must be extrapolated linearly on the basis of values measured with partial currents and/or small speed step changes.

Setting range: 0.00 - 50.0 sec
0.00 Function deactivated

058

Gear speed IV

Time required by the drive to accelerate from 0% to 100% n_{max} under the greatest external centrifugal load if it is operating at rated converter current and rated motor field current (as set in P76).

If this operating mode is not permissible, this time factor must be extrapolated linearly on the basis of values measured with partial currents and/or small speed step changes.

Setting range: 0.00 - 50.0 sec
0.00 Function deactivated

059

X X X

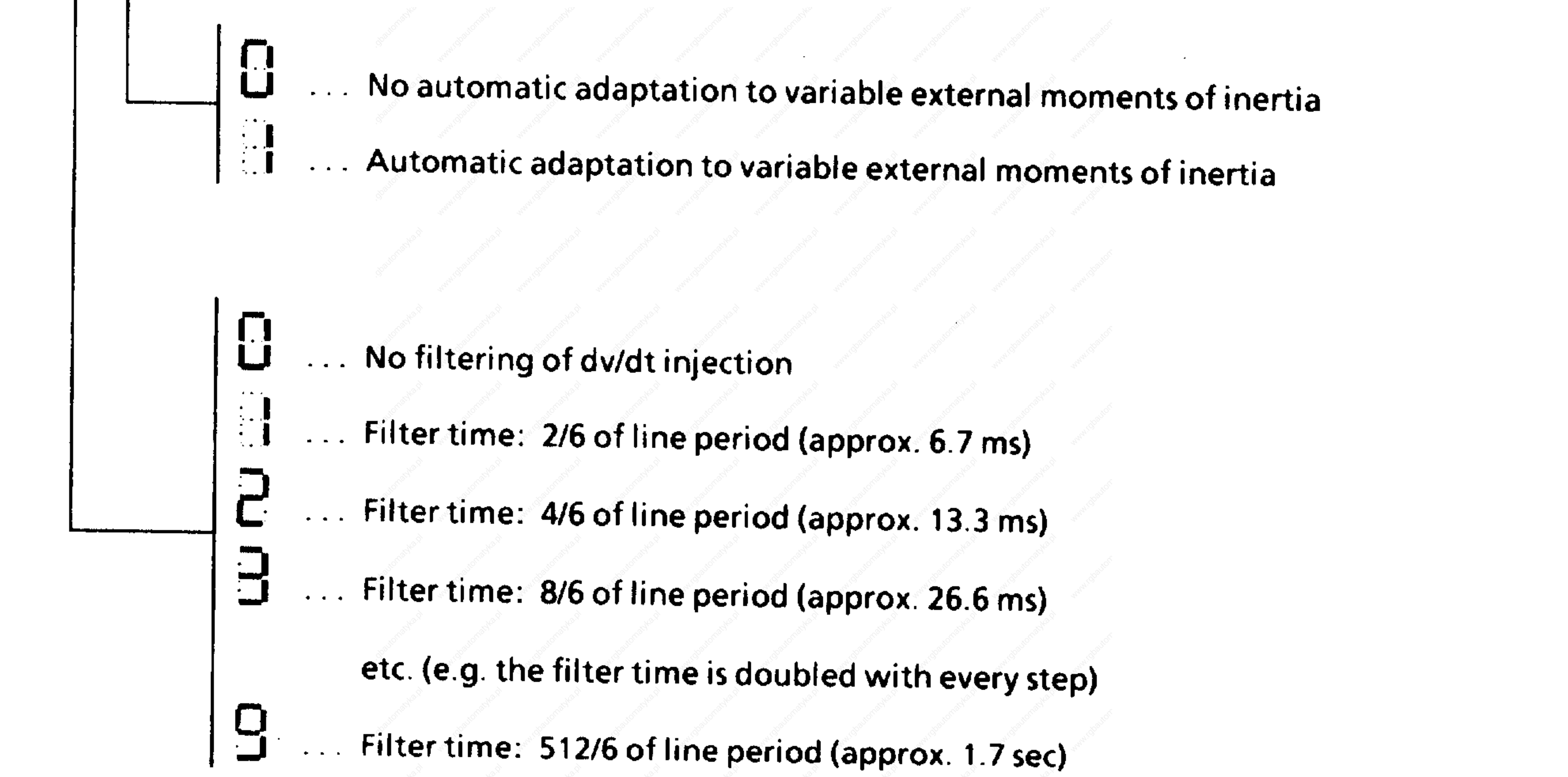

04

Various flag bits CMD 5 P

Bit No.

0

0: The unit is not switched off correctly
1: The unit is switched off correctly

1

Not assigned (for subsequent applications)

2

0: No fault is present
1: A fault is present

3

Not relevant for SIMODRIVE system

4

Not assigned (for subsequent applications)

5

Not assigned (for subsequent applications)

6

Not assigned (for subsequent applications)

7

Not assigned (for subsequent applications)

Important: These bits are changed only by the program.
They cannot be changed by means of parameterization.

008

"Field characteristic measured" flag
CMD KL

0

The field characteristic has not yet been measured correctly

1

The field characteristic has been measured correctly

009

E.m.f. setpoint (in V) at transition point
(start of field weakening)
EMK KENNL

The value entered here (by the characteristic measurement) is the motor e.m.f. which is reached at the speed set in parameter L10.

010

Transition point [in % of n_{max}]

Speed at which field-weakening mode starts.

011

1st to 20th characteristic point [in % of n_{max}]

to

030

Speeds belonging to reduced field-current values according to the diagram "Example of field characteristic".

L33

X X X

Frequency tracking speed (adjustable for systems with unstable frequency)

- 0 ... Infinite bus systems (normal state)
 - 1 ... Weak systems 1
 - 2 ... Weak systems 2
 - 3 ... Weak systems 3
- } Higher number means faster frequency tracking

Tacho fault monitoring

The response threshold for the tacho fault signal (F11) can be increased. This is necessary if the tacho fault monitor gives spurious responses due to heavily distorted line voltage.

- 0 ... Response threshold (EMF) = $60V \times P98 / 380$ (normal state)
- 1 ... Response threshold (EMF) = $120V \times P98 / 380$
- 2 ... Response threshold (EMF) = $180V \times P98 / 380$
- 3 ... Response threshold (EMF) = $240V \times P98 / 380$

NOTE

- If the response threshold of the tacho monitor has been increased, tripping in response to a tacho fault occurs only at a higher speed.
- An increase in the frequency tracking speed may lead to an increased ripple content of the armature current.

L34

Phase angle correction of the system-synchronous signal

Systems with a high harmonic content may cause erroneous EMF calculation with resultant unjustified fault messages (e.g. F11, F26, ...).

L34 = -199 ... + 199 x 10µs additional phase shift

Setting instructions: P89 = 3 (current-controlled operation)
 P76 = 0 (field current setpoint is zero)
 input current setpoint > 2% at terminal 56
 Read-out contents of parameter P07 (EMF)
 Adjust L34 until the contents of P07 = 0

- 0 ... Normal state

15 Appendix

15.1 Field characteristic

The L parameters can be used to read out the characteristic parameters calculated during the field characteristic measurement and thus, with machines of the same type, to manually enter the field characteristic directly into the L parameters without implementing the automatic field characteristic measurement.

Important: Since, even with motors of the same type, the magnetization characteristics can vary, it is advisable when commissioning a number of identical machines to carry out the automatic field characteristic measurement for every individual drive. The field characteristic should be entered manually only in exceptional cases when automatic characteristic measurement is not possible.

If the characteristics are not measured automatically, then the following L parameters must be defined:

- L08 = 1: "Field characteristic measured" flag
 - L09 : E.m.f. setpoint (in V) at transition point (start of field weakening). 1)
 - L10 : Transition point [as % of n_{max}]
 - L11 : 1st characteristic point [as % of n_{max}]
 - L12 : 2nd characteristic point [as % of n_{max}]
 - L13 : 3rd characteristic point [as % of n_{max}]
 - L14 : 4th characteristic point [as % of n_{max}]
 - L15 : 5th characteristic point [as % of n_{max}]
 - L16 : 6th characteristic point [as % of n_{max}]
 - L17 : 7th characteristic point [as % of n_{max}]
 - L18 : 8th characteristic point [as % of n_{max}]
 - L19 : 9th characteristic point [as % of n_{max}]
 - L20 : 10th characteristic point [as % of n_{max}]
 - L21 : 11th characteristic point [as % of n_{max}]
 - L22 : 12th characteristic point [as % of n_{max}]
 - L23 : 13th characteristic point [as % of n_{max}]
 - L24 : 14th characteristic point [as % of n_{max}]
 - L25 : 15th characteristic point [as % of n_{max}]
 - L26 : 16th characteristic point [as % of n_{max}]
 - L27 : 17th characteristic point [as % of n_{max}]
 - L28 : 18th characteristic point [as % of n_{max}]
 - L29 : 19th characteristic point [as % of n_{max}]
 - L30 : 20th characteristic point [as % of n_{max}]
 - L31 : 2 x number of valid characteristic points
 - L32 : minimum field current at n_{max} [255 = rated field current (P76)]
- P77 = E.m.f. setpoint (in V) at transition point (= parameter L09)
Set P90 to 00!

If the motor is to be operated only in the armature control range (constant field current), then the automatic field characteristic measurement must also be carried out or the following parameter entries made

- L08 = 1
- L09 = E.m.f. [in V] at n_{max} 1)
- L10 = 100%
- P77 = 0
- L31 = 0
- L32 = 255

and then

P90 set to 00.

1) E.m.f. setpoint is calculated as follows:

$$E.m.f._{set} = U_{Arated} - R_A \times I_{Arated}$$

U_{Arated} : Armature voltage of motor (rating plate)

I_{Arated} : Armature current of motor (rating plate)

R_A : Armature circuit resistance (Catalog DA36, Chapter 3)

Example of field characteristic

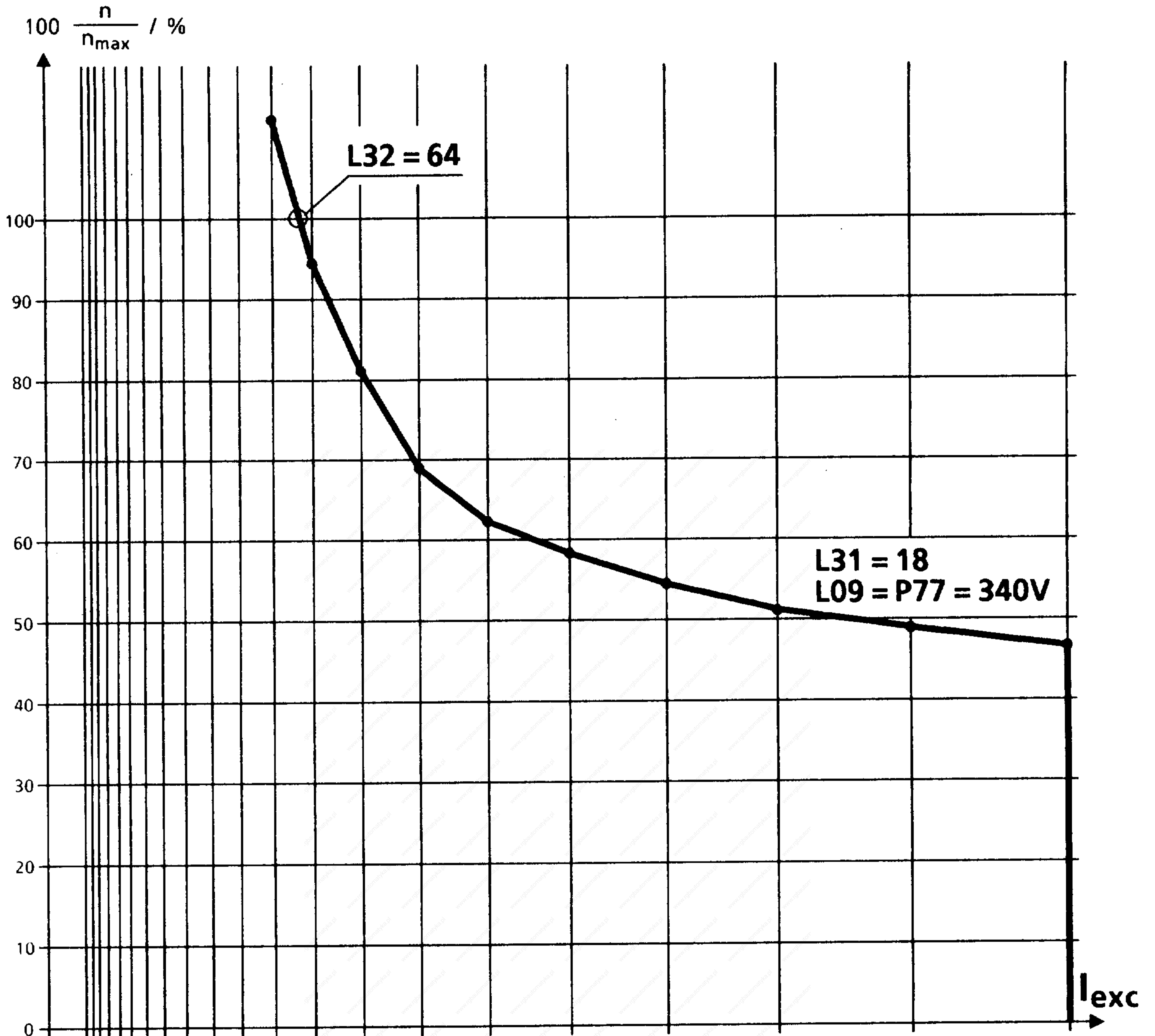

31,0%	36,9%	43,5%	51,4%	60,8%	71,8%	84,7%	100%
79	94	111	131	155	183	216	255
L17	L16	L15	L14	L13	L12	L11	L10
14	12	10	8	6	4	2	0

26,3%	67	L18	16
22,4%	57	L19	18
18,8%	48	L20	20
16,1%	41	L21	22
13,3%	34	L22	24
11,4%	29	L23	26
9,8%	25	L24	28
8,2%	21	L25	30
7,1%	18	L26	32
5,9%	15	L27	34
5,1%	13	L28	36
4,3%	11	L29	38
3,5%	9	L30	40

Field current scale, 255 corresponding to maximum field in accordance with P76 (scale to determine I FIELD MIN = L32)

Speed points (L10 to L30) assigned to the corresponding field current values

Scale to determine twice the number of valid characteristic points (L31)

Field characteristic $n = f(I_{exc})$
for E.M.F. SETPOINT = 340 V
Motor type: 1GG5134-0WH46-6HU1

15.2 Master / slave drives

15.2.1 Principle diagram

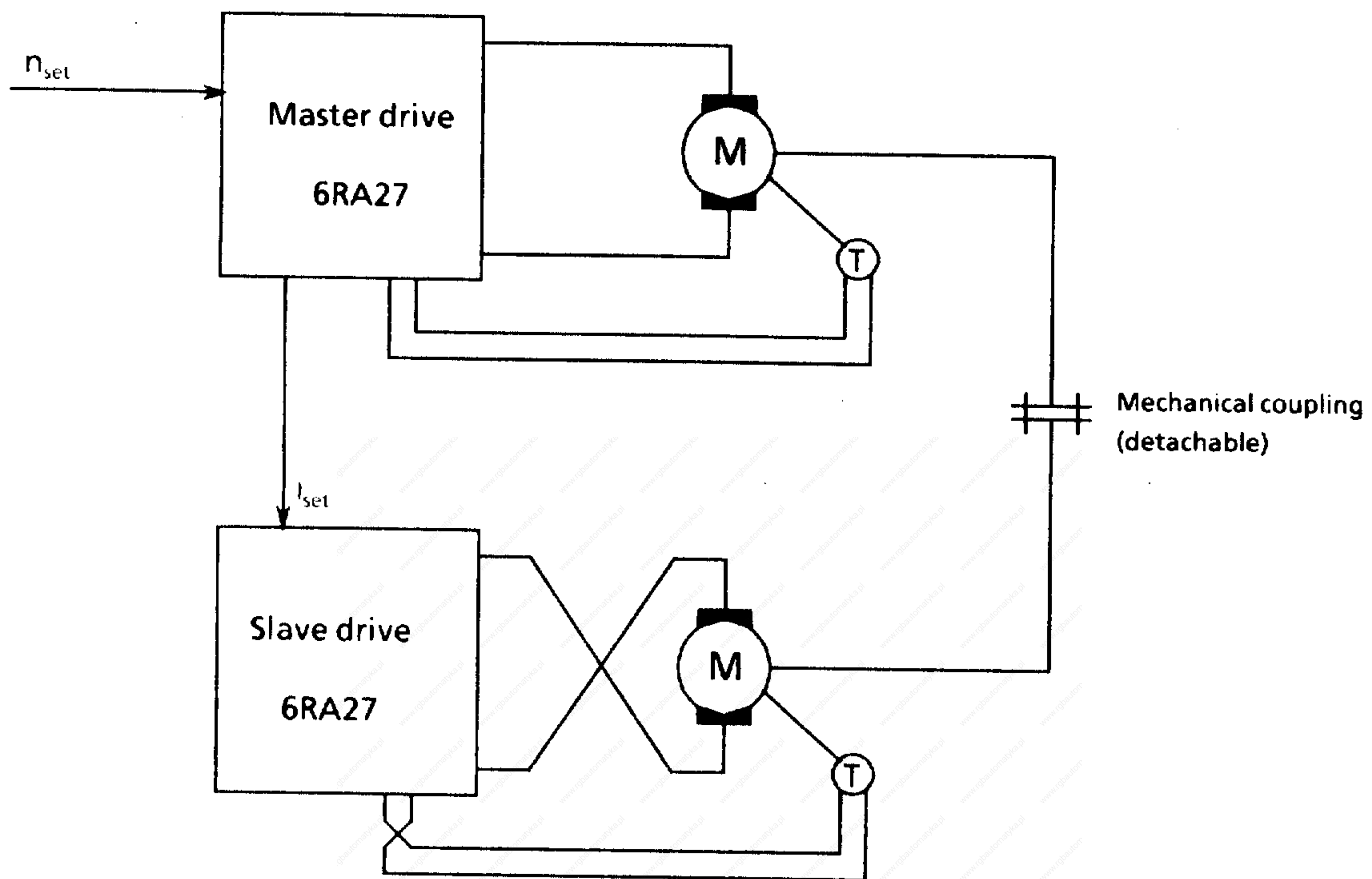

15.2.2 Implementation

NOTE

In master/slave drive combinations the master drive operates with speed control and the slave drive with current control.

Master/slave combination of drives is therefore only permissible with rigid mechanical coupling of the drive shafts because otherwise the slave drive may accelerate to inadmissibly high speeds.

15.2.2.1 Rigid coupling of the drives

For applications in which the two drives are always operated with rigid mechanical coupling.

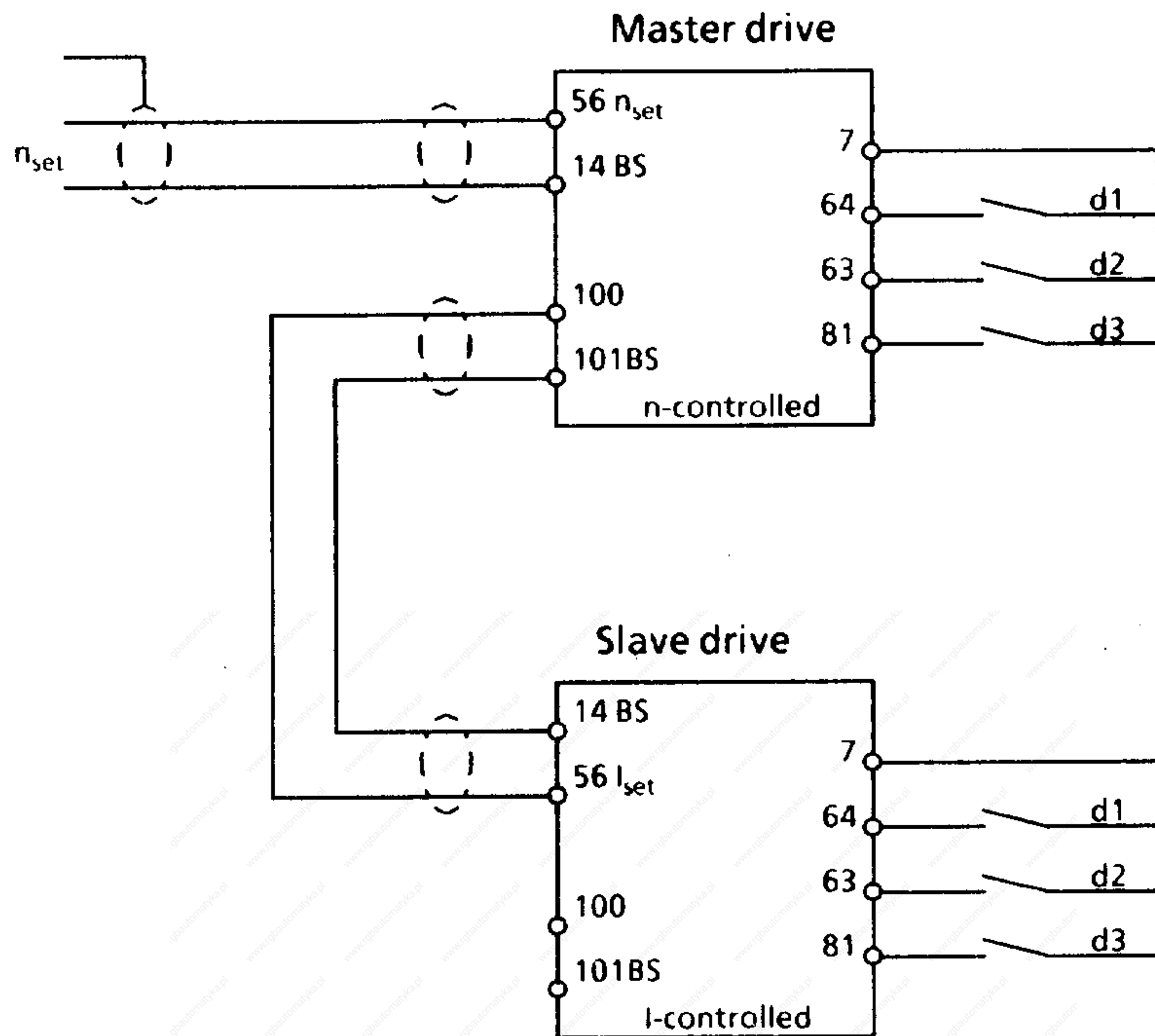

Master drive: P82 = 2 (Terminal 100 = Speed controller output)
 E67 = ± 1 (Scaling for terminal 100) ¹⁾

Slave drive: P89 = 3 (Setpoint at terminal 56 = Current setpoint)
 E01 = 80 (Scaling for terminal 56)

1) Select the sign as necessary to ensure that the master and slave drive motors develop the same torque direction.

15.2.2.2 Quasi-rigid coupling of the drives

For drive combinations in which:

- the two drives are operated as master and slave with rigid mechanical coupling or
- the two drives are operated with speed control independently of one another.

Variant 1:

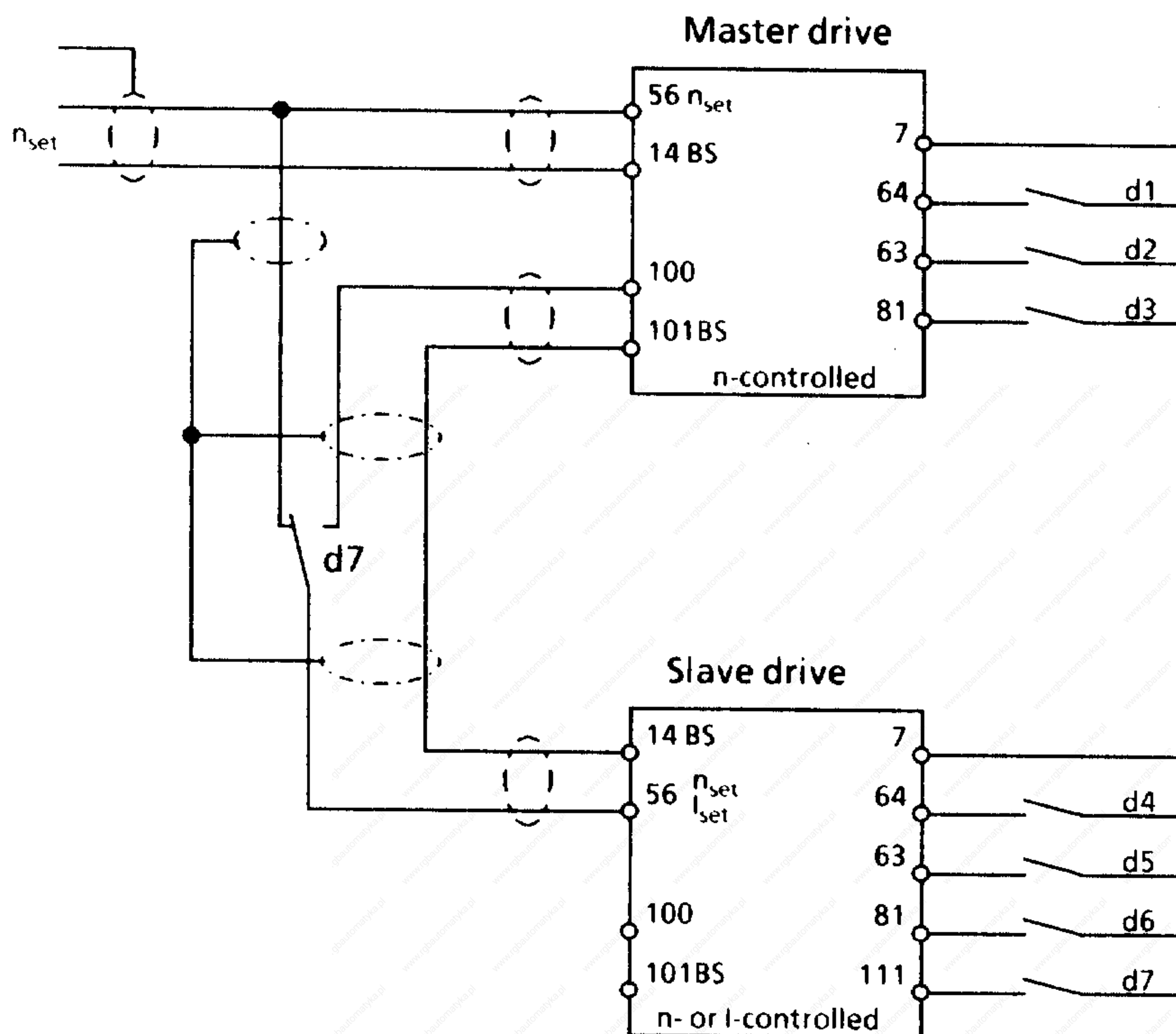

Master drive: P82 = 2 (Terminal 100 = Speed controller output)
E67 = + 0,8 (Scaling for terminal 100)

Slave drive: P84 = 11 (Terminal 111 = Switchover between master/slave drive mode) 1)
E01 = 100 (Scaling for terminal 56)

1) The switchover can also be effected with one of the other selectable-function terminals.

NOTE

Make sure that the master and slave drive motors develop the same torque direction .
(In case of torque opposition, reverse polarity of field and tacho connections in slave drive!)

Variant 2:

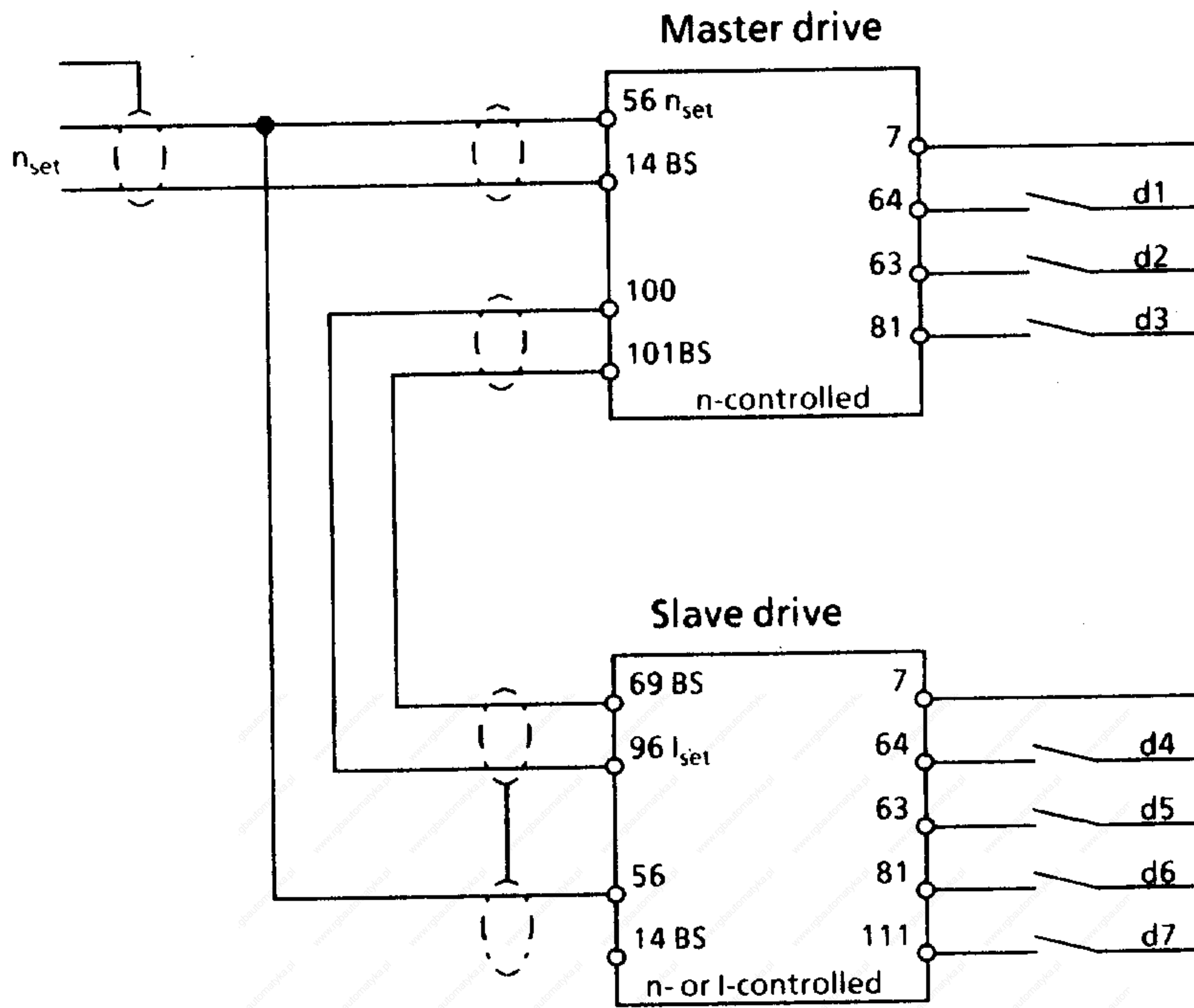

- Master drive: P82 = 2 (Terminal 100 = Speed controller output)
 E67 = + 1 (Scaling for terminal 100)
- Slave drive: P85 = 11 (Terminal 96 = Current setpoint with I control)
 E02 = 80 (Scaling for terminal 96)
 P84 = 11 (Terminal 111 = Switchover between master/slave drive mode) 1)

1) The switchover can also be effected with one of the other selectable-function terminals.

NOTE

Make sure that the master and slave drive motors develop the same torque direction.
 (In case of torque opposition, reverse polarity of field and tacho connections in slave drive!)

With both variants, contact d7 serves for switching the slave drive from speed-controlled to current-controlled operation.

Switchover to current-controlled operation is only permissible if there is rigid mechanical coupling between the master and slave drives. Contact pairs d1 / d4, d2 / d5 and d3 / d6 must be actuated simultaneously in the master and slave drives.

The "separately speed-controlled" mode may only be selected when there is no mechanical coupling between the motors.

Comparison between Variant 1 and Variant 2

	Variant 1	Variant 2
Requisite external components	Additional relay	None
Analog current limit	can be used for master and slave drive	can be used for master drive only

Prerequisites for uniform torque sharing between master and slave drives:

- identical motors
- identical converters
- same settings for current limits and EMF setpoint values (P39, P40, P41, P42, . . . , P48, P49, P71, P76, P77)

15.3 Software changing procedure

1 New startup intended after software change?

? No

2 proceed

3 Switch off electronics power supply

4 Check jumper sockets FA-FB-FC on PCB A1200 from software version 04, D1, ...
Software version
≤ 2.2 (128k-EPROM): Insert jumper in sockets FA-FB
≥ 3.0 (256k-EPROM): Insert jumper in sockets FB-FC
(A1200 modules in versions up to 03, C1, ... do not have these jumper sockets and can therefore be upgraded only to software version 2.2)

2a If the parameter settings have not been noted down in the operating instructions, switch on the rack power supply and read out and take notes of parameter values.

Note:
If module A1210-L21 or -L41 is provided, the parameter set can be printed out via the serial interface or transferred to a PG635/675/685 unit.

Proceed to 3

5 Cancel hardware write protection:
A1200 module versions up to 03, C1, ...: Insert jumper BR5
A1200 module versions from 04, D1, ...: Insert jumper in sockets EB - EC of socket triplet EA - EB - EC.

6 Remove EPROMs D3, D4 from their sockets on the A1200 module.

7 Insert new EPROMs in the sockets
Note:
D3 is marked -A101
D4 is marked -A102

8 Inspect for proper insertion of all pins in their sockets.

9 Important: Note that all parameter settings may be lost at the next electronics power-up!
(If this is not acceptable: carry out step 2a with the "old" software)

10 Switch on the rack power supply

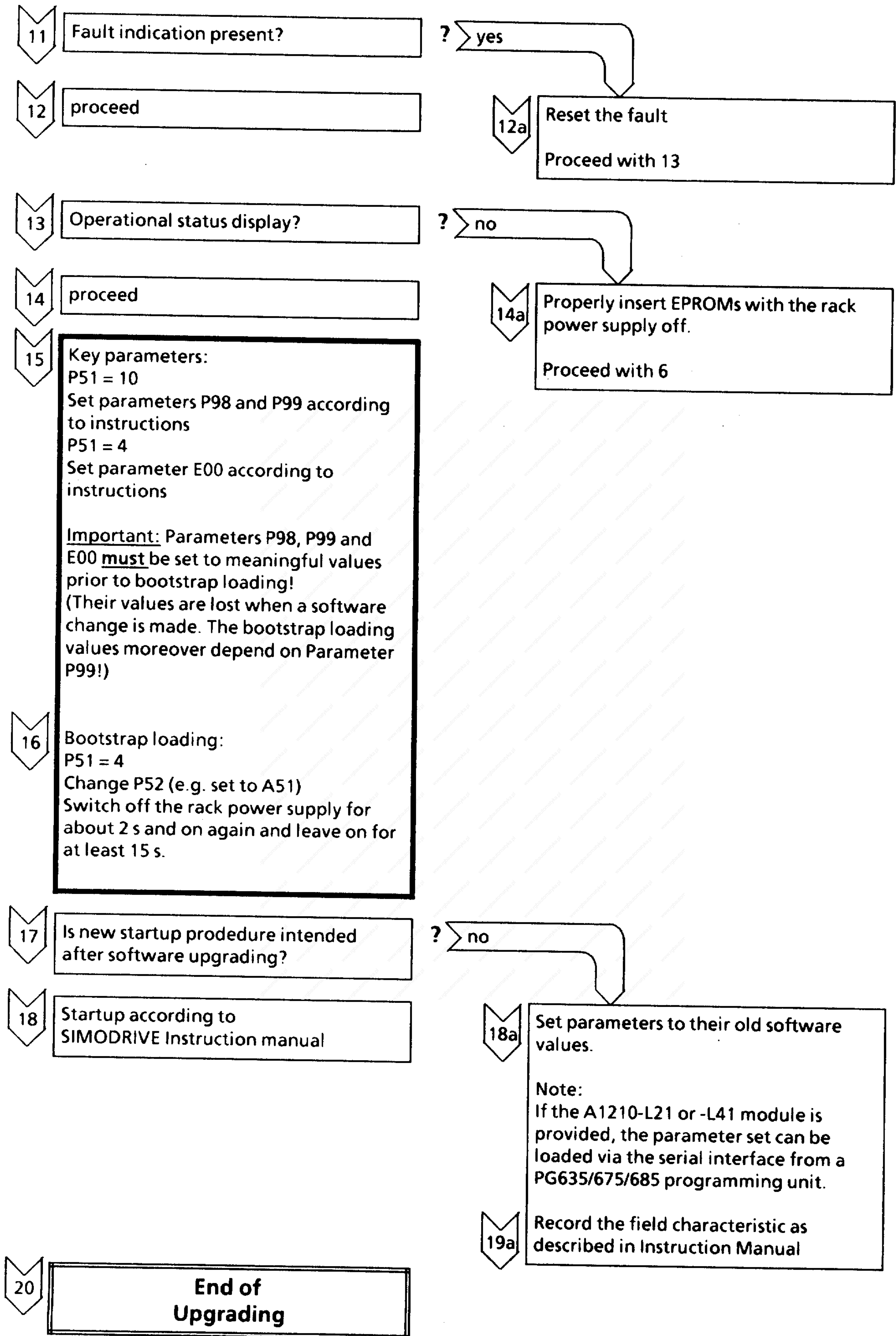

15.4 Connection of electronics chassis

Principle:

The electronics chassis potential (BS) should be tied to 0 V reference potential at one point only in order to prevent the formation of spurious currents on the electronics chassis (due to earth loops).

a) Setpoint value from NC

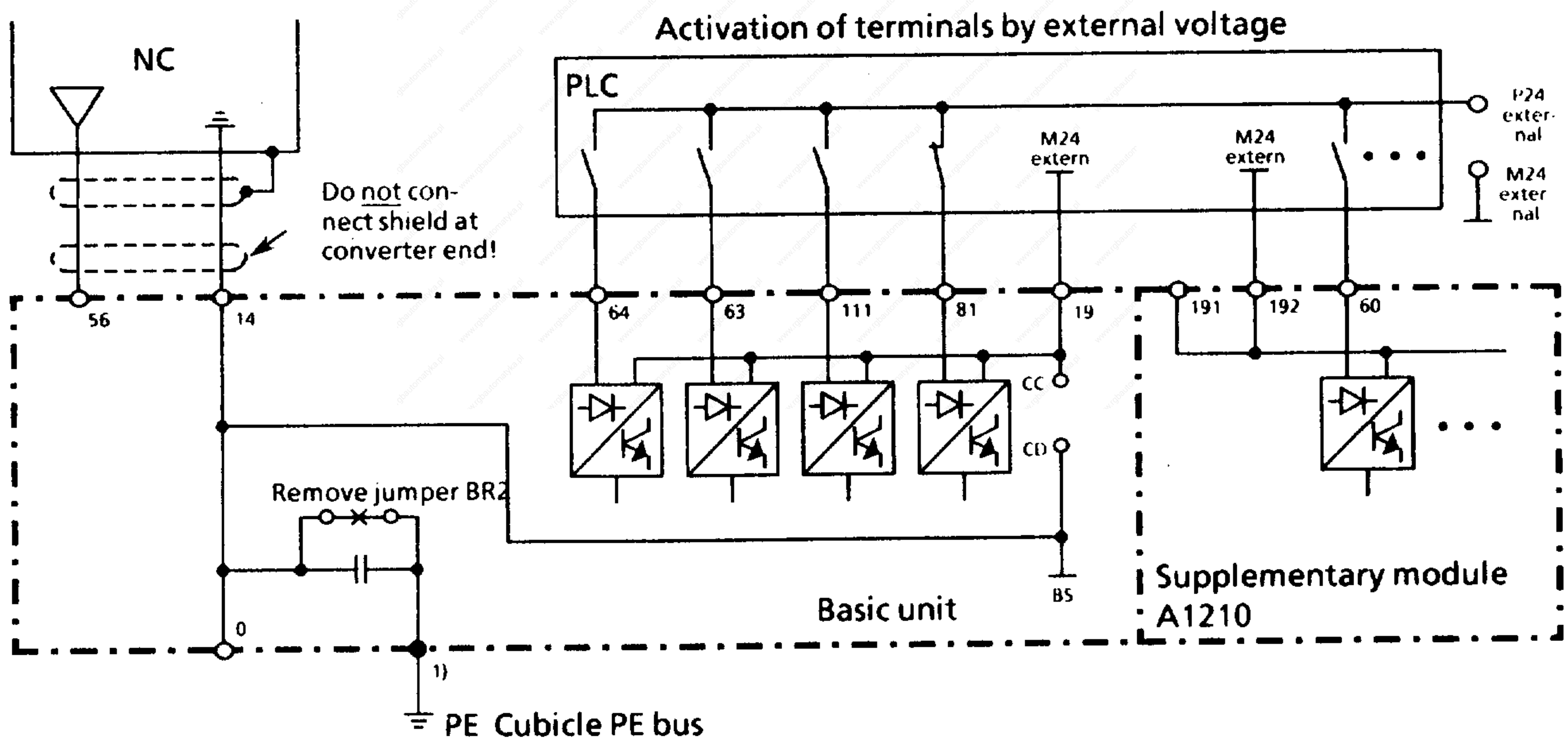
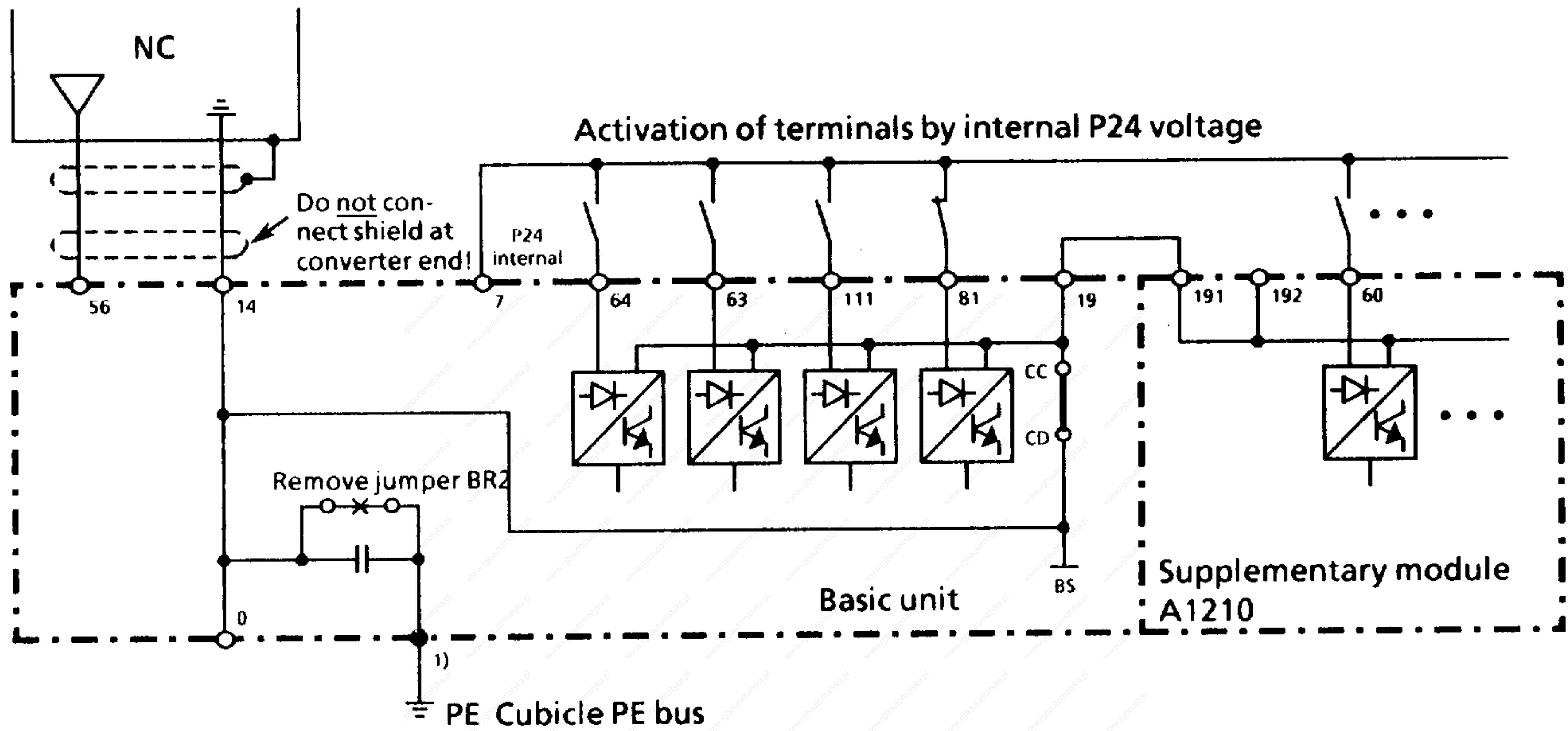

1) Converter PE terminal

b) Setpoint value from potentiometer

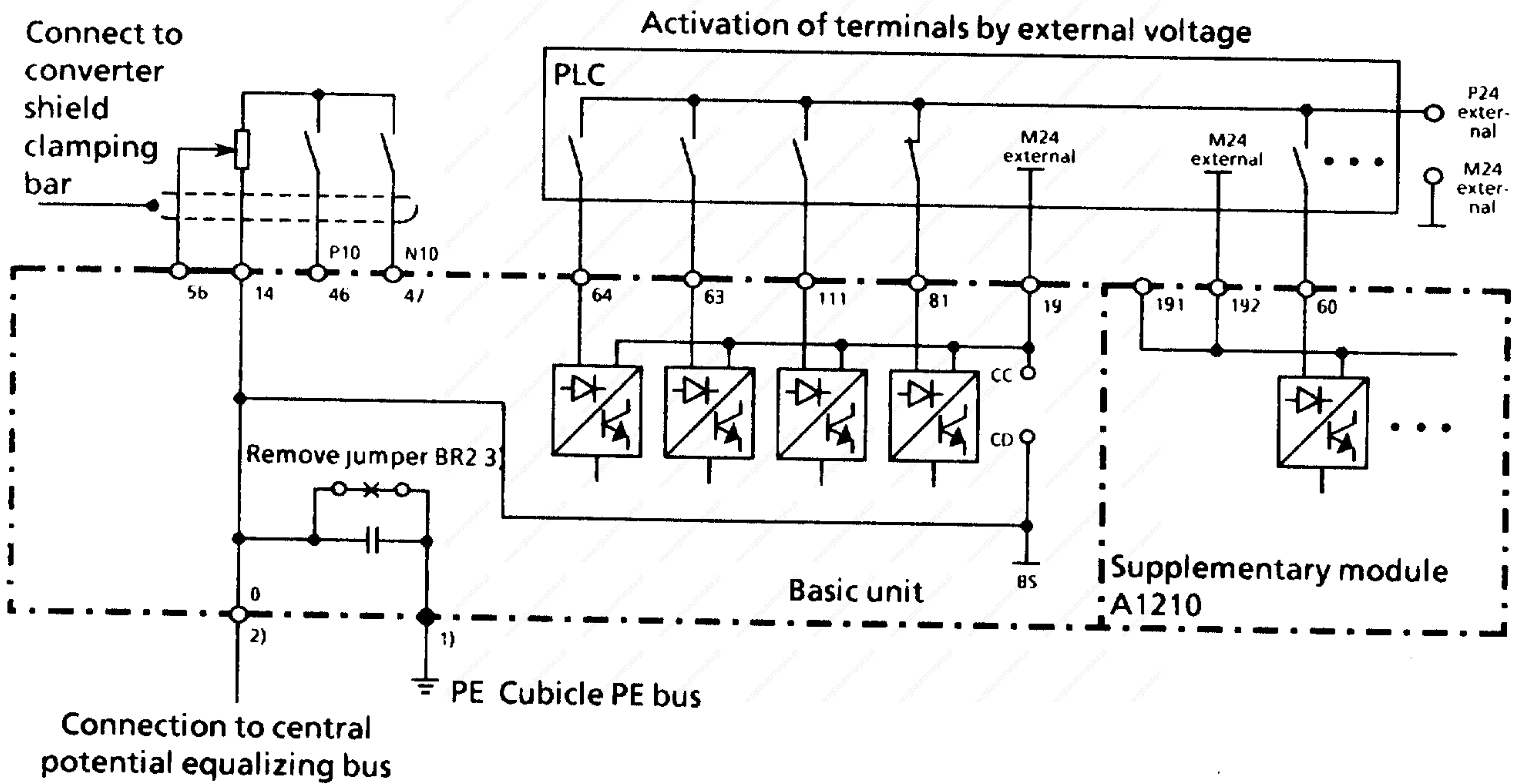
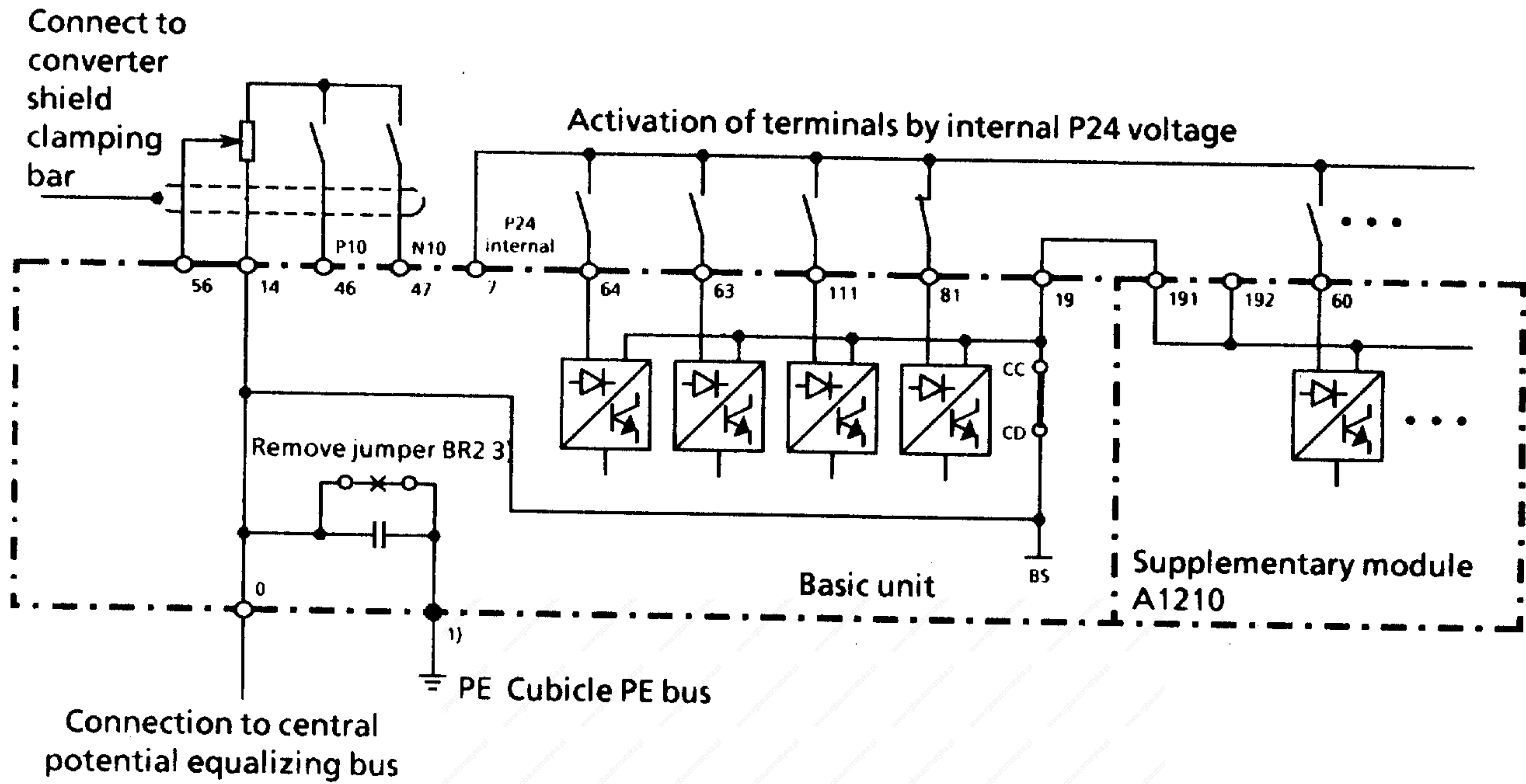

- 1) Converter PE terminal
- 2) M4 threaded bushing on module A1200
- 3) Connection to converter PE terminal suffices if there is no potential equalizing bus in the equipment cubicle. Threaded bushing 0 does not need to be connected. Jumper BR2 must not be removed in this case.

15.5 Load resistors

IMPORTANT

Supplier does not assume any responsibility for damage caused by installation of incorrect load resistors.

Operation without load resistors in armature circuit (R17 to R20) leads to destruction of current transformers.

Spare modules are delivered without load resistors!

Load resistors in the armature circuit						Load resistors in the field circuit				
Conv. rated current	reduced rated current	Current transformer ratio	Load resistors on A2 Tolerance: 0,5%		active value	Field rated current	reduced field current	Load resistors on A2		active value
			R17,R19	R18,R20				R51	R52	
A	A	1:	Ω	Ω	Ω	A	A	Ω	Ω	Ω
30	--	2000	267	88,7	66,58	5	--	1,8k	680	493,5
--	22,5	2000	--	88,7	88,7	--	3,7	--	680	680
--	7,5	2000	267	--	267	--	1,4*)	1,8k	--	1,8k
60	--	5000	332	111	83,19	10	--	3k	1,5k	1k
--	45	5000	--	111	111	--	6,7	--	1,5k	1,5k
--	15	5000	332	--	332	--	3,3*)	3k	--	3k
90	--	5000	180	75,9	56,0					
--	66	5000	--	75,9	75,9					
--	28	5000	180	--	180					
130	--	5000	100	61,2	37,69	10	--	3k	1,5k	1k
--	82	5000	--	61,2	61,2	--	6,7*)	--	1,5k	1,5k
--	50	5000	100	--	100	--	3,3	3k	--	3k
190	--	5000	75,9	40,2	26,28	15	--	2k	1k	666,7
--	124	5000	--	40,2	40,2	--	10*)	--	1k	1k
--	66	5000	75,9	--	75,9	--	5	2k	--	2k
250	--	5000	61,2	29,4	19,85					
--	170	5000	--	29,4	29,4					
--	82	5000	61,2	--	61,2					
400	--	2000	20,5	6,65	5,02	25	--	1k	680	404,7
--	300	2000	--	6,65	6,65	--	15*)	--	680	680
--	98	2000	20,5	--	20,5	--	10	1k	--	1k
600	--	2000	13,3	4,42	3,32					
--	452	2000	--	4,42	4,42					
--	150	2000	13,3	--	13,3					

*) as supplied

15.6 Fuses

NOTE

Protection of thyristors cannot be guaranteed if fuse ratings deviating from the description are fitted.

Fuses for armature circuit

Converter		Fuses		DC fuse	
Rated DC current	Order No.	Phase fuse Order No.	Rated current	Order No.	Rated current
A			A		A
30	6RA2718-6DV5.-0	3NE8 003 *)	35	3NE8 003 *)	35
60	6RA2725-6DV5.-0	3NE8 017 *)	50	3NE8 018 *)	63
90	6RA2728-6DV5.-0	3NE8 020 *)	80	3NE8 021 *)	100
130	6RA2732-6DV5.-0	3NE8 022 *)	125	3NE8 022 *)	125
190	6RA2775-6DV5.-0	3NC8 423 *)	150	3NC8 425 *)	200
250	6RA2777-6DV5.-0	3NC8 425 *)	200	3NC8 427 *)	250
400	6RA2781-6DV5.-0	3NE3 431 *)	350	3NC8 434 *)	500
600	6RA2785-6DV5.-0	3NE4 334 - 0B *)	500	3NE4 337 *)	710
30	6RA2718-6GV5.-0	3NE8 015 *)	25	3NE8 003 *)	35
60	6RA2725-6GV5.-0	3NE8 017 *)	50	3NE8 018 *)	63
90	6RA2728-6GV5.-0	3NE8 020 *)	80	3NE8 021 *)	100
130	6RA2732-6GV5.-0	3NE8 022 *)	125	3NE4 124 *)	160
190	6RA2775-6GV5.-0	3NC8 423 *)	150	3NC8 425 *)	200
250	6RA2777-6GV5.-0	3NE3 626 *)	224	3NE4 327 - 0B *)	250
400	6RA2781-6GV5.-0	3NE3 431 *)	350	3NE4 333 - 0B *)	450
600	6RA2785-6GV5.-0	3NE4 334 - 0B *)	500	170L5191 **)	630

Fuses for field circuit

Converter	Field rectifier		Fuse	
Rated DC current	Rated supply voltage	Max. perm. rated field current	Order No.	Rated current
A	V	A		A
30	380V single-ph. AC	5	5SD4 20 *)	16
60 bis 130		10	5SD4 20 *)	16
190 bis 250		15	5SD4 20 *)	16
400 bis 600		25	5SD4 40 *)	25

*) Manufactured by SIEMENS

**) Manufactured by Bussmann



Automation Systems
for Machine Tools, Robots and
Special-Purpose Machines

Issued by:
Geratewerk Wien
Postfach 83, A1211 Wien

© Siemens AG 1989
Subject to change without notice

Siemens Aktiengesellschaft

Order No. C98130-A1073-A2-09-7619
Printed in Austria

