

SMARTDRIVE
Frequency Inverters
VF1000 Series S/M/L
(0,37 - 22 kW)
Technical Specifications



CONTENTS

CHAPTER 1	Frequency inverter VF1000S (0.37 - 0.75 kW)	
	Design and layout	1-2
	Technical Specifications	1-3
	Dimensional drawings	1-4
	Power and control connections	1-6
	Control connections, VF1000S,xx	1-7
	Ordering Informations	1-8
	Design codes	1-9
CHAPTER 2	Frequency Inverter VF1000M (1.1 - 4 kW)	
	Design and layout	2-1
	Technical Specifications	2-2
	Power and control connections (230 V devices)	2-4
	Power and control connections (400/460 V devices)	2-5
	Ordering Informations	2-6
	Design codes	2-7
CHAPTER 3	Frequency Inverters VF1000L and VF1000L, HF (4 - 22 kW)	
	Design and layout	3-1
	Technical Specifications	3-2
	Technical data VF1000L, HF (to 800/1600 Hz phase-sequence frequency)	3-3
	Dimensional drawings	3-4
	Power and control connections	3-5
	Ordering Informations	3-6
	Design codes VF1000L and VF1000L, HF	3-7
CHAPTER 4	Accessories for VF1000S/M/L	
	Mains filters	4-2
	Line chokes	4-4
	Interface adapters for KEYPAD connection	4-6
	Control unit KEYPAD KP100	4-6
	SMARTCARD	4-6
	Braking resistor accessories for VF1000M	4-7
	Brake choppers BC1300/1400 for VF1000S	4-8
	Brake chopper unit BC4000 for VF1000L	4-10
	Accessories to PROFIBUS-DP	4-12
	User information	4-14

CHAPTER 1 FREQUENCY INVERTER VF1000S

Design and layout

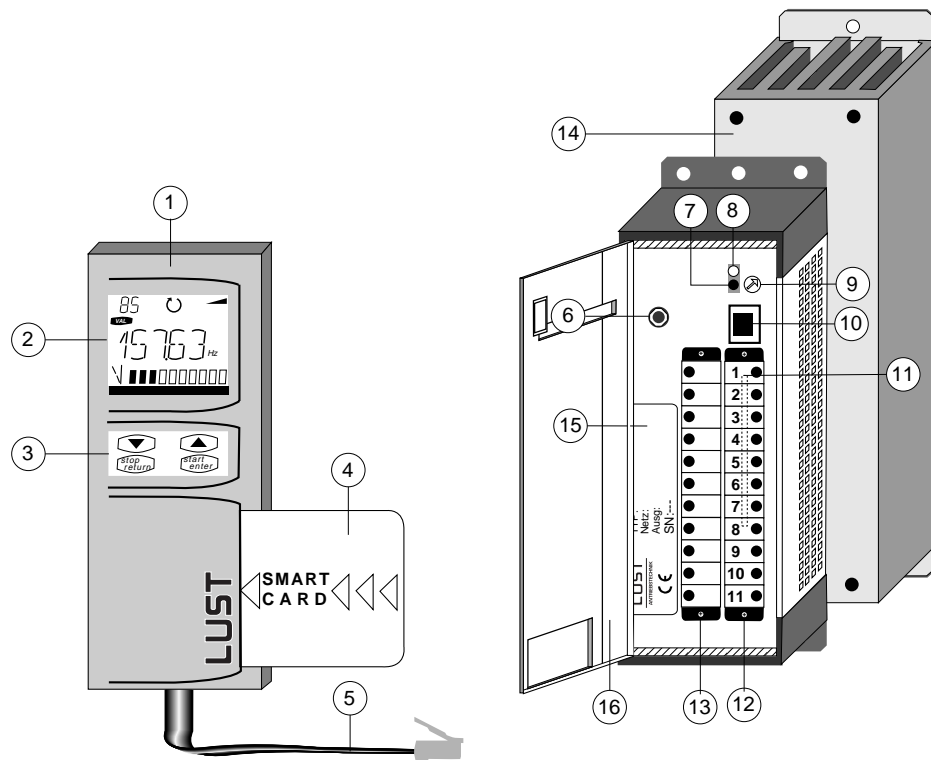

Legend

No.	Function	No.	Function
1	Control unit KEYPAD KP100 ¹⁾	9	Integral potentiometer P1, programmable
2	LCD display panel (140 seg.)	10	Socket for KEYPAD KP100
3	Membrane keypad	11	Jumper strip (concealed behind control conn.)
4	SMARTCARD ¹⁾	12	Terminal strip, control connections detachable
5	KEYPAD KP100 cable (length 0.35 m)	13	Terminal strip, power connections detachable
6	⊕ Connection point for protective earth and screen	14	Heat sink
7	LED H1 (red), "error" indicator	15	Name plate
8	LED H2 (green), "on" indicator	16	Housing cover

Regulations and standards

CE	Conformity under the terms of Machinery Directive 89/392/EEC	All VF1000S devices
UL	UL-recognized, FILE: E146022	All VF1000S devices
EMC	Compliance with technical standards EN50081-1 (interference emission: residential environment) EN50082-2 (interference immunity: industrial environment)	All VF1000S devices, with use of an appropriate mains filter ¹⁾

¹⁾ For further information see "Accessories"

Output motor-side

	Des.	Dim.	VF1104S	VF1202S	VF1204S	VF1402S
Rec. rated power with 4-pole standard motor	P	W	375	375	750	750
Device power referred to mains voltage ¹⁾	S	VA	670	840	1400	1450
Voltage	U	V	3x0...110	3x0...230		3x0...400/460
Rated current ¹⁾ (110 V)	I_N	A	3,2	-	-	-
Rated current ¹⁾ (230 V)	I_N	A	-	1,9	3,2	-
Rated current ¹⁾ (400/460 V)	I_N	A	-	-	-	1,9/1,7
Continuous current ¹⁾ (110 V)	$1,1xI_N$	A	3,5	-	-	-
Continuous current ¹⁾ (230 V)	$1,1xI_N$	A	-	2,1	3,5	-
Continuous current ¹⁾ (400/460 V)	$1,1xI_N$	A	-	-	-	2,1/1,9
Overload current ¹⁾ for 60 s	$1,5xI_N$	A	4,8	2,9	4,8	2,9
Phase-sequence frequency	f	Hz	0 ... 400			
Frequency resolution	-	%	0,1 from FMAX (0,05 Hz min.)			
Mains voltage	U	V	1 x 110 +30/-20%	1 x 230 +15/-20%		3 x 400 -15% 3 x 460 +10%
Asymmetry of mains voltage	-	%	-			≤ 3
Frequency	F	Hz	48 ... 62			
Rec. mains fusing	I	AT	1 x 10	1 x 10	1 x 10	3 x 10
Efficiency ^{1) 3)}	η	%	95	96	95	94
Power loss ³⁾	P_V	W	30	25	35	45
Cooling air temp. (1000 m above sea level)	T_N	°C	0 ... 40			
Type of cooling			Convection			
Relative air humidity	rF	%	15 ... 85, non-condensing (VDE0160)			
Power reduction as a function of cooling air temperature	ΔP_T	%/°C	2,5 in range 40 ... 50 °C			
Power reduction as a function of mounting height	ΔP_H	%/m	5 per 1000 m above seal level, max. 2000 m above seal level			
Storage temperature	T_L	°C	-25 ... +55 (VDE0160)			
Transport temperature	T_T	°C	-25 ... +70 (VDE0160)			
Permissible vibration			2 g (IEC 68-2-6)			
Protection	-	-	(IP20, VBG4, NEMA 1) ²⁾			
Mounting	-	-	Vertical wall mounting			

- 1) Referred to power stage switching frequency of 8 kHz
- 2) Not for VF1000S,G8 + VF1000S,G10
- 3) At rated voltage and rated current

CHAPTER 1 DIMENSIONAL DRAWINGS VF1000S,xx

**Standard
VF1000S
Protection IP20**

	Des.	Dim.	Value	Dimensional drawing
Mass	M	kg	ca.0,9	
Dimen- sions	A	mm	32,5	
	B	mm	∅ 4,8	
	C	mm	183	
	D	mm	170	
	E	mm	65	
	F	mm	133	
G	mm	20		

**Design
VF1000S,G8 ¹⁾
Protection IP00**

Mass	M	kg	ca.0,8	
Dimen- sions	B	mm	∅ 4,8	
	C	mm	183	
	D	mm	170	
	E	mm	63	
	F	mm	110	
	G	mm	20	

**Design
VF1000S,K1
Protection IP20**

Mass	M	kg	ca.1,1	
Dimen- sions	A	mm	32,5	
	B	mm	∅ 4,8	
	C	mm	206,5	
	D	mm	196,5	
	E	mm	65	
	F1	mm	67,5	
F	mm	133		

¹⁾ Control unit KEYPAD KP100 cannot be connected to the frequency inverter with this device version.

CHAPTER 1 DIMENSIONAL DRAWINGS VF1000S,xx

Design
VF1000S, G19, FA
Protection IP20

	Des.	Dim.	Value	Dimensional drawing
Mass	M	kg	ca.1,0	
Dimen- sions	A	mm	32,5	
	B	mm	∅ 4,8	
	C	mm	232,5	
	D	mm	220	
	E	mm	65	
	F	mm	133	
	G	mm	20	

Design
VF1000S, G10, FA, K2 ¹⁾
Protection IP00

Mass	M	kg	ca.1,2	
Dimen- sions	A	mm	32,5	
	B	mm	∅ 4,8	
	C	mm	256,5	
	D	mm	246,5	
	E	mm	63	
	F	mm	187,5	
	F1	mm	67,5	
	F2	mm	110	
	H	mm	220	
	I	mm	232,5	

Design
VF1000S, M3 or
VF1000S, M4
(Protection IP20)

M3	Screen connection	bottom		
M4	Screen connection	top + bottom		
Dimen- sions	B	mm		∅ 4,8
	E	mm		65
	L	mm		30,0
	F3	mm		104
	K	mm	5,6	

¹⁾ Control unit KEYPAD KP100 cannot be connected to the frequency inverter with this device version.

CHAPTER 1 POWER AND CONTROL CONNECTIONS VF1000S

Single-phase feed

VF1104S
VF1202S
VF1204S

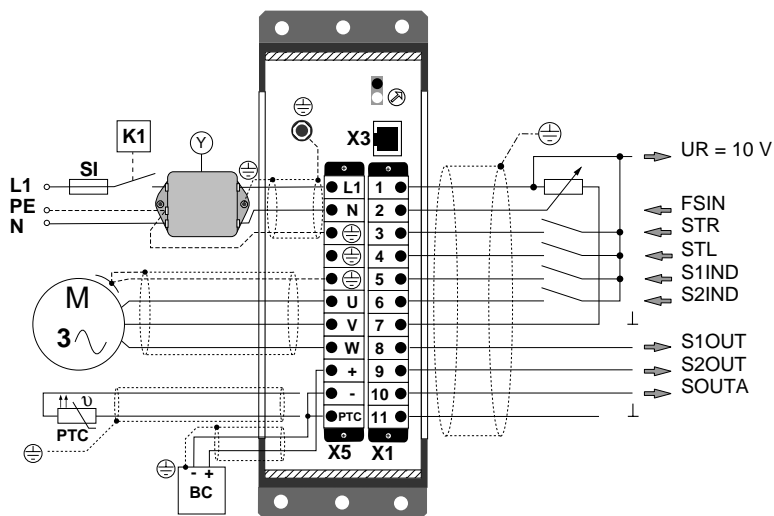

Three-phase feed

VF1402S

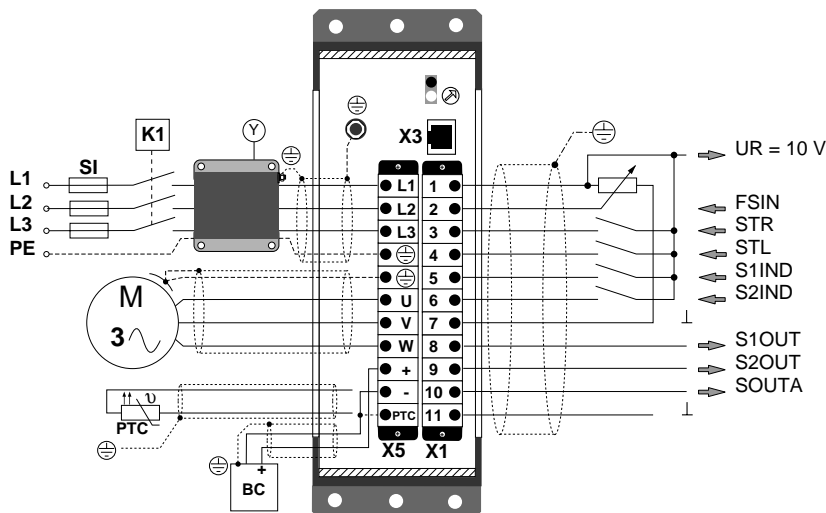

Terminal assignment

X5	Power connections
L1, N, ⊕	Mains connection 1 x 110V for VF1104S Mains connection 1 x 230 V for VF1202S or VF1204S
L1, L2, L3, ⊕	Mains connection 3 x 400/460 V for VF1402S
⊕ U, V, W	Motor connection
+ , -	Connection for dc-link or ext. brake chopper (BC1300/1400)
- , PTC	Connection for motor PTC
K1	Connection example, line contactor
Y	Connection example for external mains filter
⊕	Connection point for protective earth and screen

X1	Des.	Control connections
1	UR	10 V for reference potentiometer
2	FSIN	Reference frequency input 0-10 V, 2-10 V, 0-20 mA, 4-20 mA
3	STR	Start-Right input
4	STL	Start-Left input
5	S1IND	Programmable input, digital
6	S2IND	Programmable input, digital
7, 11	Frame	Controller reference point
8	S1OUT	Prog. output LOW activev
9	S2OUT	Prog. output LOW active
10	SOUTA	Prog. output analog
X3		Socket for control unit KEYPAD KP100

CHAPTER 1 CONTROL CONNECTIONS VF1000S,xx

VF1000S, I1

X1	Des.	Control section I1
1	U_E	Feed voltage for SOUTF, 10-15 V
2	PWM	Reference frequency, 0-100 % PWM, 20-100 % PWM
3	STR	Start-Right input
4	STL	Start-Left input
5	S1IND	Programmable input, digital
6	S2IND	Programmable input, digital
7/11	Frame	Control connection reference point
8	S1OUT	Prog. output LOW active
9	S2OUT	Prog. output LOW active
10	SOUTF	Prog. output with PWM or clock signal

VF1000S, I5 or VF1000S, I7

X1	Des.	Control section I5, I7
1	U_R	10 V ref. for reference potentiometer
2	FSIN	Reference frequency 0-10V, 2-10V, 0-20mA, 4-20mA I5 0-100%PWM, 20-100%PWM I7
3	STR	Start-Right input
4	STL	Start-Left input
5	RxD	Interface RS232
6	TxD	Interface RS232
7	GND	Interface reference point
8	S1OUT	Prog. output LOW active
9	S2OUT	Prog. output LOW active
10	SOUTA	Prog. output with analog signal I5 with PWM or clock signal I7
11	Frame	Control connection reference point

VF1000S, I6

X1	Des.	Control section I6
1		No function
2	FSIN	Reference frequency 0-100 % PWM, 20-100 % PWM
3	STR	Start-Right input
4	STL	Start-Left input
5	A	R/T A for RS485
6	B	R/T B for RS485
7	GND	Interface reference point
8	S1OUT	Prog. output LOW active
9	S2OUT	Prog. output LOW active
10		No function
11	Frame	Control connection reference point

CHAPTER 1 ORDERING INFORMATIONS FOR VF1000S

General

The standard version of the VF1000S frequency inverter is identified by the type designation. Other non-standard designs are identified by suffix design codes appended to the order designation.

Each design code has its own special meaning (see design versions of VF1000S and VF1000S,xx). For inverters not quoted in the list design codes not given here are also used.

From the design options shown, only one design version per terminal location may be ordered.

Order/type designation

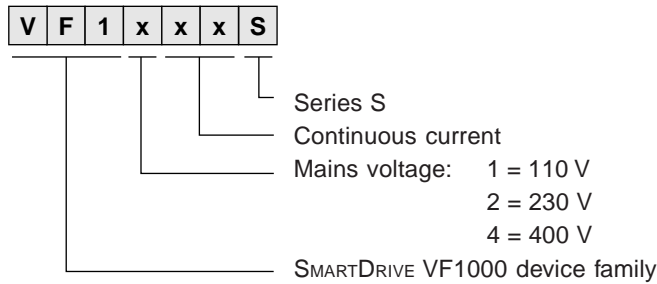

Standard design:

- Analog reference input, 2 digital control inputs
- Varnished all-metal housing with plastic cover for KEYPAD KP100 mounting, protection IP20
- Cold-plate design
- Live automatic circuit-breaker thermostat and thermistor evaluation
- Operation Manual in German

Non-standard design code



The design code is separated by a comma, and can be written in any order.

Example

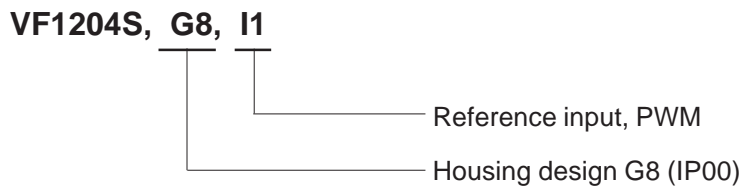

CHAPTER 1 DESIGN CODES OF THE VF1000S

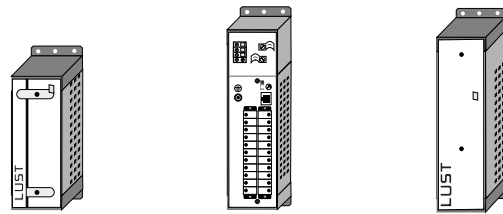

VF1000S

VF1000S,G10,FA

VF1000S,G19,FA

Standard design:

- Analog reference input, 2 digital control inputs
- Varnished all-metal housing with plastic cover for KEYPAD KP100 mounting, protection IP20
- Cold-plate design
- Live automatic circuit-breaker thermostat and thermistor evaluation
- Operation Manual in German

Terminal location	Design code	Short description
Control section	Standard	Analog reference input, 2 digital control inputs
	I1	PWM reference input
	I5	Analog reference input + RS232 to terminals
	I6	PWM reference input + RS485 to terminals
	I7	PWM reference input + RS232 to terminals
Housing	Standard	Varnished all-metal housing with plastic cover for KEYPAD KP100 mounting, protection IP20
	G8	Housing protection IP00, terminals without covering, no mounting option for KEYPAD KP100
Cooling	Standard	Cold-plate design
	K1	Heat sink, for use on thermally insulated mounting surfaces
Mounting	Standard	Attach screen to earthing point
	M3	EMC earthing clamp (on underside of housing) for ease of screen attachment
	M4	EMC earthing clamp (on top and underside of housing) for ease of screen attachment

Only one design version per terminal location is possible.

Note: The KEYPAD KP100 control unit must be ordered separately. For further information see "Accessories".

CHAPTER 1 DESIGN CODES OF THE VF1000S, G10, FA

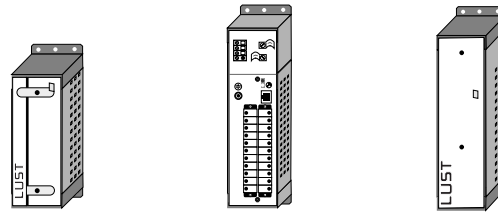

VF1000S

VF1000S,G10,FA

VF1000S,G19,FA

Standard

VF1000S, G10, FA

- Analog reference input, 2 digital control inputs
- All-metal housing, protection IP00, terminals without covering, no mounting option for KEYPAD KP100, (G10)
- Cold-plate design
- With built-in mains filter (FA) to comply with limit curve class A (industrial environment)
- Live automatic circuit-breaker thermostat and thermistor evaluation
- Operation Manual in German

Terminal location	Design code	Short description
Control section	Standard	Analog reference input, 2 digital control inputs
	I1	PWM reference input
	I5	Analog reference input + RS232 to terminals
	I6	PWM reference input + RS485 to terminals
	I7	PWM reference input + RS232 to terminals
Cooling	Standard	Cold-plate design
	K2	Heat sink, for use on thermally insulated mounting surfaces
Mounting	Standard	Two EMC earthing clamps for ease of screen attachment (suitable for cable feed from above)
	M3	EMC earthing clamp (on underside of housing) for ease of screen attachment
Integral mains filter	Standard	With built-in mains filter (FA) to comply with limit curve class A (industrial environment)
	FB	With built-in mains filter to comply with limit curve class B (residential environment) Attention: Inverter type VF1402S is not available with built-in mains filter (FB). To comply with limit curve class B an external mains filter must be used (see "Accessories").

Only one design version per terminal location is possible.

Note: The KEYPAD KP100 control unit must be ordered separately. For further information see "Accessories".

CHAPTER 1 DESIGN CODES OF THE VF1000S, G19, FA

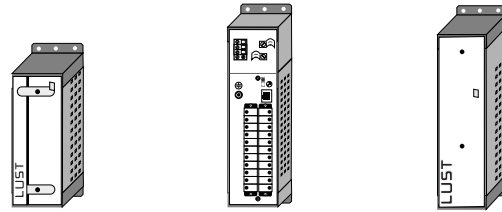

VF1000S

VF1000S,G10,FA

VF1000S,G19,FA

Standard

VF1000S, G19, FA

- Analog reference input, 2 digital control inputs
- Varnished all-metal housing with metal cover for KEYPAD KP100 mounting, protection IP20, (G19)
- Cold-plate design
- With built-in mains filter (FA) to comply with limit curve class A (industrial environment)
- Live automatic circuit-breaker thermostat and thermistor evaluation
- Operation Manual in German

Terminal location	Design code	Short description
Control section	Standard	Analog reference input, 2 digital control inputs
	I1	PWM reference input
	I5	Analog reference input + RS232 to terminals
	I6	PWM reference input + RS485 to terminals
	I7	PWM reference input + RS232 to terminals
	C8	INTERBUS-S interface for remote bus connection
	C2	CAN-Bus interface
	CP	Prepared for PROFIBUS Gateway type CP-DP1 (see "Accessories")
Cooling	Standard	Cold-plate design
	K2	Heat sink, for use on thermally insulated mounting surfaces
Mounting	Standard	Two EMC earthing clamps for ease of screen attachment
	M3	EMC earthing clamp (on underside of housing) for ease of screen attachment
Integral mains filter	Standard	With built-in mains filter (FA) to comply with limit curve class A (industrial environment)
	FB	With built-in mains filter to comply with limit curve class B (residential environment)
		Attention: Inverter type VF1402S is not available with built-in mains filter (FB). To comply with limit curve class B an external mains filter must be used (see "Accessories").

Only one design version per terminal location is possible.

Note: The KEYPAD KP100 control unit must be ordered separately. For further information see "Accessories".

CHAPTER 2 FREQUENCY INVERTER VF1000M

Design and layout

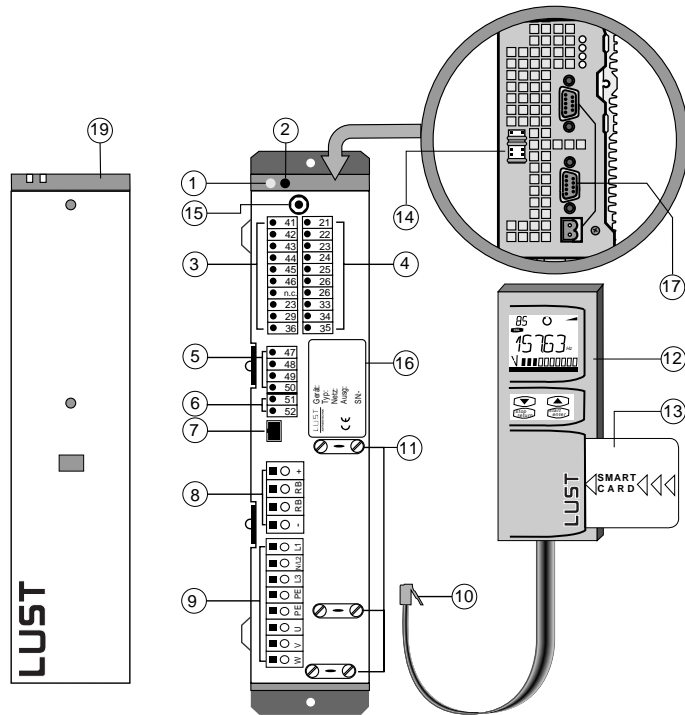

Legend

No.	Function	No.	Function
1	LED H2 (green), "on" indicator	11	EMC earthing clamps for ease of screen attachment
2	LED H1 (yellow), "error" indicator	12	Control unit KEYPAD KP100 ¹⁾
3	Terminal strip, control outputs	13	SMARTCARD ¹⁾
4	Terminal strip, control inputs	14	Jumper strip J1 to J6
5	Term. strip for design C9 (RS485) or C12 (RS232)	15	⊕ Connection point for protective earth and screen
6	Term. strip for design PTC or PT1	16	Name plate
7	Socket for KEYPAD KP100	17	D-sub plug-in connections for design C2 (CAN-Bus) or C8 (INTERBUS-S)
8	Term.strip for braking resistor/ DC-link connection	18	KEYPAD KP100 cable (length 0.35 m)
9	Terminal strip for power connections	19	Housing cover
10	KEYPAD KP100 connector		

Regulations and standards

CE	Conformity under the terms of Machinery Directive 89/392/EEC	All VF1000M devices
UL	UL-recognized, FILE: E146022	Application for test mark submitted (PROJECT No.: 97ME12052)
EMC	Compliance with technical standards EN50081-1 (interference emission: residential environment) EN50082-2 (interference immunity: industrial environment)	All VF1000M devices, with use of an appropriate mains filter ¹⁾

¹⁾ For further information see "Accessories"

CHAPTER 2 TECHNICAL SPECIFICATIONS VF1000M

New!
Available
from Sep.97

	Des.	Dim.	VF1205M	VF1207M	VF1404M	VF1406M	VF1408M	VF1410M	
Output motor-side	Rec. rated power with 4-pole standard motor	P	kW	1,1	1,5	1,5	2,2	3	4
	Device power referred to mains voltage ¹⁾	S	kVA	1,9	2,7	2,6	3,8	5,4	6,3
	Voltage	U	V	3 x 0 ... 230		3 x 0 ... 400/460			
	Rated current ¹⁾ (230 V)	I _N	A	4,5	6,2	-	-	-	-
	Rated current ¹⁾ (400/460 V)	I _N	A	-	-	3,5/3,1	5/4,7	7,2/6,3	8,9/7,7
	Cont. current ¹⁾ (230 V)	1,1xI _N	A	5	6,8	-	-	-	-
	Cont. current ¹⁾ (400/460 V)	1,1xI _N	A	-	-	3,8/3,4	5,5/5,1	7,9/7,0	9,8/8,5
	Overload current ¹⁾ for 60 s	1,5xI _N	A	6,8	9,8	5,3	7,5	10,8	13,3
	Phase-sequence frequency	f	Hz	0...400					
	Frequency resolution	-	%	0,1 from FMAX (0,05 Hz min.)					
Input mains-side	Mains voltage	U	V	1 x 230 +15/-20%		3 x 400 -15%/ 460 +10%			
	Asymmetry of mains voltage		%	-		≤ 3			
	Frequency	f	Hz	48 ... 62					
	Rec. mains fusing	I	AT	1 x 16	1 x 16	3 x 10	3 x 10	3 x 10	3 x 16
	Efficiency ^{1) 3)}	η	%	94	94	95	95	96	95
	Power loss ³⁾	P _V	W	65	82	80	100	120	150
Brake chopper with design version (BR1)	Peak braking power with integral braking res.	P _{Sp}	kW	1,65 max.					
	Cyclic braking	P _{eff}	W	90	90	90	90	90	90
External braking resistor connection ²⁾	Minimum braking res. for external mounting	R _{min}	Ω	50	50	180	180	180	180
	Brake chopper starting voltage	U _{ZK}	VDC	390	390	760	760	760	760

¹⁾ Referred to power stage switching frequency of 8 kHz

²⁾ Not permitted for design BR1

³⁾ At rated voltage and rated current

CHAPTER 2 TECHNICAL SPECIFICATIONS VF1000M

New!
Available
from Sep. 97

Ambient conditions

	Bez.	Dim.	VF1205M	VF1207M	VF1404M	VF1406M	VF1408M	VF1410M
Cooling air temperature (1000 m above sea level)	T_N	°C	0 ... 40					
Type of cooling			Convection			Forced cooling		
Relative air humidity	rF	%	15 ... 85, non-condensing (VDE0160)					
Power reduction as a function of cooling air temperature	ΔP_T	%/°C	2,5 in range 40 ... 50 °C					
Power reduction as a function of mounting height	ΔP_H	%/m	5 per 1000 m above sea level max. 2000 m above sea level					
Storage temperature	T_L	°C	-25 ... +55 (VDE0160)					
Transport temperature	T_T	°C	-25 ... +70 (VDE0160)					
Permissible vibration			2 g (IEC 68-2-6)					
Protection	-	-	IP20, VBG4, NEMA 1					
Mounting	-	-	Vertical wall mounting					
Mass	m	Kg	3,75					
Dimensions	A	mm	34,5					
	B	mm	4,8					
	C	mm	330/344 ⁴⁾			344		
	D	mm	315					
	E	mm	69					
	F	mm	245					
	F1	mm	112 ⁵⁾					
	G	mm	40					
	I	mm	220 ⁶⁾					

⁴⁾ Forced cooling with attachment fan in design FA

⁵⁾ With flat device mounting, not possible with design FA

⁶⁾ In design G16 (without terminal covering)

CHAPTER 2 POWER AND CONTROL CONNECTIONS VF1200M

Single-phase feed

VF1205M
VF1207M

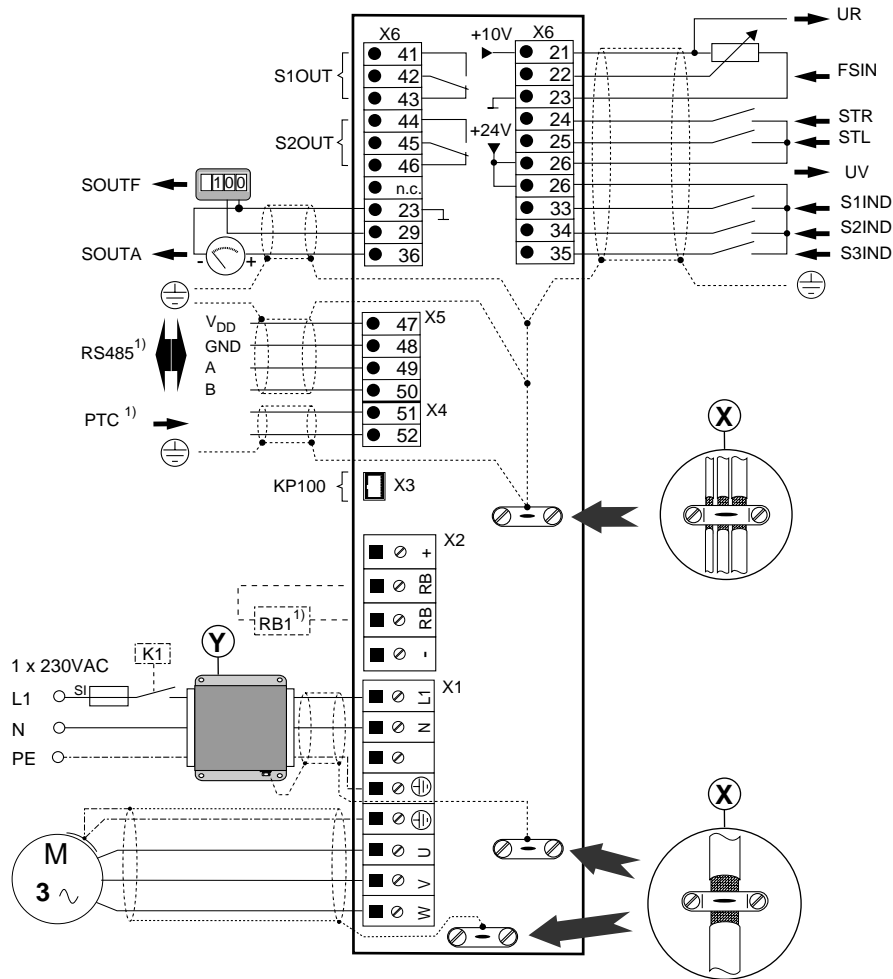

Terminal assignment

X6	Des.	Control connections
21	UR	10V for reference potentiometer
22	FSIN	Reference frequency input 0-10 V, 2-10 V, 0-20 mA, 4-20 mA 0-1 kHz, 0-10 kHz, 0-100 % PWM, 20-100 % PWM
23	Frame	Controller reference point
24	STR	Start-Right input
25	STL	Start-Left input
26	UV	Control voltage 24 V DC
29	SOUTF	Digital frequency output
33	S1IND	Programmable input, digital
34	S2IND	Programmable input, digital
35	S3IND	Programmable input, digital
36	SOUTA	Prog. output analog
41	S1OUT	NC contact of relay 1
42		Center spring of relay 1
43		NO contact of relay 1
44	S2OUT	NC contact of relay 2
45		Center spring of relay 2
46		NO contact of relay 2

X1	Power connections
L1, N, \oplus	Mains connection 1 x 230 V
\oplus U, V, W	Motor connection 3 x 230 V
X2/ +, -	Connection for dc-link
X2/ RB	Connection for ext. braking resistor
X3	Socket for control unit KeyPad KP100
X4/51, 52	Connection for motor PTC ¹⁾
X5/ 47,48,49,50	Terminals for interface RS485 ¹⁾ or RS232 ¹⁾
K1	Connection example, line contactor
Y	Connection example for external mains filter
\oplus	Protective earth
X	EMC earthing clamps for ease of screen attachment

¹⁾ Terminal function depends on the design version ordered.

CHAPTER 2 POWER AND CONTROL CONNECTIONS VF1400M

Three-phase feed

VF1404M
VF1406M
VF1408M
VF1410M

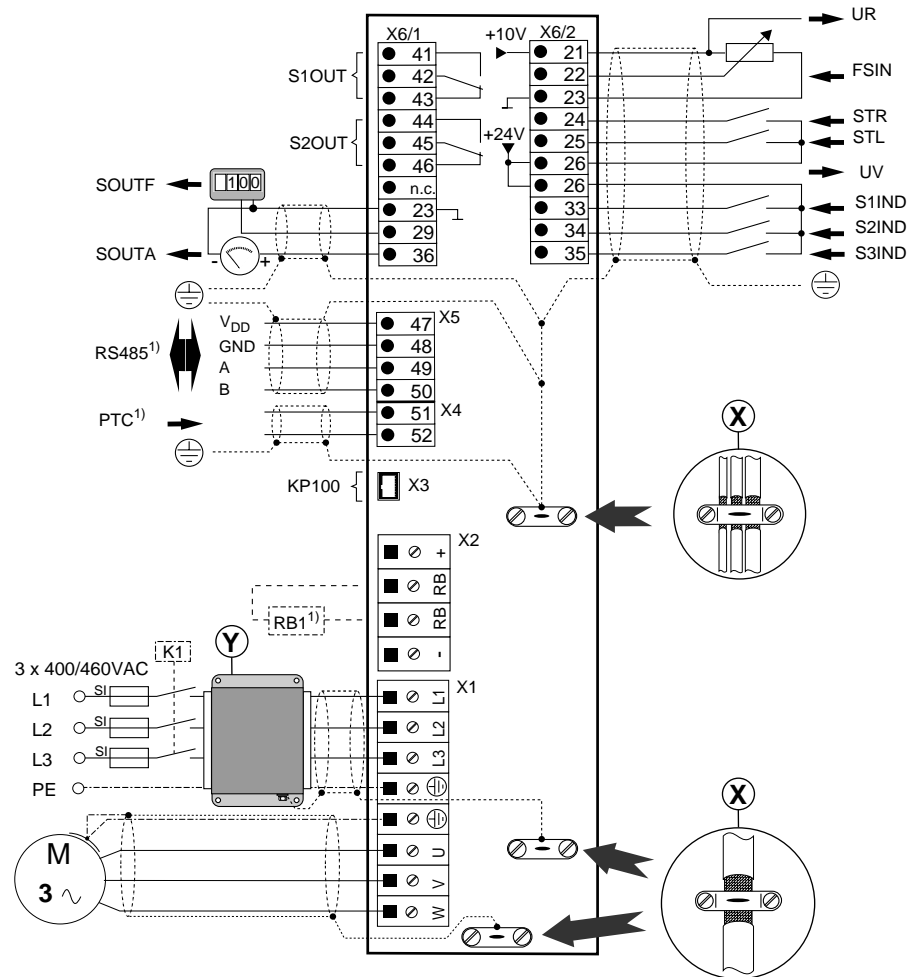

Terminal assignment

X6	Des.	Control connections
21	UR	10V for reference potentiometer
22	FSIN	Reference frequency input 0-10 V, 2-10 V, 0-20 mA, 4-20 mA 0-1 kHz, 0-10 kHz, 0-100 %PWM, 20-100 %PWM
23	Frame	Controller reference point
24	STR	Start-Right input
25	STL	Start-Left input
26	UV	Control voltage 24 V DC
29	SOUTF	Digital frequency output
33	S1IND	Programmable input, digital
34	S2IND	Programmable input, digital
35	S3IND	Programmable input, digital
36	SOUTA	Prog. output analog
41	S1OUT	NC contact of relay 1
42		Center spring of relay 1
43		NO contact of relay 1
44	S2OUT	NC contact of relay 2
45		Center spring of relay 2
46		NO contact of relay 2

X1	Power connections
L1, L2, L3 ⊕	Mains connection 3 x 400/460 V
⊕ U, V, W	Motor connection 3 x 400/460 V
X2/ +, -	Connection for dc-link
X2/ RB	Connection for ext. braking resistor
X3	Socket for control unit KEYPAD KP100
X4/51, 52	Connection for motor PTC ¹⁾
X5/ 47, 48, 49, 50	Terminals for interface RS485 ¹⁾ or RS232 ¹⁾
K1	Connection example, line contactor
Y	Connection example for external mains filter
⊕	Protective earth
X	EMC earthing clamps for ease of screen attachment

¹⁾ Terminal function depends on the design version ordered.

CHAPTER 2 ORDERING INFORMATIONS FOR VF1000M

General

The standard version of the VF1000M frequency inverter is identified by the type designation. Other non-standard designs are identified by suffix design codes appended to the order designation.

Each design code has its own special meaning (see design versions of VF1000M). For inverters not quoted in the list design codes not given here are also used.

From the design options shown, only one design version per terminal location may be ordered.

Order/type designation

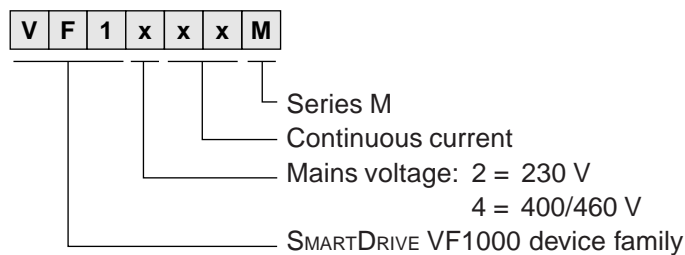

Standard design:

- Varnished all-metal housing with metal cover for KEYPAD KP100 mounting, protection IP20
- With brake chopper power electronics, without braking resistor in device heat sink
- Operation Manual in German

Non-standard design code

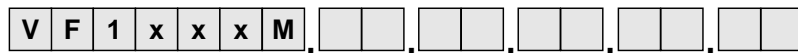

The design code is separated by a comma, and can be written in any order

Example

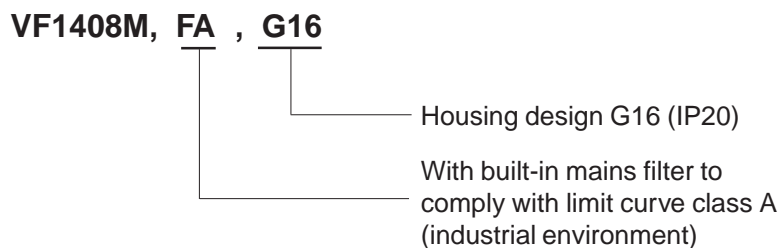

CHAPTER 2 DESIGN CODES OF THE VF1000M

Terminal location	Design code	Short description
Interface 1	Standard	No function
	C2	CAN-BUS interface
	C8	INTERBUS-S interface for remote bus connection
	TR	Technical Controller with an additional analog input (± 10 V)
	S58	Technical Controller
	CP	Prepared for PROFIBUS Gateway type CP-DP1 (see "Accessories")
Interface 2	Standard	No function
	C9	RS485 isolated to terminals
	C12	RS232 isolated to terminals
Temperature monitor	Standard	No function
	PTC	Thermistor evaluation to DIN 44081/44082 with short-circuit monitoring
	PT1	Evaluation of an automatic circuit-breaker thermostat
Braking resistor	Standard	Brake chopper power electronics, without braking resistor in device heat sink
	BR1	Brake chopper power electronics, with braking resistor in device heat sink
Integral mains filter	Standard	Without mains filter
	FA	With built-in mains filter to comply with limit curve class A (industrial environment) Attention: Inverter type VF1410M is not available with built-in mains filter FA. To comply with limit curve classes A and B an external mains filter must be used (see "Accessories").
Housing	Standard	Varnished all-metal housing with metal cover for KEYPAD KP100 mounting
	G16	Standard housing design without terminal covering (metal cover), no mounting option for KEYPAD KP100

Only one design version per terminal location is possible.

Note: The KEYPAD KP100 control unit must be ordered separately. For further information see "Accessories".

CHAPTER 3 FREQUENCY INVERTERS VF1000L AND VF1000L, HF

Design and layout

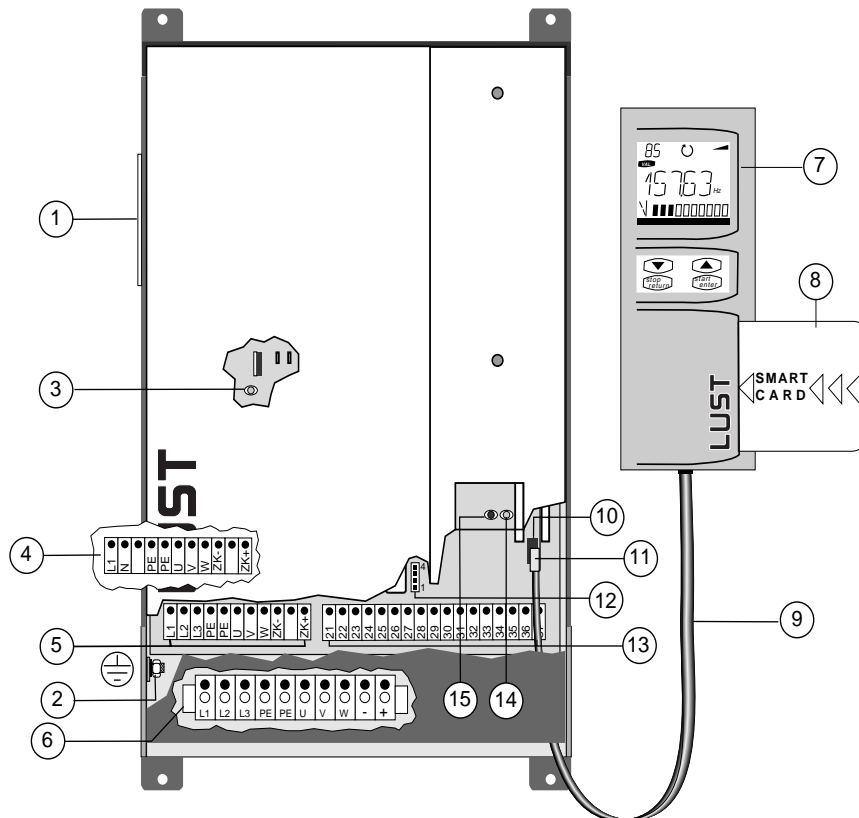

Legend

No.	Function	No.	Function
1	Name plate	7	Control unit KEYPAD KP100 ¹⁾
2	Connection point for protective earth and screen	8	SMARTCARD ¹⁾
3	LED (yellow) signals brake chopper activity	9	KEYPAD KP100 cable (length 0.35 m)
4	Terminal strip for power connections, VF1209L	10	Terminal strip for interface RS485
5	Terminal strip for power connections, VF1410L ... VF1414L	11	Socket for KEYPAD KP100
6	Terminal strip for power connections, VF1418L ... VF1445L	12	Jumper strip
		13	Terminal strip, control connections detachable
		14	LED H1 (yellow), "error" indicator
		15	LED H2 (green), "on" indicator

Regulations and standards

CE	Conformity under the terms of Machinery Directive 89/392/EEC	All VF1000L devices
UL	UL-recognized, FILE: E146022	All VF1000L devices
EMC	Compliance with technical standards	VF1209L/VF1410/14/18L with mains filter ¹⁾
	EN50081-1 (interference emission: residential environment)	VF1424/32/45L with mains filter ¹⁾
	EN50082-2 (interference immunity: industrial environment)	All VF1000L devices, with use of an appropriate mains filter ¹⁾

¹⁾ For further information see "Accessories"

CHAPTER 3 TECHNICAL SPECIFICATION VF1000L

Output motor-side

Input mains-side

Brake chopper

Ambient conditions

	Des.	Dim.	VF1209L	VF1410L	VF1414L	VF1418L	VF1424L	VF1432L	VF1445L
Rec. rated power with 4-pole standard motor	P	kW	2,2	4,0	5,5	7,5	11	15	22
Device power referred to mains voltage	S	kVA	3,8 ¹⁾	6,7 ¹⁾	9,5 ¹⁾	12,6 ¹⁾	17,5 ²⁾	22,8 ²⁾	32,7 ⁴⁾
Voltage	U	V	3x0...230	3 x 0 ... 400/460					
Rated current (230 V)	I _N	A	9,6 ¹⁾	-	-	-	-	-	-
Rated current (400/460 V)	I _N	A	-	8,9/7,8 ¹⁾	12,5/10,8 ¹⁾	16,5/14,4 ¹⁾	23/20 ²⁾	30/26 ²⁾	43/38 ⁴⁾
Continuous current (230 V)	1,1xI _N	A	10,5 ¹⁾	-	-	-	-	-	-
Continuous current (400/460 V)	1,1xI _N	A	-	9,8/8,6 ¹⁾	13,8/11,3 ¹⁾	18,2/16 ¹⁾	25,3/22 ²⁾	33/28,6 ²⁾	47,3/41,8 ⁴⁾
Overload current ¹⁾ for 60 s	1,5xI _N	A	14,4 ¹⁾	13,5 ¹⁾	18,8 ¹⁾	25 ¹⁾	34,5 ²⁾	45 ²⁾	56 ⁴⁾
Phase-sequence frequency	f	Hz	0...400						0 ... 200
Frequency resolution	-	%	0,1 from FMAX (0,05 Hz min.)						
Mains voltage	U	V	1 x 230V +15/-20%	3 x 400 -15%/ 460 +10%					
Asymmetry of mains voltage	-	%	-	≤ 3					
Frequency	f	Hz	48 ... 62						
Rec. mains fusing	I	AT	1 x 16	3 x 16	3 x 20	3 x 25	3 x 35	3 x 50	3 x 63
Efficiency ^{1) 3)}	η	%	95	96	97	≤ 97	≤ 97	≤ 97	≤ 97
Power loss	P _V	W	140	160	180	225	330	400	500
Peak braking power	P _{Sp}	kW	1,65	6,0					
Cyclic braking	P _{eff}	W	90	60	0	40	110	0	0
Cooling air temperature (up to 1000 m above sea level)	T _N	°C	0 ... 40						
Type of cooling			Forced cooling						
Relative air humidity	rF	%	15 ... 85, non-condensing (VDE 0160)						
Power reduction as a function of cooling air temperature	ΔP _T	%/°C	2,5 in range 40 ... 50 °C						
Power reduction as a function of mounting height	ΔP _H	%/m	5 per 1000 m above sea level max. 2000 m above sea level						
Storage temperature	T _L	°C	-25 ... +55 (VDE0160)						
Transport temperature	T _T	°C	-25 ... +70 (VDE0160)						
Permissible vibration			2 g (IEC 68-2-6)						
Protection	-	-	IP20, VBG4						
Mounting	-	-	Vertical wall mounting						

¹⁾ Figures relate to a power stage switching frequency of 8 kHz

²⁾ Figures relate to a power stage switching frequency of 3.9 kHz

³⁾ At rated voltage and rated current

⁴⁾ Figures relate to a power stage switching frequency of 1.9 kHz

CHAPTER 3 TECHNICAL SPECIFICATION VF1000L, HF

FMAX = 800 Hz

Software setting

The data table is valid at a power stage switching frequency of 7.8 kHz (74-PWM = 2) and a phase-sequence frequency up to max. 800 Hz.

Output motor-side

	Des.	Dim.	VF1408L, HF	VF1410L, HF	VF1414L, HF	VF1418L, HF	VF1424L, HF	
Device power	S	kVA	4,9	6,1	8,6	11,4	15,9	
Voltage	U	V	3 x 0 ... 400/ 460					
Rated current ¹⁾ (400/460 V)	I _N	A	7,2/6,2	8,9/7,8	12,5/10,8	16,5/14,5	23/20	
Continuous current ¹⁾ (400/460 V)	1,1xI _N	A	8/6,8	9,8/8,6	13,8/11,9	18,2/16	25,3/22	
Overload current ¹⁾ for 60 s	1,5xI _N	A	10,8	13,5	18,8	25	34,5	
Phase-sequence frequency	f	Hz	0 ... 800					
Mains voltage	U	V	3 x 400 -15% / 460 +10%					
Asymmetry of mains voltage	-	%	≤ 3					
Frequency	f	Hz	48 ... 62					
Rec. mains fusing	I	AT	3 x 16	3 x 16	3 x 20	3 x 25	3 x 35	
Efficiency ^{1) 3)}	η	%	96	96	97	97	97	
Power loss ³⁾	P _V	W	130	170	200	240	350	

Input mains-side

³⁾ At rated voltage and rated current

FMAX = 1600 Hz

Software setting

The data table is valid at a power stage switching frequency of 15.6 kHz (74-PWM = 3) and a phase-sequence frequency up to max. 1600 Hz.

Output motor-side

	Des.	Dim.	VF1408L, HF	VF1410L, HF	VF1414L, HF	VF1418L, HF	VF1424L, HF	
Device power	S	kVA	3,8	4,9	6,1	8,6	11,4	
Voltage	U	V	3 x 0 ... 400/ 460					
Rated current ¹⁾ (400/460 V)	I _N	A	5,6/4,8	7,2/6,2	8,9/7,8	12,5/10,8	16,5/14,4	
Continuous current ¹⁾ (400/460 V)	1,1xI _N	A	6,2/5,3	8/6,8	9,8/8,6	13,8/11,9	18,2/16	
Overload current ¹⁾ for 60 s	1,5xI _N	A	8,4	10,8	13,5	18,8	25	
Phase-sequence frequency	f	Hz	0 ... 1600					
Mains voltage	U	V	3 x 400 -15% / 460 +10%					
Asymmetry of mains voltage	-	%	≤ 3					
Frequency	f	Hz	48 ... 62					
Rec. mains fusing	I	AT	3 x 16	3 x 16	3 x 20	3 x 25	3 x 35	
Efficiency ^{1) 3)}	η	%	95	95	95	96	96	
Power loss ³⁾	P _V	W	110	130	170	200	240	

Input mains-side

³⁾ At rated voltage and rated current

Dimensional drawing
(referred to both dimension tables)

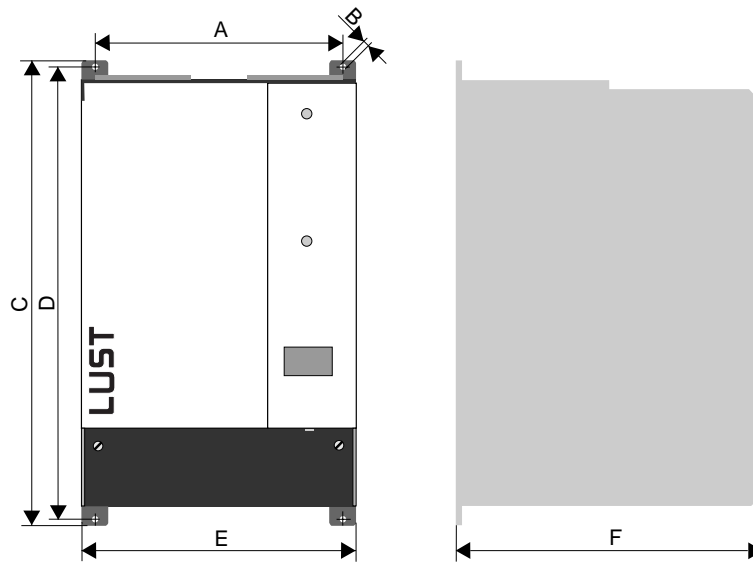

Dimension table
VF1000L

	Des.	Dim.	VF1209L	VF1418L	VF1424L	VF1432L	VF1445L
			VF1410L, VF1414L				
Mass	M	kg	ca. 6,9		ca. 10,1	ca. 10,7	ca. 11,5
Dimensions	A	mm	175				
	B	mm	Ø 5,8				
	C	mm	350				
	D	mm	340				
	E	mm	210				
	F	mm	180	272			

Dimension table
VF1000L, HF

	Des.	Dim.	VF1408L, HF	VF1410L, HF	VF1414L, HF	VF1418L, HF	VF1424L, HF
			Mass	M	kg	ca. 6,9	
Dimensions	A	mm	175				
	B	mm	Ø 5,8				
	C	mm	350				
	D	mm	340				
	E	mm	210				
	F	mm	180	272			

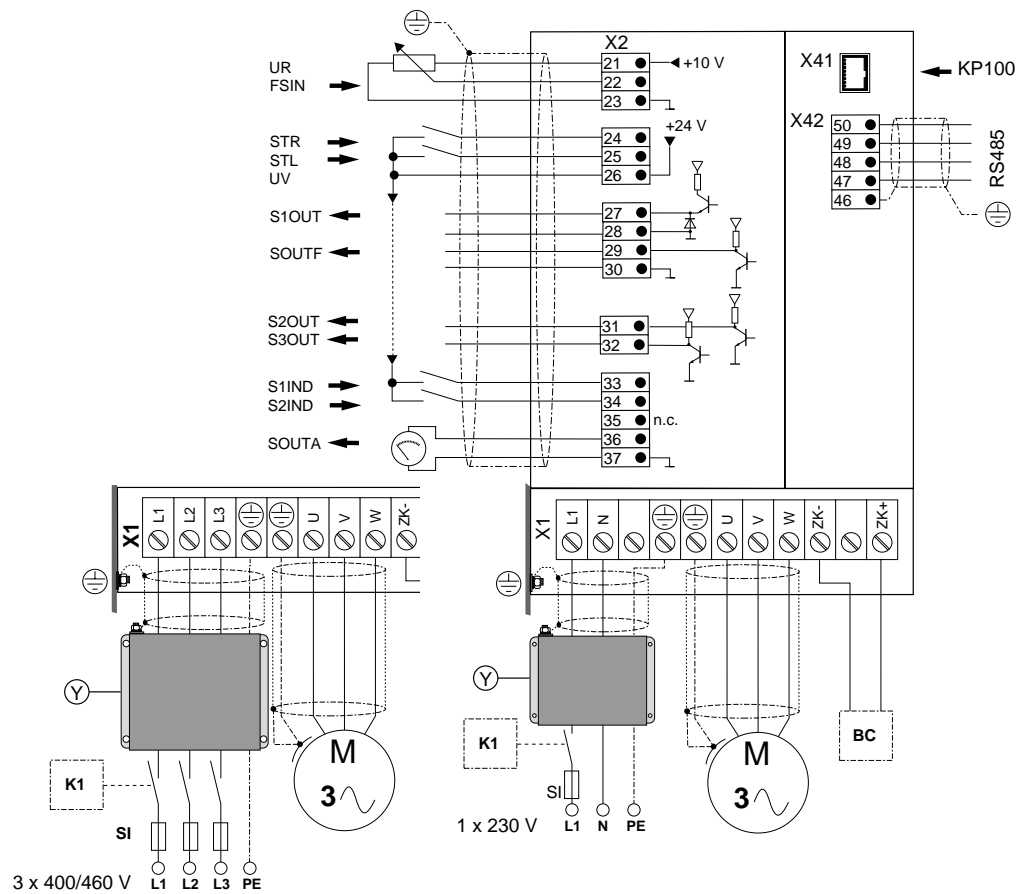

In devices VF1418L ... 1445L the earthing stud \oplus is located on the right-hand side panel.

Terminal assignment

X2	Des.	Control connections
21	UR	10 V for reference potentiometer
22	FSIN	Reference frequency input 0-10 V, 2-10 V, 0-20 mA, 4-20 mA 0-1 kHz, 0-10 kHz, 0-100 %PWM, 20-100 %PWM
23,28,30,37		Frame, controller reference point
24	STR	Start-Right input
25	STL	Start-Left input
26	UV	Control voltage 24 V DC
27	S1OUT	Prog. output HIGH active
29	SOUTF	Digital frequency output
31	S2OUT	Prog. output LOW active
32	S3OUT	Prog. output LOW active
33	S1IND	Prog. input, digital
34	S2IND	Prog. input, digital
36	SOUTA	Prog. output analog

X1	Power connections
L1,N, \oplus	Mains connection 1 x 230 V
L1,L2,L3, \oplus	Mains connection 3 x 400/460 V
\oplus U,V,W	Motor connection
ZK- ZK+	Connection for external brake chopper (BC), e.g. BC4000

X41	Socket for control unit KEYPAD KP100
------------	---

X42/ 47, 48, 49, 50	Terminal for interface RS485
--------------------------------	---------------------------------

K1	Connection example, line contactor
Y	Connection example for external mains filter
\oplus	Connection point for protective earth and screen

CHAPTER 3 ORDERING INFORMATIONS FOR VF1000L

General

The standard version of the VF1000L frequency inverter is identified by the type designation. Other non-standard designs are identified by suffix design codes appended to the order designation.

Each design code has its own special meaning (see design versions of VF1000L). For inverters not quoted in the list design codes not given here are also used.

From the design options shown, only one design version per terminal location may be ordered.

Order/type designation

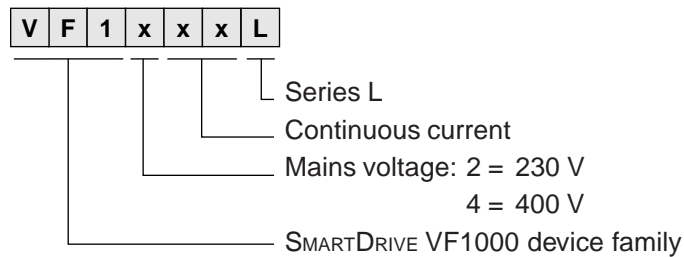

Standard design:

- Varnished all-metal housing with metal cover for KEYPAD KP100 mounting, protection IP20
- With brake chopper power electronics and braking resistor in device heat sink
- With isolated RS485 interface
- Operation Manual in German

Non-standard design code

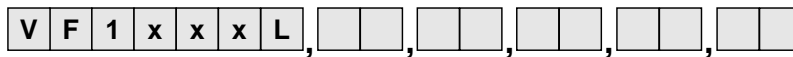

The design code is separated by a comma, and can be written in any order.

Example



CHAPTER 3 DESIGN CODES OF THE VF1000L AND VF1000L, HF

VF1000L

Terminal location	Design code	Short description
Options	Standard	No function
	C2	CAN-Bus interface, isolated
	OP1	Direct clock input for reference input, without internal ramp generator function
	OP2	Thermistor evaluation to DIN 44081/44082 with short-circuit monitoring or automatic circuit-breaker thermostat evaluation of three-phase AC motors
	OP5	3rd digital control input
	TR	Technical Controller incl. 2 analog inputs (± 10 V)
	CP	Prepared for PROFIBUS Gateway type CP-DP1 (see "Accessories")

Software	Standard	Software function see operation manual
	S58	Technical Controller with one analog input (design codes C1, C2 and CP not possible)

Only one design version per terminal location is possible

VF1000L, HF

Terminal location	Design code	Short description
Optionen	Standard	No function
	OP1	Direct clock input for reference input, without internal ramp generator function
	OP2	Thermistor evaluation to DIN 44081/44082 with short-circuit monitoring or automatic circuit-breaker thermostat evaluation of three-phase AC motors
	OP5	3rd digital control input

Only one design version per terminal location is possible

Note: The KEYPAD KP100 control unit must be ordered separately. For further information see "Accessories".

CHAPTER 4 ACCESSORIES FOR VF1000S/M/L

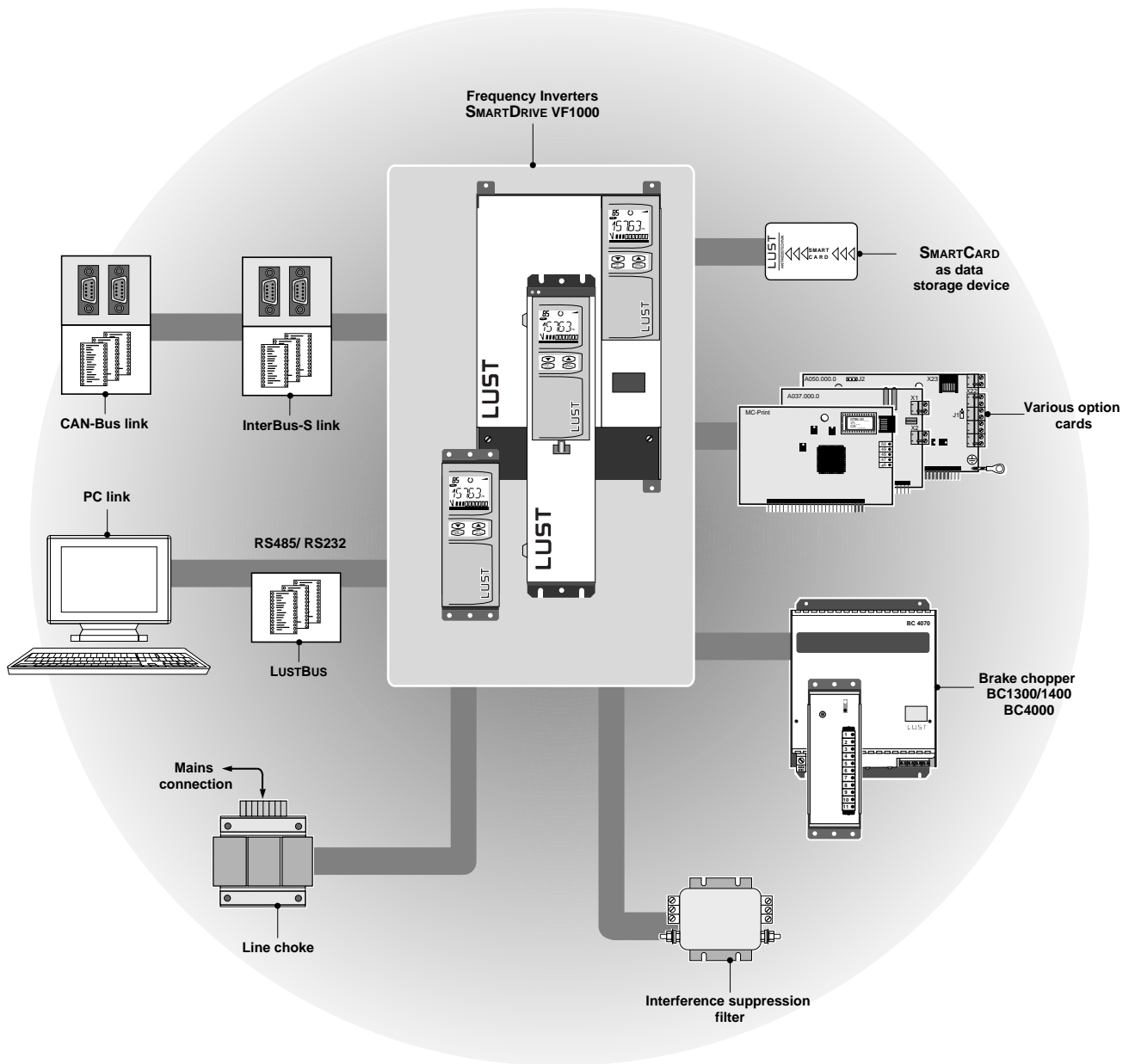

CHAPTER 4 MAINS FILTERS

The mains filters listed here enable EMC regulations to be met.

Technical Specifications

Inverter type	Order des.	Cable length	Limit curve	Rated current	Leakage current	Connections
VF1104S	NFE6.0 NFE12.3	5 m 25 m	Class B Class B	6 A 12 A	$\leq 1,5$ mA ≤ 5 mA	Tab connector A6,3 x 0,8 Terminals, 4 mm ² max.
VF1202S	NFE6.1 NFE12.3	5 m 25 m	Class B Class B	6 A 12 A	0,21 mA ≤ 5 mA	Tab connector A6,3 x 0,8 Terminals, 4 mm ² max.
VF1204S	NFE6.0 NFE12.3	5 m 25 m	Class B Class B	6 A 12 A	$\leq 1,5$ mA ≤ 5 mA	Tab connector A6,3 x 0,8 Terminals, 4 mm ² max.
VF1402S	NFD4.1	25 m	Class B	4 A	≤ 22 mA	Terminals, 4 mm ² max.
VF1200M	NFE12.1 NFE12.3	15 m 100 m	Class A Class B	12 A 12 A	$\leq 3,5$ mA ≤ 5 mA	Line: term 1,5mm ² , Load: cable Terminals, 4 mm ² max.
VF1200M,FA	NFE12.1	50 m 25 m	Class A Class B	12 A 12 A	≤ 7 mA ≤ 7 mA	Line: term 1,5mm ² , Load: cable Line: term 1,5mm ² , Load: cable
VF1400M	NFD10.1 NFD10.3 NFD12.1	15 m 100 m 25 m 25 m 15 m	Class A Class A Class B Class A Class B	10 A 10 A 10 A 12 A 12 A	≤ 5 mA < 116 mA < 116 mA ≤ 15 mA ≤ 15 mA	Line: term 1,5mm ² , Load: cable Terminals 4 mm ² max. Terminals 4 mm ² max. Line: term 1,5mm ² , Load: cable Line: term 1,5mm ² , Load: cable
VF1400M,FA ¹⁾	NFD10.1	25 m 15 m	Class A Class B	10 A 10 A	≤ 10 mA ≤ 10 mA	Line: term 1,5mm ² , Load: cable Line: term 1,5mm ² , Load: cable
VF1209L	NFE22.0	25 m	Class B	22 A	< 5 mA	Terminals, 4 mm ² max.
VF1410L VF1414L VF1408/10L,HF	NFD16.2	100 m *100 m	Class A Class B	16 A 16 A	< 178 mA < 178 mA	Terminals, 4 mm ² max Terminals, 4 mm ² max
VF1418L VF1414L,HF	NFD25.1	100 m *100 m	Class A Class B	25 A 25 A	< 127 mA < 127 mA	Terminals, 4 mm ² max. Terminals, 4 mm ² max.
VF1424L VF1432L VF1418/24L,HF	NFD35.0	100 m *100 m	Class A Class B	35 A 35 A	< 99 mA < 99 mA	Terminals, 6 mm ² max. Terminals, 6 mm ² max.
VF1445L	NFD50.1	100 m *100 m	Class A Class B	50 A 50 A	< 140 mA < 140 mA	Terminals, 16 mm ² max. Terminals, 16 mm ² max.

* With line choke

¹⁾ The inverter VF1410M is not available in design FA.

Using a mains filter does not limit the inverter power data.

Rated voltage: 1 x 230 V +10 % oder 3 x 480 V +10 %

Overload: $1,5 \times I_N$ for 1 minute per 30 minutes

Inverter parameters: = Factory setting

Line: = Filter input

Load: = Filter output

CHAPTER 4 MAINS FILTERS

Dimensional drawings

NFE6.0, NFE6.1

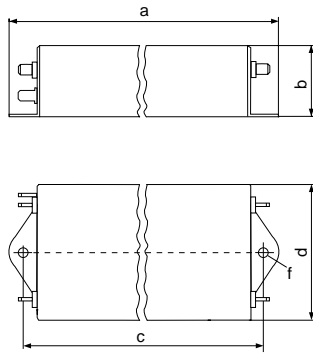

NFD10.1, NFD12.1, NFE12.1

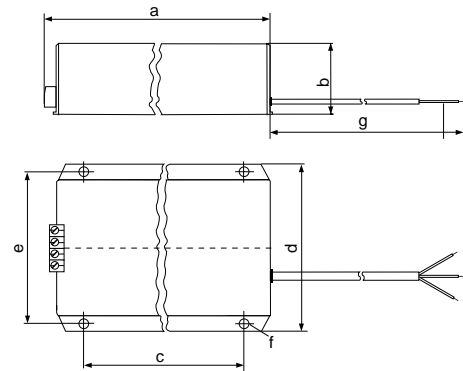

NFE22.0, NFD10.3, NFD16.2
NFD25.1, NFD35.0, NFD50.1

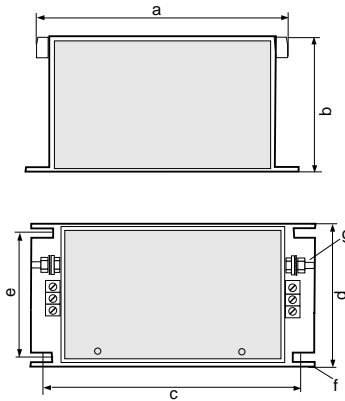

NFE12.3, NFD4.1

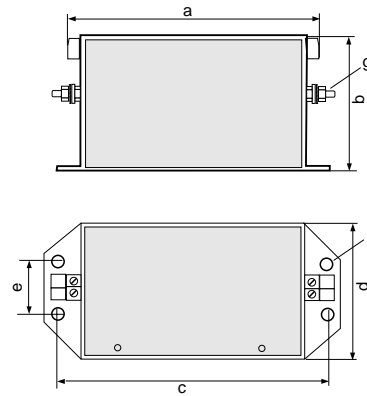

Dimension table

Order des.	a	b	c	d	e	f	g
NFE6.0	159	44,5	143	50,8	–	Ø 4,7	–
NFE6.1	88,4	40	75	52	–	5,3	–
NFE12.1 ¹⁾	101	50	51	70	61	Ø 4,7	550
NFE12.3	120	65	110	65	35	Ø 4,5	M4
NFE22.0	240	95	230	45	36	Ø 4,5	M5
NFD4.1	130	68	120	80	35	Ø 4,5	M4
NFD10.1 ¹⁾	101	50	51	70	61	Ø 4,7	550
NFD10.3	240	95	230	45	36	Ø 4,5	M5
NFD12.1 ¹⁾	143	50	51	70	61	Ø 4,7	550
NFD16.2	255	95	245	73	64	Ø 4,5	M5
NFD25.1	255	95	245	73	64	Ø 4,5	M5
NFD35.0	255	95	245	73	64	Ø 4,5	M5
NFD50.1	290	100	275	90	76	Ø 7	M5

1) With factory-assembled screened cable.

All dimensions in mm

CHAPTER 4 LINE CHOKES

In accordance with VDE 0160 and VDE 0839, only limited system perturbations and commutation notches are permitted. In order to limit these perturbations when the frequency inverter is in operation, line chokes with 4% short-circuit voltage must be used.

Technical Specifications

Inverter type	Order and type des.	Rated current [A]	Power loss [W]	Inductance [mH]	Mass [kg]	Connection
VF1202S	END4	4	5,8	7	0,4	Terminals, 2,5 mm ² max.
VF1204S	END7	7	8,2	4	0,75	Terminals, 2,5 mm ² max.
VF1402S	DND2	2	6	14,6	0,5	Terminals, 2,5 mm ² max.
VF1205M	END10	10	12	3	0,75	Terminals, 4 mm ² max.
VF1207M	END20	20	20	1,46	1,6	Terminals, 4 mm ² max.
VF1404M	DND6	6	18	4,8	1,6	Terminals, 4 mm ² max.
VF1406M	DND6	6	18	4,8	1,6	Terminals, 4 mm ² max.
VF1408M	DND10	10	31	2,9	2,5	Terminals, 4 mm ² max.
VF1410M	DND10	10	31	2,9	2,5	Terminals, 4 mm ² max.
VF1209L	END20	20	20	3	0,75	Terminals, 4 mm ² max.
VF1410L VF1408L,HF VF1410L,HF	DND10	10	31	2,9	2,5	Terminals, 4 mm ² max.
VF1414L VF1414L,HF	DND14	15	39	2,0	3,8	Terminals, 4 mm ² max.
VF1418L	DND18	18	51	1,6	3,8	Terminals, 4 mm ² max.
VF1424L VF1418L,HF VF1424L,HF	DND24	25	54	1,2	3,8	Terminals, 4 mm ² max.
VF1432L	DND32	34	75	0,86	3,8	Terminals, 6 mm ² max.
VF1445L	DND45	50	96	0,58	6,5	Terminals, 16 mm ² max.

Rated voltage: END 1 x 220 ... 240 V
 DND 3 x 380 ... 415 V, other voltages on request

Short-circuit
 voltage.: 4 %

Insulation class: T40/B to VDE 0550/ 0532

CHAPTER 4 LINE CHOKES

**Dimensional drawing,
END**

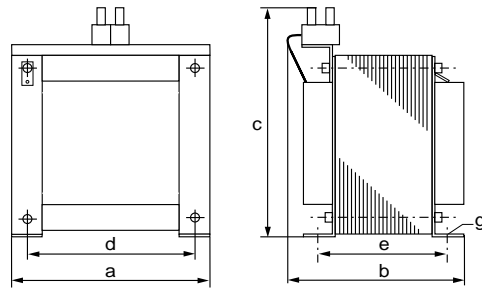

**Dimensional drawing,
DND**

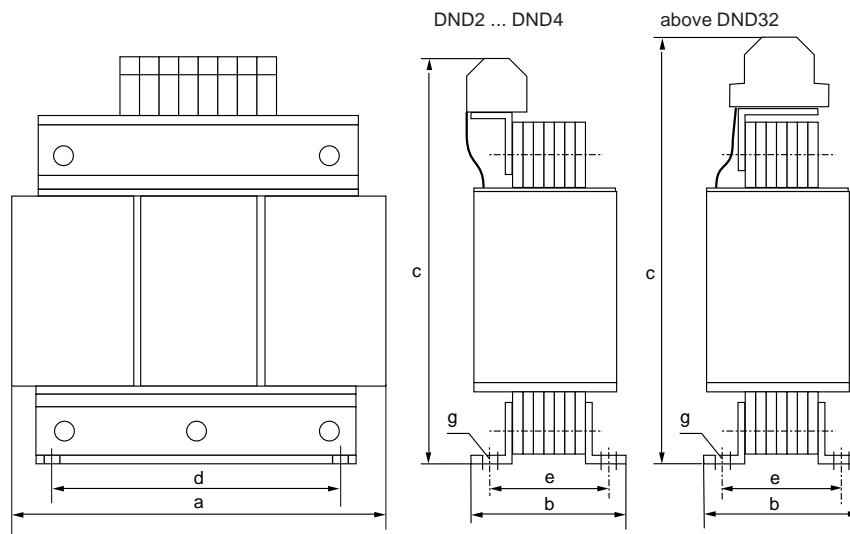

Dimension table

Order and type des.	a	b	c	d	e	g
END4	54	58	75	45	35	Ø 3,5
END7	60	72	72	50	50	Ø 3,5
END10	66	65	75	55	46	Ø 4,5
END20	84	70	90	70	52	Ø 4,8
DND2	80	44	92	50	30	Ø 4,5
DND6	100	60	105	60	44	Ø 4,8
DND10	120	64	120	84	55	Ø 4,8
DND14	150	67	167	113	49	Ø 5,8
DND18	150	67	167	113	49	Ø 5,8
DND24	150	67	190	113	49	Ø 5,8
DND32	150	67	190	113	49	Ø 5,8
DND45	180	76	195	136	57	Ø 7,0

All dimensions in mm.

CHAPTER 4 ACCESSORIES FOR DEVICE OPERATION

Interface adapter KPRS232

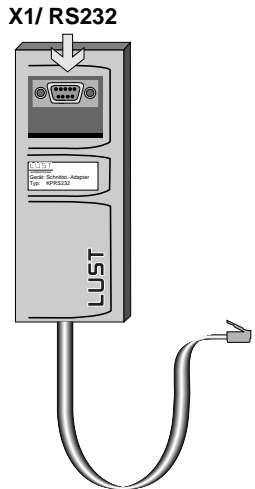

Order designation KPRS232

The KPRS232 interface adapter allows an inverter of the VF1000 family to be connected to a computer with an RS232 serial port. It isolates the KEYPAD connection of the inverter from the computer. Power is supplied to the device from the inverter.

A standard commercially available interface cable can be used for the link from the interface adapter to the computer.

Dimensions: H x W x D
158 x 62 x 21 [mm]

Control unit KEYPAD KP100

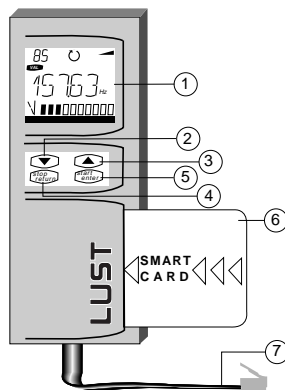

Order designation KP100

No.	Designation	Function
①	LCD display panel	140 segments, backlit green/red
②	Down cursor	Scroll back within the menu structure
③	Up cursor	Scroll forward within the menu structure
④	Stop/return key	Stop (CTRL menu), cancel or quit selected menu
⑤	Start/enter key	Start (CTRL menu), confirm or select menu
⑥	SMARTCARD	Chipcard data storage device, storage of device settings
⑦	Connecting cable	Maximum length 0.35 m

Dimensions: H x W x D
158 x 62 x 21 [mm]

SMARTCARD

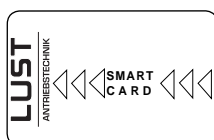

Order designation SC

For data backup and transmission, all inverter parameters can be stored on the SMARTCARD and then transferred without problem onto other frequency inverters.

CHAPTER 4 BRAKING RESISTOR ACCESSORIES FOR VF1000M

Braking resistor ZBR5

Order designation ZBR5

The ZBR5 add-on is designed for mounting in the heat sinks of inverters VF1205M and VF1207M.

	Dim.	VF1205M incl. ZBR5	VF1207M incl. ZBR5
Peak braking power	kW	1,65	1,65
Cyclic braking	W	90	90

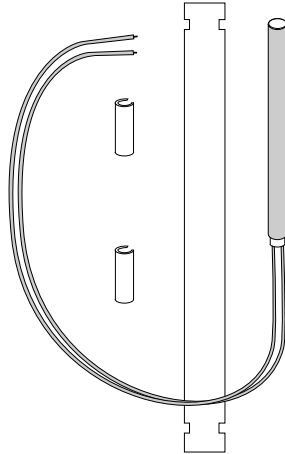

Braking resistor ZBR4

Order designation ZBR4

The ZBR4 add-on is designed for mounting in the heat sinks of inverters VF1404M, VF1406M, VF1408M and VF1410M.

	Dim.	VF1404M incl. ZBR4	VF1406M incl. ZBR4	VF1408M incl. ZBR4	VF1410M incl. ZBR4
Peak braking power	kW	1,65	1,65	1,65	1,65
Cyclic braking	W	90	90	90	90

CHAPTER 4

BRAKE CHOPPERS BC1300/1400 FOR VF1000S

Technical Specifications

	Des.	Dim.	BC1300	BC1400
Braking power at 100% cdf	P_{eff}	W	90	90
Braking power at 50% cdf	P_{eff}	W	140	140
Braking power at 25% cdf	P_{eff}	W	210	210
Braking power at 12% cdf	P_{eff}	W	310	310
Braking power at 6% cdf	P_{eff}	W	450	450
Peak braking power	P_{Sp}	kW	1,5	1,5
Autom. power red. (after 6 s)	$P_{red.}$	kW	0,7	0,7
Braking current	I_{Br}	A DC	4,0	2,7
Starting voltage	U_{ein}	V DC	390	750
Stopping voltage	U_{aus}	V DC	381	740
Braking resistor design	-	-	Heating cartridge	
Terminal cross-section	A	mm ²	1,5	
Term. 9/10 DC-link connection	-	-	Maximum length 0.5 m	
Thermostatic switching contact	-	-	250 V~ 10 A	
Ambient conditions				
Protection	-	-	IP10 (when mounted)	
Cooling air temperature	T	°C	0 ... 40	
Mounting height above sea level	H	m	1000 max.	
Relative air humidity	rF	%	15 ... 85, non-condensing (VDE 0160)	
Permissible vibration	-	-	2 g (IEC 68-2-6)	
Mounting	-	-	Vertical wall mounting	
Mechanics				
Mass	M	kg	0,5	
Dimensions	A	mm	20	
	B	mm	Ø 4,8	
	C	mm	183	
	D	mm	170	
	E	mm	65	
	F	mm	120	

cdf = continuous duty factor with 120 s cycle duration

The BC1300 brake chopper is designed for VF1000S frequency inverters with 230 V rated voltage, and the BC1400 for VF1000S inverters with 400 V. Both brake choppers have the braking resistor already built-in, and require no additional power supply.

Connection diagram

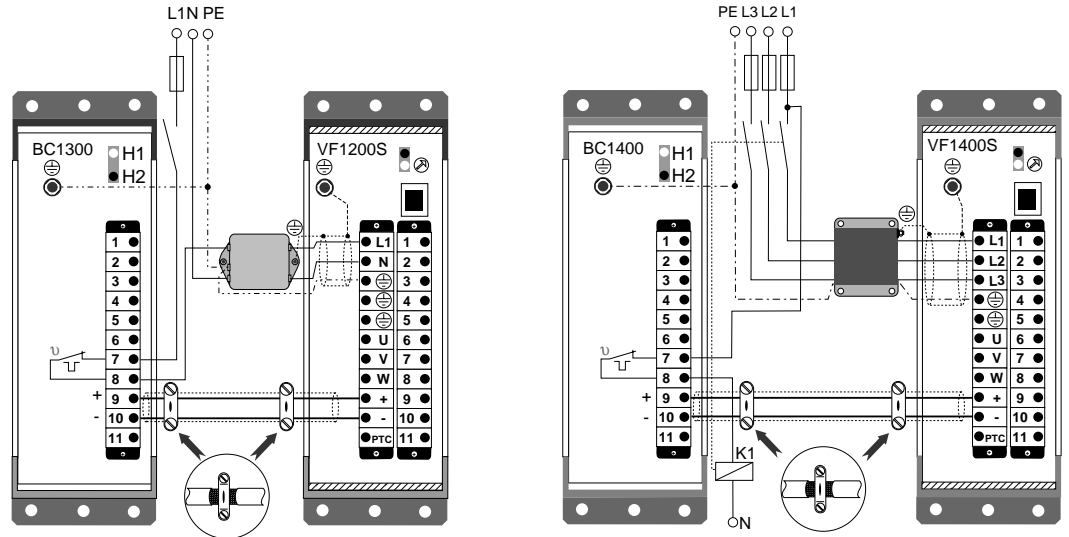

Terminal assignment

BC-term.	Meaning
5, 6	Connections not occupied
7, 8	Bimetal switch output for thermal monitoring of brake chopper
4, 9	(+) input, inverter DC-link
1, 10	(-) input, inverter DC-link
11	Connection not occupied
2, 3	Connection of ext. braking resistor (on request)
H1	Red LED, brake chopper active
H2	Green LED, ready
⊕	Connection point for protective earth and screen

Note: There is a direct correlation between the switching threshold of the brake chopper and the connected mains voltage of the inverter. For this reason, only the following combinations are possible:

- BC1300 → VF1202S or VF1204S
- BC1400 → VF1402S

CHAPTER 4 BRAKE CHOPPER UNIT BC4000 FOR VF1000L

Technical Specifications

	Des.	Dim.	BC4020	BC4070
Suitable for inverter mains voltage	U_{UN}	V AC	230 (starting voltage $U_{dcl} = 365$ V DC) 400 (starting voltage $U_{dcl} = 635$ V DC) 460 (starting voltage $U_{dcl} = 725$ V DC)	
Min. braking resistance ($U_{UN} = 230$ V)	$R_{min.}$	Ω	18	5,1
Min. braking resistance ($U_{UN} = 400$ V)	$R_{min.}$	Ω	33	9,1
Min. braking resistance ($U_{UN} = 460$ V)	$R_{min.}$	Ω	37	11
Peak braking current	I_{SP}	A DC	20	70
Continuous braking current	I_D	A DC	5	30
Ambient conditions				
Protection	-	-	IP10 (when mounted)	
Cooling air temperature	T	$^{\circ}C$	0 ... 40	
Mounting height above sea level	H	m	1000 max.	
Relative air humidity	rF	%	15 ... 85, non-condensing	
Permissible vibration	-	-	2 g (IEC 68-2-6)	
Mechanics				
Mounting	-	-	Vertical wall mounting	
Mass	M	kg	0,98	5,1
Dimensions	A	mm	100	176
	B	mm	$\varnothing 5$	
	C	mm	256	
	D	mm	246	
	E	mm	137	216
	F	mm	77	162

The BC4000 brake chopper unit is designed for VF1000L frequency inverters. It consists of the switching electronics, and for braking it additionally requires external braking resistors. No mains connection is required to supply power to the unit (with the starting voltage adjusted manually by means of the jumper strip).

Connection diagram (schematic)

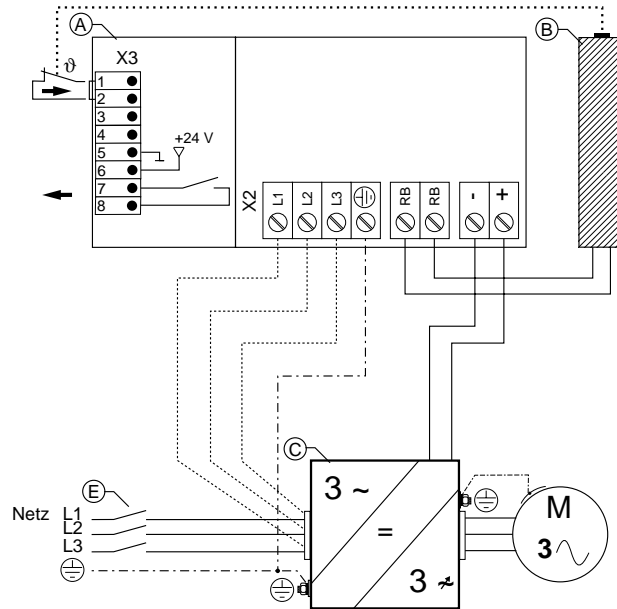

Legend

No.	Meaning
A	Brake chopper BC4000
B	Braking resistor (external)
C	Frequency inverter
E	Inverter power switch





Terminal assignment

X2	Meaning
L1,L2,L3	Mains connection, only required with automatic adjustment of starting power to mains power
⊕	Connection point for protective earth and screen
RB	Connections for braking resistor (external)
+, -	Connections for inverter DC-link
X3	Meaning
1,2	Input, braking resistor temperature switch
3,4	Unoccupied
5	Frame reference point
6	Control voltage 24 V DC ± 20%
7,8	Relay output, ready

CHAPTER 4 ACCESSORIES FOR PROFIBUS-DP

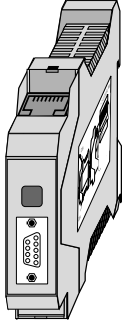
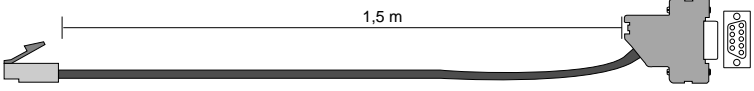
PROFIBUS-DP Gateway

Order designation: CP-DP1

Device	Supplied accessories	
	Gateway cable 	
	8-pin western plug for 9-pin D-SUB socket 	
	bus termination plug 	disk with GSD data files 

Technical data

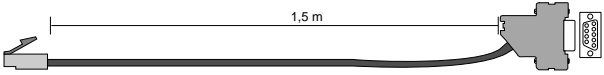
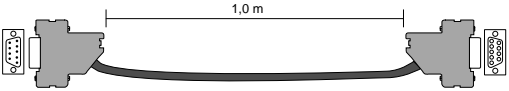
	PROFIBUS-DP Gateway CP-DP1
suitable for inverter	VF1000S,G19,FA,CP,xx VF1000M,CP,xx VF1000L,CP
hardware/protocol	DIN19245 T1+T3 / EN50170 volume 2
transmission rate	9,6 kBit/s to 12MBit/s adjustable
transmission length	12000 m to 100 m (see transmission rate)
stations per Gateway	Max. 10 stations
Gateway cable	 belongs to the scope of supply of the Gateway
Lust system bus cable	 belongs to the scope of supply of the drive
disk with GSD and ASCII data files	belongs to the scope of supply of the Gateway
bus termination plug	belongs to the scope of supply of the Gateway
PPO (parameter-process-data objects)	PPO type 1 and 3 are supported
supply voltage	24 V DC \pm 20 %
current input	1,2 A DC \pm 10 %
mounting	35 mm DIN-rail
dimensions	22,5 x 99 x 119 mm (BxHxT)
ambient temperature	0 - 50 °C non-condensing

CHAPTER 4 ACCESSORIES FOR PROFIBUS-DP

Networking example

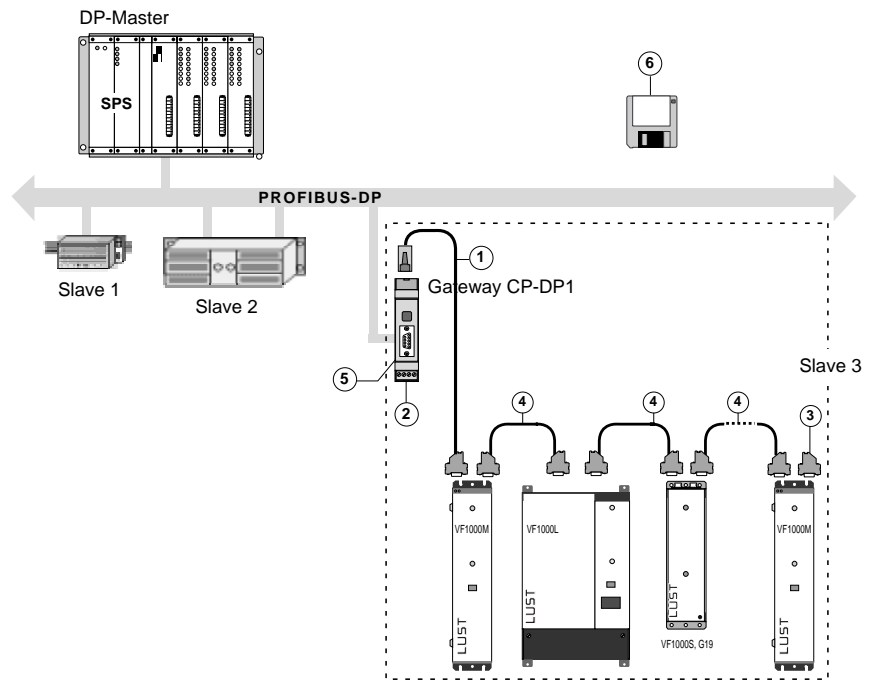

Legend

No.	Function
1	Gateway cable (supplied with the Gateway)
2	connection 24 V supply voltage
3	bus termination plug (supplied with the Gateway)
4	Lust system bus cable type I (supplied with the drive)
5	connection to the PROFIBUS-DP
6	disk with GSD data files (supplied with the drive)

CHAPTER 4 USER INFORMATION FOR VF1000S/M/L

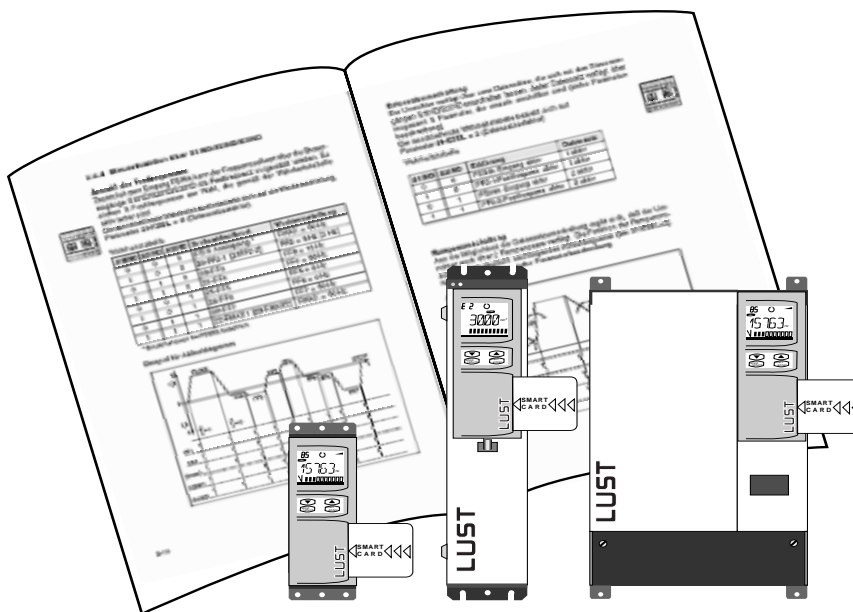

Frequency inverters

Device type	Order des.	Language	Description
VF1000S	0720.01B.0	German	Operation manual for standard device, incl. designs I1, I5, I6, I7, G8, G10, K1
	0720.21B.0	English	Operation manual for standard device, incl. designs I1, I5, I6, I7, G8, G10, K1
	0720.11B.0	German/ English	Version description, G19
	0720.02B.0	German/ English	Version description, M3, M4
	0720.03B.0	German/ English	Version description, C8
	0720.04B.0	German/ English	Version description, C2

VF1000M	0809.01B.0	German	Operation manual for standard device, incl. designs C2, C8, PTC, PT1, FA, G16
	0809.21B.0	English	Operation manual for standard device, incl. designs C2, C8, PTC, PT1, FA, G16
	0809.03B.0	German	Mounting instructions, ZBR4 and ZBR5
	0809.23B.0	English	Mounting instructions, ZBR4 and ZBR5
	0809.02B.0	German	Version description S58, TR
	0809.22B.0	English	Version description S58, TR

CHAPTER 4

USER INFORMATION FOR VF1000S/M/L

Frequency inverters

Device type	Order des.	Language	Description
VF1000L	0786.01B.0	German	Operation manual for standard device, incl. designs HF, C1, C2
	0786.21B.0	English	Operation manual for standard device, incl. designs HF, C1, C2
	A050.01B.0	German	Version description, OP1, OP2
	A050.21B.0	English	Version description, OP1, OP2
	A037.01B.0	German	Version description, OP5
	A037.21B.0	English	Version description, OP5
	0809.02B.0	German	Version description S58, TR
	0809.22B.0	English	Version description S58, TR

Accessories

Device type	Order des.	Language	Description
KEYPAD KP100	A021.02B.0	German	Operation manual for control unit
	A021.21B.0	English	Operation manual for control unit
KPRS232	A044.01B.0	German	Operation manual for interface adapter
	A044.21B.0	English	Operation manual for interface adapter
BC1300/1400	A031.01B.0	German	Operation manual for brake chopper, designed for VF1000S
	A031.21B.0	English	Operation manual for brake chopper, designed for VF1000S
BC4000	0743.00B.0	German	Operation manual for brake chopper, designed for VF1000L
	0743.21B.0	English	Operation manual for brake chopper, designed for VF1000L
CP-DP1	0841.01B.0-00	German/ English	Instruction manual for PROFIBUS-DP Gateway

CHAPTER 4 USER INFORMATION FOR VF1000S/M/L

Non-product-specific information sources

For product	Order des.	Language	Description
VF1000S/M/L	A040.02B.0	German	LUSTBUS data transfer protocol
VF1000S/M/L	A040.22B.0	English	LUSTBUS data transfer protocol
VF1000S/M/L	A047.02B.0	German	CAN-Bus data transfer protocol
VF1000S/M/L	A047.22B.0	English	CAN-Bus data transfer protocol
VF1000S/M/L	0718.50B.0	German	INTERBUS-S data transfer protocol
VF1000S/M/L	0718.51B.0	English	INTERBUS-S data transfer protocol
VF1000S/M/L	0841.02B.0-00	German	PROFIBUS-DP data transmission protocol
VF1000S/M/L	0841.22B.0-00	English	PROFIBUS-DP data transmission protocol
VF1000S/M/L	0792.50B.0	German	Installation instructions for interconnection of LUSTBUS and CAN-Bus
VF1000S/M/L	0792.51B.0	English	Installation instructions for interconnection of LUSTBUS and CAN-Bus
VF1000S/M/L	0786.04B.0	German	Parameter description (total package)
VF1000S/M/L	0786.24B.0	English	Parameter description (total package)
VF1000S/M/L	0646.08B.0	German	Practical design hints to avoid system perturbations

