

Current Transducer LAH 100-P

For the electronic measurement of currents: DC, AC, pulsed..., with galvanic separation between the primary circuit and the secondary circuit.

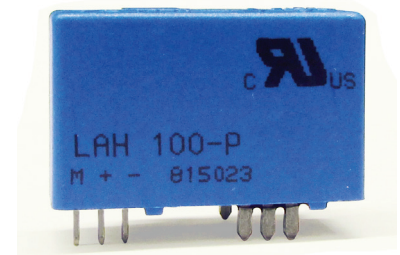

$$I_{PN} = 100 \text{ A}$$



Electrical data

I_{PN}	Primary nominal rms current	100	A	
I_{PM}	Primary current, measuring range ¹⁾	0 .. ±160	A	
R_M	Measuring resistance @	$T_A = 70 \text{ °C}$	$T_A = 85 \text{ °C}$	
		$R_{M \min}$ $R_{M \max}$	$R_{M \min}$ $R_{M \max}$	
	with ±12 V	@ I_{PN} [± A DC]	0 63	0 57 Ω
		@ I_{PN} [A rms] ²⁾	0 11	0 5 Ω
	with ±15 V	@ I_{PN} [± A DC]	20 120	45 114 Ω
		@ I_{PN} [A rms] ²⁾ @ $I_P < I_{PN}$ ³⁾	20 51	45 45 Ω
I_{SN}	Secondary nominal rms current	50	mA	
K_N	Conversion ratio	1 : 2000		
U_C	Supply voltage (±5 %)	±12 ... 15	V	
I_C	Current consumption	10 (@ ±15 V) + I_S	mA	

Accuracy - Dynamic performance data

X	Accuracy ⁴⁾ @ I_{PN} , $T_A = 25 \text{ °C}$	±0.25	%
ϵ_L	Linearity error	< 0.15	%
I_O	Offset current @ $T_A = 25 \text{ °C}$	Typ	Max
			±0.15
I_{OM}	Magnetic offset current @ $I_P = 0$ and specified R_M , after an overload of $5 \times I_{PN}$	±0.10	±0.15
		±0.10	±0.15
I_{OT}	Temperature variation of I_O	0 °C ... +70 °C	±0.10
		-25 °C ... +85 °C	±0.10
t_{ra}	Reaction time to 10 % of I_{PN}	< 200	ns
t_r	Step response time ⁵⁾ to 90 % of I_{PN}	< 500	ns
di/dt	di/dt accurately followed	> 200	A/μs
BW	Frequency bandwidth (-1 dB)	DC .. 200	kHz

General data

T_A	Ambient operating temperature	-25 .. +85	°C
T_S	Ambient storage temperature	-40 .. +90	°C
R_S	Resistance of secondary winding @ $T_A = 70 \text{ °C}$	115	Ω
		@ $T_A = 85 \text{ °C}$	121
m	Mass	24	g
	Standards	EN 50178: 1997	

Notes: ¹⁾ For 10 s, with $R_M \leq 25 \text{ Ω}$ ($U_C = \pm 15 \text{ V}$)

²⁾ 50 Hz Sinusoidal

³⁾ The measuring resistance $R_{M \min}$ may be lower (see "LAH Technical Information" leaflet)

⁴⁾ Without I_O & I_{OM}

⁵⁾ With a di/dt of 100 A/μs.

Features

- Closed loop (compensated) current transducer using the Hall effect
- Printed circuit board mounting
- Insulating plastic case recognized according to UL 94-V0.

Advantages

- Excellent accuracy
- Very good linearity
- Low temperature drift
- Optimized response time
- Wide frequency bandwidth
- No insertion losses
- High immunity to external interference
- Current overload capability.

Applications

- AC variable speed drives and servo motor drives
- Static converters for DC motor drives
- Battery supplied applications
- Uninterruptible Power Supplies (UPS)
- Switched Mode Power Supplies (SMPS)
- Power supplies for welding applications.

Application domain

- Industrial.

Current Transducer LAH 100-P

Insulation coordination

U_d	Rms voltage for AC insulation test, 50/60 Hz, 1 min	5	kV
\hat{U}_w	Impulse withstand voltage 1.2/50 μ s	12	kV
U_e	Partial discharge extinction rms voltage @ 10 pC	> 2	kV
		Min	
d_{cp}	Creepage distance ¹⁾	11.75	mm
d_{cl}	Clearance ¹⁾	11.75	mm
CTI	Comparative tracking index (group IIIa)	175	

Note: ¹⁾ On PCB with soldering pattern UTEC93-703.

Applications examples

According to EN 50178 and IEC 61010-1 standards and following conditions:

- Over voltage category OV 3
- Pollution degree PD2
- Non-uniform field

	EN 50178	IEC 61010-1
d_{cp}, d_{cl}	Rated insulation voltage	Nominal voltage
Basic insulation	1000 V	1000 V
Reinforced insulation	500 V	500 V

Safety

This transducer must be used in limited-energy secondary circuits according to IEC 61010-1.



This transducer must be used in electric/electronic equipment with respect to applicable standards and safety requirements in accordance with the manufacturer's operating instructions.



Caution, risk of electrical shock

When operating the transducer, certain parts of the module can carry hazardous voltage (eg. primary busbar, power supply). Ignoring this warning can lead to injury and/or cause serious damage.

This transducer is a build-in device, whose conducting parts must be inaccessible after installation. A protective housing or additional shield could be used.

Main supply must be able to be disconnected.

Dimensions LAH 100-P (in mm)

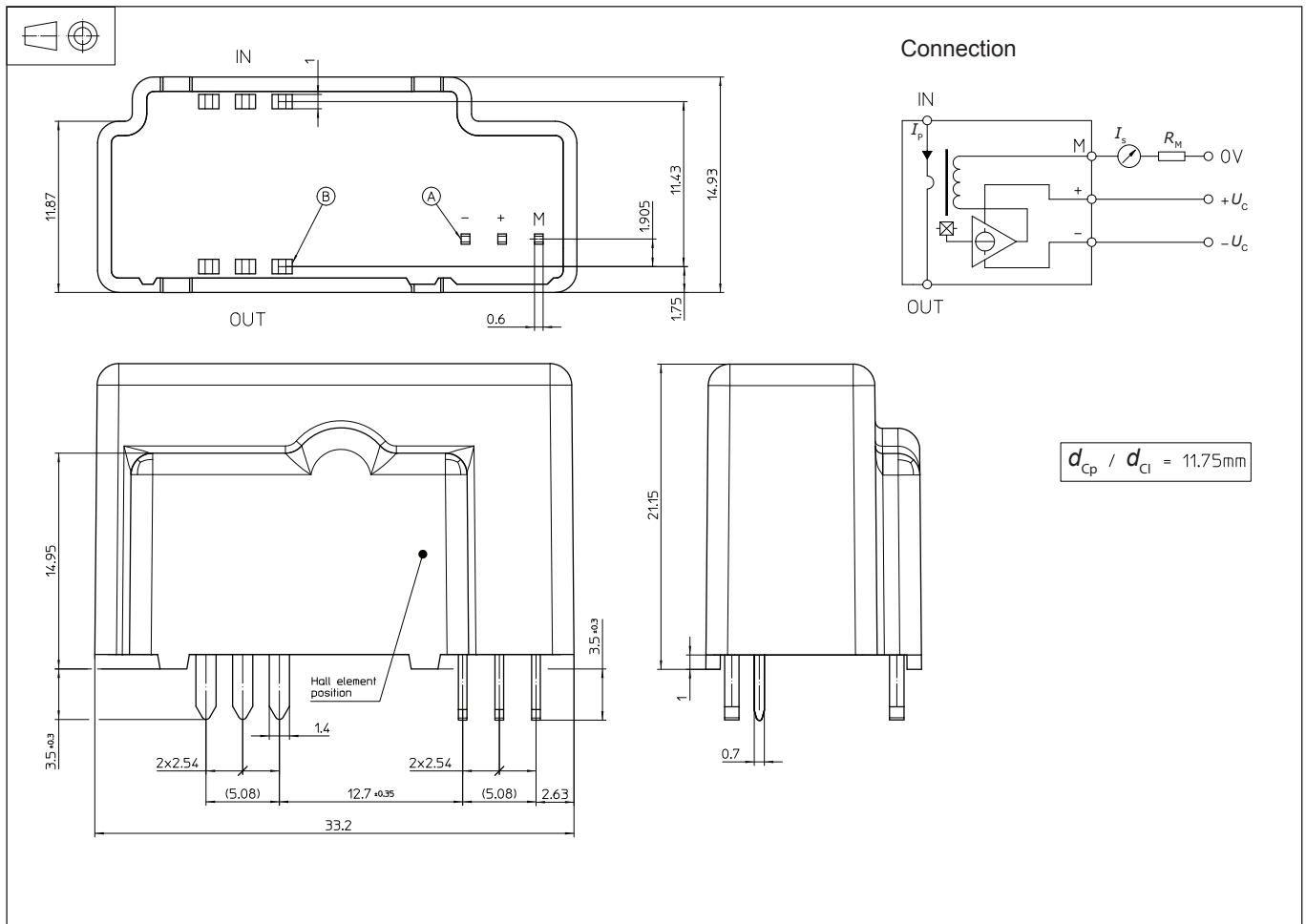

Number of primary turns	Primary current		Nominal output current I_{SN} [mA]	Turns ratio K_N	Primary resistance R_P [mΩ]	Primary insertion inductance L_P [μH]
	nominal I_{PN} [A]	maximum I_P [A]				
1	100	160	50	1 : 2000	0.08	0.007

Mechanical characteristics

- General tolerance ± 0.2 mm
- Fastening & connection of primary 6 pins 1.4 mm × 1 mm
Recommended PCB hole 2 mm
- Fastening & connection of secondary 3 pins 0.7 mm × 0.6 mm
Recommended PCB hole 1.2 mm

Remarks

- I_s is positive when I_p flows from terminals "IN" to terminals "OUT".
- The jumper temperature and PCB should not exceed 100 °C.
- This is a standard model. For different versions (supply voltages, turns ratios, unidirectional measurements...), please contact us.