

<b>Delem</b> Luchthavenweg 42, 5657 EB Eindhoven, the NETHERLANDS		See drawing 9065-901 for viewing angle options information		Date 14-04-1998	
<b>EXPLODED VIEW</b> DA69 VAO-1 STANDARD		Format <b>A3</b>		Issue <b>B</b>	
Note B Redrawn HNF Date 29-10-2001		Description Update Lay-Out Date 14-09-1998		Drawn MI	
Note A Redrawn MI Date 14-09-1998		Description Update Lay-Out		Drawn MI	
Measures in mm, unless otherwise specified		Date 14-04-1998		Scale No unauthorized copying allowed	

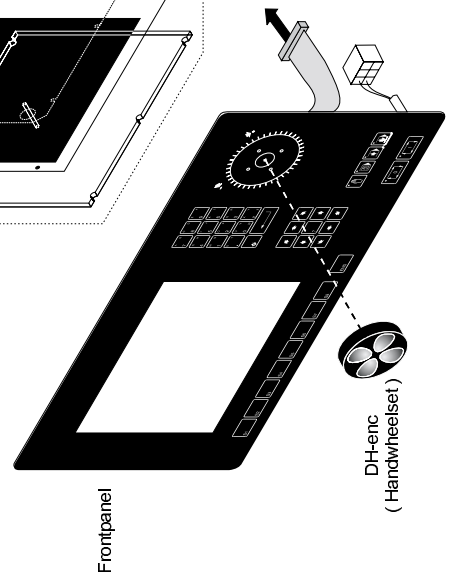

<b>Delem</b>		Luchthavenweg 42, 5657 EB Eindhoven, the NETHERLANDS	
<b>EXPLODED VIEW</b>			
DA69 VAO-2 STANDARD			
Format	Number	Issue	
<b>A3</b>	8028-505	B	
Note	Redrawn	Date	
B	HNF	29-10-2001	
Description: Update Lay-Out			
Note	Redrawn	Date	
A	MI	14-09-1998	
Description:			
Measures in mm, unless otherwise specified		Drawn	Date
		MI	14-04-1998
No unauthorized copying allowed   Scale			

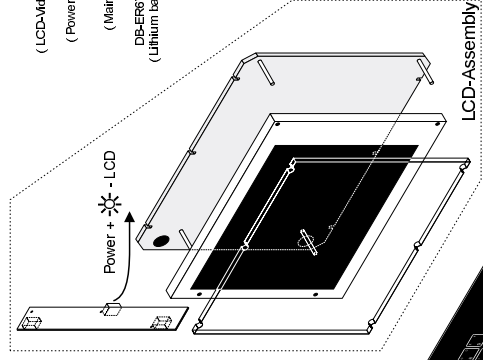
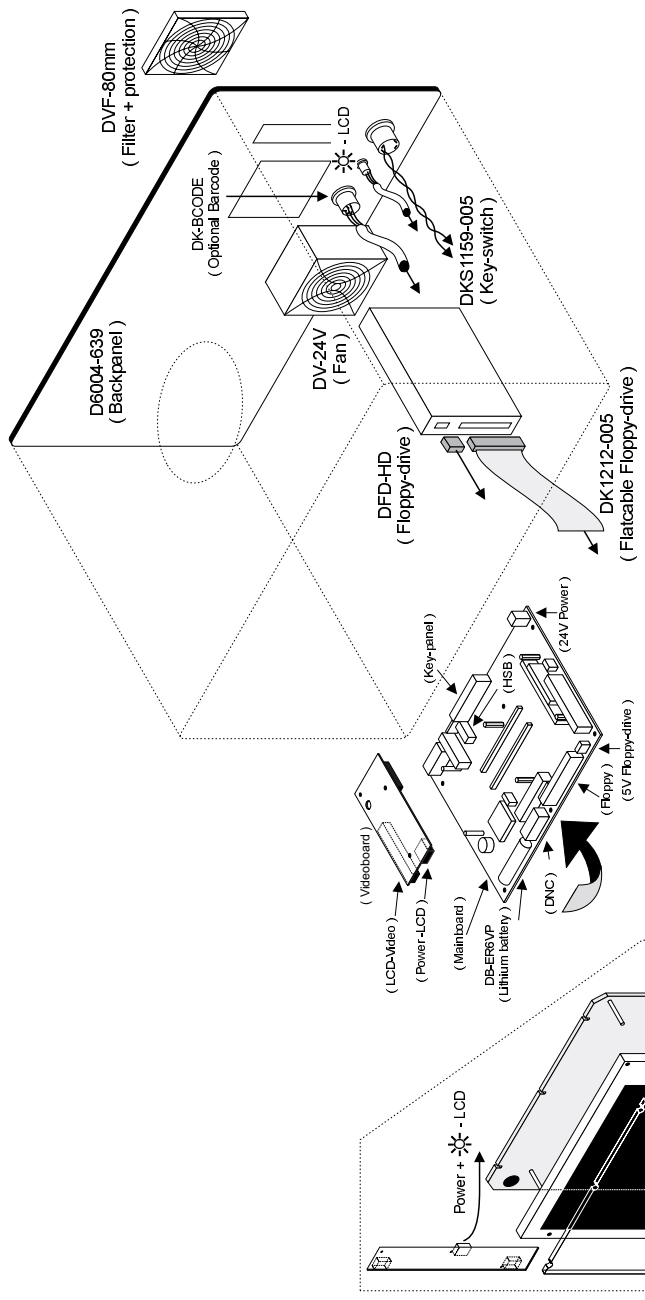
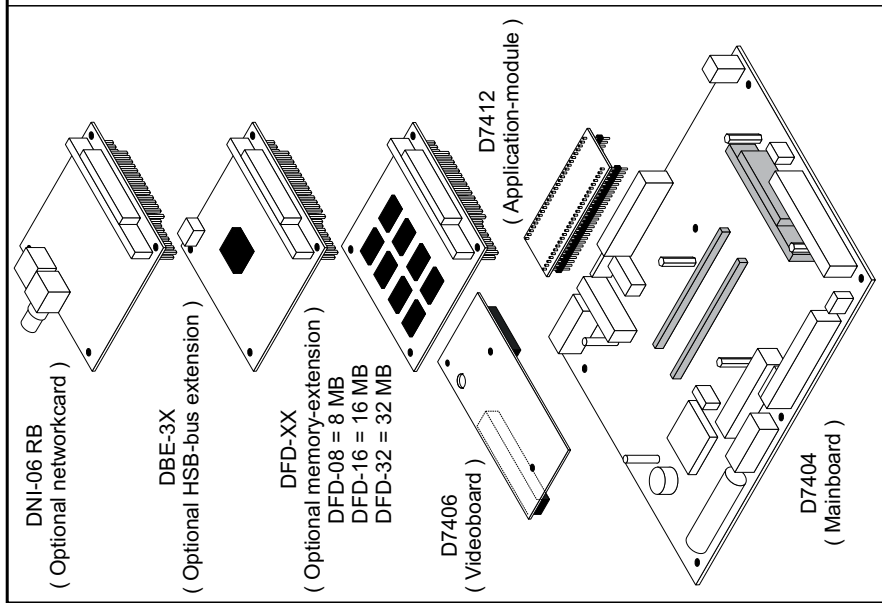
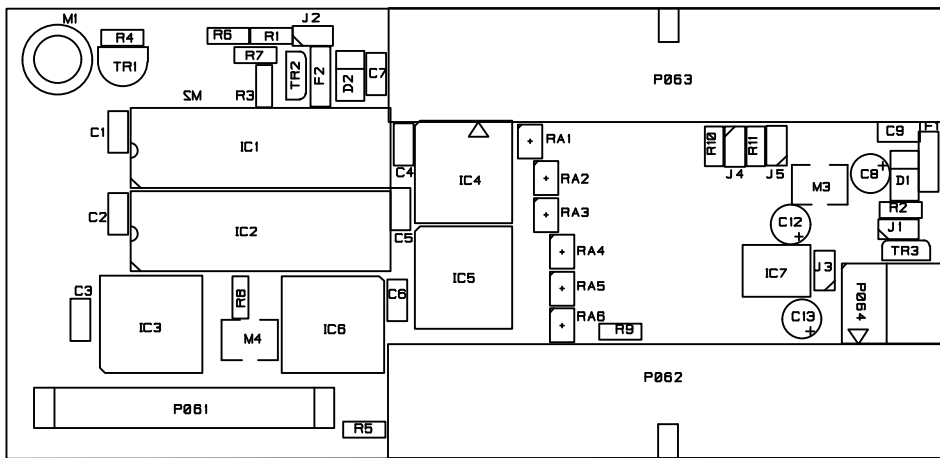

Note	Redraw	Date
		02-04-98
Description Issue A -> B		
Note	Redraw	Date
		01-10-97
Description Issue - -> A		
Measures in mm, unless otherwise specified		Drawn
		HM
		Date
		16-04-96

<b>Del em</b> Luchthavenweg 42.5657 EB Eindhoven, the NETHERLANDS		
<b>LCD INTERFACE          COMP.OPST.</b>		
301/B		
Format	Number	Issue
A4	7406-201	B
No unauthorized copying allowed		

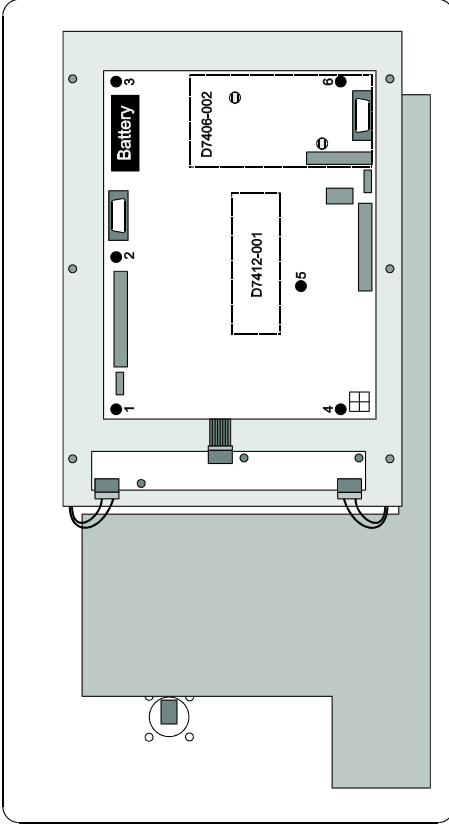

Disconnect all connectors, remove all other boards from Mainboard, and unscrew 1 - 6 to exchange D7404-008 ( Mainboard )

### EXCHANGING D7404-008 ( Mainboard DA69 )

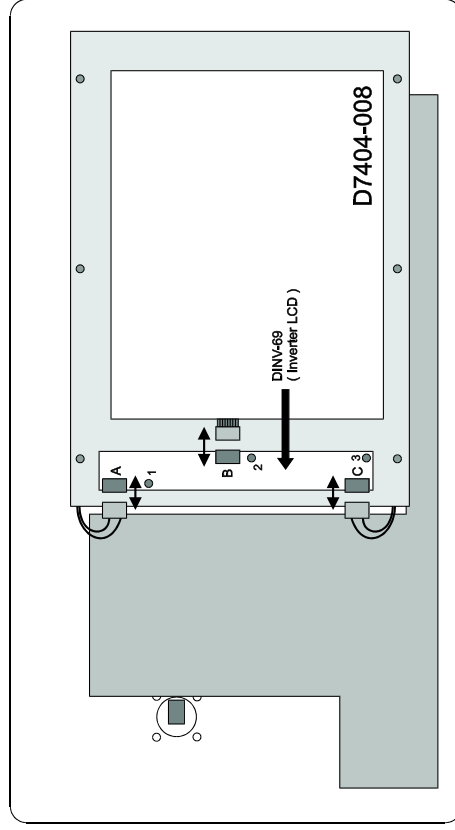

Disconnect A, B and C & Unscrew 1, 2 and 3 to exchange DINV-69 ( Inverter LCD )

### EXCHANGING DINV-69 ( Inverter LCD )

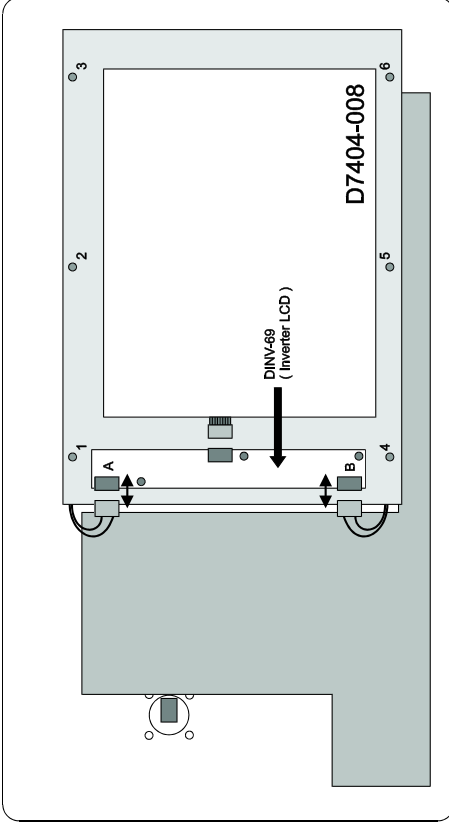

Disconnect A and B & Unscrew 1 - 6 to remove LCD-assembly from frontpanel

### BACKVIEW

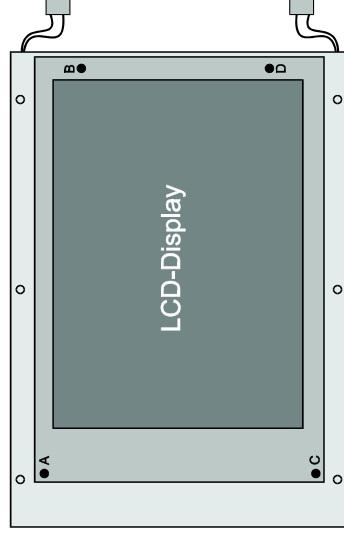

Unscrew A - D to exchange LCD-Display

### FRONTVIEW

### EXCHANGING DLCD-69 ( VGA-LCD Display )

Note	Redrawn	Date
Description		
Note	Redrawn	Date
Description		
Measures in mm, unless otherwise specified	Drawn	Date
	MI	10-03-1998

<b>Delem</b> Luchthavenweg 42, 5657 EB Eindhoven, The NETHERLANDS		
DA69 LCD-EXCHANGE NOTE		
Format	Number	Issue
A3	9055-501/-	-
No unauthorized copying allowed   Scale		

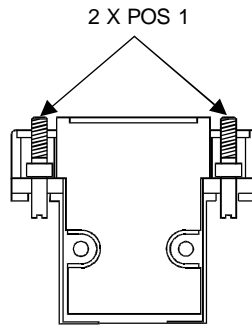
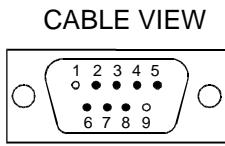

pin 2 PC RXD TO pin 3 CNC TXD
pin 3 PC TXD TO pin 2 CNC RXD
pin 7 PC RTS TO pin 8 CNC CTS
pin 5 PC 0V TO pin 5 CNC 0V
pin 7 CNC RTS TO pin 8 PC CTS
pin 4 CNC DTR TO pin 6 CNC DSR
pin 4 PC DTR TO pin 6 PC DSR

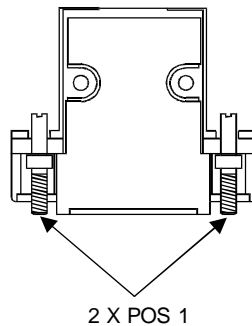
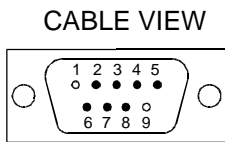

VERSIE	LENGTE
001	4 mtr
002	6 mtr
003	9 mtr
004	12 mtr

FEMALE

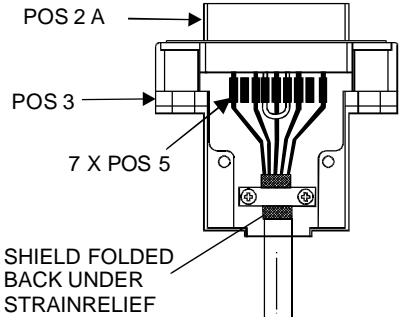

POS 4

SHIELD FOLDED  
BACK UNDER  
STRAINRELIEF

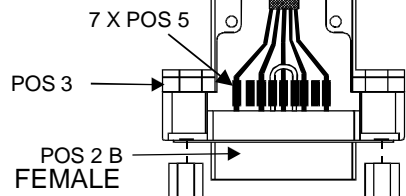

MOUNT TWO  
COUPLING NUTS

9 POLE  
MALE

25 POLE  
FEMALE

POS 6

Note	Redrawn	Date
Description -		
Note	Redrawn	Date
Description -		
Measures in mm, unless otherwise specified	Drawn VW	Date 28-01-1997

**Delem** Luchthavenweg 42, 5657 EB  
Eindhoven, the NETHERLANDS

SERIAL INTERFACE CABLE 2 X SUB-D  
9-/25-POLE

Format <b>A4</b>	Number 1130-201	Issue -
---------------------	--------------------	------------

No unauthorized copying allowed | Scale