

Synchronous servomotors

DBL/DBK



Choose your Motor:

Type	Flange	Standstill torque										Page
long	DBL1	37	0,1..0,2									⇒ 22
	DBL2	55	0,4..0,8									⇒ 26
	DBL3	75	0,65..3									⇒ 30
	DBL4	105	2,6..9,5									⇒ 34
	DBL5	142	10,5..22									⇒ 38
	DBL6	190	22..29									⇒ 42
	DBL7	190	26..40									⇒ 46
	DBL8	240	40...115									⇒ 50
short	DBK4	105	1..1,6									⇒ 54
	DBK5	142	2,1..4,3									⇒ 58
	DBK6	190	3,5..7									⇒ 62
	DBK7	190	6,5..19,5									⇒ 66

Already published editions

Edition	Comments
04 / 2001	First edition
05 / 2001	some minor corrections
07 / 2001	some minor corrections, model number description new, name plate new, dimension drawings optimized
02 / 2002	some minor corrections, encoder dimensions added
07 / 2002	new layout, resolver connection corrected

Technical changes to improve the performance of the equipment may be made without prior notice!

Printed in the Federal Republic of Germany

All rights reserved. No part of this work may be reproduced in any form (by printing, photocopying, microfilm or any other method) or stored, processed, copied or distributed by electronic means without the written permission of Kollmorgen Seidel Corporation.



Contents	Page
Contents	3
Safety Notes	4
Important Notes	5
Manufacturer Declaration	6
I General	
I.1 About this manual	7
I.2 Prescribed usage	7
I.3 Design of the motors	8
I.4 General technical data	8
I.5 Standard features	9
I.5.1 Style	9
I.5.2 Shaft end, A-side	9
I.5.3 Flange	9
I.5.4 Protection class	9
I.5.5 Protective device	9
I.5.6 Insulation material class	10
I.5.7 Vibration class	10
I.5.8 Connection method	10
I.5.9 Feedback unit	10
I.5.10 Holding brake	10
I.6 Options	11
I.7 Selection criteria	11
I.7.1 Model number description	12
I.7.2 Nameplate	12
II Installation / Setup	
II.1 Important notes	13
II.2 Assembly / Wiring	14
II.2.1 Connection of the motors	16
II.2.1.1 Wiring diagram for resolver motors	17
II.2.1.2 Wiring diagram for encoder motors	18
II.3 Setup	19
III Technical data	
III.1 Definitions	21
III.2 DBL1	22
III.3 DBL2	26
III.4 DBL3	30
III.5 DBL4	34
III.6 DBL5	38
III.7 DBL6	42
III.8 DBL7	46
III.9 DBL8	50
III.10 DBK4	54
III.11 DBK5	58
III.12 DBK6	63
III.13 DBK7	70
IV Appendix	
IV.1 Delivery package, transport, storage, maintenance, disposal	73
IV.2 Removing faults	74
IV.3 Index	75

Safety Notes



- Only properly qualified personnel are permitted to perform such tasks as transport, assembly, setup and maintenance. Properly qualified personnel are persons who are familiar with the transport, assembly, installation, setup and operation of motors, and who have the appropriate qualifications for their jobs. The qualified personnel must know and observe the following standards and regulations:
 IEC 364 resp. CENELEC HD 384 or DIN VDE 0100
 IEC-report 664 or DIN VDE 0110
 national regulations for safety and accident prevention or BGV A2
- Read the available documentation before assembly and setup. Incorrect handling of the motors can result in injury and damage to persons and machinery. Keep strictly to the technical data and the information on the connection requirements (nameplate and documentation).
- The manufacturer of the machine must generate a hazard analysis for the machine, and take appropriate measures to ensure that unforeseen movements cannot cause injury or damage to any person or property.
- It is vital that you ensure that the motor housing is safely earthed to the PE(protective earth) busbar in the switch cabinet. Electrical safety is impossible without a low-resistance earth connection.
- Do not unplug any connectors during operation. This creates the danger of death, severe injury, or extensive material damage.
- Power connections may be live even when the motor is not rotating. Never disconnect the power connections of the motor while the equipment is energised. This can cause flashovers with resulting injuries to persons and damage to the contacts.
- After disconnecting the servoamplifier from the supply voltage, wait at least five minutes before touching any components which are normally live (e.g. contacts, screw connections) or opening any connections. The capacitors in the servoamplifier can still carry a dangerous voltage up to five minutes after switching off the supply voltages. To be quite safe, measure the DC-link voltage and wait until the voltage has fallen below 40V.
- The surfaces of the motors can be very hot in operation, according to their protection category. The surface temperature can reach 100°C. Measure the temperature, and wait until the motor has cooled down below 40°C before touching it.
- Remove any fitted key (if present) from the shaft before letting the motor run independently, to avoid the dangerous results of the key being thrown out by centrifugal forces.

Symbols used in this manual:

	Danger to personnel from electricity and its effects		General warning general instruction mechanical hazard
⇒	see chapter (cross reference)	●	special emphasis

Important Notes

- **Servomotors are precision equipment. The flange and shaft are especially vulnerable during storage and assembly — so avoid brute force. Precision requires delicacy. It is important to use the locking thread which is provided to tighten up couplings, gear wheels or pulley wheels and warm up the drive components, where possible. Blows or the use of force will lead to damage to the bearings and the shaft.**

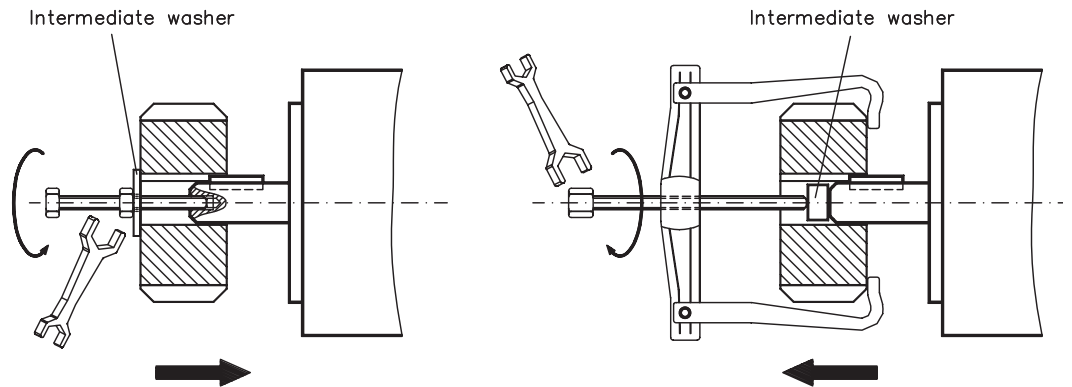

- **Wherever possible, use only backlash-free, frictionally-locking collets or couplings, e.g. from the manufacturers Baumann & Cie, Gerwah, Jacob, KTR or Ringspann. Ensure correct alignment of the couplings. A displacement will cause unacceptable vibration and the destruction of the bearings and the coupling.**
- **For toothed belts, it is vital to observe the permissible radial forces. An excessive radial load on the shaft will significantly shorten the life of the motor.**
- **Avoid axial loads on the motor shaft, as far as possible. Axial loading significantly shortens the life of the motor.**
- **In all cases, do not create a mechanically constrained motor shaft mounting by using a rigid coupling with additional external bearings (e.g. in a gearbox).**
- **For mounting style V3 (shaft end upwards), make sure that no liquid can enter the upper bearing.**
- **Take note of the no. of motor poles (6-pole) and the no. of resolver poles (2-pole), and ensure that the correct setting is made in the servoamplifier which is used. An incorrect setting can lead to the destruction of the motor, especially with small motors.**

Manufacturer declaration

According to the EG-Machine-guideline 98/37/EC, appendix II B

We, the company

Kollmorgen Seidel GmbH & Co. KG
Wacholderstrasse 40-42
40489 Düsseldorf

declare, that the product

Motor series DBL/DBK**(Types DBL1, DBL2, DBL3, DBL4, DBL5, DBL6, DBL7, DBL8, DBK4, DBK5, DBK6, DBK7)**

is intended exclusively, in its standard version, for installation in another machine and that its setup is forbidden until it has been established that the machine into which this product is to be installed conforms to the provisions of the EC Directive in its version 98/37/EC.

We confirm that the above-mentioned product conforms to the following standards:

73/23/EEC	Low voltage directive
VDE 0530 / DIN 57530	Provisions for rotating machinery
DIN 42950	Design
DIN 748	Cylindrical shaft ends
DIN 42955	True running, coaxiality and concentricity
DIN ISO 2373	Vibration class

Issued by: Management

Michael Schulte

This Declaration does not contain any assurance of properties. The notes on safety and protection in the operating instructions must always be observed.

I General

I.1 About this manual

This manual describes the DBL/DBK series of synchronous servomotors (standard version). Among other things, you find information about:

- | | | |
|---|---|-------------|
| ● | General description, standard version of the motors | Chapter I |
| ● | Installation, Setup, Wiring | Chapter II |
| ● | Technical data, dimensions and characteristics | Chapter III |
| ● | Notes on Transport, Storage, Maintenance, Disposal | Chapter IV |



This Manual is intended for the use of qualified staff with professional knowledge of electrical and mechanical engineering.

The motors are operated in drive systems together with servoamplifiers SERVOSTAR®. Please observe the entire system documentation, consisting of:

- Installation and setup instructions for the servoamplifier
- Installation and setup instructions for any expansion card which is connected
- Operating manual for the Operator Software of the servoamplifier
- Technical description of the DBL/DBK series of motors

I.2 Prescribed usage

The DBL/DBK series of synchronous servomotors is designed especially for drives for industrial robots, machine tools, textile and packing machinery and similar with high requirements for dynamics.

The user is **only** permitted to operate the motors under the ambient conditions which are defined in this documentation.

The DBL/DBK series of motors is **exclusively** intended to be driven by servoamplifiers from the SERVOSTAR series under speed and / or torque control.

The motors are installed as components in electrical apparatus or machines and can only be commissioned and put into operation as integral components of such apparatus or machines.

The motors must never be connected directly to the mains supply.

The thermal contact which is integrated in the motor windings must be observed and evaluated.

The conformity of the servo-system to the standards mentioned in the manufacturers declaration on page 6 is only guaranteed when the components (servoamplifier, motor, leads etc.) that are used have been supplied by us.

I.3 Design of the motors

Synchronous servomotors in the DBL/DBK series are brushless DC motors for demanding servo applications. When combined with our digital servoamplifiers they are especially suited for positioning tasks in industrial robots, machine tools, transfer lines etc. With high requirements for dynamics and stability.

The servomotors have permanent magnets in the rotor. The rare earth neodymium -iron-boron magnetic material is an important factor in making it possible to drive these motors in a highly dynamic fashion. A three-phase winding which is driven by the servoamplifier is integrated into the stator. The motor does not have any brushes since commutation is performed electronically by the servoamplifier.

The temperature of the winding is monitored by temperature sensors in the stator windings and is signalled via an electrically isolated contact (normally closed, DBL1: PTC/3k Ω).

A **resolver** is built into the motors as standard feedback element. The servoamplifiers in the SERVOSTAR series evaluate the resolver position and supply sinusoidal currents to the motors. The motors can be delivered with or without a built-in holding brake. Retrofitting of the brake is not possible.

The motors are enamelled in matt black (RAL 9005). This finish is not resistant against solvents (e.g. trichlorethylene, nitro-thinners, or similar).

I.4 General technical data

Climate category	3K3 to EN 50178
Ambient temperature (at rated values)	5...+40°C for site altitude up to 1000m amsl It is vital to consult our applications department for ambient temperatures above 40°C and encapsulated mounting of the motors.
Permissible humidity (at rated values)	85% rel. humidity, no condensation
Power derating (currents and torques)	1% / K in range 40°C...50°C up to 1000m amsl for site altitude above 1000m amsl and 40°C 6% up to 2000m amsl 17% up to 3000m amsl 30% up to 4000m amsl 55% up to 5000m amsl No derating for site altitudes above 1000m amsl with temperature reduction of 10K / 1000m
Max. permissible flange temperature	65°C at rated values
Ball-bearing life	≥ 20.000 operating hours
Technical data	⇒ III
Storage data	⇒ IV.1

I.5 Standard features

I.5.1 Style

The basic style for the DBL/DBK synchronous motors is style IM B5 according to DIN42950. The permitted mounting positions may be read from the technical data of the motor series.

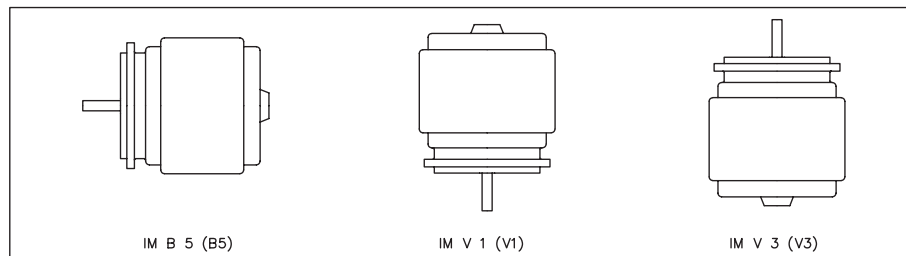

I.5.2 Shaft end, A-side

Power transmission is made through the cylindrical shaft end A (fit k6) to DIN 748, with a locking thread (except DBL1/DBL2) but **without a fitted-keyway**.

If the motors drive via pinions or toothed belts, then high radial forces will occur. The permissible values at the end of the shaft may be read from the diagrams in chapter III. The maximum values at rated speed you will find at the technical data. Power take-off from the middle of the free end of the shaft allows a 10% increase in F_R .

The curves are based on a bearing life of 20.000 operating hours.

The axial force F_A must not exceed $F_R/3$.

Double-coned collets have proved to be ideal zero-backlash coupling devices, combined, if required, with metal bellows couplings.

I.5.3 Flange

Flange dimensions to IEC standard, fit j6, accuracy according to DIN 42955.
Tolerance class: **R**

I.5.4 Protection class

Standard version	IP65
Standard shaft bushing	IP64
Shaft bushing with shaft-sealing ring	IP65

I.5.5 Protective device

The standard version of each motor is fitted with a thermostat (electrically isolated, normally closed, DBL1: PTC/3k Ω). You will find the switching point at the technical data. The thermostat does **not** provide any protection against short, heavy overloading. Provided that our preassembled resolver cable is used, the thermostat contact is integrated into the monitoring system of the digital servoamplifier SERVOSTAR.

The flange temperature must not exceed 65°C in rated operation.

I.5.6 Insulation material class

The motors come up to insulation material class F according to DIN 57530.

I.5.7 Vibration class

The motors are made to vibration class N according to DIN ISO 2373.

I.5.8 Connection method

<u>Motor series</u>	<u>Resolver</u>	<u>Power</u>
DBL1	Cable	Cable
DBL2..DBL6, DBK	Connector	Connector
DBL7, DBL8	Connector	Terminal box

The mating connectors are not part of the delivery package. We can supply preassembled resolver and power leads.

In Chapter II.2.1 you will find notes on the cable materials.

I.5.9 Feedback unit

The motors are equipped with two-pole hollow-shaft resolvers as standard.

As an option, the motors (except DBL1) are available with built in single- (ECN1313) or multiturm (EQN1325) EnDat-encoders (DBL2: ECN 1113 / EQN 1125).

The motor length changes when an encoder is mounted. Retrofitting is not possible.

I.5.10 Holding brake

The motors are optionally available with a holding brake (except DBL1).

A permanent magnet brake (24V DC) is integrated into the G-motors. When this brake is de-energized it blocks the rotor. **The holding brakes are designed as standstill brakes** and are not suited for repeated operational braking. If the brake is released then the rotor can be moved without a remanent torque, the operation is free from backlash! The motor length increases when a holding brake is mounted.

The holding brake can be controlled directly by SERVOSTAR-servoamplifier (no personal safety !), the winding is suppressed in the servoamplifier — additional circuitry is not required.

If the holding brake is not controlled directly by the servoamplifier, an additional wiring (e.g. varistor) is required. Consult our applications department beforehand.

A personal safe operation of the holding brake requires an additional contact (normally opened) in the braking circuit and an anti-surge-device (e.g. Varistor) for the brake.

Wiring example for SERVOSTAR 600

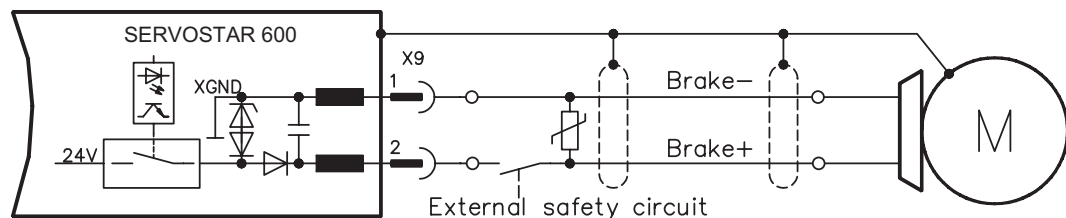

I.6 Options

— Holding brake

Built-in holding brake (\Rightarrow I.5.10).
Motor length increases by the holding brake.

— Radial shaft-sealing rings

A radial shaft-sealing ring can be supplied at extra charge to seal against oil mist and oil spray. This increases the protection rating of the shaft bushing to IP65. The sealing ring is not suitable for dry running. When a holding brake is built in, the motor length increases by a sealing ring for approximately 10mm.

— Vertical mounting sockets

If fitted with angular sockets for feedback and power connectors, the motors are also available with vertical sockets.

— Keyway

The motors are available with keyway and key inserted according to DIN748
The shaft is balanced with a short (half) key.

— EnDat

A high resolution EnDat-encoder is mounted instead of the resolver (\Rightarrow I.5.9).
The motor length increases by the encoder.

— 2nd Thermostat

An additional thermostat can be applied to the motor winding. The connection takes place via the power connector resp. the terminal box.

— Forced ventilation

For some motors ventilation bonnets are available which cool the motor electrically.
Connection takes place via a 6-pole angular socket
With the ventilation bonnet mounted, the dimensions and nominal data of the motors vary.
Please consult our applications department.

All options can **not** be retrofitted.

I.7 Selection criteria

The three-phase servomotors are designed to operate with SERVOSTAR servoamplifiers.
Together, both units form a closed speed or torque control loop.

The most important selection criteria are:

—	Standstill torque	M_0	[Nm]
—	Rated speed	n_n	[min ⁻¹]
—	Moment of inertia of motor and load	J	[kgcm ²]
—	Effective torque (calculated)	M_{rms}	[Nm]

When calculating the motors and servoamplifiers which are required, take account of the static load **and** the dynamic load (acceleration/braking). Collected formulae and examples of the calculations are available from our applications department.

I.7.1 Model number description

The type code is only described briefly here. It is sufficient to give the 10-figure motor designation (AAA.....) as ordering information, provided that any deviations of the features and accessories from the standard version are given in plain text.

Example Order text: **DBL4H00260**
with holding brake and multi-turn Endat encoder

The correct and complete type code will then be generated by the manufacturer:

DBL4H00260 - 01 3M 00 00 00 00 0 - 00285E

Description of the individual positions in the type code:

AAAAAAAA - BB CC DD EE FF GG H - KKKKKK

Abbreviation	Number of figures	Name	Content
AAAAAAAAAA	10	Motor name	Name of the standard motor, ignoring any options
-	1		-
BB	2	Brake	00 for standard
CC	2	Feedback	02 for standard
DD	2	Connection for feedback/power	00 for standard
EE	2	Shaft design	00 for standard
FF	2	Thermal protection	00 for standard
GG	2	Protection class	00 for standard
H	1	Ventilation	00 for standard
-	1		-
KKKKKK	6	Motor number	serial number

I.7.2 Nameplate

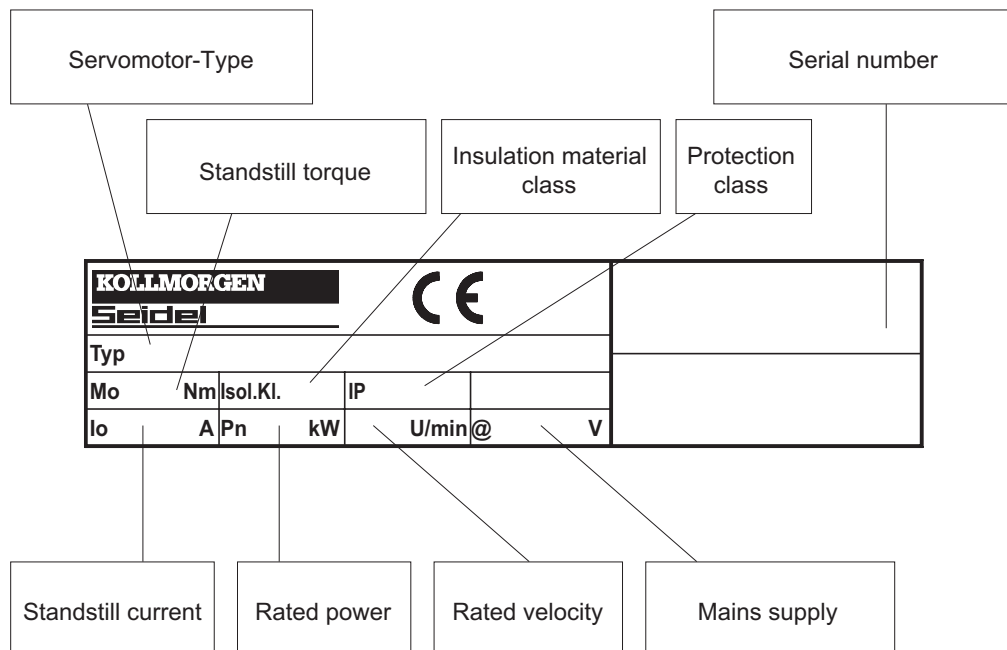

II Installation / Setup

II.1 Important notes

- Check that the servoamplifier and motor match each other. Compare the rated voltage and rated current of the unit. Carry out the wiring according to the wiring diagram in the Installation and Setup Instructions for the servoamplifier. The connections to the motor are shown on pages 17f. Notes on the connection methods can be found on page 16.
- Ensure that there is proper earthing of the servoamplifier and the motor.
- Route the power and control cables as separately as possible from one another (separation > 20 cm). This will improve the immunity of the system to electromagnetic interference. If a motor power cable is used which includes integral brake control leads, then these brake control leads must be shielded. The shielding must be connected at both ends (see under Installation Instructions for the servoamplifier).
- Install all cables carrying a heavy current with an adequate cross-section, as per EN 60204. The recommended cross-section can be found in the Technical data.



Caution!

If a servoamplifier of the series SERVOSTAR 601 ..620 is used and the motor cable exceeds 25m, a boxed choke (type 3YL-20, manufactured by Kollmorgen Seidel) and motor leads with the following diameters must be used:

Servo amplifier	Choke box	Max. diameter of the motor lead
SERVOSTAR 601...606	3YL-20	4 x 1mm ²
SERVOSTAR 610	3YL-20	4 x 1,5mm ²
SERVOSTAR 620	3YL-20	4 x 2,5 mm ²

- Connect up all shielding via a wide surface-area contact (low impedance) and metallized connector housings or EMC-cable glands.
- Check the compliance to the permitted radial and axial forces F_R and F_A . When you use a toothed belt drive, the **minimal** permitted diameter of the pinion e.g. follows from the equation: $d_{\min} \geq \frac{M_0}{F_R} \times 2$.
- Ensure that there is adequate heat transfer in the surroundings and the motor flange, so that the maximum permissible flange temperature is not exceeded in S1 operation.



Caution!

Never undo the electrical connections to the motor while it is energised. A dangerous voltage, resulting from residual charge, can be still present on the capacitors up to 5 minutes after switch-off of the mains supply.

Measure the DC-link voltage and wait until it has fallen below 40V.

Even when the motor is not rotating, control and power leads may be live.

II.2 Assembly / Wiring

Only qualified staff with knowledge of mechanical engineering are permitted to assemble the motor.

Only staff qualified and trained in electrical engineering are allowed to wire up the motor.

The procedure is described as an example. A different method may be appropriate or necessary, depending on the application of the equipment.



Warning!

Protect the motor from unacceptable stresses.

Take care, especially during transport and handling, that components are not bent and that insulation clearances are not altered.

Always make sure that the motors are de-energized during assembly and wiring, i.e. No voltage may be switched on for any piece of equipment which is to be connected.

Ensure that the switch cabinet remains turned off (barrier, warning signs etc.).

The individual voltages will only be turned on again during setup



Note!

The ground symbol |||| , which you will find in the wiring diagrams, indicates that you must provide an electrical connection, with as large a surface area as possible, between the unit indicated and the mounting plate in the switch cabinet. This connection is to suppress HF interference and must not be confused with the PE (protective earth) symbol (protective measure to EN 60204).

To wire up the motor, use the wiring diagrams in the Installation and Setup Instructions of the servoamplifier which is used.

The following notes should help you to carry out the assembly and wiring in an appropriate sequence, without overlooking anything.

Site	The site must be free of conductive and aggressive material. For V3-mounting (shaft end upwards), make sure that no liquids can enter the bearings. If an encapsulated assembly is required, please consult our applications department beforehand.
Ventilation	Ensure an unhindered ventilation of the motors and observe the permissible ambient and flange temperatures. For ambient temperatures above 40°C please consult our applications department beforehand.
Assembly	During assembly, take care that the motor is not overstressed when it is fixed in place.
Cable selection	Select cables according to EN 60204 See the table in chapter II.1 when cable length exceeds 25m.
Earthing Shielding	Use correct earthing and EMC-shielding according to the Installation instructions for the servoamplifier which is used. Earth the mounting plate and motor casing. For connection methods see chapter II.2.1.
Wiring	<ul style="list-style-type: none">— Route power cables as separately as possible from control cables— Connect up the resolver or encoder.— Connect the motor leads, install motor chokes close to the servoamplifier, connect shields to shielding terminals or EMC connectors at both ends— Connect the holding brake, if used, Connect shielding at both ends.
Check	Final check of the installed wiring, according to the wiring diagram which was used

II.2.1 Connection of the motors



- Carry out the wiring in accordance with the valid standards and regulations.
- Only use our preassembled shielded leads for the resolver and power connections.
- Connect up the shielding according to the wiring diagrams in the Installation Instructions for the servoamplifier.
- Incorrectly installed shielding inevitably leads to EMC interference.

In the table below you find all leads supplied by us. Further information referring to chemical, mechanical and electrical qualities can be received from our applications department.

Insulating material

- Sheathing - PUR (Polyurethane, identification 11Y)
 core insulation - PETP (Polyesteraphtalate, identification 12Y)

Capacity

- Motor lead - less than 150 pF/m
 Resolver lead - less than 120 pF/m

Technical Data

- All leads are UL-listed. The UL-Style-number is printed on the sheathing.
- All leads are suitable for trailing.
- Technical data refer to mobile usage of leads.
 Life time: 1 Million bending cycles
- The temperature range refers to the operation temperature.
- Identification:
 - N = numbered cores
 - F = cores with colour code according to DIN 47100
 - B = cores with letter identification
 - () = shielding

Cores [mm ²]	Identification	Temperature range [°C]	Cable diameter [mm]	Bending radius [mm]	Remarks
(4x1,0)	F	-30 / +80	10,5	105	Motor lead
(4x1,5)	B	-30 / +80	11,3	115	
(4x2,5)	N	-5 / +70	12,7	125	
(4x1,0+(2x0,75))	F	-30 / +80	12	120	Motor lead with integral brake control leads
(4x1,5+(2x0,75))	B	-10 / +80	12,5	125	
(4x2,5+(2x1))	B	-30 / +80	13,8	140	Resolver lead
(4x2x0,25)	F	-30 / +80	6,9	60	Resolver lead
(7x2x0,25)	F	-10 / +80	9,5	95	Encoder lead

II.2.1.1 Wiring diagram for resolver motors

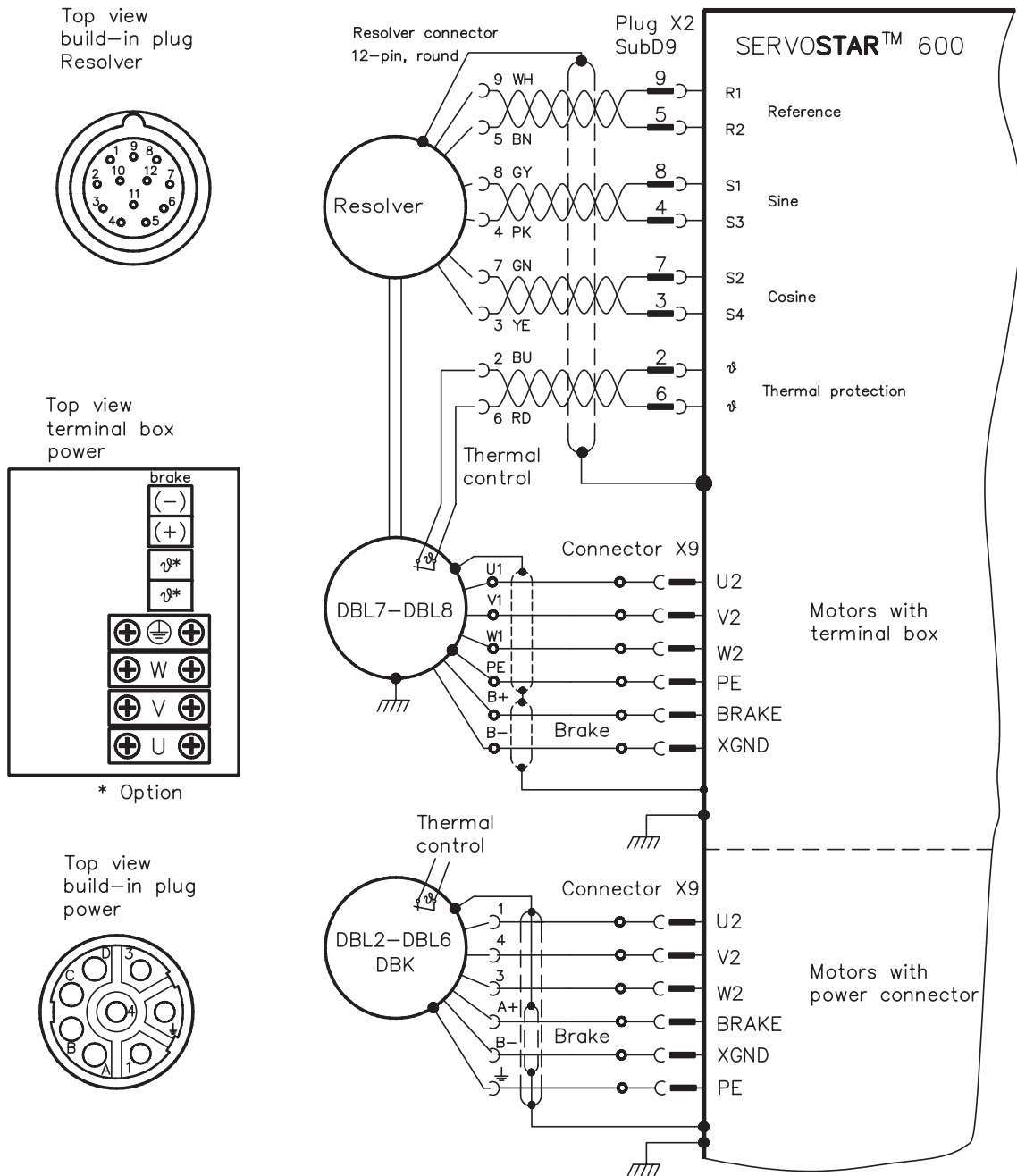

connector round, 12-poles

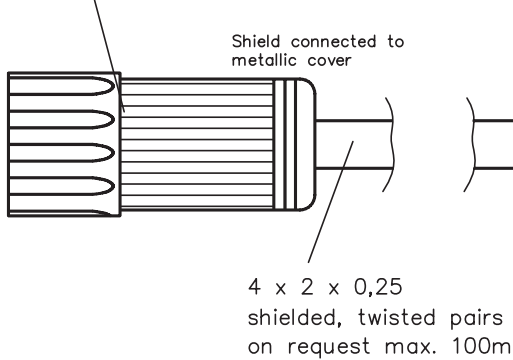

Sub-D connector 9-poles

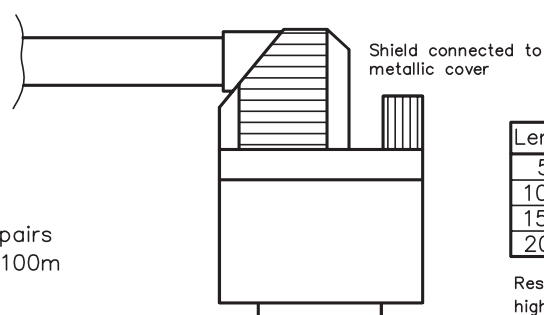

Length	Mat.No.
5m	84972
10m	84973
15m	84974
20m	84975

Res. cable with connector higher lengths up to 100m on request.

colour coding acc. to IEC 757

II.2.1.2 Wiring diagram for encoder motors

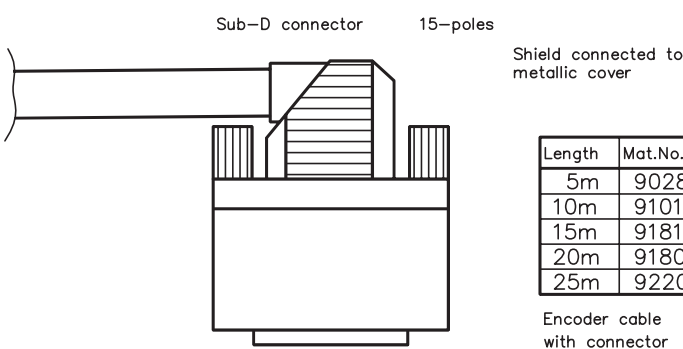
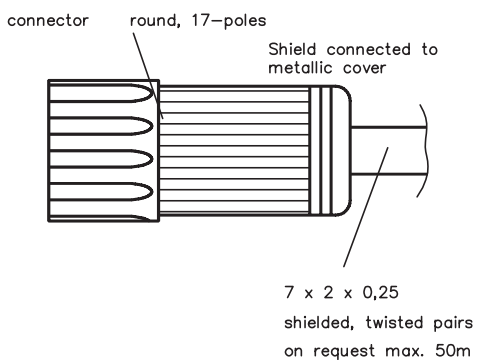
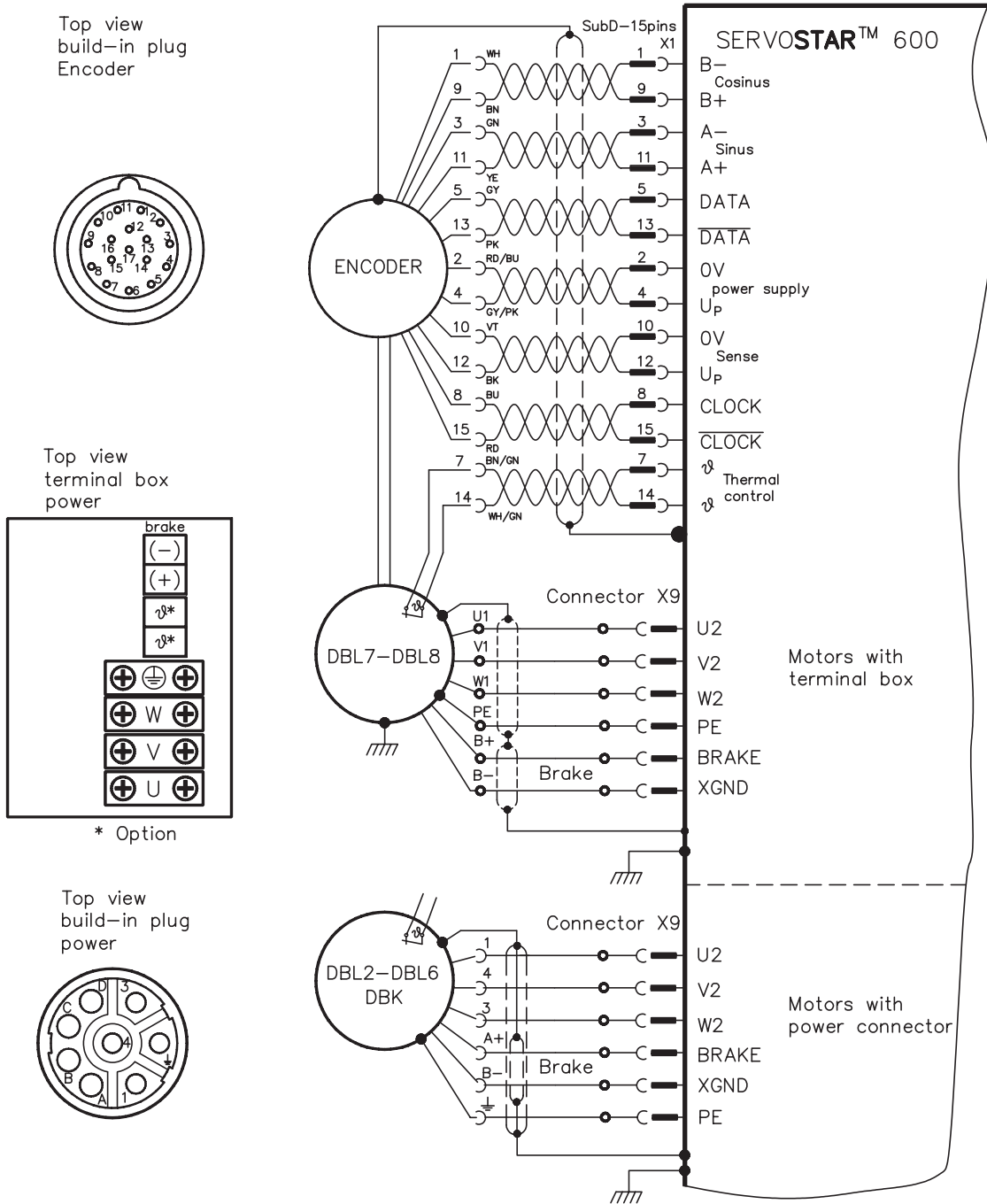

Length	Mat.No.
5m	90287
10m	91019
15m	91811
20m	91807
25m	92205

Encoder cable with connector

colour coding acc. to IEC 757

II.3 Setup

The procedure for setup is described as an example. A different method may be appropriate or necessary, depending on the application of the equipment.

Only specialist personnel with extensive knowledge in the areas of electrical engineering / drive technology are allowed to commission the drive unit of servoamplifier and motor.



Caution!

Check that all live connection points (terminal boxes) are safe against accidental contact. Deadly voltages can occur, up to 900V.

Never undo the electrical connections to the motor when it is live. The residual charge in the capacitors of the servoamplifier can produce dangerous voltages up to 5 minutes after the mains supply has been switched off.

The surface temperature of the motor can reach 100°C in operation.

Check (measure) the temperature of the motor. Wait until the motor has cooled down below 40°C before touching it.

Make sure that, even if the drive starts to move unintentionally, no danger can result for personnel or machinery.

- Check the assembly and orientation of the motor.
- Check the drive components (clutch, gear unit, belt pulley) for the correct seating and setting (observe the permissible radial and axial forces).
- Check the wiring and connections to the motor and the servoamplifier. Check that the earthing is correct.
- Test the function of the holding brake, if used. (apply 24V, the brake must be released).
- Check whether the rotor of the motor revolves freely (release the brake, if necessary). Listen out for grinding noises.
- Check that all the required measures against accidental contact with live and moving parts have been carried out.
- Carry out any further tests which are specifically required for your system.
- Now commission the drive according to the setup instructions for the servo amplifier.
- In multi-axis systems, individually commission each drive unit (servoamplifier and motor).

This page has been deliberately left blank.

III Technical data

III.1 Definitions

Standstill torque M_0 [Nm]

The standstill torque can be maintained indefinitely at a speed $n=0 \text{ min}^{-1}$ and rated ambient conditions.

Rated torque M_n [Nm]

The rated torque is produced when the motor is drawing the rated current at the rated speed. The rated torque can be produced indefinitely at the rated speed in continuous operation (S1).

Standstill current I_{0rms} [A]

The standstill current is the effective sinusoidal current which the motor draws during standstill to produce the standstill torque.

Rated current I_{nrms} [A]

The rated current is the effective sinusoidal current which the motor draws at the rated speed in order to produce the rated torque.

Peak current (pulse current) I_{0max} [A]

The peak current (effective sinusoidal value) is approximately equivalent to 4-times the rated current. The actual value is determined by the peak current of the servoamplifier which is used.

Torque constant K_{Trms} [Nm/A]

The torque constant defines how much torque in Nm is produced by the motor with 1A r.m.s. current. The relationship is $M=I \times K_T$ (up to $I = 2 \times I_0$)

Voltage constant K_{Erms} [mV/min⁻¹]

The voltage constant defines the induced motor EMF, as an effective sinusoidal value between two terminals, per 1000 rpm

Rotor moment of inertia J [kgcm²]

The constant J is a measure of the acceleration capability of the motor. For instance, at I_0 the acceleration time t_b from 0 to 3000 rpm is given as:

$$t_b [\text{s}] = \frac{3000 \times 2\pi}{M_0 \times 60\text{s}} \times \frac{m^2}{10^4 \times \text{cm}^2} \times J \quad \text{with } M_0 \text{ in Nm and } J \text{ in kgcm}^2$$

Thermal time constant t_{th} [min]

The constant t_{th} defines the time for the cold motor, under a load of I_0 , to heat up to an overtemperature of 0.63×105 Kelvin. This temperature rise happens in a much shorter time when the motor is loaded with the rated current.

Release delay time t_{BRH} [ms] / Application delay time t_{BRL} [ms] of the brake

These constants define the response times of the holding brake when operated with the rated voltage from the servoamplifier.

III.2

DBL1

Technical data

Data		Symbol [Unit]	DBL1 X00010	DBL1 X00020
Electrical data				
	Standstill torque	M_0 [Nm]	0,1	0,2
	Standstill current	I_{0rms} [A]	0,60	0,93
	Mains voltage	U_N [VAC]	230	
$U_N =$ 230V	Rated speed	n_n [min ⁻¹]	6000	6000
	Rated torque	M_n [Nm]	0,09	0,18
	Rated current	I_n [A]	0,59	0,89
	Rated power	P_n [kW]	0,06	0,11
$U_N =$ 400V	Rated speed	n_n [min⁻¹]	—	—
	Rated torque	M_n [Nm]	—	—
	Rated current	I_n [A]	—	—
	Rated power	P_n [kW]	—	—
$U_N =$ 480V	Rated speed	n_n [min ⁻¹]	—	—
	Rated torque	M_n [Nm]	—	—
	Rated current	I_n [A]	—	—
	Rated power	P_n [kW]	—	—
	Peak current	I_{0max} [A]	2,8	4,3
	Torque constant	K_{Trms} [Nm/A]	0,17	0,22
	Voltage constant	K_{Erms} [mV/min]	10	13
	Winding resistance Ph-Ph	R_{20} [Ω]	38,2	22
	Winding inductance Ph-Ph	L [mH]	6,5	4,7
Mechanical data				
	Rotor moment of inertia	J [kgcm ²]	0,06	0,12
	Static friction torque	M_R [Nm]	0,01	0,01
	Thermal time constant	t_{TH} [min]	5	7
	Weight standard	G [kg]	0,7	0,8
	Radial load permitted at shaft end @ 6000 min ⁻¹	F_R [N]	60	
	Axial load permitted at shaft end @ 6000 min ⁻¹	F_A [N]	20	
	Motor number		00647R	00670R

Connections and leads

Data	DBL1 X00010	DBL1 X00020
Power connection	cable	
Motor cable, shielded	4 x 1	
Resolver connection	cable	
Resolver cable, shielded	4 x 2 x 0,25mm ²	

Dimensions (drawing in principle)

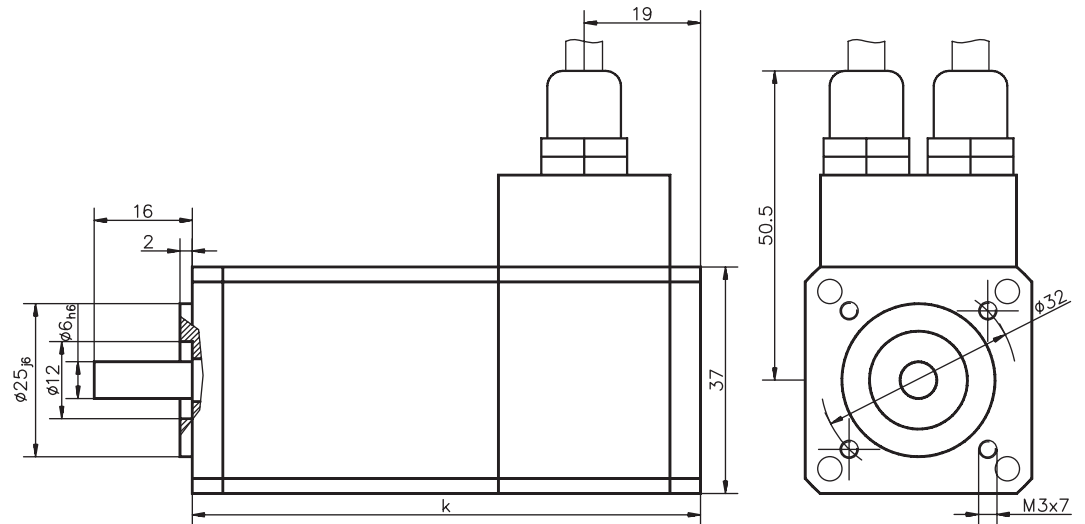

TYP	K
DBL1X00010	83
DBL1X00020	99

Pin assignment

The motors of the DBL1 series are fitted with loose cables (length approx. 80cm). The cables are stripped, the power cores are additionally fitted with ferrules. The shielding braids are twisted to a cord each. The resolver leads are colour-coded according to IEC 757, the power leads (except PE) are numbered.

Power Cable

Lead	Connection
1	U2
2	V2
3	W2
GNYE	PE

Resolver Cable

Lead	Connection	Pin-No. Resolver connector (servoamplifier)
WH	- Reference	9
BN	+ Reference	5
GN	- Cosine	7
YE	+ Cosine	3
GY	+ Sine	8
PK	- Sine	4
BU	Thermostat	2
RD	Thermostat	6

Radial-/axial forces at the shaft end

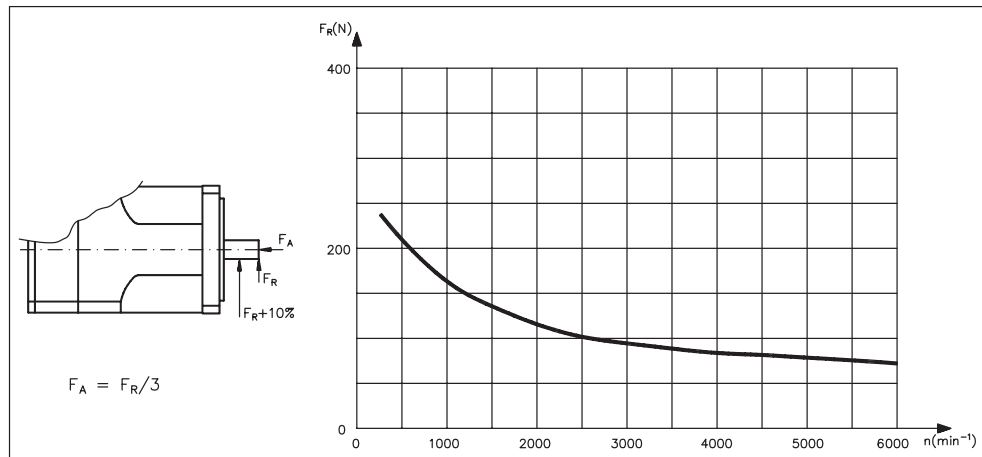

Performance curves

DBL1X00010

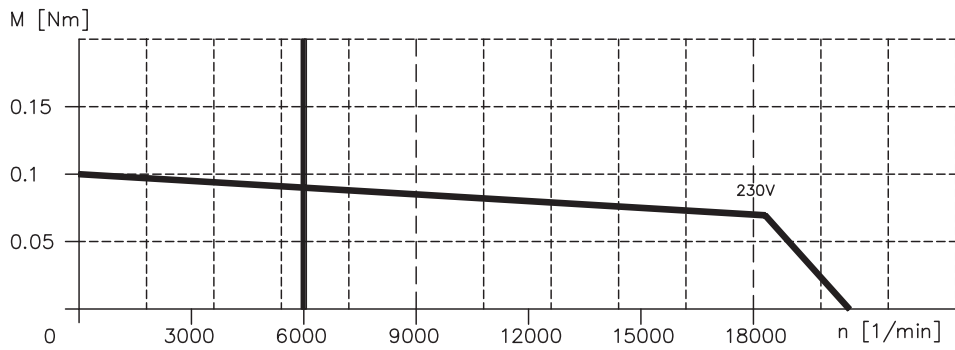

DBL1X00020

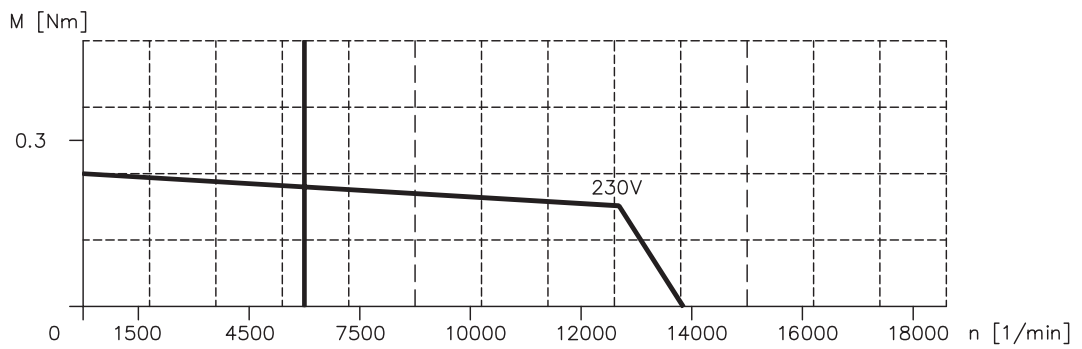

This page has been deliberately left blank.

III.3

DBL2

Technical data

Data	Symbol [Unit]	DBL2 H00040	DBL2 H00060	DBL2 M00080	DBL2 H00080	
Electrical data						
Standstill torque	M_0 [Nm]	0,4	0,6	0,8	0,8	
Standstill current	I_{0rms} [A]	0,93	1,5	0,83	1,49	
Mains voltage	U_N [VAC]	230-480				
$U_N = 230V$	Rated speed	n_n [min ⁻¹]	4500	4500	—	4500
	Rated torque	M_n [Nm]	0,36	0,55	—	0,72
	Rated current	I_n [A]	0,90	1,42	—	1,45
	Rated power	P_n [kW]	0,17	0,26	—	0,34
$U_N = 400V$	Rated speed	n_n [min⁻¹]	6000	6000	4500	6000
	Rated torque	M_n [Nm]	0,34	0,52	0,72	0,69
	Rated current	I_n [A]	0,70	1,27	0,83	1,10
	Rated power	P_n [kW]	0,21	0,33	0,34	0,43
$U_N = 480V$	Rated speed	n_n [min ⁻¹]	—	—	—	—
	Rated torque	M_n [Nm]	—	—	—	—
	Rated current	I_n [A]	—	—	—	—
	Rated power	P_n [kW]	—	—	—	—
Peak current	I_{0max} [A]	4,3	6,8	3,8	6,8	
Torque constant	K_{Trms} [Nm/A]	0,43	0,41	0,96	0,54	
Voltage constant	K_{Erms} [mV/min]	26	25	58	33	
Winding resistance Ph-Ph	R_{20} [Ω]	26,5	14,8	47,7	14,7	
Winding inductance Ph-Ph	L [mH]	20	13,2	43	13	
Mechanical data						
Rotor moment of inertia	J [kgcm ²]	0,08	0,11	0,13		
Static friction torque	M_R [Nm]	0,02	0,02	0,02		
Thermal time constant	t_{TH} [min]	15	20	22		
Weight standard	G [kg]	1,1	1,25	1,5		
Radial load permitted at shaft end @ 3000 min ⁻¹	F_R [N]	115				
Axial load permitted at shaft end @ 3000 min ⁻¹	F_A [N]	40				
Motor number		00288R	00558R	00348R	00293R	

Brake data

Data	Symbol [Unit]	Value
Holding torque	M_{BR} [Nm]	1,2
Operating voltage	U_{BR} [VDC]	24 +15 / -0 %
electrical power	P_{BR} [W]	8
Moment of inertia	J_{BR} [kgcm ²]	0,07
Release delay time	t_{BRH} [ms]	15-20
Application delay time	t_{BRL} [ms]	5-10
Weight of the brake	G_{BR} [kg]	0,3

Connections and leads

Data	DBL2 H00040	DBL2 H00060	DBL2 M00080	DBL2 H00080
Power connection	4 + 4 poles, round, angular			
Motor cable, shielded	4 x 1			
Motor cable with control leads, shielded	4 x 1 + 2 x 0,75			
Resolver connection	12 poles, round, angular			
Resolver cable, shielded	4 x 2 x 0,25mm ²			
Encoder connection (Option)	17 poles, round, angular			
Encoder cable, shielded	7 x 2 x 0,25mm ²			

Dimensions (drawing in principle)

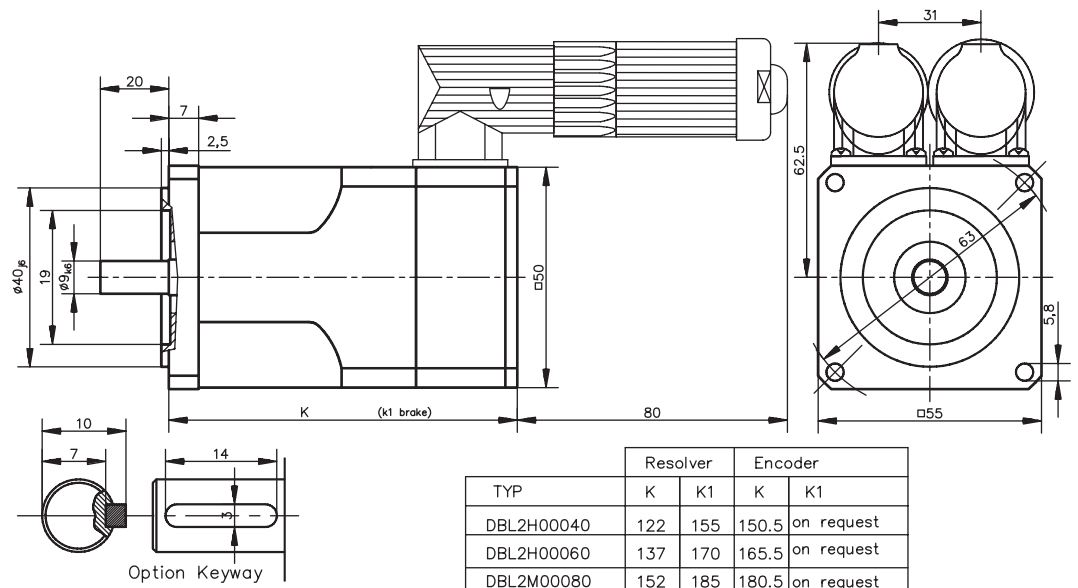

Pin assignment

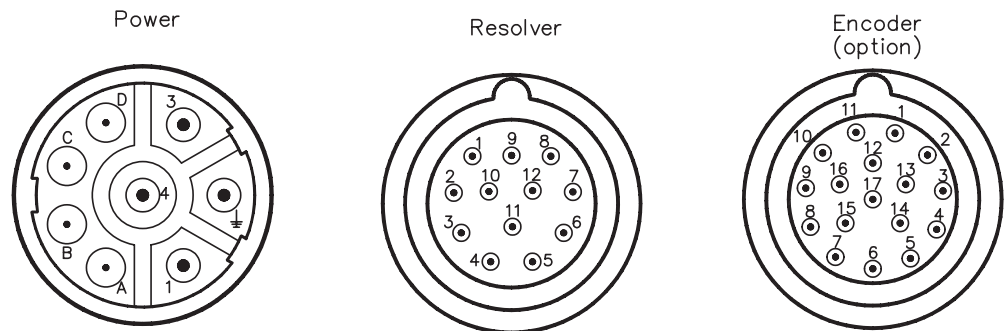

Power connector		Resolver connector		Encoder connector (Option)	
Pin	Connection	Pin	Connection	Pin	Connection
1	U2	1	n.c.	1	B- (Cosine)
⏏	PE	2	Thermostat	2	0 V (power supply)
3	W2	3	+ Cosine	3	A- (Sine)
4	V2	4	- Sine	4	U _P (power supply)
		5	+ Reference	5	DATA
A	Brake +	6	Thermostat	6	n.c.
B	Brake -	7	- Cosine	7	Thermostat
C	2nd Thermostat (Option)	8	+ Sine	8	CLOCK
D	2nd Thermostat (Option)	9	- Reference	9	B+ (Cosine)
		10	n.c.	10	0 V (Sense)
		11	n.c.	11	A+ (Sine)
		12	n.c.	12	U _P (Sense)
				13	DATA
				14	Thermostat
				15	CLOCK
				16	n.c.
				17	n.c.

Radial-/axial forces at the shaft end

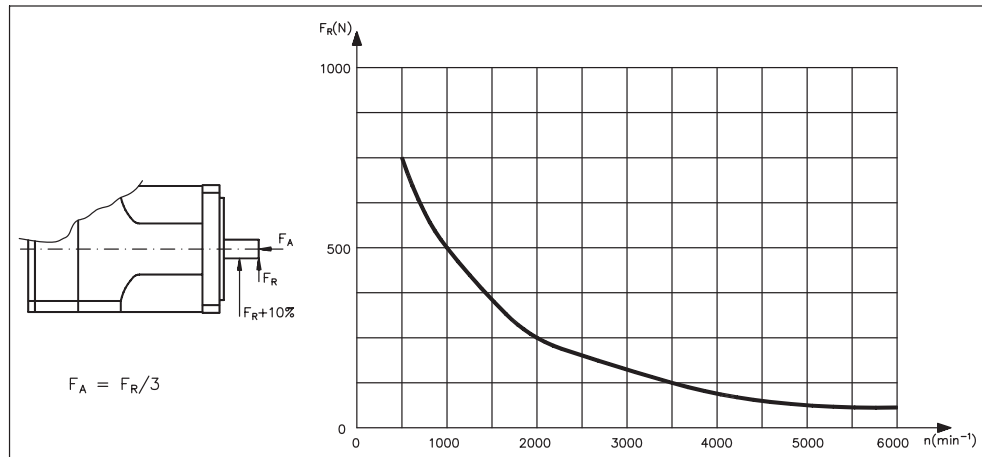

Performance curves

DBL2H00040

M [Nm]

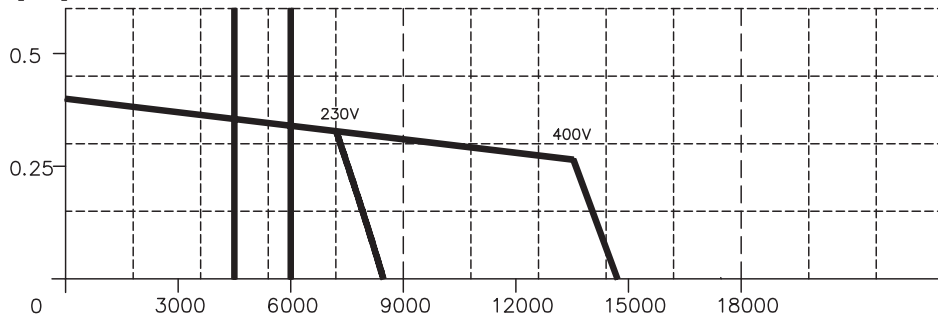

DBL2H00060

M [Nm]

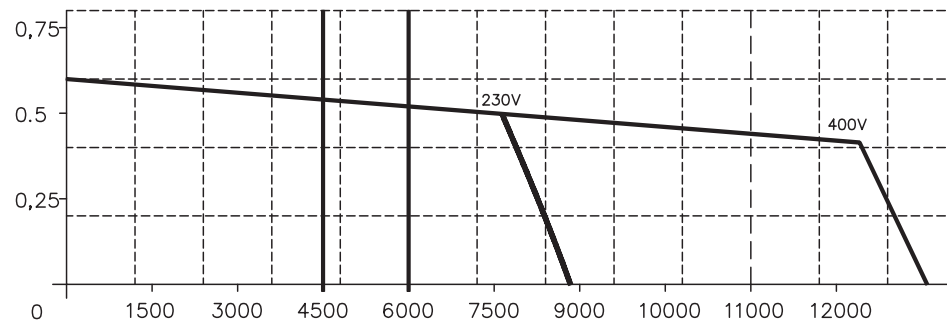

DBL2M00080

M [Nm]

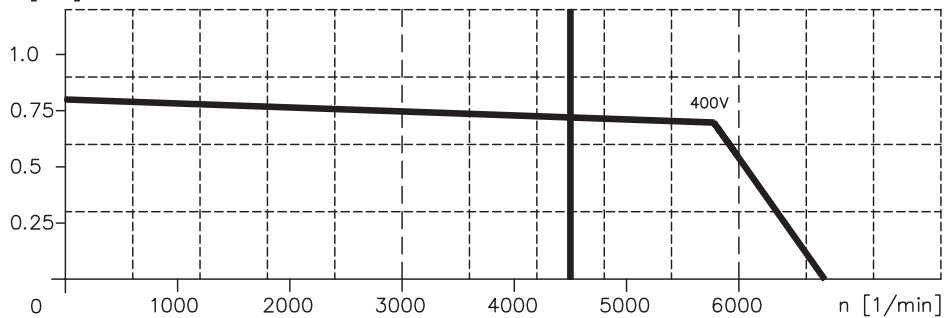

DBL2H00080

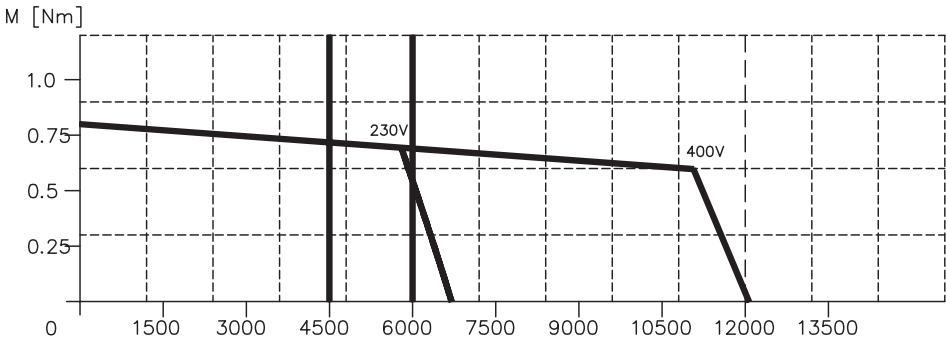

III.4 DBL3

Technical data

Data	Symbol [Unit]	DBL3 N00065	DBL3 H00065	DBL3 N00130	DBL3 H00130	DBL3 M00190	DBL3 H00250	DBL3 N00300
Electrical data								
Standstill torque	M_0 [Nm]	0,65	0,65	1,3	1,3	1,9	2,5	3,0
Standstill current	I_{0rms} [A]	0,67	1,08	1,0	1,75	1,5	3,0	2,1
Mains voltage	U_N [VAC]	230-480						
$U_N = 230V$	Rated speed	n_n [min^{-1}]	—	3000	—	3000	—	3000
	Rated torque	M_n [Nm]	—	0,6	—	1,2	—	2,2
	Rated current	I_n [A]	—	1,05	—	1,6	—	2,7
	Rated power	P_n [kW]	—	0,19	—	0,38	—	0,69
$U_N = 400V$	Rated speed	n_n [min^{-1}]	3000	6000	3000	6000	3000	6000
	Rated torque	M_n [Nm]	0,60	0,48	1,20	1,1	1,6	1,80
	Rated current	I_n [A]	0,65	0,95	0,95	1,5	1,32	2,40
	Rated power	P_n [kW]	0,19	0,30	0,38	0,69	0,50	1,13
$U_N = 480V$	Rated speed	n_n [min^{-1}]	3600	—	3600	—	3600	—
	Rated torque	M_n [Nm]	0,58	—	1,15	—	1,54	—
	Rated current	I_n [A]	0,59	—	0,90	—	1,21	—
	Rated power	P_n [kW]	0,22	—	0,43	—	0,58	—
Peak current	I_{0max} [A]	3,0	5,0	4,5	7,5	6,9	13,9	9,5
Torque constant	K_{Trms} [Nm/A]	0,98	0,60	1,28	0,74	1,27	0,83	1,46
Voltage constant	K_{Erms} [mV/min]	59	36,5	77,5	45	77	50	88
Winding resistance Ph-Ph	R_{20} [Ω]	79	30,3	35,5	13	21,3	5,1	11,5
Winding inductance Ph-Ph	L [mH]	82,8	31	61	22	40	11	25
Mechanical data								
Rotor moment of inertia	J [kgcm ²]	0,5		0,8		1,0	1,4	1,7
Static friction torque	M_R [Nm]	0,02		0,02		0,03	0,05	0,05
Thermal time constant	t_{TH} [min]	25		30		32	32	35
Weight standard	G [kg]	1,9		2,3		2,5	3,3	4
Radial load permitted at shaft end @ 3000 min^{-1}	F_R [N]	350						
Axial load permitted at shaft end @ 3000 min^{-1}	F_A [N]	110						
Motor number		00299R	00276R	00258R	00275R	00263R	00420R	00252R

Brake data

Data	Symbol [Unit]	Value
Holding torque	M_{BR} [Nm]	2,5
Operating voltage	U_{BR} [VDC]	24 +15 / -0 %
electrical power	P_{BR} [W]	12
Moment of inertia	J_{BR} [kgcm ²]	0,38
Release delay time	t_{BRH} [ms]	10-15
Application delay time	t_{BRL} [ms]	10-15
Weight of the brake	G_{BR} [kg]	0,4

Connections and leads

Data	DBL3 N00065	DBL3 H00065	DBL3 N00130	DBL3 H00130	DBL3 M00190	DBL3 H00250	DBL3 N00300
Power connection	4 + 4 poles, round, angular						
Motor cable, shielded	4 x 1						
Motor cable with control leads, shielded	4 x 1 + 2 x 0,75						
Resolver connection	12 poles, round, angular						
Resolver cable, shielded	4 x 2 x 0,25mm ²						
Encoder connection (Option)	17 poles, round, angular						
Encoder cable, shielded	7 x 2 x 0,25mm ²						

Dimensions (drawing in principle)

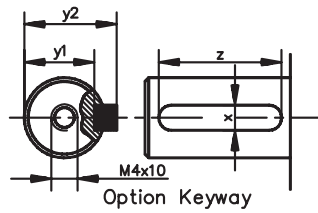
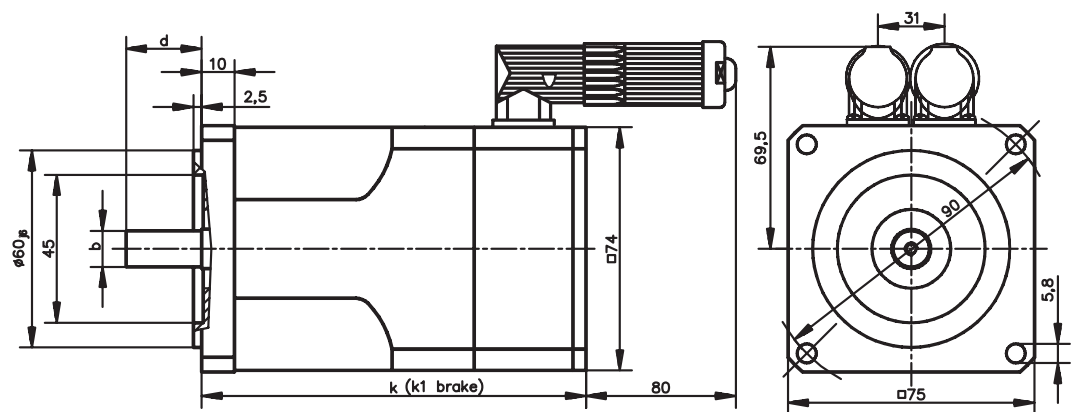

TYP	Resolver		Encoder		d	b	x	y1	y2	z
	k	k1	k	k1						
DBL3N00065	116	149	172	205	23	$\phi 11_{k6}$	4	8.5	12.5	16
DBL3H00065	116	149	172	205	23	$\phi 11_{k6}$	4	8.5	12.5	16
DBL3N00130	134	167	190	223	23	$\phi 11_{k6}$	4	8.5	12.5	16
DBL3H00130	134	167	190	223	23	$\phi 11_{k6}$	4	8.5	12.5	16
DBL3M00190	152	185	208	241	23	$\phi 11_{k6}$	4	8.5	12.5	16
DBL3H00250	170	203	226	259	30	$\phi 14_{k6}$	5	11	16	22
DBL3N00300	188	221	244	277	30	$\phi 14_{k6}$	5	11	16	22

Pin assignment

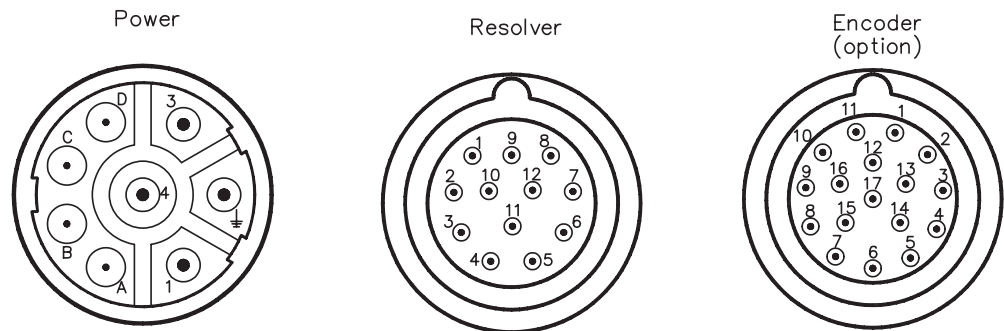

Power connector		Resolver connector		Encoder connector (Option)	
Pin	Connection	Pin	Connection	Pin	Connection
1	U2	1	n.c.	1	B- (Cosine)
\perp	PE	2	Thermostat	2	0 V (power supply)
3	W2	3	+ Cosine	3	A- (Sine)
4	V2	4	- Sine	4	U _P (power supply)
		5	+ Reference	5	DATA
A	Brake + (Option)	6	Thermostat	6	n.c.
B	Brake - (Option)	7	- Cosine	7	Thermostat
C	2nd Thermostat (Option)	8	+ Sine	8	CLOCK
D	2nd Thermostat (Option)	9	- Reference	9	B+ (Cosine)
		10	n.c.	10	0 V (Sense)
		11	n.c.	11	A+ (Sine)
		12	n.c.	12	U _P (Sense)
				13	DATA
				14	Thermostat
				15	CLOCK
				16	n.c.
				17	n.c.

Radial-/axial forces at the shaft end

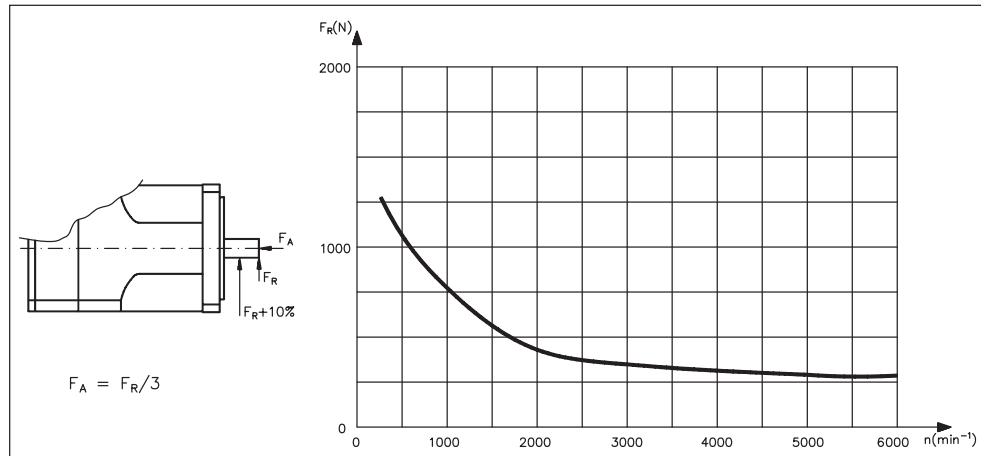

Performance curves

DBL3N00065

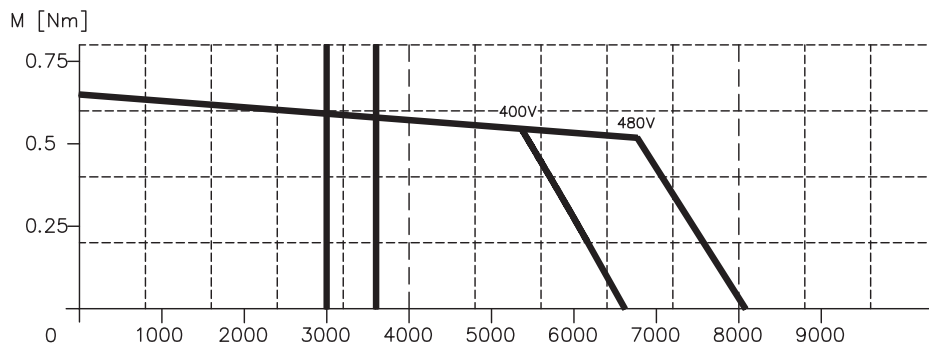

DBL3H00065

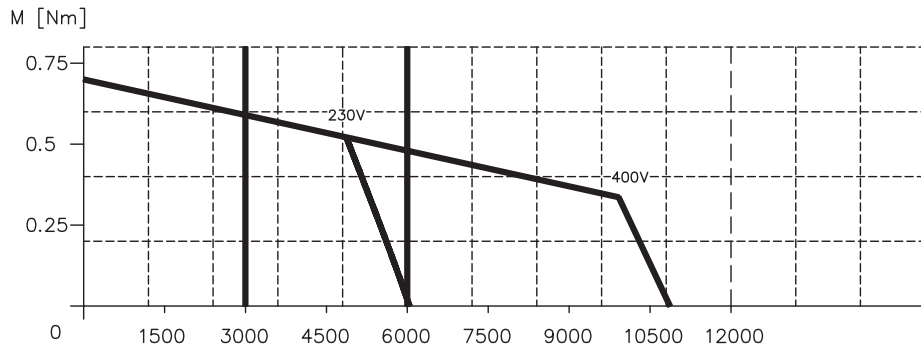

DBL3N00130

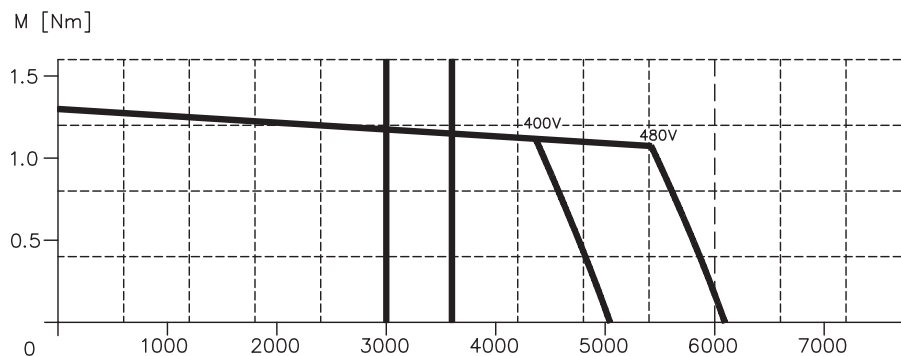

DBL3H00130

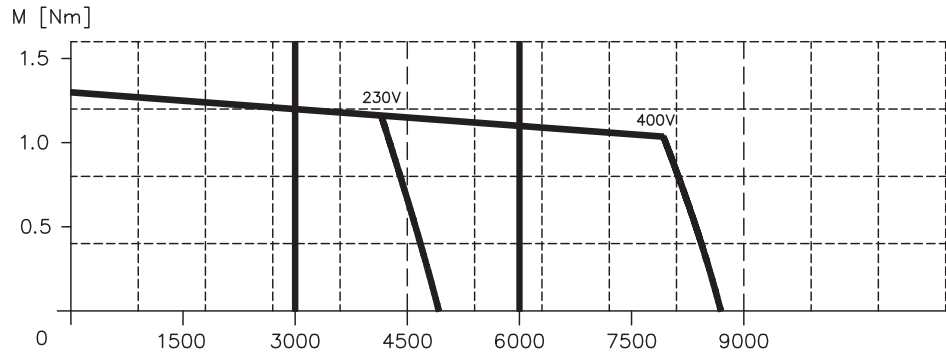

DBL3M00190

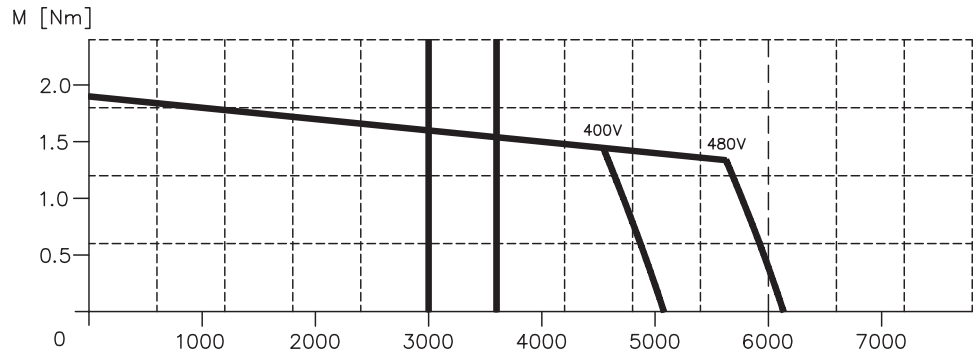

DBL3H00250

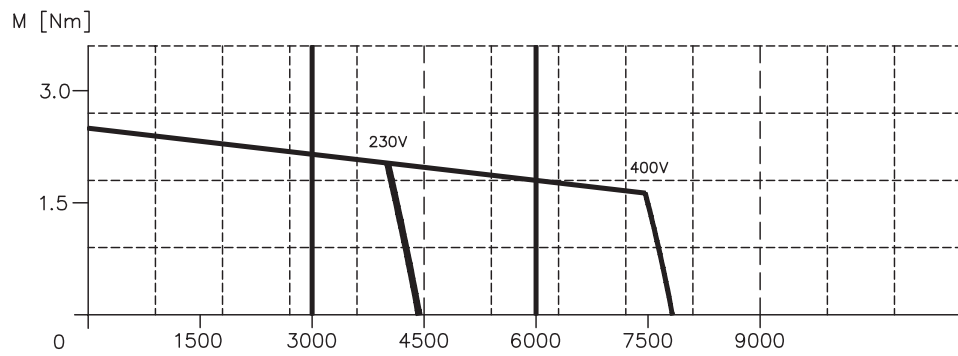

DBL3N00300

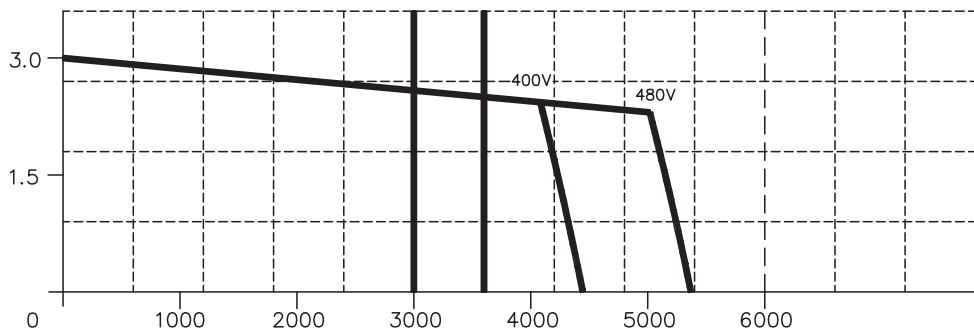

III.5

DBL4

Technical data

Data	Symbol [Unit]	DBL4 N00260	DBL4 H00260	DBL4 N00530	DBL4 H00530	DBL4 N00750	DBL4 H00750	DBL4 N00950	
Electrical data									
	Standstill torque	M_0 [Nm]	2,6	2,6	5,3	5,3	7,5	7,5	9,5
	Standstill current	I_{0rms} [A]	1,9	3,0	3,2	6,5	4,1	9,3	6,1
	Mains voltage	U_N [VAC]	230-480						
$U_N = 230V$	Rated speed	n_n [min ⁻¹]	—	3000	—	3000	—	3000	—
	Rated torque	M_n [Nm]	—	2,3	—	4,6	—	6,4	—
	Rated current	I_n [A]	—	2,8	—	6,0	—	8,4	—
	Rated power	P_n [kW]	—	0,72	—	1,45	—	2,01	—
$U_N = 400V$	Rated speed	n_n [min ⁻¹]	3000	—	3000	—	3000	—	3000
	Rated torque	M_n [Nm]	2,3	—	4,6	—	6,5	—	8
	Rated current	I_n [A]	1,76	—	2,77	—	3,7	—	5,6
	Rated power	P_n [kW]	0,72	—	1,45	—	2,04	—	2,51
$U_N = 480V$	Rated speed	n_n [min ⁻¹]	3600	—	3600	—	3600	—	3600
	Rated torque	M_n [Nm]	2,2	—	4,4	—	6,25	—	7,8
	Rated current	I_n [A]	1,62	—	2,68	—	3,38	—	5,03
	Rated power	P_n [kW]	0,83	—	1,66	—	2,36	—	2,94
	Peak current	I_{0max} [A]	8,6	13	15	30	19	42,6	27,5
	Torque constant	K_{Trms} [Nm/A]	1,36	0,86	1,65	0,81	1,85	0,81	1,55
	Voltage constant	$K_{E rms}$ [mV/min]	82	52	100	49	112	49	94
	Winding resistance Ph-Ph	R_{20} [Ω]	9,5	3,8	6,14	1,65	3,8	0,86	1,61
	Winding inductance Ph-Ph	L [mH]	40	15	30	9,3	22,6	5,3	10
Mechanical data									
	Rotor moment of inertia	J [kgcm ²]	2,1		2,8		4,3		6,5
	Static friction torque	M_R [Nm]	0,10		0,12		0,15		0,20
	Thermal time constant	t_{TH} [min]	60		60		66	70	70
	Weight standard	G [kg]	4,5		5,7		7,6		8,7
	Radial load permitted at shaft end @ 3000 min ⁻¹	F_R [N]	580						
	Axial load permitted at shaft end @ 3000 min ⁻¹	F_A [N]	180						
	Motor number		00301R	00285R	00253R	00284R	00254R	00609R	00470R

Brake data

Data	Symbol [Unit]	Value
Holding torque	M_{BR} [Nm]	5
Operating voltage	U_{BR} [VDC]	24 +15 / -0 %
electrical power	P_{BR} [W]	16
Moment of inertia	J_{BR} [kgcm ²]	1,06
Release delay time	t_{BRH} [ms]	10-30
Application delay time	t_{BRL} [ms]	5-15
Weight of the brake	G_{BR} [kg]	0,75

Connections and leads

Data	DBL4 N00260	DBL4 H00260	DBL4 N00530	DBL4 H00530	DBL4 N00750	DBL4 H00750	DBL4 N00950
Power connection	4 + 4 poles, round, angular						
Motor cable, shielded	4 x 1,5						
Motor cable with control leads, shielded	4 x 1 + 2 x 0,75						
Resolver connection	12 poles, round, angular						
Resolver cable, shielded	4 x 2 x 0,25mm ²						
Encoder connection (Option)	17 poles, round, angular						
Encoder cable, shielded	7 x 2 x 0,25mm ²						

Dimensions (drawing in principle)

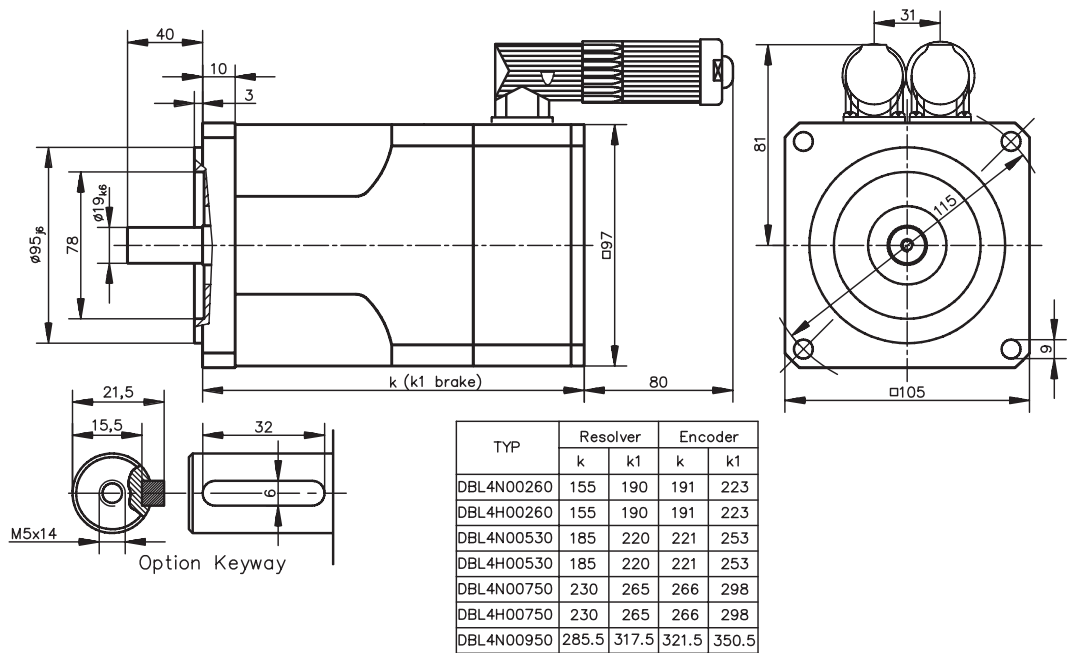

Pin assignment

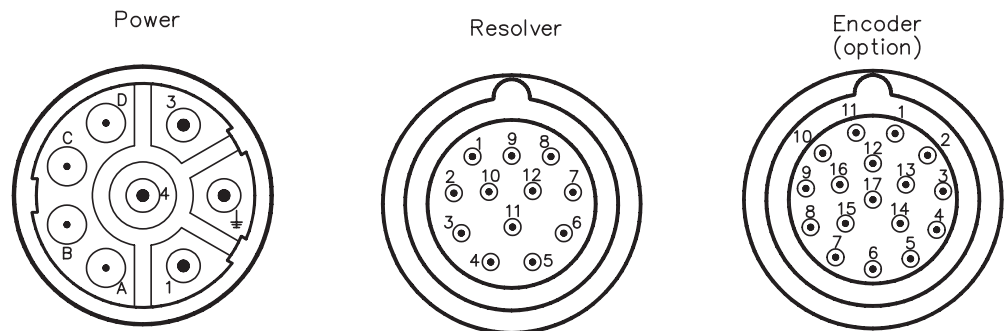

Power connector		Resolver connector		Encoder connector (Option)	
Pin	Connection	Pin	Connection	Pin	Connection
1	U2	1	n.c.	1	B- (Cosine)
⏏	PE	2	Thermostat	2	0 V (power supply)
3	W2	3	+ Cosine	3	A- (Sine)
4	V2	4	- Sine	4	U _P (power supply)
		5	+ Reference	5	DATA
A	Brake + (Option)	6	Thermostat	6	n.c.
B	Brake - (Option)	7	- Cosine	7	Thermostat
C	2nd Thermostat (Option)	8	+ Sine	8	CLOCK
D	2nd Thermostat (Option)	9	- Reference	9	B+ (Cosine)
		10	n.c.	10	0 V (Sense)
		11	n.c.	11	A+ (Sine)
		12	n.c.	12	U _P (Sense)
				13	DATA
				14	Thermostat
				15	CLOCK
				16	n.c.
				17	n.c.

Radial-/axial forces at the shaft end

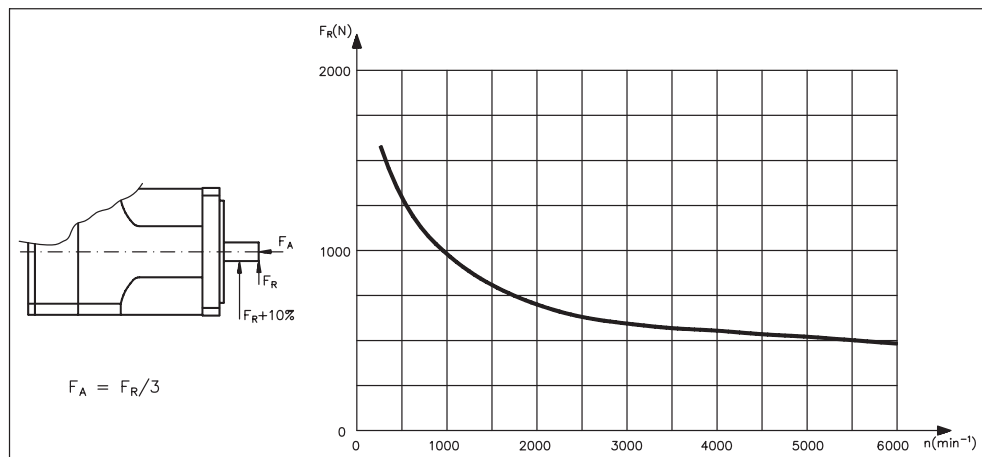

Performance curves

DBL4N00260

M [Nm]

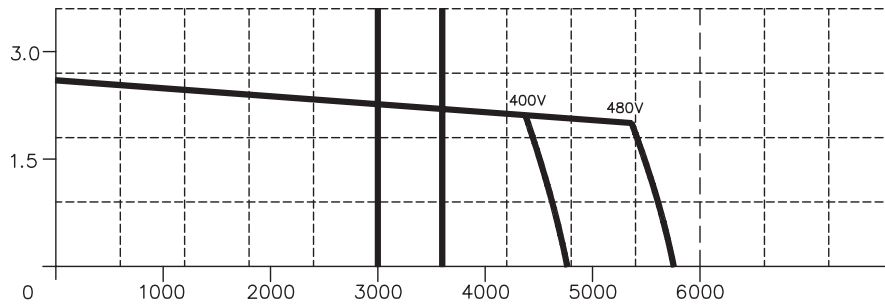

DBL4H00260

M [Nm]

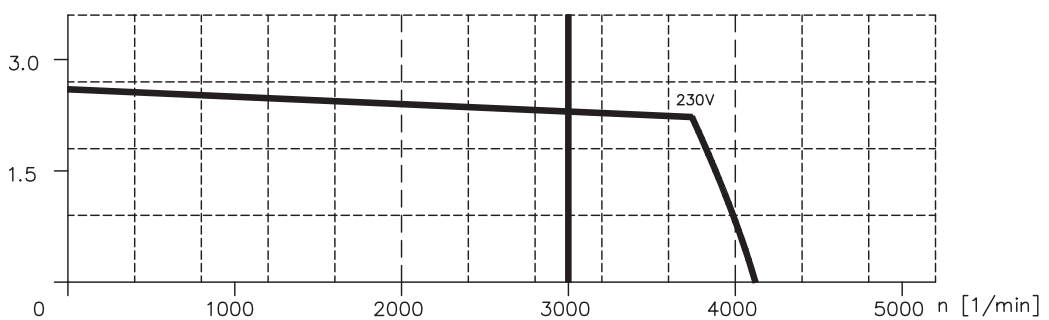

DBL4N00530

M [Nm]

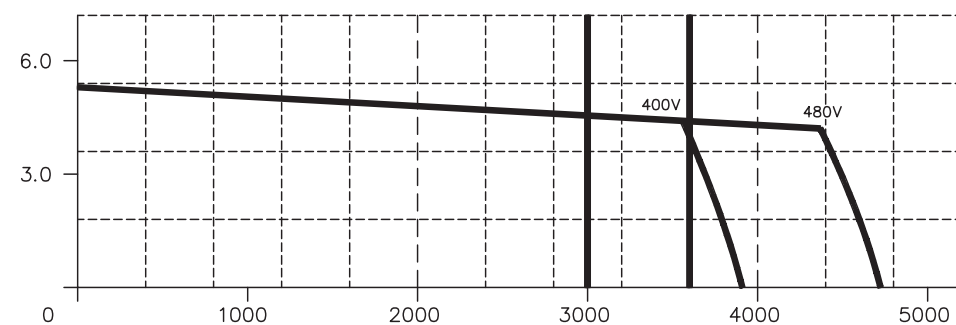

DBL4H00530

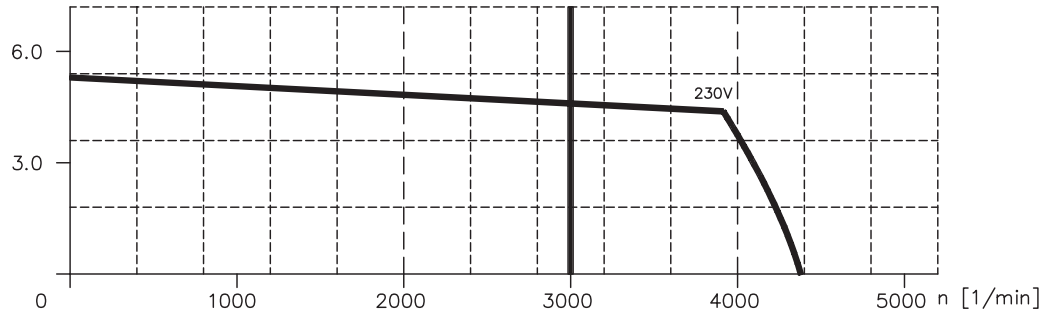

DBL4N00750

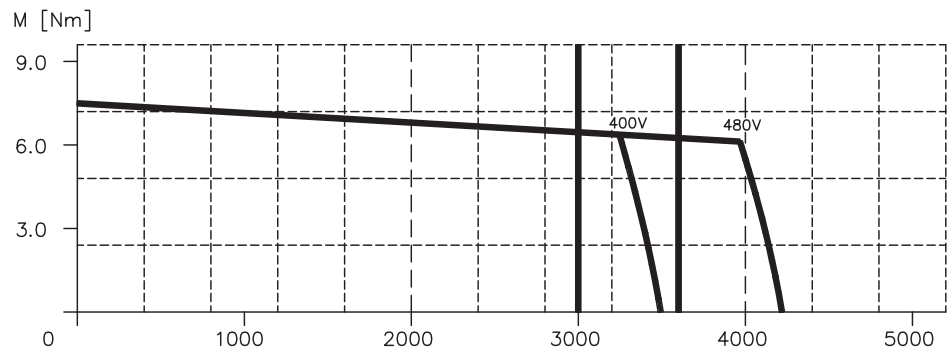

DBL4H00750

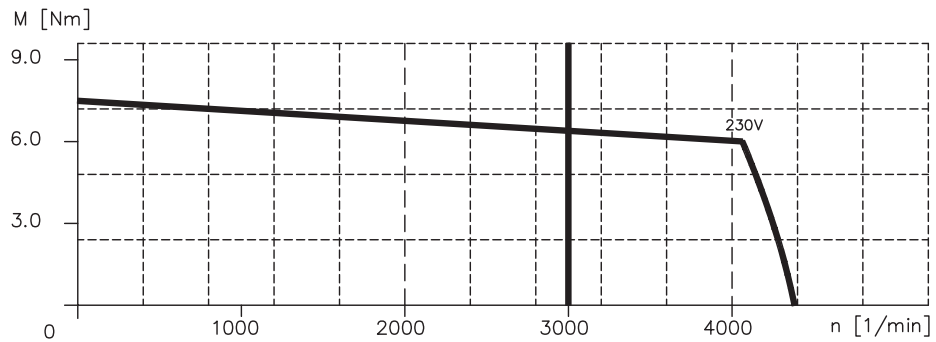

DBL4N00950

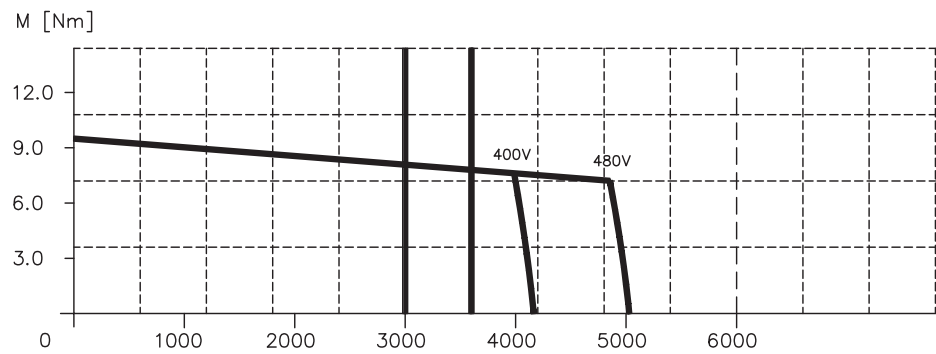

III.6

DBL5

Technical data

Data	Symbol [Unit]	DBL5 N01050	DBL5 H01050	DBL5 N01350	DBL5 H01350	DBL5 N01700	DBL5 H01700	DBL5 N02200
Electrical data								
Standstill torque	M_0 [Nm]	10,5	10,5	13,5	13,5	17	17	22
Standstill current	I_{orms} [A]	6,5	14,1	8,7	18,6	10,4	20,0	13,7
Mains voltage	U_N [VAC]	230-480						
$U_N = 230V$	Rated speed	n_n [min ⁻¹]	—	3000	—	3000	—	3000
	Rated torque	M_n [Nm]	—	8,5	—	10,7	—	14
	Rated current	I_n [A]	—	13	—	15,7	—	17,3
	Rated power	P_n [kW]	—	2,67	—	3,36	—	4,40
$U_N = 400V$	Rated speed	n_n [min ⁻¹]	3000	—	3000	—	3000	—
	Rated torque	M_n [Nm]	8,5	—	10,7	—	14	—
	Rated current	I_n [A]	5,7	—	7,3	—	9,1	—
	Rated power	P_n [kW]	2,67	—	3,36	—	4,40	—
$U_N = 480V$	Rated speed	n_n [min ⁻¹]	3600	—	3600	—	3600	—
	Rated torque	M_n [Nm]	8	—	10	—	13,4	—
	Rated current	I_n [A]	5	—	6,45	—	8,17	—
	Rated power	P_n [kW]	3,02	—	3,77	—	5,05	—
Peak current	I_{0max} [A]	30	71	40	85	48	91	63
Torque constant	K_{Trms} [Nm/A]	1,6	0,74	1,55	0,73	1,64	0,86	1,6
Voltage constant	K_{Erms} [mV/min]	97	45	94	44	99	52	97
Winding resistance Ph-Ph	R_{20} [Ω]	2,25	0,52	1,71	0,38	1,25	0,36	0,94
Winding inductance Ph-Ph	L [mH]	19,8	4,5	16,5	3,1	12,6	3,3	9
Mechanical data								
Rotor moment of inertia	J [kgcm ²]	8,1	—	9,1	—	11,3	—	13,1
Static friction torque	M_R [Nm]	0,25	—	0,30	—	0,30	—	0,40
Thermal time constant	t_{TH} [min]	50	—	55	—	60	—	75
Weight standard	G [kg]	9,8	—	11,2	—	14	—	17
Radial load permitted at shaft end @ 3000 min ⁻¹	F_R [N]	640						
Axial load permitted at shaft end @ 3000 min ⁻¹	F_A [N]	200						
Motor number		00666R	00562R	00576R	00633R	00665R	00661R	00620R

Brake data

Data	Symbol [Unit]	Value
Holding torque	M_{BR} [Nm]	12
Operating voltage	U_{BR} [VDC]	24 +15/ -0 %
electrical power	P_{BR} [W]	18
Moment of inertia	J_{BR} [kgcm ²]	3,6
Release delay time	t_{BRH} [ms]	30-60
Application delay time	t_{BRL} [ms]	10-20
Weight of the brake	G_{BR} [kg]	1,5

Connections and leads

Data	DBL5 N01050	DBL5 H01050	DBL5 N01350	DBL5 H01350	DBL5 N01700	DBL5 H01700	DBL5 N02200
Power connection	4 + 4 poles, round, angular						
Motor cable, shielded	4 x 1,5	4 x 2,5	4 x 1,5	4 x 2,5	4 x 1,5	4 x 2,5	4 x 2,5
Motor cable with control leads, shielded	4 x 1,5 + 2 x 0,75	4 x 2,5 + 2 x 1	4 x 1,5 + 2 x 0,75	4 x 2,5 + 2 x 1	4 x 1,5 + 2 x 0,75	4 x 2,5 + 2 x 1	4 x 2,5 + 2 x 1
Resolver connection	12 poles, round, angular						
Resolver cable, shielded	4 x 2 x 0,25mm ²						
Encoder connection (Option)	17 poles, round, angular						
Encoder cable, shielded	7 x 2 x 0,25mm ²						

Dimensions (drawing in principle)

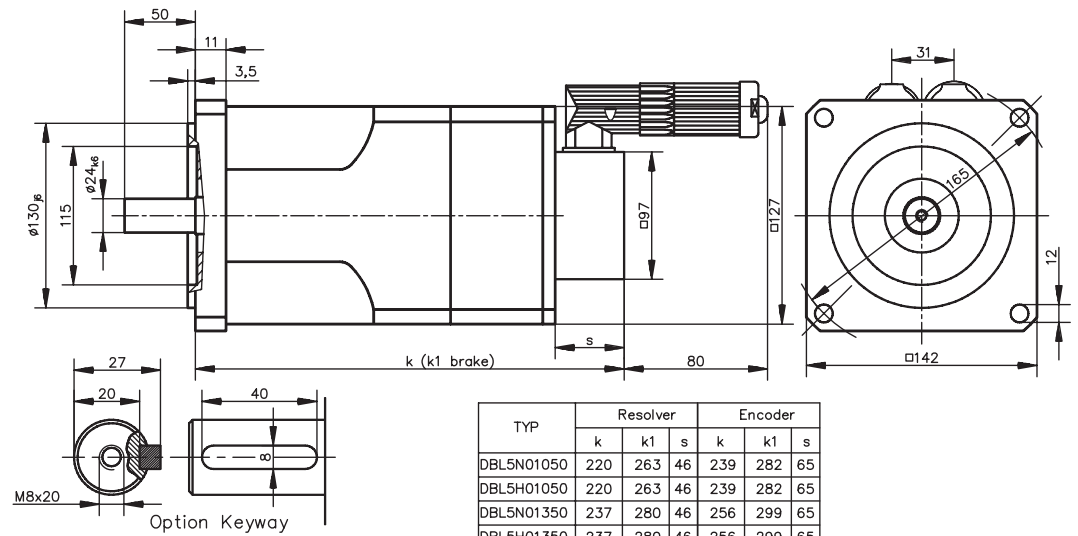

Pin assignment

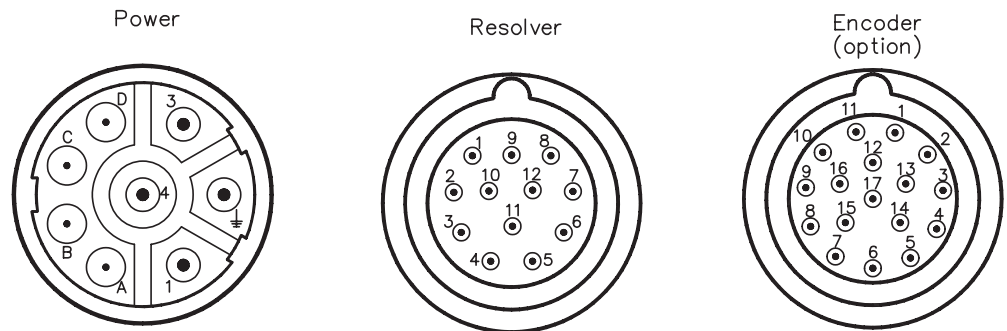

Power connector		Resolver connector		Encoder connector (Option)	
Pin	Connection	Pin	Connection	Pin	Connection
1	U2	1	n.c.	1	B- (Cosine)
⏏	PE	2	Thermostat	2	0 V (power supply)
3	W2	3	+ Cosine	3	A- (Sine)
4	V2	4	- Sine	4	U _P (power supply)
		5	+ Reference	5	DATA
A	Brake + (Option)	6	Thermostat	6	n.c.
B	Brake - (Option)	7	- Cosine	7	Thermostat
C	2nd Thermostat (Option)	8	+ Sine	8	CLOCK
D	2nd Thermostat (Option)	9	- Reference	9	B+ (Cosine)
		10	n.c.	10	0 V (Sense)
		11	n.c.	11	A+ (Sine)
		12	n.c.	12	U _P (Sense)
				13	DATA
				14	Thermostat
				15	CLOCK
				16	n.c.
				17	n.c.

Radial-/axial forces at the shaft end

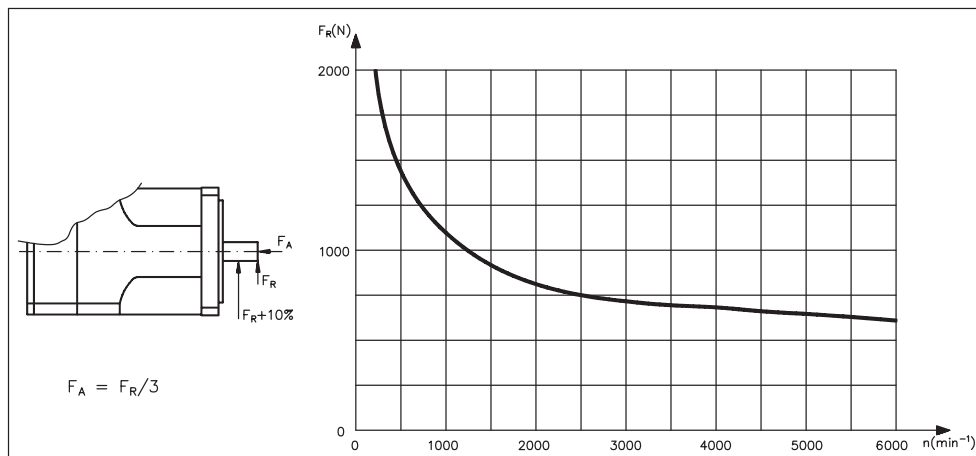

Performance curves

DBL5N01050

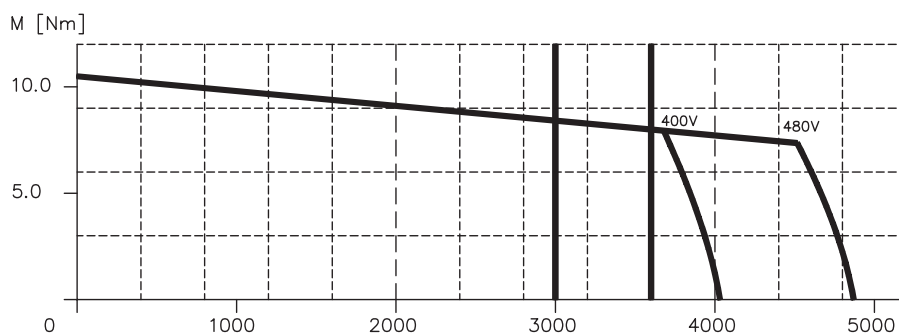

DBL5H01050

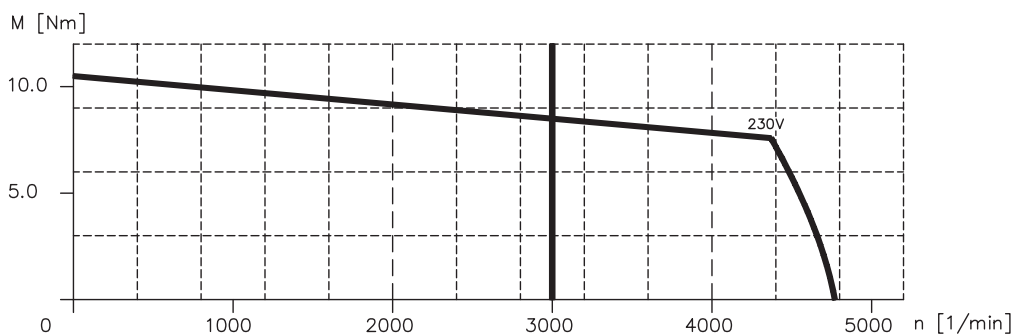

DBL5N01350

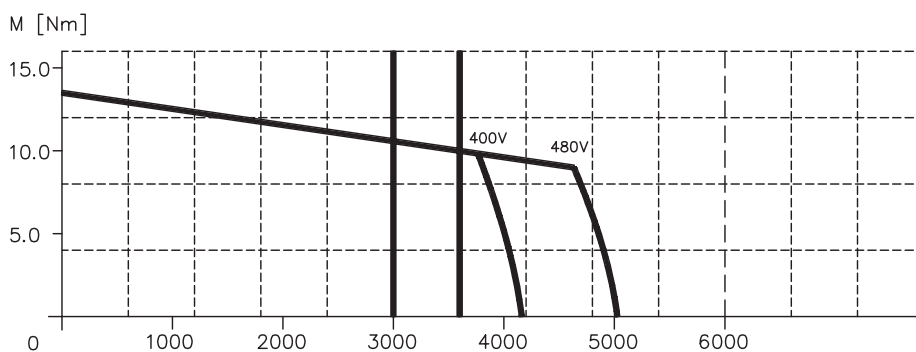

DBL5H01350

M [Nm]

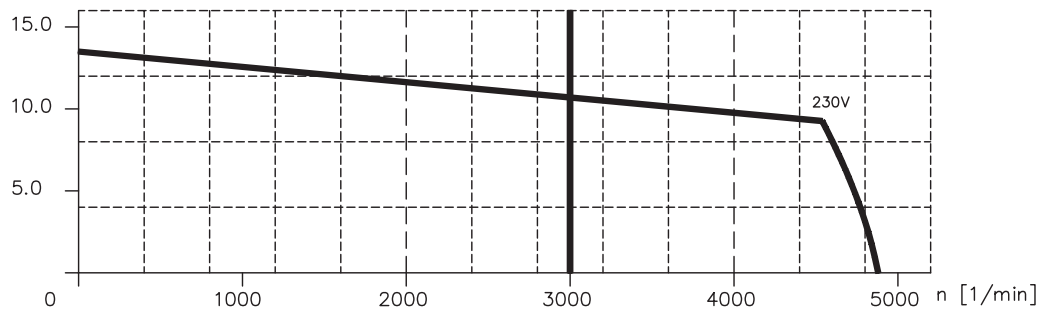

DBL5N01700

M [Nm]

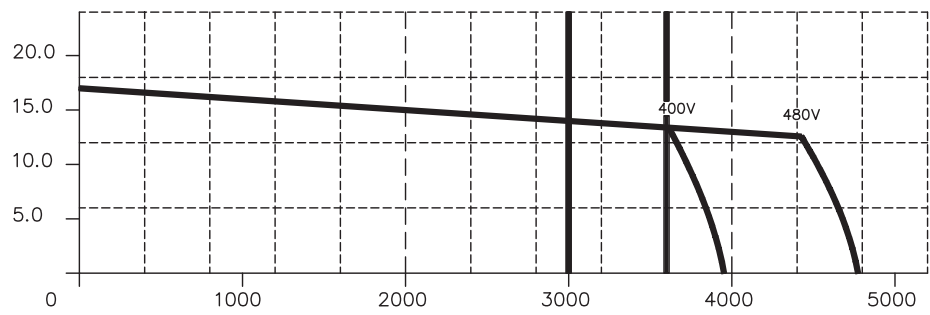

DBL5H01700

M [Nm]

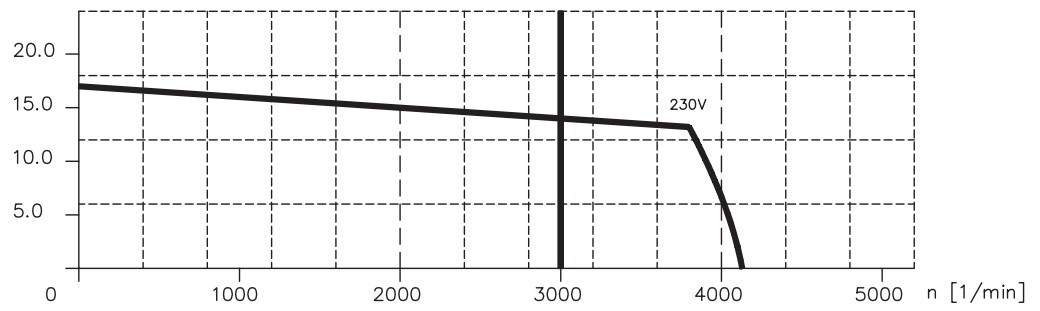

DBL5N02200

M [Nm]

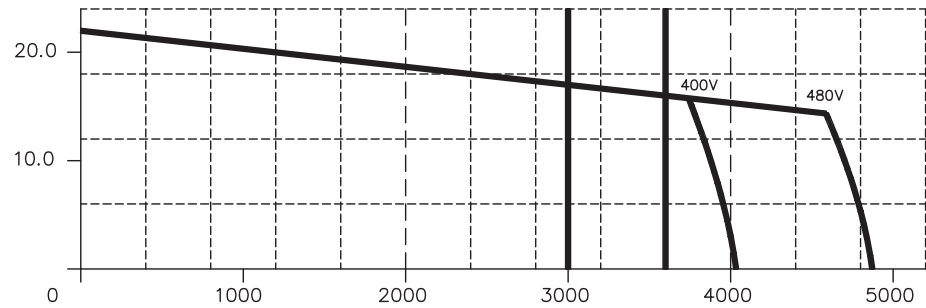

III.7

DBL6

Technical data

Data		Symbol [Unit]	DBL6 N02200	DBL6 N02900
Electrical data				
	Standstill torque	M_0 [Nm]	22	29
	Standstill current	I_{0rms} [A]	15,1	17,5
	Mains voltage	U_N [VAC]	230-480	
$U_N = 230V$	Rated speed	n_n [min ⁻¹]	—	—
	Rated torque	M_n [Nm]	—	—
	Rated current	I_n [A]	—	—
	Rated power	P_n [kW]	—	—
$U_N = 400V$	Rated speed	n_n [min⁻¹]	3000	3000
	Rated torque	M_n [Nm]	16	20
	Rated current	I_n [A]	12	13,5
	Rated power	P_n [kW]	5,03	6,28
$U_N = 480V$	Rated speed	n_n [min ⁻¹]	3600	3600
	Rated torque	M_n [Nm]	14,8	18,4
	Rated current	I_n [A]	10,1	11,2
	Rated power	P_n [kW]	5,58	6,94
	Peak current	I_{0max} [A]	69,5	81
	Torque constant	K_{Trms} [Nm/A]	1,46	1,65
	Voltage constant	K_{Erms} [mV/min]	88	100
	Winding resistance Ph-Ph	R_{20} [Ω]	0,72	0,55
	Winding inductance Ph-Ph	L [mH]	8,5	6,5
Mechanical data				
	Rotor moment of inertia	J [kgcm ²]	25,1	38,2
	Static friction torque	M_R [Nm]	0,40	0,40
	Thermal time constant	t_{TH} [min]	60	70
	Weight standard	G [kg]	21,5	27
	Radial load permitted at shaft end @ 3000 min ⁻¹	F_R [N]	680	
	Axial load permitted at shaft end @ 3000 min ⁻¹	F_A [N]	230	
	Motor number		00332R	00407R

Brake data

Data	Symbol [Unit]	Value
Holding torque	M_{BR} [Nm]	20
Operating voltage	U_{BR} [VDC]	24 +15 / -0 %
electrical power	P_{BR} [W]	22
Moment of inertia	J_{BR} [kgcm ²]	9,5
Release delay time	t_{BRH} [ms]	20-60
Application delay time	t_{BRL} [ms]	10-35
Weight of the brake	G_{BR} [kg]	2,75

Connections and leads

Data	DBL6 N02200	DBL6 N02900
Power connection	4 + 4 poles, round, angular	
Motor cable, shielded	4 x 2,5	
Motor cable with control leads, shielded	4 x 2,5 + 2 x 1	
Resolver connection	12 poles, round, angular	
Resolver cable, shielded	4 x 2 x 0,25mm ²	
Encoder connection (Option)	17 poles, round, angular	
Encoder cable, shielded	7 x 2 x 0,25mm ²	

Dimensions (drawing in principle)

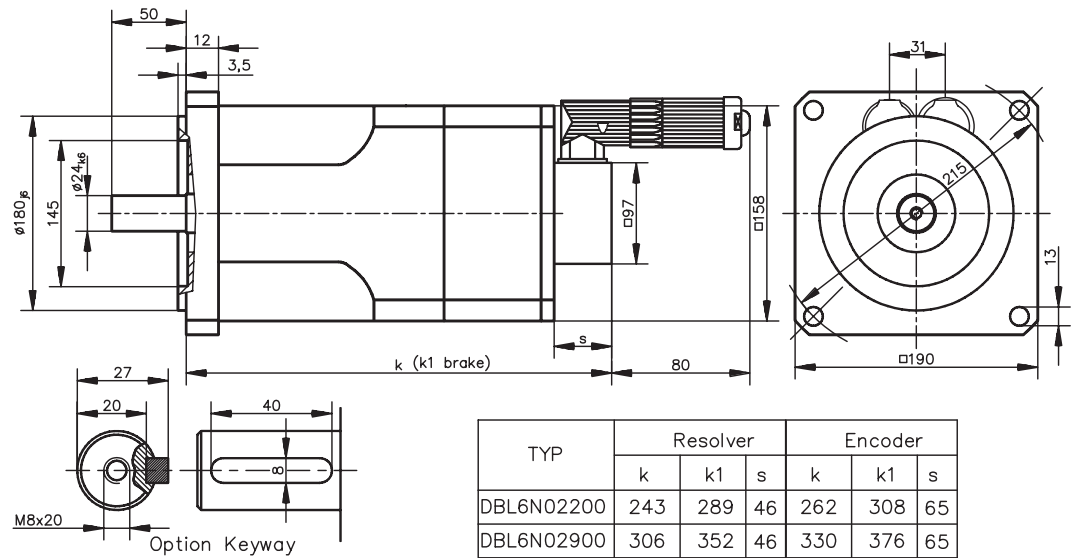

Pin assignment

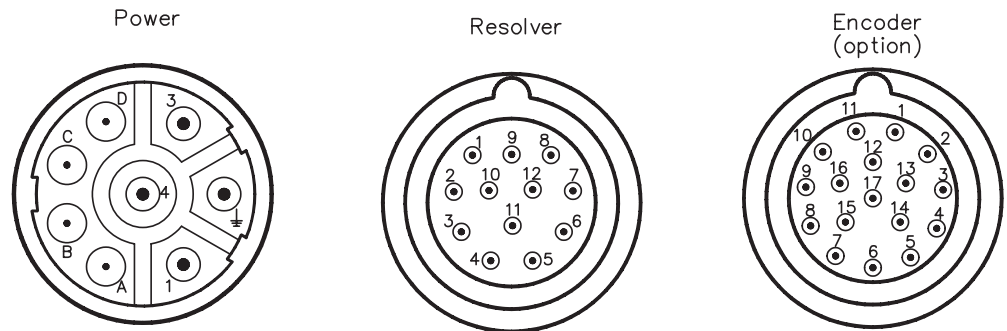

Power connector		Resolver connector		Encoder connector (Option)	
Pin	Connection	Pin	Connection	Pin	Connection
1	U2	1	n.c.	1	B- (Cosine)
⏏	PE	2	Thermostat	2	0 V (power supply)
3	W2	3	+ Cosine	3	A- (Sine)
4	V2	4	- Sine	4	U _P (power supply)
		5	+ Reference	5	DATA
A	Brake + (Option)	6	Thermostat	6	n.c.
B	Brake - (Option)	7	- Cosine	7	Thermostat
C	2nd Thermostat (Option)	8	+ Sine	8	CLOCK
D	2nd Thermostat (Option)	9	- Reference	9	B+ (Cosine)
		10	n.c.	10	0 V (Sense)
		11	n.c.	11	A+ (Sine)
		12	n.c.	12	U _P (Sense)
				13	DATA
				14	Thermostat
				15	CLOCK
				16	n.c.
				17	n.c.

Radial-/axial forces at the shaft end

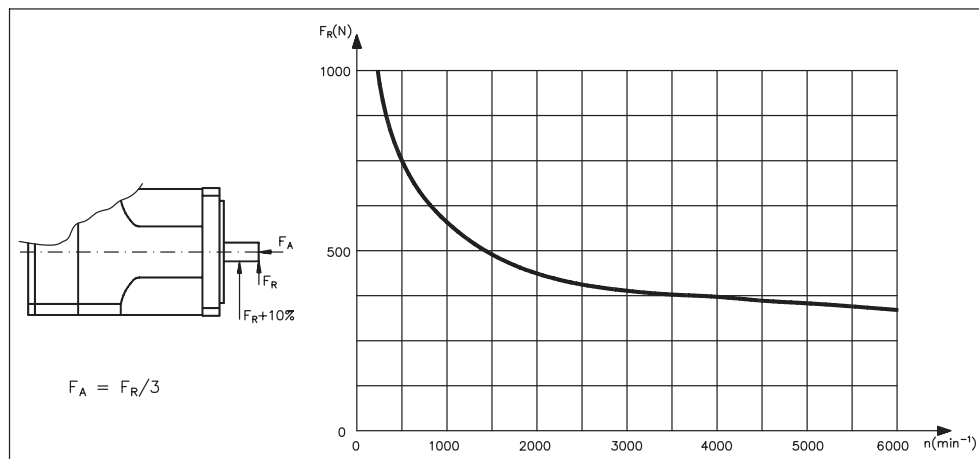

Performance curves

DBL6N02200

M [Nm]

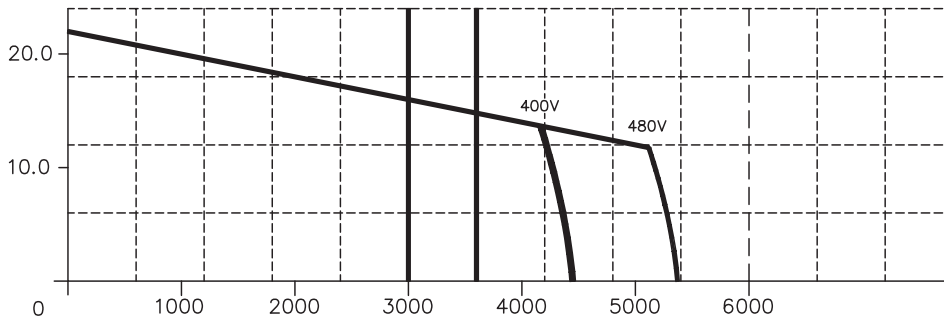

DBL6N02900

M [Nm]

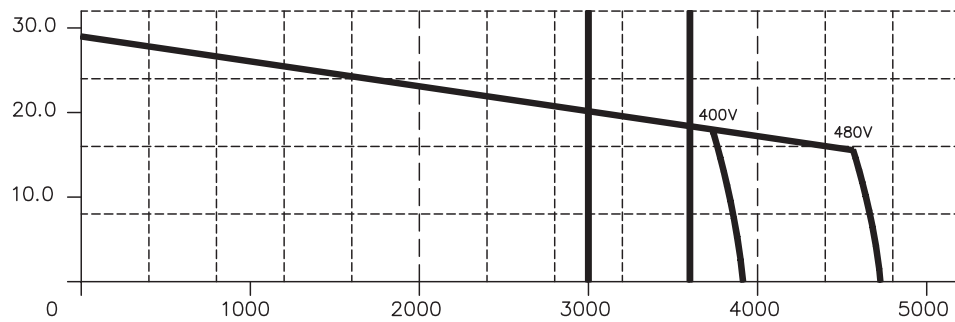

This page has been deliberately left blank.

III.8

DBL7

Technical data

Data		Symbol [Unit]	DBL7 N02600	DBL7 N03200	DBL7 N04000
Electrical data					
	Standstill torque	M_0 [Nm]	26	32	40
	Standstill current	I_{0rms} [A]	17,0	20,0	23,4
	Mains voltage	U_N [VAC]	230-480		
$U_N = 230V$	Rated speed	n_n [min ⁻¹]	—	—	—
	Rated torque	M_n [Nm]	—	—	—
	Rated current	I_n [A]	—	—	—
	Rated power	P_n [kW]	—	—	—
$U_N = 400V$	Rated speed	n_n [min⁻¹]	3000	3000	3000
	Rated torque	M_n [Nm]	20	23	26
	Rated current	I_n [A]	14,1	15,8	17
	Rated power	P_n [kW]	6,28	7,23	8,17
$U_N = 480V$	Rated speed	n_n [min ⁻¹]	3600	3600	3600
	Rated torque	M_n [Nm]	18,8	21	23,2
	Rated current	I_n [A]	12,3	13,1	13,6
	Rated power	P_n [kW]	7,09	7,92	8,75
	Peak current	I_{0max} [A]	76	89,8	94
	Torque constant	K_{Trms} [Nm/A]	1,53	1,6	1,71
	Voltage constant	K_{Erms} [mVmin]	92,5	97	103,5
	Winding resistance Ph-Ph	R_{20} [Ω]	0,46	0,36	0,3
	Winding inductance Ph-Ph	L [mH]	4,5	3,6	2,9
Mechanical data					
	Rotor moment of inertia	J [kgcm ²]	97,4	114,1	139,4
	Static friction torque	M_R [Nm]	0,40	0,50	0,60
	Thermal time constant	t_{TH} [min]	60	67	60
	Weight standard	G [kg]	28	32,5	40
	Radial load permitted at shaft end @ 3000 min ⁻¹	F_R [N]	780		
	Axial load permitted at shaft end @ 3000 min ⁻¹	F_A [N]	360		
	Motor number		00335R	00402R	00450R

Brake data

Data	Symbol [Unit]	Value
Holding torque	M_{BR} [Nm]	20
Operating voltage	U_{BR} [VDC]	24 +15 / -0 %
electrical power	P_{BR} [W]	22
Moment of inertia	J_{BR} [kgcm ²]	9,5
Release delay time	t_{BRH} [ms]	20-60
Application delay time	t_{BRL} [ms]	10-35
Weight of the brake	G_{BR} [kg]	3,3

Connections and leads

Data	DBL7 N02600	DBL7 N03200	DBL7 N04000
Power connection	Terminal box		
Motor cable, shielded	4 x 2,5		4 x 4
Motor cable with control leads, shielded	4 x 2,5 + 2 x 1		—
Control leads, shielded	4 x 1		
Resolver connection	12 poles, round		
Resolver cable, shielded	4 x 2 x 0,25mm ²		
Encoder connection (Option)	17 poles, round		
Encoder cable, shielded	7 x 2 x 0,25mm ²		

Dimensions (drawing in principle)

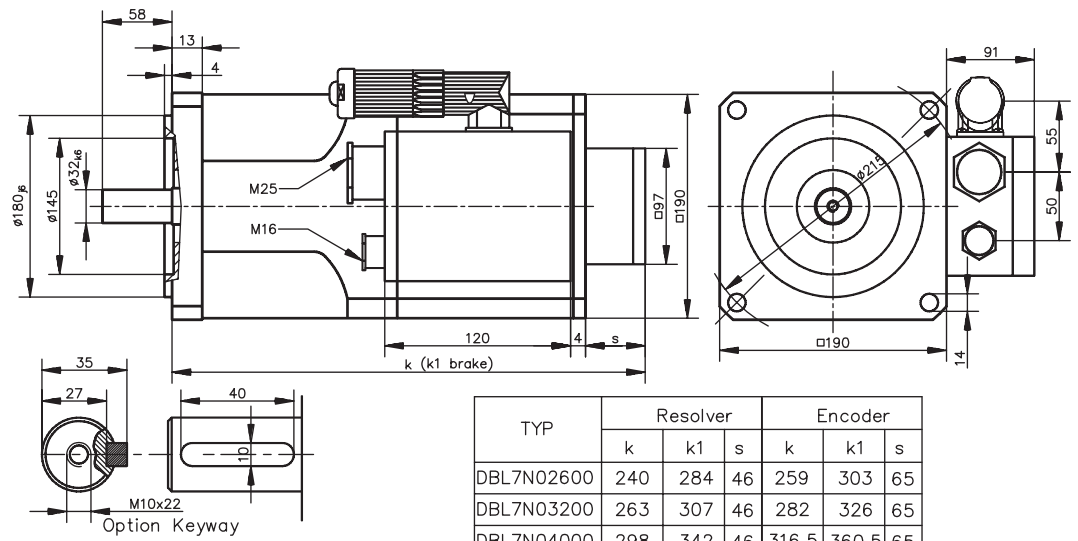

Pin assignment

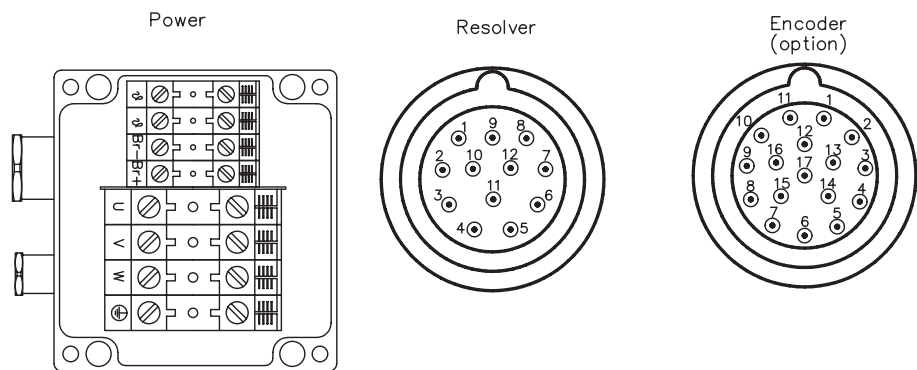

Terminal box		Resolver connector		Encoder connector (Option)	
Kl.	Connection	Pin	Connection	Pin	Connection
U	U2	1	n.c.	1	B- (Cosine)
\perp	PE	2	Thermostat	2	0 V (power supply)
V	V2	3	+ Cosine	3	A- (Sine)
W	W2	4	- Sine	4	U _P (power supply)
		5	+ Reference	5	DATA
(+)	Brake + (Option)	6	Thermostat	6	n.c.
(-)	Brake - (Option)	7	- Cosine	7	Thermostat
9	2nd Thermostat (Option)	8	+ Sine	8	CLOCK
9	2nd Thermostat (Option)	9	- Reference	9	B+ (Cosine)
		10	n.c.	10	0 V (Sense)
		11	n.c.	11	A+ (Sine)
		12	n.c.	12	U _P (Sense)
				13	DATA
				14	Thermostat
				15	CLOCK
				16	n.c.
				17	n.c.

Radial-/axial forces at the shaft end

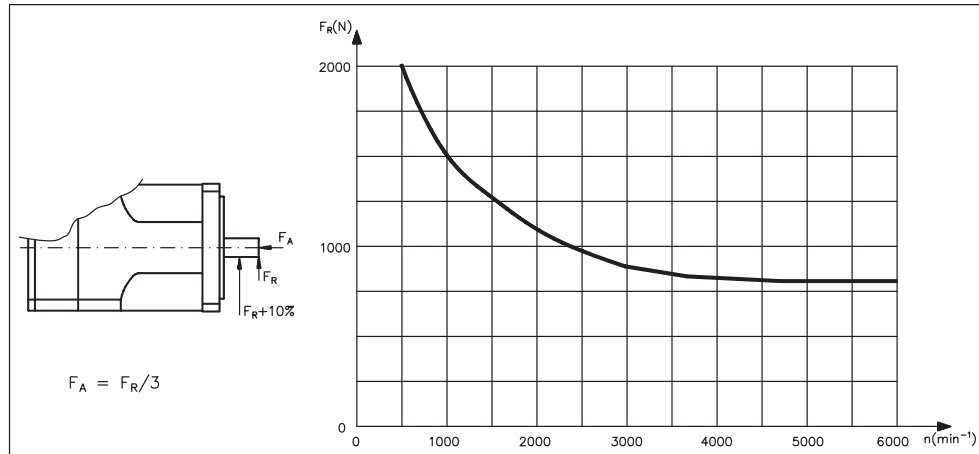

Performance curves

DBL7N02600

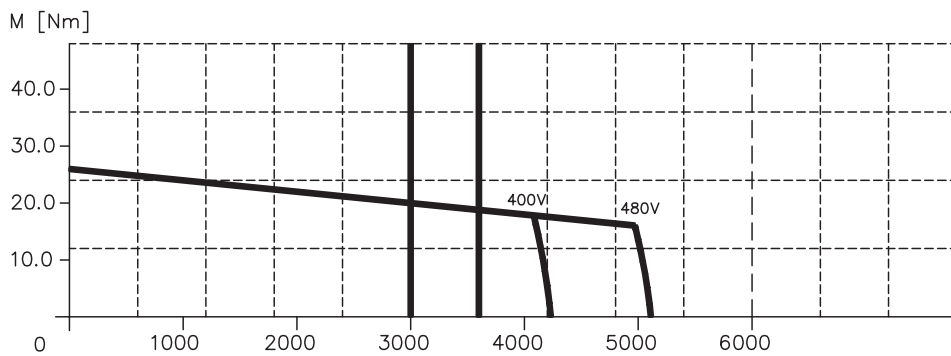

DBL7N03200

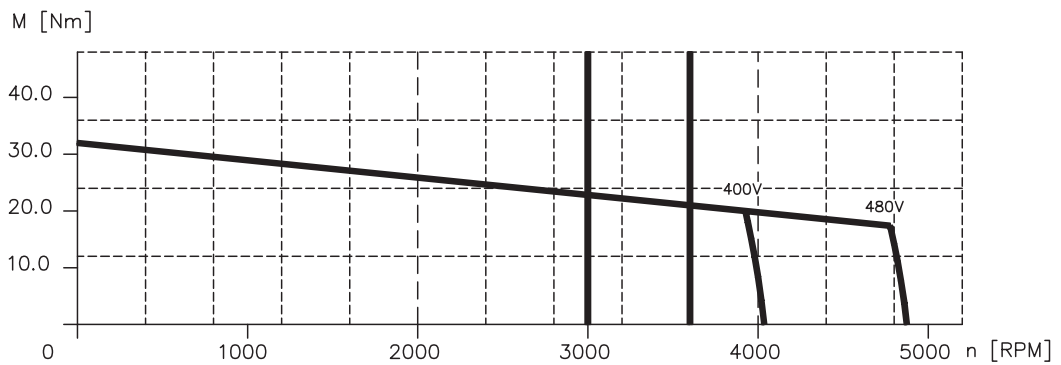

DBL7N04000

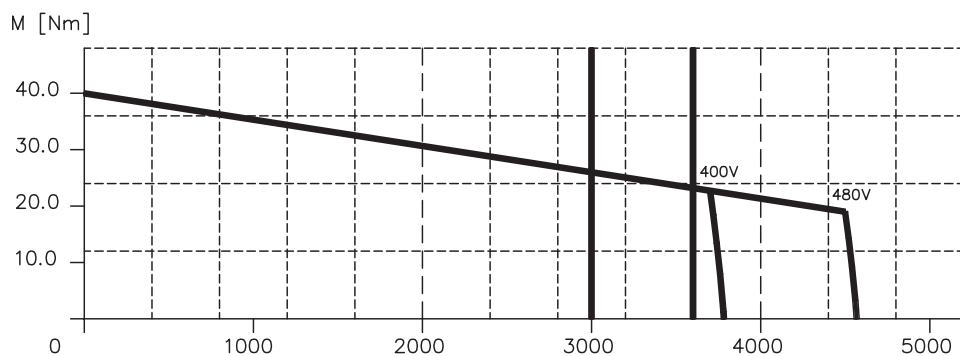

This page has been deliberately left blank.

III.9

DBL8

Technical data

Data		Symbol [Unit]	DBL8 N04000	DBL8 N06800	DBL8 L09300	DBL8 L11500
Electrical data						
	Standstill torque	M_0 [Nm]	40	68	93	115
	Standstill current	I_{0rms} [A]	23	37	34	43
	Mains voltage	U_N [VAC]	230-480			
$U_N = 230V$	Rated speed	n_n [min ⁻¹]	—	—	—	—
	Rated torque	M_n [Nm]	—	—	—	—
	Rated current	I_n [A]	—	—	—	—
	Rated power	P_n [kW]	—	—	—	—
$U_N = 400V$	Rated speed	n_n [min⁻¹]	3000	3000	2000	2000
	Rated torque	M_n [Nm]	32	50	70	85
	Rated current	I_n [A]	20	28,6	32	32,5
	Rated power	P_n [kW]	10,1	15,7	14,7	17,8
$U_N = 480V$	Rated speed	n_n [min ⁻¹]	3600	3600	—	—
	Rated torque	M_n [Nm]	30,4	45,6	—	—
	Rated current	I_n [A]	17,5	25	—	—
	Rated power	P_n [kW]	11,5	17,2	—	—
	Peak current	I_{0max} [A]	80	140	118	146
	Torque constant	K_{Trms} [Nm/A]	1,74	1,85	2,71	2,71
	Voltage constant	K_{Erms} [mV/min]	105	112	164	164
	Winding resistance Ph-Ph	R_{20} [Ω]	0,35	0,12	0,16	0,11
	Winding inductance Ph-Ph	L [mH]	7,5	3,4	4,4	3,9
Mechanical data						
	Rotor moment of inertia	J [kgcm ²]	71,1	113,6	153	190
	Static friction torque	M_R [Nm]	0,70	0,70	0,80	0,80
	Thermal time constant	t_{TH} [min]	65	65	79	90
	Weight standard	G [kg]	43	54	74	93
	Radial load permitted at shaft end @ 2000 min ⁻¹	F_R [N]	1800			
	Axial load permitted at shaft end @ 2000 min ⁻¹	F_A [N]	400			
	Motor number		00690R	00531R	00672R	00668R

Brake data

Data	Symbol [Unit]	Value
Holding torque	M_{BR} [Nm]	60
Operating voltage	U_{BR} [VDC]	24 +15 / -0 %
electrical power	P_{BR} [W]	36
Moment of inertia	J_{BR} [kgcm ²]	57,5
Release delay time	t_{BRH} [ms]	150
Application delay time	t_{BRL} [ms]	40
Weight of the brake	G_{BR} [kg]	5,4

Connections and leads

Data	DBL8 N04000	DBL8 N06800	DBL8 L09300	DBL8 L11500
Power connection	Terminal box			
Motor cable, shielded	4 x 4	4 x 10		
Control leads, shielded	4 x 1			
Resolver connection	12 poles, round			
Resolver cable, shielded	4 x 2 x 0,25mm ²			
Encoder connection (Option)	17 poles, round			
Encoder cable, shielded	7 x 2 x 0,25mm ²			

Dimensions (drawing in principle)

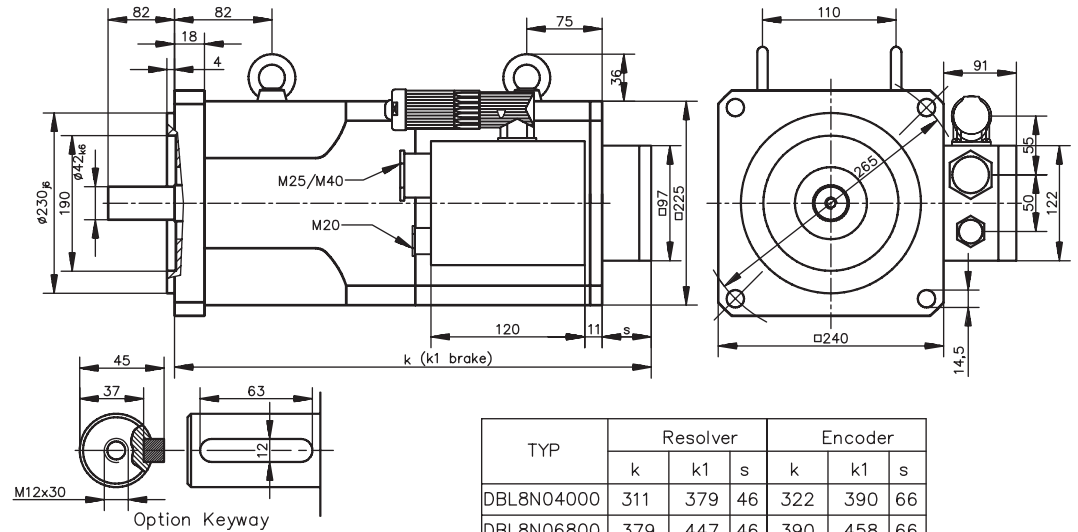

Pin assignment

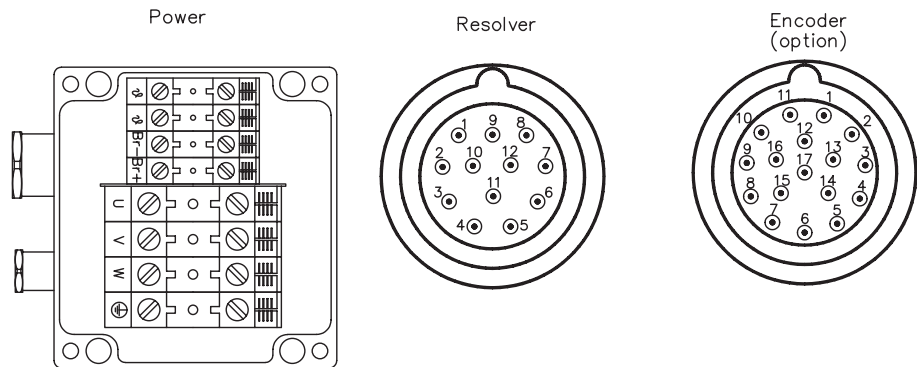

Terminal box		Resolver connector		Encoder connector (Option)	
Kl.	Connection	Pin	Connection	Pin	Connection
U	U2	1	n.c.	1	B- (Cosine)
\perp	PE	2	Thermostat	2	0 V (power supply)
V	V2	3	+ Cosine	3	A- (Sine)
W	W2	4	- Sine	4	U _P (power supply)
		5	+ Reference	5	DATA
(+)	Brake + (Option)	6	Thermostat	6	n.c.
(-)	Brake - (Option)	7	- Cosine	7	Thermostat
9	2nd Thermostat (Option)	8	+ Sine	8	CLOCK
9	2nd Thermostat (Option)	9	- Reference	9	B+ (Cosine)
		10	n.c.	10	0 V (Sense)
		11	n.c.	11	A+ (Sine)
		12	n.c.	12	U _P (Sense)
				13	DATA
				14	Thermostat
				15	CLOCK
				16	n.c.
				17	n.c.

Radial-/axial forces at the shaft end

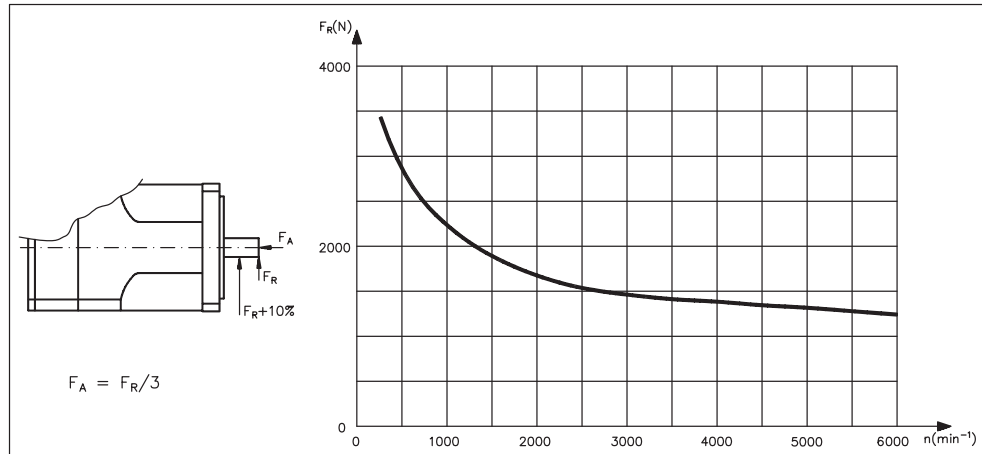

Performance curves

DBL8N04000

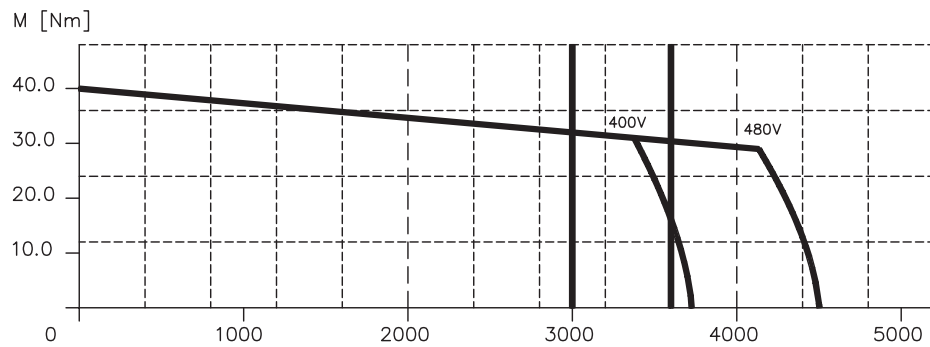

DBL8N06800

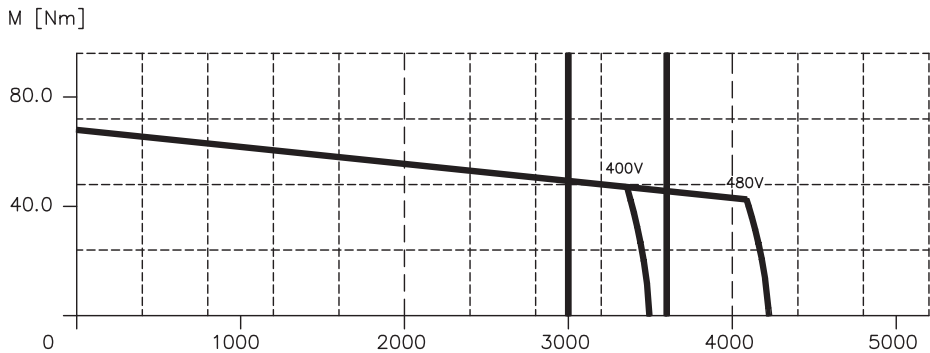

DBL8L09300

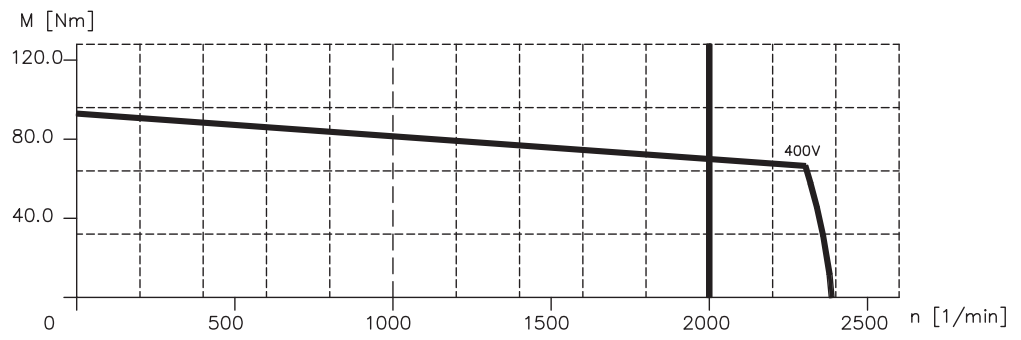

DBL8L11500

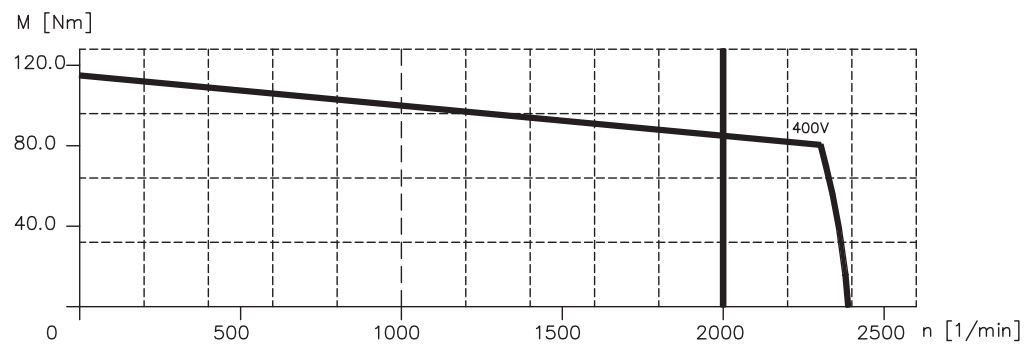

III.10

DBK4

Technical data

Data		Symbol [Unit]	DBK4 N00100	DBK4 H00100	DBK4 N00160	DBK4 H00160
Electrical data						
	Standstill torque	M_0 [Nm]	1	1	1,6	1,6
	Standstill current	I_{0rms} [A]	1,1	1,9	1,1	1,9
	Mains voltage	U_N [VAC]	230-480			
$U_N = 230V$	Rated speed	n_n [min ⁻¹]	—	3000	—	3000
	Rated torque	M_n [Nm]	—	0,9	—	1,4
	Rated current	I_n [A]	—	1,85	—	1,7
	Rated power	P_n [kW]	—	0,28	—	0,44
$U_N = 400V$	Rated speed	n_n [min⁻¹]	3000	—	3000	—
	Rated torque	M_n [Nm]	0,9	—	1,4	—
	Rated current	I_n [A]	1,06	—	1	—
	Rated power	P_n [kW]	0,28	—	0,44	—
$U_N = 480V$	Rated speed	n_n [min ⁻¹]	3600	—	3600	—
	Rated torque	M_n [Nm]	0,88	—	1,35	—
	Rated current	I_n [A]	0,95	—	0,91	—
	Rated power	P_n [kW]	0,33	—	0,5	—
	Peak current	I_{0max} [A]	5	8,7	4,9	7,1
	Torque constant	K_{Trms} [Nm/A]	0,93	0,53	1,49	0,84
	Voltage constant	K_{Erms} [mVmin]	56	32	90	51
	Winding resistance Ph-Ph	R_{20} [Ω]	38	13	25	7,6
	Winding inductance Ph-Ph	L [mH]	70	24	68	18
Mechanical data						
	Rotor moment of inertia	J [kgcm ²]	0,79		1,28	
	Static friction torque	M_R [Nm]	0,10		0,13	
	Thermal time constant	t_{TH} [min]	45		50	55
	Weight standard	G [kg]	3			
	Radial load permitted at shaft end @ 3000 min ⁻¹	F_R [N]	590			
	Axial load permitted at shaft end @ 3000 min ⁻¹	F_A [N]	180			
	Motor number		00259R	00017R	00441R	00347R

Brake data

Data	Symbol [Unit]	Value
Holding torque	M_{BR} [Nm]	2,5
Operating voltage	U_{BR} [VDC]	24 +15 / -0 %
electrical power	P_{BR} [W]	12
Moment of inertia	J_{BR} [kgcm ²]	0,38
Release delay time	t_{BRH} [ms]	10-15
Application delay time	t_{BRL} [ms]	10-15
Weight of the brake	G_{BR} [kg]	0,45

Connections and leads

Data	DBK4 N00100	DBK4 H00100	DBK4 N00160	DBK4 H00160
Power connection	4 + 4 poles, round, angular			
Motor cable, shielded	4 x 1			
Motor cable with control leads, shielded	4 x 1 + 2 x 0,75			
Resolver connection	12 poles, round, angular			
Resolver cable, shielded	4 x 2 x 0,25mm ²			
Encoder connection (Option)	17 poles, round, angular			
Encoder cable, shielded	7 x 2 x 0,25mm ²			

Dimensions (drawing in principle)

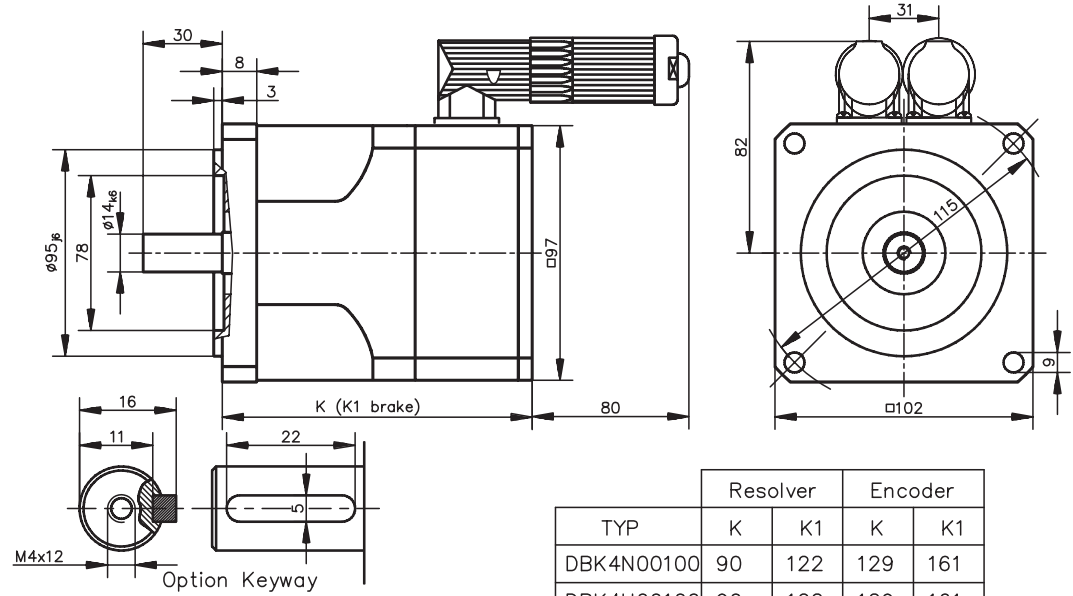

TYP	Resolver		Encoder	
	K	K1	K	K1
DBK4N00100	90	122	129	161
DBK4H00100	90	122	129	161
DBK4N00160	105	150	144	182
DBK4H00160	105	150	144	182

Pin assignment

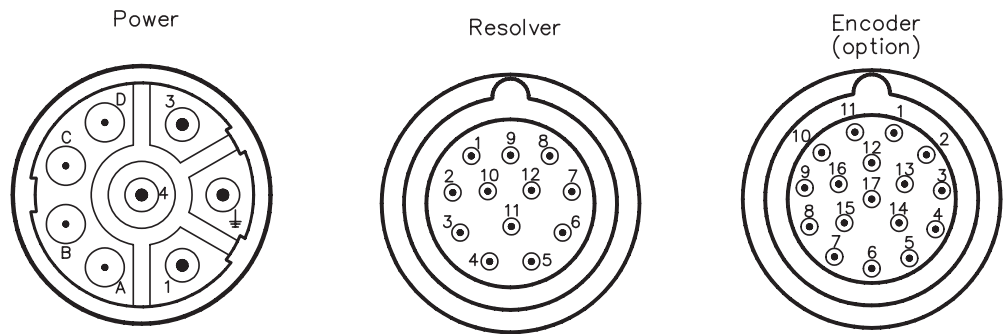

Power connector		Resolver connector		Encoder connector (Option)	
Pin	Connection	Pin	Connection	Pin	Connection
1	U2	1	n.c.	1	B- (Cosine)
\perp	PE	2	Thermostat	2	0 V (power supply)
3	W2	3	+ Cosine	3	A- (Sine)
4	V2	4	- Sine	4	U _P (power supply)
		5	+ Reference	5	DATA
A	Brake + (Option)	6	Thermostat	6	n.c.
B	Brake - (Option)	7	- Cosine	7	Thermostat
C	2nd Thermostat (Option)	8	+ Sine	8	CLOCK
D	2nd Thermostat (Option)	9	- Reference	9	B+ (Cosine)
		10	n.c.	10	0 V (Sense)
		11	n.c.	11	A+ (Sine)
		12	n.c.	12	U _P (Sense)
				13	DATA
				14	Thermostat
				15	CLOCK
				16	n.c.
				17	n.c.

Radial-/axial forces at the shaft end

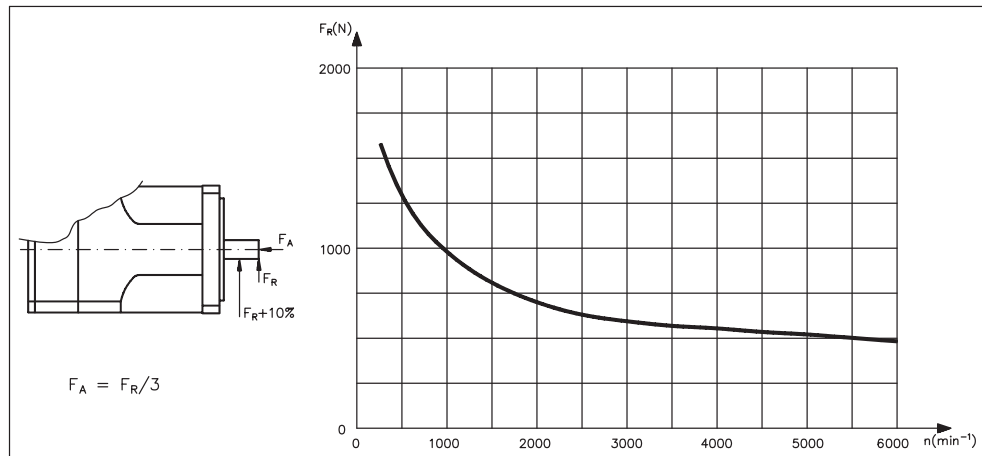

Performance curves

DBK4N00100

M [Nm]

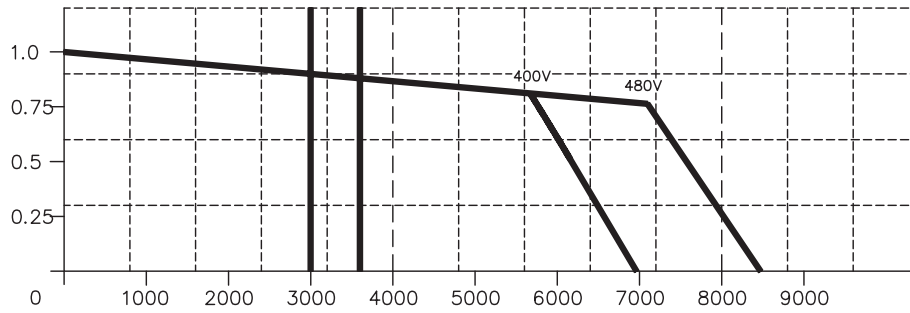

DBK4H00100

M [Nm]

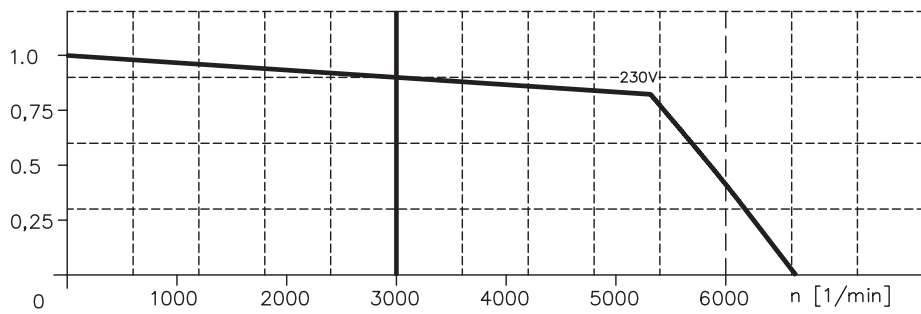

DBK4N00160

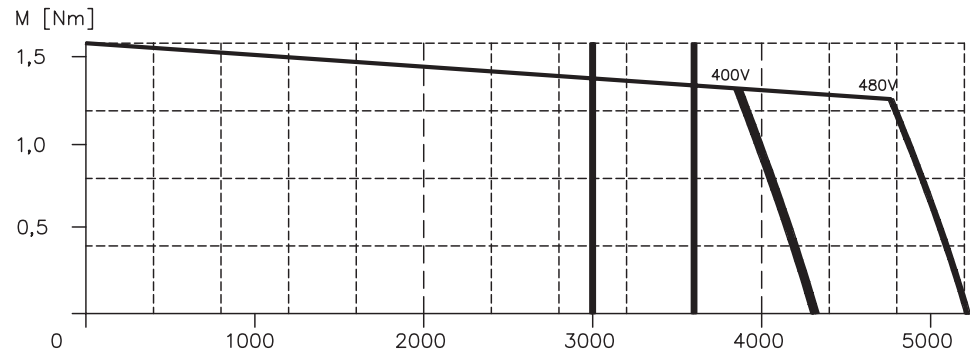

DBK4H00160

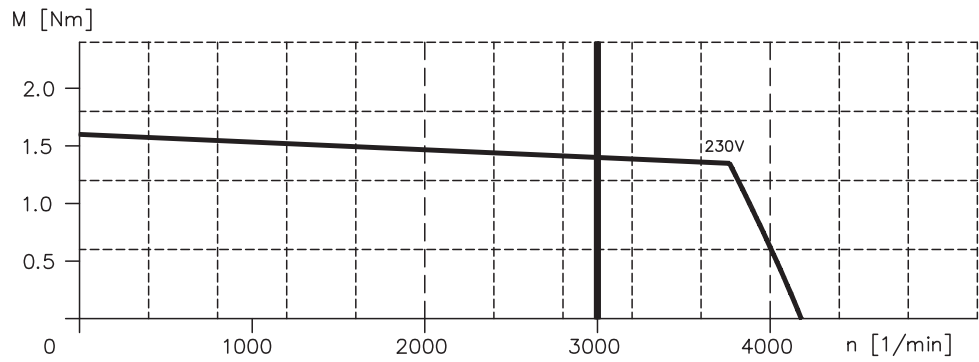

III.11

DBK5

Technical data

Data		Symbol [Unit]	DBK5 N00210	DBK5 H00210	DBK5 N00430	DBK5 H00430
Electrical data						
	Standstill torque	M_0 [Nm]	2,1	2,1	4,3	4,3
	Standstill current	I_{0rms} [A]	1,5	4	2,9	5
	Mains voltage	U_N [VAC]	230-480			
$U_N = 230V$	Rated speed	n_n [min ⁻¹]	—	3000	—	3000
	Rated torque	M_n [Nm]	—	1,9	—	3,9
	Rated current	I_n [A]	—	3,94	—	4,8
	Rated power	P_n [kW]	—	0,60	—	1,23
$U_N = 400V$	Rated speed	n_n [min⁻¹]	3000	—	3000	—
	Rated torque	M_n [Nm]	1,9	—	3,9	—
	Rated current	I_n [A]	1,5	—	2,8	—
	Rated power	P_n [kW]	0,60	—	1,23	—
$U_N = 480V$	Rated speed	n_n [min ⁻¹]	3600	—	3600	—
	Rated torque	M_n [Nm]	1,8	—	3,8	—
	Rated current	I_n [A]	1,32	—	2,55	—
	Rated power	P_n [kW]	0,68	—	1,43	—
	Peak current	I_{0max} [A]	7	14,6	13	22,5
	Torque constant	K_{Trms} [Nm/A]	1,36	0,52	1,49	0,87
	Voltage constant	K_{Erms} [mV/min]	83	32	90	53
	Winding resistance Ph-Ph	R_{20} [Ω]	22	3,1	7,1	2,2
	Winding inductance Ph-Ph	L [mH]	60	10	32	10
Mechanical data						
	Rotor moment of inertia	J [kgcm ²]	4,13		5,78	
	Static friction torque	M_R [Nm]	0,15		0,20	
	Thermal time constant	t_{TH} [min]	33		34	
	Weight standard	G [kg]	3,9		6,8	
	Radial load permitted at shaft end @ 3000 min ⁻¹	F_R [N]	640			
	Axial load permitted at shaft end @ 3000 min ⁻¹	F_A [N]	200			
	Motor number		00374R	00549R	00375R	00345R

Brake data

Data	Symbol [Unit]	Value
Holding torque	M_{BR} [Nm]	5
Operating voltage	U_{BR} [VDC]	24 +15 / -0 %
electrical power	P_{BR} [W]	16
Moment of inertia	J_{BR} [kgcm ²]	1,06
Release delay time	t_{BRH} [ms]	10-30
Application delay time	t_{BRL} [ms]	5-15
Weight of the brake	G_{BR} [kg]	0,75

Connections and leads

Data	DBK5 N00210	DBK5 H00210	DBK5 N00430	DBK5 H00430
Power connection	4 + 4 poles, round, angular			
Motor cable, shielded	4 x 1			
Motor cable with control leads, shielded	4 x 1 + 2 x 0,75			
Resolver connection	12 poles, round, angular			
Resolver cable, shielded	4 x 2 x 0,25mm ²			
Encoder connection (Option)	17 poles, round, angular			
Encoder cable, shielded	7 x 2 x 0,25mm ²			

Dimensions (drawing in principle)

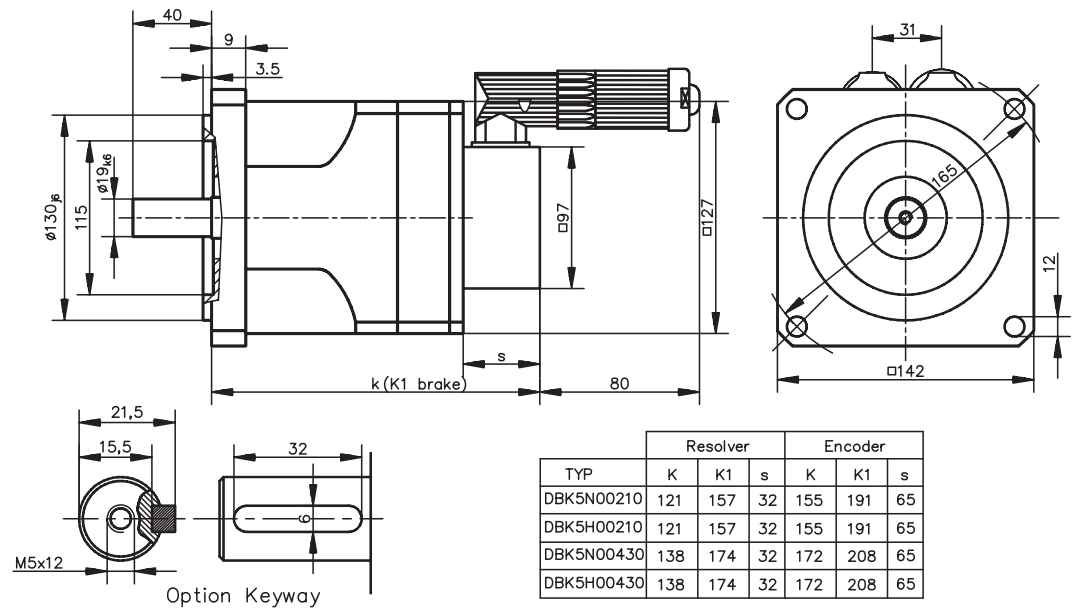

Pin assignment

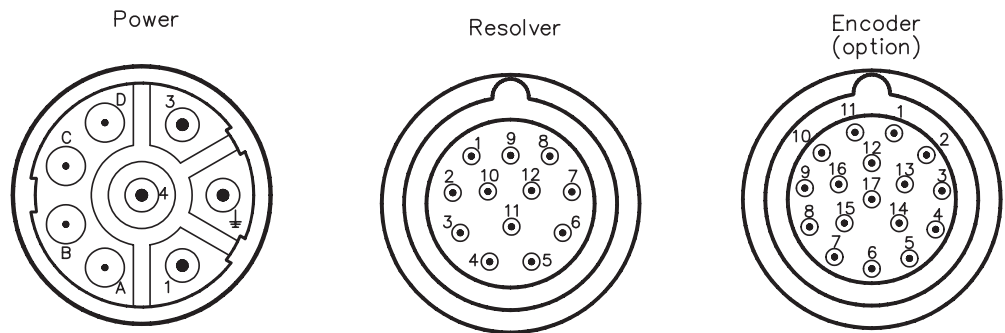

Power connector		Resolver connector		Encoder connector (Option)	
Pin	Connection	Pin	Connection	Pin	Connection
1	U2	1	n.c.	1	B- (Cosine)
⏏	PE	2	Thermostat	2	0 V (power supply)
3	W2	3	+ Cosine	3	A- (Sine)
4	V2	4	- Sine	4	U _P (power supply)
		5	+ Reference	5	DATA
A	Brake + (Option)	6	Thermostat	6	n.c.
B	Brake - (Option)	7	- Cosine	7	Thermostat
C	2nd Thermostat (Option)	8	+ Sine	8	CLOCK
D	2nd Thermostat (Option)	9	- Reference	9	B+ (Cosine)
		10	n.c.	10	0 V (Sense)
		11	n.c.	11	A+ (Sine)
		12	n.c.	12	U _P (Sense)
				13	DATA
				14	Thermostat
				15	CLOCK
				16	n.c.
				17	n.c.

Radial-/axial forces at the shaft end

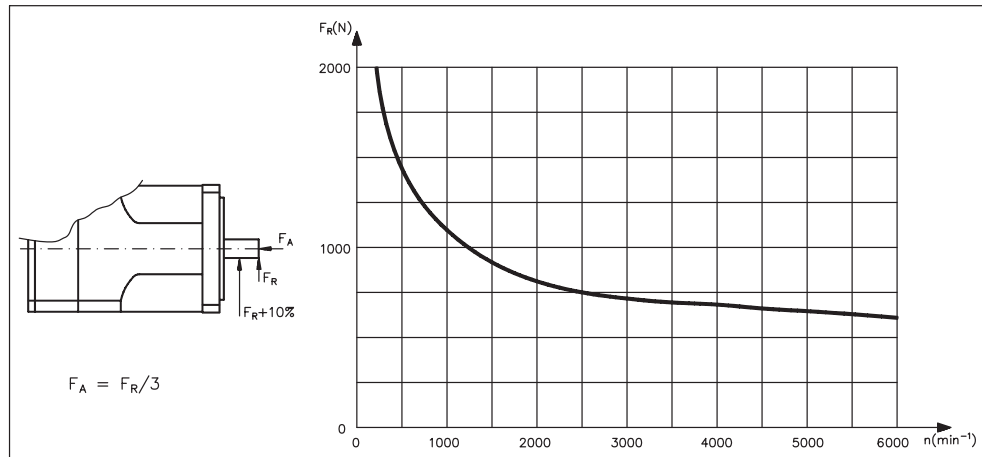

Performance curves

DBK5N00210

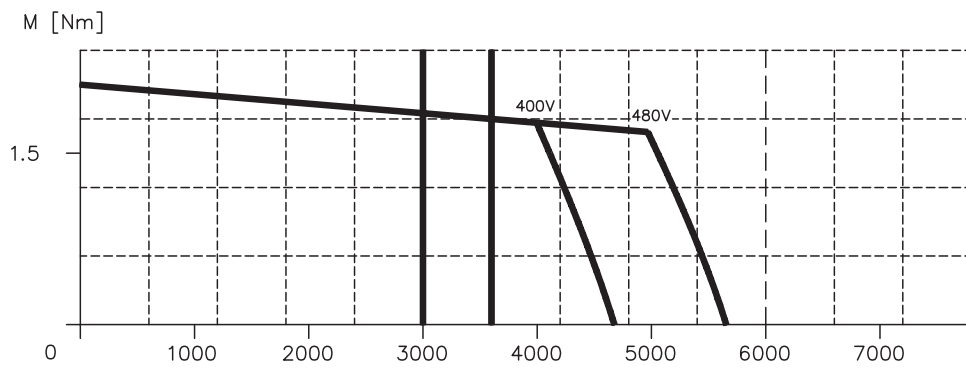

DBK5H00210

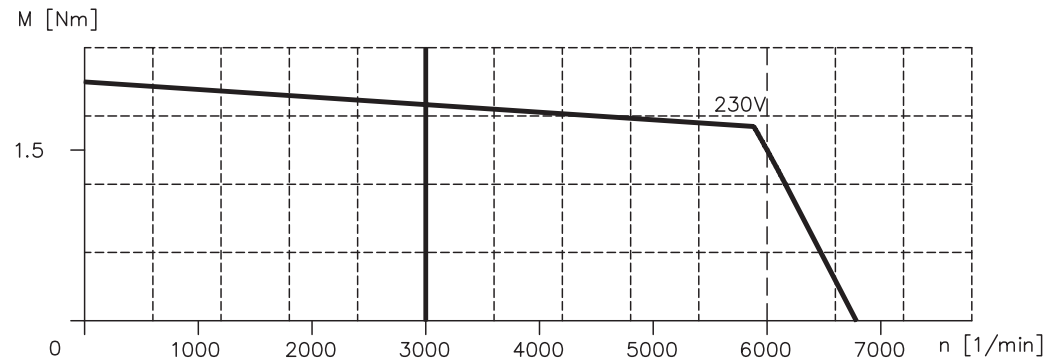

DBK5N00430

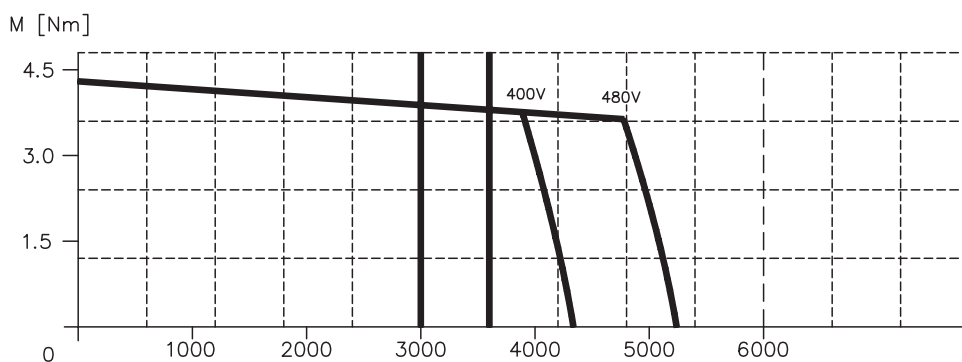

DBK5H00430

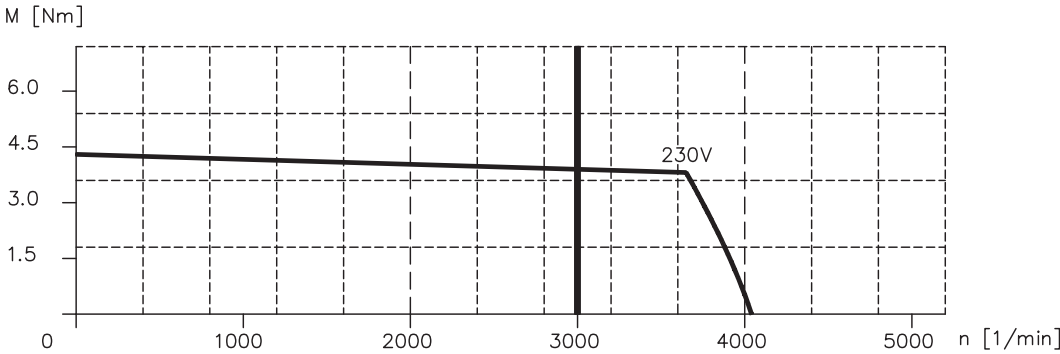

III.12

DBK6

Technical data

Data		Symbol [Unit]	DBK6 N00350	DBK6 N00700
Electrical data				
	Standstill torque	M_0 [Nm]	3,5	7
	Standstill current	I_{0rms} [A]	2,8	5
	Mains voltage	U_N [VAC]	230-480	
$U_N = 230V$	Rated speed	n_n [min ⁻¹]	—	—
	Rated torque	M_n [Nm]	—	—
	Rated current	I_n [A]	—	—
	Rated power	P_n [kW]	—	—
$U_N = 400V$	Rated speed	n_n [min⁻¹]	3000	3000
	Rated torque	M_n [Nm]	3	6
	Rated current	I_n [A]	2,7	4,6
	Rated power	P_n [kW]	0,94	1,89
$U_N = 480V$	Rated speed	n_n [min ⁻¹]	3600	3600
	Rated torque	M_n [Nm]	2,9	5,7
	Rated current	I_n [A]	2,3	4,1
	Rated power	P_n [kW]	1,09	2,15
	Peak current	I_{0max} [A]	13	23
	Torque constant	K_{Trms} [Nm/A]	1,27	1,39
	Voltage constant	K_{Erms} [mV/min]	77	84
	Winding resistance Ph-Ph	R_{20} [Ω]	12	4,4
	Winding inductance Ph-Ph	L [mH]	56	34
Mechanical data				
	Rotor moment of inertia	J [kgcm ²]	8	11,35
	Static friction torque	M_R [Nm]	0,30	0,30
	Thermal time constant	t_{TH} [min]	31	38
	Weight standard	G [kg]	5,5	8,7
	Radial load permitted at shaft end @ 3000 min ⁻¹	F_R [N]	650	
	Axial load permitted at shaft end @ 3000 min ⁻¹	F_A [N]	200	
	Motor number		00476R	00356R

Brake data

Data	Symbol [Unit]	Value
Holding torque	M_{BR} [Nm]	5
Operating voltage	U_{BR} [VDC]	24 +15 / -0 %
electrical power	P_{BR} [W]	16
Moment of inertia	J_{BR} [kgcm ²]	1,06
Release delay time	t_{BRH} [ms]	10-30
Application delay time	t_{BRL} [ms]	5-15
Weight of the brake	G_{BR} [kg]	0,75

Connections and leads

Data	DBK6 N00350	DBK6 N00700
Power connection	4 + 4 poles, round, angular	
Motor cable, shielded	4 x 1	
Motor cable with control leads, shielded	4 x 1 + 2 x 0,75	
Resolver connection	12 poles, round, angular	
Resolver cable, shielded	4 x 2 x 0,25mm ²	
Encoder connection (Option)	17 poles, round, angular	
Encoder cable, shielded	7 x 2 x 0,25mm ²	

Dimensions (drawing in principle)

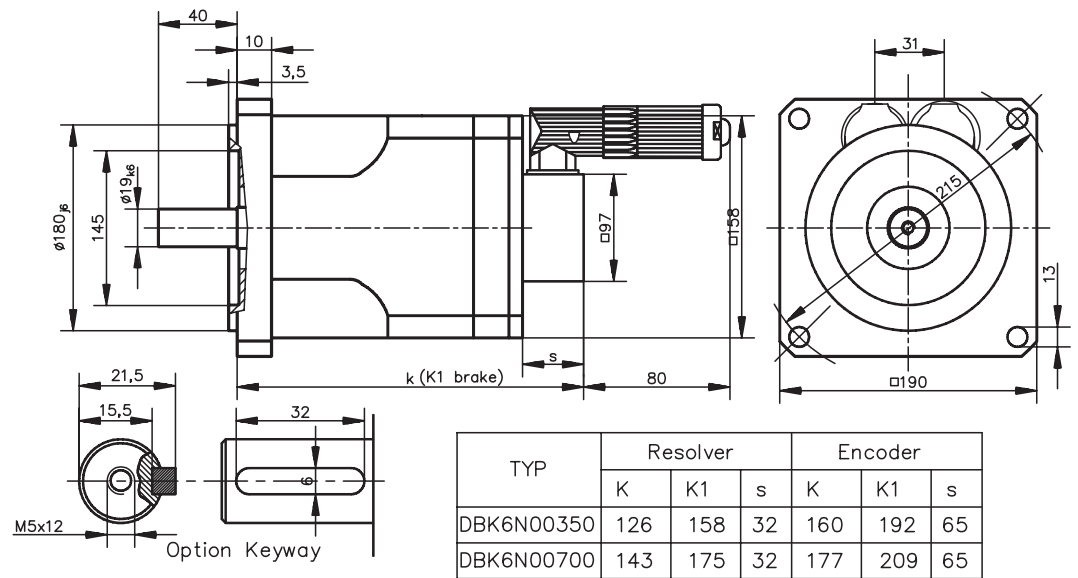

Pin assignment

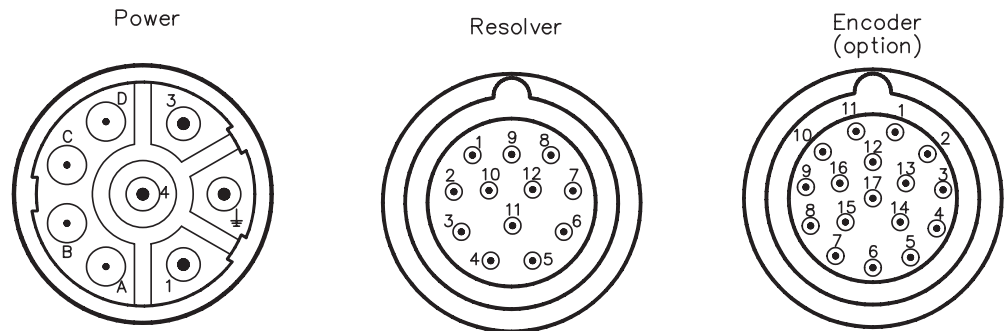

Power connector		Resolver connector		Encoder connector (Option)	
Pin	Connection	Pin	Connection	Pin	Connection
1	U2	1	n.c.	1	B- (Cosine)
⏏	PE	2	Thermostat	2	0 V (power supply)
3	W2	3	+ Cosine	3	A- (Sine)
4	V2	4	- Sine	4	U _P (power supply)
		5	+ Reference	5	DATA
A	Brake + (Option)	6	Thermostat	6	n.c.
B	Brake - (Option)	7	- Cosine	7	Thermostat
C	2nd Thermostat (Option)	8	+ Sine	8	CLOCK
D	2nd Thermostat (Option)	9	- Reference	9	B+ (Cosine)
		10	n.c.	10	0 V (Sense)
		11	n.c.	11	A+ (Sine)
		12	n.c.	12	U _P (Sense)
				13	DATA
				14	Thermostat
				15	CLOCK
				16	n.c.
				17	n.c.

Radial-/axial forces at the shaft end

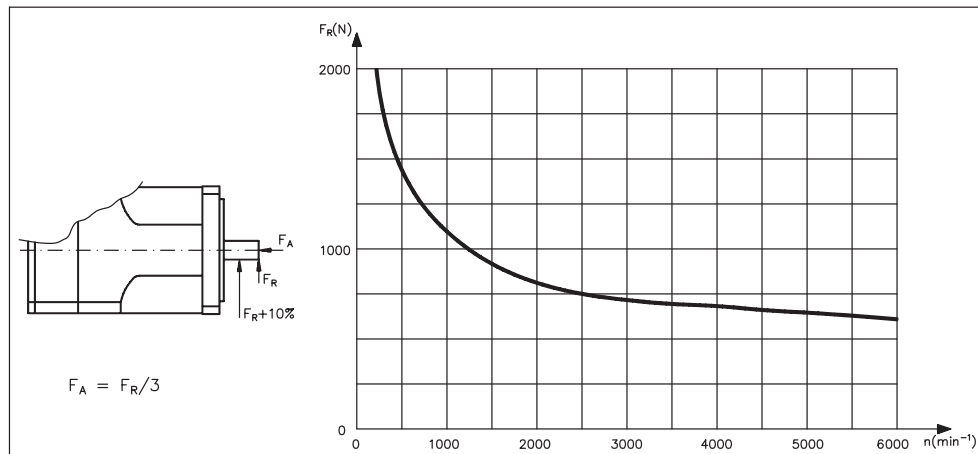

Performance curves

DBK6N00350

M [Nm]

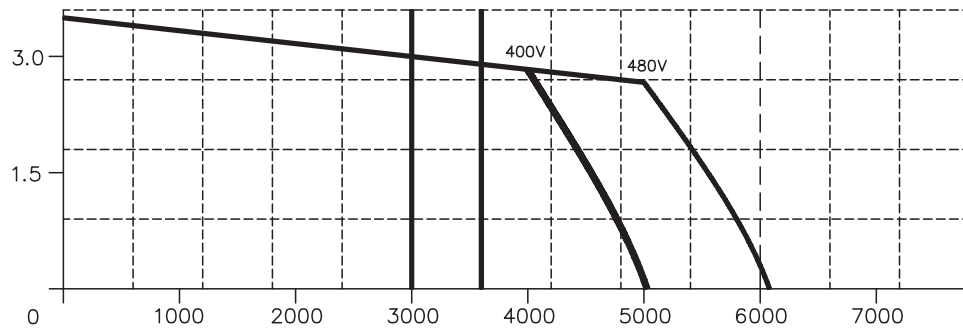

DBK6N00700

M [Nm]

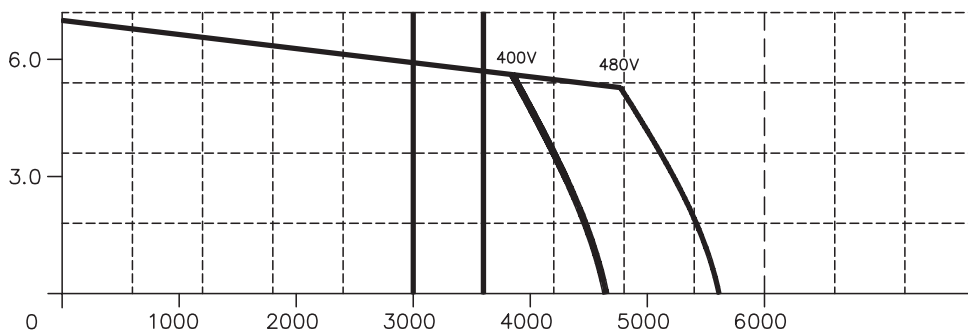

This page has been deliberately left blank.

III.13

DBK7

Technical data

Data		Symbol [Unit]	DBK7 N00650	DBK7 N01200	DBK7 N01950
Electrical data					
	Standstill torque	M_0 [Nm]	6,5	12	19,5
	Standstill current	I_{0rms} [A]	4,5	7,5	11,8
	Mains voltage	U_N [VAC]	230-480		
$U_N = 230V$	Rated speed	n_n [min ⁻¹]	—	—	—
	Rated torque	M_n [Nm]	—	—	—
	Rated current	I_n [A]	—	—	—
	Rated power	P_n [kW]	—	—	—
$U_N = 400V$	Rated speed	n_n [min⁻¹]	3000	3000	3000
	Rated torque	M_n [Nm]	5	10	15
	Rated current	I_n [A]	3,8	6,8	10
	Rated power	P_n [kW]	1,57	3,14	4,71
$U_N = 480V$	Rated speed	n_n [min ⁻¹]	3600	3600	3600
	Rated torque	M_n [Nm]	4,7	9,6	14
	Rated current	I_n [A]	3,3	5,96	8,48
	Rated power	P_n [kW]	1,77	3,62	5,28
	Peak current	I_{0max} [A]	21	34,5	55
	Torque constant	K_{Trms} [Nm/A]	1,43	1,61	1,65
	Voltage constant	K_{Erms} [mV/min]	87	98	100
	Winding resistance Ph-Ph	R_{20} [Ω]	4,15	1,65	0,9
	Winding inductance Ph-Ph	L [mH]	22	11,5	7
Mechanical data					
	Rotor moment of inertia	J [kgcm ²]	32,36	53,11	69,16
	Static friction torque	M_R [Nm]	0,35	0,40	0,50
	Thermal time constant	t_{TH} [min]	35	42	52
	Weight standard	G [kg]	10	14,5	19
	Radial load permitted at shaft end @ 3000 min ⁻¹	F_R [N]	690		
	Axial load permitted at shaft end @ 3000 min ⁻¹	F_A [N]	230		
	Motor number		00377R	00378R	00379R

Brake data

Data	Symbol [Unit]	Value
Holding torque	M_{BR} [Nm]	12
Operating voltage	U_{BR} [VDC]	24 +15 / -0 %
electrical power	P_{BR} [W]	18
Moment of inertia	J_{BR} [kgcm ²]	3,6
Release delay time	t_{BRH} [ms]	30-60
Application delay time	t_{BRL} [ms]	10-20
Weight of the brake	G_{BR} [kg]	1,5

Connections and leads

Data	DBK7 N00650	DBK7 N01200	DBK7 N01950
Power connection	4 + 4 poles, round, angular		
Motor cable, shielded	4 x 1,5		
Motor cable with control leads, shielded	4 x 1,5 + 2 x 0,75		
Resolver connection	12 poles, round, angular		
Resolver cable, shielded	4 x 2 x 0,25mm ²		
Encoder connection (Option)	17 poles, round, angular		
Encoder cable, shielded	7 x 2 x 0,25mm ²		

Dimensions (drawing in principle)

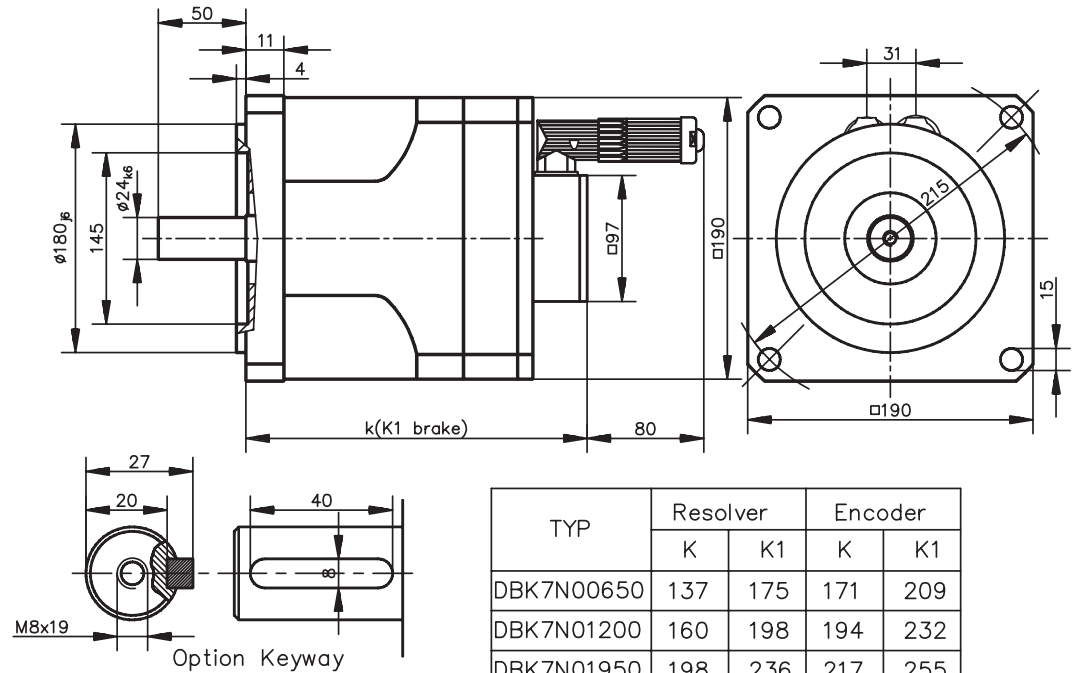

Pin assignment

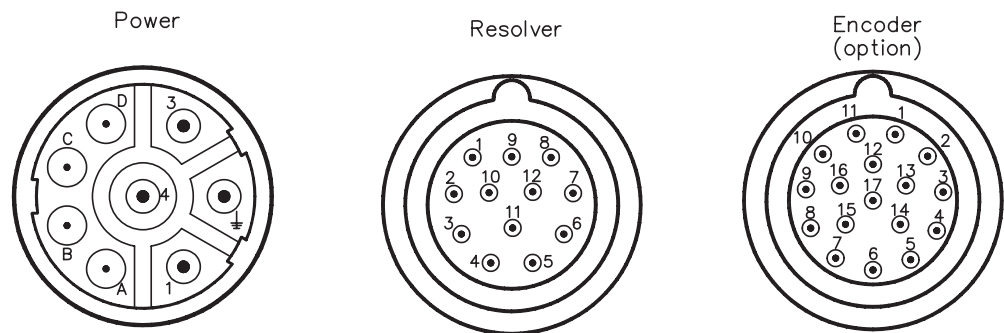

Power connector		Resolver connector		Encoder connector (Option)	
Pin	Connection	Pin	Connection	Pin	Connection
1	U2	1	n.c.	1	B- (Cosine)
\perp	PE	2	Thermostat	2	0 V (power supply)
3	W2	3	+ Cosine	3	A- (Sine)
4	V2	4	- Sine	4	U _P (power supply)
		5	+ Reference	5	DATA
A	Brake + (Option)	6	Thermostat	6	n.c.
B	Brake - (Option)	7	- Cosine	7	Thermostat
C	2nd Thermostat (Option)	8	+ Sine	8	CLOCK
D	2nd Thermostat (Option)	9	- Reference	9	B+ (Cosine)
		10	n.c.	10	0 V (Sense)
		11	n.c.	11	A+ (Sine)
		12	n.c.	12	U _P (Sense)
				13	DATA
				14	Thermostat
				15	CLOCK
				16	n.c.
				17	n.c.

Radial-/axial forces at the shaft end

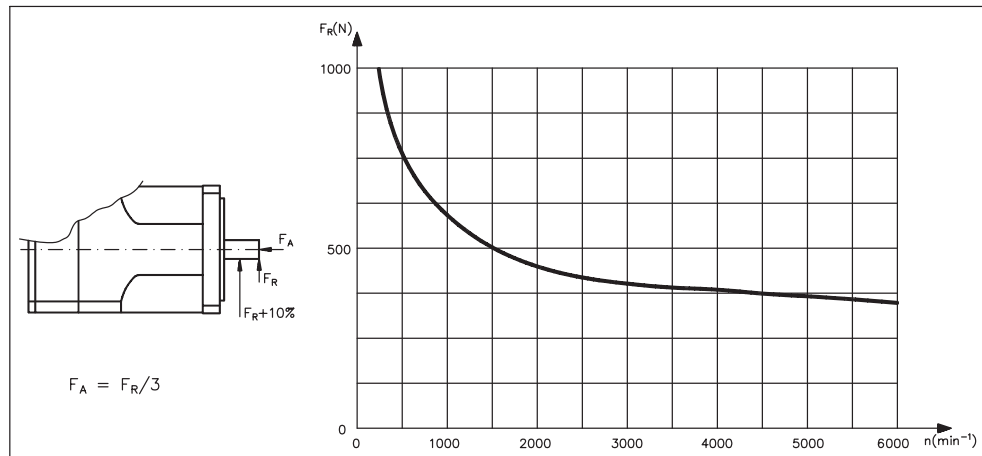

Performance curves

DBK7N00650

M [Nm]

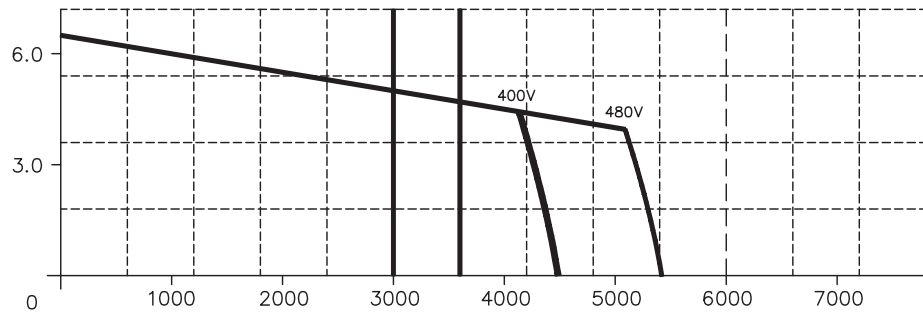

DBK7N01200

M [Nm]

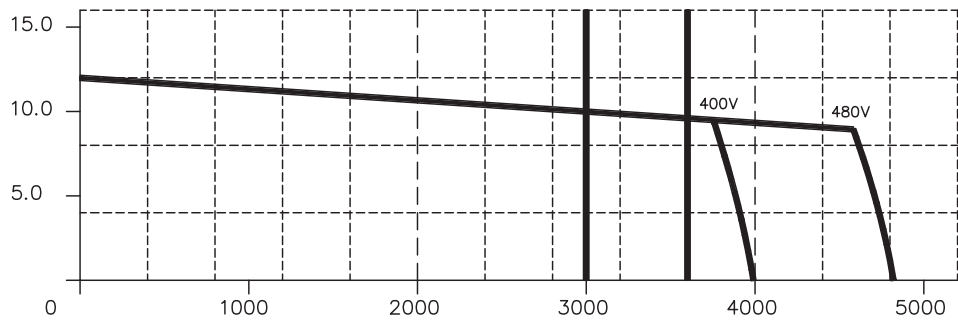

DBK7N01950

M [Nm]

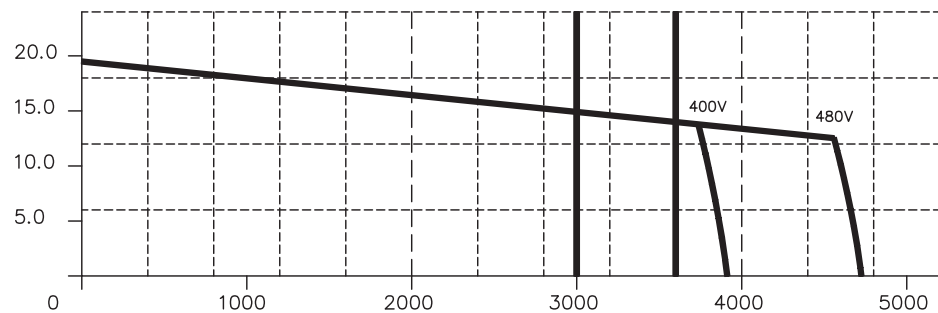

IV Appendix

IV.1 Delivery package, transport, storage, maintenance, disposal

Delivery package: — Motor from the DBL/DBK series
 — Technical description (documentation), 1 copy per delivery
 — Motor package leaflet (short info)

Transport: — Climate category 2K3 to EN 50178
 Transport temperature—25...+70°C, max. 20K/hr change
 Transport humidity rel. humidity 5% - 95% , no condensation
 — only by qualified personnel
 — only in the manufacturer's original recyclable packaging
 — avoid shocks
 — if the packaging is damaged, check the motor for visible damage.
 Inform the carrier and, if appropriate, the manufacturer.

Packaging:

Motor type	Carton	Pallet or skeleton box	Max.stacking height
DBL1	X		10
DBL2	X		10
DBL3	X		6
DBL4	X		6
DBL5	X		5
DBL6		X	1
DBL7		X	1
DBL8		X	1
DBK4	X		6
DBK5	X		5
DBK6		X	1
DBK7		X	1

Storage: — Climate category 1K4 to EN 50178
 Storage temperature —25...+55°C, max. variation 20K/hr.
 Humidity rel. humidity 5% - 95%, no condensation
 — only in the manufacturer's original recyclable packaging
 — max. stacking height see table under Packaging
 — Storage time unlimited

Maintenance: — Only by qualified personnel
 — The ball bearings have a grease packing which is adequate for 20,000 hours of operation under normal conditions. The bearings should be replaced after 20,000 hours of operation under rated conditions
 — Check the motor for bearing noise every 2500 operating hours, respectively each year. If any noises are heard, then the operation of the motor must stop, the bearings must be replaced.
 — Opening the motor invalidates the warranty.

Cleaning: — If the housing is dirty: clean with Isopropanol or similar.
do not immerse or spray

Disposal: — The disposal should be carried out by a certified disposal company.
 Ask us for addresses.

IV.2 Removing faults

The following table is to be seen as a "First Aid" box. There can be a large number of different reasons for a fault, depending on the particular conditions in your system. The fault causes described below are mostly those which directly influence the motor. Peculiarities which show up in the control loop behaviour can usually be traced back to an error in the parameterization of the servoamplifier. The documentation for the servoamplifier and the setup software provides information on these matters.

For multi-axis systems there may be further hidden reasons for faults.

Our applications department can give you further help with your problems.

Fault	Possible cause	Measures to remove the cause of the fault
Motor doesn't rotate	<ul style="list-style-type: none"> — Servo-amplifier not enabled — Break in setpoint lead — Motor phases in wrong sequence — Brake not released — Drive is mechanically blocked 	<ul style="list-style-type: none"> — Supply ENABLE signal — Check setpoint lead — Correct the phase sequence — Check brake controls — Check mechanism
Motor runs away	<ul style="list-style-type: none"> — Motor phases in wrong sequence 	<ul style="list-style-type: none"> — Correct the phase sequence
Motor oscillates	<ul style="list-style-type: none"> — Break in the shielding of the resolver cable — amplifier gain to high 	<ul style="list-style-type: none"> — Replace resolver cable — use motor default values
Error message: brake	<ul style="list-style-type: none"> — Short-circuit in the supply voltage lead to the motor holding brake — Faulty motor holding brake 	<ul style="list-style-type: none"> — Remove the short-circuit — Replace motor
Error message: output stage fault	<ul style="list-style-type: none"> — Motor cable has short-circuit or earth short — Motor has short-circuit or earth short 	<ul style="list-style-type: none"> — Replace cable — Replace motor
Error message: resolver	<ul style="list-style-type: none"> — Resolver connector is not properly plugged in — Break in resolver cable, cable crushed or similar 	<ul style="list-style-type: none"> — Check connector — Check cables
Error message: motor temperature	<ul style="list-style-type: none"> — Motor thermostat has switched — Loose resolver connector or break in resolver cable 	<ul style="list-style-type: none"> — Wait until the motor has cooled down. Then investigate why the motor becomes so hot. — Check connector, replace resolver cable if necessary
Brake does not grip	<ul style="list-style-type: none"> — Required holding torque too high — Brake faulty — Motor shaft axially overloaded 	<ul style="list-style-type: none"> — Check the dimensioning — Replace motor — Check the axial load, reduce it. — Replace motor, since the bearings have been damaged

IV.3 Index

Text	Page	Text	Page
A Ambient temperature	8	N Nameplate	12
Assembly	15	O Options	11
Axial force	9	P Peak current	21
B Break response times	21	Power derating	8
C Connection method	10	Protection class	9
Contents	3	Protective device	9
Coupling	9	R Radial force	9
D DBK4	54	Rated current	21
DBK5	58	Rated torque	21
DBK6	63	Resolver	10
DBK7	70	Resolver lead	16
DBL1	22	Rotor moment of inertia	21
DBL2	26	S Safety notes	4
DBL3	30	Servo amplifier	8
DBL4	34	Setup	19
DBL5	38	Shielding	15
DBL6	42	Site	15
DBL7	46	Standstill current	21
DBL8	50	Standstill torque	21
Delivery package	73	Storage	73
Disposal	73	Storage humidity	73
E Earthing	15	Storage temperature	73
Encoder	10	Storage time	73
F Feedback unit	10	Style	9
Flange temperature	8	T Thermal time constant	21
G Ground symbol	14	Thermostat	9
H Holding brake	10	Torque constant	21
I Insulation material class	10	Transport	73
M Maintenance	73	V Ventilation	15
Manufacturer declaration	6	Vibration class	10
Motor lead	16	Voltage constant	21
		W Wiring	15

Sales and Service

We are committed to quality customer service. In order to serve in the most effective way, please contact your local sales representative for assistance. If you are unaware of your local sales representative, please contact us.

Europe

Visit the european Danaher Motion web site at www.DanaherMotion.de for Setup Software upgrades, application notes, technical publications and the most recent version of our product manuals.

Danaher Motion Customer Support - Europe

Internet	www.DanaherMotion.de
E-Mail	info@danaher-motion.de
Phone.:	+49(0)203 - 99 79 - 0
Fax:	+49(0)203 - 99 79 - 155

North America

Visit the North American Danaher Motion web site at www.DanaherMotion.com for Setup Software upgrades, application notes, technical publications and the most recent version of our product manuals.

Danaher Motion Customer Support - Radford

(800-777-3786)

Internet	www.MotionVillage.com
E-Mail	servo@kollmorgen.com
Phone:	(800) 77SERVO