

Systems  
Technical  
Publication

# SERVOSTAR® 600

with Kollmorgen GOLDLINE™  
BH/MH Motors



**KOLLMORGEN**



**Kollmorgen SERVOSTAR® 600 Amplifier**

- **400 to 480 Volt Three Phase AC Input Power**
- **Resolver Feedback**
- **Integrated Power Supply**
- **Fully Digital Control**
- **CE, UL, cUL**

The SERVOSTAR 600 amplifier is a compact, fully digital drive-amplifier designed to simplify installation, system set-up, and system reliability.

### FEATURES:

#### Servo Control

- Easy to tune servo loops
- Advanced sinewave commutation technology provides smooth, precise low-speed control and high speed performance
- Velocity loop bandwidths to 400 Hz
- DQ Current control increases high speed peak torque performance for faster cycle rates
- Space Vector Modulation reduces normal power stage switching losses
- Torque angle control enhances motor performance
- Fully digital control loops
- Compact and attractive rugged metal package for space-saving, modern appearance - metal package minimizes electrical noise emission & susceptibility
- Command modes: Torque, Velocity, Position, Electronic Gearing Pulse Following, and Motion Task
- Five current ratings: 3, 6, 10, 14, and 20 amp RMS/phase continuous
- 2 to 1 peak/continuous current rating (5 second at peak)
- Run time counter

#### Easy Connectivity

- Built in encoder equivalent output can eliminate the need for an additional position feedback device
- RS-232 Communication

- Unique multi-drop configuration allows a PC or PLC to communicate to multiple SERVOSTAR 600 amplifiers via single RS-232 connection
- SERVOSTAR 600's versatile communication capabilities make it easy to integrate machine control data directly from the factory floor to your information system
- Analog  $\pm 10V$ , pulse/direction, master encoder, and serial port, I/O command options

#### Robust Design

- ESD rugged circuit design and fully metallic enclosure
- Full protection against short circuit, overvoltage, undervoltage, heatsink overtemperature, motor overtemperature, overspeed, overcurrent, and feedback loss
- UL, cUL listed, and CE
- Built-in line filter for CE
- Flash memory

#### Windows Start-up Environment

- Graphical environment simplifies set up
- PC "Oscilloscope" for measuring real-time motion performance
- Interactive MOTIONTASK Programming

#### Configurable I/O

- 2 separate analog inputs (14 and 12 bit resolution) configurable to 6 different command modes
- 2 analog outputs
- 4 digital inputs
- 2 digital outputs
- I/O can be configured to a variety of functions to customize the SERVOSTAR 600 to individual machines

#### I/O Option Card (see page 5)

- Adds 14 additional digital inputs and 8 digital outputs
- All I/O are optically isolated
- Simple plug in to top face of Amplifier

#### Regenerative Power Sharing

- Patented circuitry allows the DC bus from two or more amplifiers to be connected together allowing regen power to be shared among multiple drives

#### Built in Parameter Unit

- Perform basic drive set up without the need for a PC
- Provides diagnostic information
- Allows motor selection from parameters store in memory

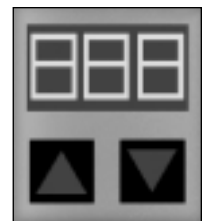

#### Built in Safety Relay

- Switches off the power stage to ensure personnel safety and prevents an unintended restart of the drive, even in the event of a fault
- Allows DC bus to remain on

### Motion Capabilities

The SERVOSTAR 600 can be configured to perform motion control that normally requires a fully programmable drive with a motion language. With the SERVOSTAR 600 there is no programming language to learn; the user only “fill in the blanks” to create common motion tasks

- Up to 180 motion task can be stored in permanent memory
- Motion Tasked can be linked together.
- 10 types of homing
- Speed profile/registration control
- Adjustable S curve acceleration

- Absolute and relative (index) moves
- Linking of motion task (sequencing)
- Adjustable Following-Error window
- Adjustable window for the In Position signal

Linked motion tasks are started:

- Immediately upon reaching a targeted position
- Digital Input upon reaching the targeted position
- A Preset Time Delay after the targeted position is reached

### Motion Examples

#### INCREMENTAL MOVE

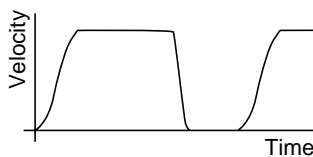

#### ABSOLUTE MOVE

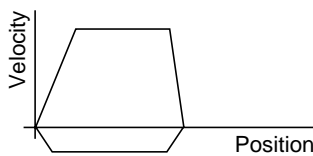

#### ELECTRONIC GEARING 5:1 (MASTER/SLAVE)

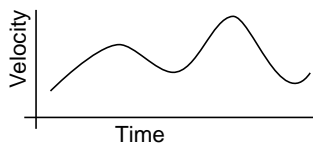

#### MACRO MOVE

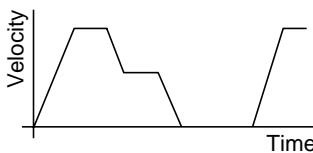

### Application Examples

- material handling
- bottle making
- packaging
- soft positioning
- robot
- conveyor belt controlling
- fast positioning
- special cleaning process
- part selection
- glass processing
- robot
- wirepuller
- textile industry
- printing
- electronics
- web converting
- cut to length

# SERVOSTAR 600

## CONNECTOR INFORMATION

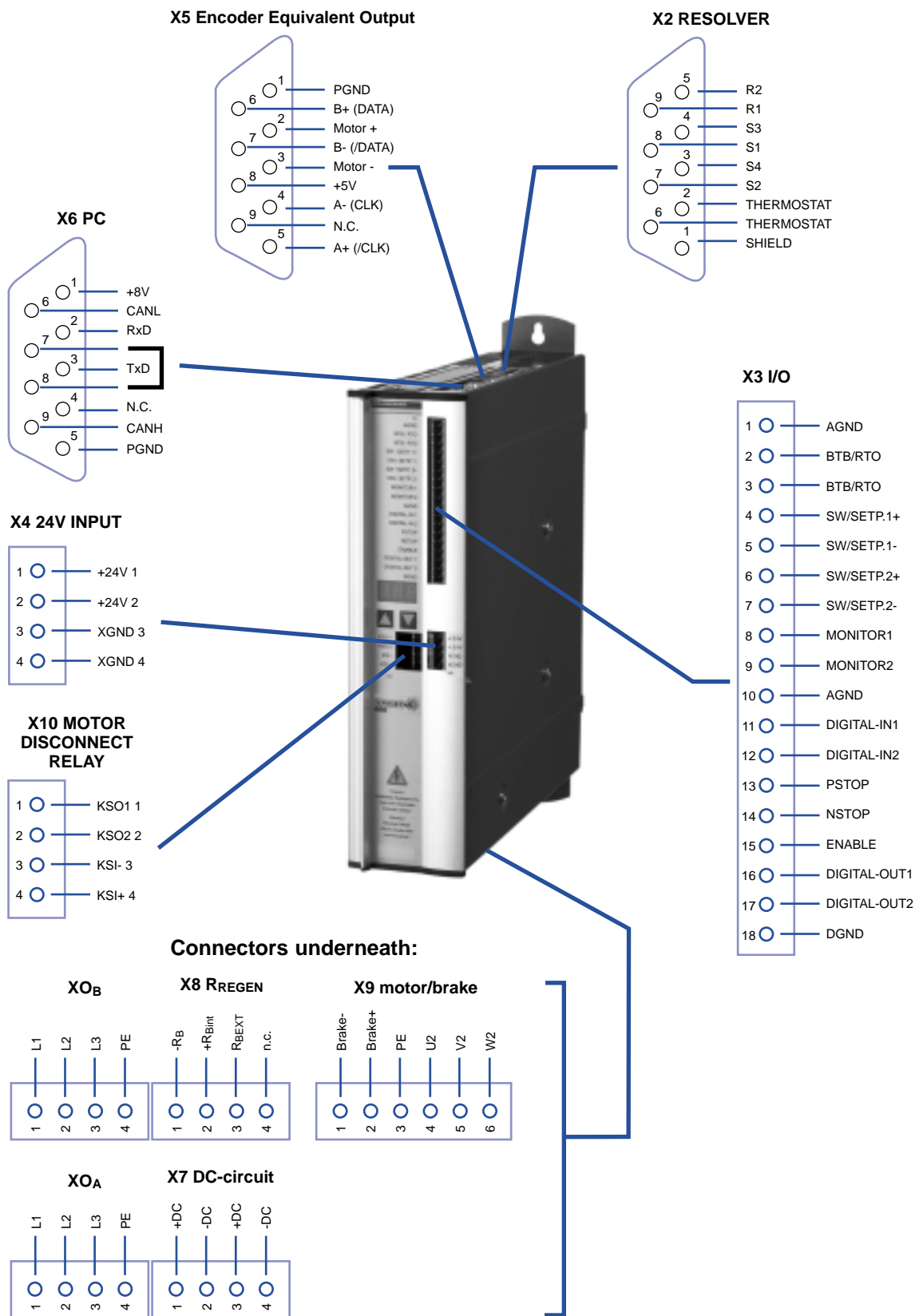

## I/O OPTION CARD

### CONNECTOR POSITION

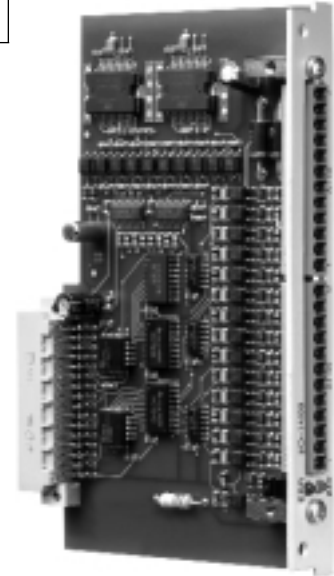
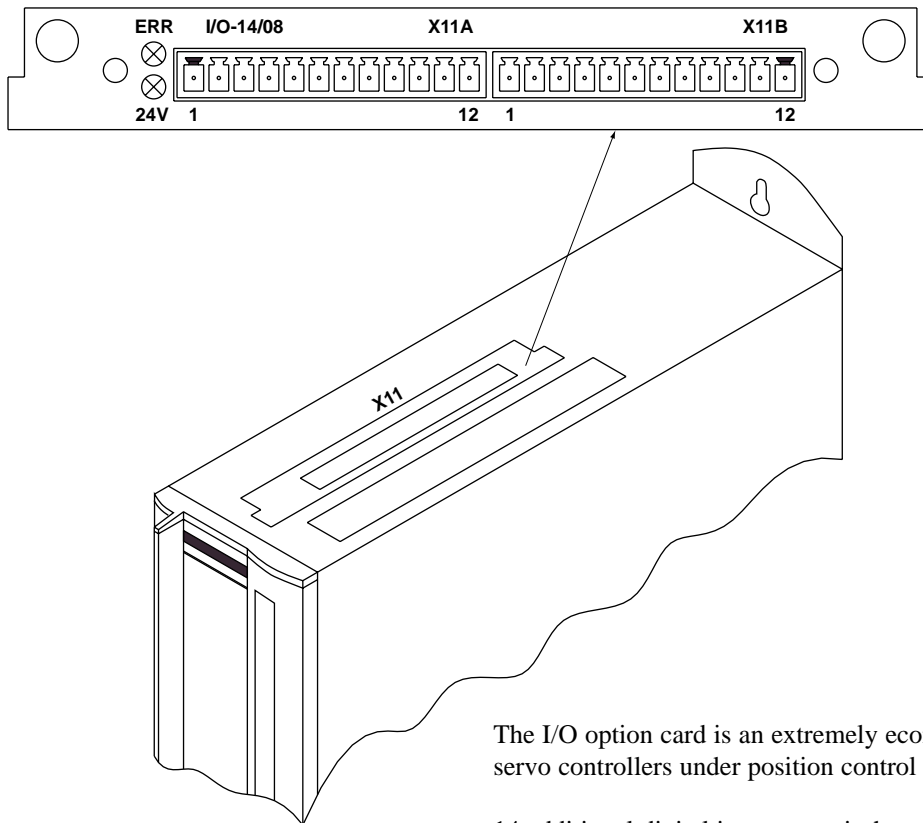

The I/O option card is an extremely economical way of operating servo controllers under position control for simple automation tasks.

14 additional digital inputs permit the selection and start of the motion tasks that are stored in the motion-task memory of the SERVOSTAR® 600. All the important functions for the position controller that is integrated into the servo controller can thus be operated from a small, independent control system.

8 digital outputs report the status of the drive to the higher-level control.

### CONNECTOR ASSIGNMENTS

Connector X11A			Connector X11B		
Terminal	Fn.	Description	Terminal	Fn.	Description
1	In	A0	1	In	MT_Restart
2	In	A1	2	In	Start_MT
3	In	A2	3	Out	InPos
4	In	A3	4	Out	Next-InPos
5	In	A4	5	Out	Sfault
6	In	A5	6	Out	PosReg1
7	In	A6	7	Out	PosReg2
8	In	A7	8	Out	PosReg3
9	In	Reference	9	Out	PosReg4
10	In	Sfault_clear	10	Out	Reserve
11	In	Start_MT Next	11	Sup.	24V DC
12	In	Start_Jog v=x	12	Sup.	I/O-GND

### Electrical characteristics

- Closed loop velocity bandwidth up to 400 Hz
- Motor current ripple frequency 16 kHz
- Switching frequency: 8 kHz
- Long term speed regulation (0.01%)
- Position loop update rate 250  $\mu$ s (4 kHz)
- Velocity loop update rate 250  $\mu$ s (4 kHz)
- Commutation update rate 62.5  $\mu$ s (16 kHz)
- SVM Current loop update rate 62.5  $\mu$ s (16 kHz)

### Fault protection

- Output phase to phase and phase to ground short circuit protection
- Overvoltage
- Undervoltage
- Overtemperature (motor and amplifier)
- Overspeed
- Overcurrent
- Feedback loss
- Foldback
- Supply loss
- Excessive position error

### Environmental

- Operation range
  - Ambient 0 to 45°C (derated above ambient up to 55°C)
  - Storage -25°C to 55°C
- Humidity (non-condensing) max 85%

### Velocity Loop Compensation

- PI Plus controller (PDFF Format) or PI controller
- Field tunable and digital repeatability

### Position Loop Compensation

- Proportional loop with Feed Forward

### Analog I/O

- 2 Configurable Inputs:  $\pm$ 10V, 12 and 14 bit resolution
- 2 Configurable Outputs:  $\pm$ 10V, 10 bit resolution

### Digital I/O

- 4 Configurable Inputs: 24 volts, PLC-compatible
- 2 Configurable Outputs: 24 volts (open collector), PLC-compatible
- Remote enable Input: 24V, PLC-compatible

### Drive Status Relay (BTB/RTO)

- Contact closure rated for 0.5 amps, 24 Volt

### Pulse or Master/Slave Input

- Pulse command: pulse/direction or quadrature encoder format
- RS-485 receivers
- Up to 16 slave amplifiers can be connected together
- Input ratio is configurable

### Position Feedback For User (Encoder Equivalent Output Port)

- Configurable to Encoder Equivalent (ROD) or SSI format
- Encoder Equivalent (ROD): A Quad B with Marker (zero) pulse, RS-485 driver
- SSI (serial synchronous interface): max clock frequency is 1.5 Mhz, RS-485 driver
- Programmable resolution

### I/O Extension Card (Option)

- Field Installable
- 14 Digital Inputs 24V, PLC-compatible
- 8 Digital Outputs 24V, PLC-compatible
- 24V PLC Interface

### Communications

- RS-232 Interface

### Operational modes

- Torque control — from analog or digital command
- Velocity control — from analog or digital command
- Pulse following
- Gearing from quad encoder input
- Motion Task
- Serial Commands

### Diagnostics

- 3 digit Seven segment LED display
- Error history log
- Internal variable monitoring
- PC scope

### Motor Feedback

- Resolver

### Motor Brake Control

- 24V optional holding brake in the motor can be controlled directly by the SERVOSTAR 600

### Power Inputs

- 400 to 480VAC 3phase, 50 or 60 Hz, built in line filter for CE requirements
- 24 VDC @ 1 amp (3 amps with brake) For Logic

### Power Regeneration Options

- Internal
- External - using BAR housed resistors
- Bus Sharing - Distributes regen power among multiple amplifiers

### Built in Parameter Unit

- Displays drive status information
- Parameters: Drive Address, baud rate, Velocity loop tuning, Motor type, Position output information format, brake, regen type

## Amplifier Ratings

Model	Output Continuous Current Per Phase (RMS/phase)	Output Peak Current Per Phase (5 sec)	Internal Power Dissipation (Watts)	AC Input Line Voltage (3 phase)	Rated Input Power (KVA) @480 V	Continuous Internal Regen Power (Watts)	Continuous External Regen Power (Watts)
S603	3	6	40	400-480	2.3	80	500
S606	6	12	60	400-480	4.6	200	1,500
S610	10	20	90	400-480	8.1	200	1,500
S614	14	28	160	400-480	11.6	200	1,500
S620	20	40	200	400-480	16.6	200	1,500

## DIMENSIONS/ORDERING INFORMATION

### Resistive Regeneration Sizing

Shunt regeneration is required to dissipate energy that is pumped back into the DC bus during load deceleration. The amount of shunt regeneration required is a function of the sum of simultaneously decelerating loads. The loads need to be defined in terms of system inertia, maximum speed, and deceleration time. In addition, the duty cycle must be known. Application Note AS6000H details a calculation method to determine proper regeneration sizing.

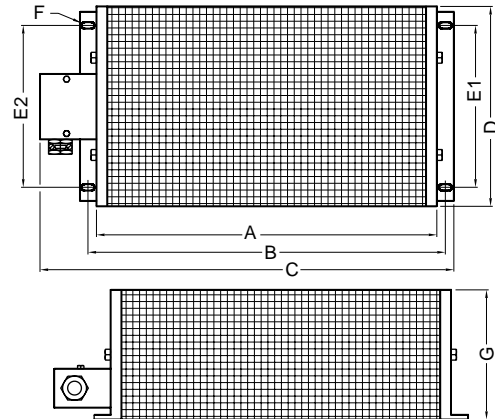
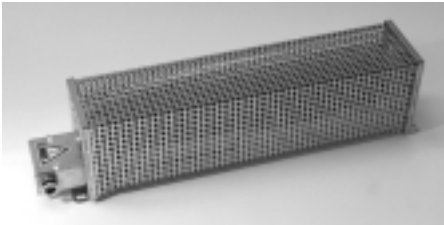

Model	Watts	Ohms	Amplifiers	A	B	C	D	E1	E2	F	G
BAR-250	250	33	S603, S606, S610	330(12.99)	390(15.35)	412(16.22)	66(2.60)	44(1.73)	35(1.38)	4,5x9(.20x.35)	77(3.03)
BAR-500	500	33	S603, S606, S610	400(15.75)	426(16.77)	486(19.13)	92(3.62)	64(2.52)	64(2.52)	6,5x9(.20x.35)	120(4.72)
BAR-1500	1500	33	S606, S610	500(19.69)	526(20.71)	586(23.07)	185(7.28)	150(5.91)	150(5.91)	6,5x9(.20x.35)	120(4.72)

## SERVOSTAR 600 DIMENSIONS

### S603/06/10

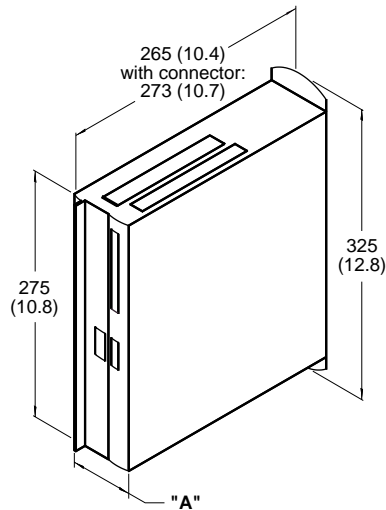

Dimensions in mm (inches)

	DIM. "A"
3 AMP	70 (2.8)
6 AMP	70 (2.8)
10 AMP	70 (2.8)
14 AMP	100 (3.9)
20 AMP	120 (4.7)

## ADDITIONAL FUNCTIONS

**MOTIONLINK**® for Windows takes the fear out of setting up a servo system. Designed for the novice as well as the advanced user, **MOTIONLINK** lets users quickly set-up and fine tune system performance.

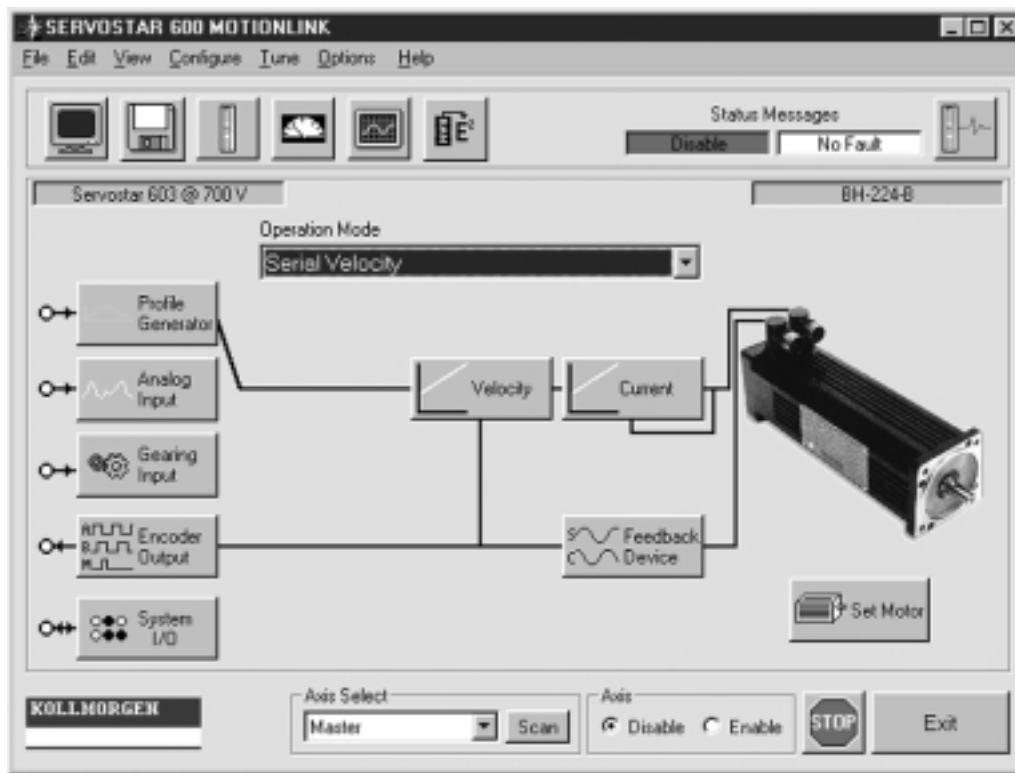

### PC Oscilloscope:

For closely evaluating system performance **MOTIONLINK** includes the functionality of an oscilloscope. You can very easily excite the load then review performance graphically on your computer screen.

### Direct Terminal Mode:

This mode turns your computer into a "dumb terminal." Variables or parameters can be monitored and changed using the **SERVOSTAR 600's** command language. This mode is ideal for advanced users who want to get directly in the "heart" of the **SERVOSTAR 600**.



### Tuning:

Velocity and position loop tuning is straight forward, allowing the novice user to achieve the best machine performance.

### Monitor Mode:

Allows you to monitor key operation variables. Speed, torque, and other variables can be viewed in real PSEUDO time in linear gauge format.



### Auto Set-up:

**MOTIONLINK** auto set-up environment walks even the first time user through line voltage, motor, operation mode and load tuning to make system configuration friendly and fast.

### Configuring I/O:

Inputs & Outputs are configurable to a wide variety of functions to configure the **SERVOSTAR 600** to individual machine needs.



**MOTIONLINK** has many other features including:

- Saving drive configuration to disk
- Activating position limits
- Displaying amplifier status
- Setting acceleration amps
- Limiting max speed or torque



## CONFIGURABLE AND READABLE FUNCTIONS

<b>Basic Set Up</b> <ul style="list-style-type: none"> <li>• Input Power</li> <li>• Main Phase Missing</li> <li>• Max Regen Power</li> <li>• Internal or External Regen Resistor</li> <li>• Drive Name and Serial No *</li> <li>• Run Time *</li> <li>• Firmware Version *</li> <li>• Hardware Version *</li> </ul>	<b>Velocity Control</b> <ul style="list-style-type: none"> <li>• Speed Command Scaling</li> <li>• Speed Command Ramp (Accel)</li> <li>• Speed Command Ramp (Decel)</li> <li>• Maximum Speed</li> <li>• Proportional Gain</li> <li>• Integral Time Constant</li> <li>• Feedback Filter</li> <li>• Motion direction</li> </ul>	<b>Motion Homing/Jogging</b> <ul style="list-style-type: none"> <li>• Direction</li> <li>• Homing Type</li> <li>• Reference Offset</li> <li>• Start Command</li> <li>• Jog Command</li> <li>• Homing Velocity</li> <li>• Jog Velocity</li> </ul>
<b>Drive Operation Modes</b> <ul style="list-style-type: none"> <li>• Digital Speed</li> <li>• Analog Speed</li> <li>• Digital Torque</li> <li>• Analog Torque</li> <li>• Electronic Gearing</li> <li>• External Position Control</li> <li>• Internal Position - MotionTasks</li> </ul>	<b>Current Control</b> <ul style="list-style-type: none"> <li>• Current Command Scaling</li> <li>• Current Foldback</li> <li>• Cont Drive Current</li> <li>• Peak Drive Current</li> <li>• Proportional Gain</li> <li>• Integral Time Constant</li> </ul>	<b>Communications</b> <ul style="list-style-type: none"> <li>• RS-232 from PC</li> <li>• Drive Address</li> <li>• Message Types from Drive</li> <li>• Prompt Configuration</li> <li>• Scan</li> </ul>
<b>Digital Scope Tool</b> <ul style="list-style-type: none"> <li>• Record real time data</li> <li>• Display on PC Oscilloscope</li> <li>• Start Current Move</li> <li>• Start Jog Move</li> <li>• Start Position Move</li> <li>• Record Start</li> <li>• Adjust Trigger</li> <li>• Recording in Process *</li> <li>• Cancel Recording</li> <li>• Recording Done *</li> <li>• Transmit Data to PC Oscilloscope</li> </ul>	<b>Motor Configuration</b> <ul style="list-style-type: none"> <li>• Motor Name and Number *</li> <li>• Motor Continuous Current</li> <li>• Motor Peak Current</li> <li>• Motor Inductance</li> <li>• Motor Poles</li> <li>• Motor Max Speed</li> <li>• Motor Brake (with or without)</li> <li>• Motor Adaptive Gain</li> <li>• Motor Speed Angle Advance</li> <li>• Motor Torque Angle Advance</li> </ul>	<b>Position Output (Motor)</b> <ul style="list-style-type: none"> <li>• Format: Off, Encoder equivalent output or SSI format</li> </ul> <b>Encoder Equivalent Output</b> <ul style="list-style-type: none"> <li>• Resolution of Encoder Equiv Output</li> <li>• Marker Pulse Offset</li> </ul> <b>SSI</b> <ul style="list-style-type: none"> <li>• Baud rate of SSI Output</li> <li>• Format type (binary or gray code)</li> <li>• Standard or Inverted Clock</li> <li>• Input Edge Positive or Negative</li> </ul>
<b>Feedback Configuration</b> <p><b>Resolvers:</b></p> <ul style="list-style-type: none"> <li>• Number of Poles</li> <li>• Resolver-zero offsetting</li> <li>• Resolver Bandwidth</li> <li>• Feedback Gain</li> </ul>	<b>Drive Status</b> <ul style="list-style-type: none"> <li>• Actual Error *</li> <li>• Actual Warning *</li> <li>• Last 10 Errors *</li> <li>• Rate of Occurrence *</li> <li>• Drive Reset Command</li> </ul>	<b>Position Control</b> <ul style="list-style-type: none"> <li>• Proportional Gain</li> <li>• Integral Action Time</li> <li>• Feed Forward</li> <li>• Following Error *</li> </ul>
<b>Drive Monitoring</b> <ul style="list-style-type: none"> <li>• Regen Wattage *</li> <li>• Actual Position (within one rev) *</li> <li>• Actual Position *</li> <li>• Actual Speed *</li> <li>• Command Speed *</li> <li>• Current Foldback Level *</li> <li>• Drive Temperature *</li> <li>• Heatsink Temperature *</li> <li>• Effective Current *</li> <li>• D Current Component *</li> <li>• Q Current Component *</li> <li>• Analog Commands *</li> <li>• DC Bus voltage *</li> </ul>	<b>Others</b> <ul style="list-style-type: none"> <li>• Stop Drive</li> <li>• Drive Enable</li> <li>• Drive Disable</li> </ul>	<b>Motion-Gear Mode</b> <ul style="list-style-type: none"> <li>• GearMode Type:</li> <li>• Encoder Follower</li> <li>• Pulse Follower</li> </ul>

\* READ ONLY

## CONFIGURABLE AND READABLE FUNCTIONS

### Motion Task (or Blocks)

- Change/Copy Motion Task
- Position Type (Rotary or Linear)
- Master/Slave
- Motion Task Stop
- In Position
- Set Position Registers
- Motion Task Start
- Acceleration ramp
- Deceleration Ramp
- Min Acceleration
- Max Velocity
- Position Capture (Positive or Negative Edge)

### Analog Input

- Two Differential Analog Inputs that can be configured in the following ways:

#### Mode 0

The amplifier uses Input 1 only, depending on the operation mode.

OPMODE	Input 1	Input 2
analog speed	speed command	inactive
analog torque	torque command	inactive

#### Mode 1

The amplifier uses Input 1 or 2, depending on the operation mode.

OPMODE	Input 1	Input 2
analog speed	speed command	inactive
analog torque	inactive	torque command

#### Mode 2

Both inputs are switched off.

OPMODE	Input 1	Input 2
analog speed	inactive	inactive
analog torque	inactive	inactive

#### Mode 3

The amplifier uses Input 1, depending on the operation mode. Input 2 is used for limiting peak current.

OPMODE	Input 1	Input 2
analog speed	speed command	limits peak torque
analog torque	torque command	limits peak torque

#### Mode 4

The amplifier uses the sum of Inputs 1 and 2, depending on the setting of OPMODE.

OPMODE	Input 1 + Input 2
analog speed	speed setpoint
analog torque	torque setpoint

#### Mode 5

The amplifier uses the product of Inputs 1 and 2, depending on the setting of OPMODE. The voltage on Input 2 has the effect of a weighting factor for Input 1.

OPMODE	Input 1 • Input 2
analog speed	speed setpoint
analog torque	torque setpoint

- Signal dead band
- Signal offset
- Auto Offset command
- Input Configuration

### Analog Output

- Two Analog Outputs can be configured for Actual Speed, Actual Current, Commanded Speed, Commanded Current, or Contouring error window

## CONFIGURABLE AND READABLE FUNCTIONS

### Digital I/O

#### Inputs:

The 4 digital inputs can be configured as follows:

IN1MODE=1	External drive reset (only available at Input 1)
IN3MODE=2	Activates PSTOP in positive direction of travel (only available at Input 3)
IN4MODE=3	Activates NSTOP in negative direction of travel(only available at Input 4)
IN3MODE=4	Activates PSTOP function combined with integral gain off (only available at Input 3)
IN4MODE=5	Activates NSTOP function combined with integral gain off (only available at Input 4)
IN3MODE=6	Activates both PSTOP and NSTOP (only available at Input 3)
IN3MODE=7	Activates both PSTOP and NSTOP with integral gain off (only available at Input 3)
INxMODE=8	Switch between analog input 1 and analog input 2
INxMODE=9	Select a motion task that is stored in memory
INxMODE=10	Turn integral gain off in the velocity loop
INxMODE=11	Switch between velocity and torque control
INxMODE=12	Home switch
INxMODE=13	Change over position feedback from encoder equivalent output format (ROD) to SSI format
INxMODE=14	Reset following error or limit infringement warning
INxMODE=15	Start next motion task once the targeted position is reached
INxMODE=16	Start a motion task. Enter task number through an auxiliary variable
INxMODE=17	Start motion task that is bit coded on the digital inputs
INxMODE=18	Switch over to second (lower) peak value of current
INxMODE=19	Reserved
INxMODE=20	Start jog. Enter speed through an auxiliary variable
INxMODE=21	Turn off undervoltage monitoring
INxMODE=22	Restart motion task that was interrupted
INxMODE=23	Same as INxMode 16 except motion task started on rising edge only
INxMODE=24	Switch between Opmodes a (Input high) and b (Input low) when $INxTRIG = a*256+b$
INxMODE=25	During set up, set encoder equivalent output marker pulse offset
IN2MODE=26	Position latch on rising edge of input (only available at Input 2)
INxMODE=30	On rising edge of input the string stored in INHCMD will be processed. On falling edge of input the string stored in INLCMD will be processed. Multiple commands in the string are possible up to total of 64 characters.

#### Outputs:

The 2 digital outputs can be configured as follows:

OxMODE=1	Motor speed is less than preset value	OxMODE=16	Target position reached for each task in an automatically executed sequence of motion task (Next-In Position)
OxMODE=2	Motor seed is greater than preset value	OxMODE=17	Error or warning message is signaled
OxMODE=3	Drive power stage ready	OxMODE=18	Error message is signaled
OxMODE=4	Preset regen power is exceeded	OxMODE=19	DC bus voltage is higher than an auxiliary value
OxMODE=5	Software travel limit is reached	OxMODE=20	DC bus voltage is lower than an auxiliary value
OxMODE=6	Actual position is greater than preset value	OxMODE=21	Drive is enabled
OxMODE=7	Target position reached (In Position)	OxMODE=22	Marker pulse (low speeds only)
OxMODE=8	Actual current feedback less than preset value	OxMODE=23	Option card status
OxMODE=9	Actual current feedback greater than preset value	OxMODE=24	Homing complete
OxMODE=10	Following error exceeded	OxMODE=28	Preset function of position register 0 is reached
OxMODE=11	I <sup>2</sup> T monitoring threshold is reached	OxMODE=29	Preset function of position register 5 is reached
OxMODE=12	Preset function of position register 1 is reached	OxMODE=35	Status of hardware and software enable
OxMODE=13	Preset function of position register 2 is reached		
OxMODE=14	Preset function of position register 3 is reached		
OxMODE=15	Preset function of position register 4 is reached		

# Kollmorgen GOLDLINE BH/MH

## INTRODUCTION



### *Kollmorgen GOLDLINE™ BH/MH Series*

- 0.52 to 69 lb-ft (0.7 to 93 N-m)
- 70.0 to 190 mm (2.76 to 7.5 inches) Square Frame
- Resolver Feedback
- Speeds up to 7500 RPM
- 400/480 VAC, 565/680 VDC bus rated

Kollmorgen **GOLDLINE BH/MH** servomotors build on the tradition of high performance motors from Kollmorgen. Designed around the classic industry-standard Kollmorgen **GOLDLINE** series, the **BH/MH** motors incorporate the highest energy rare earth neodymium-iron-boron magnets and excellent thermal design to provide exceptional continuous torque and peak torque performance in a compact package.

The servomotors incorporate the patented IPM (Interior Permanent Magnet) design technology which results in superior torque to inertia and torque per volume ratios.

The **BH/MH** line of servomotors is available in 5 frame sizes and 3 stack lengths per frame. With multiple windings per stack, the **BH/MH** series meet the needs of a wide range of applications.

#### **BH-Series** (low inertia)

The **BH-Series** provides extremely low inertia rotors allowing optimum performance in applications requiring rapid acceleration and deceleration. The IPM magnetic design provides for very high torque density and torque/inertia ratios. When used with the **SERVOSTAR® 600** family of amplifiers, the resulting speed/torque is the widest range in the industry.

#### **MH-Series** (medium inertia)

The **MH-Series** is an extension of the **BH-Series**. With seven times higher inertia, this motor series offers the advantage of better performance for systems having compliant loads or larger inertia mismatches.

#### **FEATURES:** BH or MH Series

- Compact (high torque/volume ratio)
- Speeds to 7500 RPM standard
- IPM (Interior Permanent Magnet) design for low cogging
- CE Compliant, UL recognition
- Rugged resolver feedback
- Built-in thermostat
- Rear shaft extension for mounting additional feedback devices
- Class H insulation system
- Rotatable CE connectors standard on 12x, 22x, 42x
- Terminal Box standard on 62x and 82x frames

#### **OPTIONS:**

- IP65 and IP67 sealing
- Fail-safe brake, 24 and 90VDC
- NEMA and Metric mountings
- Standard **SERVOSTAR 600** UL/CE cable assemblies available in 3 meter increments

#### **MOTOR RATINGS**

The motors performance capacity depends on the ability to get rid of the heat generated within the motor package. The ratings on the following pages assume that the motor is mounted to a metal mounting bracket capable of drawing heat energy away. The ratings assume the following:

- a.) For BH12x and BH22x: Continuous Duty Ratings are for a motor mounted to a 1/4 inch thick aluminum faceplate of 96 square inches.
- b.) For the BH42x, BH62x, and BH82x: Continuous Duty Ratings are for a motor mounted to a 1 inch thick aluminum faceplate plate of 452 square inches.
- c.) Ambient temperature is 40° C (or less)

Equivalent thermal masses and radiating surface areas are a common part of classical machine design. Other applications require derating.

# Kollmorgen GOLDLINE BH/MH and SERVOSTAR 600

## SYSTEM PERFORMANCE CURVES

### 1 ■ Motor BH-122-A or MH-123-A ■ Amplifier: S603

Performance Specification	Symbol	Units	
Cont. Torque at stall	Tc	lb-ft	0.52
		N-m	0.70
Peak Torque at stall	Tp	lb-ft	1.77
		N-m	2.40
Cont. Power @480V	HP rated	HP	0.54
	kW rated	kW	0.41
Max. Speed	N	RPM	7500
Motor Inertia	BH Series	Jm	lb-ft-s <sup>2</sup>
			kg-m <sup>2</sup>
Motor Inertia	MH Series	Jm	lb-ft-s <sup>2</sup>
			kg-m <sup>2</sup>
Motor Weight	BH Series	Wt	lb
			kg
Motor Weight	MH Series	Wt	lb
			kg

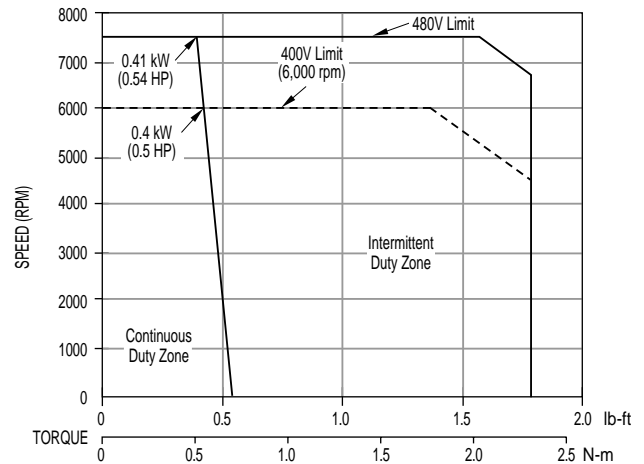

### 2 ■ Motor BH-124-B or MH-125-B ■ Amplifier: S603

Performance Specification	Symbol	Units	
Cont. Torque at stall	Tc	lb-ft	1.00
		N-m	1.35
Peak Torque at stall	Tp	lb-ft	3.10
		N-m	4.20
Cont. Power @480V	HP rated	HP	1.11
	kW rated	kW	0.83
Max. Speed	N	RPM	7500
Motor Inertia	BH Series	Jm	lb-ft-s <sup>2</sup>
			kg-m <sup>2</sup>
Motor Inertia	MH Series	Jm	lb-ft-s <sup>2</sup>
			kg-m <sup>2</sup>
Motor Weight	BH Series	Wt	lb
			kg
Motor Weight	MH Series	Wt	lb
			kg

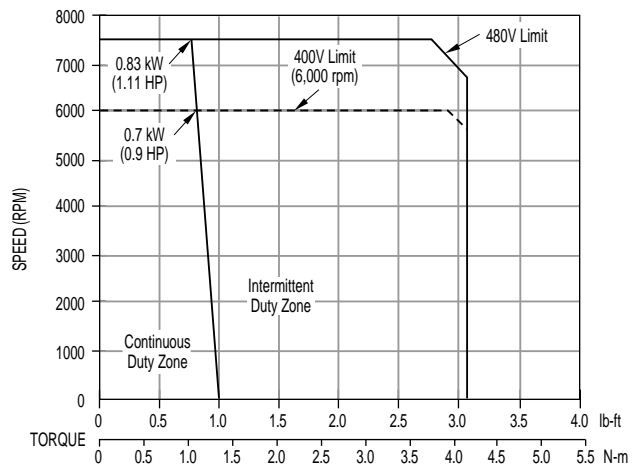

### 3 ■ Motor BH-126-B or MH-127-B ■ Amplifier: S603

Performance Specification	Symbol	Units	
Cont. Torque at stall	Tc	lb-ft	1.40
		N-m	1.90
Peak Torque at stall	Tp	lb-ft	3.10
		N-m	4.20
Cont. Power @480V	HP rated	HP	1.6
	kW rated	kW	1.2
Max. Speed	N	RPM	7500
Motor Inertia	B Series	Jm	lb-ft-s <sup>2</sup>
			kg-m <sup>2</sup>
Motor Inertia	M Series	Jm	lb-ft-s <sup>2</sup>
			kg-m <sup>2</sup>
Motor Weight	B Series	Wt	lb
			kg
Motor Weight	M Series	Wt	lb
			kg

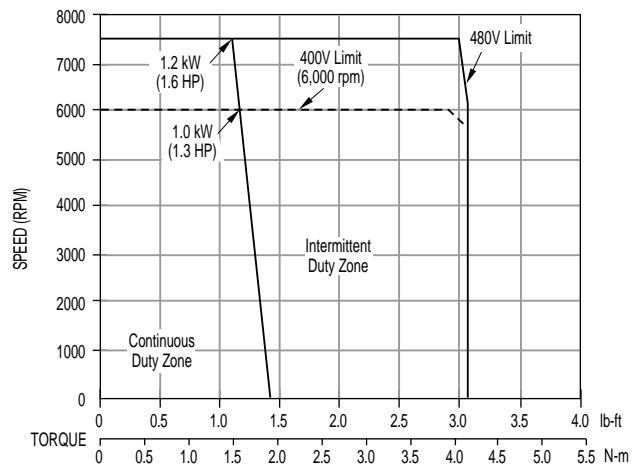

- All curves shown at 60 Hz input, derate max. speed and peak power by 15% for 50 Hz operation.

# Kollmorgen GOLDLINE BH/MH and SERVOSTAR 600

## SYSTEM PERFORMANCE CURVES

### 4 ■ Motor BH-222-E or MH-223-E ■ Amplifier: S603

Performance Specification	Symbol	Units		
Cont. Torque at stall	Tc	lb-ft	1.5	
		N-m	2.1	
Peak Torque at stall	Tp	lb-ft	3.5	
		N-m	4.8	
Cont. Power @480V		HP rated	1.9	
		kW rated	1.4	
Max. Speed	N	RPM	7000	
Motor Inertia	BH Series	Jm	lb-ft-s <sup>2</sup>	0.0000735
			kg-m <sup>2</sup>	0.0000996
	MH Series		lb-ft-s <sup>2</sup>	0.000617
			kg-m <sup>2</sup>	0.000836
Motor Weight	BH Series	Wt	lb	9.0
			kg	4.1
	MH Series		lb	11.0
			kg	5.0

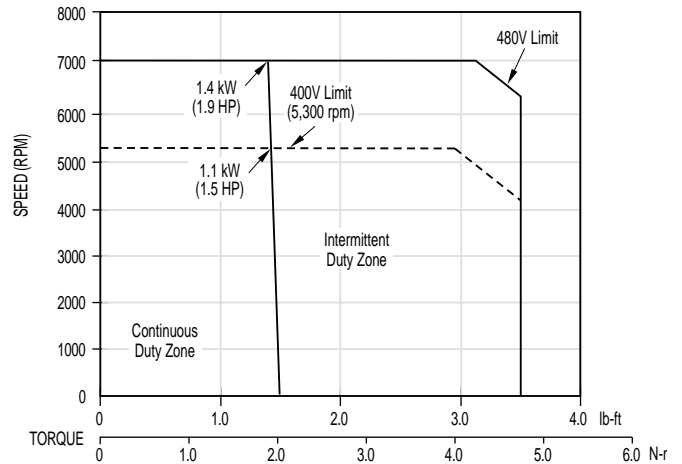

### 5 ■ Motor BH-224-G or MH-225-G ■ Amplifier: S603

Performance Specification	Symbol	Units		
Cont. Torque at stall	Tc	lb-ft	2.8	
		N-m	3.8	
Peak Torque at stall	Tp	lb-ft	5.4	
		N-m	7.3	
Cont. Power @480V		HP rated	2.1	
		kW rated	1.6	
Max. Speed	N	RPM	4600	
Motor Inertia	BH Series	Jm	lb-ft-s <sup>2</sup>	0.0001275
			kg-m <sup>2</sup>	0.0001729
	MH Series		lb-ft-s <sup>2</sup>	0.000843
			kg-m <sup>2</sup>	0.001143
Motor Weight	BH Series	Wt	lb	13.6
			kg	6.2
	MH Series		lb	16.0
			kg	7.3

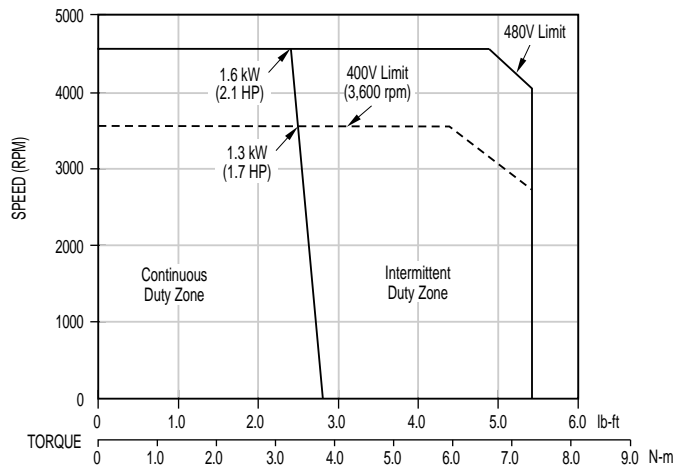

### 6 ■ Motor BH-226-C or MH-227-C ■ Amplifier: S606

Performance Specification	Symbol	Units		
Cont. Torque at stall	Tc	lb-ft	4.1	
		N-m	5.6	
Peak Torque at stall	Tp	lb-ft	10.5	
		N-m	14.2	
Cont. Power @480V		HP rated	2.9	
		kW rated	2.2	
Max. Speed	N	RPM	4900	
Motor Inertia	BH Series	Jm	lb-ft-s <sup>2</sup>	0.0001853
			kg-m <sup>2</sup>	0.0002512
	MH Series		lb-ft-s <sup>2</sup>	0.0013
			kg-m <sup>2</sup>	0.0018
Motor Weight	BH Series	Wt	lb	16.7
			kg	7.6
	MH Series		lb	21.0
			kg	9.5

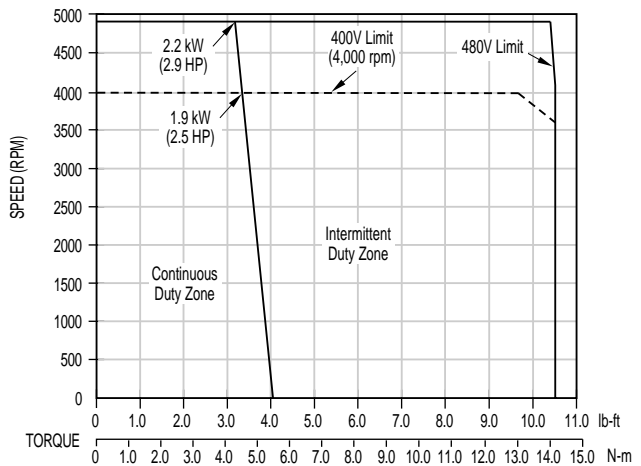

- All curves shown at 60 Hz input, derate max. speed and peak power by 15% for 50 Hz operation.

# Kollmorgen GOLDLINE BH/MH and SERVOSTAR 600

## SYSTEM PERFORMANCE CURVES

### 7 ■ Motor BH-226-E or MH-227-E ■ Amplifier: S603

Performance Specification	Symbol	Units		
Cont. Torque at stall	Tc	lb-ft	4.1	
		N-m	5.6	
Peak Torque at stall	Tp	lb-ft	7.7	
		N-m	10.5	
Cont. Power @480V	HP rated	HP	2.2	
	kW rated	kW	1.7	
Max. Speed	N	RPM	3200	
Motor Inertia	BH Series	Jm	lb-ft-s <sup>2</sup>	0.0001853
			kg-m <sup>2</sup>	0.0002512
	MH Series		lb-ft-s <sup>2</sup>	0.0013
			kg-m <sup>2</sup>	0.0018
Motor Weight	BH Series	Wt	lb	16.7
			kg	7.6
	MH Series		lb	21.0
			kg	9.5

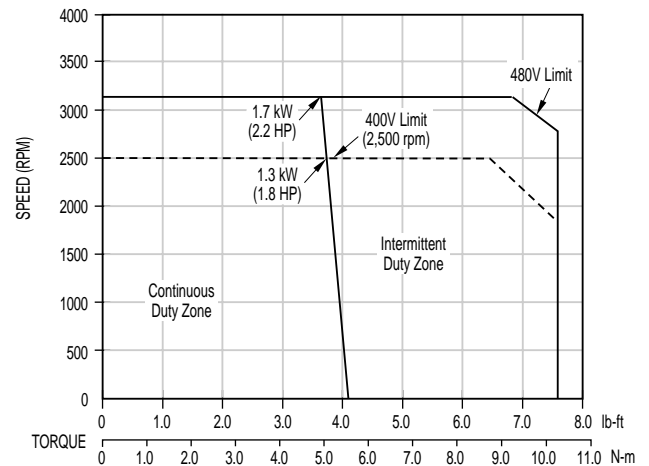

### 8 ■ Motor BH-422-D or MH-423-D ■ Amplifier: S606

Performance Specification	Symbol	Units		
Cont. Torque at stall	Tc	lb-ft	4.3	
		N-m	5.8	
Peak Torque at stall	Tp	lb-ft	12.2	
		N-m	16.5	
Cont. Power @480V	HP rated	HP	2.8	
	kW rated	kW	2.1	
Max. Speed	N	RPM	4600	
Motor Inertia	BH Series	Jm	lb-ft-s <sup>2</sup>	0.000238
			kg-m <sup>2</sup>	0.000323
	MH Series		lb-ft-s <sup>2</sup>	0.00191
			kg-m <sup>2</sup>	0.00259
Motor Weight	BH Series	Wt	lb	18.5
			kg	8.4
	MH Series		lb	23.0
			kg	10.5

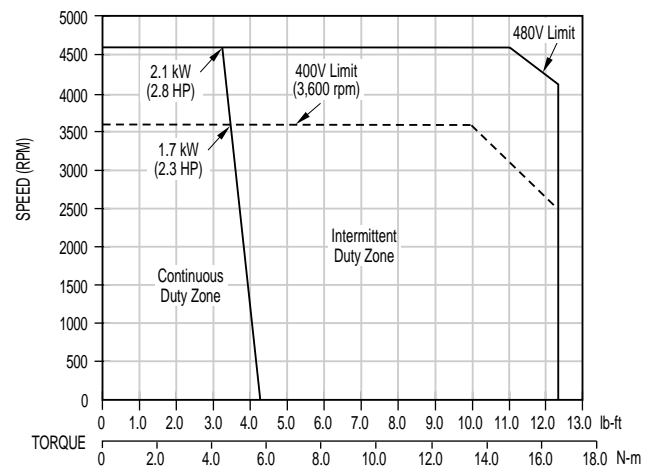

### 9 ■ Motor BH-424-D or MH-425-D ■ Amplifier: S606

Performance Specification	Symbol	Units		
Cont. Torque at stall	Tc	lb-ft	7.8	
		N-m	10.6	
Peak Torque at stall	Tp	lb-ft	14.7	
		N-m	20.0	
Cont. Power @480V	HP rated	HP	4.4	
	kW rated	kW	3.3	
Max. Speed	N	RPM	3700	
Motor Inertia	BH Series	Jm	lb-ft-s <sup>2</sup>	0.000484
			kg-m <sup>2</sup>	0.000656
	MH Series		lb-ft-s <sup>2</sup>	0.00325
			kg-m <sup>2</sup>	0.00441
Motor Weight	BH Series	Wt	lb	27.5
			kg	12.5
	MH Series		lb	34
			kg	15.5

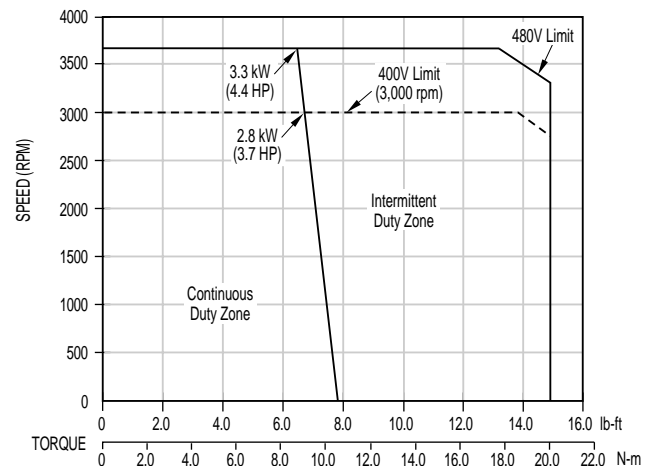

- All curves shown at 60 Hz input, derate max. speed and peak power by 15% for 50 Hz operation.

# Kollmorgen GOLDLINE BH/MH and SERVOSTAR 600

## SYSTEM PERFORMANCE CURVES

### 10 ■ Motor BH-426-B or MH-427-B ■ Amplifier: S610

Performance Specification	Symbol	Units		
Cont. Torque at stall	Tc	lb-ft	11.7	
		N-m	15.8	
Peak Torque at stall	Tp	lb-ft	27.4	
		N-m	37.1	
Cont. Power @480V	HP rated	HP	5.7	
	kW rated	kW	4.2	
Max. Speed	N	RPM	3200	
Motor Inertia	BH Series	Jm	lb-ft-s <sup>2</sup>	0.000685
			kg-m <sup>2</sup>	0.000929
	MH Series	Jm	lb-ft-s <sup>2</sup>	0.00485
			kg-m <sup>2</sup>	0.00657
Motor Weight	BH Series	Wt	lb	35.0
			kg	15.9
	MH Series	Wt	lb	44.0
			kg	20.0

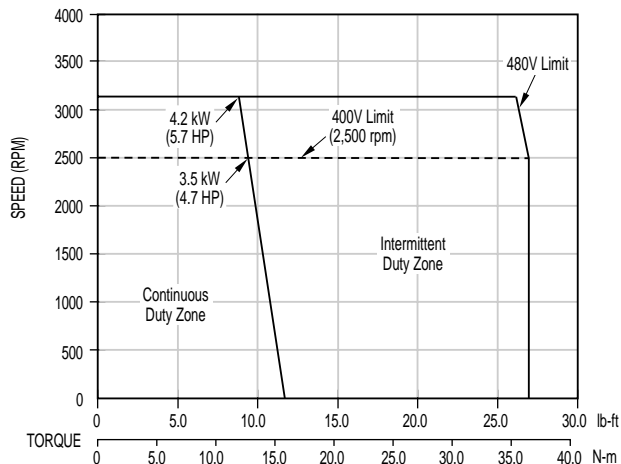

### 11 ■ Motor BH-426-C or MH-427-C ■ Amplifier: S614

Performance Specification	Symbol	Units		
Cont. Torque at stall	Tc	lb-ft	11.4	
		N-m	15.5	
Peak Torque at stall	Tp	lb-ft	24.5	
		N-m	33.2	
Cont. Power @480V	HP rated	HP	7.9	
	kW rated	kW	5.9	
Max. Speed	N	RPM	5000	
Motor Inertia	BH Series	Jm	lb-ft-s <sup>2</sup>	0.000685
			kg-m <sup>2</sup>	0.000929
	MH Series	Jm	lb-ft-s <sup>2</sup>	0.00485
			kg-m <sup>2</sup>	0.00657
Motor Weight	BH Series	Wt	lb	35.0
			kg	15.9
	MH Series	Wt	lb	44.0
			kg	20.0

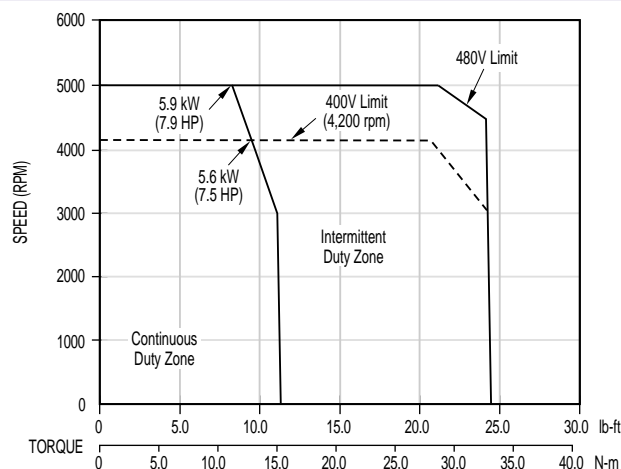

### 12 ■ Motor BH-622-A or MH-623-A ■ Amplifier: S606

Performance Specification	Symbol	Units		
Cont. Torque at stall	Tc	lb-ft	10.8	
		N-m	14.6	
Peak Torque at stall	Tp	lb-ft	29.5	
		N-m	40.0	
Cont. Power @480V	HP rated	HP	3.3	
	kW rated	kW	2.5	
Max. Speed	N	RPM	2000	
Motor Inertia	BH Series	Jm	lb-ft-s <sup>2</sup>	0.000758
			kg-m <sup>2</sup>	0.001028
	MH Series	Jm	lb-ft-s <sup>2</sup>	0.00572
			kg-m <sup>2</sup>	0.00775
Motor Weight	BH Series	Wt	lb	37.0
			kg	16.8
	MH Series	Wt	lb	44.0
			kg	20.0

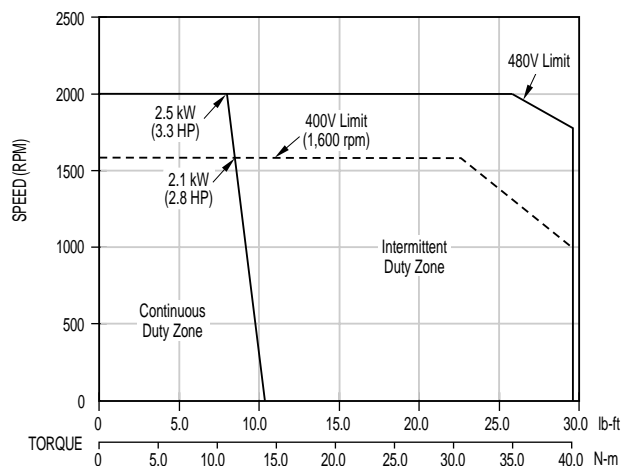



# Kollmorgen GOLDLINE BH/MH and SERVOSTAR 600

## SYSTEM PERFORMANCE CURVES

### 13 ■ Motor BH-622-B or MH-623-B ■ Amplifier: S610

Performance Specification	Symbol	Units		
Cont. Torque at stall	Tc	lb-ft	11.0	
		N-m	14.9	
Peak Torque at stall	Tp	lb-ft	24.7	
		N-m	33.5	
Cont. Power @480V	HP rated	HP	5.9	
	kW rated	kW	4.4	
Max. Speed	N	RPM	4000	
Motor Inertia	BH Series	Jm	lb-ft-s <sup>2</sup>	0.000758
			kg-m <sup>2</sup>	0.001028
	MH Series	Jm	lb-ft-s <sup>2</sup>	0.00572
			kg-m <sup>2</sup>	0.00775
Motor Weight	BH Series	Wt	lb	37.0
			kg	16.8
	MH Series	Wt	lb	44.0
			kg	20.0

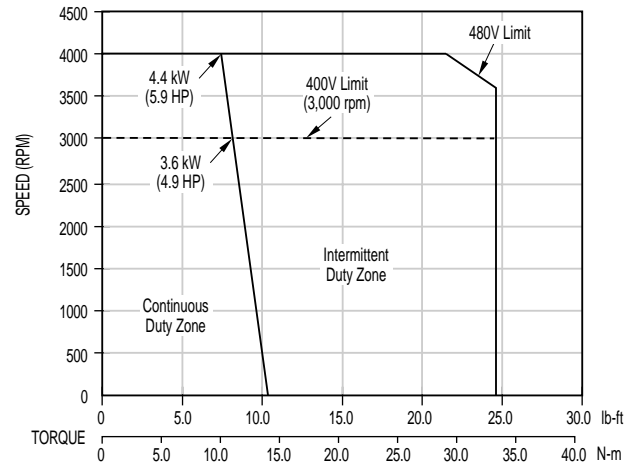

### 14 ■ Motor BH-624-C or MH-625-C ■ Amplifier: S620

Performance Specification	Symbol	Units		
Cont. Torque at stall	Tc	lb-ft	18.6	
		N-m	25.2	
Peak Torque at stall	Tp	lb-ft	41.4	
		N-m	56.2	
Cont. Power @480V	HP rated	HP	9.5	
	kW rated	kW	7.1	
Max. Speed	N	RPM	4500	
Motor Inertia	BH Series	Jm	lb-ft-s <sup>2</sup>	0.0015
			kg-m <sup>2</sup>	0.002034
	MH Series	Jm	lb-ft-s <sup>2</sup>	0.01037
			kg-m <sup>2</sup>	0.01406
Motor Weight	BH Series	Wt	lb	51.0
			kg	23.1
	MH Series	Wt	lb	63.0
			kg	28.6

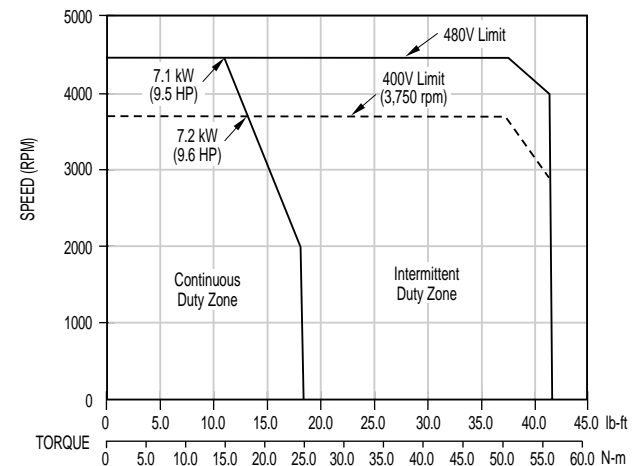

### 15 ■ Motor BH-624-D or MH-625-D ■ Amplifier: S614

Performance Specification	Symbol	Units		
Cont. Torque at stall	Tc	lb-ft	18.9	
		N-m	25.6	
Peak Torque at stall	Tp	lb-ft	40.4	
		N-m	54.8	
Cont. Power @480V	HP rated	HP	8.4	
	kW rated	kW	6.3	
Max. Speed	N	RPM	3300	
Motor Inertia	BH Series	Jm	lb-ft-s <sup>2</sup>	0.0015
			kg-m <sup>2</sup>	0.002034
	MH Series	Jm	lb-ft-s <sup>2</sup>	0.01037
			kg-m <sup>2</sup>	0.01406
Motor Weight	BH Series	Wt	lb	51.0
			kg	23.1
	MH Series	Wt	lb	63.0
			kg	28.6

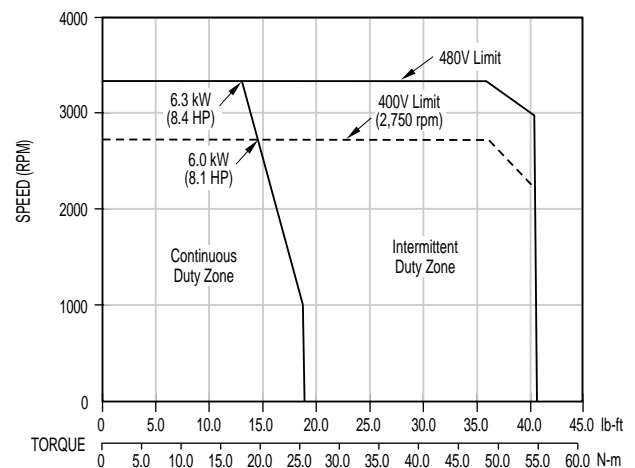

- All curves shown at 60 Hz input, derate max. speed and peak power by 15% for 50 Hz operation.

# Kollmorgen GOLDLINE BH/MH and SERVOSTAR 600

## SYSTEM PERFORMANCE CURVES

### 16 ■ Motor BH-624-E or MH-625-E ■ Amplifier: S614

Performance Specification	Symbol	Units		
Cont. Torque at stall	Tc	lb-ft	18.9	
		N-m	25.6	
Peak Torque at stall	Tp	lb-ft	34.6	
		N-m	46.9	
Cont. Power @480V		HP rated	9.8	
		kW rated	7.3	
Max. Speed	N	RPM	3850	
Motor Inertia	BH Series	Jm	lb-ft-s <sup>2</sup>	0.0015
			kg-m <sup>2</sup>	0.0020
	MH Series		lb-ft-s <sup>2</sup>	0.0104
			kg-m <sup>2</sup>	0.014
Motor Weight	BH Series	Wt	lb	51.0
			kg	23.1
	MH Series		lb	63.0
			kg	28.6

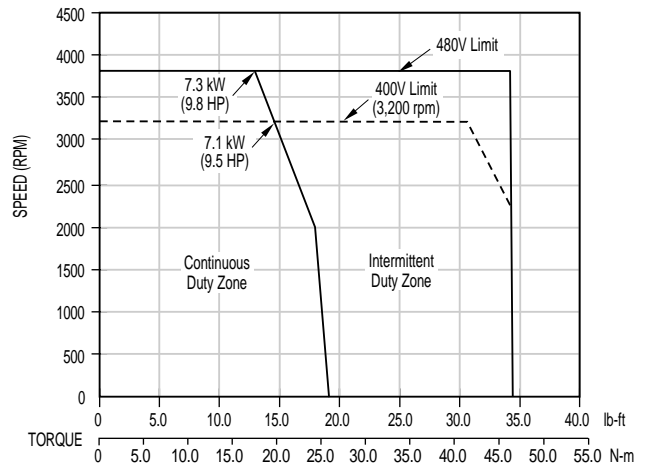

### 17 ■ Motor BH-624-G or MH-625-G ■ Amplifier: S610

Performance Specification	Symbol	Units		
Cont. Torque at stall	Tc	lb-ft	19.1	
		N-m	25.9	
Peak Torque at stall	Tp	lb-ft	63.6	
		N-m	86.2	
Cont. Power @480V		HP rated	6.2	
		kW rated	4.6	
Max. Speed	N	RPM	2600	
Motor Inertia	BH Series	Jm	lb-ft-s <sup>2</sup>	0.0015
			kg-m <sup>2</sup>	0.0020
	MH Series		lb-ft-s <sup>2</sup>	0.010
			kg-m <sup>2</sup>	0.014
Motor Weight	BH Series	Wt	lb	51.0
			kg	23.1
	MH Series		lb	63.0
			kg	28.6

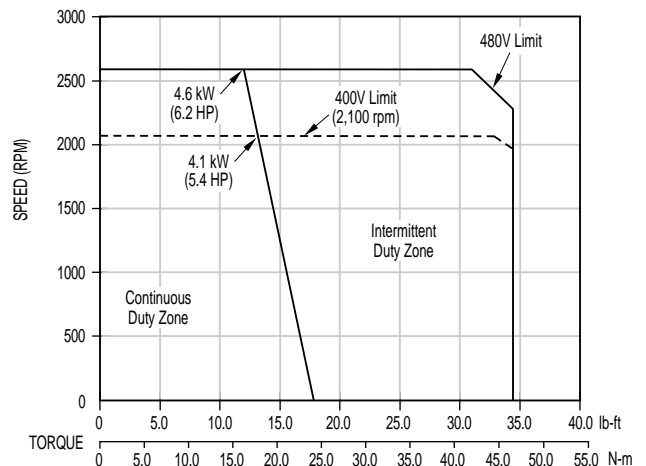

### 18 ■ Motor BH-626-C or MH-627-C ■ Amplifier: S610

Performance Specification	Symbol	Units		
Cont. Torque at stall	Tc	lb-ft	27.0	
		N-m	36.6	
Peak Torque at stall	Tp	lb-ft	61.1	
		N-m	82.9	
Cont. Power @480V		HP rated	6.5	
		kW rated	4.9	
Max. Speed	N	RPM	1550	
Motor Inertia	BH Series	Jm	lb-ft-s <sup>2</sup>	0.0022
			kg-m <sup>2</sup>	0.0030
	MH Series		lb-ft-s <sup>2</sup>	0.0156
			kg-m <sup>2</sup>	0.0212
Motor Weight	BH Series	Wt	lb	66.0
			kg	29.9
	MH Series		lb	83.0
			kg	37.6

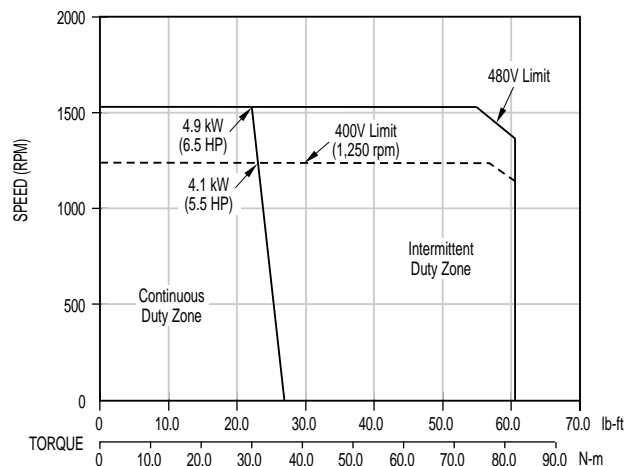

- All curves shown at 60 Hz input, derate max. speed and peak power by 15% for 50 Hz operation.

# Kollmorgen GOLDLINE BH/MH and SERVOSTAR 600

## SYSTEM PERFORMANCE CURVES

### 19 ■ Motor BH-626-E or MH-627-E ■ Amplifier: S620

Performance Specification	Symbol	Units		
Cont. Torque at stall	Tc	lb-ft	26.1	
		N-m	35.4	
Peak Torque at stall	Tp	lb-ft	50.2	
		N-m	68.0	
Cont. Power @480V	HP rated	HP	14.1	
	kW rated	kW	10.5	
Max. Speed	N	RPM	3700	
Motor Inertia	BH Series	Jm	lb-ft-s <sup>2</sup>	0.0022
			kg-m <sup>2</sup>	0.0030
	MH Series		lb-ft-s <sup>2</sup>	0.0156
			kg-m <sup>2</sup>	0.0212
Motor Weight	BH Series	Wt	lb	66.0
			kg	29.9
	MH Series		lb	83.0
			kg	37.6

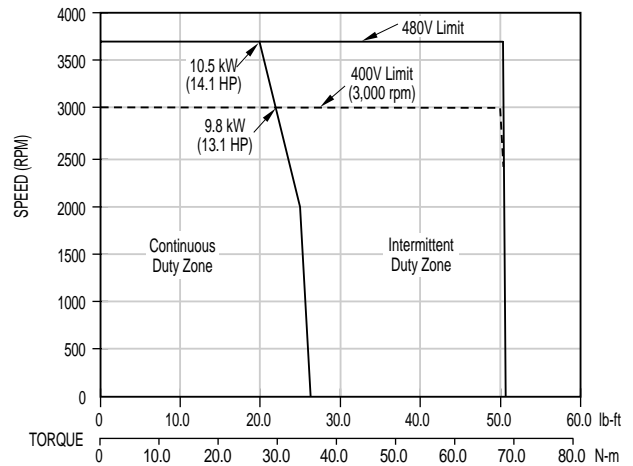

### 20 ■ Motor BH-822-C or MH-823-C ■ Amplifier: S610

Performance Specification	Symbol	Units		
Cont. Torque at stall	Tc	lb-ft	25.7	
		N-m	34.8	
Peak Torque at stall	Tp	lb-ft	60.2	
		N-m	81.6	
Cont. Power @480V	HP rated	HP	6.3	
	kW rated	kW	4.7	
Max. Speed	N	RPM	1600	
Motor Inertia	BH Series	Jm	lb-ft-s <sup>2</sup>	0.0036
			kg-m <sup>2</sup>	0.0049
	MH Series		lb-ft-s <sup>2</sup>	0.0259
			kg-m <sup>2</sup>	0.0351
Motor Weight	BH Series	Wt	lb	79.0
			kg	36.0
	MH Series		lb	96.0
			kg	43.7

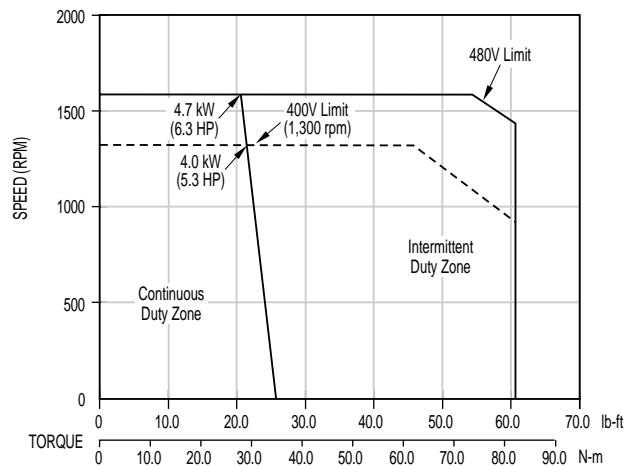

### 21 ■ Motor BH-822-D or MH-823-D ■ Amplifier: S620

Performance Specification	Symbol	Units		
Cont. Torque at stall	Tc	lb-ft	25.6	
		N-m	34.7	
Peak Torque at stall	Tp	lb-ft	53.6	
		N-m	72.7	
Cont. Power @480V	HP rated	HP	11.4	
	kW rated	kW	8.5	
Max. Speed	N	RPM	3000	
Motor Inertia	BH Series	Jm	lb-ft-s <sup>2</sup>	0.0036
			kg-m <sup>2</sup>	0.0049
	MH Series		lb-ft-s <sup>2</sup>	0.0259
			kg-m <sup>2</sup>	0.0351
Motor Weight	BH Series	Wt	lb	79.0
			kg	36.0
	MH Series		lb	96.0
			kg	43.5

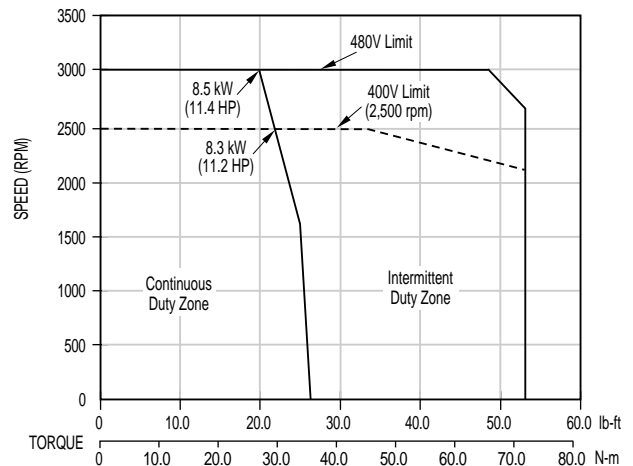

- All curves shown at 60 Hz input, derate max. speed and peak power by 15% for 50 Hz operation.

# Kollmorgen GOLDLINE BH/MH and SERVOSTAR 600

## SYSTEM PERFORMANCE CURVES

### 22 ■ Motor BH-826-A or MH-827-A ■ Amplifier: S620

Performance Specification	Symbol	Units		
Cont. Torque at stall	Tc	lb-ft	69.0	
		N-m	93.5	
Peak Torque at stall	Tp	lb-ft	120.1	
		N-m	162.8	
Cont. Power @480V	HP rated	HP	15.3	
		kW rated	11.4	
Max. Speed	N	RPM	1500	
Motor Inertia	BH Series	Jm	lb-ft-s <sup>2</sup>	0.0093
			kg-m <sup>2</sup>	0.0126
Motor Inertia	MH Series	Jm	lb-ft-s <sup>2</sup>	0.0655
			kg-m <sup>2</sup>	0.0888
Motor Weight	BH Series	Wt	lb	147.0
			kg	66.7
Motor Weight	MH Series	Wt	lb	190.0
			kg	86.2

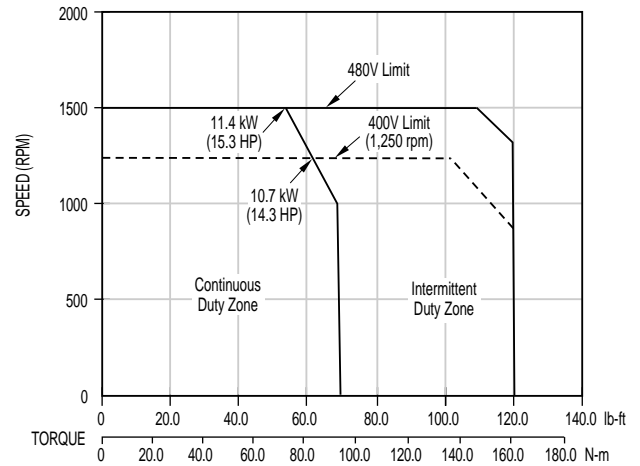

- All curves shown at 60 Hz input, derate max. speed and peak power by 15% for 50 Hz operation.

# Kollmorgen GOLDLINE BH/MH

## DIMENSIONS

### BH/MH-12x

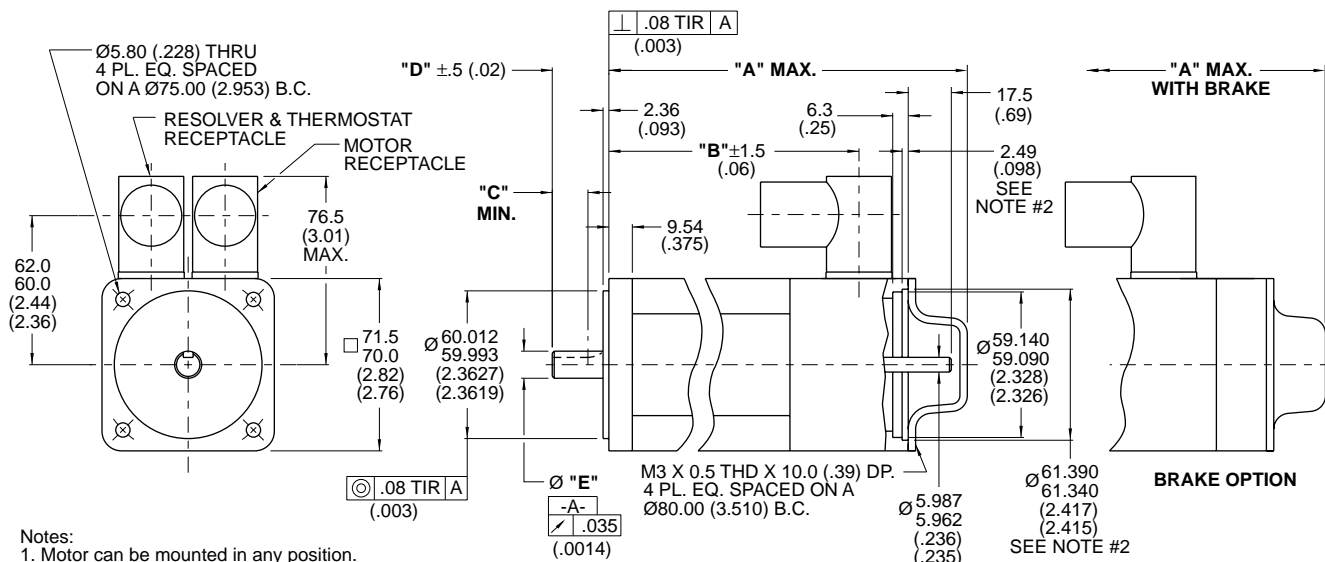

**Notes:**

1. Motor can be mounted in any position.
2. Counterbore for o-ring seal.
3. -61 and -71 models have been certified to meet IP65 sealing. -S model has been certified to meet IP67 sealing and has viton shaft seal and viton o-rings.
4. -63 and -73 models meet sealing specs except for mounting face.
5. Kollmorgen approved mating plugs with filler plugs must be installed before motor meets sealing specs.
6. Customer shaft key supplied with motor.
7. Dimensions in parentheses ( ) are in English and are for reference only.
8. Tolerances unless otherwise specified:

Metric: X decimal place  $\pm .4$  English: XX decimal places  $\pm .015$   
 XX decimal places  $\pm .13$  XXX decimal places  $\pm .005$

**KEYWAY DETAIL**

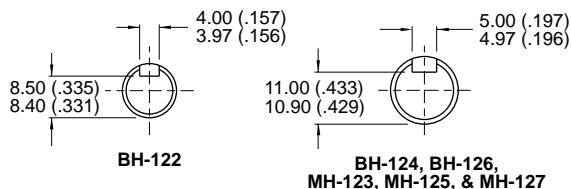

Model	"A" MAX.		"B"	"C"	"D"	"E"
	without brake	with brake				
BH-122	204.0 (8.03)	243.8 (9.59)	159.0 (6.26)	18.0 (0.71)	23.0 (0.90)	10.997-11.008 (.4330-.4334)
BH-124	234.5 (9.23)	273.2 (10.76)	189.5 (7.46)	20.0 (0.79)	30.0 (1.18)	13.997-14.008 (.5511-.5515)
BH-126	265.0 (10.43)	303.7 (11.96)	220.0 (8.66)	20.0 (0.79)	30.0 (1.18)	13.997-14.008 (.5511-.5515)
MH-123	241.0 (9.49)	279.6 (11.01)	196.0 (7.72)	20.0 (0.79)	30.0 (1.18)	13.997-14.008 (.5511-.5515)
MH-125	283.1 (11.15)	321.7 (12.67)	238.1 (9.37)	20.0 (0.79)	30.0 (1.18)	13.997-14.008 (.5511-.5515)
MH-127	335.5 (13.21)	374.1 (14.73)	290.5 (11.44)	20.0 (0.79)	30.0 (1.18)	13.997-14.008 (.5511-.5515)

Standard Options		
Model No.	Mating Plugs	Shaft Seal
-61	No	Yes
-63	No	No
-71	Yes	Yes
-73	Yes	No

### CONNECTOR PIN OUTS

**Connections:**

**Motor Receptacle:  
INTERCONNECTRON  
LEOB0BKNNNN000**

- Pin 3 - Phase W (brown)
- Pin 4 - Phase V (red)
- Pin 1 - Phase U (white)
- Pin 2 - Ground (green/yellow)
- Pin A - (Optional) Brake (blue)
- Pin B - (Optional) Brake (blue)  
(brake not polarity sensitive)

**Resolver & Thermostat Receptacle:  
INTERCONNECTRON  
SFMB12TNNNN000**

- Pin 3 - S3 (black), Sin Lo
- Pin 4 - S4 (blue), Cos Lo
- Pin 5 - R2 (yellow/white or black/white), Ref. Lo
- Pin 7 - S1 (red) Sin Hi
- Pin 8 - S2 (yellow) Cos Hi
- Pin 9 - R1 (red/white), Ref Hi
- Pin 2
- Pin 6 } **Thermostat:**  
Normally closed contacts  
4 Amp, 120 VAC - thermostat  
opens at 170°C  $\pm 5^\circ\text{C}$   
and closes at 132°C  $\pm 5^\circ\text{C}$   
(BH, MH-12x -- yellow leads)

# Kollmorgen GOLDLINE BH/MH

## DIMENSIONS

### BH/MH-22x

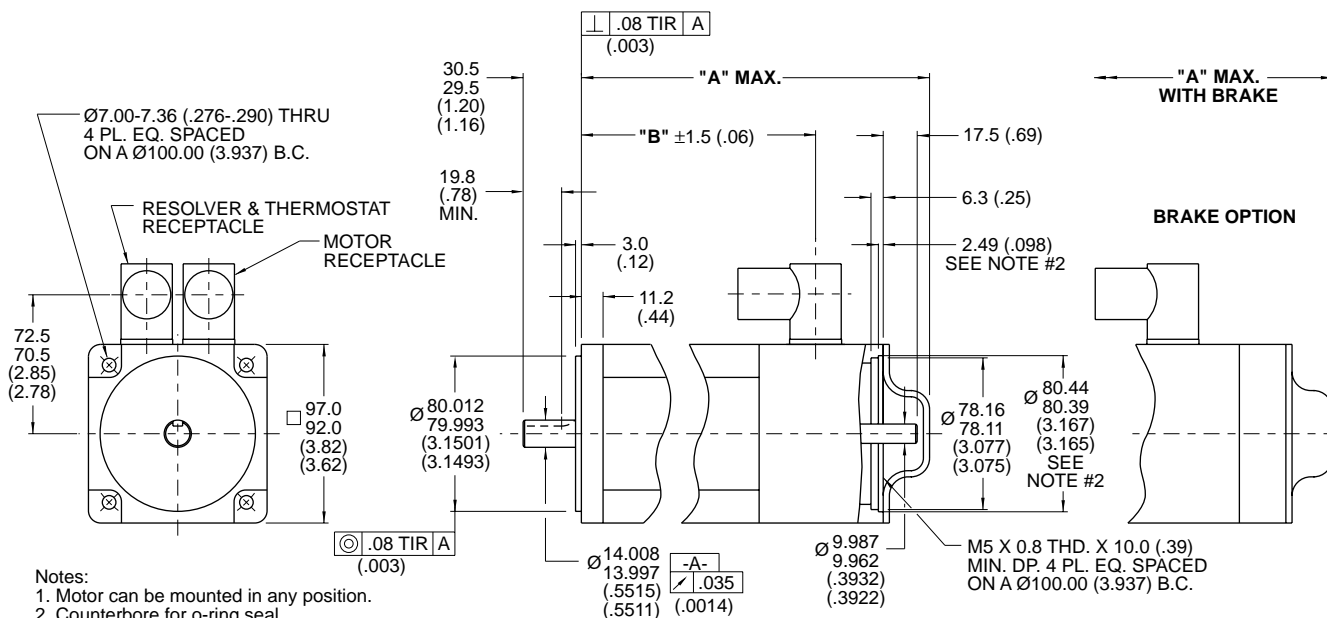

#### Notes:

- Motor can be mounted in any position.
- Counterbore for o-ring seal.
- 61 and -71 models have been certified to meet IP65 sealing. -S model has been certified to meet IP67 sealing and has viton shaft seal and viton o-rings.
- 63 and -73 models meet sealing specs except for mounting face.
- Kollmorgen approved mating plugs with filler plugs must be installed before motor meets sealing specs.
- Customer shaft key supplied with motor.
- Dimensions in parentheses ( ) are in English and are for reference only.
- Tolerances unless otherwise specified:  
Metric: X decimal place ±.4      English: XX decimal places ±.015  
          XX decimal places ±.13      XXX decimal places ±.005

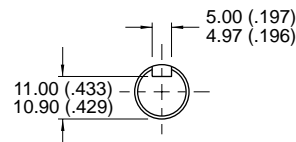

KEYWAY DETAIL

Model	"A" MAX.		"B"
	without brake	with brake	
BH-222	236.2 (9.30)	276.5 (10.89)	179.7 (7.08)
BH-224	275.8 (10.86)	316.1 (12.44)	219.3 (8.63)
BH-226	315.4 (12.42)	355.1 (14.00)	258.9 (10.19)
MH-223	275.8 (10.86)	316.0 (12.44)	219.3 (8.63)
MH-225	315.4 (12.42)	355.7 (14.00)	258.9 (10.19)
MH-227	373.2 (14.69)	413.4 (16.28)	316.7 (12.47)

Standard Options		
Model No.	Mating Plugs	Shaft Seal
-61	No	Yes
-63	No	No
-71	Yes	Yes
-73	Yes	No

## CONNECTOR PIN OUTS

#### Connections:

#### Motor Receptacle: INTERCONNECTRON LEOBOBKNNNNN000

Pin 3	- Phase W (brown)
Pin 4	- Phase V (red)
Pin 1	- Phase U (white)
Pin 2	- Ground (green/yellow)
Pin A	- (Optional) Brake (blue)
Pin B	- (Optional) Brake (blue) (brake not polarity sensitive)

#### Resolver & Thermostat Receptacle: INTERCONNECTRON SFMB12TNNNN000

Pin 3	- S3 (black), Sin Lo
Pin 4	- S4 (blue), Cos Lo
Pin 5	- R2 (yellow/white), Ref. Lo
Pin 7	- S1 (red) Sin Hi
Pin 8	- S2 (yellow) Cos Hi
Pin 9	- R1 (red/white), Ref Hi
Pin 2	} <b>Thermostat:</b> Normally closed contacts 4 Amp, 120 VAC - thermostat opens at 170°C ±5°C and closes at 132°C ±5°C (BH, MH-22x -- yellow leads)
Pin 6	

# Kollmorgen GOLDLINE BH/MH

## DIMENSIONS

### BH/MH-42x

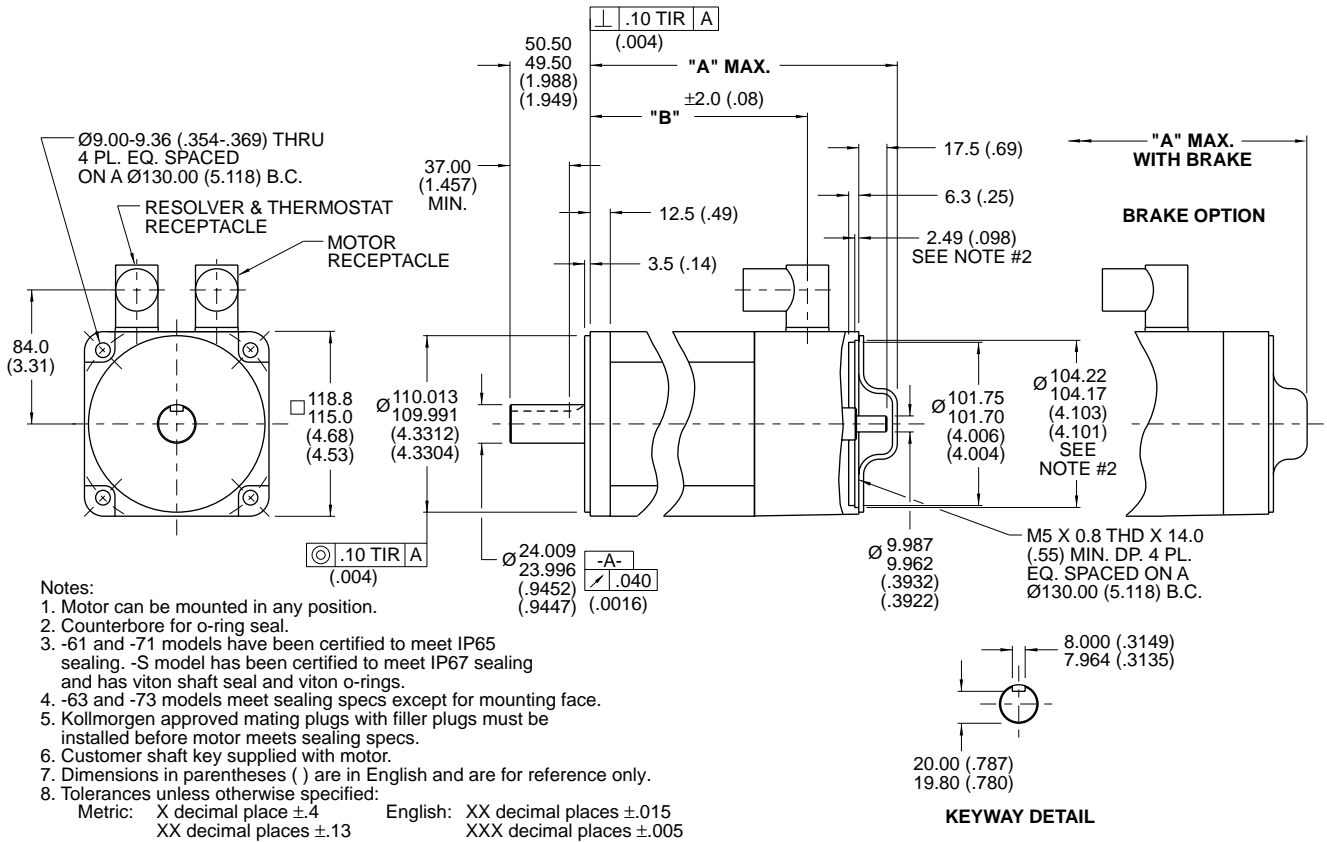

	"A" MAX.		"B"
	without brake	with brake	
BH-422	265.5 (10.45)	313.9 (12.36)	212.6 (8.37)
BH-424	318.8 (12.55)	367.3 (14.46)	265.9 (10.47)
BH-426	372.1 (14.65)	420.6 (16.56)	319.2 (12.57)
MH-423	318.8 (12.55)	367.3 (14.46)	265.9 (10.47)
MH-425	372.1 (14.65)	420.6 (16.56)	319.2 (12.57)
MH-427	444.9 (17.52)	493.4 (19.43)	392.0 (15.43)

Standard Options		
Model No.	Mating Plugs	Shaft Seal
-61	No	Yes
-63	No	No
-71	Yes	Yes
-73	Yes	No

## CONNECTOR PIN OUTS

### Connections:

#### Motor Receptacle: INTERCONNECTRON LEOBOKNNNNN000

Pin 3	- Phase W (brown)
Pin 4	- Phase V (red)
Pin 1	- Phase U (white)
Pin 2	- Ground (green/yellow)
Pin A	- (Optional) Brake (blue)
Pin B	- (Optional) Brake (blue) (brake not polarity sensitive)

#### Resolver & Thermostat Receptacle: INTERCONNECTRON SFMB12TNNNN000

Pin 3	- S3 (black), Sin Lo
Pin 4	- S4 (blue), Cos Lo
Pin 5	- R2 (yellow/white), Ref. Lo
Pin 7	- S1 (red) Sin Hi
Pin 8	- S2 (yellow) Cos Hi
Pin 9	- R1 (red/white), Ref Hi
Pin 2	} <b>Thermostat:</b> Normally closed contacts 4 Amp, 120 VAC - thermostat opens at 170°C $\pm 5^\circ\text{C}$ and closes at 132°C $\pm 5^\circ\text{C}$ (BH, MH-42x -- yellow leads)
Pin 6	

# Kollmorgen GOLDLINE BH/MH

## DIMENSIONS

### BH/MH-62x

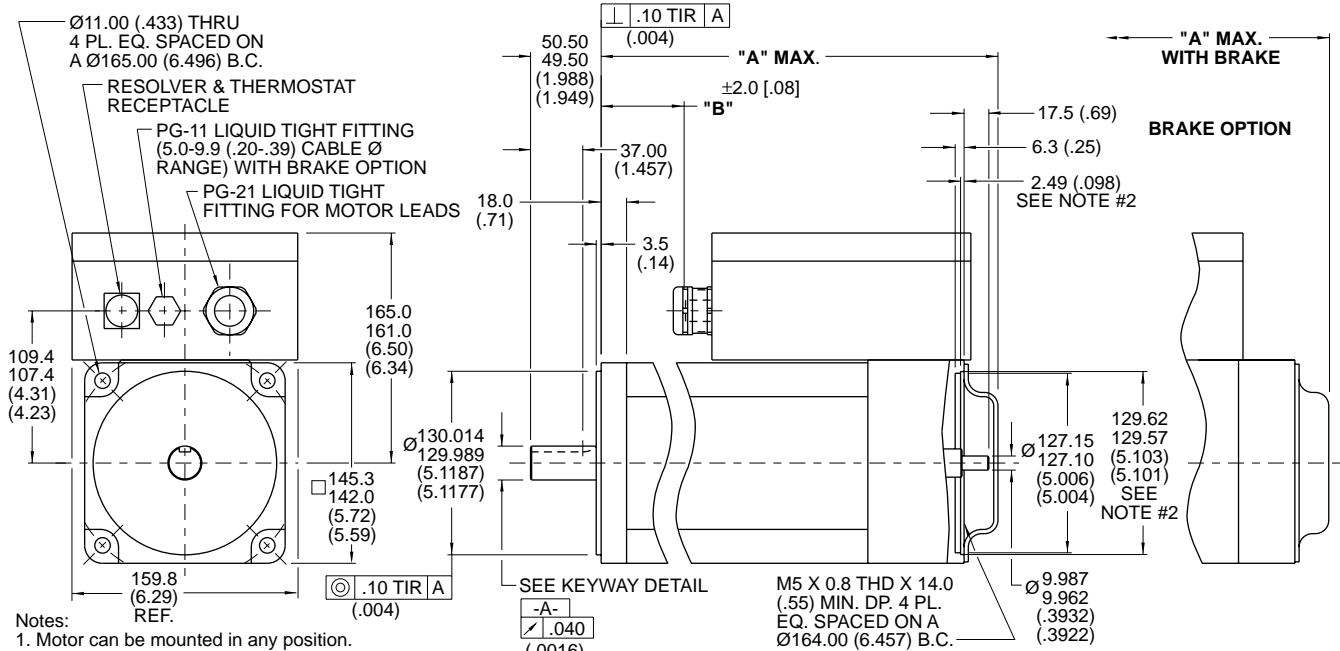

- Notes:
- Motor can be mounted in any position.
  - Counterbore for o-ring seal.
  - 41 and -51 models have been certified to meet IP65 sealing. -S model has been certified to meet IP67 sealing, except for PG-21, and has viton shaft seal and viton o-rings.
  - 43 and -53 models meet sealing specs except for mounting face.
  - Kollmorgen approved cables and mating plugs with filler plugs must be installed before motor meets sealing specs.
  - Customer shaft key supplied with motor.
  - Dimensions in parentheses ( ) are in English and are for reference only.
  - Tolerances unless otherwise specified:  
Metric: X decimal place  $\pm .4$  English: XX decimal places  $\pm .015$   
XX decimal places  $\pm .13$  XXX decimal places  $\pm .005$

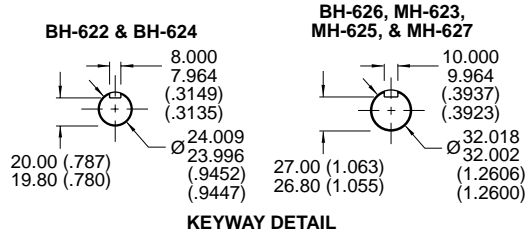

	"A" MAX.		"B"
	without brake	with brake	
BH-622	299.2 (11.79)	355.6 (14.00)	96.8 (3.81)
BH-624	367.8 (14.48)	424.2 (16.70)	165.4 (6.51)
BH-626	436.4 (17.18)	492.8 (19.40)	234.0 (9.21)
MH-623	367.8 (14.48)	424.3 (16.70)	165.4 (6.51)
MH-625	436.4 (17.18)	492.9 (19.41)	234.0 (9.21)
MH-627	531.5 (20.93)	588.0 (23.15)	329.1 (12.96)

Standard Options		
Model No.	Mating Plugs	Shaft Seal
-41	No	Yes
-43	No	No
-51	Yes	Yes
-53	Yes	No

### CONNECTOR PIN OUTS

#### Connections:

#### Motor Terminal Strip:

- Terminal **U** - white lead  
Terminal **V** - red lead  
Terminal **W** - brown lead

(M6 pan head screw with external tooth lockwasher is provided for use as a case ground.)

#### Brake Terminal Strip:

(2) blue leads

#### Resolver & Thermostat Receptacle:

#### INTERCONNECTRON SEFA12AMREN000

- Pin **3** - S3 (black), Sin Lo  
Pin **4** - S4 (blue), Cos Lo  
Pin **5** - R2 (yellow/white), Ref. Lo  
Pin **7** - S1 (red) Sin Hi  
Pin **8** - S2 (yellow) Cos Hi  
Pin **9** - R1 (red/white) Ref. Hi  
Pin **2**  
Pin **6**

#### Thermostat:

Normally closed contacts  
4 Amp, 120 VAC - thermostat opens at 170°C  $\pm 5^\circ\text{C}$  and closes at 132°C  $\pm 5^\circ\text{C}$  (BH, MH-62x -- yellow leads)



# Kollmorgen GOLDLINE BH/MH

## DIMENSIONS

### BH/MH-82x

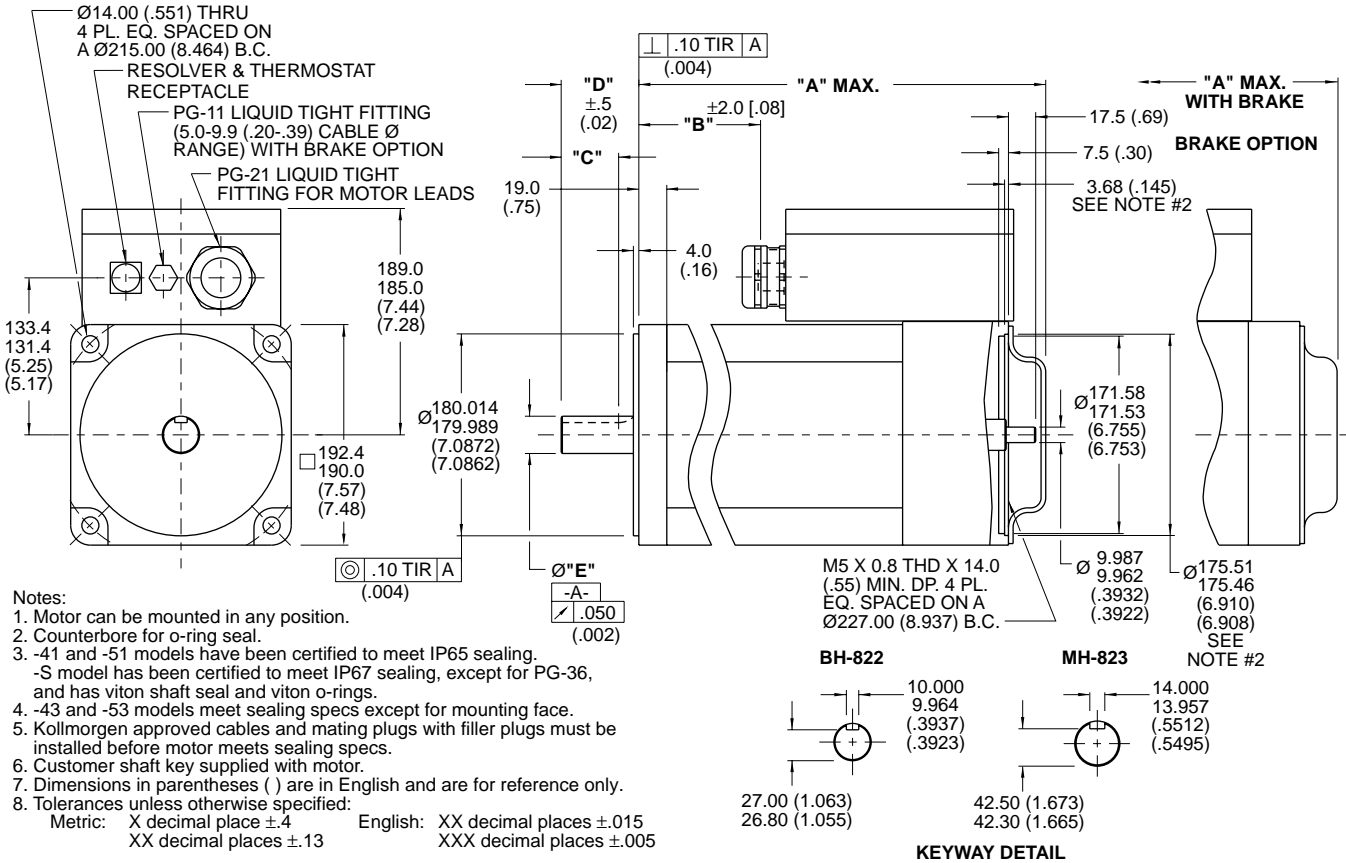

	"A" MAX.		"B"	"C"	"D"	"E"
	without brake	with brake				
BH-822	360.4 (14.19)	416.9 (16.41)	158.3 (6.23)	39.00 (1.535)	58.00 (2.283)	32.002-32.018 (1.2600-1.2606)
MH-823	449.9 (17.71)	506.4 (19.94)	247.8 (9.76)	54.00 (2.126)	82.00 (3.228)	48.002-48.018 (1.8898-1.8905)
BH-826	520.2 (20.48)	595.9 (23.46)	337.3 (13.28)	54.00 (2.126)	82.00 (3.228)	48.002-48.018 (1.8898-1.8905)
MH-827	648.7 (25.54)	686.0 (27.01)	446.6 (17.58)	54.00 (2.126)	82.00 (3.228)	48.002-48.018 (1.8898-1.8905)

Standard Options		
Model No.	Mating Plugs	Shaft Seal
-41	No	Yes
-43	No	No
-51	Yes	Yes
-53	Yes	No

### CONNECTOR PIN OUTS

<p><b>Connections:</b></p> <p><b>Motor Terminal Strip:</b></p> <p>Terminal <b>U</b> - white lead          Terminal <b>V</b> - red lead          Terminal <b>W</b> - brown lead</p> <p>(M6 pan head screw with external tooth lockwasher is provided for use as a case ground.)</p> <p><b>Brake Terminal Strip:</b>          (2) blue leads</p>	<p><b>Resolver &amp; Thermostat Receptacle:</b>  <b>INTERCONNECTRON SEFA12AMREN000</b></p> <p>Pin <b>3</b> - S3 (black), Sin Lo          Pin <b>4</b> - S4 (blue), Cos Lo          Pin <b>5</b> - R2 (yellow/white), Ref. Lo          Pin <b>7</b> - S1 (red) Sin Hi          Pin <b>8</b> - S2 (yellow) Cos Hi          Pin <b>9</b> - R1 (red/white) Ref. Hi</p> <p>Pin <b>2</b> } <b>Thermostat:</b>          Pin <b>6</b> } Normally closed contacts          4 Amp, 120 VAC - thermostat opens at 170°C ±5°C and closes at 132°C ±5°C (BH, MH-82x -- yellow leads)</p>
--	---

# Kollmorgen GOLDLINE BH/MH and SERVOSTAR 600

## SYSTEM SUMMARY

### System Summary and Configurations

*Motor	Continuous Torque lb-ft (N-m)	Peak Torque lb-ft (N-m)	Continuous Power HP (kW)	Max Speed RPM	Amplifier	Amplifier Cont/Peak Current (RMS/Phase)	**Cable Set	Curve Number
BH-122-A-61 MH-123-A-61	0.52 (0.70)	1.77 (2.40)	0.54 (0.41)	7500	S60301	3/6	CS-SS-RHG1HE-xx	1
BH-124-B-61 MH-125-B-61	1.00 (1.35)	3.10 (4.20)	1.11 (0.83)	7500	S60301	3/6	CS-SS-RHG1HE-xx	2
BH-126-B-61 MH-127-B-61	1.40 (1.90)	3.10 (4.20)	1.6 (1.2)	7500	S60301	3/6	CS-SS-RHG1HE-xx	3
BH-222-E-61 MH-223-E-61	1.5 (2.1)	3.5 (4.8)	1.9 (1.4)	7000	S60301	3/6	CS-SS-RHG1HE-xx	4
BH-224-G-61 MH-225-G-61	2.8 (3.8)	5.4 (7.3)	2.1 (1.6)	4600	S60301	3/6	CS-SS-RHG1HE-xx	5
BH-226-C-61 MH-227-C-61	4.1 (5.6)	10.5 (14.2)	2.9 (2.2)	4900	S60601	6/12	CS-SS-RHG1HE-xx	6
BH-226-E-61 MH-227-E-61	4.1 (5.6)	7.7 (10.5)	2.2 (1.7)	3200	S60301	3/6	CS-SS-RHG1HE-xx	7
BH-422-D-61 MH-423-D-61	4.3 (5.8)	12.2 (16.5)	2.8 (2.1)	4600	S60601	6/12	CS-SS-RHG1HE-xx	8
BH-424-D-61 MH-425-D-61	7.8 (10.6)	14.7 (20.0)	4.4 (3.3)	3700	S60601	6/12	CS-SS-RHG1HE-xx	9
BH-426-B-61 MH-427-B-61	11.7 (15.8)	27.4 (37.1)	5.7 (4.2)	3200	S61001	10/20	CS-SS-RHG1HE-xx	10
BH-426-C-61 MH-427-C-61	11.4 (15.5)	24.5 (33.2)	7.9 (5.9)	5000	S61401	14/28	CS-SS-RHG2HE-xx	11
BH-622-A-41 MH-623-A-41	10.8 (14.6)	29.5 (40.0)	3.3 (2.5)	2000	S60601	6/12	CS-SS-RHG2UE-xx	12
BH-622-B-41 MH-623-B-41	11.0 (14.9)	24.7 (33.5)	5.9 (4.4)	4000	S61001	10/20	CS-SS-RHG2UE-xx	13
BH-624-C-41 MH-625-C-41	18.6 (25.2)	41.4 (56.2)	9.5 (7.1)	4500	S62001	20/40	CS-SS-RHG2UE-xx	14
BH-624-D-41 MH-625-D-41	18.9 (25.6)	40.4 (54.8)	8.4 (6.3)	3300	S61401	14/28	CS-SS-RHG2UE-xx	15
BH-624-E-41 MH-625-E-41	18.2 (24.7)	34.5 (46.8)	9.8 (7.3)	3850	S61401	14/28	CS-SS-RHG2UE-xx	16
BH-624-G-41 MH-625-G-41	18.2 (24.7)	34.5 (46.8)	6.2 (4.6)	2600	S61001	10/20	CS-SS-RHG2UE-xx	17
BH-626-C-41 MH-627-C-41	27.0 (36.6)	61.1 (82.9)	6.5 (4.9)	1550	S61001	10/20	CS-SS-RHG2UE-xx	18
BH-626-E-41 MH-627-E-41	26.1 (35.4)	50.2 (68.0)	14.1 (10.5)	3700	S62001	20/40	CS-SS-RHG2UE-xx	19
BH-822-C-41 MH-823-C-41	25.7 (34.8)	60.2 (81.6)	6.3 (4.70)	1600	S61001	10/20	CS-SS-RHG2UE-xx	20
BH-822-D-41 MH-823-D-41	25.6 (34.7)	53.6 (72.7)	11.4 (8.5)	3000	S62001	20/40	CS-SS-RHG2UE-xx	21
BH-826-A-41 MH-827-A-41	69.0 (93.5)	120.1 (162.8)	15.3 (11.4)	1500	S62001	20/40	CS-SS-RHG2UE-xx	22

Notes: \*All motors have resolver feedback. \*\*Cable "xx" designation denotes length= 01, 03, 06, 09 meters

# Kollmorgen GOLDLINE BH/MH and SERVOSTAR 600

## ORDERING INFORMATION

	Model Number	Description
<b>External Regen Resistors (in housing):</b>	BAR-250	250 watts
	BAR-500	500 watts
	BAR-1500	1500 watts
<b>Communications Cables:</b>	A-97251-004	RS-232 (9 pin) communication cable
	A-SR6Y	Y- adapter cable with 5 DB9 connectors for connecting PC up to 4 drives, includes termination
<b>SERVOSTAR 600 Option Slot:</b>	I/O Extension Card	S6xxxx-EI

## Kollmorgen GOLDLINE® BH ORDERING INFORMATION

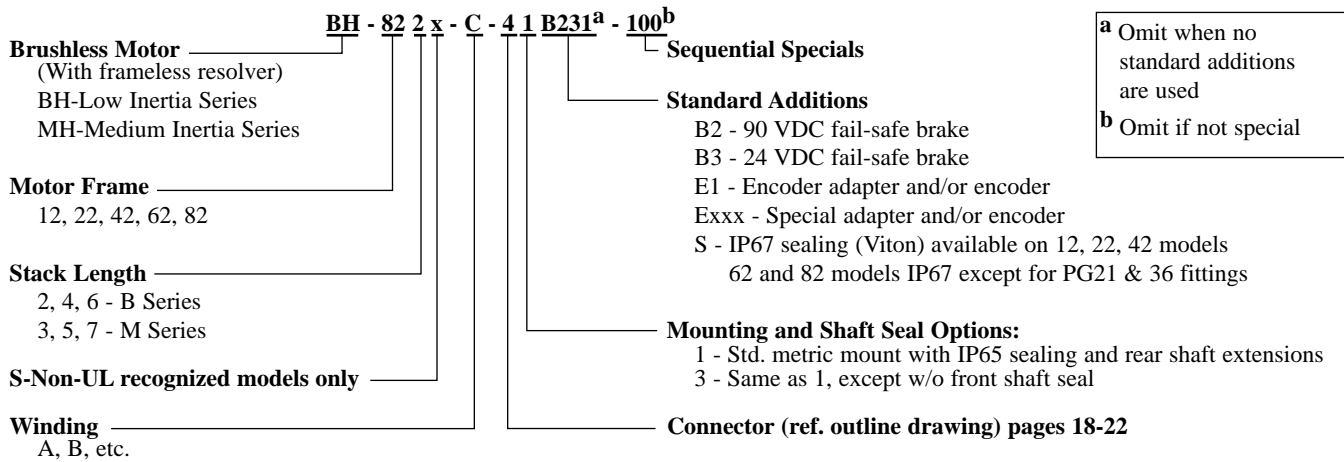

## SERVOSTAR 600 ORDERING INFORMATION

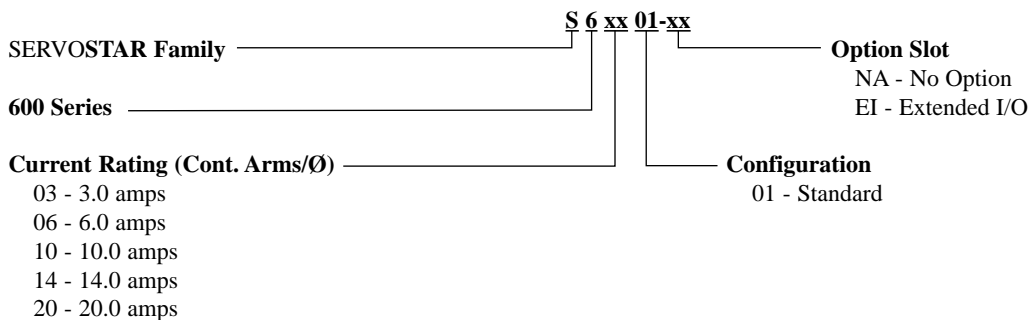

Note: BH/MH Series motors are available with custom mechanicals including special shafts and keyways. Contact the Kollmorgen Customer Support Network (1-800-77 SERVO) for more information.

## Kollmorgen Sales Offices

E-mail: [servo@kollmorgen.com](mailto:servo@kollmorgen.com)

Internet: <http://www.kollmorgen.com>

### Motion Technologies Group

1-800-77 SERVO

E-mail: [servo@kollmorgen.com](mailto:servo@kollmorgen.com)

#### Americas

Radford, VA

Tel: (800) 77 SERVO

Fax: (540) 639-1640

#### Europe & Middle East

Duesseldorf, Germany

Tel: (49) 203 9979 0

Fax: (49) 203 9979 155

#### Asia Pacific & Far East

Tianjin, China

Tel: (86) 22 2627 1090

Fax: (86) 22 2627 1093

## Kollmorgen Manufacturing Locations

#### Kollmorgen Artus

Avrillé, France

Ho Chi Minh City, Vietnam

#### Kollmorgen PMI

Commack, NY

#### Kollmorgen Electro-Optical

Northampton, MA

#### Kollmorgen Seidel

Duesseldorf, Germany

#### Kollmorgen Industrial Drives

Radford, VA

#### Kollmorgen Servotronic

Tel Aviv, Israel

#### Kollmorgen Inland Motor

Radford, VA

#### Kollmorgen Tandon Inc

Bombay, India

#### Kollmorgen Magnedyne

Vista, CA

#### Kollmorgen Tianjin Industrial Drives

Tianjin, China

Kollmorgen enjoys a reputation of excellence based on constant endeavors to update products. Information in this brochure is subject to change.

Windows is a registered trademark of Microsoft Corporation.  
Kollmorgen SERVOSTAR® 600, MOTIONLINK®, Kollmorgen GOLDLINE,  
and MOTIONEERING are trademarks of Kollmorgen.

# KOLLMORGEN