

SKiiP 11NAB126V1



MiniSKiiP[®] 1

3-phase bridge rectifier +
brake chopper + 3-phase
bridge inverter
SKiiP 11NAB126V1

Features

- Fast Trench IGBTs
- Robust and soft freewheeling diodes in CAL technology
- Highly reliable spring contacts for electrical connections
- UL recognised file no. E63532

Typical Applications*

- Inverter up to 8 kVA
- Typical motor power 4 kW

Remarks

- V_{CEsat} , V_F = chip level value

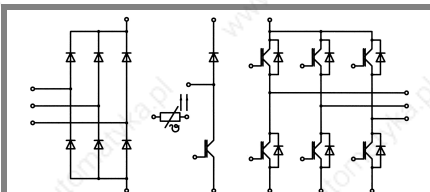

NAB

Absolute Maximum Ratings		$T_s = 25\text{ °C}$, unless otherwise specified		
Symbol	Conditions	Values	Units	
IGBT - Inverter, Chopper				
V_{CES}	$T_s = 25\text{ (70) °C}$	1200	V	
I_C		16 (15)	A	
I_{CRM}		16	A	
V_{GES}		± 20	V	
T_j		- 40 ... + 150	°C	
Diode - Inverter, Chopper				
I_F	$T_s = 25\text{ (70) °C}$	14 (11)	A	
I_{FRM}		16	A	
T_j		- 40 ... + 150	°C	
Diode - Rectifier				
V_{RRM}	$T_s = 70\text{ °C}$	1600	V	
I_F		35	A	
I_{FSM}		$t_p = 10\text{ ms, sin } 180\text{ °, } T_j = 25\text{ °C}$	220	A
i^2t		$t_p = 10\text{ ms, sin } 180\text{ °, } T_j = 25\text{ °C}$	240	A ² s
T_j		- 40 ... + 150	°C	
Module				
I_{tRMS}	per power terminal (20 A / spring)	20	A	
T_{stg}		- 40 ... + 125	°C	
V_{isol}	AC, 1 min.	2500	V	

Characteristics		$T_s = 25\text{ °C}$, unless otherwise specified			
Symbol	Conditions	min.	typ.	max.	Units
IGBT - Inverter, Chopper					
V_{CEsat}	$I_{Cnom} = 8\text{ A, } T_j = 25\text{ (125) °C}$		1,7 (2)	2,1 (2,4)	V
$V_{GE(th)}$	$V_{GE} = V_{CE}, I_C = 0,3\text{ mA}$	5	5,8	6,5	V
$V_{CE(TO)}$	$T_j = 25\text{ (125) °C}$		1 (0,9)	1,2 (1,1)	V
r_T	$T_j = 25\text{ (125) °C}$		87 (138)	113 (162)	mΩ
C_{ies}	$V_{CE} = 25\text{ V, } V_{GE} = 0\text{ V, } f = 1\text{ MHz}$		0,7		nF
C_{oes}	$V_{CE} = 25\text{ V, } V_{GE} = 0\text{ V, } f = 1\text{ MHz}$		0,1		nF
C_{res}	$V_{CE} = 25\text{ V, } V_{GE} = 0\text{ V, } f = 1\text{ MHz}$		0,1		nF
$R_{th(j-s)}$	per IGBT		1,5		K/W
$t_{d(on)}$	under following conditions		35		ns
t_r	$V_{CC} = 600\text{ V, } V_{GE} = \pm 15\text{ V}$		25		ns
$t_{d(off)}$	$I_{Cnom} = 8\text{ A, } T_j = 125\text{ °C}$		365		ns
t_f	$R_{Gon} = R_{Goff} = 50\text{ Ω}$		105		ns
E_{on}	inductive load		0,8		mJ
E_{off}			1		mJ
Diode - Inverter, Chopper					
$V_F = V_{EC}$	$I_{Fnom} = 8\text{ A, } T_j = 25\text{ (125) °C}$		1,9 (2)	2,2 (2,4)	V
$V_{(TO)}$	$T_j = 25\text{ (125) °C}$		1 (0,8)	1,1 (0,9)	V
r_T	$T_j = 25\text{ (125) °C}$		112 (150)	138 (187)	mΩ
$R_{th(j-s)}$	per diode		2,5		K/W
I_{RRM}	under following conditions		12		A
Q_{rr}	$I_{Fnom} = 8\text{ A, } V_R = 600\text{ V}$		1,8		μC
E_{rr}	$V_{GE} = 0\text{ V, } T_j = 125\text{ °C}$		0,9		mJ
	$di_F/dt = 520\text{ A/μs}$				
Diode - Rectifier					
V_F	$I_{Fnom} = 15\text{ A, } T_j = 25\text{ °C}$		1,1		V
$V_{(TO)}$	$T_j = 150\text{ °C}$		0,8		V
r_T	$T_j = 150\text{ °C}$		20		mΩ
$R_{th(j-s)}$	per diode		1,5		K/W
Temperature Sensor					
R_{ts}	3 %, $T_r = 25\text{ (100) °C}$		1000(1670)		Ω
Mechanical Data					
w			35		g
M_s	Mounting torque	2		2,5	Nm

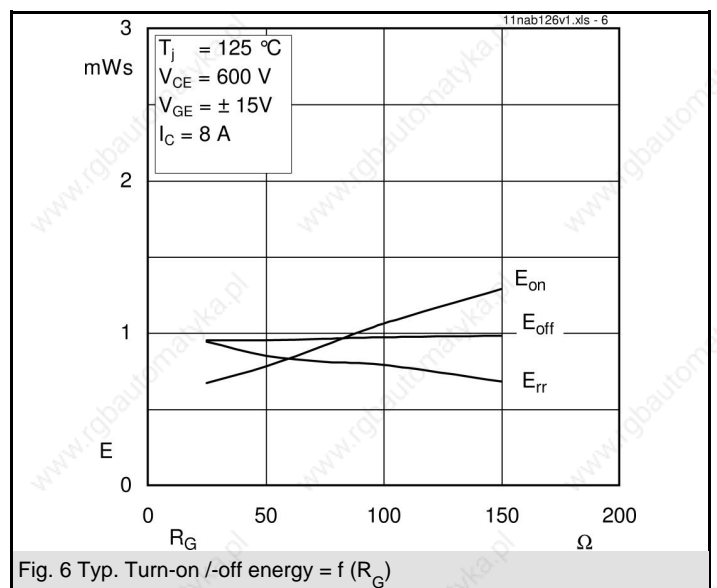
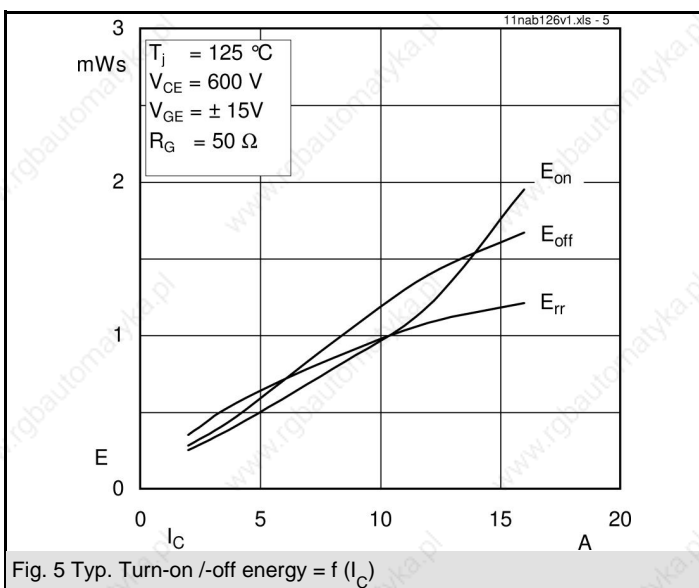
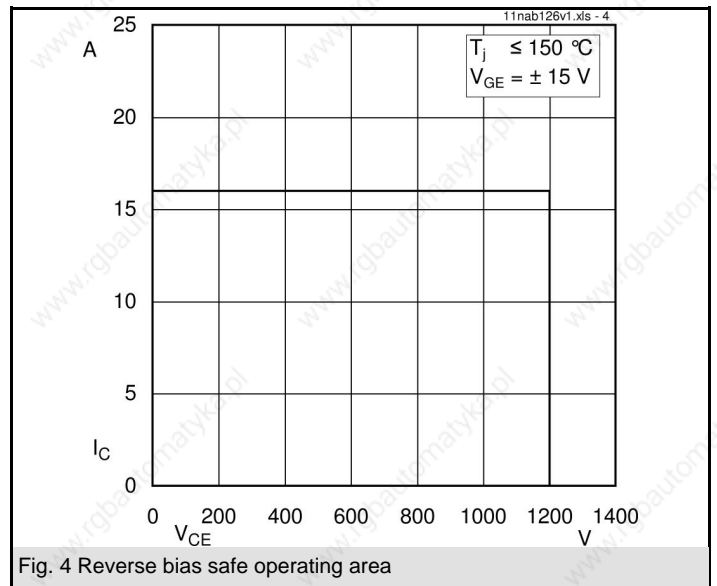
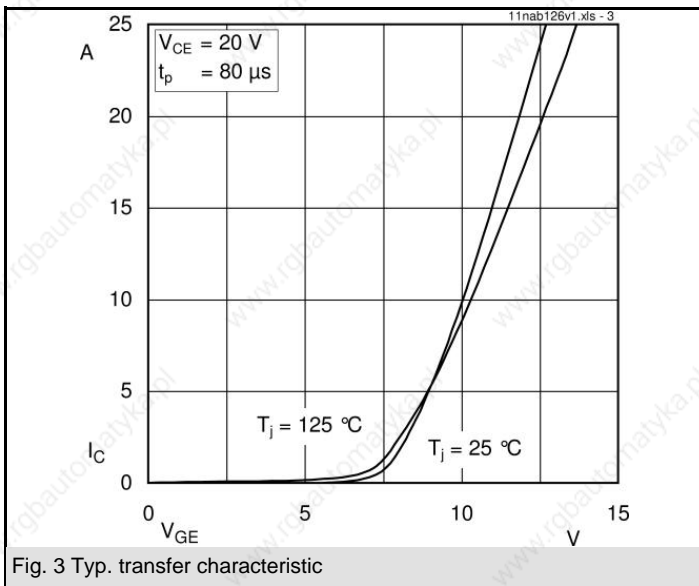
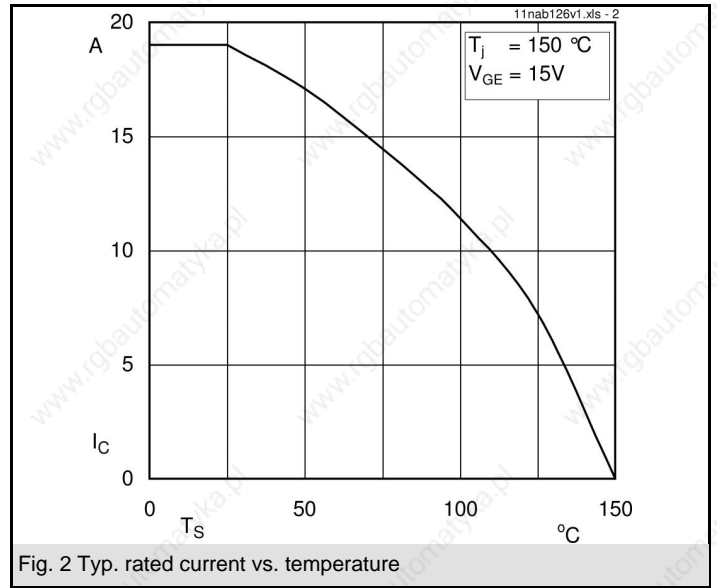
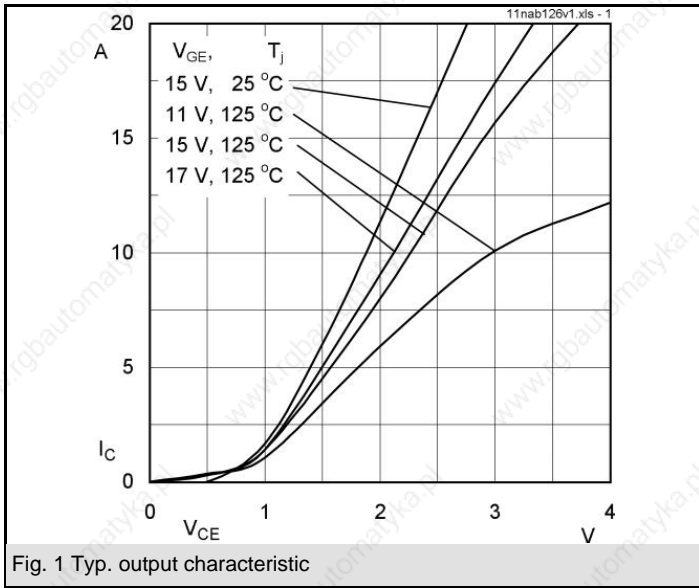

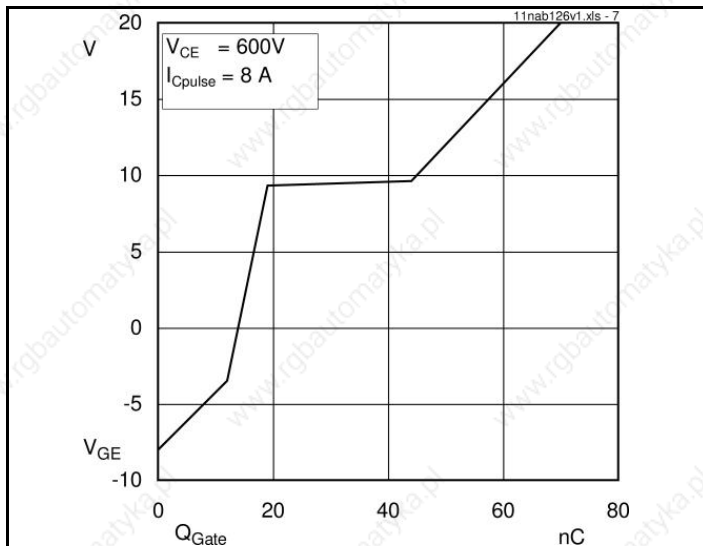

Fig. 7 Typ. gate charge characteristic

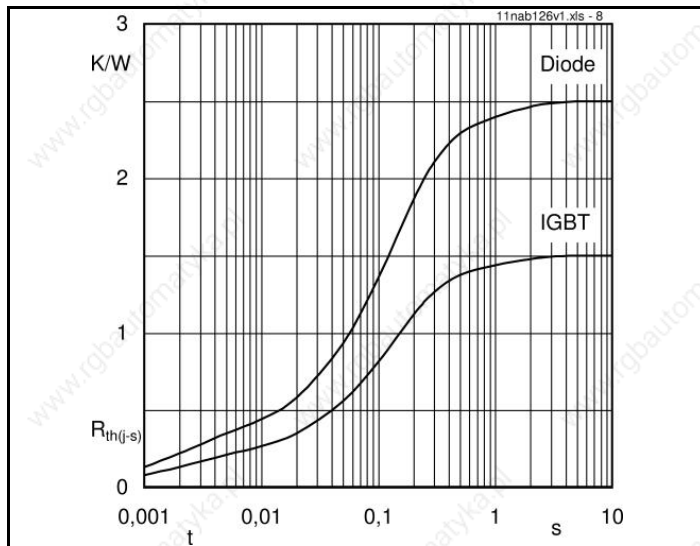

Fig. 8 Typ. thermal impedance

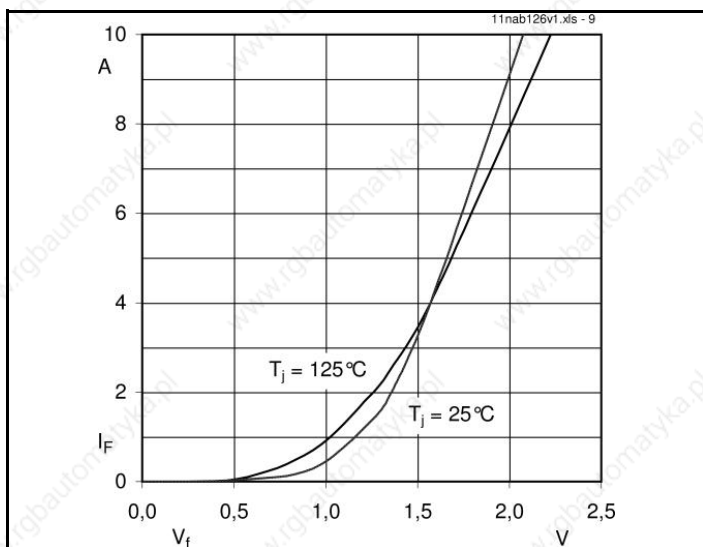

Fig. 9 Typ. freewheeling diode forward characteristic

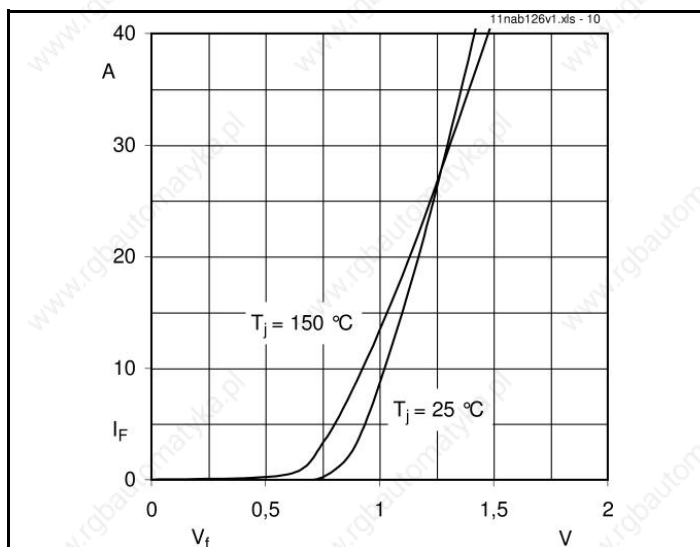
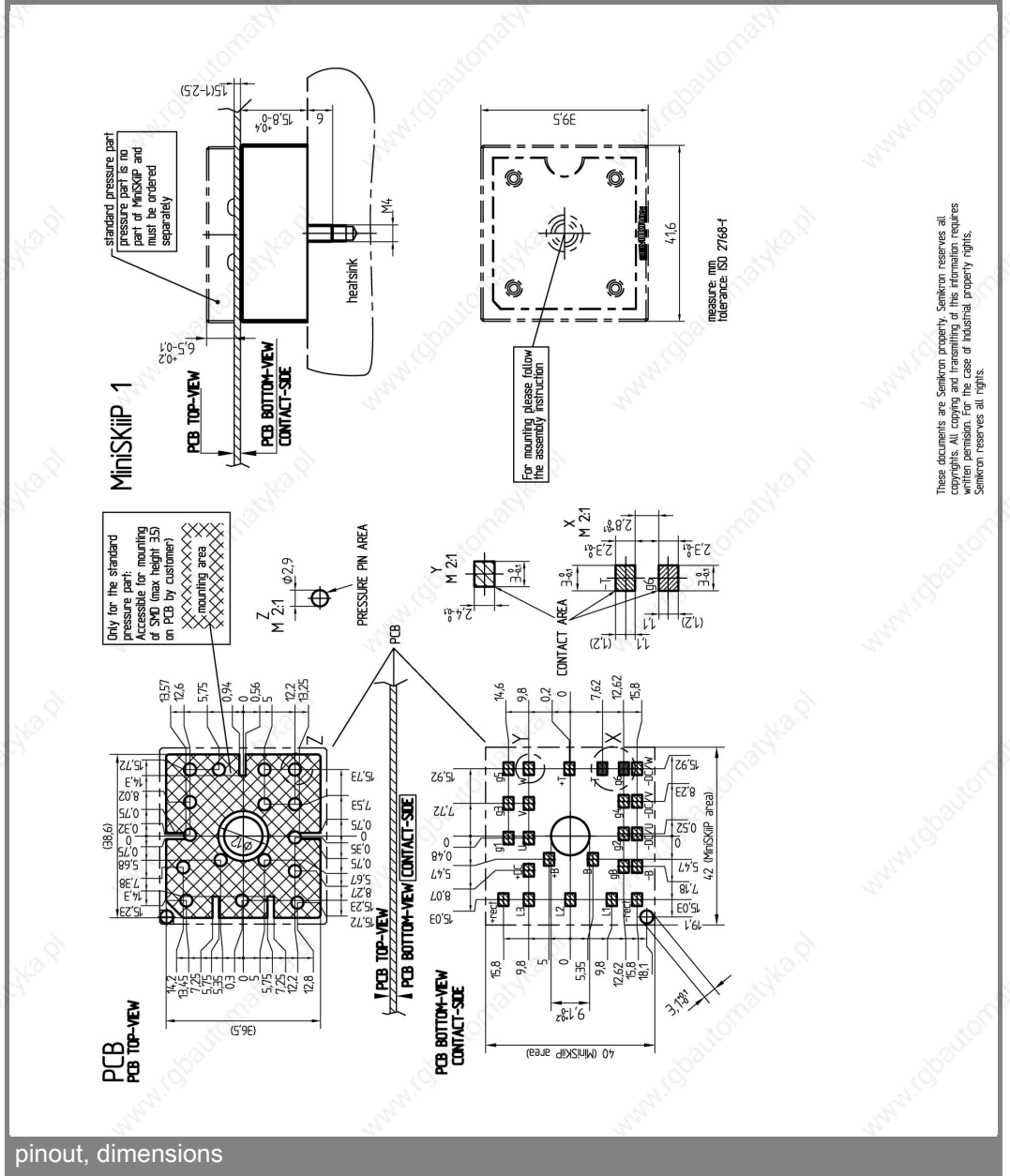
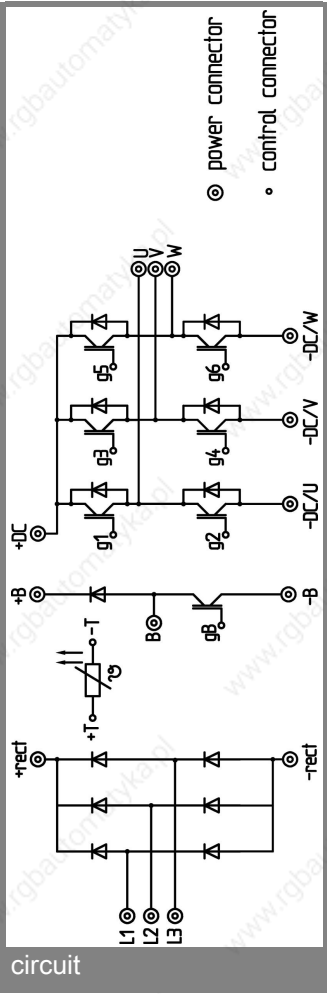

Fig. 10 Typ. input bridge forward characteristic

SKiiP 11NAB126V1



These documents are Semikron property. Semikron reserves all copyright and other intellectual property rights. Any use without written permission for the case of industrial property rights. Semikron reserves all rights.