

Electrical Connections of Main Spindle Drives

Project Planning Manual

DOK-GENERL-MAIN*EL*CON-PRJ1-EN-P



Titel Electrical Connections of Main Spindle Drives

Type of documentation: Project Planning Manual

Documenttype DOK-GENERL-MAIN*EL*CON-PRJ1-EN-E1,44

Internal file reference • 209-0042-4111-00

Reference This electronic document is based on the hardcopy document with document desig.: 209-0042-4111-00 EN/04.94

This documentation is used: This documentation serves:

- to introduce and categorize the connections of the main spindle drives,
- as a source for the circuit diagrams for not only the power connections but also the feedback and CNC connections when developing the machine circuit diagrams,
- to offer a table summary of assembled cables and their construction,
- to make customer-specific cables possible,
- to identify the plugs and cables supplied.

This documentation

- applies to all main spindle drives,
- correlates with the „Project Planning Notes“ for main spindle controllers and main spindle motors. This documentation can be referenced via text strings.

Change procedures

Designation of documentation up to present edition	Release-date	Comments
209-0042-4111-00 EN/04.94	Apr/94	First Edition
DOK-GENERL-MAIN*EL*CON-PRJ1-EN-E1,44	Jul./97	First E-Dok

Copyright © INDRAMAT GmbH, 1994

Copying of this document, and giving it to others and the use or communication of the contents thereof, are forbidden without express authority. Offenders are liable to the payment of damages.

All rights are reserved in the event of the grant of a patent or the registration of a utility model or design. (DIN 34-1)

The electronic documentation (E-doc) may be copied as often as needed if such are to be used by the consumer for the purpose intended.

Validity All rights reserved with respect to the content of this documentation and the availability of the products.

Publisher INDRAMAT GmbH • Bgm.-Dr.-Nebel-Straße 2 • D-97816 Lohr
Telefon 0 93 52 / 40-0 • Tx 689421 • Fax 0 93 52 / 40-48 85

Dept ENA (MR, FS)

Table of Contents	Page
1. Electrical Connections	7
1.1. Standardization	7
1.2. Types	10
1.3. Determination of Size and Guidelines	13
2. Power Connections	15
2.1. Motor-Controller Power Connections	15
2.1.1. Breakdown of the Types of Connections	16
2.1.2. Connection Plans for Direct Connections	19
2.1.3. Assembled Data List	29
2.1.4. Line Specifications	45
2.2. Power connections of the RAC three-phase mains	46
2.2.1. Three-Phase Mains Requirements	47
2.2.2. Connection Plans	49
2.2.3. Connecting Components Data List	52
3. Feedback and CNC Connections	56
3.1. Types of feedback and CNC connections	57
3.2. Connecting plans for direct connections	60
3.2.1. Motor feedback, high-resolution	61
3.2.2. Motor feedback, incremental encoder	63
3.2.3. Spindle Feedback, high-resolution	64
3.2.4. Spindle Feedback, incremental encoder	66
3.2.5. Lead Spindle Feedback	67
3.2.6. Control input, signal and analogue outputs, Bb-contact ...	68
3.2.7. Speed set-point, analogue +/- 10V	69
3.2.8. Speed set-point, digital, 16 bit parallel	70

3.2.9. SERCOS Interface	71
3.2.10. Position set-point, digital, 16 bit parallel	72
3.2.11. Serial interface RS 232C	73
3.2.12. Incremental encoder output	74
3.2.13. Control of the mains contactor integrated into the RAC controller	75
3.3. Assembled Cable Specifications	76
3.4. Line Specifications List	84
4. Installation Guidelines	85
5. Delivery, Identification, Storage	88
6. Customizing Specifications	91
7. Index	94
8. Supplementary Documentation	99

1. Electrical Connections

1.1. Standardization

The electrical connections in the entire INDRAMAT main spindle drive program have been standardized with the goal of reducing the range of cables available.

There are three categories of electrical connections:

- power connections
- feedback and CNC connections
- controller-specific connections

Power connections

The motor connections to the main spindle controller always have the same terminal assignment, regardless of the controller implemented. The cable cross sectional area is dependent on the motor power requirements.

The RAC controller is connected directly to the three-phase mains. The terminal assignments of the different RAC's are always the same. The cable cross sectional area is dependent on the current type of the respective RAC.

Feedback and CNC connections

Plug assignment is the same regardless of controller and motor type.

Controller-specific connections

The KDA/TDA controllers used in modular drive packages have controller-specific electrical connections. This documentation does not deal with their connection. It is dealt with in the documentation on main spindle controllers KDA 3.2, or TDA 1.1, „Project Planning Notes“. The cables needed are part of the electrical connecting accessories E...-DA.

The mains contactor and the respective control circuits are integrated into the RAC controllers for direct mains connection. The facility control system must operate this control circuit. The controller-specific connections are outlined in the mains connection plans in Section 2.2.

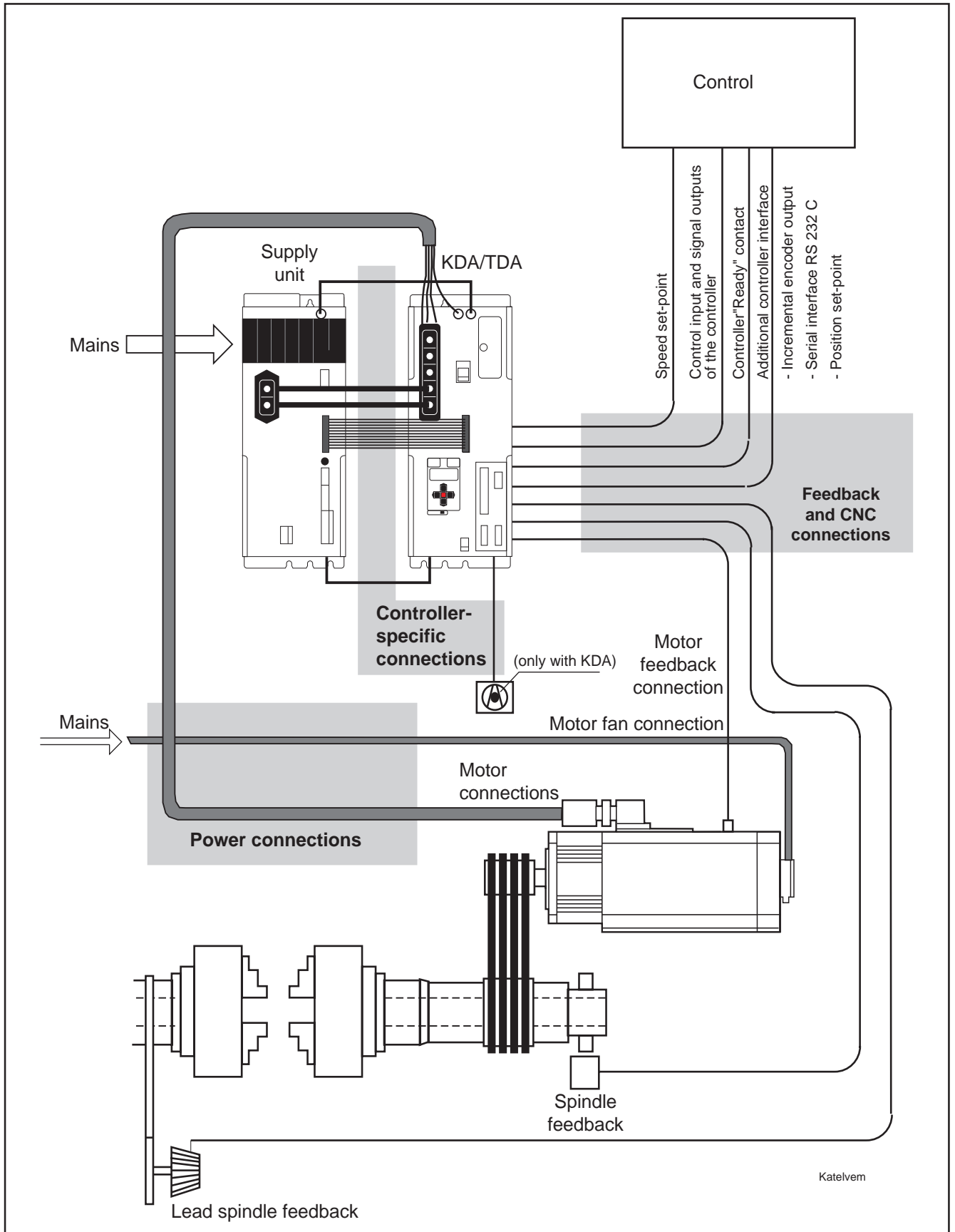

Figure 1.2: Categories of electrical connections for main spindle drives with KDA/TDA

1. Electrical Connections

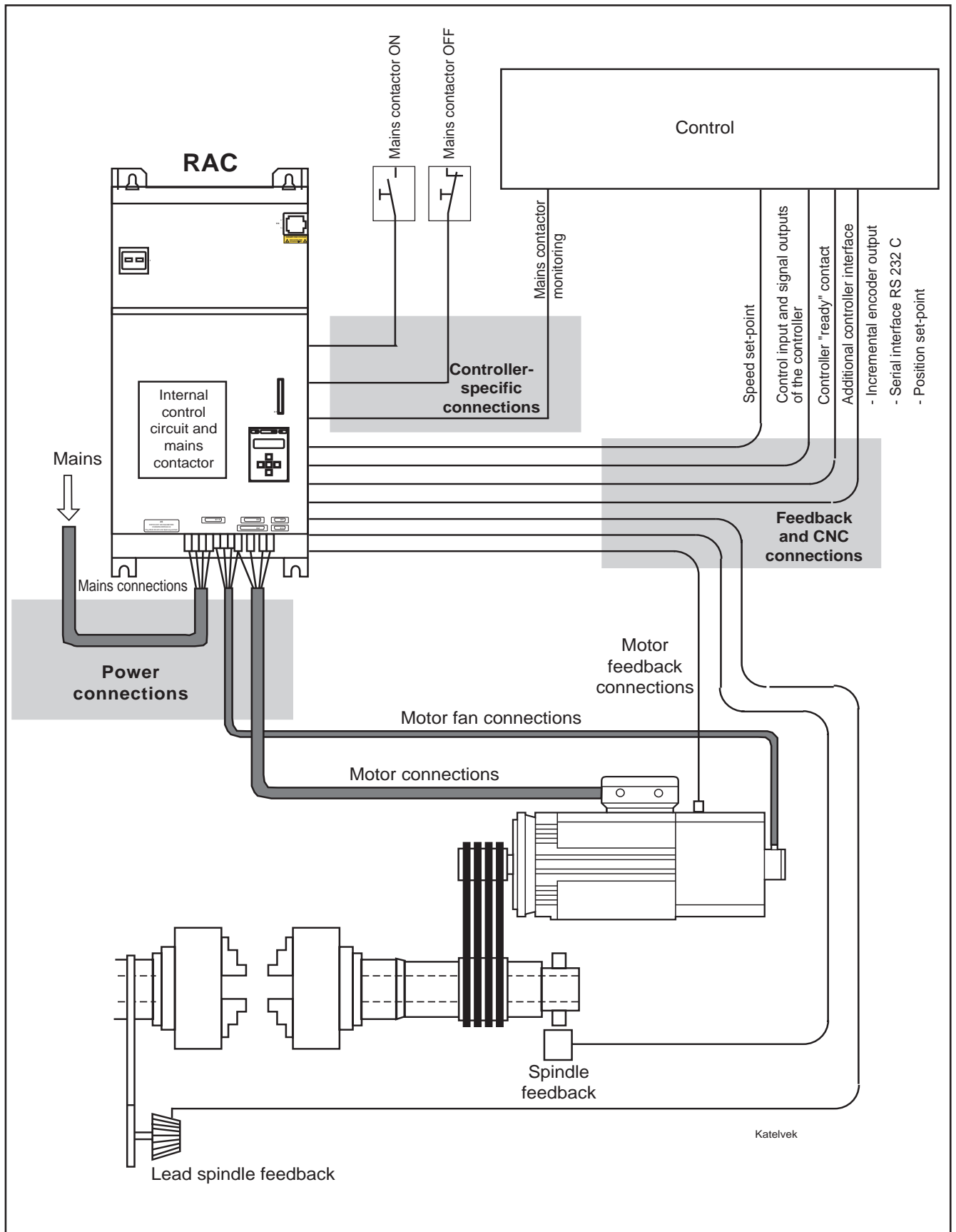

Figure 1.3: Categories of electrical connections for main spindle drives with RAC (here RAC 2.2)

Motor fans cannot be connected to the controller in main spindle drives with RAC3 and RAC4! They are connected directly to the three-phase mains via appropriate protective motor switches!

1.2. Types

The electrical connections of all categories are available as

- assembled (ready to use), or,
- components (individual parts, not ready to use).

Assembled cables are supplied in the lengths ordered and guarantee a quick and easy assembly of control cabinet and machine. If only assembled cables are used, then no additional cable and plug accessories are needed.

Component electrical connections are made up of individual, assembled parts. The specifications of these parts are listed in the table. These must then be assembled in accordance with the guidelines outlined in Section 5.

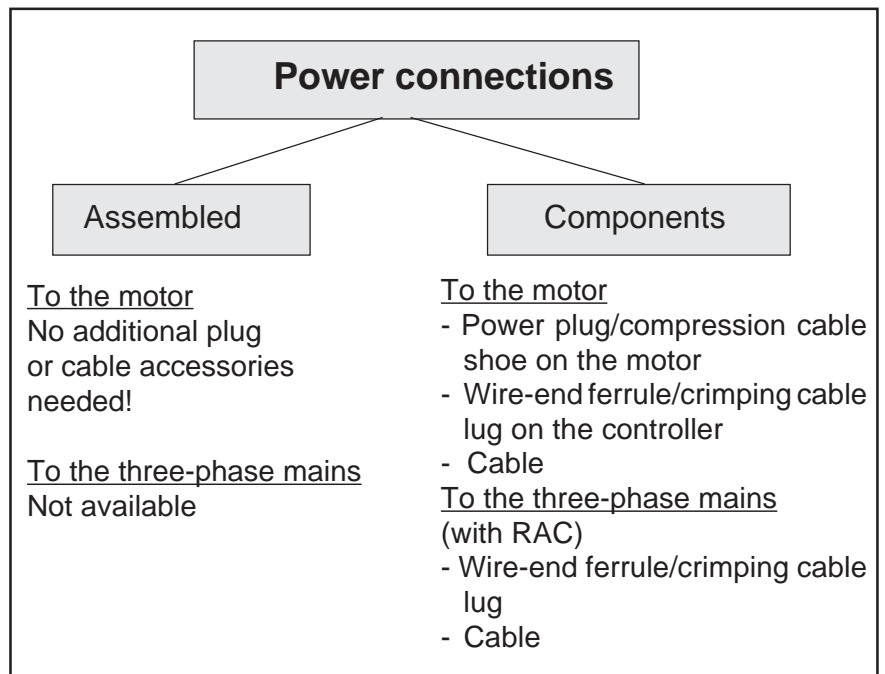

Figure 1.4: Specifications of the power connections with accessories referenced.

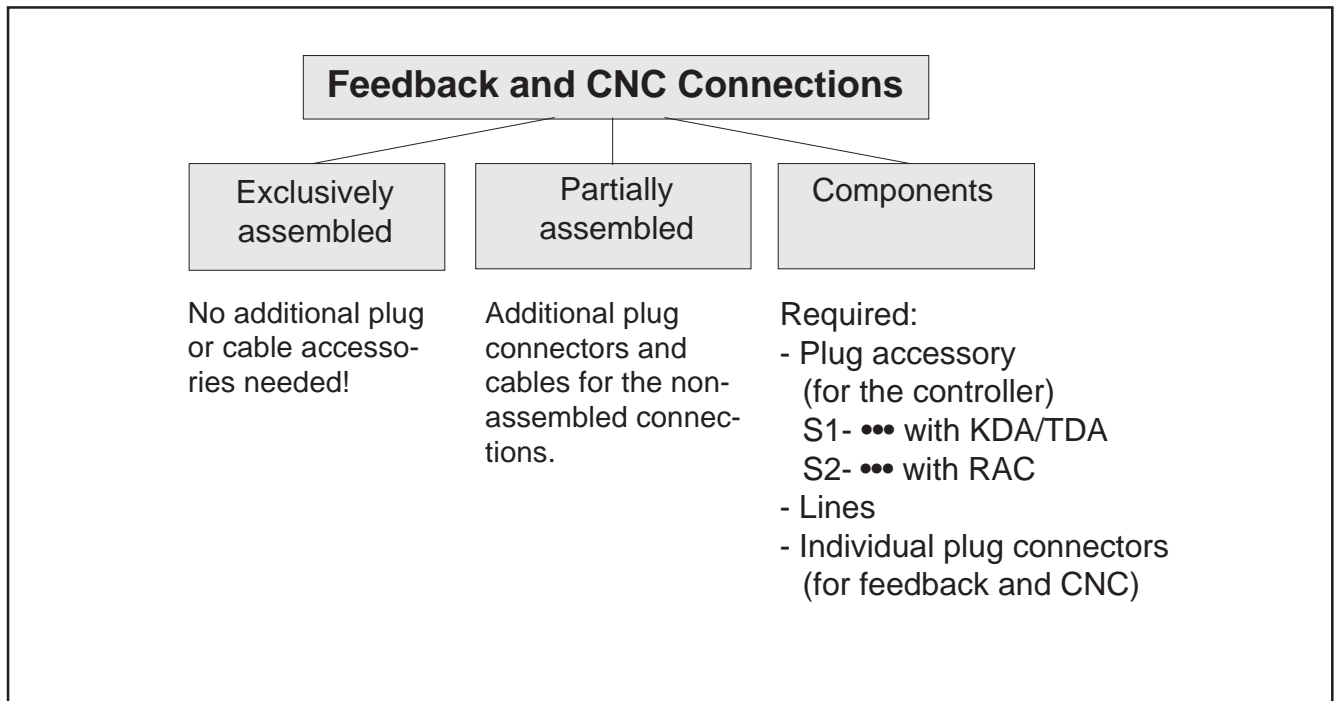

Figure 1.5: Specifications of the feedback and CNC connections with accessories referenced.

Should only component cables be used with the feedback and CNC connections, then the plug accessory sets offered guarantee a complete connection to the controller by means of appropriate plug connectors.

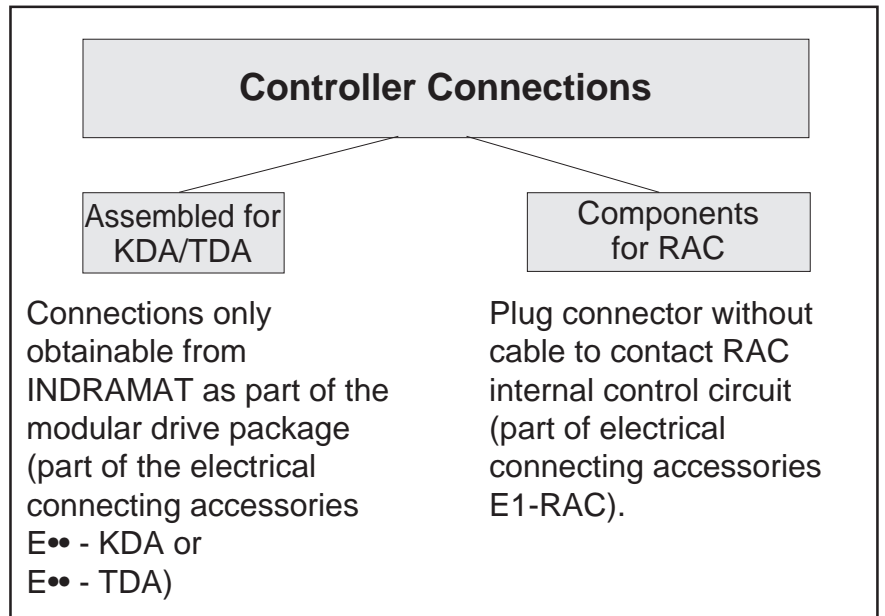

Figure 1.6: Construction of controller-specific connections with electrical connecting accessories referenced.

The controller-specific connections are always required! The electrical connection accessories within the KDA/TDA modular drive package are dependent upon the adjacent controller in the drive package (see documentation main spindle controller; „Project Planning Notes“).

1.3. Determination of Size and Guidelines

Sizing the conductor cross sections

The conductor cross sections of the assembled INDRAMAT cables are sized in accordance with guidelines EN 60 204, Section 1/ 2/86.

The cross sections of the power connections to the main spindle motor have been selected in acc. with the respective rated current of the motor (see tables listing assembly specifications beginning with Fig. 2.19).

The cross sections of the power connections to the three-phase mains are dimensioned according to the continuous output of the main spindle motor used in the main spindle controllers for direct mains connection (see Section 2.2.3).

Load Capacity Table		Conversion table for ambient temperatures greater than 30 degrees C.	
Rated conductor cross sections	Load capacity of the conductors in the machines, normal application in busway	Ambient temperature °C	Conversion factor
mm ²	A		
0,75	9	30	1
1	12	35	0,93
1,5	15,5	40	0,87
2,5	21	45	0,79
4	28	50	0,71
6	36	55	0,61
10	50	60	0,50
16	68		
25	89		
35	111		
50 ³⁾	134		

³⁾actual cross section equals 47 mm²

Figure 1.7: Load capacity and conversion factor table for ambient temperatures greater than 30 degrees C., in acc. with EN 60 204-1/ 2/86.

The permissible operating temperature on the surface of the cable equals 70 degrees C. For allocation rated conductor cross section - load capacity, ambient air temperature is based on 30 degrees C.

Load capacity must be converted in accordance with EN 60 204-1/ 2/ 86 (Figure 1.7) for ambient temperatures higher than those in the example.

See EN 60 204 Section 1 / 2/86 for further details.

Sizing maximum cable lengths

Maximum cable length is limited by the electro-magnetic distortions and the loss of voltage along the cable. Transit time effects in the motor power cable cause cable-length dependent voltage increases at the motor terminals. This also limits cable lengths.

The maximum cable lengths given reference the direct connection between controller and motor, or feedback, in those cases where assembled INDRAMAT cables are used, and an ambient temperature of 30 degrees C is maintained in accordance with VDE 0113.

Terminal points and intermediate couplings can reduce maximum cable length.

– Power connection to motor: 75 m

– Feedback connection: 75 m

2. Power Connections

INDRAMAT main spindle drives have power connections between the controller and motor and between the RAC controller and the three-phase mains.

2.1. Motor-Controller Power Connections

The power connections between motor and controller are broken down into Sections:

Section 2.1.1: Division of the types of connections

- direct connection motor-controller
- connection with intermediate terminal
- connection with plug design
- connection with plugin testing points

Section 2.1.2: Connection plans for direct connection of motor and motor fan of

- 2AD 100 and 2AD 101 with air flow A->B
- 2AD 100 and 2AD 101 with air flow B->A
- 2AD 132 with power connector
- 2AD 132, 2D 160, 2AD 180, 2AD 200 and 2AD 225 with terminal box
- 1MB frameless spindle motor (water cooled)

Section 2.1.3: Table of assembled cable specifications for

- motor-controller direct connection and connection with intermediate terminal
- connection with plug design
- connection with plugin testing points

Section 2.1.4: Table of cable specifications such as

- type designation,
- conductor cross section,
- cable construction,
- cable diameter,
- bending radii, and,
- length-related weight.

2.1.1. Breakdown of the Types of Connections

There are four types of assembled power connections between motor and controller.

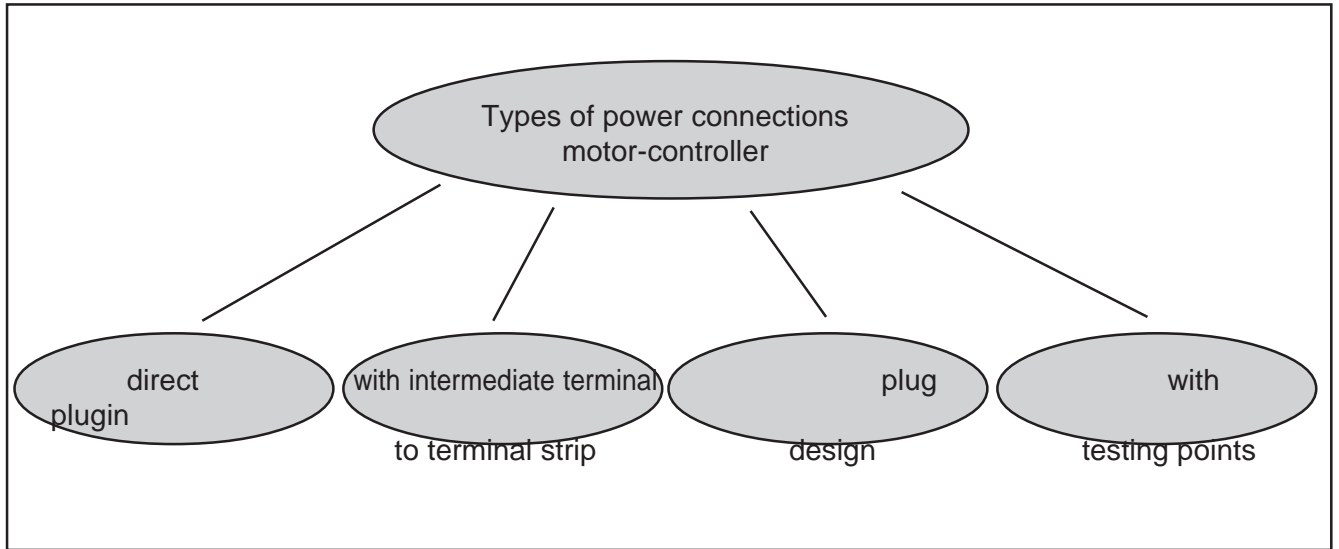

Figure 2.1: The four types of power connections

Motor-controller direct connection

This type of connection is characterized by the lowest number of imperfections and the lowest drop in voltage in comparison to the other types of connections.

A terminal point for the strand pair of the holding brake must be located close to the motor power connection on the controller in the control cabinet, if main spindle drives with holding brakes are used!

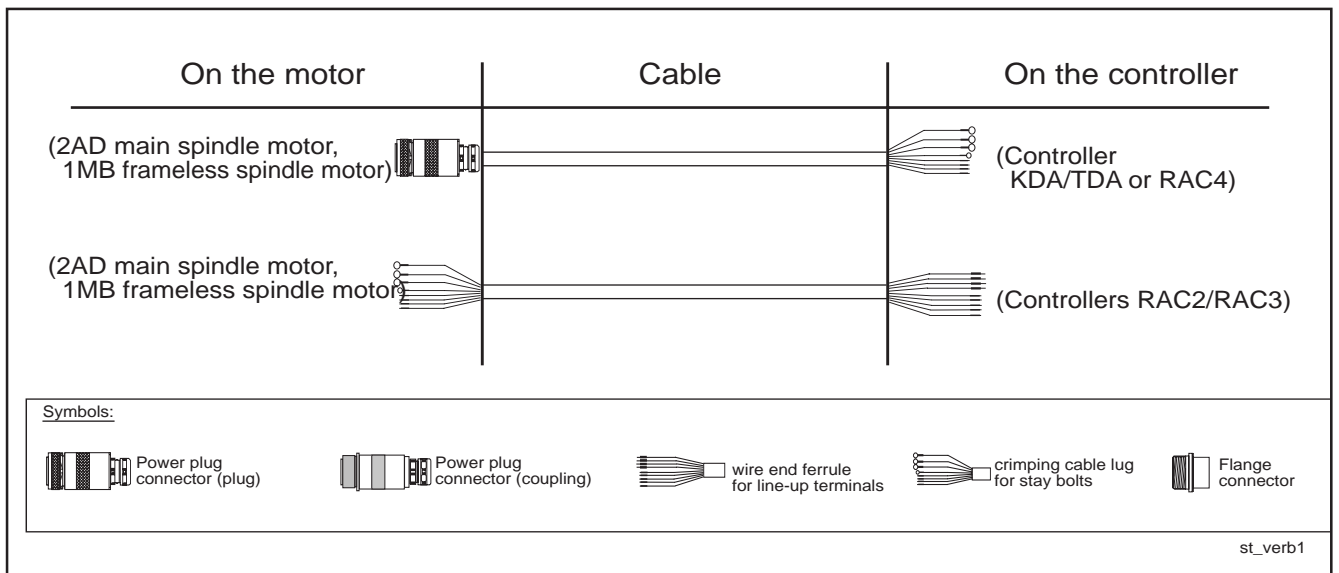

Figure 2.2: Assembled power cables for direct connections (also see Figs. 2.19 and 2.20 for 2AD, and for 1MB see Figs. 2.25 through 2.27).

Motor-controller connection with intermediate terminal

With this type of connection it is easy for the CNC control to take charge of the electrical holding brake, or to be integrated into the control circuit.

The intermediate terminal at a terminal strip also makes it possible to reroute a space-saving, sheathless cable into the cable conduits of the control cabinet!

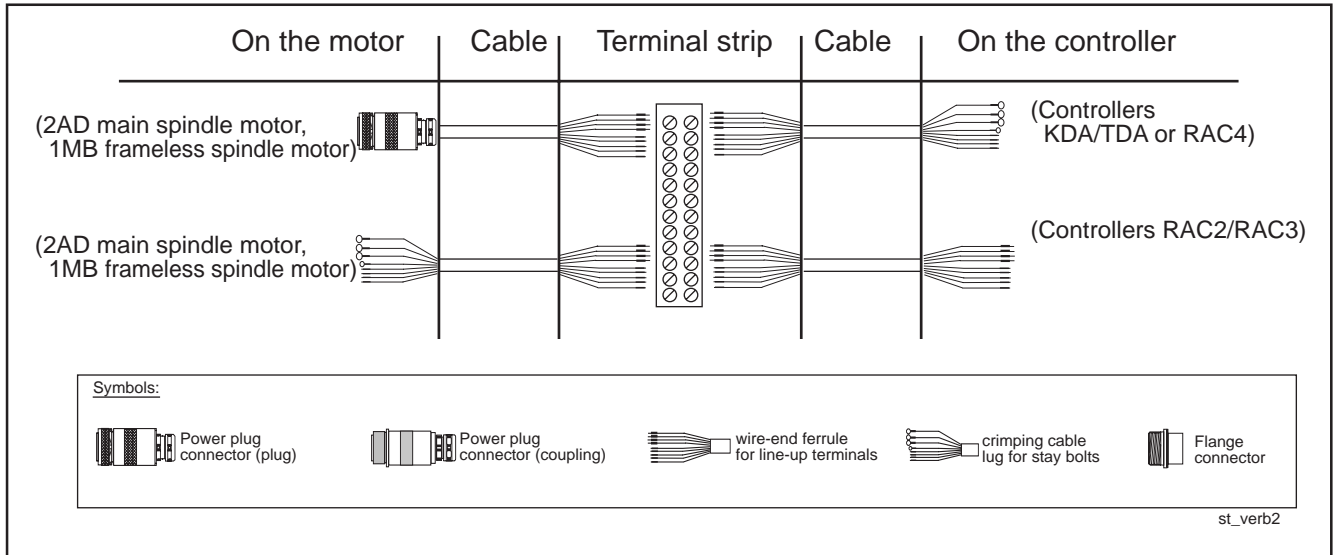

Figure 2.3: Assembled power cable with intermediate terminal at terminal strip (also see Figs. 2.19 and 2.20 for 2AD, Figs. 2.25 through 2.27 for 1MB).

Motor-controller connection with plug design

This type of connection makes it possible to finish the control cabinet entirely independent of the machines.

In addition, damaged cables can be very quickly and reliably exchanged.

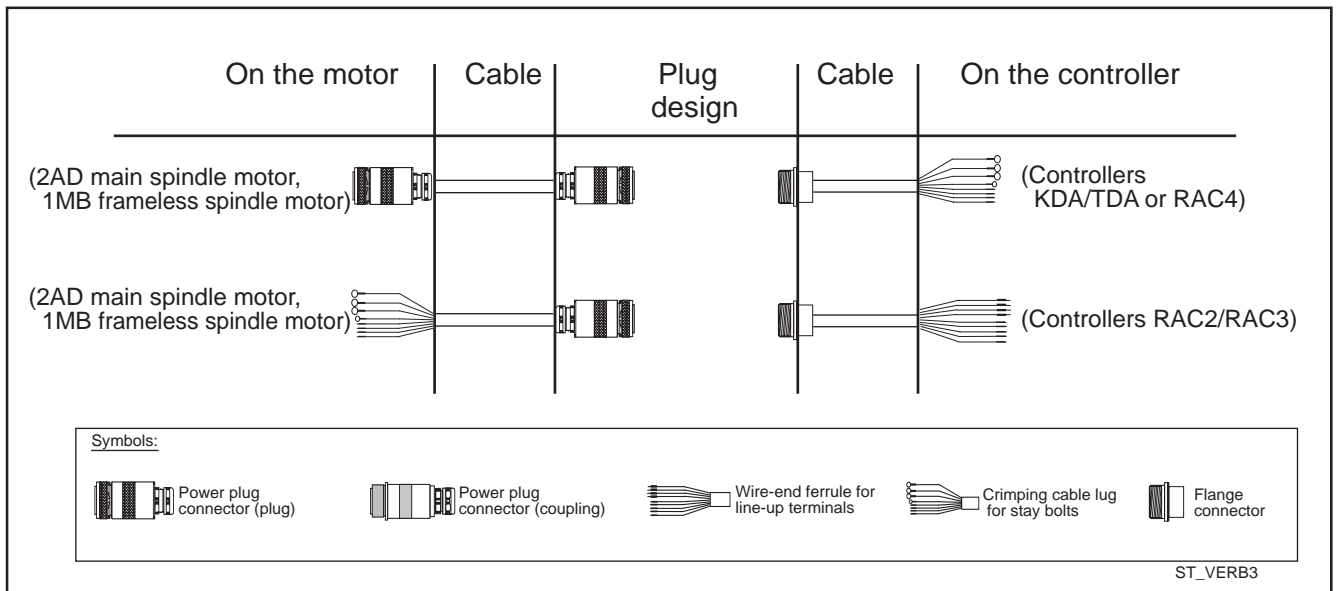

Figure 2.4: Assembled power cable with plug design (also see Figs. 2.21 and 2.22 for 2AD, see Figs. 2.28 through 2.30) for 1MB.

Motor-controller connection with plugin testing points

This connection type is advantageous for larger facilities because it is possible to quickly and reliably exchange the damaged section of a cable.

The mounting of assembled cables of this type is particularly simple and quick.

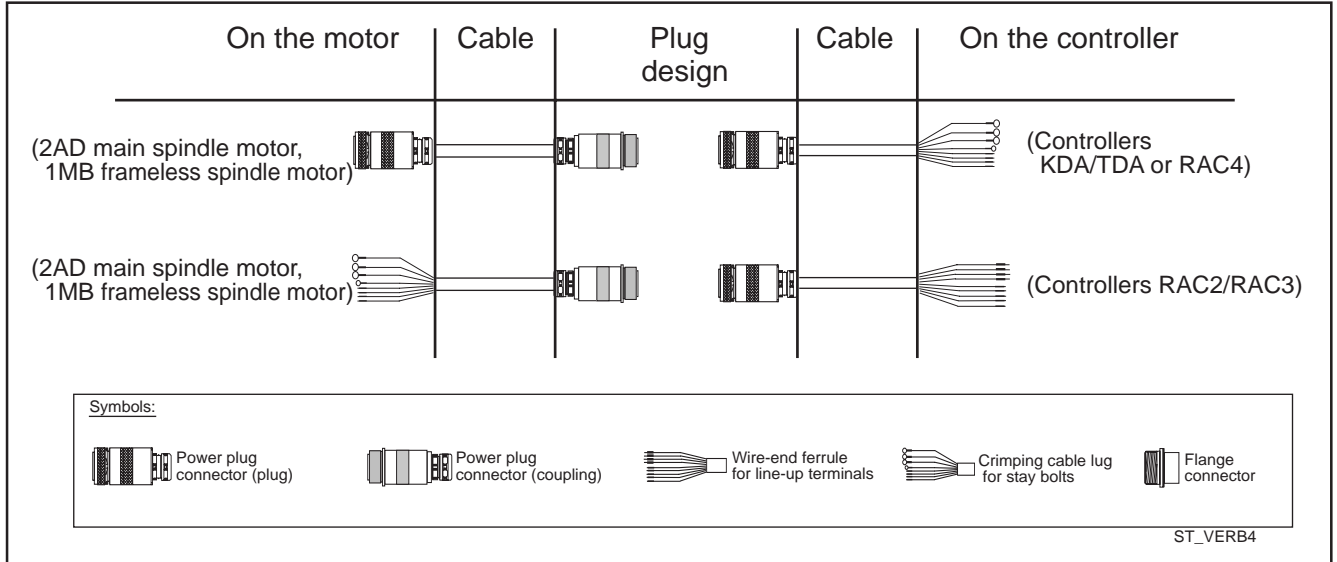

Figure 2.5: Assembled power cable with plugin testing points (also see figure 2.23, 2.24 for 2AD, see Figs. 2.31 through 2.33 for 1MB) .

The assembled cable with the power plug connectors at both ends (plug/coupling) can be added as an extension piece between the plugin testing points.

2.1.2. Connection Plans for Direct Connections

Only the connection plans for the direct connection of the motor-controller power connections are depicted. They also, however, apply to all other connections types. The respective testing points do not alter the arrangement of motor and controller connections.

The connection plans assist in constructing the facility wiring diagrams. The facility circuit diagrams of the machine manufacturer should be used when wiring the facility!

Technical Data

The technical specifications for the motor, the holding brake (optional) and the motor fan are dealt with in the documentation on the respective main spindle motor - project planning notes. The documentation also includes a recommendation for the selection of the protective motor switch for the motor fan.

Motor with Holding Brake

If a main spindle motor with holding brake is used, then the control cabinet must supply it with +24V +/-10%. The facility control system controls the holding brake.

The criteria for the holding brake control system are –

- the operating principle of the holding brake, and,
- monitors the powering down of the motor ($N < N_{min}$).

The respective application determines all other criteria.

Monitoring of motor shutdown ($N < N_{min}$) is explained in the document entitled „AC Main Spindle Drives with Controlled Asynchronous Motors or Frameless Spindle Motors; Description of Application“.

2AD 100 motor connection (cooling air flow A => B) and 2AD 101 (motor fan with terminal box)

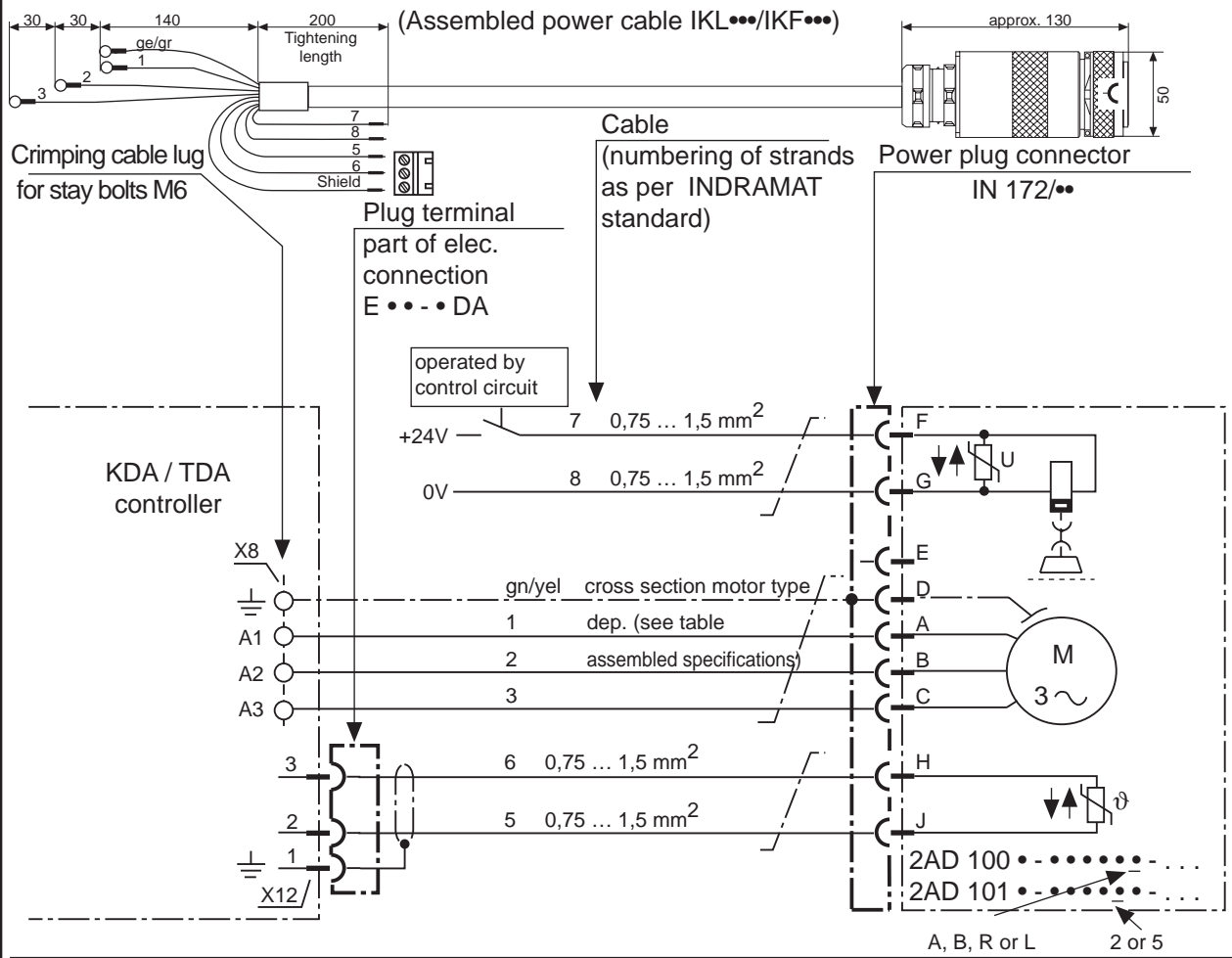

Motor fan connection:

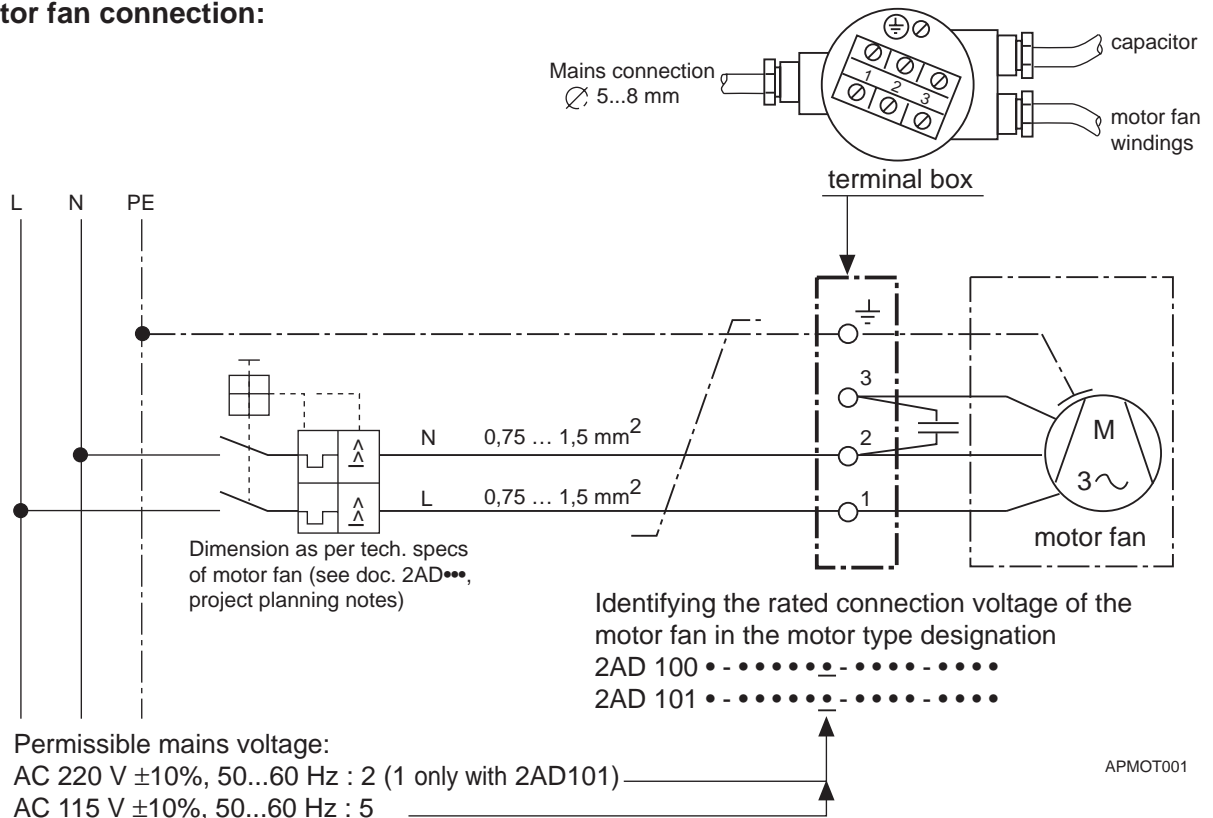
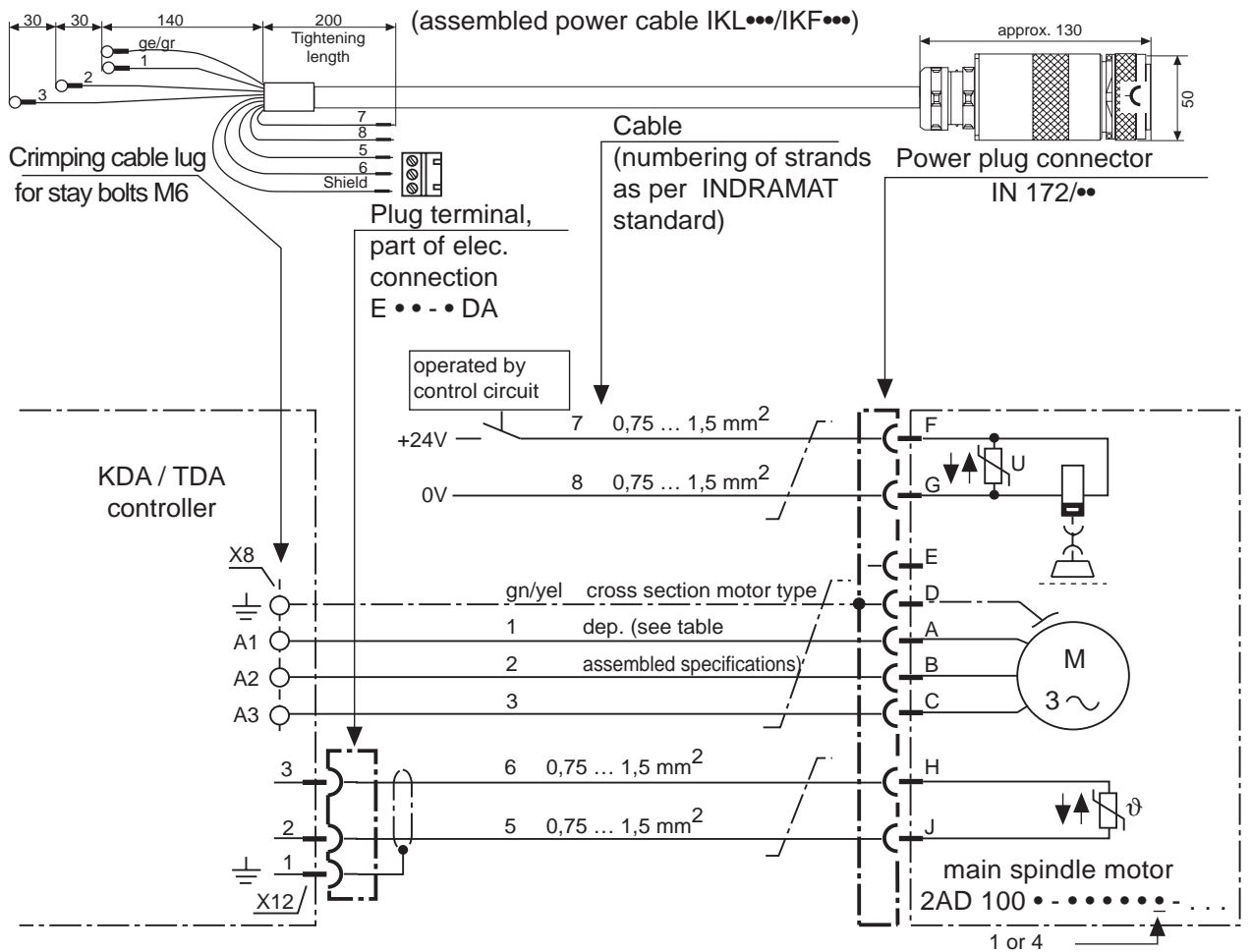

Figure 2.6: Connection of 2AD 100 motor with air flow from A->B and 2AD 101 with terminal box to motor fan.

2AD 100 motor connection (cooling air flow B => A)



Motor fan connection:

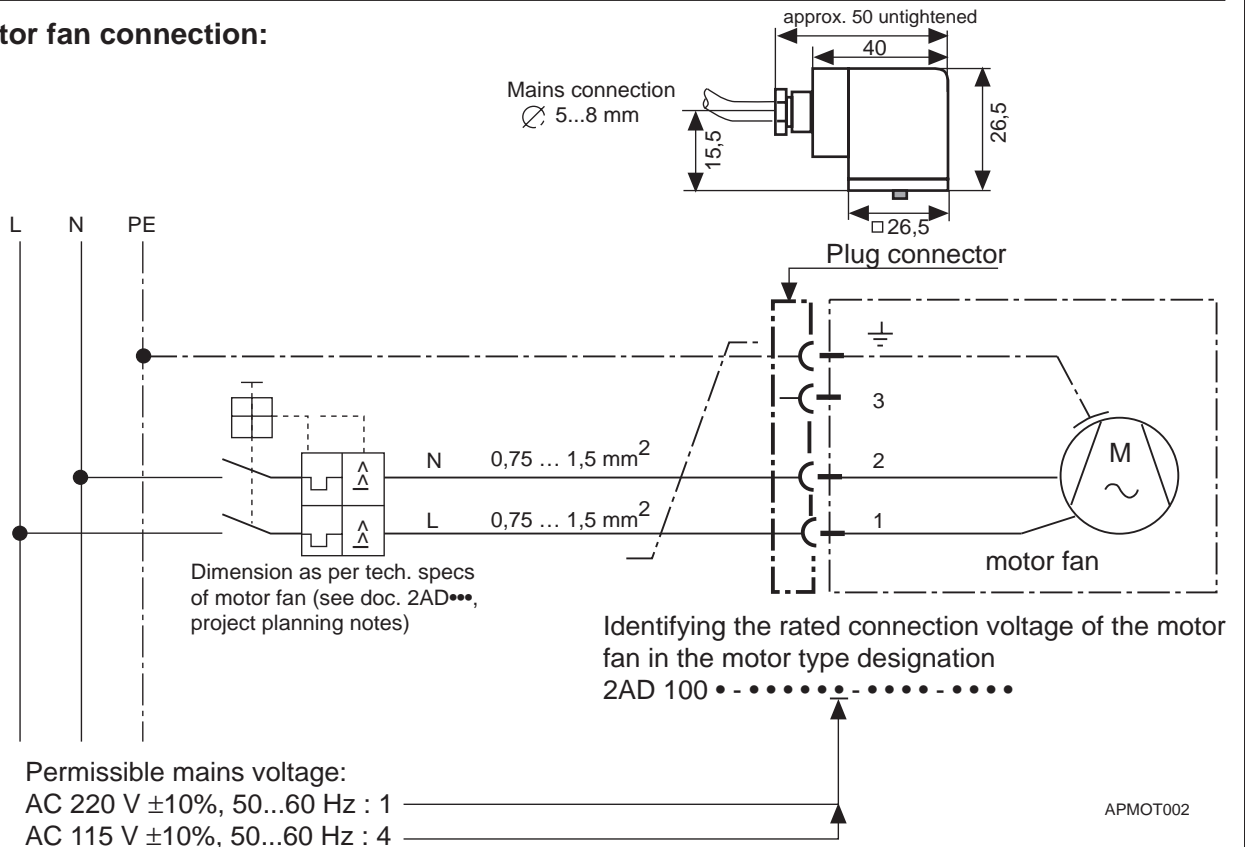
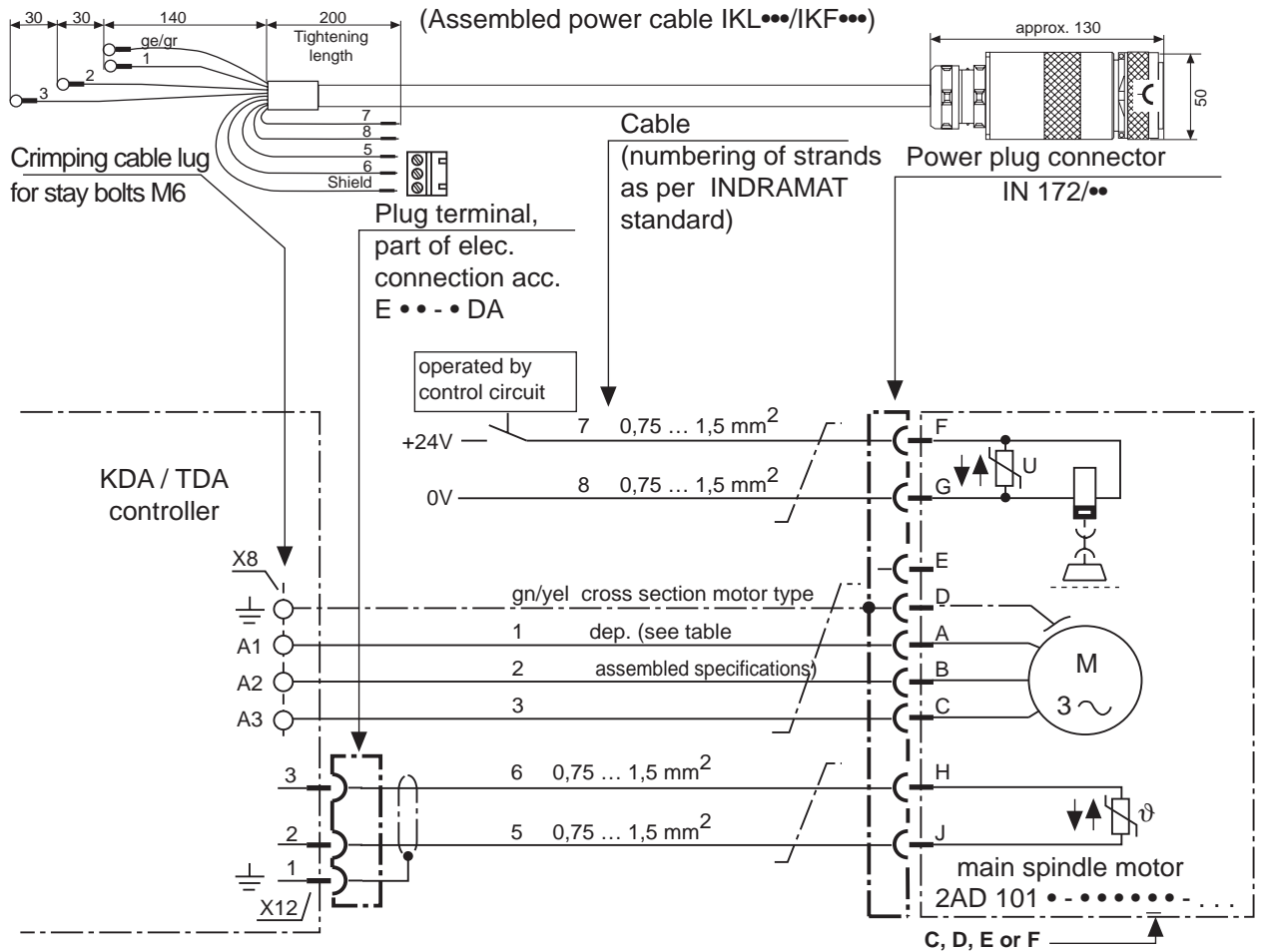
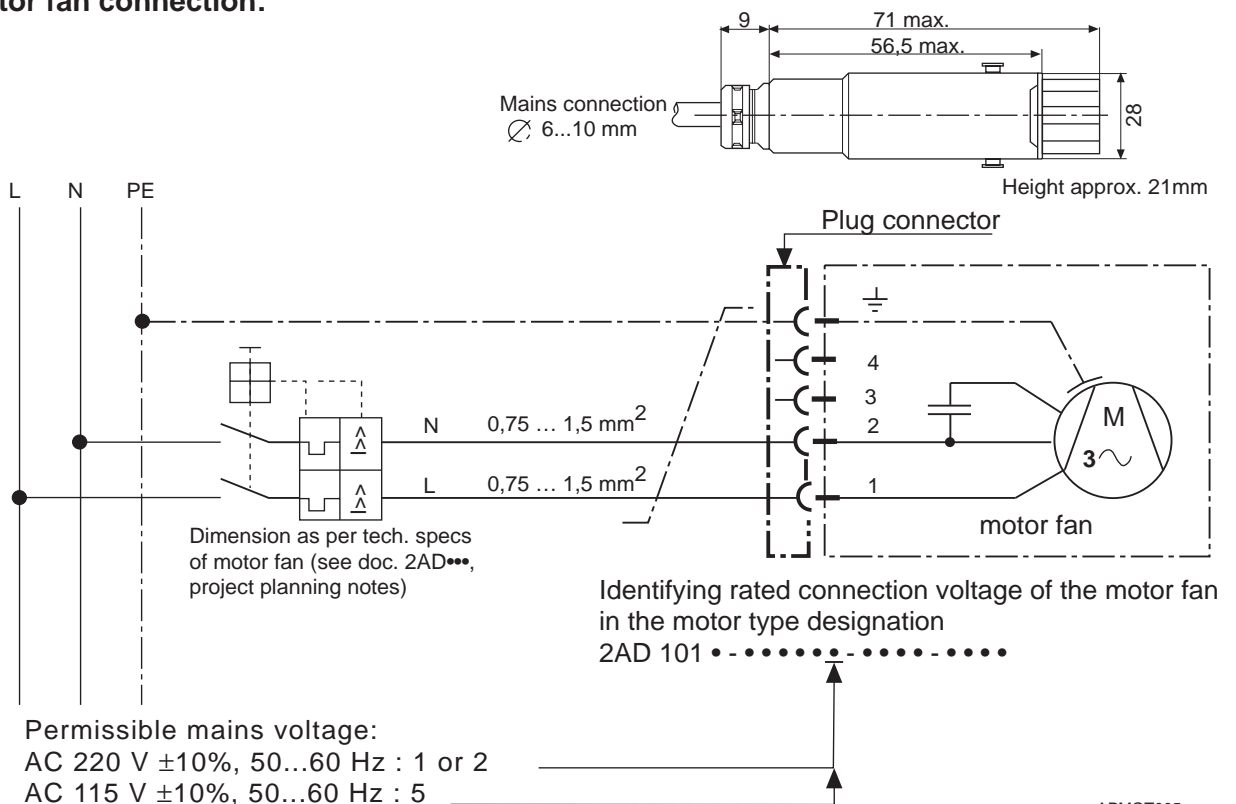

Figure 2.7: Connection of 2AD 100 motor with air flow from B->A.

2AD 101 motor connection (motor fan with plug connector)



Motor fan connection:



APMOT005

Figure 2.8: Connection of 2AD 101 motor with plug connector to motor fan.

2AD 132 motor connection (power plug connector) to KDA/TDA

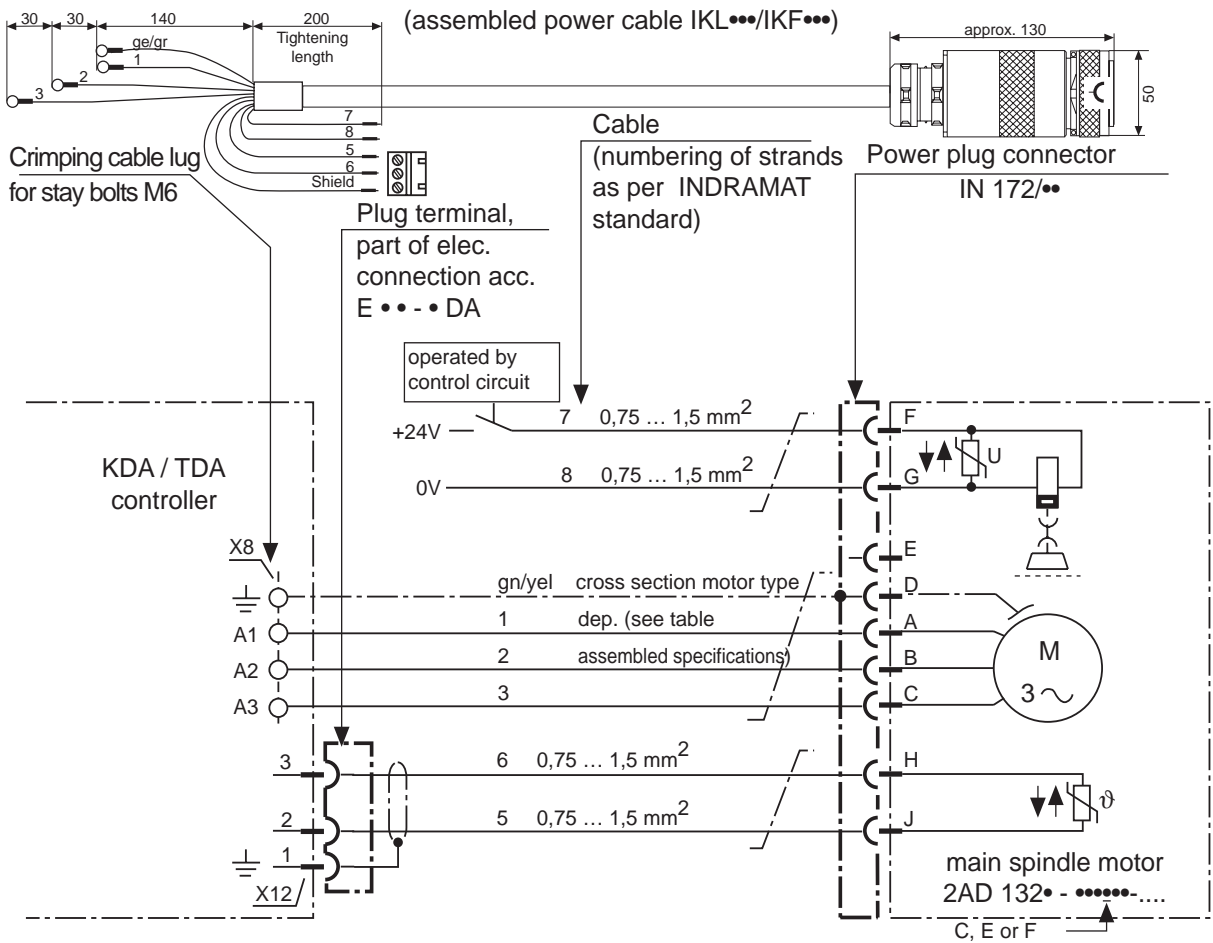

Motor fan connection:

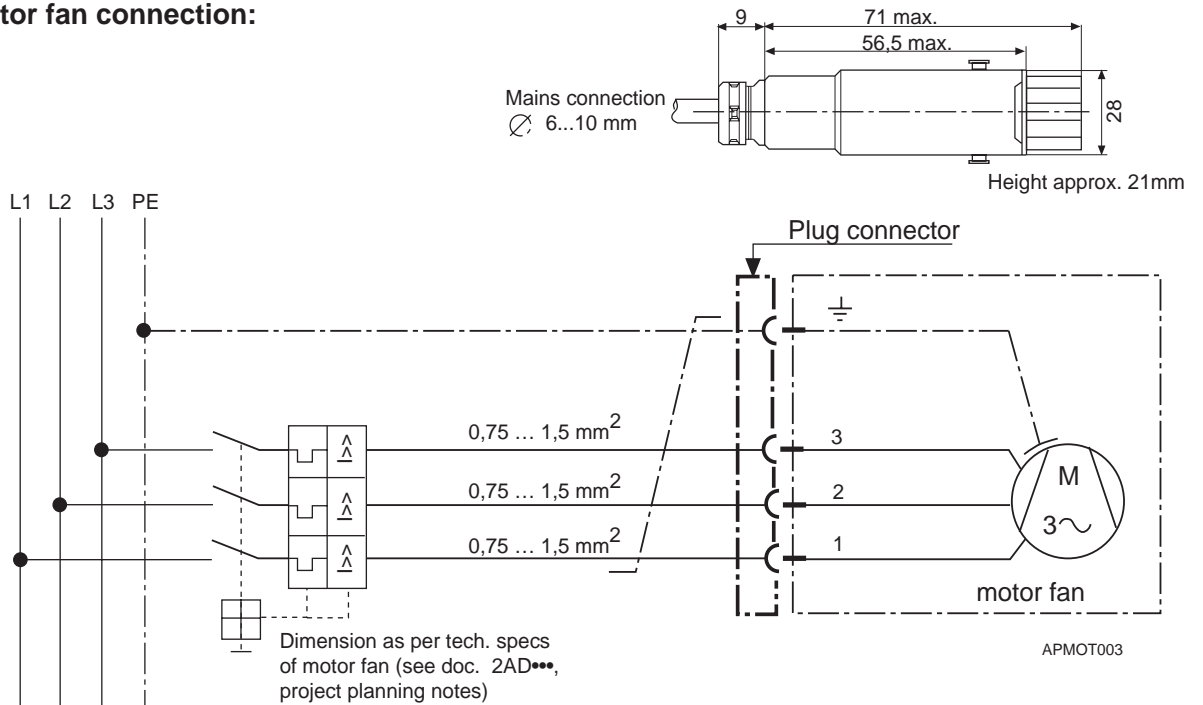

Permissible mains voltage:
 3x400V ±15%, 50...60Hz
 3x460V ±10%, 60Hz

Figure 2.9: Connection of 2AD 132 motor with power plug to KDA/TDA controller.

2AD 132 motor connection (power plug connector) to RAC

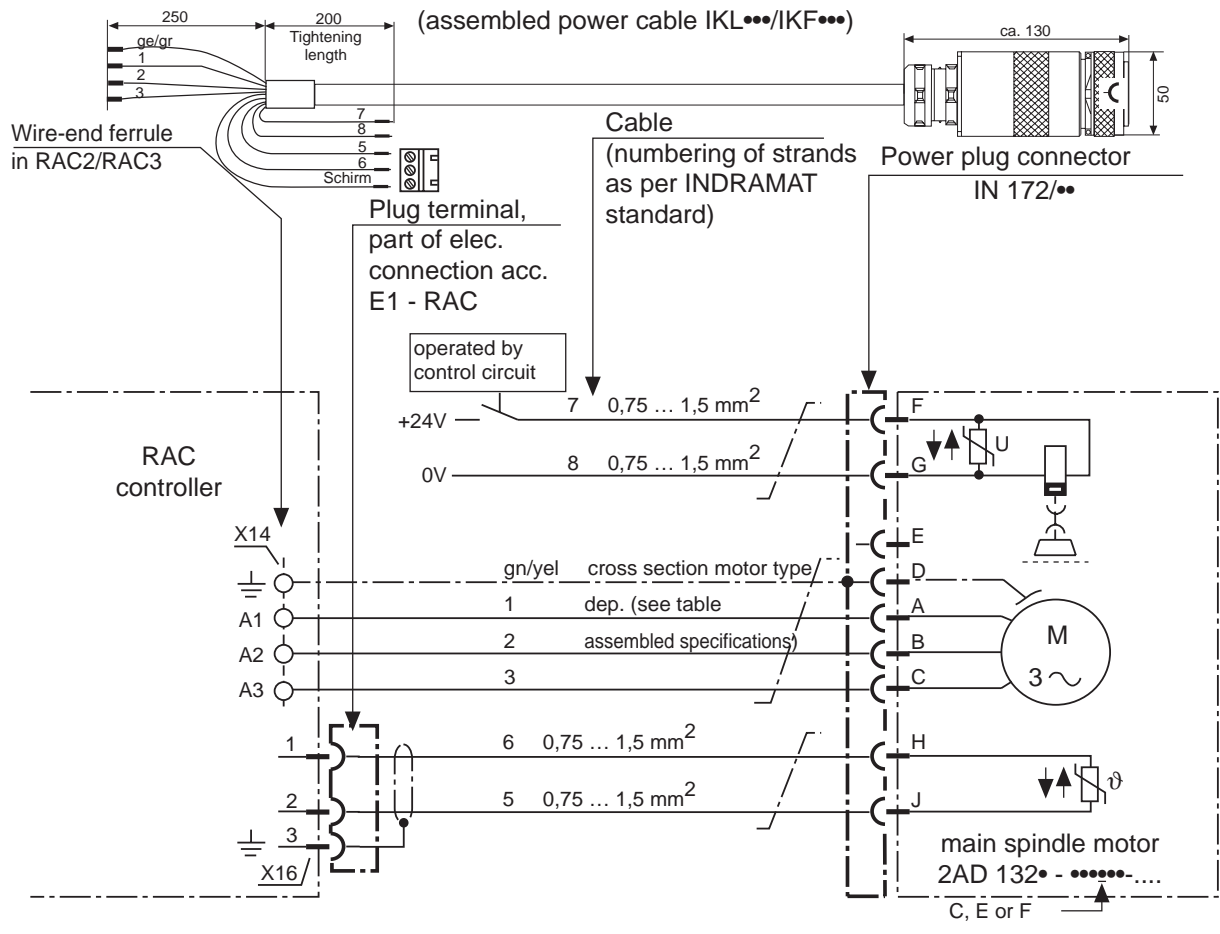

Motor fan connection:

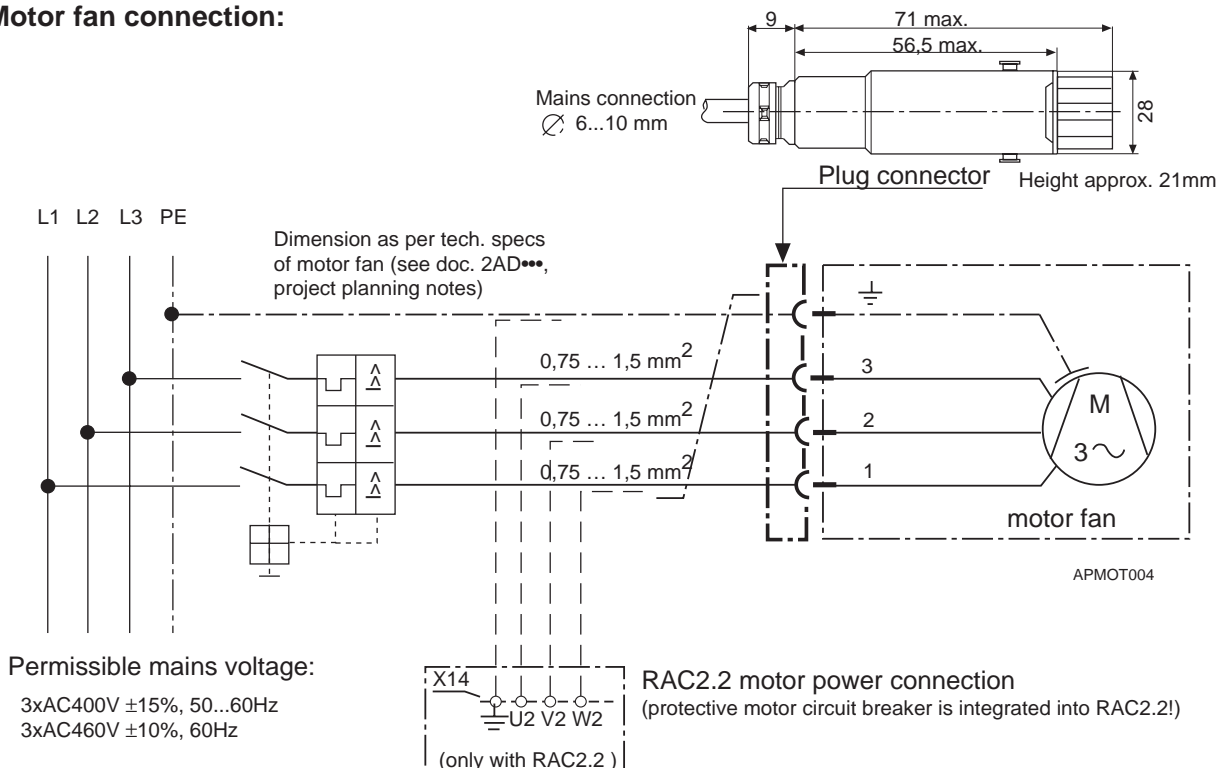
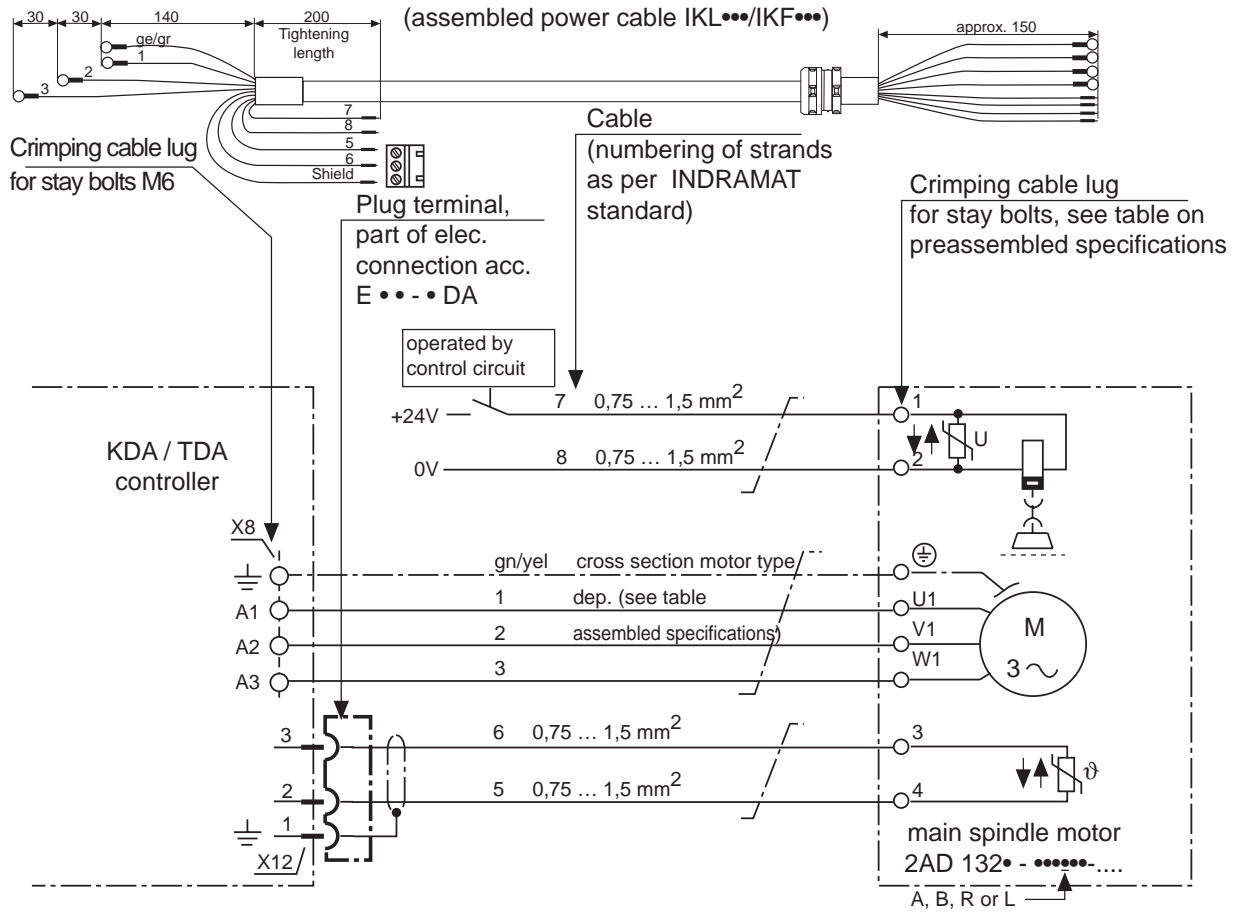

Figure 2.10: Connection of 2AD 132 motor with power plug to RAC controller.

2AD 132 motor connection (terminal box) to KDA/TDA



Motor fan connection:

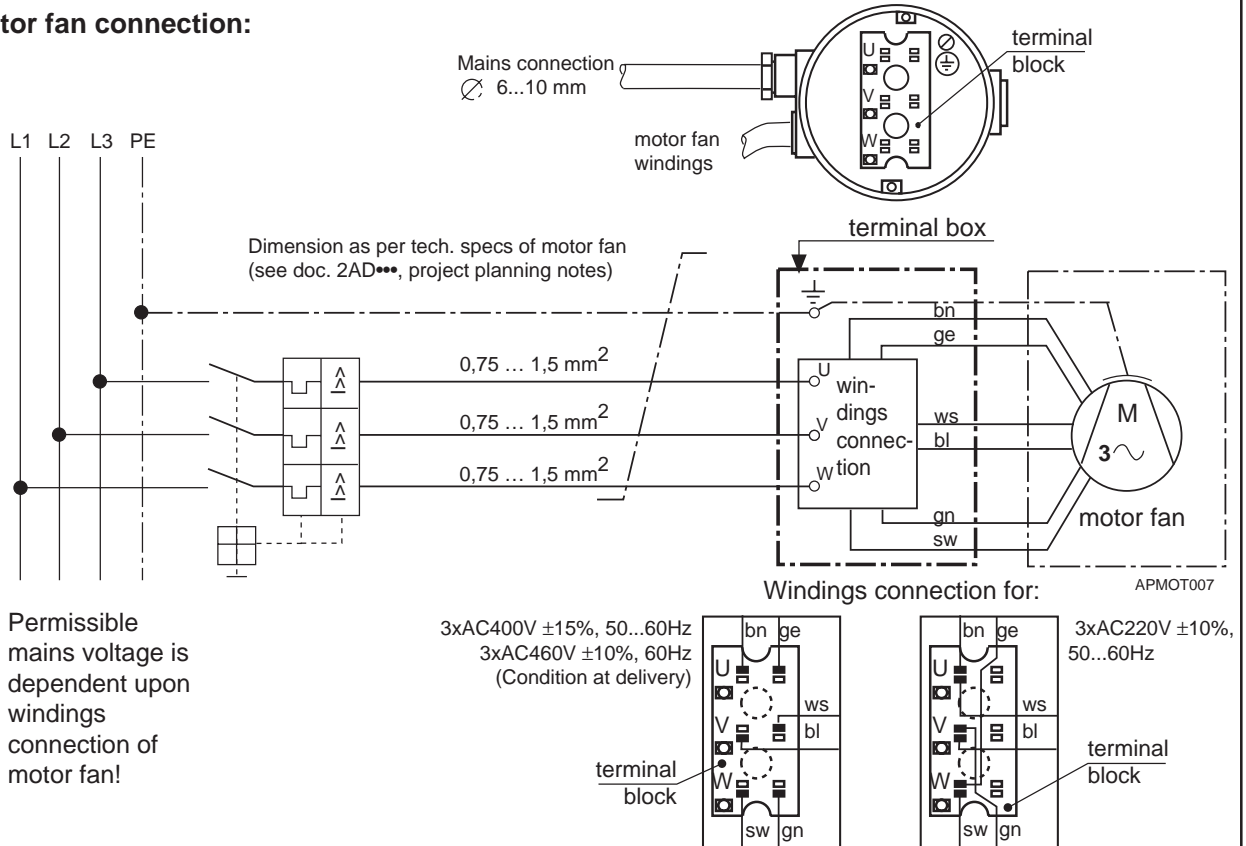
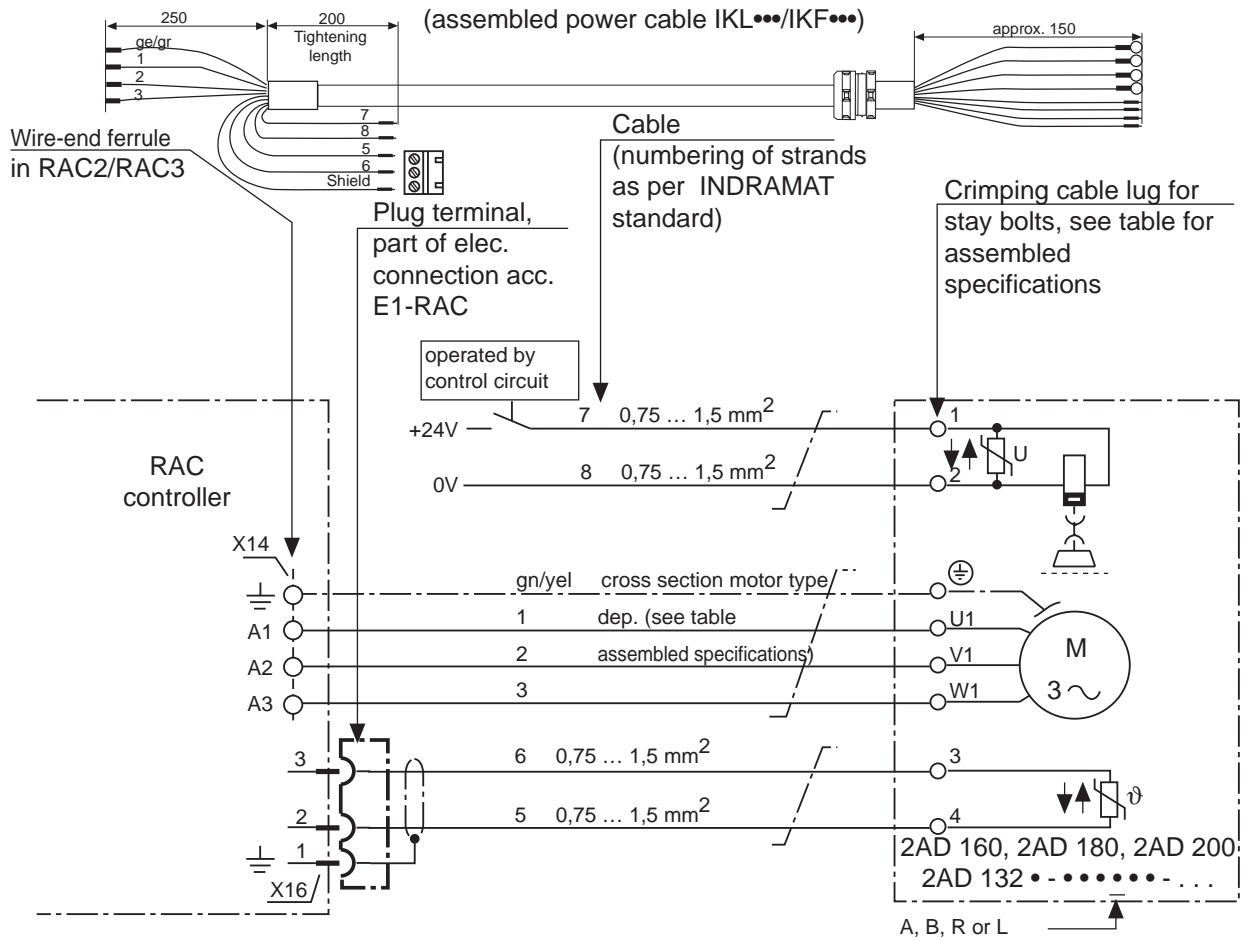

Figure 2.11: Connection of 2AD 132 motor with terminal box to KDA/TDA controller.

2AD 132 motor connection (terminal box), 2AD 160, 2AD 180 and 2AD 200 to RAC



Motor fan connection:

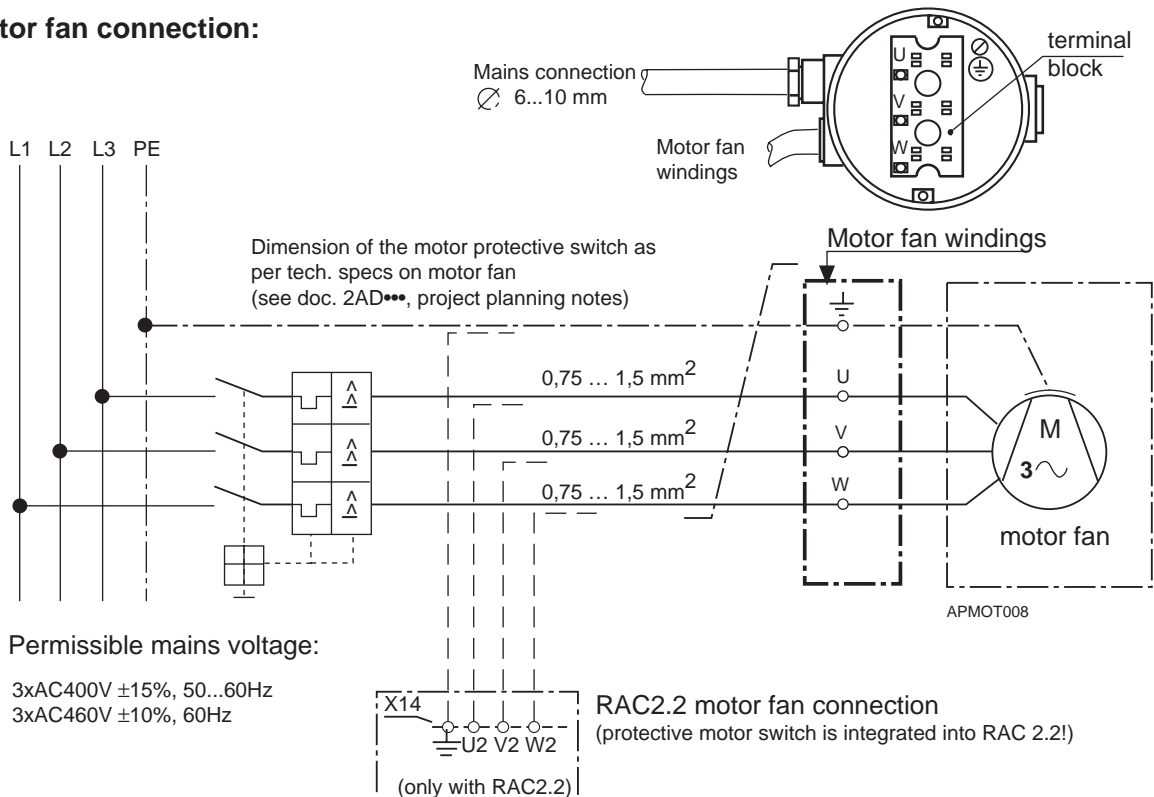

Figure 2.12: Connection of 2AD 132, 2AD 160, 2AD 180 and 2AD 200 motors (all have terminal box)

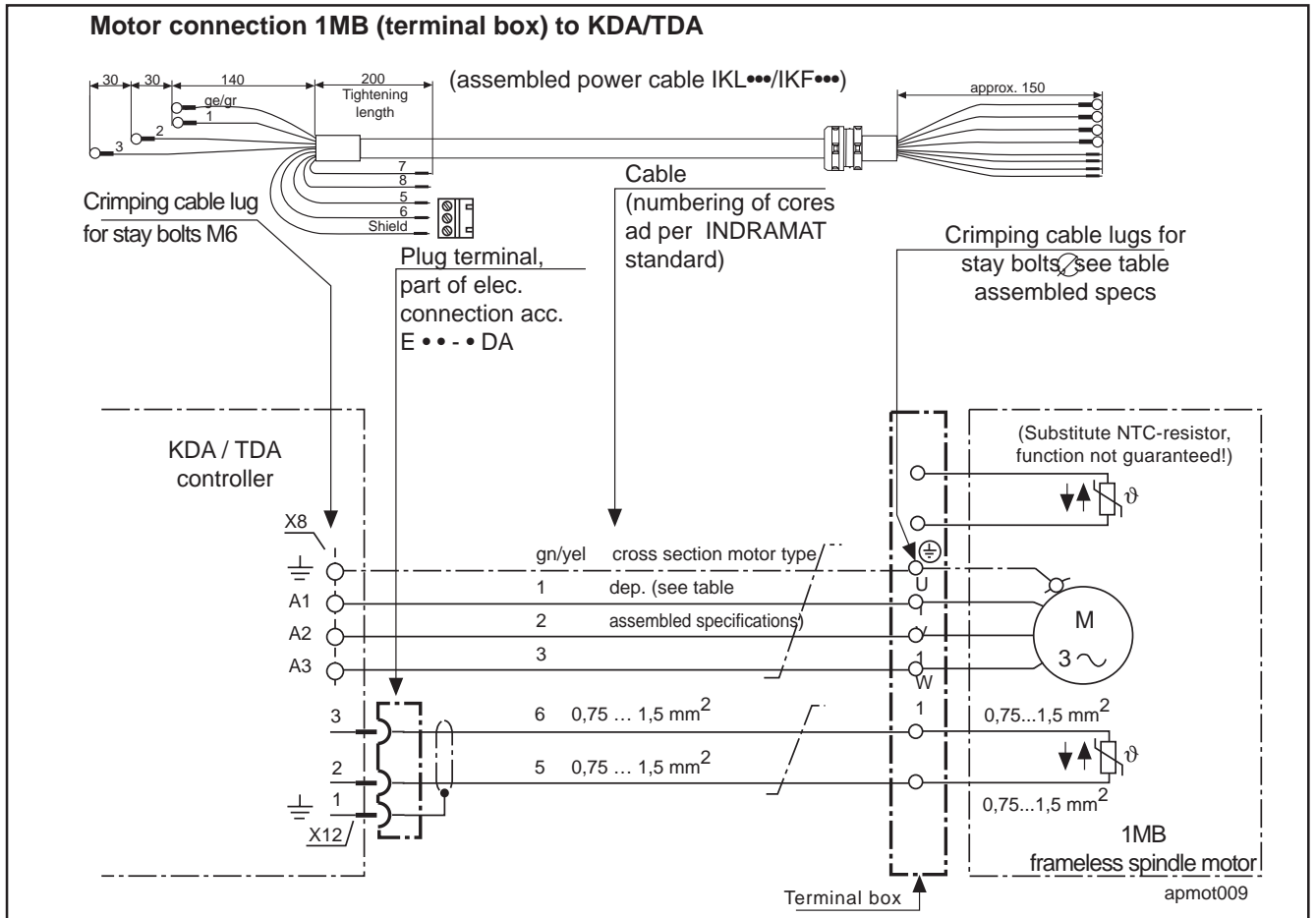

Fig. 2.13: Connection via terminal box of 1MB frameless spindle motors to KDA/TDA controllers

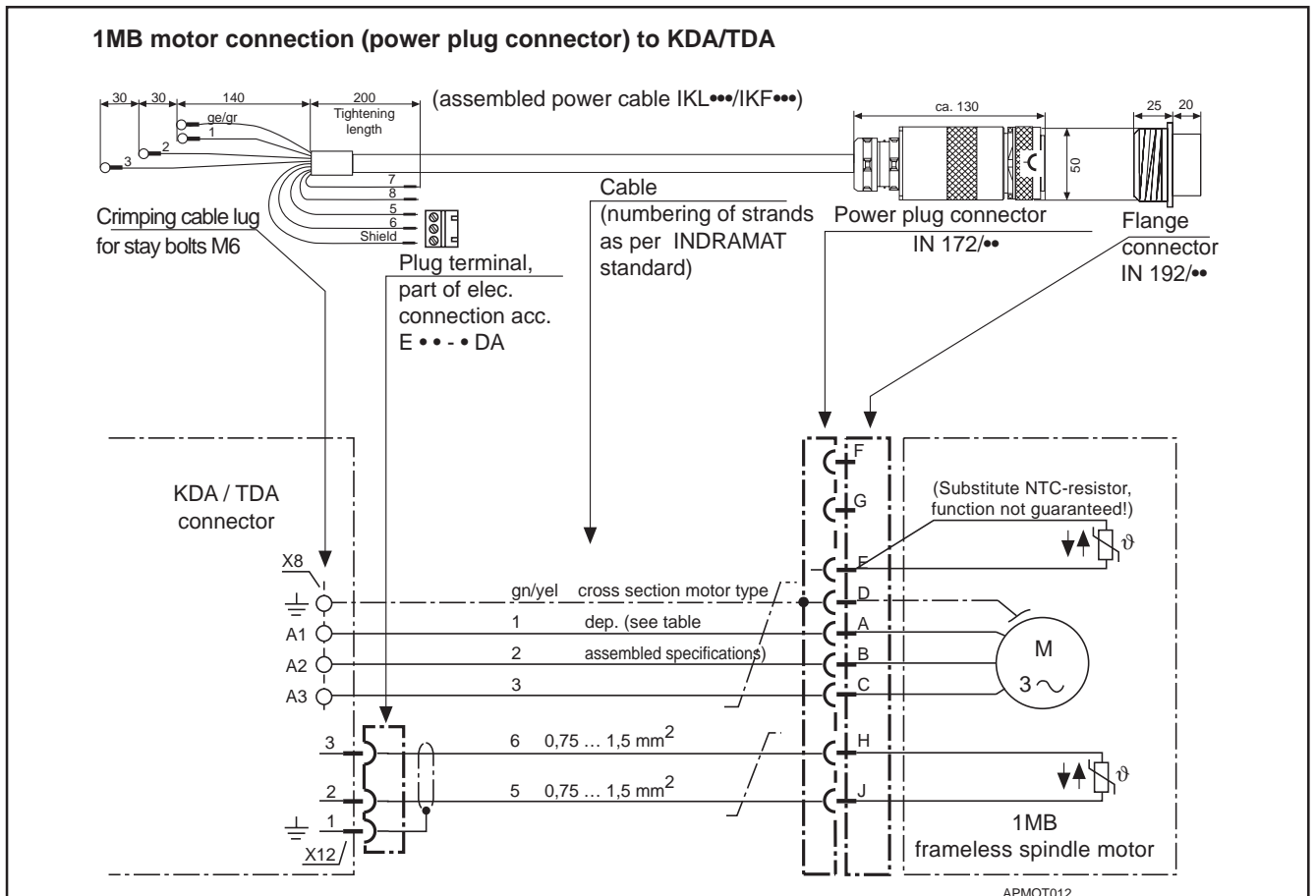

Figure 2.14: Connection of 1MB frameless spindle motors to KDA/TDA controllers via power plug connectors.

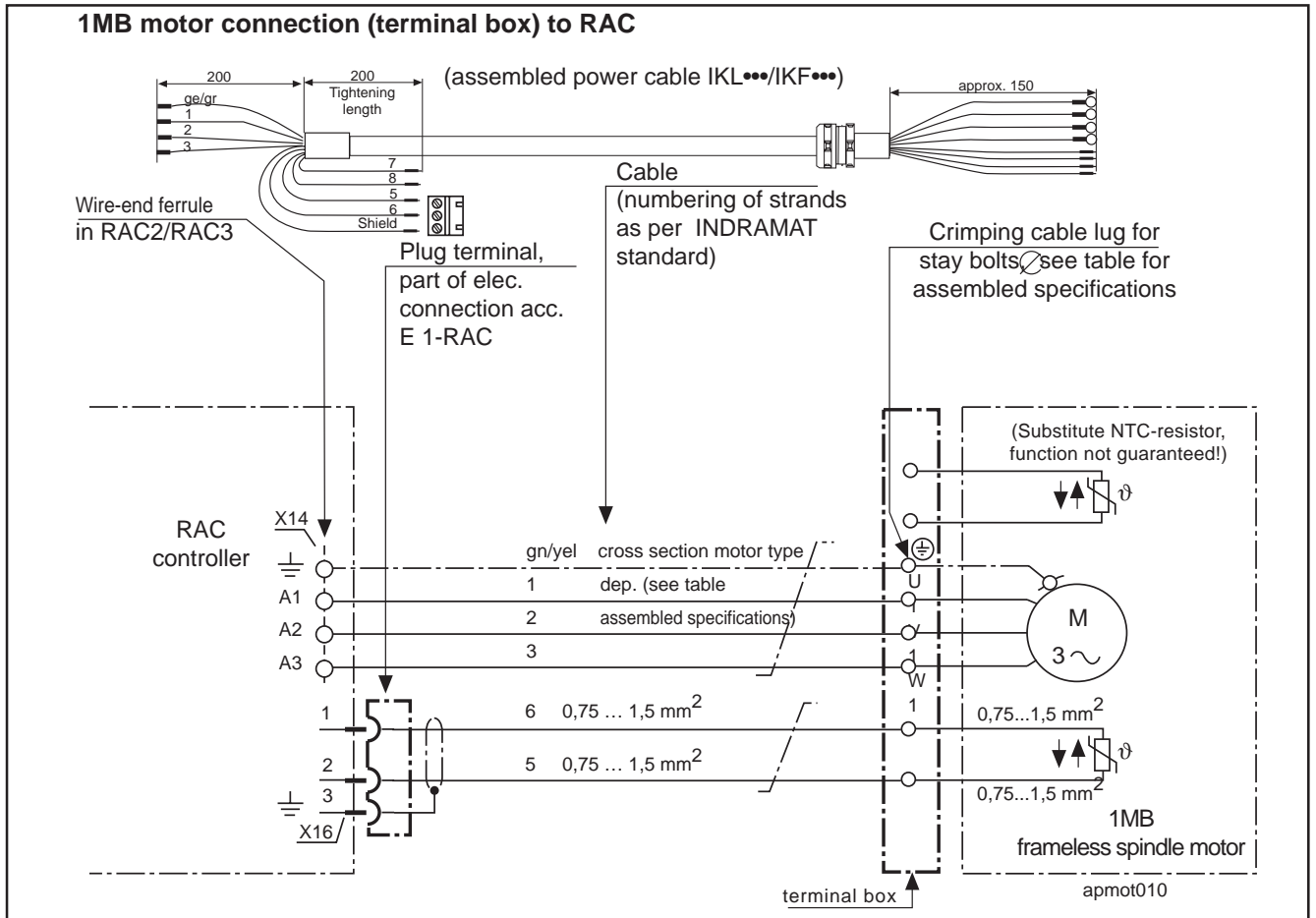

Fig. 2.15: Connection via terminal box of 1MB frameless spindle motor to RAC controller

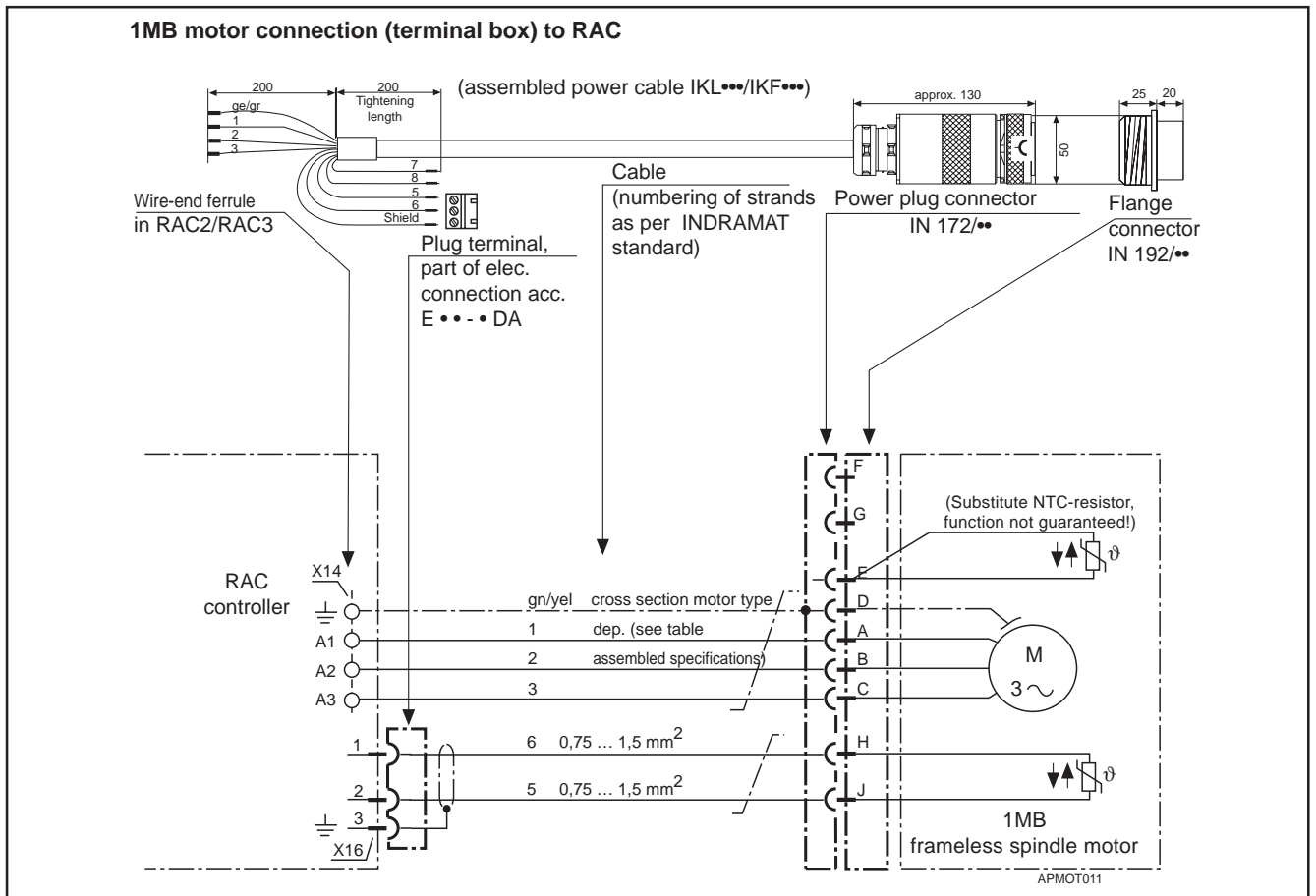

Fig. 2.16: 1MB frameless spindle motor connection to RAC controller via power plug connector.

2.1.3. Assembled Data List

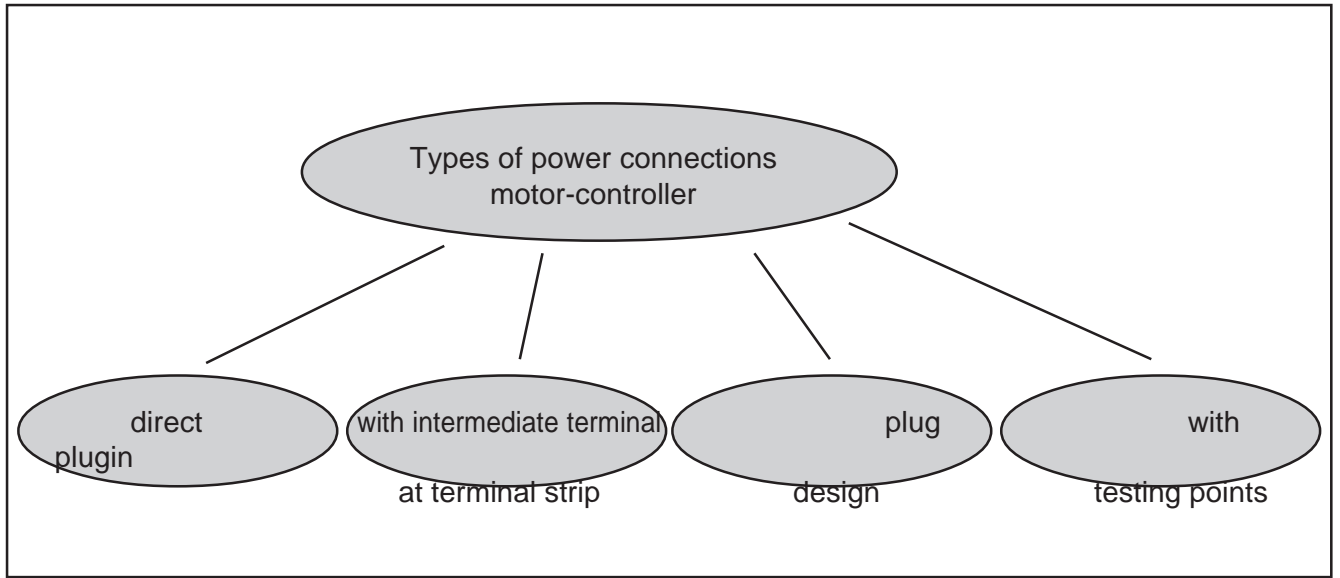

Figure 2.17: Four types of assembled power connections

The four types of power motor-controller connections are motor-type dependent and have been summarized in a table.

Assembled Specifications Table

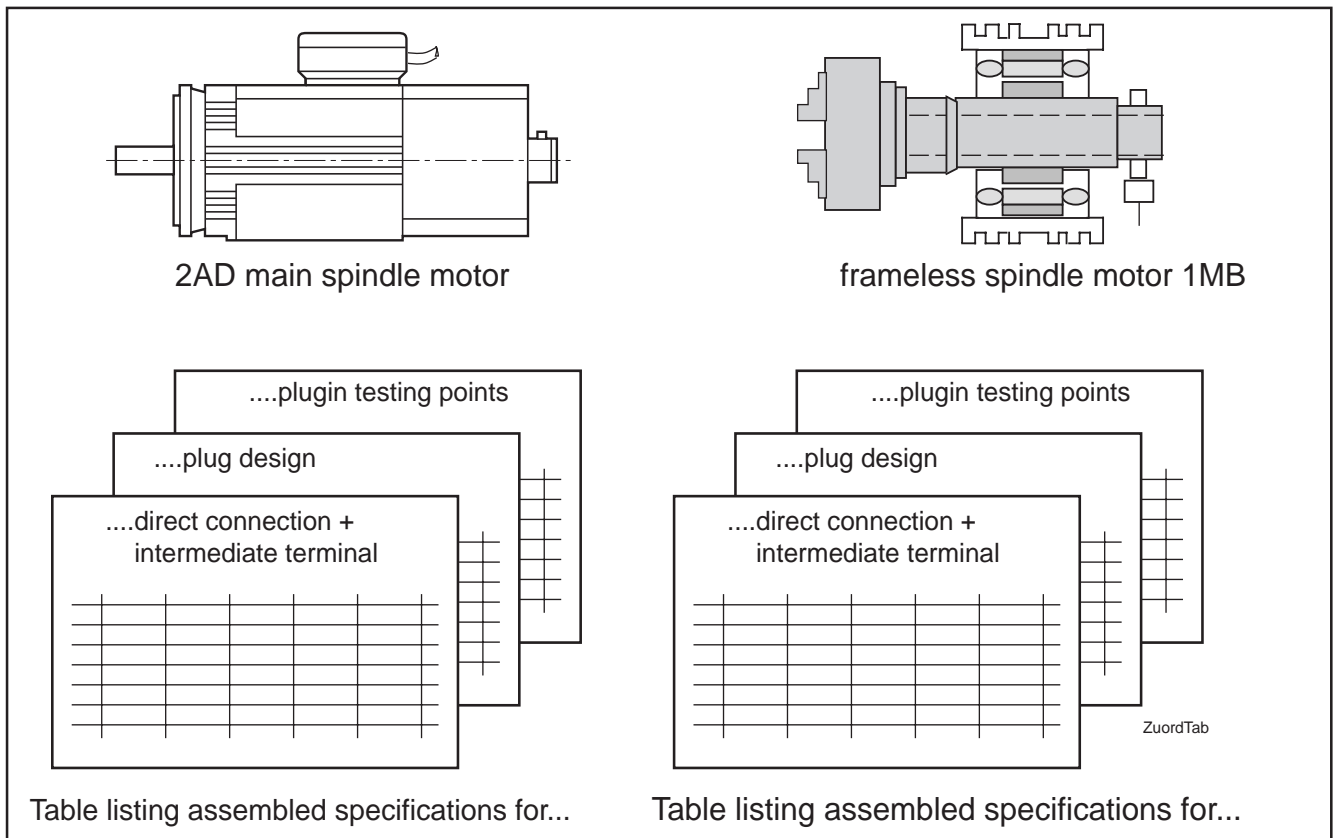
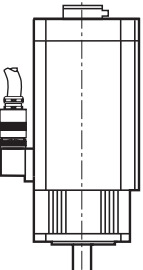

Figure 2.18: Allocation of main spindle motors in table

The tables list the available flexible and highly flexible assembled cables and their significant components.

Section 1: 2AD power connections - direct connections and intermediate terminals

 Cable cross section A [mm ²]	Assembled cables for direct connection flex./highly flex.	Assembled cable components for direct connection		Assembled cables for intermediate terminals on terminal strips	
		on the motor	Cable flex./highly flex.	on the controller	on the motor flex./highly flex.
2AD100B-B.....AS-3.....	IKL071/IKF071	IN172/25	IN203/IN403	For... ...stay bolt M6 (KDA/TDA)	IKL074/ *)
2AD100C-B.....AS-3.....	IKL071/IKF071	IN172/25	IN203/IN403	...stay bolt M6 (KDA/TDA)	IKL074/ *)
2AD100D-B.....AS-3.....	IKL112/IKF112	IN172/06	IN204/IN404	...stay bolt M6 (KDA/TDA)	IKL115/ *)
2AD101D-B.....BD-3.....	IKL130/IKF130	IN172/10	IN205/IN405	...stay bolt M6 (KDA/TDA)	IKL134/ *)
2AD132B-B.....BS-3.....	IKL130/IKF130	IN172/10	IN205/IN405	...stay bolt M6 (KDA/TDA)	IKL134/ *)
2AD132C-B.....BS-3.....	*)	IN172/16	IN206/IN406	...stay bolt M6 (KDA/TDA)	IKL150/IKF150
2AD132D-B.....BD-3.....	IKL170/IKF170	IN172/25	IN207/IN407	...stay bolt M6 (KDA/TDA)	*)
2AD132B-B.....DS-3.....	IKL115/ *)	IN172/06	IN204/IN404	For... ...line-up terminals (RAC2/RAC3)	IKL115/ *)
2AD132C-B.....CS-3.....	IKL134/ *)	IN172/10	IN205/IN405	...line-up terminals (RAC2/RAC3)	IKL134/ *)
2AD132D-B.....AS-3.....	IKL150/IKF150	IN172/16	IN206/IN406	...line-up terminals (RAC2/RAC3)	IKL150/IKF150

alkab01







Symbols:

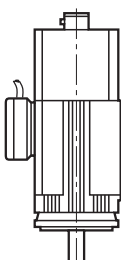

*) Available. For inquiries on type information contact Development Dept., INDRAMAT.

Figure 2.19: Assembled specifications table for direct connection and intermediate terminals on terminal strips for 2AD motors - Section 1.

Section 2: 2AD power connections - direct connections and intermediate terminals

Cable cross section A [mm ²]	Assembled cables for direct connection	Cable components for direct connection			Assembled cables for intermediate terminals on the motor flex./highly flex.	Assembled cables for intermediate terminals on the controller flex./highly flex.
		on the motor	Cable flex./highly flex.	on the controller		
		Für...		For...		
2AD132B-B.....BS-3..... (PG 29)	IKL135/IKF135	..stay bolt M6 ⊕ M8	IN205/IN405	..stay bolt M6 (KDA/TDA)	IKL136/IKF136	not available
2AD132C-B.....BS-3..... (PG 29)	IKL157/IKF157	..stay bolt M6 ⊕ M8	IN206/IN406	..stay bolt M6 (KDA/TDA)	IKL152/IKF152	not available
2AD132D-B.....BD-3..... (PG 29)	IKL174/IKF174	..stay bolt M8 ⊕ M8	IN207/IN407	..stay bolt M6 (KDA/TDA)	IKL172/IKF172	not available
2AD132B-B.....DS-3..... (PG 29)	IKL110	For...	IN204/IN404	For...		
2AD132C-B.....CS-3..... (PG 29)	IKL136/IKF136	..stay bolt M6 ⊕ M8	IN205/IN405	...line-up terminals (RAC2 /RAC3)	IKL136/IKF136	not available
2AD132D-B.....AS-3..... (PG 29)	IKL151/IKF151	..stay bolt M8 ⊕ M8	IN206/IN406	...line-up terminals (RAC2 /RAC3)	IKL151/IKF151	not available
2AD160B-B.....BS-3..... (PG 29)	IKL171/IKF171	..stay bolt M8 ⊕ M8	IN207/IN407	...line-up terminals (RAC2 /RAC3)	IKL171/IKF171	not available
2AD160C-B.....BS-3..... (PG 42)	IKL182/ *)	..stay bolt M10 ⊕ M10	IN267	...line-up terminals (RAC2 /RAC3)	IKL182/ *)	not available
2AD180C-B.....BS-3..... (PG 42)	IKL182/ *)	..stay bolt M10 ⊕ M10	IN267	...line-up terminals (RAC2 /RAC3)	IKL182/ *)	not available
2AD180D-B.....BS-3..... (PG 42)	IKL191/ *)	For...	IN268/ *)	For...		
2AD200C-B.....AS-3..... (PG 48)	2 x IKL 175/2 x IKF 175	..stay bolt M12 ⊕ M12	2 x IN207/ 2 x IN 407	...Screws M12 (RAC4)	IKL175/IKF175	not available

ALKA802







Symbols:

-  Power plug connector (plug)
-  Power plug connector (coupling)
-  PG screw connection
-  Wire-end ferrule
-  Crimping cable lug
-  Flange connection

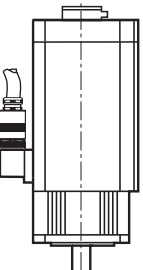
*) Available. For inquiries on type information contact Development Dept., INDRAMAT.

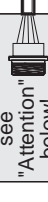
Figure 2.20: Assembled specifications table for direct connections and intermediate terminals on terminal strips for 2AD motors - Section 2.

Section 1: 2AD power connections - plug design

Cable cross section A[mm ²]	Assembled cables for plug connector		The components of assembled cables with plug design			
	on the motor flex./highly flex.	on the controller flex./highly flex.	on the motor	Cable flex./highly flex.	Plug design	L: on the controller
						
2AD100B-B.....-AS*3-.....	IKL073/IKF073	*)	IN172/25	IN203/IN403	IN217/25 see "Attention" below!	dto. stay bolt M6 (KDA/TDA) For..
2AD100C-B.....-AS*3-.....	IKL073/IKF073	*)	IN172/25	IN203/IN403	IN217/25	dto. stay bolt M6 (KDA/TDA)
2AD100D-B.....-AS*3-.....	IKL111/IKF111	IKL114/IKF114	IN172/06	IN204/IN404	IN217/06	dto. stay bolt M6 (KDA/TDA)
2AD101D-B.....-BD*3-.....	IKL133/IKF133	*)	IN172/10	IN205/IN405	IN217/10	dto. stay bolt M6 (KDA/TDA)
2AD132B-B.....-BS*3-.....	IKL133/IKF133	*)	IN172/10	IN205/IN405	IN217/10	dto. stay bolt M6 (KDA/TDA)
2AD132C-B.....-BS*3-.....	IKL154/IKF154	*)	IN172/10	IN206/IN406	IN217/16	dto. stay bolt M6 (KDA/TDA)
2AD132D-B.....-BD*3-.....	*)	*)	IN172/25	IN207/IN407	IN217/25	dto. stay bolt M6 (KDA/TDA)
2AD132B-B.....-DS*3-.....	IKL111/IKF111	*)	IN172/6	IN204/IN404	IN217/06 see "Attention" below!	dto. line-up terminals (RAC2/RAC3) For..
2AD132C-B.....-CS*3-.....	IKL133/IKF133	*)	IN172/10	IN205/IN405	IN217/10	dto. line-up terminals (RAC2/RAC3)
2AD132D-B.....-AS*3-.....	IKL154/IKF154	*)	IN172/16	IN206/IN406	IN217/16	dto. line-up terminals (RAC2/RAC3)

Symbols:



Attention!

Flange connection IN218 must have an insulator casing which fits out over the contacts on the soldered or crimped side by approx. 3 mm!







Do not use any other type!

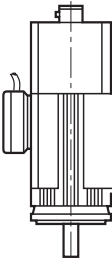

Figure 2.21: Specifications table for assembled cables with plug connectors for 2AD motors - Section 1.

*) Available. For inquiries on type information contact Development Dept., INDRAMAT.

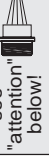
Section 2: 2AD power connections - plug design

Cable cross section A [mm²]	Assembled cables for plug connector		Assembled cable components with plug connector				
	on the motor flex./highly flex.	on the controller flex./highly flex.	on the motor	Cable flex./highly flex.	plug design	L:	on the controller
			For..		see "attention" below!		For..
2AD132B-B***-BS*3-*** (PG29)	IKL137/IKF137		..stay bolt M6 ⊕ M8	IN205/IN405	IN217/10	dto.	..stay bolt M6 (KDA/TDA)
2AD132C-B***-BS*3-*** (PG29)	IKL153/IKF153		..stay bolt M8 ⊕ M8	IN206/IN406	IN217/16	dto.	..stay bolt M6 (KDA/TDA)
2AD132D-B***-BD*3-*** (PG29)	IKL173/IKF173		..stay bolt M8 ⊕ M8	IN207/IN407	IN217/25	dto.	..stay bolt M6 (KDA/TDA)
2AD132B-B***-DS*3-*** (PG29)	*)		For..		see "attention" below!		For..
2AD132C-B***-CS*3-*** (PG29)	IKL137/IKF137		..stay bolt M6 ⊕ M8	IN204/IN404	IN217/06	dto.	..line-up terminals (RAC2/RAC3)
2AD132D-B***-AS*3-*** (PG29)	*)		..stay bolt M8 ⊕ M8	IN205/IN405	IN217/10	dto.	..line-up terminals (RAC2/RAC3)
2AD160B-B***-BS*3-*** (PG29)	*)		..stay bolt M8 ⊕ M8	IN206/IN406	IN217/16	dto.	..line-up terminals (RAC2/RAC3)
2AD160C-B***-BS*3-*** (PG42)	not available	not available	..stay bolt M10 ⊕ M10	IN267	not available	dto.	..line-up terminals (RAC2/RAC3)
2AD180C-B***-BS*3-*** (PG42)	not available	not available	..stay bolt M10 ⊕ M10	IN267	not available	dto.	..line-up terminals (RAC2/RAC3)
2AD180D-B***-BS*3-*** (PG42)	not available	not available	For..		see "attention" below!		For..
2AD200C-B***-AS*3-*** (PG48)	not available	not available	..stay bolt M12 ⊕ M12	2 x IN207/2 x IN 407	not available	dto.	..screws M12 (RAC4)

Symbols:



*) Available. For inquiries on type information contact Development Dept., INDRAMAT.







Attention!

Flange connection IN218 must have an insulator casing which juts out over the contacts on the soldered or crimped side by approx. 3 mm!

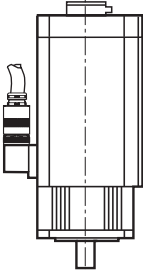
Do not use any other type!

Figure 2.22: Specifications for connection with plug design for 2AD motors-Section 2.

Section 1: 2AD power connections - plugin testing points

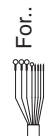
Cable cross section A [mm ²]	Preassembled cables for plugin testing points		Components of preassembled cables with plugin testing points			
	on the motor flex. /highly flex.	on the controller flex. /highly flex.	on the motor	Cable flex. /highly flex.	plugin testing points	L. on the controller
						
2AD100B-B.....-AS*3-.....	IKL072/IKF072	IKL071/IKF071	IN172/25	IN203/IN403	IN172/25	..stay bolt M6 (KDA/TDA)
2AD100C-B.....-AS*3-.....	IKL072/IKF072	IKL071/IKF071	IN172/25	IN203/IN403	IN172/25	..stay bolt M6 (KDA/TDA)
2AD100D-B.....-AS*3-.....	IKL113/IKF113	IKL112/IKF112	IN172/06	IN204/IN404	IN172/06	..stay bolt M6 (KDA/TDA)
2AD101D-B.....-BD*3-.....	IKL138/IKF138	IKL130/IKF130	IN172/10	IN205/IN405	IN172/10	..stay bolt M6 (KDA/TDA)
2AD132B-B.....-BS*3-.....	IKL138/IKF138	IKL130/IKF130	IN172/10	IN205/IN405	IN172/10	..stay bolt M6 (KDA/TDA)
2AD132C-B.....-BS*3-.....	IKL158/IKF158	*)	IN172/10	IN206/IN406	IN172/16	..stay bolt M6 (KDA/TDA)
2AD132D-B.....-BD*3-.....	IKL178/IKF178	IKL170/IKF170	IN172/25	IN207/IN407	IN172/25	..stay bolt M6 (KDA/TDA)
2AD132B-B.....-DS*3-.....	IKL113/IKF113	*)	IN172/6	IN204/IN404	IN172/06	For..
2AD132C-B.....-CS*3-.....	IKL138/IKF138	IKL134/ *)	IN172/10	IN205/IN405	IN172/10	..line-up terminals (RAC2/RAC3)
2AD132D-B.....-AS*3-.....	IKL158/IKF158	*)	IN172/16	IN206/IN406	IN172/16	..line-up terminals (RAC2/RAC3)

Symbols:











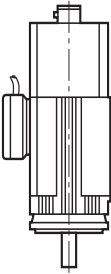

*) Available. For inquiries on type information contact Development Dept., INDRAMAT.

ALKAB05

Figure 2.23: Table of assembled specifications for connections with plug testing points in 2AD motors - Section 1.

Section 2: 2AD power connections - plugin testing points

Cable cross section A [mm ²]	Preassembled cable for plugin testing points		Components of preassembled cables with plugin testing points			
	on the motor flex. /highly flex.	on the controller flex. /highly flex.	on the motor	Cable flex. /highly flex.	plugin testing points	L. on the controller
			For.			
2AD132B-B.....BS*3..... (PG29)	IKL129/IKF129	IKL130/IKF130	..stay bolt M6 ⊕ M8	IN205/IN405	IN172/10	..stay bolt M6 (KDA/TDA)
2AD132C-B.....BS*3..... (PG29)	IKL149/IKF149	*)	..stay bolt M8 ⊕ M8	IN206/IN406	IN172/16	..stay bolt M6 (KDA/TDA)
2AD132D-B.....BD*3..... (PG29)	IKL169/IKF169	IKL170/IKF170	..stay bolt M8 ⊕ M8	IN207/IN407	IN172/25	..stay bolt M6 (KDA/TDA)
2AD132B-B.....DS*3..... (PG29)	*)		For.			For.
2AD132C-B.....CS*3..... (PG29)	IKL129/IKF129	*)	..stay bolt M6 ⊕ M8	IN204/IN404	IN172/06	..line-up terminals (RAC2/RAC3)
2AD132D-B.....AS*3..... (PG29)	IKL149/IKF149	IKL134/ *)	..stay bolt M6 ⊕ M8	IN205/IN405	IN172/10	..line-up terminals (RAC2/RAC3)
2AD160B-B.....BS*3..... (PG29)	IKL169/IKF169	*)	..stay bolt M8 ⊕ M8	IN206/IN406	IN172/16	..line-up terminals (RAC2/RAC3)
2AD160C-B.....BS*3..... (PG42)	not available	not available	..stay bolt M8 ⊕ M8	IN207/IN407	IN172/25	..line-up terminals (RAC2/RAC3)
2AD180C-B.....BS*3..... (PG42)	not available	not available	..stay bolt M10 ⊕ M10	IN267	not available	..line-up terminals (RAC2/RAC3)
2AD180D-B.....BS*3..... (PG42)	not available	not available	..stay bolt M10 ⊕ M10	IN267	not available	..line-up terminals (RAC2/RAC3)
2AD200C-B.....AS*3..... (PG48)	not available	not available	For.			For.
			..stay bolt M10 ⊕ M10	IN268	not available	..Screws M12(RAC4)
			..stay bolt M12 ⊕ M12	2 x IN207/2 x IN 407	not available	..Screws M12(RAC4)

Symbols:



*) Available. For inquiries on type information contact Development Dept., INDRAMAT.

ALKAB06

Figure 2.24: Table of assembled specifications for connections with plugin testing points in 2AD motors - Section 2.

Section 1: 1MB power connections - plugin testing points

Motor model (PG)	Cable cross section A [mm ²]	Assembled cables for direct connection		Components of assembled cables for direct connections			Assembled cables for intermediate terminals on terminal strips	
		Assembled cables for direct connection	on the motor	Cable flex./highly flex.	on the controller	on the motor flex./highly flex.	on the controller flex./highly flex.	
1MB160E-4B...			For...		For...			
1MB160B-4A... (PG 29)	10	IKL135/IKF135	..stay bolt M6 ⊕ M8	IN205/IN405	..stay bolt M6 (KDA/TDA)	IKL136/IKF136	not available	
1MB160D-4A... (PG 29)	10	IKL135/IKF135	..stay bolt M6 ⊕ M8	IN205/IN405	..stay bolt M6 (KDA/TDA)	IKL136/IKF136	not available	
1MB160F-4A... (PG 29)	25	IKL174/IKF174	..stay bolt M8 ⊕ M8	IN207/IN407	..stay bolt M6 (KDA/TDA)	IKL172/IKF172	not available	
1MB200D-4E... (PG 29)	25	IKL174/IKF174	..stay bolt M8 ⊕ M8	IN207/IN407	..stay bolt M6 (KDA/TDA)	IKL172/IKF172	not available	
1MB200D-4C... (PG)								
1MB240B-4A... (PG 29)	10	IKL135/IKF135	..stay bolt M6 ⊕ M8	IN205/IN405	..stay bolt M6 (KDA/TDA)	IKL136/IKF136	not available	
1MB240D-4A... (PG 29)	10	IKL135/IKF135	..stay bolt M6 ⊕ M8	IN205/IN405	..stay bolt M6 (KDA/TDA)	IKL136/IKF136	not available	
1MB240F-4A... (PG 29)	25	IKL174/IKF174	..stay bolt M8 ⊕ M8	IN207/IN407	..stay bolt M6 (KDA/TDA)	IKL172/IKF172	not available	
1MB240H-4A... (PG 29)	25	IKL174/IKF174	..stay bolt M8 ⊕ M8	IN207/IN407	..stay bolt M6 (KDA/TDA)	IKL172/IKF172	not available	
1MB241H-6C... (PG 29)	25	IKL174/IKF174	..stay bolt M8 ⊕ M8	IN207/IN407	..stay bolt M6 (KDA/TDA)	IKL172/IKF172	not available	
1MB310B-6A... (PG)								

Symbols:

*) Available. For inquiries on type information contact Development Dept., INDRAMAT.

ALKAB07

Figure 2.25: Table of assembled specifications for direct connection and for intermediate terminals on terminals strips in 1MB motors - Section 1.

Section 2: 1MB power connections - plugin testing points

1MB Frameless Spindle Motor	Assembled cables for direct connection	Components of the assembled cable for direct connection		Assembled cables for intermediate terminals on terminal strips on the controller flex./highly flex.	
		on the motor	Cable flex./highly flex.	on the controller	on the motor flex./highly flex.
1MB160F-4B... (PG)		For...	For...		
1MB200D-4B... (PG 29)	10	..stay bolt M6 ⊕ M8	IN205/IN405	...line-up terminals (RAC2 /RAC3)	IKL136/IKF136 not available
1MB200D-4D... (PG)					
1MB200E-4B... (PG)					
1MB200H-4B... (PG)					
1MB240F-4B... (PG)					
1MB240H-4B... (PG 29)	16	..stay bolt M8 ⊕ M8	IN206/IN406	...line-up terminals (RAC2 /RAC3)	IKL151/IKF151 not available
1MB241H-6D... (PG 29)	10	..stay bolt M6 ⊕ M8	IN205/IN405	...line-up terminals (RAC2 /RAC3)	IKL136/IKF136 not available
1MB310B-6B... (PG 29)	25	..stay bolt M8 ⊕ M8	IN207/IN407	...line-up terminals (RAC2 /RAC3)	IKL171/IKF171 not available
1MB310D-6B... (PG 29)	25	..stay bolt M8 ⊕ M8	IN207/IN407	...line-up terminals (RAC2 /RAC3)	IKL171/IKF171 not available
1MB310F-6B... (PG 42)	35	..stay bolt M10 ⊕ M10	IN267	...line-up terminals (RAC2 /RAC3)	IKL182/ *) not available
1MB312B-4A... (PG 29)	25	..stay bolt M8 ⊕ M8	IN207/IN407	...line-up terminals (RAC2 /RAC3)	IKL171/IKF171 not available
1MB312C-4A... (PG 29)	35	..stay bolt M10 ⊕ M10	IN267	...line-up terminals (RAC2 /RAC3)	IKL182/ *) not available

AL/KAB08









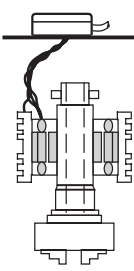

Symbols:

- Power plug connector (plug)
- Power plug connector (coupling)
- PG screw connection
- Wire-end ferrule
- Crimping cable lug
- Flange connection

*) Available. For inquiries on type information contact Development Dept., INDRAMAT.

Figure 2.26: Table of assembled specifications for direct connection and for intermediate terminals on terminals strips in 1MB motors - Section 2.

Section 3: 1MB power connections - direct connections and intermediate terminals

Cable cross section A [mm ²]	Assembled cables for direct connections	Components of the assembled cables for direct connections		Assembled cable for intermediate terminals on terminal strips on the controller flex./highly flex.	
		on the motor	Cable flex./highly flex.	on the controller	on the motor flex./highly flex.
 1MB375B-6B... (PG)		 For...		 For...	
1MB375D-6B... (PG)		 For...		 For... ..Screws M12(RAC4)	

ALKAB09











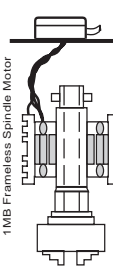



Symbols:

-  Power plug connector (plug)
-  Power plug connector (coupling)
-  PG screw connection
-  Wire-end ferrule
-  Crimping cable lug
-  Flange connection







*) Available. For inquiries on type information contact Development Dept., INDRAMAT.

Figure 2.27: Table listing information on assembled cables for direct connections and for intermediate terminals on terminal strips in 1MB motors - Section 3.

Section 1: 1MB power connections - plug design

1MB Frameless Spindle Motor 	Cable cross section A[mm ²]	Assembled cables for plug design		Components of assembled cables with plug design				
		on the motor flex. /highly flex.	on the controller flex. /highly flex.	on the motor	Cable flex. /highly flex.	plug design	L. on the controller	
1MB160E-4B... (PG)				For..				For..
1MB160B-4A... (PG 29)	10	IKL137/IKF137	*)	..stay bolt M6 	IN205/IN405	IN217/10	dto.	..stay bolt M6 (KDA/TDA)
1MB160D-4A... (PG 29)	10	IKL137/IKF137	*)	..stay bolt M6 	IN205/IN405	IN217/10	dto.	..stay bolt M6 (KDA/TDA)
1MB160F-4A... (PG 29)	25	IKL173/IKF173	*)	..stay bolt M8 	IN207/IN407	IN217/25	dto.	..stay bolt M6 (KDA/TDA)
1MB200D-4E... (PG 29)	25	IKL173/IKF173	*)	..stay bolt M8 	IN207/IN407	IN217/25	dto.	..stay bolt M6 (KDA/TDA)
1MB200D-4C... (PG)								
1MB240B-4A... (PG 29)	10	IKL137/IKF137	*)	..stay bolt M6 	IN205/IN405	IN217/10	dto.	..stay bolt M6 (KDA/TDA)
1MB240D-4A... (PG 29)	10	IKL137/IKF137	*)	..stay bolt M6 	IN205/IN405	IN217/10	dto.	..stay bolt M6 (KDA/TDA)
1MB240F-4A... (PG 29)	25	IKL173/IKF173	*)	..stay bolt M8 	IN207/IN407	IN217/25	dto.	..stay bolt M6 (KDA/TDA)
1MB240H-4A... (PG 29)	25	IKL173/IKF173	*)	..stay bolt M8 	IN207/IN407	IN217/25	dto.	..stay bolt M6 (KDA/TDA)
1MB241H-6C... (PG 29)	25	IKL173/IKF173	*)	..stay bolt M8 	IN207/IN407	IN217/25	dto.	..stay bolt M6 (KDA/TDA)
1MB310B-6A... (PG)								

Symbols:

-  Power plug connector (plug)
-  Power plug connector (coupling)
-  PG screw connection
-  Wire-end ferrule
-  Crimping cable lug
-  Flange connection

*) Available. For inquiries on type information contact Development Dept., INDRAMAT.

Attention!
Flange connection IN218 must have an insulator casing which juts out over the contacts on the soldered or crimped side by approx. 3 mm!
Do not use any other type!

ALC00870

Figure 2.28: Table of specifications for assembled cables with plug design in 1MB motors - Section 1.

Section 2: 1MB power connections - plug design

1MB Frameless Spindle Motor	Cable cross section A[mm ²]	Assembled cable for plug design		Components of assembled cable with plug design				
		on the motor flex. /highly flex.	on the controller flex. /highly flex.	on the motor	Cable flex. /highly flex.	Plug design	L. on the controller	
1MB160F-4B... (PG)				For..		see "Attention" below!		For..
1MB200D-4B... (PG 29)	10	IKL137/IKF137	*	..stay bolts M6 ⊕ M8	IN205/IN405	IN217/10	IN218/10	..line-up terminals (RAC2/RAC3)
1MB200D-4D...								
1MB200E-4B...								
1MB200H-4B...								
1MB240F-4B... (PG)								
1MB240H-4B... (PG 29)	16	IKL153/IKF153	*	..stay bolts M8 ⊕ M8	IN206/IN406	IN217/16	IN218/16	..line-up terminals (RAC2/RAC3)
1MB241H-6D... (PG 29)	10	IKL137/IKF137	*	..stay bolts M6 ⊕ M8	IN205/IN405	IN217/10	IN218/10	..line-up terminals (RAC2/RAC3)
1MB310B-6B... (PG 29)	25	IKL173/IKF173	*	..stay bolts M8 ⊕ M8	IN207/IN407	IN217/25	IN218/25	..line-up terminals (RAC2/RAC3)
1MB310D-6B... (PG 29)	25	IKL173/IKF173	*	..stay bolts M8 ⊕ M8	IN207/IN407	IN217/25	IN218/25	..line-up terminals (RAC2/RAC3)
1MB310F-6B... (PG 42)	35	not available	not available	..stay bolts M10 ⊕ M10	IN267	not available	not available	..line-up terminals (RAC2/RAC3)
1MB312B-4A... (PG 29)	25	IKL173/IKF173	*	..stay bolts M8 ⊕ M8	IN207/IN407	IN217/25	IN218/25	..line-up terminals (RAC2/RAC3)
1MB312C-4A... (PG48)	35	not available	not available	..stay bolts M10 ⊕ M10	IN267	not available	not available	..line-up terminals (RAC2/RAC3)

Symbols:

- Power plug connector (plug)
- Power plug connector (coupling)
- PG screw connection
- Wire-end ferrule
- Crimping cable lug
- Flange connection











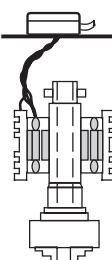

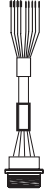
*) Available. For inquiries on type information contact Development Dept., INDRAMAT.

Attention!
Flange connector IN218 must have an insulator casing which juts out over the contacts on the soldered or crimped side by approx. 3 mm!
Do not use any other types!

ALKAB11

Figure 2.29: Table of specs on assembled cables with plug design for 1MB motors - Section 2.

Section 3: 1MB power connections - plug design

Cable cross section A[mm ²]	Assembled cable for plug design		Components of assembled cables with plug design			
	on the motor flex. /highly flex.	on the controller flex. /highly flex.	on the motor	Cable flex. /highly flex.	Plug design	L. on the controller
 1MB375B-6B... (PG)			 For..		 see "Attention" below!	 For.. ..line-up terminals (RAC2/RAC3)
1MB375D-6B... (PG)			 For..		 see "Attention" below!	 For.. ..screws M12(RAC4)

Symbols:







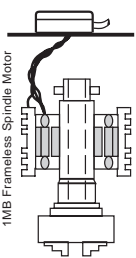

Attention!
 Flange connection IN218 must have an insulator casing which juts out over the contacts on the soldered or crimped side by approx. 3 mm!
 Do not use any other types!

ALKAB12

Figure 2.30: Specifications table on assembled cables with plug design for 1MB motors - Section 3.

Section 1: 1MB power connections - plugin testing points

1MB Frameless Spindle Motor 	Cable cross section A[mm ²]	Assembled cable for plugin testing points		Components of preassembled cables with plugin testing points			
		on the motor flex. /highly flex.	on the controller flex. /highly flex.	on the motor	Cable flex. /highly flex.	Plug testing points	L. on the controller
1MB160E-4B... (PG)				For.			
1MB160B-4A... (PG 29)	10	IKL129/IKF129	IKL130/IKF130	..stay bolt M6 ⊕ M8	IN205/IN405	IN210/10	dto. ..stay bolt M6 (KDA/TDA)
1MB160D-4A... (PG 29)	10	IKL129/IKF129	IKL130/IKF130	..stay bolt M6 ⊕ M8	IN205/IN405	IN210/10	dto. ..stay bolt M6 (KDA/TDA)
1MB160F-4A... (PG 29)	25	IKL169/IKF169	IKL170/IKF170	..stay bolt M8 ⊕ M8	IN207/IN407	IN210/25	dto. ..stay bolt M6 (KDA/TDA)
1MB200D-4E... (PG 29)	25	IKL169/IKF169	IKL170/IKF170	..stay bolt M8 ⊕ M8	IN207/IN407	IN210/25	dto. ..stay bolt M6 (KDA/TDA)
1MB200D-4C... (PG)							
1MB240B-4A... (PG 29)	10	IKL129/IKF129	IKL130/IKF130	..stay bolt M6 ⊕ M8	IN205/IN405	IN210/10	dto. ..stay bolt M6 (KDA/TDA)
1MB240D-4A... (PG 29)	10	IKL129/IKF129	IKL130/IKF130	..stay bolt M6 ⊕ M8	IN205/IN405	IN210/10	dto. ..stay bolt M6 (KDA/TDA)
1MB240F-4A... (PG 29)	25	IKL169/IKF169	IKL170/IKF170	..stay bolt M8 ⊕ M8	IN207/IN407	IN210/25	dto. ..stay bolt M6 (KDA/TDA)
1MB240H-4A... (PG 29)	25	IKL169/IKF169	IKL170/IKF170	..stay bolt M8 ⊕ M8	IN207/IN407	IN210/25	dto. ..stay bolt M6 (KDA/TDA)
1MB241H-6C... (PG 29)	25	IKL169/IKF169	IKL170/IKF170	..stay bolt M8 ⊕ M8	IN207/IN407	IN210/25	dto. ..stay bolt M6 (KDA/TDA)
1MB310B-6A... (PG)							

ALKAB13

Symbols:

-  Power plug connector (plug)
-  Power plug connector (coupling)
-  PG screw connection
-  Multi-core cable end
-  Crimping cable lug
-  Flange connection

*) Available. For inquiries on type information contact Development Dept., INDRAMAT.

Figure 2.31: Specifications table on assembled cables for connection with plugin testing points in 1MB motors - Section 1.

Section 2: 1MB power connections - plugin testing points

1MB Frameless Spindle Motor	Cable cross section A[mm ²]	Assembled cable for plugin testing points		Components of a assembled cables with plugin testing points			
		on the motor flex. /highly flex.	on the controller flex. /highly flex.	on the motor flex. /highly flex.	Plug testing point	L.	on the controller
1MB160F-4B... (PG)							
1MB200D-4B... (PG 29)	10	IKL129/IKF129	IKL134/ *)	..stay bolt M6 ⊕ M8	IN217/10	IN172/10	..line-up terminals (RAC2/RAC3)
1MB200D-4D... (PG)							
1MB200E-4B... (PG)							
1MB200H-4B... (PG)							
1MB240F-4B... (PG)							
1MB240H-4B... (PG 29)	16	IKL149/IKF149	*)	..stay bolt M8 ⊕ M8	IN210/16	IN172/16	..line-up terminals (RAC2/RAC3)
1MB241H-6D... (PG 29)	10	IKL129/IKF129	IKL134/ *)	..stay bolt M6 ⊕ M8	IN217/10	IN172/10	..line-up terminals (RAC2/RAC3)
1MB310B-6B... (PG 29)	25	IKL169/IKF169	*)	..stay bolt M8 ⊕ M8	IN210/25	IN172/25	..line-up terminals (RAC2/RAC3)
1MB310D-6B... (PG 29)	25	IKL169/IKF169	*)	..stay bolt M8 ⊕ M8	IN210/25	IN172/25	..line-up terminals (RAC2/RAC3)
1MB310F-6B... (PG 42)	35	not available	not available	..stay bolt M10 ⊕ M10	not available	not available	..line-up terminals (RAC2/RAC3)
1MB312B-4A... (PG 29)	25	IKL169/IKF169	*)	..stay bolt M8 ⊕ M8	IN210/25	IN172/25	..line-up terminals (RAC2/RAC3)
1MB312C-4A... (PG 29)	35	not available	not available	..stay bolt M10 ⊕ M10	not available	not available	..line-up terminals (RAC2/RAC3)

ALKAB14

Symbols:

- Power plug connector (plug)
- Power plug connector (coupling)
- PG screw connection
- Wire-end ferrule
- Flange connection
- Crimping cable lug

*) Available. For inquiries on type information contact Development Dept., INDRAMAT.

Figure 2.32: Specifications table on assembled cables for connection with plugin testing points in 1MB motors - Section 2.

2.1.4. Cable Specifications

Cable Type	Cable cross Section in mm ²	Cable Construction	Diameter in mm	Bending Radius in mm		Weight in kg/m
				fixed	flexible	
IN 203	4	4x4,0 + 2x(2x1,5)StC mm ²	18,5 ± 1,0	120	270	0,570
IN 204	6	4x6,0 + 2x(2x1,5)StC mm ²	18,0 ± 1,0	120	300	0,670
IN 205	10	4x10,0 + 2x(2x1,5)StC mm ²	26,0 ± 1,0	200	380	1,100
IN 206	16	4x16,0 + 2x(2x1,5)StC mm ²	26,0 ± 1,0	220	390	1,330
IN 207	25	4x25,0 + 2x(2x1,5)StC mm ²	28,5 ± 1,0	240	430	1,700
IN 267	35	4x35,0 + 2x(2x1,5)StC mm ²	32,0 ± 1,0	150	250	2,170
IN 403	4	4x4,0 + (2x0,75)StC + (2x1,0)StC mm ²	15,5 ± 1,0	95	160	0,373
IN 404	6	4x6,0 + (2x0,75)StC + (2x1,0)StC mm ²	18,0 ± 1,0	105	175	0,500
IN 405	10	4x10,0 + (2x0,75)StC + (2x1,0)StC mm ²	21,5 ± 1,0	130	220	0,740
IN 406	16	4x16,0 + 2x(2x1,0)StC mm ²	25,0 ± 1,0	150	250	1,100
IN 407	25	4x25,0 + (2x0,75)StC mm ²	26,0 ± 1,0	140	200	0,500

Figure 2.34: Cable specifications for power connections

2.2. Power connections of the RAC three-phase mains

The power connections between the RAC main spindle controller and the three-phase mains are arranged in ...

Section 2.2.1: Three-phase mains requirements for direct connection of RAC controllers to

- grounded three-phase mains, and,
- ungrounded three-phase mains.

Section 2.2.2: Connecting diagrams for

- grounded three-phase mains, and,
- ungrounded three-phase mains.

Section 2.2.3: Tabulated specifications of connecting components, such as,

- required connection cross sections,
- fuses for cable protection,
- power transformers, if needed,
- surge protector type designations, if needed,
- design of connections on the controller.

Types

The power connections of the RAC controller three-phase mains are generally internal control cabinet cables which are, for the sake of expediency, constructed with single strands. Motor connection cables from INDRAMAT can, however, also be used.

2.2.1. Three-Phase Mains Requirements

Permissible mains voltage

Dependent upon the „AC supply voltage“ option, the following mains voltages are permissible for RAC controllers:

Type key field no. 5, „Rated connection voltage“ for.. ..RAC2.2 ..RAC 4.1 ..RAC 3.1	Voltage permitted at X14/L1,L2,L3
380 /	3xAC 400V, -15%/+10%, 50..60 Hz
460 460 /	3xAC 400V, -15%/+15%, 50 Hz 3xAC 460V, -10%/+10%, 60 Hz
/ 460	3xAC 380 ... 460V/ ±10%, 50..60 Hz
Type key field no. 11, „Rated connection voltage for control electronics.“ Only in RAC 3.1	Voltage permitted at X14/L,N
220	AC 220V, ±10%, 50..60 Hz, 200VA

Figure 2.35: Permissible mains voltage for RAC controllers.

Periodic voltages

Voltage at the RAC should not be permitted to periodically exceed 1000 V (peak value) between the outer wire (terminal L1, L2, L3) and the housing!

Non-periodic overvoltage

Non-periodic overvoltages between the outer wire and housing are tolerable for RAC controllers, if these are in accordance with VDE 0160 (see Fig. 2.36)!

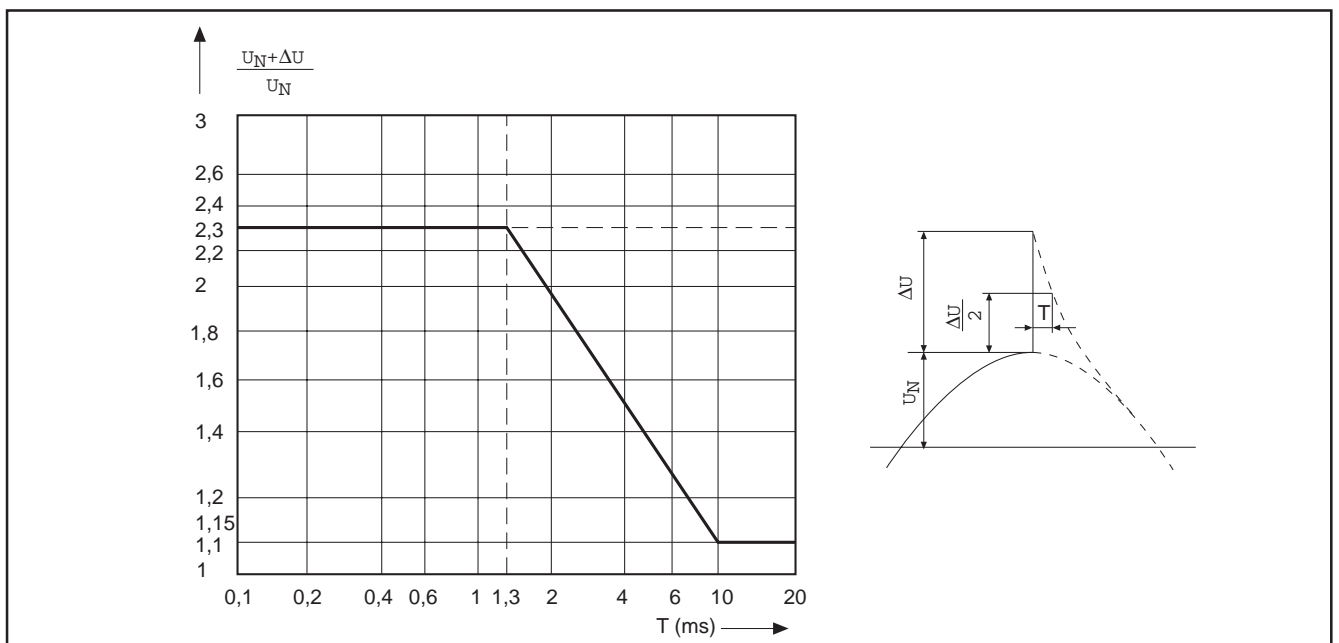

Figure 2.36: Non-periodic overvoltages as per VDE 0160.

The peak value of the rated voltage equals $U_N = 460V \cdot \text{square root of } 2 = 650V$. Maximum tolerable, non-periodic voltage peak equals 1500 V for $T < 1.3 \text{ ms}$.

Grounded Three-Phase Mains

RAC controllers can be directly connected to Wye-point and three-phase mains grounded on the outer wire. Should the mains voltage not agree with the RAC rated connection voltage, then an autotransformer is needed to equalize the voltage (see Figure 2.37)!

Ungrounded Three-Phase Mains

Ungrounded three-phase mains run increased danger of unsafe overvoltages occurring between the outer wire and the housing. RAC controllers can only be operated on these mains

- if the drive is connected via an isolating transformer, or,
- if surge arresters safeguard the facility.

Connection via an Isolating Transformer

The RAC controller is most protected against damage from overvoltage when it is connected via an isolating transformer. The drive operates with the greatest possible safety. The use of an isolating transformer is recommended in that case where an ungrounded three-phase mains also requires voltage to be matched to the permissible connection voltage of the unit (see Figure 2.38).

Surge Arresters as Safeguards

RAC controllers may only then be operated with ungrounded three-phase mains if the facility is secured with a surge arrester. An autotransformer can be used in the event that voltage must be matched to the permissible rated connection voltage of the unit.

The recommended surge arrester safeguards upto a leakage current of $I^2t = 750A^2s$. For thermal reasons, greater leakage currents evoke a response from the signal contact of the surge arrester.

The signal contact expediently triggers the separation of the machine from the mains (see Figure 2.39). Should this not be possible, then the signal contact is switched into the control system of the mains contactor of the RAC (see Figure 2.40).

The operational safety of the drives is greater if an isolating transformer is used, than if a surge arrester is used. The initial expense with larger loads is, however, significantly smaller. The surge arresters are destroyed after one use and must be exchanged!

2.2.2. Connection Plans

Grounded Three-Phase Mains

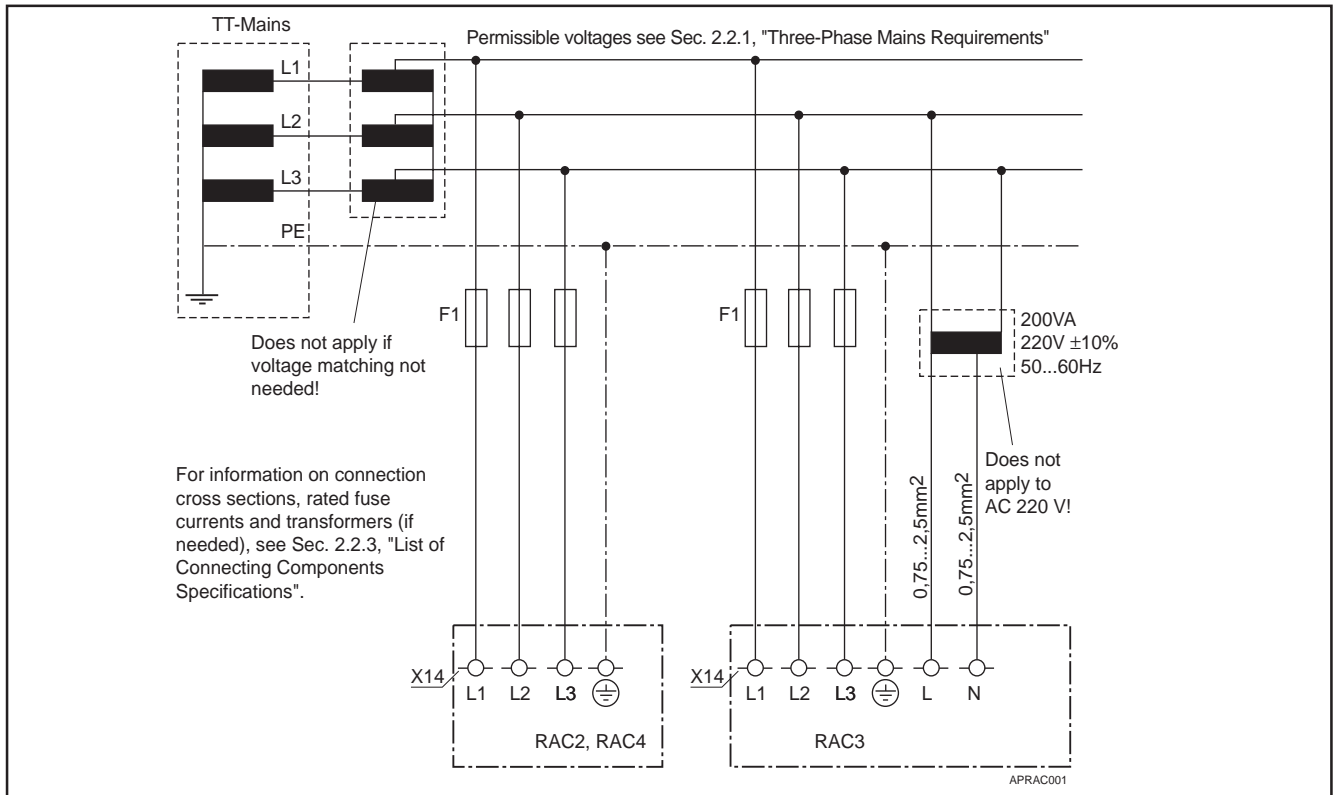

Figure 2.37: Connecting RAC2, RAC3 and RAC4 to a grounded three-phase mains.

Ungrounded Three-Phase Mains

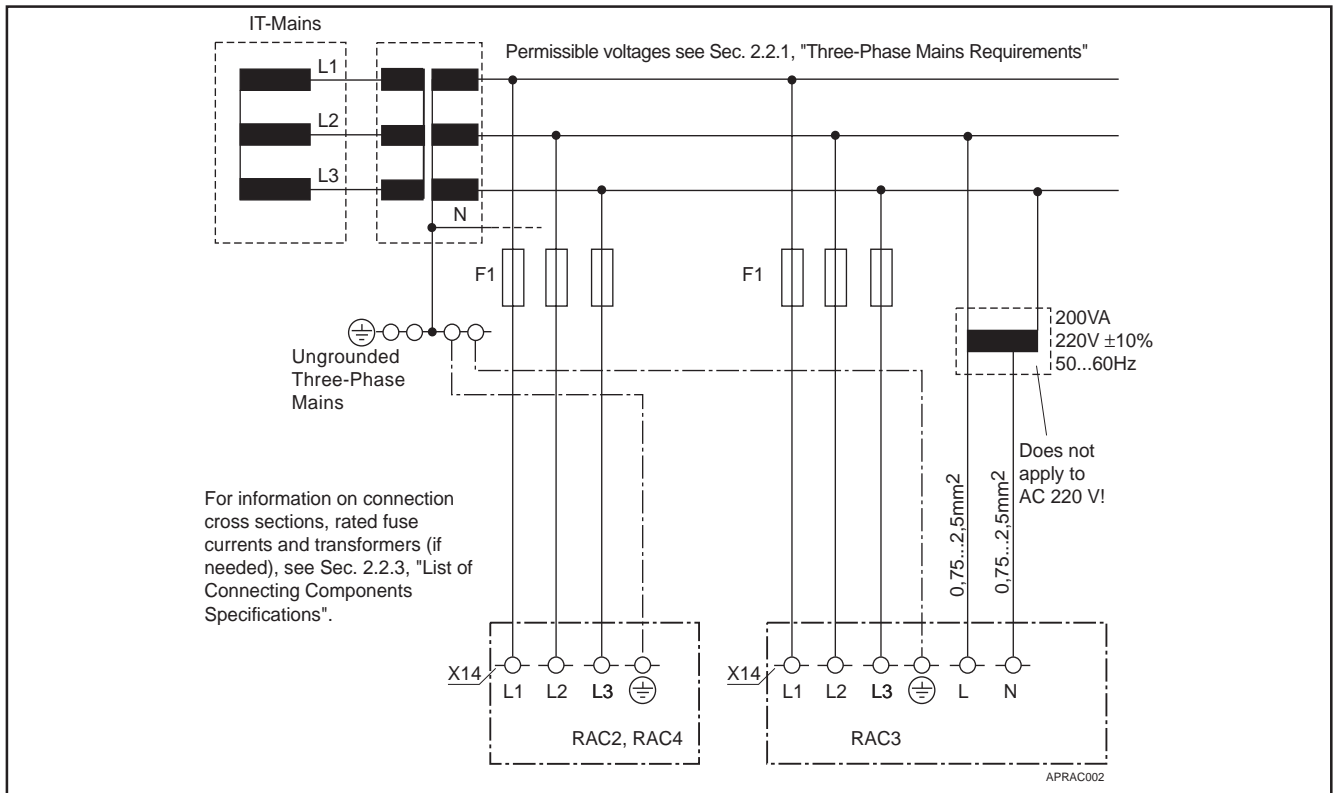

Figure 2.38: Connecting RAC2, RAC3 and RAC4 to an ungrounded three-phase mains using an isolating transformer.



An earth leakage circuit breaker (FI) should not be built into the RAC controllers!

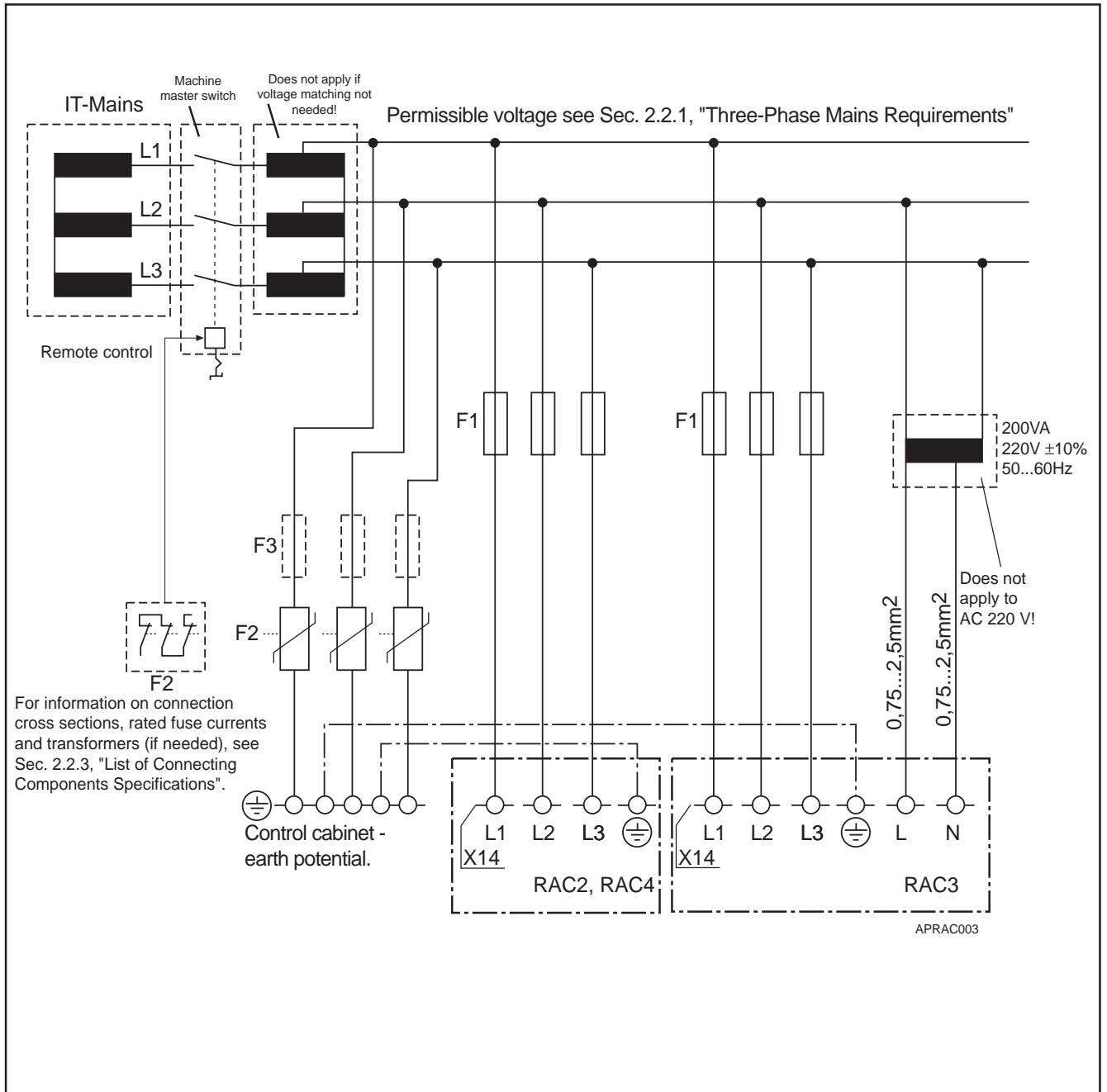

Figure 2.39: Connecting RAC2, RAC3 and RAC4 to ungrounded three-phase mains, actuation of surge arrester triggers mains separation.

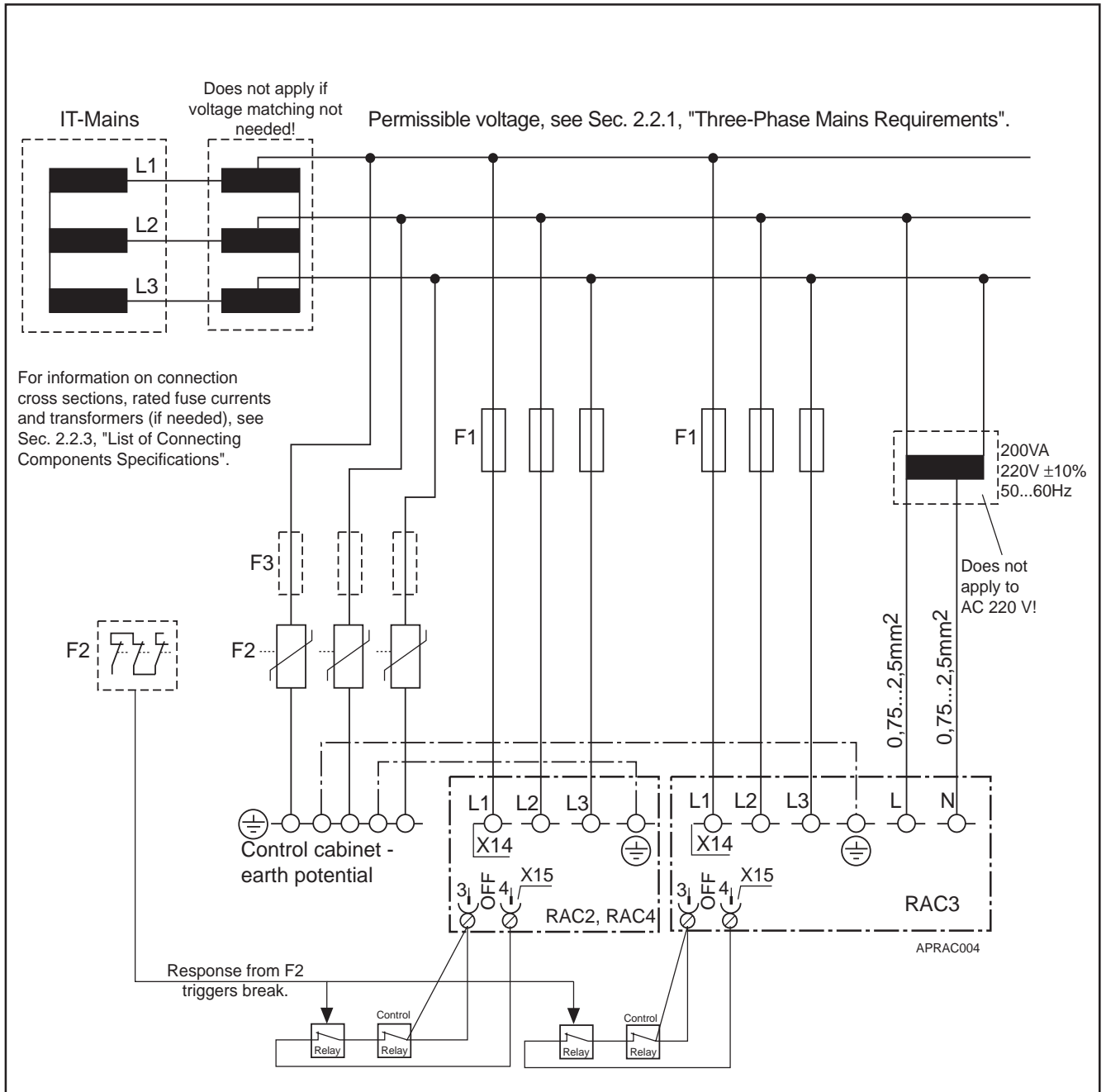

Figure 2.40: Connecting RAC2, RAC3 and RAC4 to ungrounded three-phase mains, actuation of surge arrester triggers release of mains contactor in the RAC.

For thermal reasons, the surge arresters disconnect at $I^2t=750A^2s$ (30s at 5A) once they are actuated (leakage current). They are then no longer functional and must be exchanged!



An earth leakage circuit breaker (FI) must not be built into the RAC controller!

2.2.3. Connecting Components Data List

Connection cross section,
type of fuse

The dimensions of the mains fuse and the mains connection cable are dependent upon the rated output of the main spindle motor operated on the RAC controller.

If the rated output of the main spindle motor is fully utilized during a processing cycle, then the following values are achieved:

Main spindle motor	P _{Rated} in kW	I _{Mains RAC} in A	Fuse F1, Type	Cable cross section in mm ²
2AD132B-...-DS	10	19		
1MB200E-4B-...	11	21	3xNH25gl	4
1MB240F-4B-...	11	26		
2AD132C-...-CS	15	29		
1MB240H-4B-...	15	29		
1MB241H-6D-...	16	30	3xNH35gl	6
1MB200D-4D-...	19	36		
1MB310B-6B-...	19	36		
1MB200H-4B-...	19,5	37		
1MB312B-4A-...	20	38		
2AD132D-...-AS	22	42	3xNH50gl	10
1MB310D-6B-...	25	48		
1MB312C-4A-...	25	48		
2AD160B-...-BS	30	57	3xNH63gl	16
1MB310F-6B-...	35	66		
2AD160C-...-BS	37	70	3xNM80gl	25
1MB375B-6B-...	40	76		
2AD180C-...-BS	52	99	3xNH100gl	35
1MB375B-6B-...	55	105		
2AD180D-...-BS	63	120	3xNH125gl	50
2AD200C-...-AS	79	150	3xNH160gl	2x25
2AD225C-...-AS	93	176	3xNH200gl	2x35

Figure 2.41: Mains connection specifications with rated service of main spindle motors, or frameless spindle motors (valid for 3 x AC 380 V ... 3 X AC 460 V).

Appropriate circuit breakers can be used instead of NH-fuses!

Should the rated power of the main spindle motor not be completely utilized during the duty cycle, including acceleration and braking, then the RAC mains connection can be engineered lower. The minimum values for the connecting components must, however, be adhered to! Wiring and overload problems could occur (with load peak current), if these minimum values are not achieved!

Controller Type	Min. Fuse F1, Type	Min. conductor Cross Section in mm ²
RAC3.1-100-...	3xNH25gl	4
RAC3.1-150-...	3xNH35gl	6
RAC2.2-200-...	3xNH50gl	10
RAC2.2-250-...	3xNH63gl	16
RAC4.1-300-...	3xNH80gl	25
RAC4.1-400-...	3xNH25gl	25

Figure 2.42: Minimum values of the connecting components

$$I_{\text{MainsRAC}} = 1,9 \cdot P_{\text{Cont.Motor}} \text{ * A/kW}$$

$P_{\text{Cont.Motor}}$ = continuous output (kw) actually required of the motor

(Formula applies to 3 x AC 380 V ... 3 x AC 460 V).

Using the load capacity table in Fig. 1.7, the calculated mains current, I_{mainsRAC} , is allocated to a cable cross section. The selected cross section and its corresponding fuse must not fall short of the minimum values listed in Figure 2.42!

Sizing the Autotransformer

The output, S_{mains} , of a possibly needed autotransformer, corresponds to the rated output, or the actually required continuous output of the main spindle motor. The inductive components of the relative short-circuit voltage, u_{kx} , must be smaller than 4%!

$$S_{\text{Mains}} = \sqrt{3} \cdot U_{\text{X14/L1-L2}} \cdot I_{\text{MainsRAC}}$$

$U_{\text{X14/L1-L2}}$ = Voltage at the RAC mains connection terminals (most favorable value: 3 x AC 400 V)

I_{MainsRAC} (see formula above)

$$u_{\text{kx}} = U_{\text{KX1}} / U_{\text{Rated1}} \cdot 100\%$$

U_{KX1} = Prim. short-circuit voltage in V, inductive component

U_{Rated1} = Rated voltage of the transformer in V, primary

Sizing the Isolating Transformer

The output, S_{mains} , of an isolating transformer, if needed, also depends upon the rated output, or the actual continuous output required of the main spindle motor.

The stray inductance of an isolating transformer is significantly higher than that of an autotransformer. Depending upon the type of RAC, the minimum transformer output of the isolating transformer must, as a result, achieve the minimum value! The inductive component of the relative short-circuit voltage, U_{kx} , must be smaller than 4%!

Controller Type	Minimum Output SMains (kVA)
RAC3.1-100-...	25
RAC3.1-150-...	40
RAC2.2-200-...	50
RAC2.2-250-...	65
RAC4.1-300-...	80
RAC4.1-400-...	100

Figure 2.43: Minimum transformer output if the RAC controller is connected via an isolating transformer.

The already stated formulae are used to calculate the mains current, $I_{mainsRAC}$, and the mains connection output, S_{mains} , of the main spindle motor:

$$I_{mainsRAC} = 1,9 * P_{cont.Motor} * A/kW$$

$P_{cont.Motor}$ = continuous output (kw) actually demanded of motor

(Formula valid for 3 x AC 380 V ... 3 x AC 460 V.)

$$S_{mains} = \sqrt{3} * U_{X14/L1-L2} * I_{mainsRAC}$$

$U_{X14/L1-L2}$ = Voltage at mains connection terminals of RAC (most favorable value: 3 x AC 400 V)

$I_{mainsRAC}$ (see above formula)

Overvoltage Protectors

Controller Type	Fuse F3 Type	Surge arrester F2, Type
RAC3.1-100-...	---	 VM 500 FM (Manufactured by DEHN)
RAC3.1-150-...	---	
RAC2.2-200-...	---	
RAC2.2-250-...	3x100Agl	
RAC4.1-300-...	3x100Agl	
RAC4.1-400-...	3x100Agl	

Figure 2.44: Specifications for surge arresters in an ungrounded three-phase mains.

Controller Lay-Out

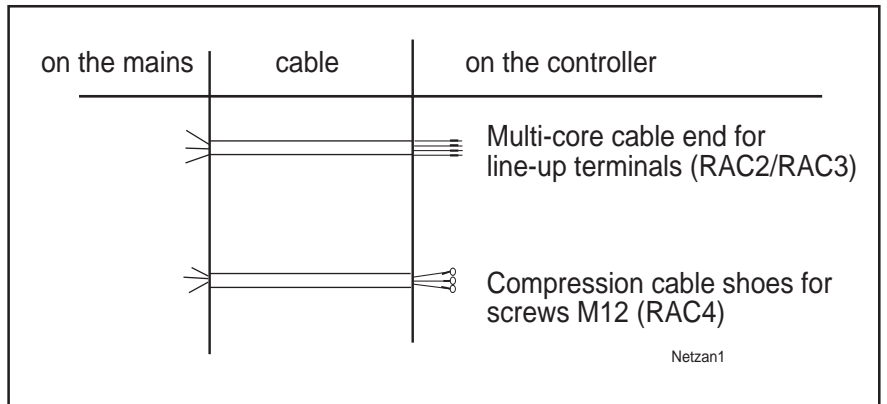

Figure 2.45: Mains connection cable for RAC controllers.

3. Feedback and CNC Connections

Signal exchange with the CNC control takes place via the CNC connections; feedback of position or speed of the motor shaft and the spindle to the main spindle controller via the feedback connections.

The Section on feedback and CNC connections is broken down into

Section 3.1: Division of the types of connections

- direct connection
- connection with link terminal
- connection with plug design
- connection with plugin testing points

Section 3.2: Connection diagrams for the direct connection of

- CNC control and controller
- feedback and controller for all standard interfaces and optional interfaces

Section 3.3: Specifications table of the assembled cables for

- direct connection and connections using link terminals
- connection with plug design
- connection with plugin testing points

Section 3.4: Specifications table for cables, such as,

- type designation
- conductor cross sections and cable construction
- cable diameter
- inflection radii, and,
- length-related weight

3.1. Types of feedback and CNC connections

There are four types of assembled feedback and CNC connections.

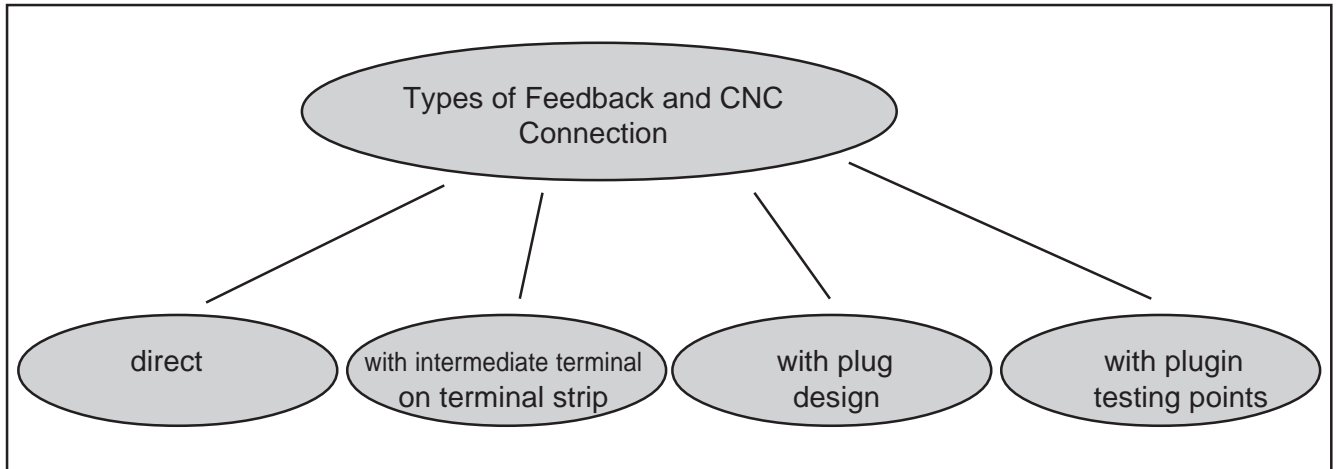

Figure 3.1: Four types of assembled feedback and CNC connections

Direct connection

This type of connection is characterized by the lowest number of imperfections in comparison to other connection types.

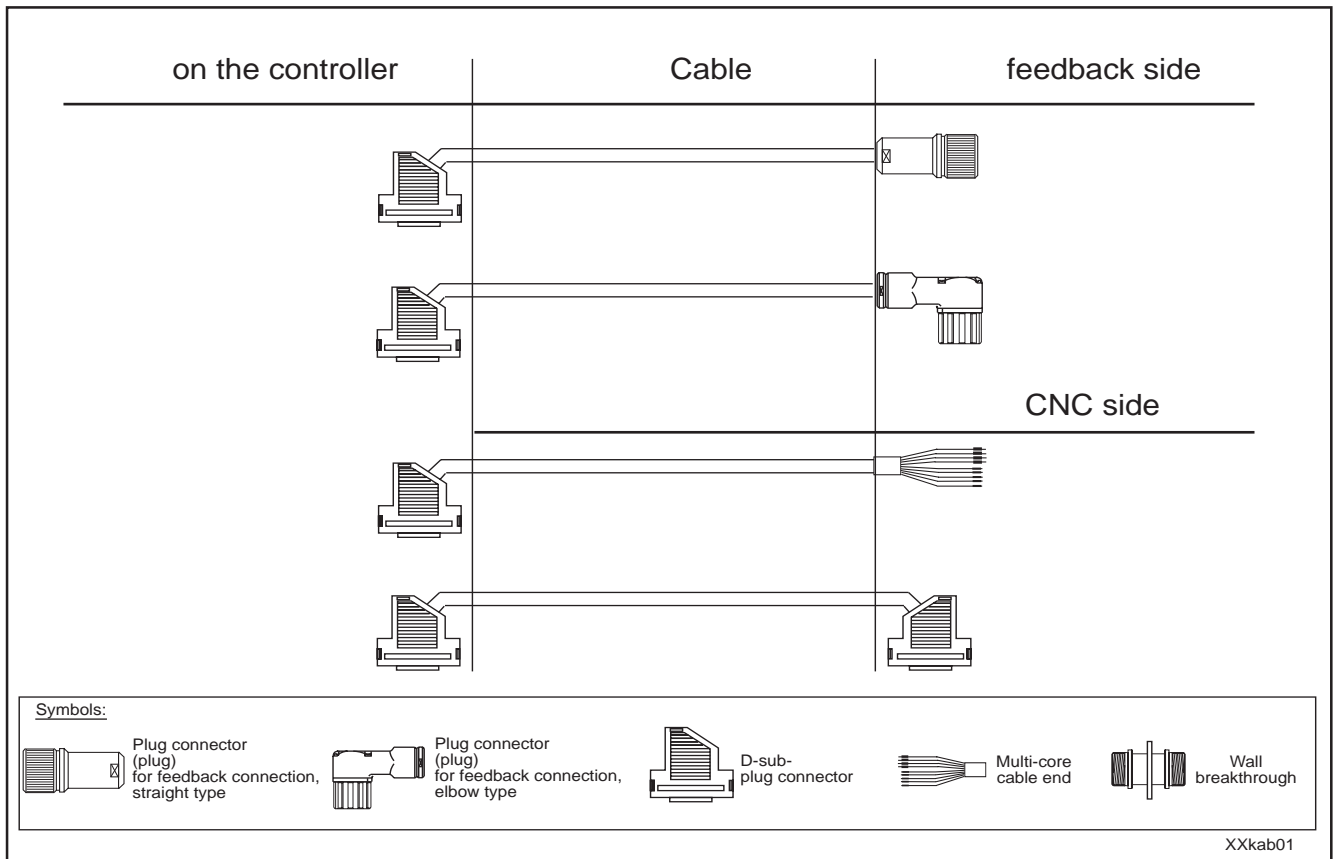

Figure 3.2: Assembled cables for direct connections (also see figure 3.22).

Connection with Intermediate Terminals

This type of connection permits an easy diagnosis of the signal exchange to the CNC control at the intermediate terminal points.

Intermediate terminals in feedback connections with incremental encoder are not to be recommended because of increased sensitivity to interference! Intermediate terminals are not permitted with high-resolution motor and spindle feedback!

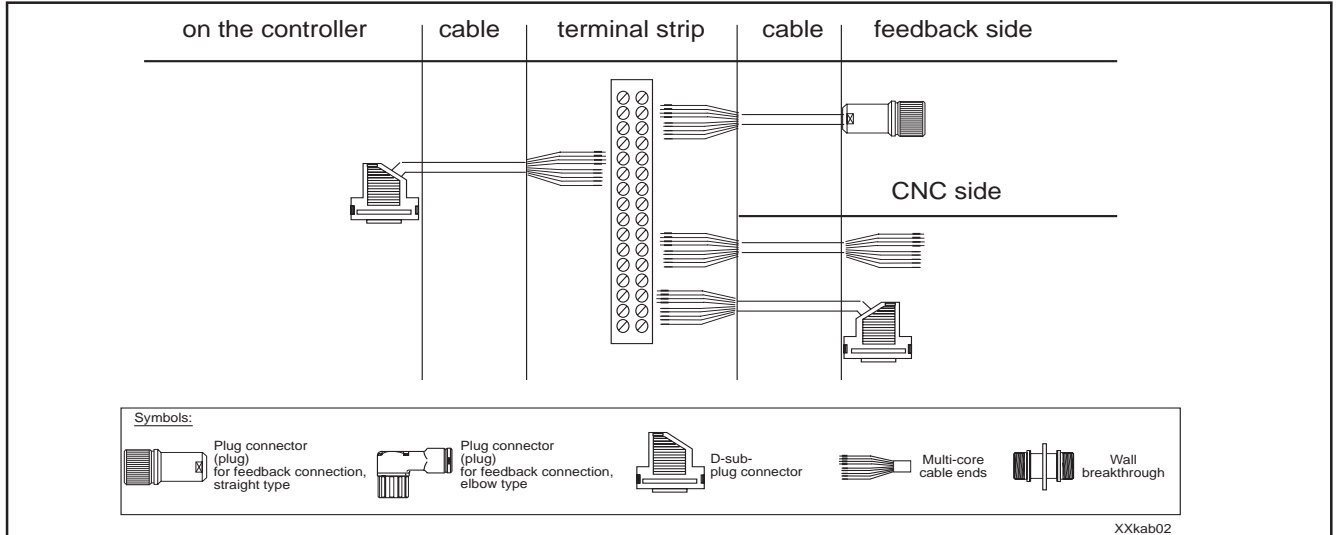

Figure 3.3: Assembled cables for intermediate terminals on the terminal strip (also see Figure 3.22).

Connection with plug design

The control cabinet can be finished entirely independent of the machine with this type of connection. The melding of machine and control cabinet is quick and simple.

In addition, damaged cables on the outside of the control cabinet can be quickly and safely exchanged.

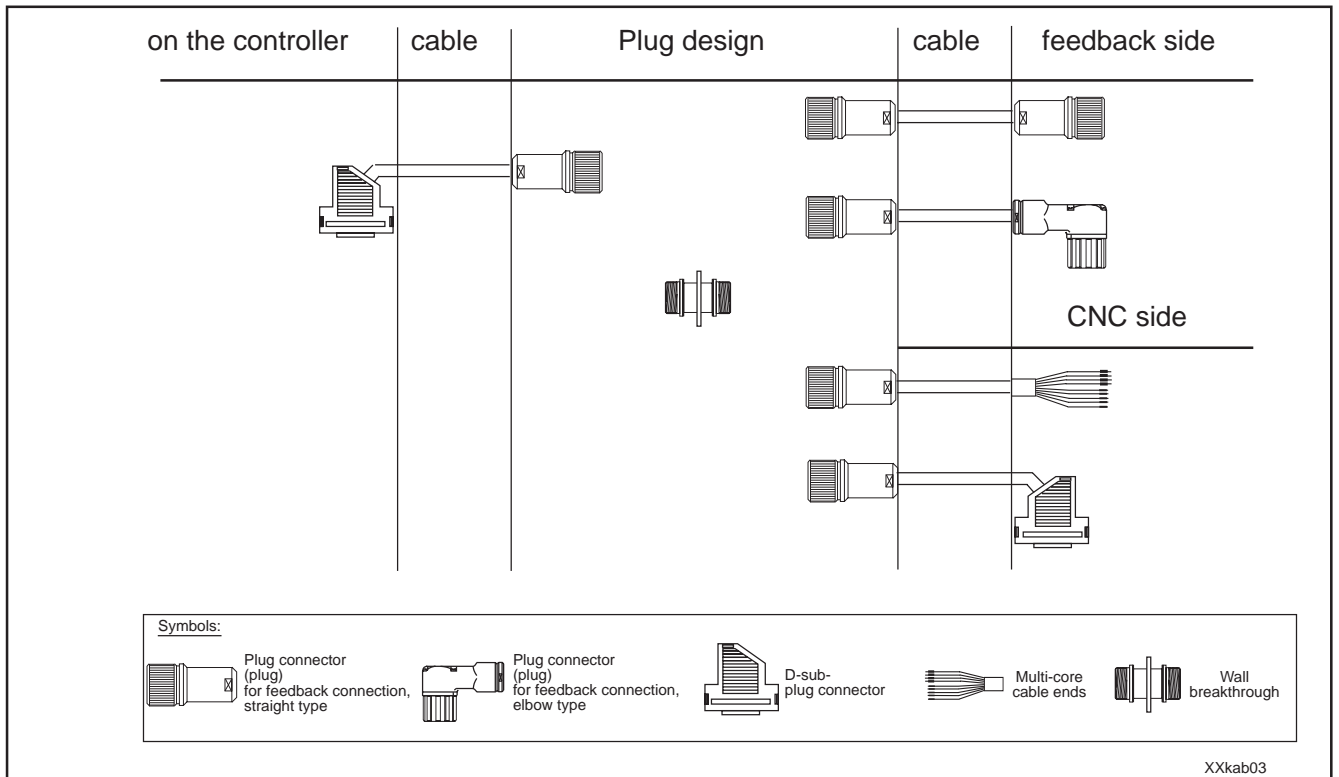

Figure 3.4: Assembled cables for plug design (also see Figure 3.23).

Connection with
plugin testing point

This type of connection is advantageous with larger facilities as it is possible to quickly and safely exchange a damaged section.

The mounting of assembled cables of this type of connection is particularly simple and quick.

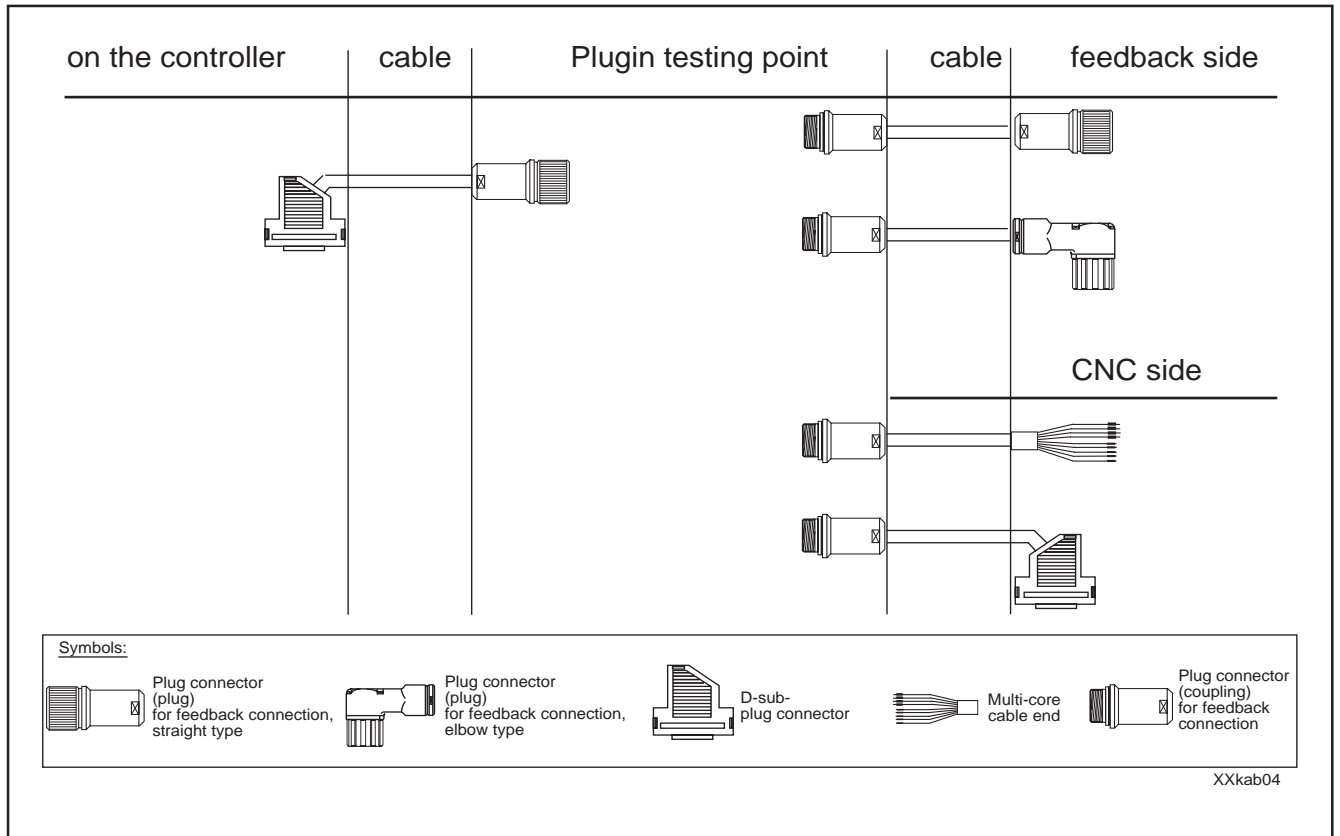

Figure 3.5: Assembled cable with plugin testing points (also see Figure 3.24)

3.2. Connecting plans for direct connections

Only the connection plans for the direct connection of feedback and CNC connections are depicted. They do, however, apply to all other types of connections. The respective testing points do not alter the allocation of the connections for feedback or CNC control and main spindle controller.

The connection plans are to be used to develop the plant connection diagrams. The plant connection diagrams of the machine manufacturer are to be used when wiring the plant!

Standard interfaces and optional interfaces

Main spindle controllers are always equipped with motor feedback connection (X3, standard) and control input, signal and analogue outputs (X2, standard). The controllers can optionally be equipped with additional feedback and CNC interfaces.

The optional interfaces are listed in the type designations of the controller to be mounted. The type key is listed in the documentation about main spindle controllers - „Project Planning Notes“.

3.2.1. Motor feedback, high-resolution

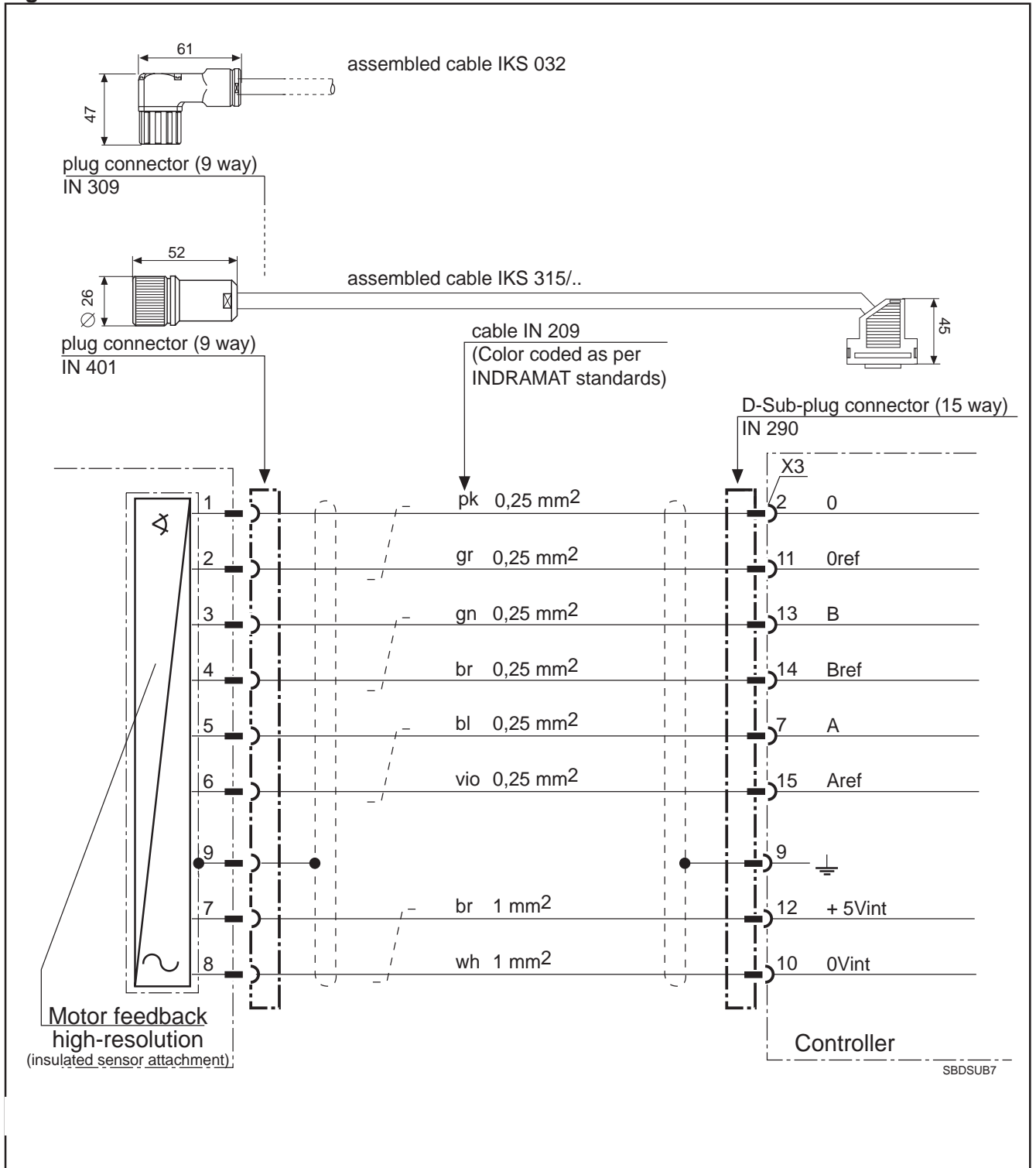

Figure 3.6: Connection plan for high-resolution motor feedback (standard)



The high-resolution motor feedback cable must not be fed over a terminal strip due to sensitivity to interference!

3. Feedback and CNC Connections

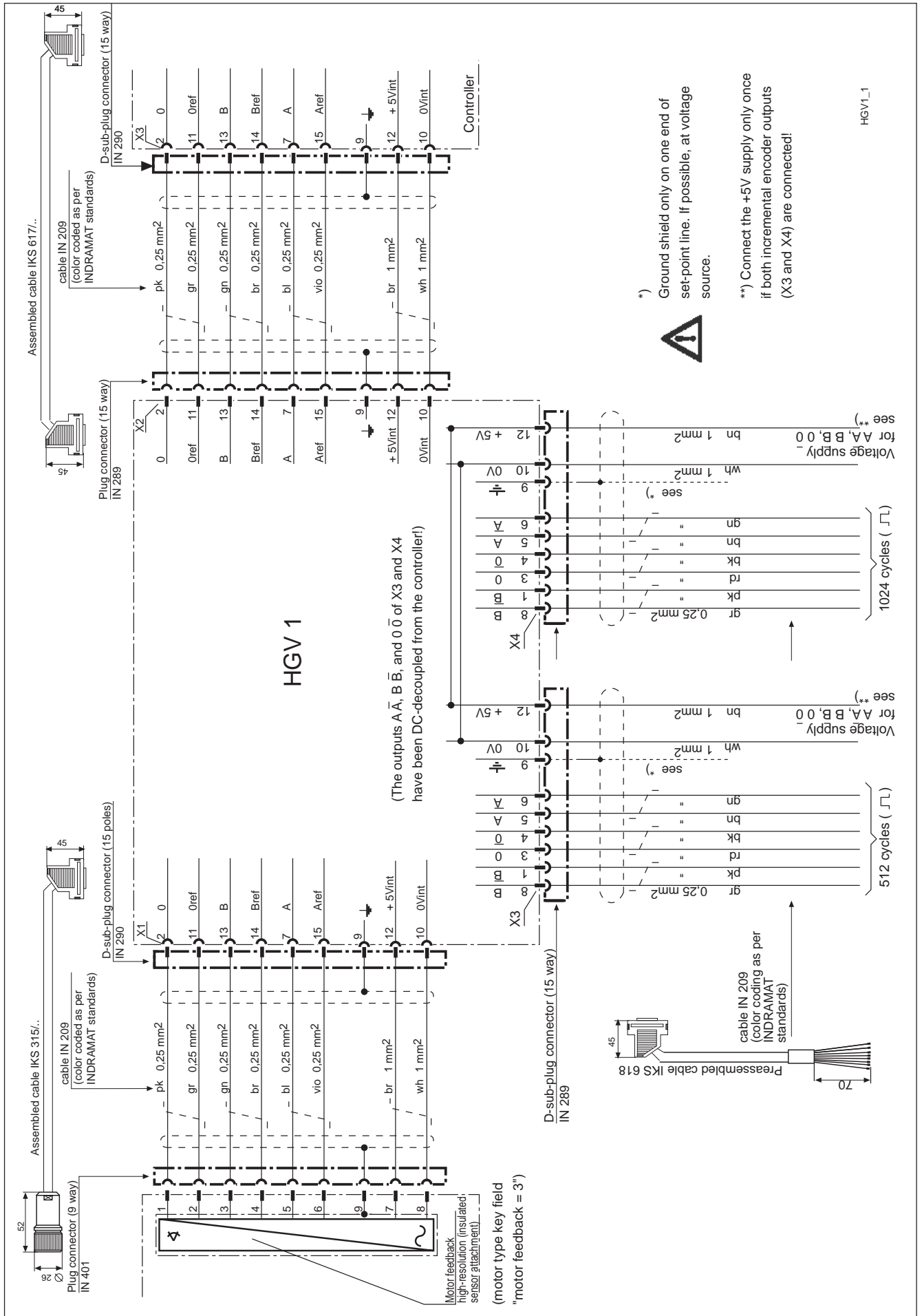

Figure 3.7: HG V1 connection plan switched into the high-resolution motor feedback cable.

3.2.2. Motor feedback, incremental encoder

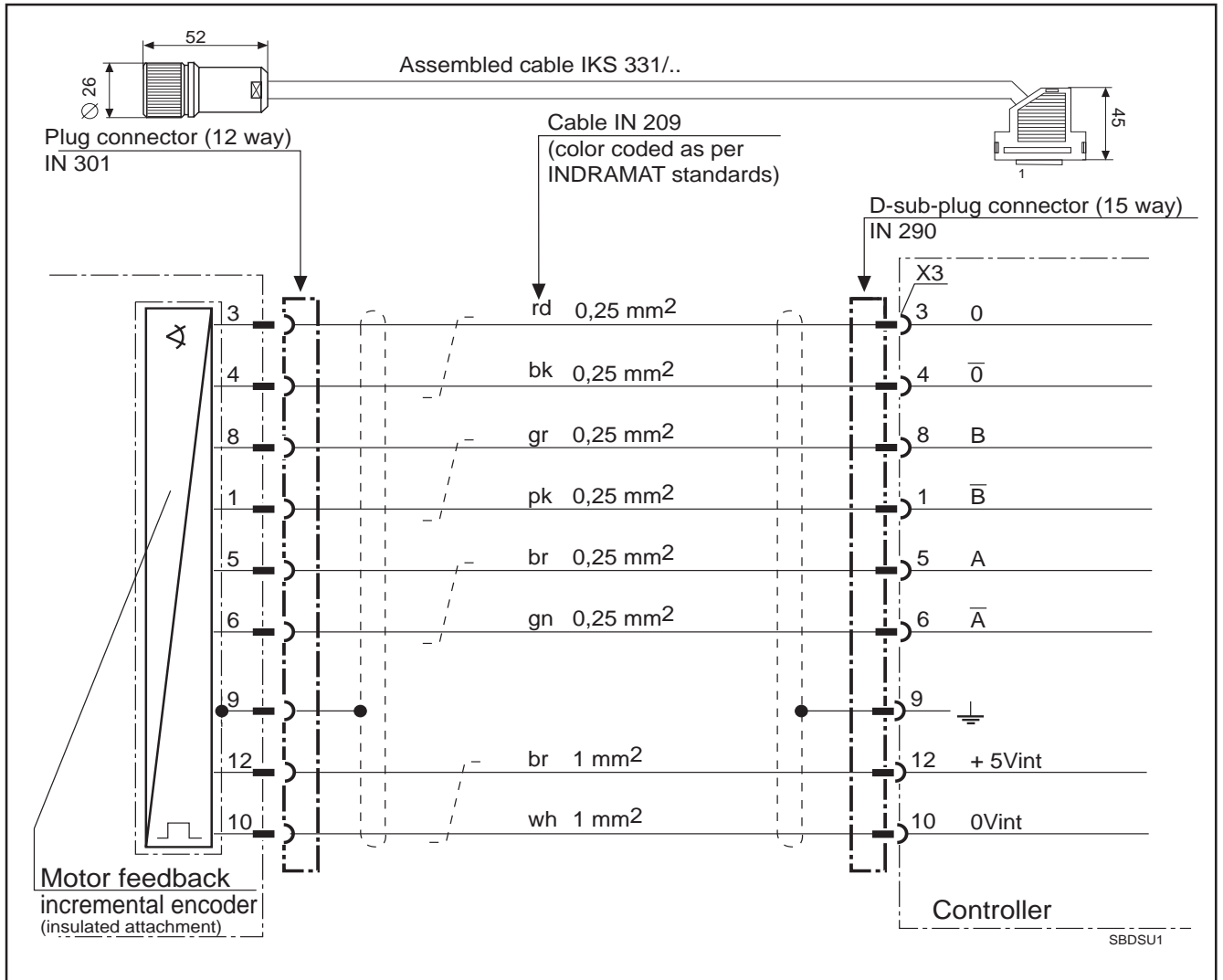

Figure 3.8: Connection plan for incremental encoder motor feedback (motor type key field „motor feedback = 1“).

3.2.3. Spindle Feedback, high-resolution

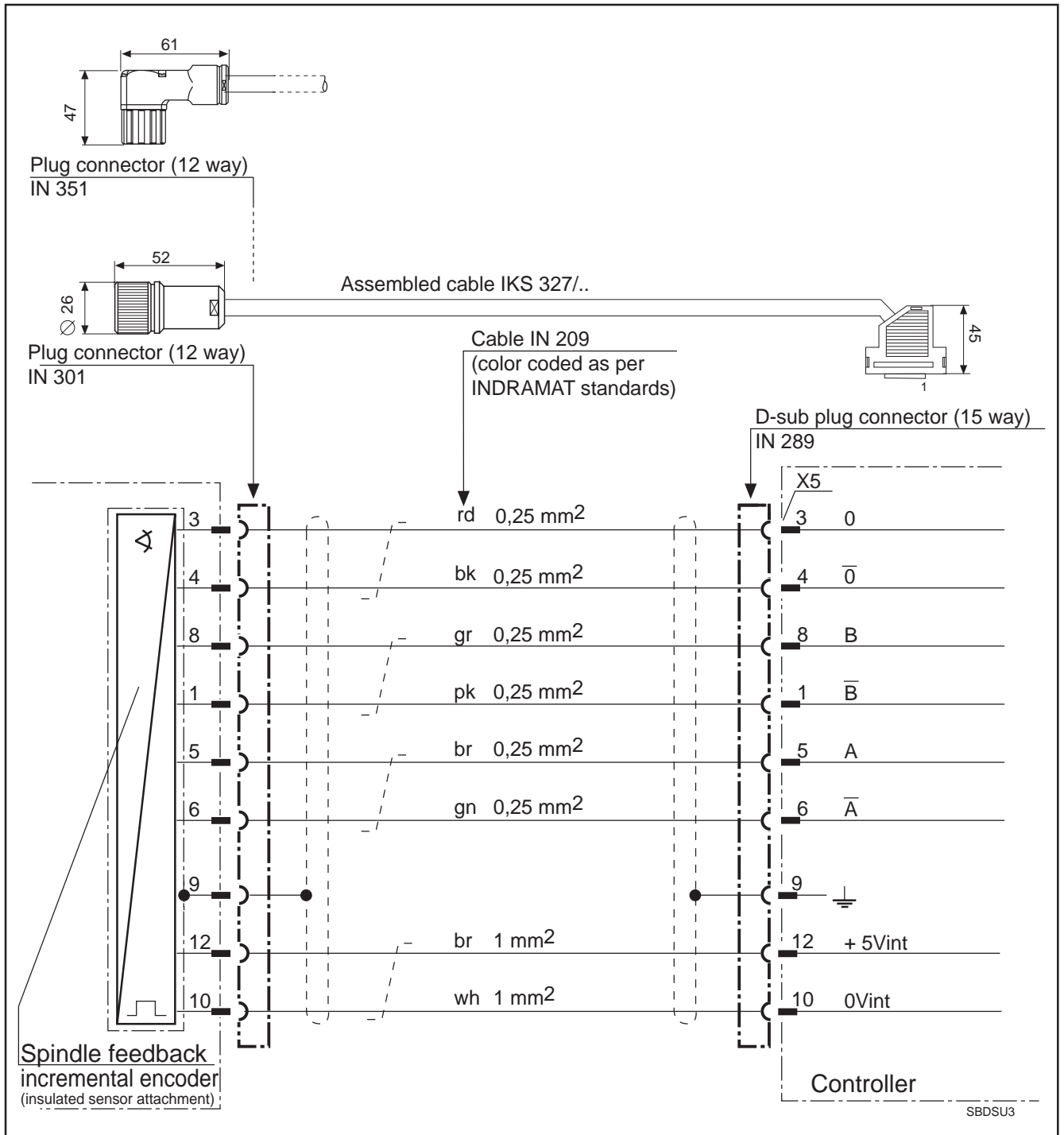

Figure 3.9: Connection plan for high-resolution main spindle position encoder as spindle feedback (controller with „additional encoder input = P“ option).



The cable to the high-resolution spindle feedback must not be fed over a terminal strip because of sensitivity to interference!

3.2.4. Spindle Feedback, incremental encoder

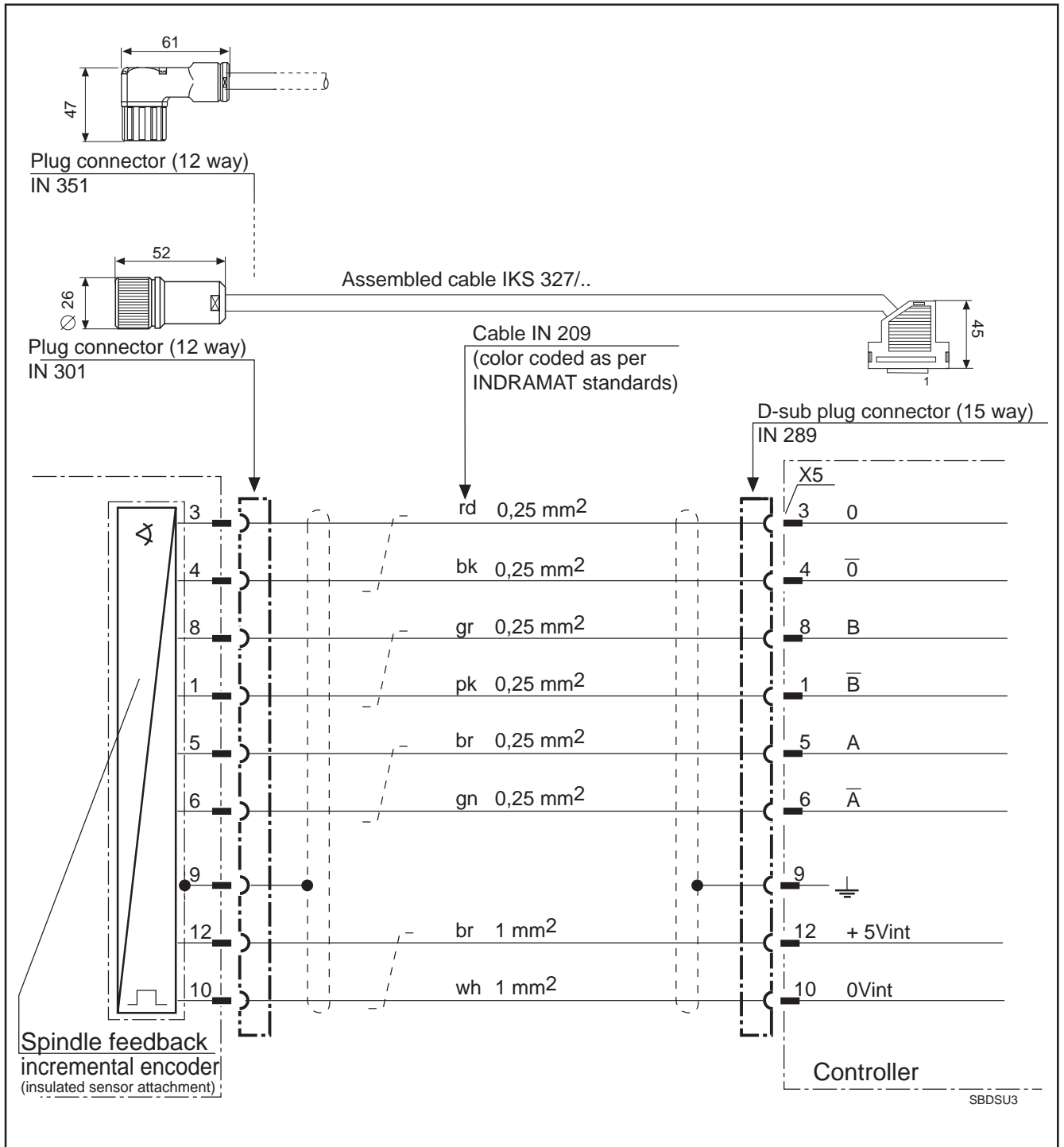

Figure 3.11: Connection plan for incremental encoder in the capacity of spindle feedback (controller with „additional encoder input = P“ option).

3.2.5. Lead Spindle Feedback

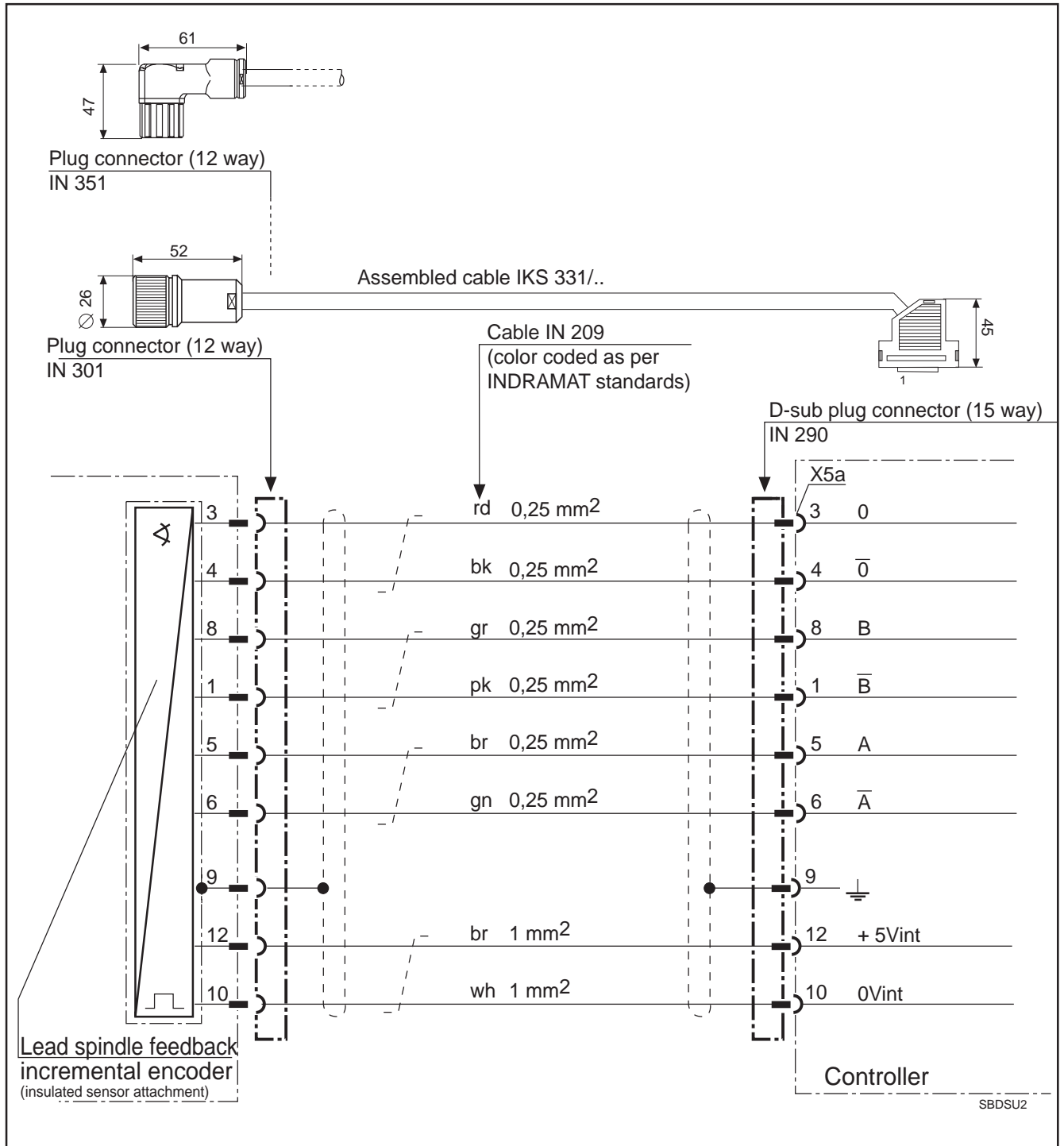

Figure 3.12: Connection plan for incremental encoder in the capacity of lead spindle feedback (controller with „additional encoder input = Y“ option).



Controllers with the „additional encoder input = Y“ are equipped with interfaces X5a and X5. This is necessary because spindle synchronization requires, in addition to position information about the lead spindle, a direct position measuring system (spindle feedback) at the spindle to be synchronized as well!

3.2.6. Control input, signal and analogue outputs, Bb-contact

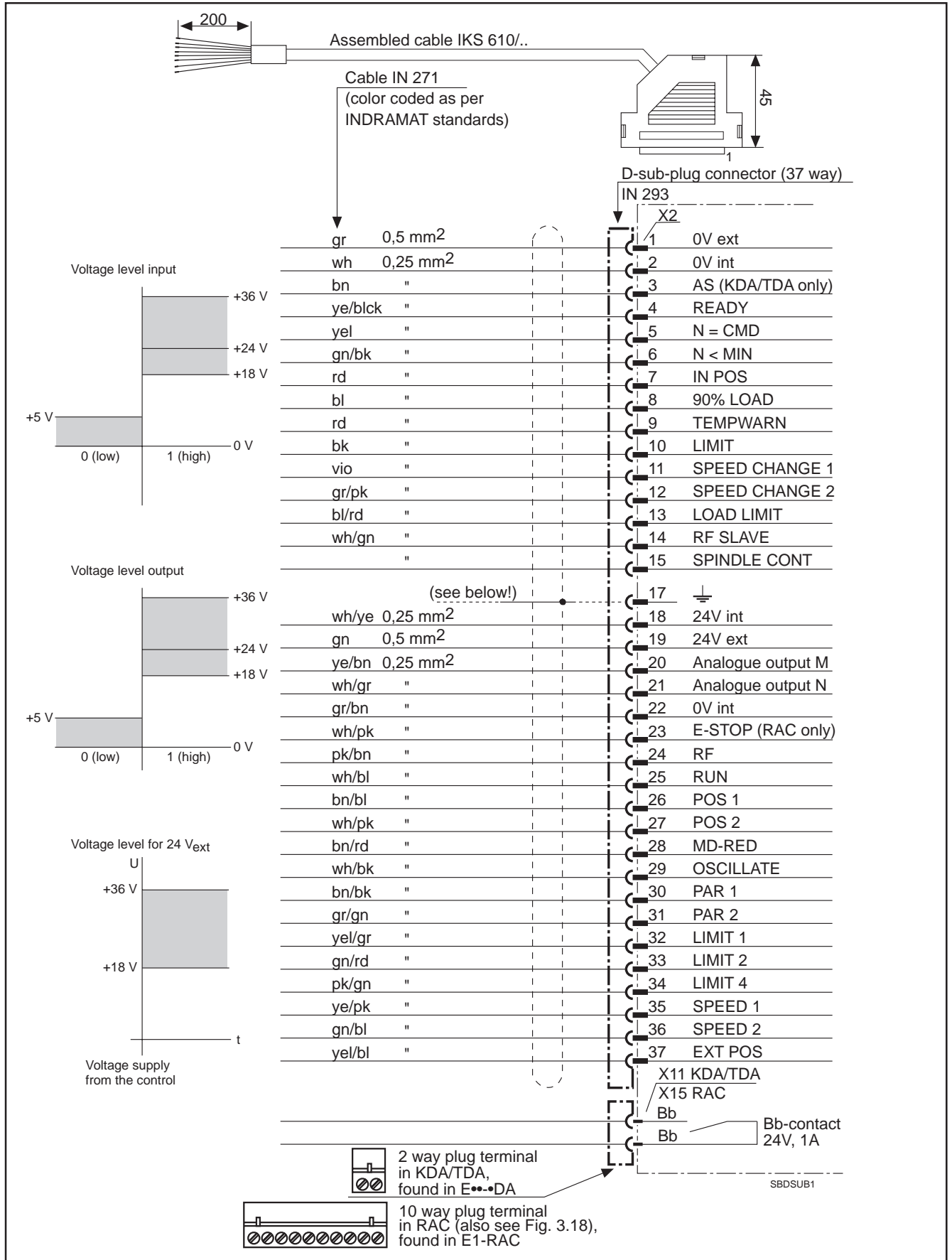

Figure 3.13: Connection plan for control input, signal and analogue outputs, Bb-contact (standard).

The control and signal outputs are DC-decoupled from the controller. The control must supply the outputs with *24V/0 V. Should this not be possible, then connect terminal 1 with 2 and 18 with 19!



Ground the shield only on one end of the cable. If possible, at voltage source.



Do not directly connect a contactor coil via the relay contact Bb, as the high intermittent currents caused by frequent switching could overload the relay contact and cause it to fail.

3.2.7. Speed set-point, analogue +/- 10V

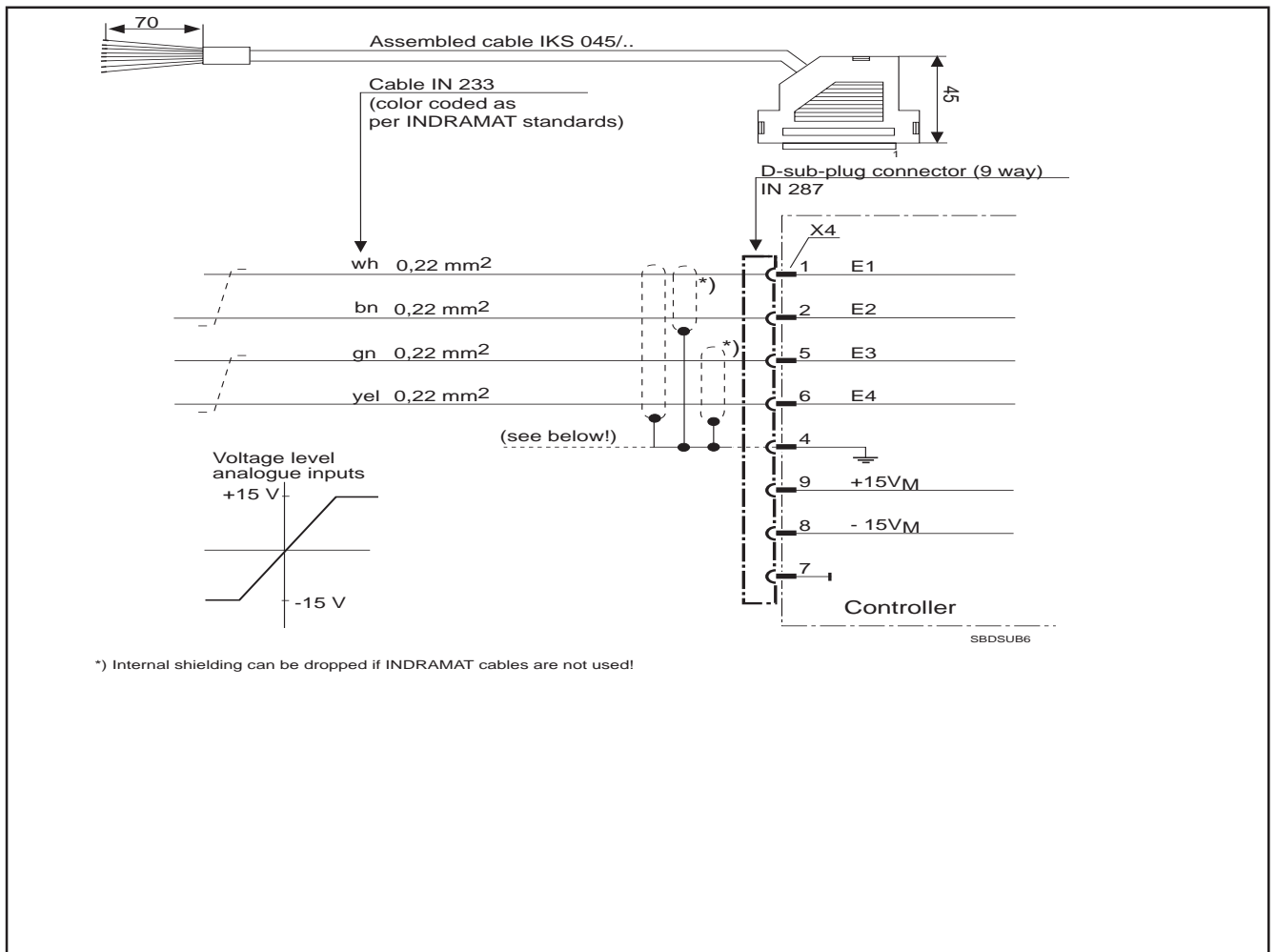

Figure 3.14: Connection plan for analogue speed set-point („speed set-point=A“ option)

Inputs E1/E2 and E3/E4 for the analogue set-point are designed as differential inputs.



Ground the shield only on one end of the set-point cable. If possible, at voltage source!

3.2.8. Speed set-point, digital, 16 bit parallel

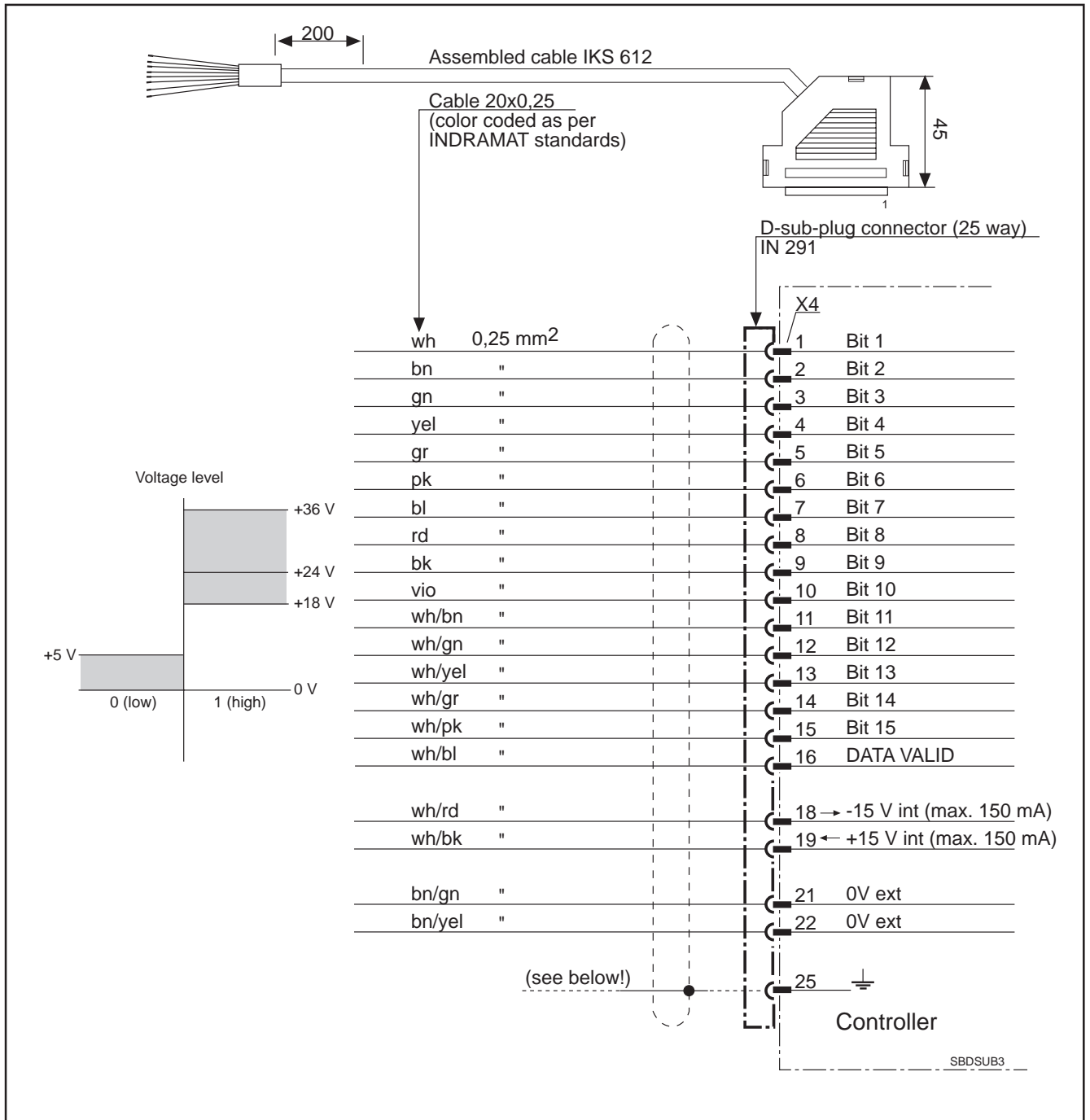

Figure 3.15: Connection plan for digital speed set-points („speed set-point=D“ option)

The inputs for the digital speed set-point (bit 1 ... bit 15, DATA VALID) are DC-decoupled from the controller. Terminal 21 should be connected to the 0V potential of the control! The inputs are then set with the +24V potential of the control! If the control does not supply *24V/0, then connect terminal 18 with 21 and set the inputs via terminal 19! Current consumption approx. 15mA per input!



Ground shield only at one end of the cable. If possible, at voltage source!

3.2.9. SERCOS Interface

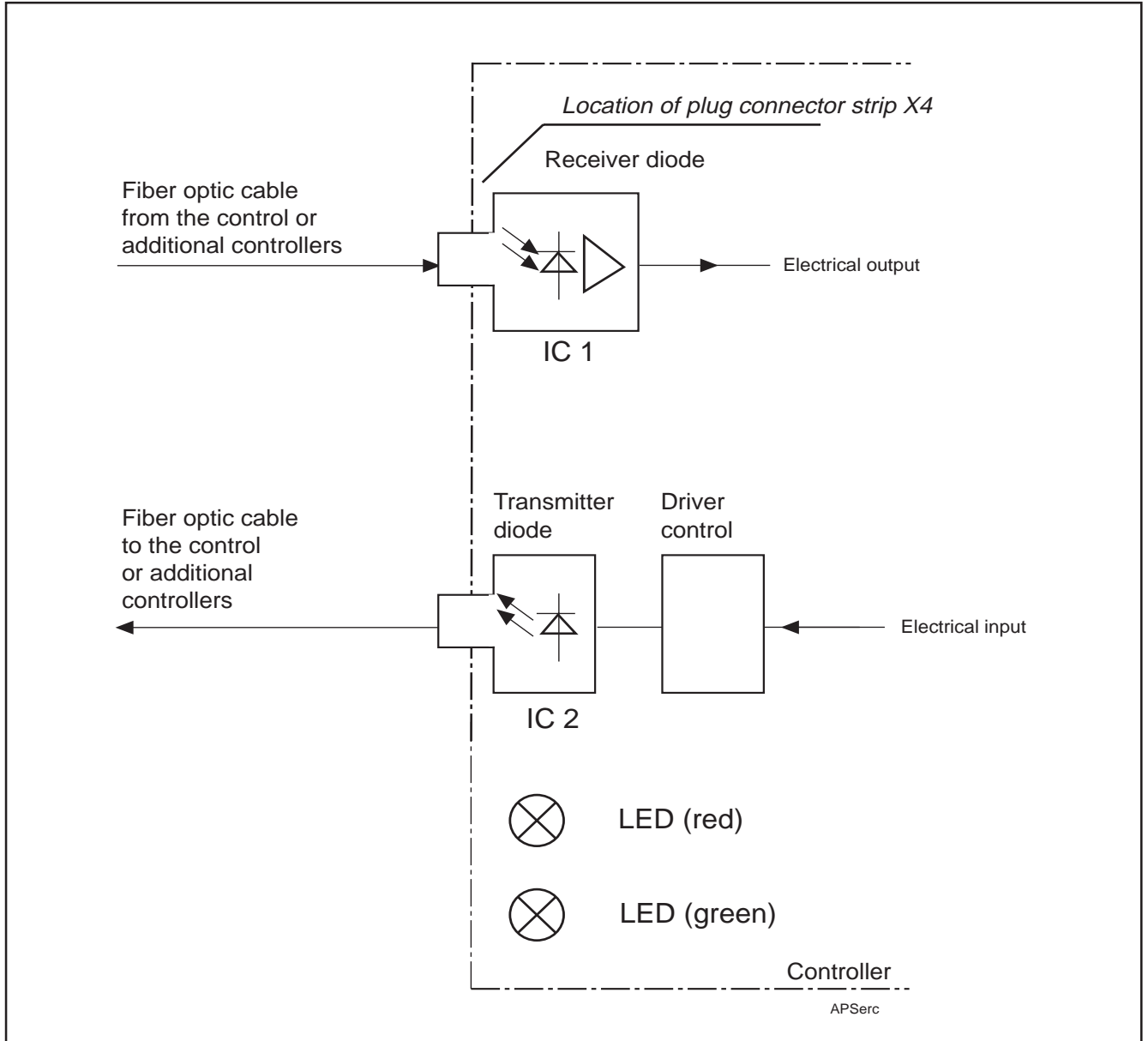

Figure 3.16: SERCOS interface connection plan („speed set-point=L“ option)

Additional fiber optic cable specifications

For specifications on assembled fiber optic cables, attenuation calculations, for specifications on constructing custom cables see doc. no. 209.0090-4101, „LWL Handling; description of application“.

3.2.10. Position set-point, digital, 16 bit parallel

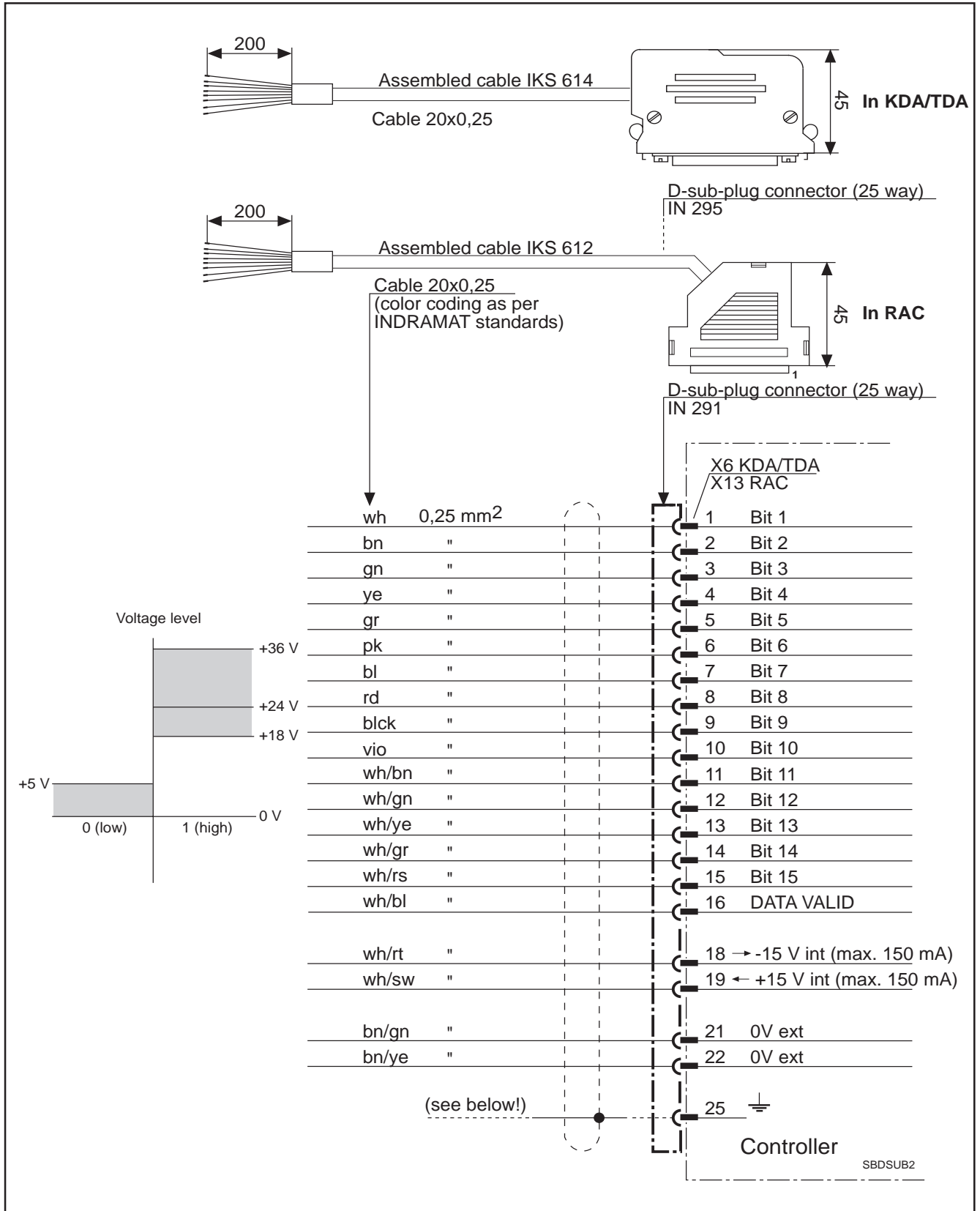

Figure 3.17: Connection plan for digital position set-point („additional interface=D“ option)



Ground shield only at one end of cable. If possible, at voltage source!

The digital position set-point inputs (bit 1 ... bit 15, DATA VALID) are DC-decoupled from the controller. Terminal 21 should be connected to the OV potential of the control! The inputs are set with the +24V potential of the control! If the control does not supply +24V/0 V, then connect terminal 18 with 21 and the inputs via terminal 19! Current consumption is approx. 15 mA per input!



Ground shield only at end of cable. If possible, at voltage source!

**3.2.11. Serial interface
RS 232C**

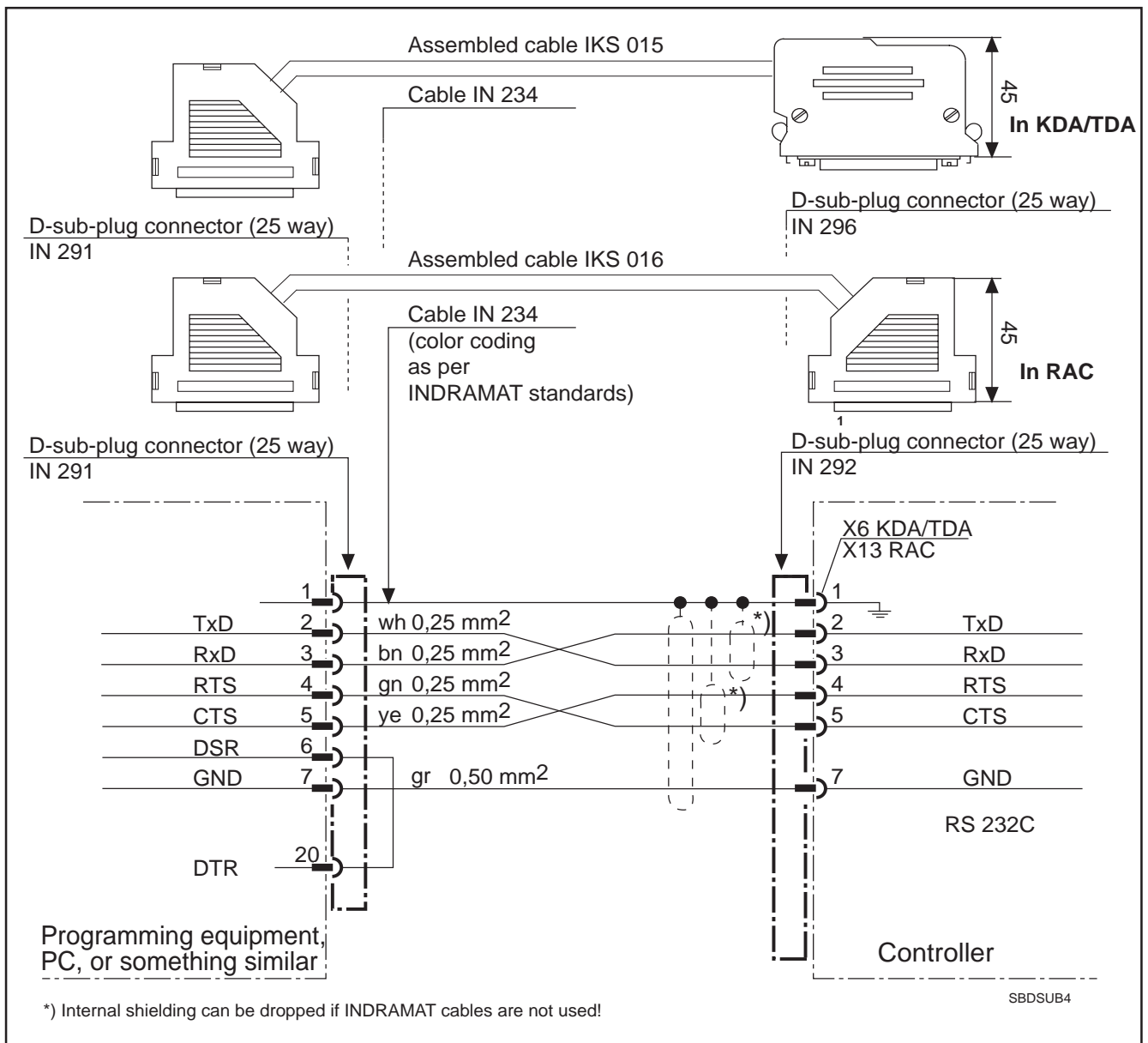

Figure 3.18: Connection plans for serial interfaces („additional interface=S“ option)

3.2.12. Incremental encoder output

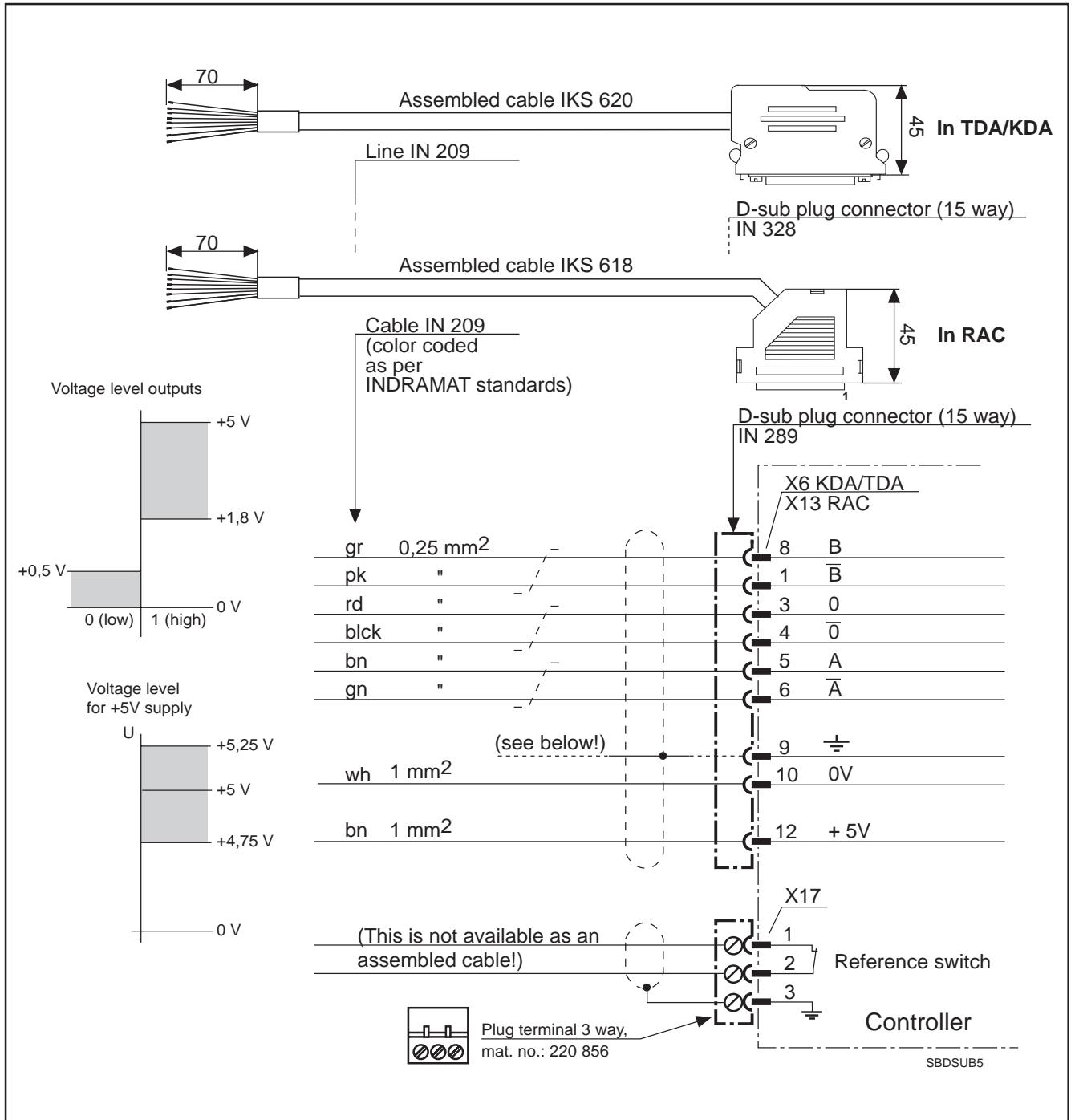

Figure 3.19: Connection plan for incremental encoder output and reference switch signal („additional interface=I” option)

Outputs $\bar{A}\bar{A}$, $\bar{B}\bar{B}$ and $\bar{O}\bar{O}$ are DC-decoupled from the controller. The CNC control must supply them with +5V/0.



Ground shield only at end of cable. If possible, at voltage source!

3.2.13. Control of the mains contactor integrated into the RAC controller

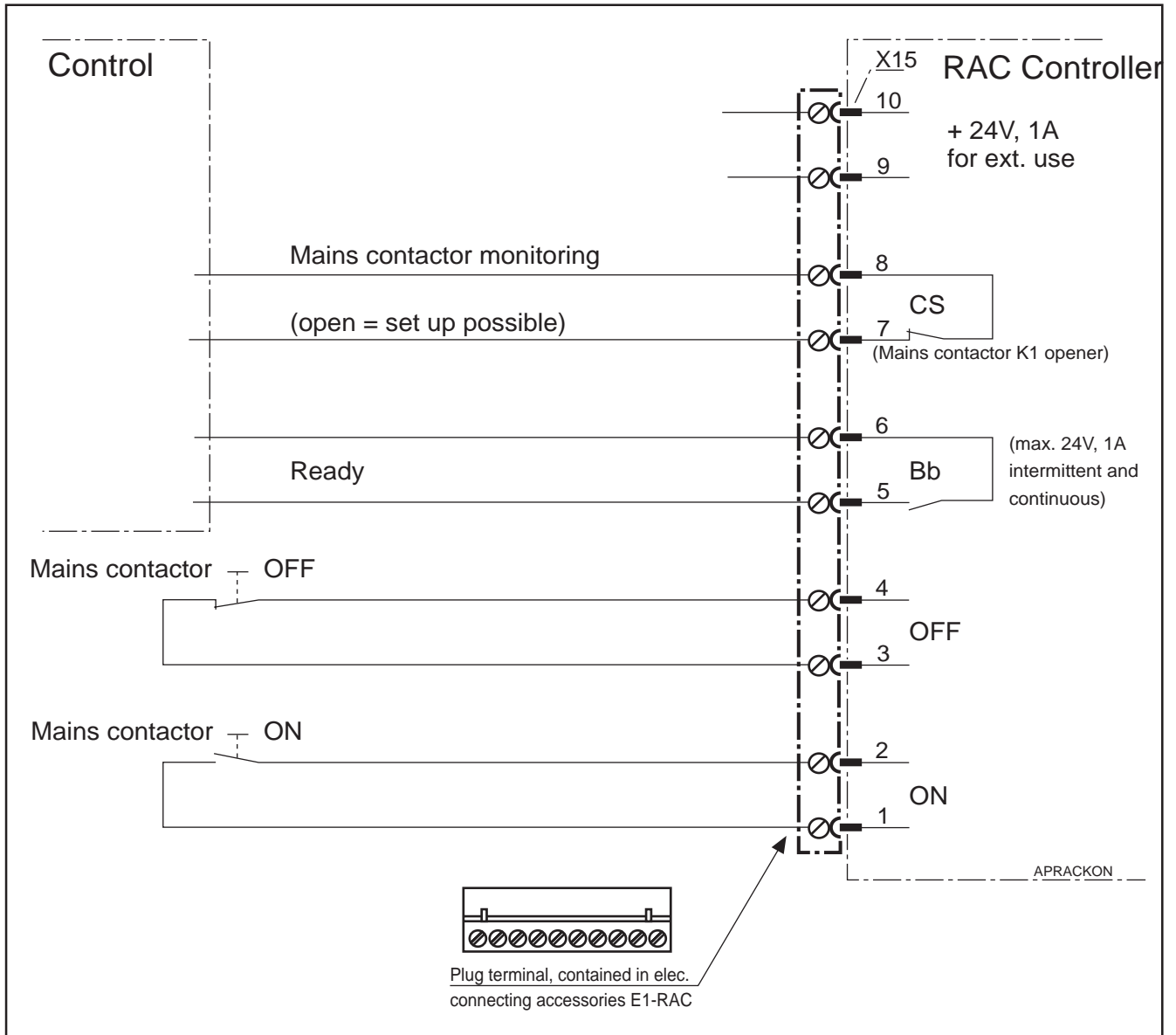

Figure 3.20: Connection plan for control of the mains contactor integrated into the RAC controller.



The controller-internal mains contactor should not be used to regularly shutdown the drives! It should only be activated with standing drive and controller enabler shut off!



Do not directly connect a contactor coil via the relay contact Bb, as the high intermittent currents caused by frequent switching could overload the relay contact and cause it to fail.

3.3. Assembled Cable Specifications

Specifications of the assembled cables for the four types of connections is dependent upon the functional options of the main spindle controller and are summarized in tables.

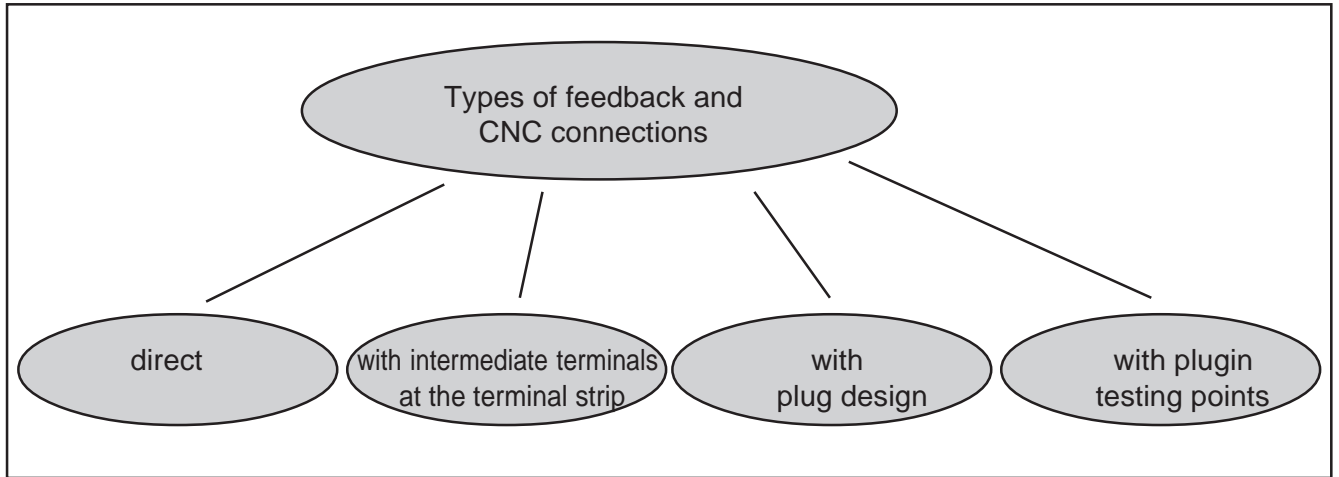

Figure 3.21: Four types of assembled feedback and CNC connections

The tables indicate both the assembled cable and its construction.

Table Summarizing Assembled Specifications

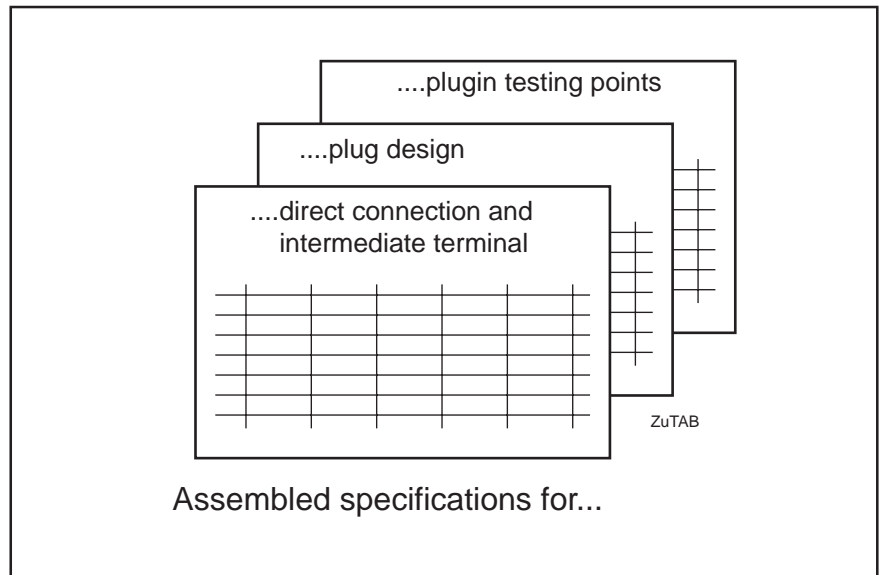

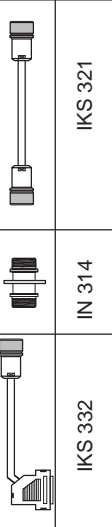
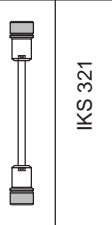

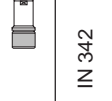

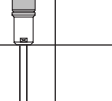
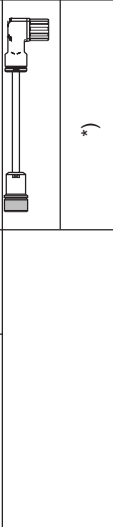
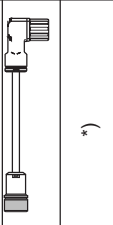
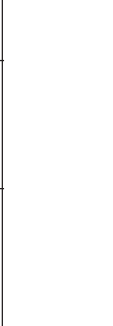

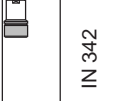
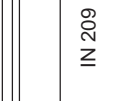
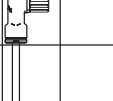
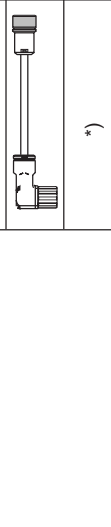
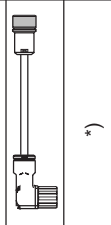

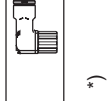

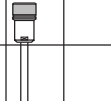
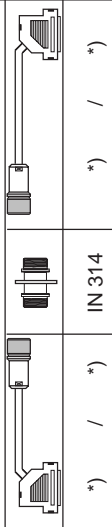
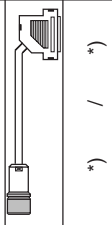
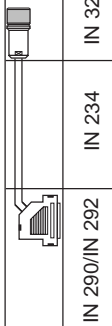

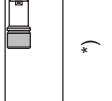

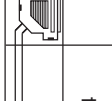
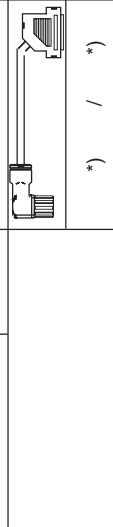
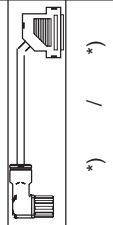
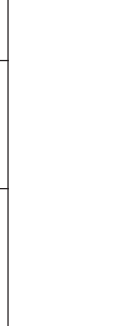
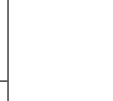
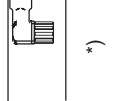

Figure 3.22: Summary of assembled specifications for feedback and CNC connections

The tables summarize the available assembled feedback and CNC cables and their significant components.

Feedback and CNC connections - direct connection and link terminal

Interfaces on the main spindle controller		Assembled cable for direct connection	Cable design for direct connection		Assembled cable for intermediate terminals on terminal strip		
			On the controller	Cable	Feedback or CNC	On the controller	Feedback or CNC
Standard Interfaces							
	Motor feedback connection	IKS 315	IN 290	IN 209	IN 401	not permitted!	not permitted!
		IKS 032	IN 290	IN 209	IN 309	not permitted!	not permitted!
	Control input, signal and analogue outputs	IKS 610	IN 293	IN 271	For.. ..line-up terminals		not available
Interfaces for functional options							
Type key field "speed set-point"	A analog	IKS 045	IN 287	IN 209	For.. ..line-up terminals		not available
	D digital	IKS 612	IN 291	20 x 0,25	..line-up terminals		not available
	L Sercos	IKO 982	IN 418	IN 414	IN 420		

Figure 3.23: Assembled specifications for direct connection and intermediate terminals at terminal strip allocated to the interfaces on the main spindle controller.

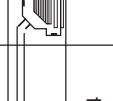
Feedback and CNC Connections - plug type										
Main spindle controller interfaces		Assembled cables for plug design			Cable structure for plug design					
		on the controller	feedback side	on the controller	plug type	cable	on the controller	cable	Feedback side	
Standard interfaces										
Motor feedback connection		X3	 IKS 332	 IKS 321	 IN 314	 IN 314	 IN 209	 IN 209	 IN 401	
			 *)	 *)	 IN 342	 IN 342	 IN 209	 IN 209	 IN 309	
			 *)	 *)	 *)	 *)	 IN 209	 IN 209	 IN 401	
Control input, signal and analogue outputs		X2	- not available -			- not available -				
Functional options interfaces										
Type key field "speed set-point"	A, D, L	X4	- not available -			- not available -				
Type key field "additional interfaces"	D, I	X6/X13 (*TA/RAC)	- not available -			- not available -				
	S		 *) / *)	 *) / *)	 IN 290/IN 292	 IN 314	 IN 234	 IN 234	 IN 291	
			 *) / *)	 *) / *)	 *)	 *)	 IN 234	 IN 234	 IN 291	

AL-KABFE

Figure 3.24: Table summarizing assembled specifications for connections using a plugin testing points allocated to the interfaces on the main spindle controller.

3. Feedback and CNC Connections

P		X5		X5a		AL-KABF6	
Type code field "additional encoder input"	Connected to..	IKS 330 incremental encoder	IKS 305	IN 289	IN 209	IN 303	IN 301
	IKS 330 high-resolution encoder	IKS 321	IN 289	IN 209	IN 304	IN 401	
	IKS 330 second motor feedback	IKS 321	IN 289	IN 209	IN 304	IN 401	
	Connected to..						
	IKS 330 incremental encoder	IKS 308	IN 289	IN 209	IN 303	IN 351	
	IKS 330 high-resolution encoder	*)	IN 289	IN 209	IN 304	IN 309	
	IKS 330 second motor feedback	*)	IN 289	IN 209	IN 304	IN 309	
	Connected to..						
	IKS 330 incremental encoder	*)	IN 289	IN 209	IN 303	IN 301	
	IKS 330 high-resolution encoder	*)	IN 289	IN 209	IN 304	IN 401	
	IKS 330 second motor feedback	*)	IN 289	IN 209	IN 304	IN 401	
	Connected to..						
	IKS 330 incremental encoder	*)	IN 289	IN 209	IN 303	IN 351	
	IKS 330 high-resolution encoder	*)	IN 289	IN 209	IN 304	IN 309	
	IKS 330 second motor feedback	*)	IN 289	IN 209	IN 304	IN 309	
Connected to..							
IKS 330 incremental encoder	IKS 305	IN 290	IN 209	IN 303	IN 301		
IKS 330 high-resolution encoder	IKS 308						
IKS 330 second motor feedback	*)						
*)	*)						

Legend:

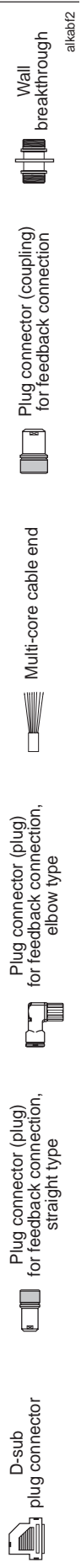

Figure 3.24: Table summarizing assembled specifications for connections using a plugin testing points allocated to the interfaces on the main spindle controller.

Feedback and CNC Connections - plugin testing points									
Main spindle controller interfaces	Assembled cable for plugin testing points		Cable construction with plugin testing points						
	On the controller	Feedback or CNC	On the controller	cable	Plugin testing points	cable	Feedback side	Feedback side	Feedback side
Standard interfaces									
Motor feedback connection	X3	IKS 315	IKS 322	IN 290	IN 209	IN 401	IN 309	IN 209	IN 401
	X2	IKS 315	IKS 360	IN 290	IN 209	IN 401	IN 306	IN 209	IN 309
Control input, signal and analogue outputs		- not available -	- not available -						

ALKABF3

Figure 3.25: Table of assembled specifications for plug connections allocated to the interfaces on the main spindle controller.

3.4. Cable Specifications List The cable specifications used in the assembled cables are summarized below in table form. All necessary specifications and measurements are listed.

Cable typ	Cable Construction	Diameter in mm	Bending radius in mm		Weight in kg/m
			Fixed routing	Flexible routing	
IN 209	(2x1,0+4x2x0,25)C	8,8 ±0,3	40	90	0,102
IN 233	(2x2x0,25)C	8,3 ±0,3	80	125	0,102
IN 234	2x(2x0,22)C+2x0,5	7,0 ±0,3	45	70	0,070
IN 271	34x0,25+2x0,5	11,0 ±1,0	60	125	0,195
20 x 0,25	(20x0,25)C	9,1 ±0,4	137	182	0,153

Figure 3.26: Table of cable specifications for feedback and CNC connections.

4. Installation Guidelines

Cable routing guidelines

There must be a clearance of at least 100 mm between the power connections and the feedback or CNC connections if the cables are routed parallel. Otherwise, it is necessary to separate the cable conduit with metal (see Fig. 4.1)

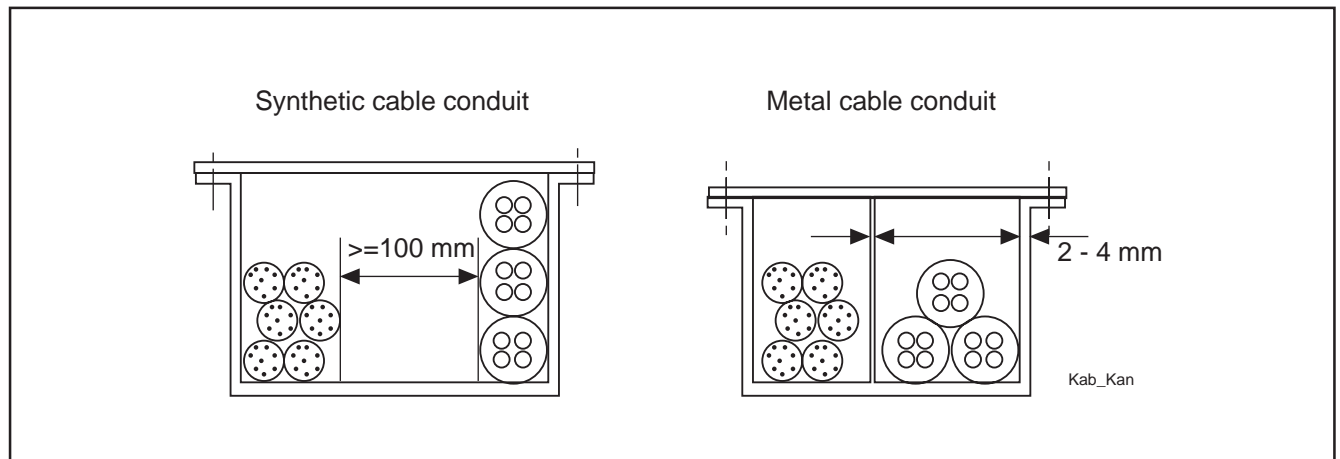

Figure 4.1: Routing the cables together in the cable conduit.

Wiring

The guidelines outlined in the connection plans on power, feedback and CNC connections with reference to the twisting of conductors and the shielding of bunched conductors must be followed in order to achieve interference-free operation!

The shielding should be connected as outlined in the connection plans. This avoids mass potential loops!

Feedback units

Feedback units which the main spindle controller evaluates must be mounted and electrically insulated at the machine or motor.

Do not route the feedback cables in the vicinity of high-frequency equipment, the magnetic fields of transformers, chokes, motors and other magnetic consumers, as well as high-voltage cables, as otherwise interference could be coupled in!

Power plug connectors

The dimensioning of the contact distances and leakage paths of the power plug connectors is based on the degree of contamination as outlined in DIN VDE 0160.

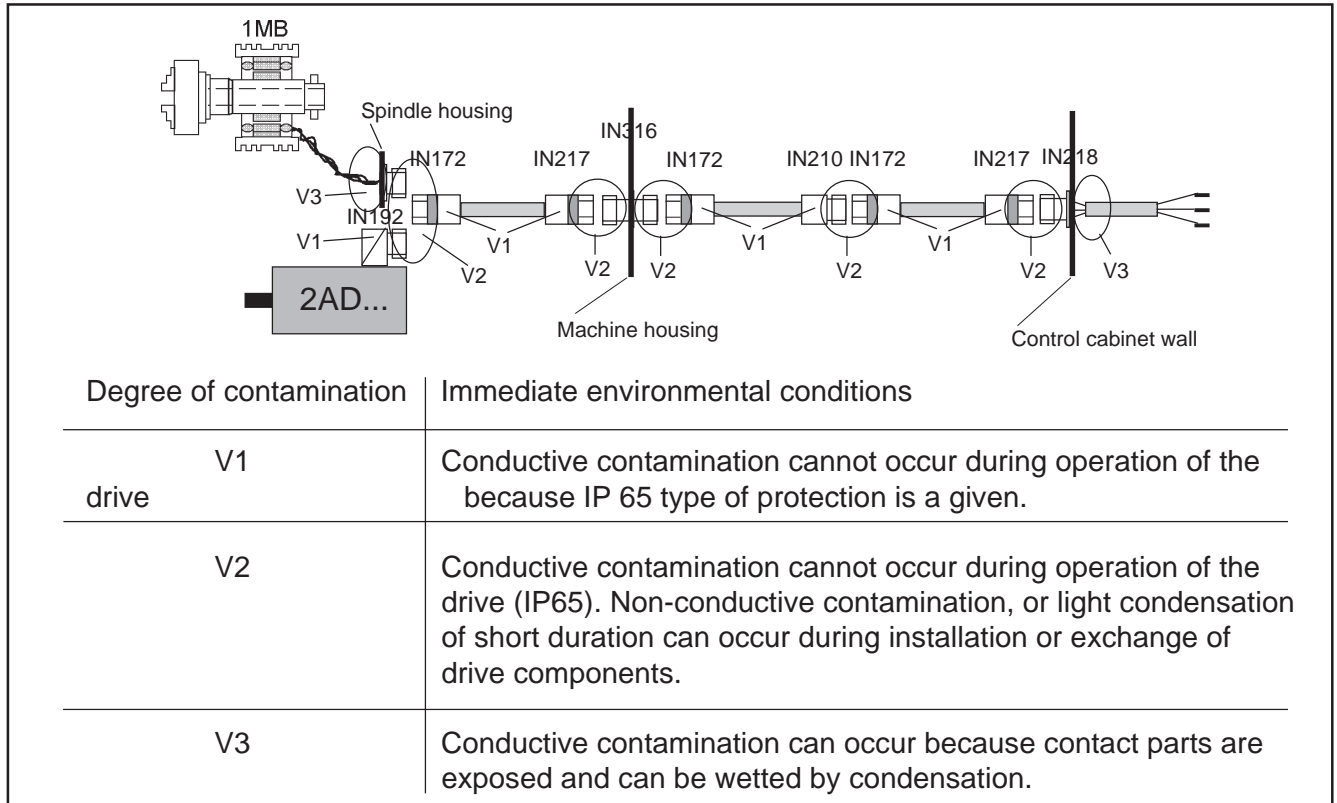

Figure 4.2: Degree of contamination in acc. with DIN VDE 0160.



If wetting from coolants or lubricants is to be expected when installing a drive or exchanging drive components, then seal the open plug side of power connections with protective caps.

Only join power plug connectors if plug side is dry!



Detach and join power plug connectors only when no power is present!



If a power plug connector is used to connect 1MB frameless motors, then do not spill coolant onto the backside of the flanged socket on either the spindle or machine housing!

Installing Cables	The plug connectors of the power cable and the feedback connections must be firmly screwed into place when the drive is operating!
Category of Protection for the Cable	Category IP65 protects assembled INDRAMAT cables when they are firmly screwed in and attached. This does not, however, apply to the open side of control cabinet and housing breakthroughs as well as d-sub plug connectors!
General Controller Installation Guidelines	<ul style="list-style-type: none">– Do not detach the AS programming module when unit is still under power. The knurling screw must be firmly affixed during operation!– The d-sub plug connectors must be firmly screwed into place!– Twist the motor power cable strands!
Modular Drive System Installation Guidelines	<ul style="list-style-type: none">– The transparent panes on the safety guards on the front side of the unit must be firmly affixed during operation!– Ground the motor on the controller and ground the controller directly on the supply module!– Plug the control voltage bus end plug (supply module accessories) into the last controller on the drive configuration!– Adhere to maximum tightening torque of the stay bolts, otherwise there is the risk of tearing!– Plug in heatsink fan cable, if present.
RAC Installation Guidelines	<ul style="list-style-type: none">– The power connection safety guards on the front of the RAC4 must be closed when the unit is switched on and during operation!– Ground the motor on the controller and ground the controller housing to the main incoming earth terminal!
Measures Against Sources of Interference from Inside the Control Cabinet	<p>If contacts or semi-conductors are used in connection with electronic equipment and components to switch such inductive loads as chokes, contactors and relays, then these must be appropriately cleared of interference. If direct current is used, then this is achieved by the arrangement of freewheeling diodes, and if alternating current is used, then this is achieved with the arrangement of commercial safety RC suppressor components situated directly at the inductivity. Do not use varistors as protective circuits!</p> <p>Only that suppression component situated directly at the inductivity serves the purpose. Otherwise an interference level is radiated which is too high. This influences both the function of the drive and the electronics. Other interference sources, such as high-frequency equipment (anodized components, and similar) must be placed and wired outside of the control cabinet.</p>

5. Delivery, Identification, Storage

Assembled Cables

Assembled cables are rolled up and loosely packed in with the delivery. They do have a label (cable marker), which bears the order designation and the length of the assembled cable.

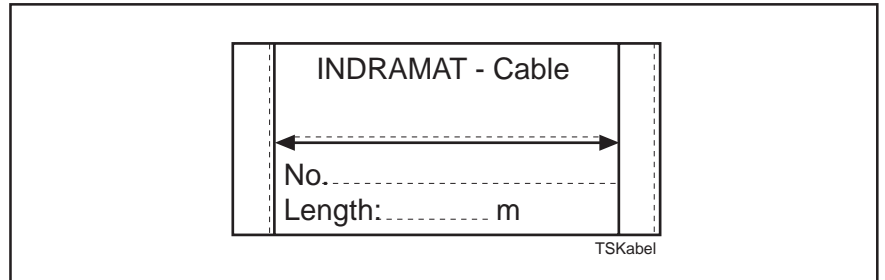

Figure 5.1: Label (cable marker) on INDRAMAT assembled cables.

Plug accessories

The plug accessory sets contain the plug connector (D-sub) for the optional interfaces of the controller. They are packed in plastic bags and bear a packaging slip (see Figure 5.3).

The plug accessory sets are delivered in a sealed carton together with single plug connectors and the controller-specific connections.

Note: The plug accessory sets are not necessarily needed (see Fig. 1.2)!

		Designation:	S • - • • •
Controller type	KDA/TDA 1 RAC 2		
Type key field for the controller:			
Speed set-point:			
analog +/- 10V	A		
digital (16 Bit parallel)	D		
SERCOS interface	L		
Additional encoder input:			
Without add. encoder input	O		
With add. encoder input for spindle feedb. or 2nd motor feedb.	P		
With add. encoder input and synchronous input (AS •5 and speed set-point = A)	Y		
Additional encoder input:			
Without add. encoder input	O		
Position set-point, digital (16 bit parallel)	D		
Serial interface (RS 232C)	S		
Incremental encoder output	I		

Figure 5.2: Designations of the plug accessory sets

Packaging slip

<p>Page 1</p> <div style="text-align: right; border: 1px solid black; padding: 2px; width: fit-content; margin: 0 auto;">INDRAMAT</div> <h2 style="text-align: center; margin: 10px 0;">S2 - API</h2> <h1 style="text-align: center; margin: 10px 0;">239 164</h1> <p style="text-align: center;">Additional plug accessories RAC ●●●●●●●●●● - API - ●●●</p> <table border="1" style="width: 100%; border-collapse: collapse; margin-top: 10px;"> <thead> <tr> <th style="width: 10%;">No.</th> <th style="width: 70%;">Designation</th> <th style="width: 20%;">Mat. No.</th> </tr> </thead> <tbody> <tr> <td style="text-align: center;">1</td> <td>D-SUB-plug 37 way, bushing X2</td> <td style="text-align: center;">221652</td> </tr> <tr> <td style="text-align: center;">1</td> <td>housing 37 way X2</td> <td style="text-align: center;">221659</td> </tr> </tbody> </table>	No.	Designation	Mat. No.	1	D-SUB-plug 37 way, bushing X2	221652	1	housing 37 way X2	221659	<p>Page 2</p> <table border="1" style="width: 100%; border-collapse: collapse; margin-top: 10px;"> <thead> <tr> <th style="width: 10%;">No.</th> <th style="width: 70%;">Designation</th> <th style="width: 20%;">Mat. No.</th> </tr> </thead> <tbody> <tr> <td style="text-align: center;">1</td> <td>D-SUB-plug 15 way, pins X3</td> <td style="text-align: center;">220623</td> </tr> <tr> <td style="text-align: center;">3</td> <td>Housing, 15 way X3, X5, X13</td> <td style="text-align: center;">221661</td> </tr> <tr> <td style="text-align: center;">2</td> <td>D-SUB-plug 15 way, bushing X5, X13</td> <td style="text-align: center;">223008</td> </tr> </tbody> </table>	No.	Designation	Mat. No.	1	D-SUB-plug 15 way, pins X3	220623	3	Housing, 15 way X3, X5, X13	221661	2	D-SUB-plug 15 way, bushing X5, X13	223008		
No.	Designation	Mat. No.																						
1	D-SUB-plug 37 way, bushing X2	221652																						
1	housing 37 way X2	221659																						
No.	Designation	Mat. No.																						
1	D-SUB-plug 15 way, pins X3	220623																						
3	Housing, 15 way X3, X5, X13	221661																						
2	D-SUB-plug 15 way, bushing X5, X13	223008																						
<p>Page 3</p> <table border="1" style="width: 100%; border-collapse: collapse; margin-top: 10px;"> <thead> <tr> <th style="width: 10%;">No.</th> <th style="width: 70%;">Designation</th> <th style="width: 20%;">Mat. No.</th> </tr> </thead> <tbody> <tr> <td style="text-align: center;">1</td> <td>D-SUB-plug 9 way, bushing X4</td> <td style="text-align: center;">222740</td> </tr> <tr> <td style="text-align: center;">1</td> <td>Housing, 9 way X4</td> <td style="text-align: center;">222154</td> </tr> <tr> <td style="text-align: center;">1</td> <td>Plug terminal 3 way X17</td> <td style="text-align: center;">220856</td> </tr> <tr> <td style="text-align: center;">10</td> <td>screw </td> <td style="text-align: center;">221657</td> </tr> </tbody> </table>	No.	Designation	Mat. No.	1	D-SUB-plug 9 way, bushing X4	222740	1	Housing, 9 way X4	222154	1	Plug terminal 3 way X17	220856	10	screw 	221657	<p>Page 4</p> <table border="1" style="width: 100%; border-collapse: collapse; margin-top: 10px;"> <thead> <tr> <th style="width: 10%;">No.</th> <th style="width: 70%;">Designation</th> <th style="width: 20%;">Mat. No.</th> </tr> </thead> <tbody> <tr> <td style="height: 150px;"></td> <td></td> <td></td> </tr> </tbody> </table> <div style="margin-top: 10px;"> <table style="width: 100%; border-collapse: collapse;"> <tr> <td style="width: 50%; border-right: 1px solid black; padding: 2px;"> Date: 24.05.93 File: S2-API Mat. No. BPZ: 253227 </td> <td style="width: 50%; padding: 2px;"> Acc. pack. slip S2-API Z.No.:109-0743-4248-00 </td> </tr> </table> </div>	No.	Designation	Mat. No.				Date: 24.05.93 File: S2-API Mat. No. BPZ: 253227	Acc. pack. slip S2-API Z.No.:109-0743-4248-00
No.	Designation	Mat. No.																						
1	D-SUB-plug 9 way, bushing X4	222740																						
1	Housing, 9 way X4	222154																						
1	Plug terminal 3 way X17	220856																						
10	screw 	221657																						
No.	Designation	Mat. No.																						
Date: 24.05.93 File: S2-API Mat. No. BPZ: 253227	Acc. pack. slip S2-API Z.No.:109-0743-4248-00																							

Figure 5.3: An example of the plug accessories set packaging slip.

Individual plug connectors and cables

Individual cables are rolled up and loosely packed in with the delivery. The sequential order number is always printed on them.

Single plug connectors are packed into plastic bags. The bags have a label which indicate order number, appearance and dimensions of the mounted plug connector.

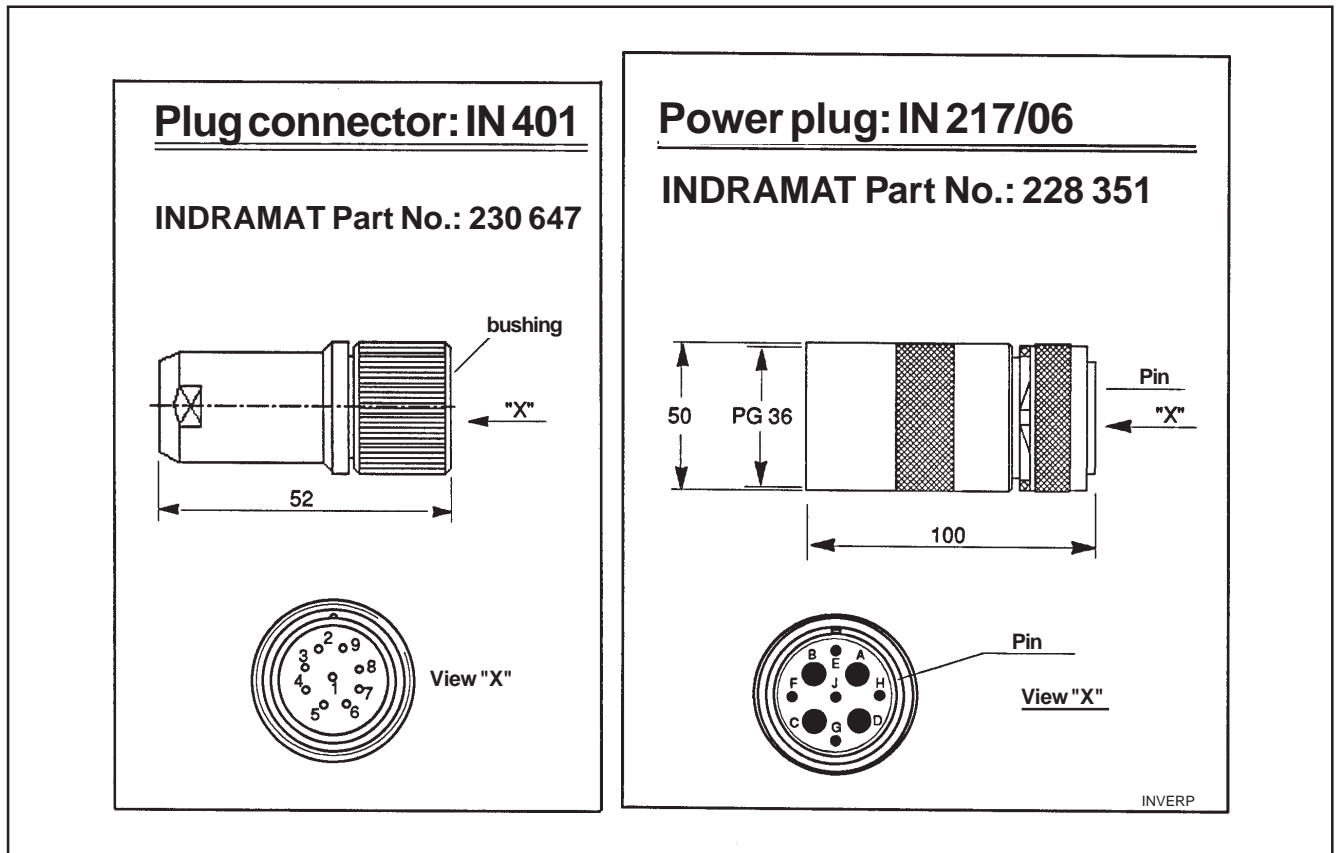

Figure 5.4: Packing single plug connectors (example)

Single plug connectors are packed into a sealed carton along with plug accessories sets and the controller-specific connections.

Controller-specific connections

The controller-specific connections are also packed in plastic bags and labelled with the respective order number. E•••• for KDA/TDA controllers (depending upon the arrangement within the drive package), E1-RAC for RAC controllers.

Further information about the controller-specific connections can be found in the document on the respective controller - „Project Planning Notes“.

Note: The controller-specific connections are always required!

Storage

Assembled cables, plug accessory sets, the controller-specific connections, individual plug connectors and cables should be stored dry and dust-free. Permissible storage temperature range equals -30 to +85 degrees C.

6. Customizing Specifications

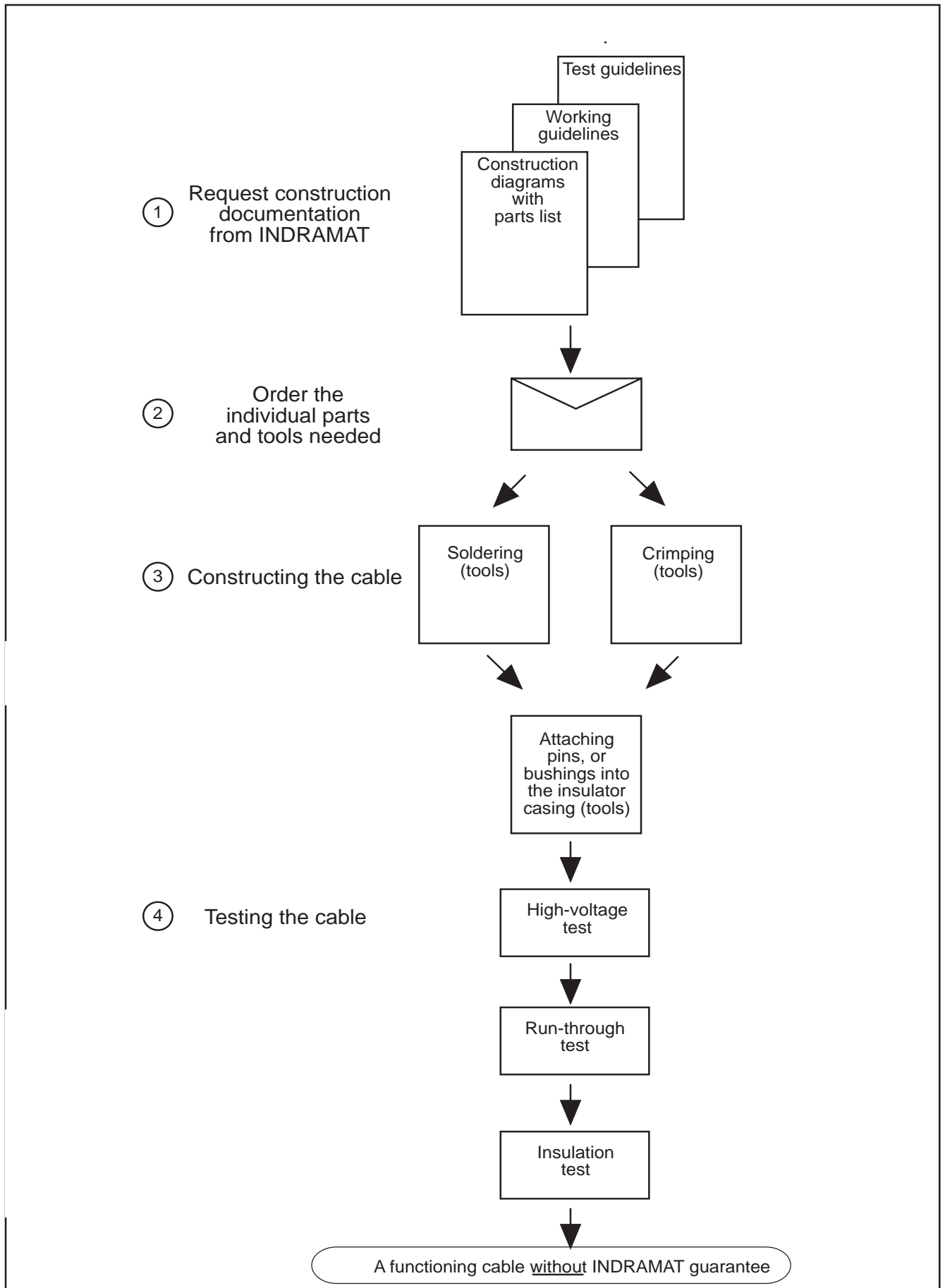
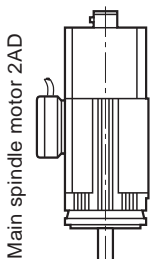
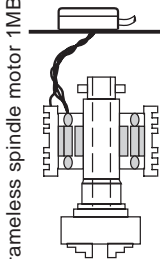





Figure 6.1: Customizing a power cable

Customizing a motor power cable

Motor	Crimping cable lug	Reduction	Screws	Cable	Cross section in mm ²	... on the controller
 <p>Main spindle motor 2AD</p>  <p>Frameless spindle motor 1MB</p>	Terminal box bolts					
		(dropped)	PG29 Mat. no. 220 874	IN204 (flex.)	6	
		(dropped)	PG29 Mat. no. 220 874	IN404 (highly flex.)	6	
		(dropped)	PG29 Mat. no. 220 742	IN205 (flex.)	10	
		(dropped)	PG29 Mat. no. 220 554	IN405 (highly flex.)	10	
		(dropped)	PG29 Mat. no. 220 472	IN206 (flex.)	16	
		(dropped)	PG29 Mat. no. 220 472	IN406 (highly flex.)	16	
		PG29/PG36 Mat. no. 226 349	PG36 Mat. no. 220 473	IN207 (flex.)	25	
		(dropped)	PG29 Mat. no. 220 472	IN407 (highly flex.)	25	
		PG42/PG36 Mat. no. 226 350	PG36 Mat. no. 243 552	IN267 (flex.)	35	
		(dropped)	PG42 Mat. no. 253 479	IN268 (flex.)	50	
			PG36 Mat. no. 220 473	IN207 (flex.)	25	
			PG29 Mat. no. 220 472	IN407 (highly flex.)	25	
			PG36/PG29 Mat. no. 220 474			











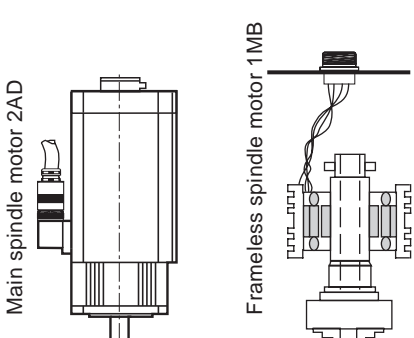

PGREDKLK









*) Available. For inquiries on type information contact Development Dept., INDRAMAT.

Figure 6.2: Screw and reduction specifications for motor power connections via terminal boxes.

Allocation of motor type to the PG thread of the respective terminal box is listed in the table outlining assembled specifications in Section 2.1.3.

Motor	Power plug connector	Reduction	Bolts	Cable	Cross section in mm ²	... on the controller
 <p>Main spindle motor 2AD</p> <p>Frameless spindle motor 1MB</p>	 <p>IN172** (Specs also apply to IN210/... IN217/..)</p>	 PG36/PG29 Mat. no. 220 474	PG29 Mat. no. 220 874	IN203 (flex.)	4	
		 PG36/PG29 Mat. no. 220 474	PG29 Mat. no. 220 874	IN403 (highly flex.)	4	
		 PG36/PG29 Mat. no. 220 474	PG29 Mat. no. 220 874	IN204 (flex.)	6	
		 PG36/PG29 Mat. no. 220 474	PG29 Mat. no. 220 874	IN404 (highly flex.)	6	
		 PG36/PG29 Mat. no. 220 474	PG29 Mat. no. 220 472	IN205 (flex.)	10	
		 PG36/PG29 Mat. no. 220 474	PG29 Mat. no. 221 554	IN405 (highly flex.)	10	
		 PG36/PG29 Mat. no. 220 474	PG29 Mat. no. 220 472	IN206 (flex.)	16	
		 PG36/PG29 Mat. no. 220 474	PG29 Mat. no. 220 472	IN406 (highly flex.)	16	
		 PG36/PG29 Mat. no. 220 474	PG36 Mat. no. 220 473	IN207 (flex.)	25	
		 PG36/PG29 Mat. no. 220 474	PG29 Mat. no. 220 472	IN407 (highly flex.)	25	

Symbols:

 Power plug connector (plug)
  Power plug connector (coupling)
  PG screw connection
  Wire-end ferrule
  Crimping cable lug
  Flange connection
  Reduction

*) Available. For inquiries on type information contact Development Dept., INDRAMAT.

PGRED172

Figure 6.3: Specifications for bolts and reduction for motor power connections via power plug connectors.

It is only possible to solder the power plug connectors – independent of cable core cross sections – in types IN172/25, IN 210/25 and IN217/25!

7. Index

Symbole

1MB connected to RAC 28
1MB to KDA/TDA 27
2AD 100 with KDA/TDA 21
2AD 100 and 2AD 101 connections 20
2AD 132 CONNECTED TO KDA/TDA 23
2AD 132 connected to KDA/TDA 25
2AD to KDA/TDA 27
2S 100 WITH KDA/TDA 22

A

Ambient temperatures 13
Analogue outputs 68
AS programming module 87
Autotransformer 48

B

Bending radius 45

C

Cable conduit 85
Cable construction 91
Category of Protection for the Cable 87
CNC Connections 56
Conductive contamination 86
Conductor cross sections, sized 13
Connecting an RAC to a three-phase mains 49
Connecting components 53
Connecting RAC with overvoltage surge arresters 50
Connection 2AD 132 with KDA/TDA 21
Connection 2AD 180 26
Connection of 1MB to KDA/TDA 27
Connection of 2AD 100 to KDA/TDA 20
Connection plans for feedback and CNC 60
Connection plans, motor-controller 19
Connection with intermediate terminals, feedback/C 58
Connection with plug design 58
Connection with plugin testing point 59
Contamination, degree of 86
Control circuits RAC 75
Control input 68
Control voltage bus end plug 87
Controller-specific connections 12
Crimping 91
Customizing specification 91

D

Diameter 45
Direct connections, feedback and CNC 57
Drive configuration 87
Drive shutdown 75

E

Earth leakage circuit breaker 49
Environmental conditions 86
Equalizing the voltage 48

F

Feedback and CNC Connections 11, 56
Feedback and CNC connections 76
Feedback connections 56
Flanged socket 86
Freewheeling diodes 87
Fuse type 52

G

Grounded Three-Phase Mains 48

H

Heatsink fan cable 87
High-resolution motor feedback 61
High-voltage test 91
Holding Brake 19
Holding brake 9

I

IKS015/IKS016 73
IKS045 69
IKS314 64, 66
IKS610 68
IKS612 70
IKS614 72
IKS618/IKS620 74
IN 203 45
IN 204 45
IN 205 45
IN 206 45
IN 207 45
IN 209 84
IN 233 84
IN 234 84
IN 267 45
IN 271 84
IN 403 45
IN 404 45
IN 405 45
IN 406 45
IN 407 45
Incremental encoder output 74
Individual plug connectors 11, 90
Installation guidelines 85
Insulation test 91
Insulator casing 91
Interference sources inside the control cabinet 87
Interference-free operation 85
Isolating transformer 48

K

KDA/TDA elec. conn. 8

L

Lead Spindle Feedback 67

Line 10

Line construction 45

Line lengths 14

Line routing 85

Line specifications for feedback and CNC connectio 45

Load capacity table 13

M

Mains connection line for RACs 55

Mains connection specifications 52

Mains voltage 47

Mass potential loops 85

Motor fan 19

Motor feedback, incremental encoder 63

Motor with blocking brake 19

Motor-controller connection with plug design 17

Motor-controller connection with plugin testing po 18

Motor-controller direct connection 16

Motor-controller power connections 15

N

Non-conductive contamination 86

O

Operating temperature, cable 13

Outer wire 47

Overvoltages 47

P

Packaging slip 89

PG thread 92

Plug accessory sets 88

Plug connector 90

Position set-point, digital 72

Power cable with intermediate terminal at terminal 17

Power cable with plug design 17

Power cable with plugin testing points 18

Power cables for direct connections 16

Power connections of the RAC three-phase mains 46

Power motor-controller connections 29

Power plug 90

Power plug connectors 86

Processing cycle 53

Protective caps 86

Protective circuits 87

Protective motor switch 19

R

RAC elec. conn. 9

Rated connection voltag 47

Rated connection voltage for control electronics 47
RC suppressor components 87
Reduction 92, 93
Relative short-circuit voltage 53
Run-through test 91

S

Screws 92
SERCOS Interface 71
Serial interface 73
Shielding of bunched conductors 85
Sizing the Autotransformer 53
Sizing the Isolating Transformer 54
Soldering 91
Soldering of power plug connectors 93
Specifications of the power connection 10
Speed set-point, analog 69
Speed set-point, digital 70
spindle feedback 66
Storage 90
Storage temperature 90
Supply module 87
Surge arresters 48, 55

T

Table of power connections to the motor 29
Tables, feedback and CNC conn. 76
Terminal box 92
Three-Phase Mains 47
Tools 91

U

Ungrounded Three-Phase Mains 48

V

Varistors 87
Viewing panes 87

W

Weight 45
Wetting from coolants or lubricants 86
Wiring 85
Wye-point and outer wire grounded three-phase main 48

Summary of supplementary documentation

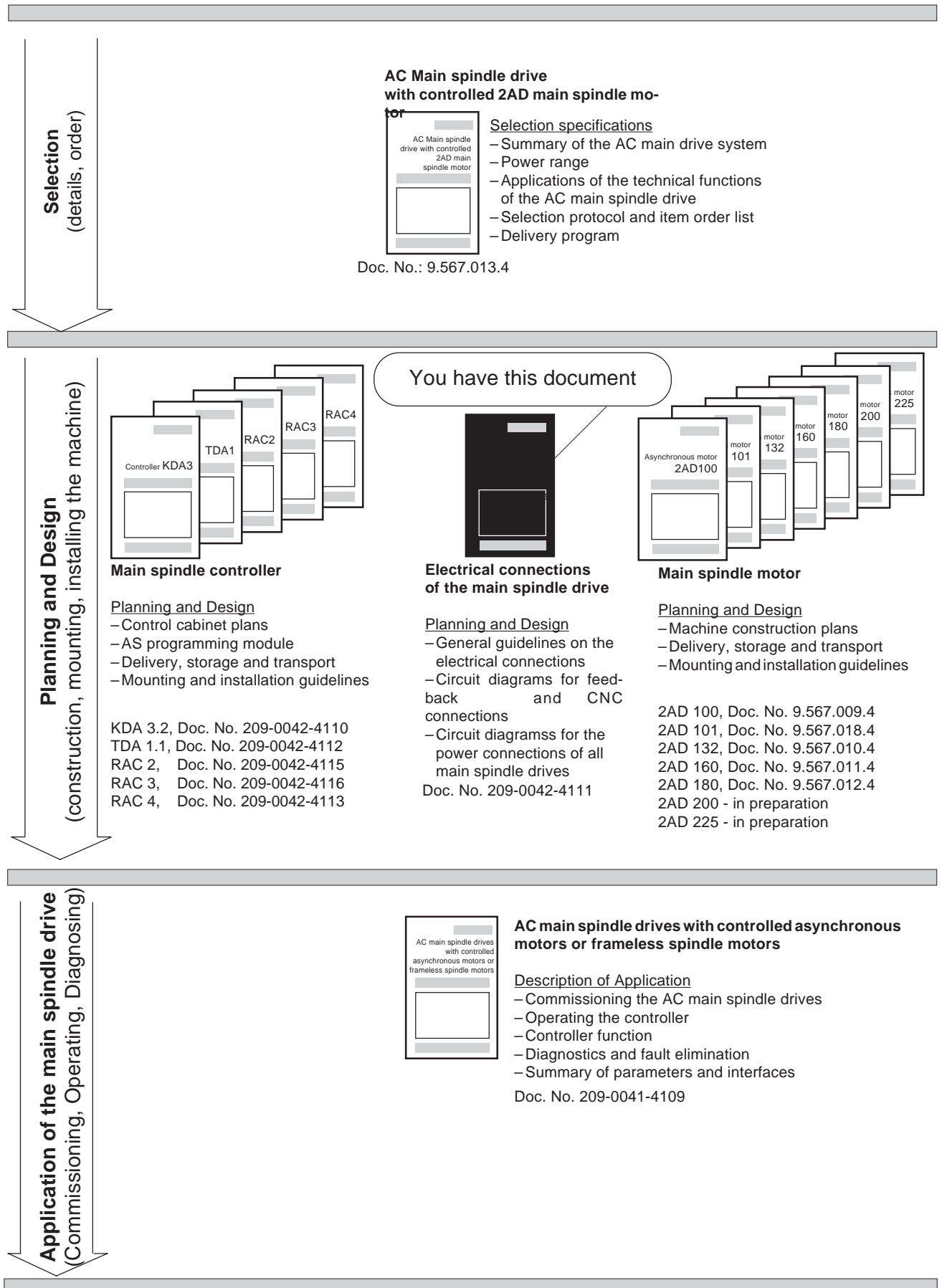
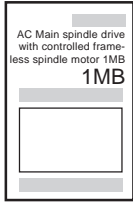

Figure 8.1: Summary of supplementary documentation

AC Main spindle drive with controlled frameless spindle motor 1MB



- Selection specifications**
- Summary of the AC main drive system
 - Power range
 - Applications of the technical functions of the AC main spindle drive
 - Selection protocol and items order list
 - Delivery program

Doc. No. 9.567.012.4

AC main spindle drives with controlled asynchronous motor 2AD and changeover planetary gearboxes 2K

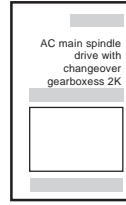

- Selection specifications**
- Summary of the AC main drive system
 - Power range
 - Order guidelines

Doc. No. 9.567.022.4

Selection
(details, order)

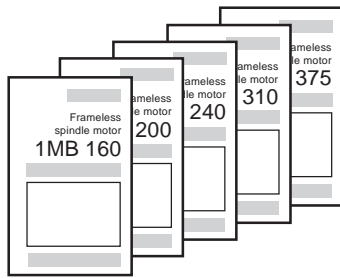

Frameless spindle motor

Planning and Design

- Machine construction plans
- Integrating into the cooling system
- Electrical and coolant connections
- Delivery

- 1MB 160, Doc. No. 9.576.014.4
- 1MB 200, Doc. No. 9.576.016.4
- 1MB 240/241, Doc. No. 9.576.015.4
- 1MB 310/312, Doc. No. 9.576.008.4
- 1MB 375, Doc. No. 9.576.007.4

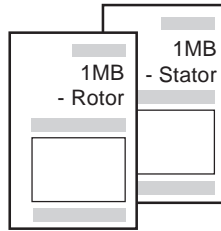

Mounting guidelines

- Delivery, handling, transport
- Mounting
- Cooling guidelines

- Stator, Doc. No. 9.600.063.4
- Rotor, Doc. No. 9.600.062.4

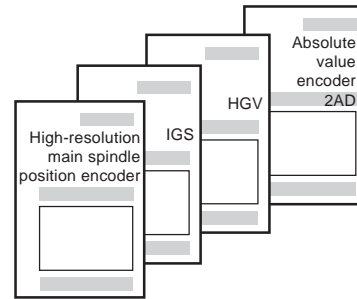

Supplementary documentation

- high-resolution main spindle encoder
 - application description
Doc. No. 9.552.247.4
 - mounting guidelines
Doc. No. 9.600.060.4
- incremental encoder output IGS
Doc. No. 9.568.015.4
- high-resolution encoder junction HG
Doc. No. 9.568.010.4
- absolute value encoder attachment for 2AD 132, 2AD 160, 2AD 180
Doc. No. 9.568.020.4

Planning and Design
(construction, mounting, installing the machine)

Application of the main spindle drive
(Commissioning, Operating, Diagnosing)

