

# New Multi-functional & Economical PLC

Body equipped with combined relay and transistor output



L30R

#### Super-high processing speed

80 ns/step (0 to 3000 steps for ST command)

#### Number of I/O points expandable up to 216 max.

When using FP0R extension unit\*2

#### Combined output (Ry+Tr)

Tr: 4 points, 0.5 A (Only 2 points for L14)

#### Built-in 2-axis pulse output

50 kHz max.\*1

#### Built-in 2-channel multi-functional analog input

Voltage, thermistor and potentiometer input \*2

#### Built-in calendar/clock\*2

#### Built-in RS485 communication port\*3

\*1) L14 is 1-axis/20 kHz max. and L30 is 2-axis/20 kHz max.

\*2) Only for L40R, L40MR, L60R and L60MR models

\*3) Only for L40MR and L60MR models



L14R



L40R/L40MR

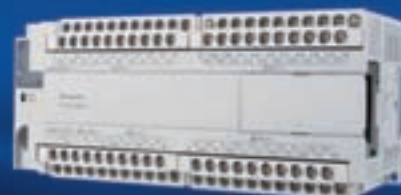

L60R/L60MR

## Super-high Processing Speed

Super-high speed of 80 ns/step for 0 to 3000 steps (ST command). 580 ns/step processing speed for 3001 steps or more (Only for L40 and L60).

## Program Memory

L14 and L30: 2.5 k steps  
L40 and L60: 8 k steps

## The Maximum Number of I/O Points

One control unit can be connected with up to 3 expansion units. Therefore, the maximum number can reach 150 points.

In addition, if the expansion FP0 adaptor is used, the maximum number can reach 216 points when the FP0R expansion unit is used. (Only for L40R, L40MR, L60R and L60MR)

## Maximum 2-channel Communication Port

One RS232C programming port is equipped on the body. And RS485 communication port is also built in L40MR and L60MR.

## Modbus-RTU

Non-program communication with the devices (such as the temperature controller and the inverter etc.) using global universal industry standard Modbus-RTU (binary) can be realized simply.

## PLC Link

If L40MR and L60MR are used, the sharing of bit data and word data among 16 PLCs (max.) can be realized.

## Computer Link

Non-program communication with the devices (such as the display, image processor, temperature controller and wattmeter etc.) using Panasonic open protocol "MEWTOCOL" can be realized simply.

## Universal Serial Communication

It can generate or send the corresponding commands according to the communication protocol used by the pairing device. In addition, it can also receive the flow data, such as the data from the measuring instrument, bar code reader and RF-ID etc.

# FP-X0

**Rich Functions, High Cost-effective.**

**Strong Lineup, Wide Application.**

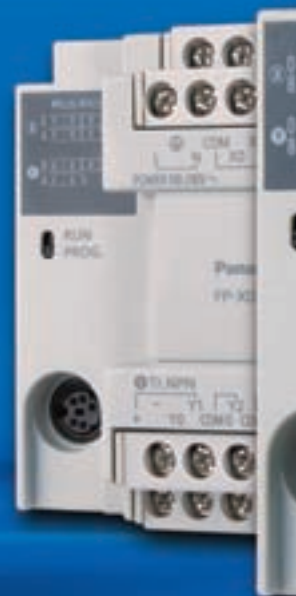

## 6 Kinds of Control Units

L14R, L30R, L40R and L60R: Ry+Tr, AC  
 L40MR, L60MR: Ry+Tr, RS485, AC

## 11 Kinds of Expansion Units (FP-X)

(16 points) × (Ry, NPN, PNP)

(30 points) × (Ry, NPN, PNP) (AC, DC)

Specific unit for input (E16X)

Specific unit for output (E14YR)

3 units max. can be added.

E16X, E16T, E16P upgraded to Ver.3 or later can be connected (The number of connected units is limited.)

## 56 Kinds of Combinations (of I/O number)

14 to 150 points (FP0R expansion units excluded)

## Built-in 2-axis Pulse Output Function

L14 is 1-axis pulse output, while L30/L40/L60 are 2-axis, and the pulse output function is built in the body of the controller. Built-in 2-axis type can realize linear interpolation (Only for L40 and L60).

## Analog Input Function

Multi-functional analog input (10 bit, 2-channel)

Voltage input (0 to 10 V), thermistor input and adjustable potentiometer input.





# Basic Performance (Expansion)

Programmable Controller **FP-X0**

## ■Plenty of I/O Points -150 points max.

(If further expansion is made to FP0R expansion unit, the number can be expanded to 216 points max.)

If the customer can not predict the number of I/O points needed by his machineries and devices in the future, he will feel hesitant and uncomfortable. But, the I/O number of FP-X0 can reach 150 points max. by using the FP-X expansion unit. Therefore, the customer's discomfort and hesitation can be eliminated. And the number of I/O points can be expanded to 216 by using the FP0R expansion unit. (L14R and L30R don't have the expansion function, so they can not be expanded.)

•The maximum number of expansion unit is up to 3 units



The cable between the units can be bent to realize the side-by-side installation, thus saving the installation space.

### [Expansion]

•E16X, E16T and E16P upgraded to Ver.3 or later can be connected in series up to 3 units. But, E14 and E16 expansion units can not be connected at the right sides of E16X/E16T/E16P (Ver.2 earlier) or E16R/E14YR.

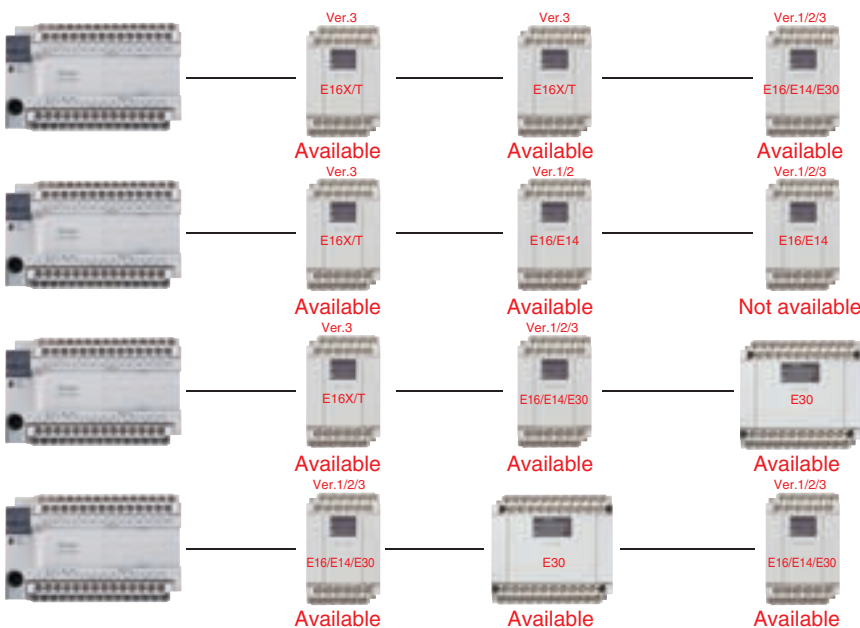

| Product name | Power supply | Specifications  | Model      |
|--------------|--------------|---|------------|
| FP-X E16X    | -            | DC input, 16 points                                     | AFPX-E16X  |
| FP-X E14YR   | -            | 2A relay output, 14 points                              | AFPX-E14YR |
| FP-X E16R    | -            | DC input, 8 points<br>2 A relay output, 8 points        | AFPX-E16R  |
| FP-X E30R    | AC           | 16-point DC input<br>14-point 2A relay output           | AFPX-E30R  |
| FP-X E30RD   | DC           | 16-point DC input<br>14-point 2A relay output           | AFPX-E30RD |
| FP-X E16T    | -            | 8-point DC input<br>8-point transistor (NPN) output     | AFPX-E16T  |
| FP-X E16P    | -            | DC input, 8 points<br>8-point transistor (PNP) output   | AFPX-E16P  |
| FP-X E30T    | AC           | DC input, 16 points<br>14-point transistor (NPN) output | AFPX-E30T  |
| FP-X E30TD   | DC           | 16-point DC input<br>14-point transistor (NPN) output   | AFPX-E30TD |
| FP-X E30P    | AC           | 16-point DC input<br>14-point transistor (PNP) output   | AFPX-E30P  |
| FP-X E30PD   | DC           | 16-point DC input<br>Transistor (PNP) output, 14 points | AFPX-E30PD |

## ■Further expansion and more functions achieved by using the existing FP0R expansion unit easily

The maximum number of FP0R expansion unit is up to 3 after all the control units are equipped with adaptors.

A wider range of application can be achieved by using[transistor output],[analog I/O],[thermocouple input]and[I/O LINK (network)].

Only one FP0 expansion adaptor can be installed on the control unit.

In addition, two FP-X expansion units can be installed after the adaptor is installed.



FP0 expansion adaptor (AFPX-EFPO)

Besides the supplied expansion cable of 8 cm, 30 cm and 80 cm types are also sold separately. They can be bent or straightened. (The total extension length is within 160 cm.)

| Model      | Specifications   |
|------------|--|
| AFP0RE8X   | 8-point DC input MIL connector                               |
| AFP0RE16X  | 16-point DC input MIL connector                              |
| AFP0RE8YT  | 8-point transistor output MIL connector                      |
| AFP0RE8YRS | 8-point relay output screw terminal block                    |
| AFP0RE16YT | 16-point transistor output MIL connector                     |
| AFP0RE16T  | 8-point DC input, 8-point transistor output, MIL connector   |
| AFP0RE32T  | 16-point DC input, 16-point transistor output, MIL connector |
| AFP0RE8RS  | 4-point DC input, 4-point relay output, screw terminal block |
| AFP0RE16RS | 8-point DC input, 8-point relay output, screw terminal block |

| Model    | Specifications                        |
|----------|---------------------------------------|
| FP0-A21  | Analog 2-point input , 1-point output |
| FP0-A80  | Analog 8-point input                  |
| FP0-A04V | Analog (voltage) 4-point output       |
| FP0-A04I | Analog (current) 4-point output       |
| FP0-TC4  | Thermocouple 4-point input            |
| FP0-TC8  | Thermocouple 8-point input            |
| FP0-IOL  | I/O LINK unit                         |
| FP0-CCLS | CC-Link slave unit                    |

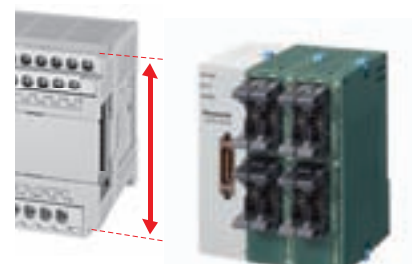

Both of them are 90 mm and can be installed in the cabinet.

# Special Functions

Programmable Controller **FP-X0**

## ■ Pulse output function / High-speed counter function

The pulse output function of FP-X0 (1-axis for L14 and 2-axis for L30/L40/L60) is built in the body of the control unit. Compared with the previous PLC that must use the advanced or specific positioning units or more than two multi-axis control devices, FP-X0 only uses one unit basically, thus saving the space and reducing the cost.

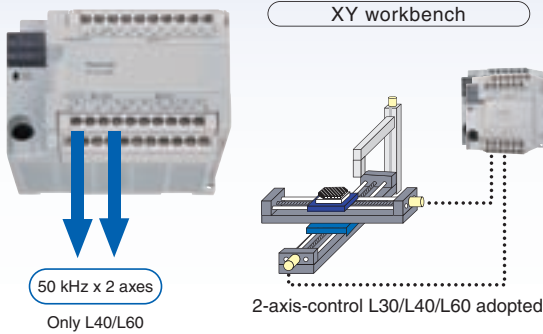

| Items                          | Specifications  |
|--------------------------------|---|
| Max. frequency of pulse output | L14: 20kHz(CH0) L30: 20kHz(CH0,1)<br>L40 L60: 50kHz(CH0,1)  |
| Output mode                    | CW / CCW, Pulse/Sign output   |
| Function                       | Trapezoidal control, multi-speed operation, JOG operation, original position return, 2-axis linear interpolation (Only L40 and L60) |

## L40 and L60 adopting 2-axis linear interpolation

2-axis linear interpolation is a kind of function that controls 2 motor axes and makes the robot arm and tool head carry out diagonal line moving simultaneously, which is applied in the stacker's picking & mounting components, the control of XY workbench and the baseplate cutting etc.

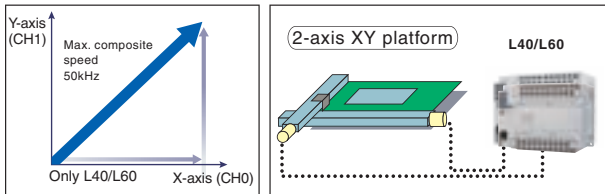

## ■ Body equipped with combined relay and transistor output

The load capacity of the transistor is up to 0.5 A.

## Built-in 4-point high-speed counter

4-point for 1-phase or 2-point for 2-phase (X0 to X3)



| Model   | HSC input mode | Pulse output (1-axis) | When HSC using 1 channel | When HSC using all the channels |
|---------|----------------|-----------------------|--------------------------|---------------------------------|
| L14     | 1-phase        | Stopping              | 20 kHz                   | 20 kHz                          |
|         |                | Outputting            | 20 kHz                   | 20 kHz                          |
|         | 2-phase        | Stopping              | 20 kHz                   | 20 kHz                          |
|         |                | Outputting            | 17 kHz                   | 16 kHz                          |
| Model   | HSC input mode | Pulse output (2-axis) | When HSC using 1 channel | When HSC using all the channels |
| L30     | 1-phase        | Stopping              | 20 kHz                   | 20 kHz                          |
|         |                | Outputting            | 20 kHz                   | 14 kHz                          |
|         | 2-phase        | Stopping              | 20 kHz                   | 20 kHz                          |
|         |                | Outputting            | 13 kHz                   | 12 kHz                          |
| L40/L60 | 1-phase        | Stopping              | 50 kHz                   | 33 kHz                          |
|         |                | Outputting            | 36 kHz                   | 24 kHz                          |
|         | 2-phase        | Stopping              | 20 kHz                   | 16 kHz                          |
|         |                | Outputting            | 16 kHz                   | 13 kHz                          |

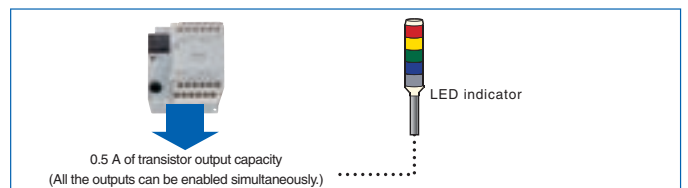

## ■ Built-in PID command (F356 EZPID)

One line of temperature-control program is enough.

A wider range of temperature-control applications is achieved through the use of PLC, such as the multi-section temperature control, temperature control linked with the timer, variable temperature control based on the data calculation results and multi-point temperature control etc. Using new PID commands (F356 EZPID) makes the PID control program simplified substantially than before. It was considered relatively hard to carry out temperature control through PLC before, but now it becomes quite easy. The example shown at the right side is a simple constant temperature control. If you use the F356 command together with the combination operation of touch screen, only one line of program is needed, thus making PID control amazingly simple.

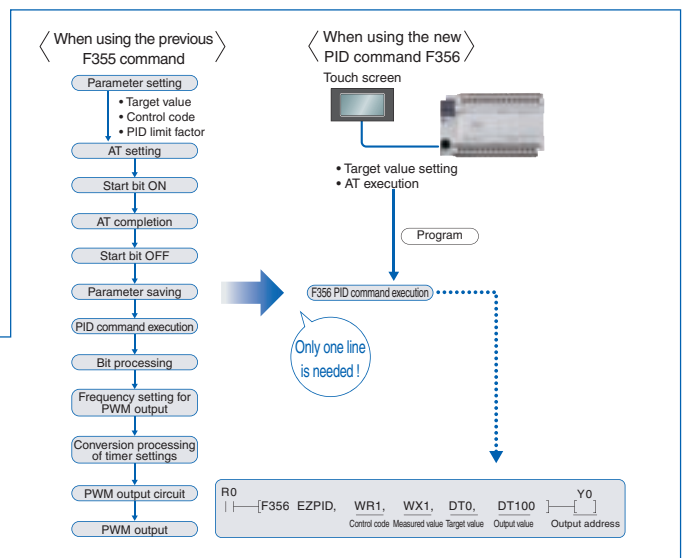
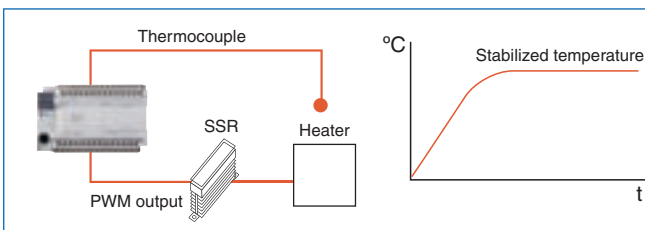

# Part Number List

## Programmable Controller FP-X0 Control Unit

### 1) Control unit

| Product name | Power supply    | Specifications  | Specifications   |                    |                     | Part No.   |
|--------------|-----------------|---|------------------|--------------------|---------------------|------------|
|              |                 |   | Program capacity | Analog input       | RS485 communication |            |
| FP-X0 L14R   | 100 to 240 V AC | 24 V DC input, 8 points<br>0.5 A/5 to 24 V DC transistor output, 2 points<br>2 A relay output, 4 points   | 2.5 k steps      | -                  | -                   | AFPX0L14R  |
| FP-X0 L30R   | 100 to 240 V AC | 24 V DC input, 16 points<br>0.5 A/5 to 24 V DC transistor output, 4 points<br>2 A relay output, 10 points | 2.5 k steps      | -                  | -                   | AFPX0L30R  |
| FP-X0 L40R   | 100 to 240 V AC | 24 V DC input, 24 points<br>0.5 A/5 to 24 V DC transistor output, 4 points<br>2 A relay output, 12 points | 8 k steps        | 10 bits, 2 channel | -                   | AFPX0L40R  |
| FP-X0 L40MR  | 100 to 240 V AC | 24 V DC input, 24 points<br>0.5 A/5 to 24 V DC transistor output, 4 points<br>2 A relay output, 12 points | 8 k steps        | 10 bits, 2 channel | Available           | AFPX0L40MR |
| FP-X0 L60R   | 100 to 240 V AC | 24 V DC input, 32 points<br>0.5 A/5 to 24 V DC transistor output, 4 points<br>2 A relay output, 24 points | 8 k steps        | 10 bits, 2 channel | -                   | AFPX0L60R  |
| FP-X0 L60MR  | 100 to 240 V AC | 24 V DC input, 32 points<br>0.5 A/5 to 24 V DC transistor output, 4 points<br>2 A relay output, 24 points | 8 k steps        | 10 bits, 2 channel | Available           | AFPX0L60MR |

Note) 24 V DC input: ± common

### 2) Expansion unit

FP-X expansion I/O unit and FP0R unit can be used.  
But FP0 adaptors for FP-X expansion are required when FP0R expansion units are used.

### 3) Software tools (Refer to Operation Manual for the details.)

| Product name | Software classification                  | Part No.  |
|--------------|--|-----------|
| FPWIN GR     | Japanese version with supplied cable kit | AFPS10122 |
|              | English version Full type                | AFPS10520 |
|              | English version Lite type                | AFPS11520 |
|              | Chinese version Full type                | AFPS10820 |
| FPWIN Pro    | Korean version                           | AFPS10920 |
|              | Japanese version                         | AFPS50160 |
|              | English version                          | AFPS50560 |

Note) For FP-X0: FPWIN GR Ver.2.91 or later  
FPWIN Pro Ver.6.31 or later

### 4) Other cables and maintenance parts

| Product name                                   | Specifications                                    | Part No.                          |          |
|--|---|-----------------------------------|----------|
| Backup battery                                 | For data storage backup and calendar/clock backup | AFP8801                           |          |
| FP-X expansion cable <sup>Note)</sup>          | 8cm   | AFPX-EC08                         |          |
|  | 30cm  | AFPX-EC30                         |          |
|  | 80cm  | AFPX-EC80                         |          |
| Cable for FP and computer connection (M5 type) | 3 m   | Round D-SUB, 9-pin, L-shaped type | AFC8503  |
|  |   | Round D-SUB, 9-pin, Straight type | AFC8503S |
| Power cable for FP0                            | For the adaptor for FP0 expansion, 1 m long       | AFP0581                           |          |
| Installation bracket for FP0 (Long-strip type) | For FP0 expansion unit, 10 pieces per package     | AFP0803                           |          |

Note) The cables for expansion can be extended to 160 cm max.

## Specifications

### 1) Performance specifications

| Items                             | Specifications   |   |  |                                |  |       |  |
|-----------------------------------|--|---|--|--------------------------------|--|-------|--|
|                                   | L14R   | L30R  | L40R   | L40MR                          | L60R   | L60MR |  |
| Control unit                      | DC input 8 points, Relay output 4 points, Transistor output 2 points   | DC input 16 points, Relay output 10 points, Transistor output 4 points  | DC input 24 points, Relay output 12 points, Transistor output 4 points                         |                                | DC input 32 points, Relay output 24 points, Transistor output 4 points |       |  |
|                                   | When using FP-X E16 expansion I/O units  | -   | 88 points max. (3 expansion units max.)  |                                | 108 points max.  |       |  |
|                                   | When using FP-X E30 expansion I/O units  | -   | 130 points max. (3 expansion units max.)   |                                | 150 points max. (3 expansion units max.)                               |       |  |
|                                   | When using FP0R expansion units  | -   | 196 points max. (3 expansion units max.)   |                                | 216 points max. (3 expansion units max.)                               |       |  |
| Programming method/Control method | Relay symbol/Cyclic operation  |   |  |                                |  |       |  |
| Program memory                    | Built-in Flash-ROM (Free of backup battery)  |   |  |                                |  |       |  |
| Program capacity                  | 2.5 k steps  |   | 8 k steps  |                                |  |       |  |
| No of instruction                 | Basic commands   | Approx. 114 kinds   |  |                                |  |       |  |
|                                   | High-level commands  | Approx. 230 kinds   |  |                                |  |       |  |
| Processing speed                  | 0.08 μs/step for basic commands  |   | 3 k steps: 0.08 μs/step for basic commands, 0.32 μs for high-level commands(MV commands)       |                                |  |       |  |
|                                   | 0.32 μs for high-level commands (MV commands)  |   | After 3 k steps: 0.58 μs/step for basic commands, 1.62 μs for high-level commands(MV commands) |                                |  |       |  |
| I/O refreshing + basic time       | Basic time   | 0.15 ms or less   | 0.18 ms or less  | 0.31 to 0.35 ms or less        | 0.34 to 0.39 ms or less  |       |  |
|                                   |  | When using E16: 0.4 ms × No. of units<br>When using E30: 0.5 ms × No. of units<br>When using FP0 expansion adaptors: 1.4 ms + the refreshing time of the FP0 expansion unit |  |                                |  |       |  |
| Memory for processing             | Relays   | External input (X) <sup>Note 1)</sup>   | 960 points   | 1760 points                    |  |       |  |
|                                   |  | External output (Y) <sup>Note 1)</sup>  | 960 points   | 1760 points                    |  |       |  |
|                                   |  | Internal relay (R)  | 1008 points  | 4096 points                    |  |       |  |
|                                   |  | Special internal relay (R)  | 224 points   |                                |  |       |  |
|                                   |  | Timer-Counter (T/C)   | 256 points <sup>Note 2)</sup>  | 1024 points <sup>Note 2)</sup> |  |       |  |
|                                   | Memory area  | Link relay (L)  | No   | 2048 points                    |  |       |  |
|                                   |  | Data register (DT)  | 2500 words   | 8192 words                     |  |       |  |
|                                   |  | Special data register (DT)  | 420 words  |                                |  |       |  |
|                                   |  | Link data register (LD)   | No   | 256 words                      |  |       |  |
|                                   |  | File registration (FL)  | No   |                                |  |       |  |
| Index register (I)                | 14 words (IO to ID)  |   |  |                                |  |       |  |
| Differential points               | Equivalent to program capacity   |   |  |                                |  |       |  |
| Master control relay (MCR)        | 32 points  | 256 points  |  |                                |  |       |  |
| Label number (JP+LOOP)            | 100 points   | 256 points  |  |                                |  |       |  |
| No. of step programs              | 128 (Engineering)  | 1000 (Engineering)  |  |                                |  |       |  |
| No. of subroutines                | 100  | 500   |  |                                |  |       |  |
| No. of interrupt programs         | Input: 8 programs, timing: 1 program   |   |  |                                |  |       |  |
| Sampling trace                    | No   | Yes   |  |                                |  |       |  |
| Comments storage                  | All of the I/O comments, explanations and block comments can be saved. (Free of backup battery, 328 k bytes) |   |  |                                |  |       |  |
| PLC link function                 | No   | Yes   |  |                                |  |       |  |
| Constant scan                     | In unit of 0.5 ms: 0.5 ms to 600 ms  |   |  |                                |  |       |  |
| Password                          | Available (4 or 8 digits)  |   |  |                                |  |       |  |
| Upload protection                 | Available  |   |  |                                |  |       |  |
| Self-diagnosis function           | Checks of the watchdog timer and the program syntax  |   |  |                                |  |       |  |

| Items  | Specifications   |   |   |  |  |       |  |
|--|--|---|---|--|--|-------|--|
|  | L14R   | L30R  | L40R  | L40MR  | L60R   | L60MR |  |
| Program editing during Run                               | Available (Capacity modified simultaneously: 128 steps)<br>But comments cannot be modified during the process. |   | Available (Capacity modified simultaneously: 512 steps)<br>But comments can be modified during the process.   |  |  |       |  |
| Downloading during Run                                   | Available  |   |   |  |  |       |  |
| High-speed counter <sup>Note 3)</sup> <sup>Note 4)</sup> | Body input   | 1-phase, 4-channel (20 kHz max.) and 2-phase, 2-channel (20 kHz max.) |   | 1-phase, 4-channel (50 kHz max.) and 2-phase, 2-channel (20 kHz max.)  |  |       |  |
|  |  | Body output   | Pulse: 1-channel (20 kHz max.)<br>PWM: 1-channel (1.6 kHz max.)   | Pulse: 2-channel (20 kHz max.)<br>PWM: 2-channel (1.6 kHz max.)  | Pulse: 2-channel (50 kHz)<br>PWM: 2-channel (3.0 kHz max.) |       |  |
| Pulse catch input/Interrupt program                      | 8 points (High-speed counting and interrupt input included)  |   |   |  |  |       |  |
| Periodical interrupt                                     | 0.5 ms unit: 0.5 ms to 1.5 s, 10 ms unit: 10 ms to 30 s  |   |   |  |  |       |  |
| Analog input   | No   |   | 2-channel (For inputting any of the following items in each channel)<br>Potentiometer input<br>Min. resistance value of potentiometer: 5 kΩ<br>10-bit resolution (K0 to K1000)<br>Accuracy ± 1.0% F.S.+ accuracy of external resistors<br>Thermistor input<br>For inputting the resistance value of the thermistor (Min. resistance value of external thermistors + external resistance value > 2 kΩ)<br>10-bit resolution (K0 to K1023)<br>Accuracy ± 1.0% F.S.+ accuracy of external thermistors<br>Voltage input<br>Absolute max. input voltage: 10 V<br>10-bit resolution (K0 to K1023)<br>Accuracy ± 2.5% F.S. (F.S. = 10 V) |  |  |       |  |
|  | Calendar/clock   | No  |   | Yes  |  |       |  |
|  | Flash ROM backup <sup>Note 5)</sup>  | Backup made according to commands of F12 and P13                      | Data memory (2500 words)  | Data memory (8192 words)   |  |       |  |
|  |  | Automatic backup when power OFF                                       | Counter: 6 points (C250 to C255)<br>Process value of the counter: 6 points (EV250 to EV255)<br>Internal relays: 5 points (WR58 to WR62)<br>Data memory: 300 words (DT2200 to DT2499)  | Counter: 16 points (C1008 to C1023)<br>Process value of the counter: 16 points (EV1008 to EV1023)<br>Internal relays: 8 points (WR248 to WR255)<br>Data memory: 302 words (DT7890 to DT8191) |  |       |  |
| Backup battery   | No   |   | Yes (Backup lasting for the whole process)  |  |  |       |  |
| RS485 communication port                                 | No   |   | Yes   | No   | Yes  |       |  |

Note 1) The actual usable points depend on the combination of the hardware.  
Note 2) The points of the timer can be added as required.  
Note 3) The rated voltage is 24 V DC at 25 °C. The frequency may fall according to the changes of the voltage, temperature and operating conditions.  
Note 4) The maximum frequency may vary with the difference of the operating method.  
Note 5) The allowable writing operation is within 10000 times. Areas to be held and not held can be specified using the system registers.



## 2) General specifications

| Items  | Specifications   |   |
|--|--|---|
| Operating temperature  | 0 to +55°C   |   |
| Storage temperature  | -40 to +70°C   |   |
| Operating humidity   | 10 to 95% RH<br>(at 25 °C, no condensation)  |   |
| Storage humidity   | 10 to 95% RH<br>(at 25 °C, no condensation)  |   |
| Withstand voltage<br><small>Note 1)<br/>Note 2)</small>  | Input terminals ⇔<br>Relay output terminals  | 2300 V AC, 1 minute                                   |
|  | All of the transistor output terminals ⇔<br>All of the relay output terminals  |   |
|  | All of the input terminals⇔<br>All of the power supply terminals and functional ground terminals   |   |
|  | All of the relay output terminals ⇔<br>All of the power supply terminals and functional ground terminals   |   |
|  | All of the transistor output terminals ⇔<br>All of the power supply terminals and functional ground terminals  |   |
| Insulation resistance<br><small>Note 1)</small>  | Power supply terminals ⇔<br>Ground terminals   | 1500 V AC, 1 minute                                   |
|  | Input terminals ⇔<br>Transistor output terminals   | 500 V AC, 1 minute                                    |
|  | Input terminals ⇔<br>Output terminals  | 100 MΩ min.<br>(500 V DC insulation resistance meter) |
|  | All of the transistor output terminals ⇔<br>All of the relay output terminals  |   |
| All of the input terminals ⇔<br>All of the power supply terminals and functional ground terminals  |  |   |
| All of the output terminals ⇔<br>All of the power supply terminals and functional ground terminals |  |   |
| Vibration resistance   | 5 to 8.4 Hz, 3.5 mm amplitude in one direction, 1 scan/1 minute<br>8.4 to 150 Hz, fixed acceleration of 9.8 m/s <sup>2</sup> , 1 scan/1 minute<br>10 minutes in X,Y,Z direction each |   |
|  | Shock resistance   |   |
| Shock resistance   | 147 m/s <sup>2</sup> , 4 times in X, Y, Z directions each  |   |
| Noise immunity   | 1500 V [p-p] pulse width 50 ns, 1 μs<br>(Measured from noise simulation method AC power supply terminals)  |   |
| Operating environment  | No corrosive gases or too much dust  |   |
| Conformed EC Directives  | EMC Directive: EN61131-2,<br>Low Voltage Directive: EN61131-2  |   |
| Overvoltage class  | II   |   |
| Pollution level  | 2  |   |
| Weight   | L14R: approx. 280g L30R: approx. 450g<br>L40R/L40MR: approx. 530g L60R/L60MR: approx. 730g   |   |

Note 1) The programmable port, RS485 communication port and the internal digital circuit part are non-insulation type.

Note 2) The cut-off current is 5 mA (The default value when shipped from the factory).

## 5) Output specifications

### Relay output specifications

| Items  | Specifications                          |   |   |       |                |       |
|--|---|---|---|-------|----------------|-------|
|  | L14R                                    | L30R  | L40R  | L40MR | L60R           | L60MR |
| Insulation method  | Relay insulation                        |   |   |       |                |       |
| Output form  | 1a output (Relay replacement disabled)  |   |   |       |                |       |
| Rated control capacity (Resistance load)<br><small>Note)</small> | 2A 250 V AC, 2A 30 V DC<br>(per point)  |   |   |       |                |       |
| Output points per common   | 1 point/<br>COM×2<br>2 points/<br>COM×1 | 2 points/<br>COM×1<br>4 points/<br>COM×2  | 1 point/COM×2<br>2 points/COM×1<br>4 points/COM×2 |       | 4 points/COM×6 |       |
| Response time  | OFF→ON                                  | Approx. 10 ms   |   |       |                |       |
|  | ON→OFF                                  | Approx. 8 ms  |   |       |                |       |
| Life   | Mechanical                              | 20000000 times min.(Switching frequency 180 times/minute)   |   |       |                |       |
|  | Electrical                              | 100000 times min. (Depending on the rated control capacity, switching frequency of 20 times/minute) |   |       |                |       |
| Surge absorber   | No                                      |   |   |       |                |       |
| Action indicator   | LED indication                          |   |   |       |                |       |

Note) There are restrictions on the rated current for each output block. Each usable rated current is as below.

L14:Y2 to Y5(4 points) Max. 6A in total

L30:Y4 to YD(10 points) Max. 8A in total

L40:Y4 to YFD(12 points) Max. 8A in total

L60:Y4 to YB(8 points) Max. 8A in total, YC to Y1B(16 points) Max. 8A in total

### Circuit diagram



## 3) Power supply specifications

### AC power supply

| Items                                 | Specifications  |                                |
|---------------------------------------|---|--------------------------------|
|                                       | L14R  | L30R,L40R,L40MR,L60R,L60MR     |
| Rated voltage                         | 100 to 240 V AC   |                                |
| Applied voltage range                 | 85 to 264 V AC  |                                |
| Inrush current                        | 35A max.(at 240 V AC and 25°C)                                | 40A max.(at 240 V AC and 25°C) |
| Momentary power off time              | 10 ms (when 100 V AC used)                                    |                                |
| Frequency                             | 50/60 Hz(47 to 63 Hz)   |                                |
| Leakage current                       | 0.75 mA max.between the input and protective ground terminals |                                |
| Service life of built-in power supply | 20000 h (at 55°C)   |                                |
| Fuse                                  | Built-in (replacement disabled)                               |                                |
| Insulation system                     | Transformer isolation   |                                |
| Screw of terminal block               | M3  |                                |

### Universal power supply for input (output) (L30/L40/L60 only)

| Items                                       | Specifications    |
|---|-------------------|
| Rated output voltage                        | 24 V DC           |
| Applied voltage range                       | 21.6 to 26.4 V DC |
| Rated output current                        | 0.3A              |
| Overcurrent protection <small>Note)</small> | Yes               |
| Screw of terminal block                     | M3                |

Note) Output short protection is a temporary overcurrent protection. When the short is detected, all the power supplies of PLC will be turned OFF.  
If the current load out of this specification is connected and in consecutive over-loaded status, failures may occur.

## 4) Input specifications

| Items                             | Specifications   |  |      |  |      |       |
|-----------------------------------|--|--|------|--|------|-------|
|                                   | L14R   | L30R   | L40R | L40MR  | L60R | L60MR |
| Insulation method                 | Optical coupler  |  |      |  |      |       |
| Rated input voltage               | 24 V DC  |  |      |  |      |       |
| Applied voltage range             | 21.6 V DC to 26.4 V DC   |  |      |  |      |       |
| Rated input current               | Approx. 3.5 mA (Control unit: X0 to X3); Approx. 4.3 mA (Control unit: X4 and the following ones)  |  |      |  |      |       |
| Input points per common           | 8 points/COM (L14R), 16 points/COM (L30R),<br>24 points/COM (L40R), 16 points/COM×2 (L60R)<br>(Input power supply +/- are both available.) |  |      |  |      |       |
| Min. ON voltage/Min. ON current   | 19.2 V DC/3 mA   |  |      |  |      |       |
| Max. OFF voltage/Max. OFF current | 2.4 V DC/1.0 mA  |  |      |  |      |       |
| Response time                     | Input impedance  |  |      |  |      |       |
|                                   | Approx. 6.8 kΩ (Control units: X0 to X3); Approx. 5.6 kΩ (control unit X4 and the following ones)  |  |      |  |      |       |
|                                   | OFF→ON   | For X0 to X3, 1 ms max.: common input<br>25 μs max. <small>Note)</small> : When setting high-speed counter, pulse catching input and interrupt input |      | For X0 to X3, 1 ms max.: common input<br>10 μs max. <small>Note)</small> : When setting high-speed counter, pulse catching input and interrupt input |      |       |
| ON→OFF                            | Same as the above.   |  |      |  |      |       |
| Action indicator                  | LED indication   |  |      |  |      |       |
| EN61131-2 application type        | TYPE 3 standard (Depending on the above-mentioned specifications)  |  |      |  |      |       |

Note) The specifications mentioned above are at rated 24 V DC and operating temperature of 25°C.

### Circuit diagram

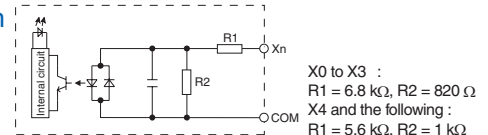

### Transistor (NPN) output specifications

| Items   | Specifications    |   |   |       |      |       |
|---|-------------------|---|---|-------|------|-------|
|   | L14R              | L30R                                    | L40R                                    | L40MR | L60R | L60MR |
| Insulation method                                       | Optical coupler   |   |   |       |      |       |
| Output method   | Open-collector    |   |   |       |      |       |
| Rated load voltage                                      | 5 to 24 V DC      |   |   |       |      |       |
| Allowable range of load voltage                         | 4.75 to 26.4 V DC |   |   |       |      |       |
| Max.load current  | 0.5 A             |   |   |       |      |       |
| Max.impact current                                      | 1.5 A             |   |   |       |      |       |
| Output points per common                                | 2 points/COM      | 4 points/COM                            |   |       |      |       |
| Leakage current at OFF status                           | 1 μA max.         |   |   |       |      |       |
| Max. voltage drop at ON status                          | 0.3 V DC max.     |   |   |       |      |       |
| Response time (at 25°C)                                 | OFF→ON            | 10 μs max.<br>(Load current over 15 mA) | 5 μs max.<br>(Load current over 15 mA)  |       |      |       |
|   | ON→OFF            | 40 μs max.<br>(Load current over 15 mA) | 15 μs max.<br>(Load current over 15 mA) |       |      |       |
| External power supply (Positive and negative terminals) | Voltage           | 21.6 to 26.4 V DC                       |   |       |      |       |
|   | Current           | 15 mA max.                              |   |       |      |       |
| Surge absorber  | Zener diode       |   |   |       |      |       |
| Action indicator  | LED indication    |   |   |       |      |       |

### Circuit diagram

[NPN output]  
[Y0 to Y3]

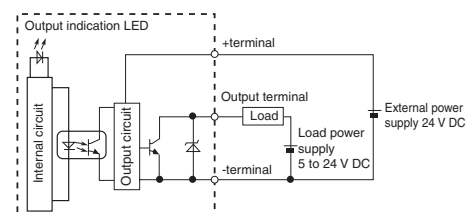

## ■ Dimensions of FP-X0 programmable controller (Unit: mm in)

### ● AFPX0L14R

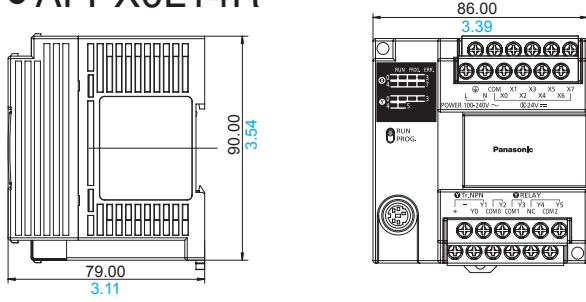

### ● AFPX0L30R

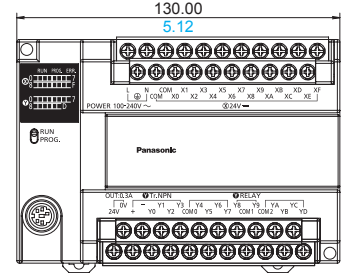
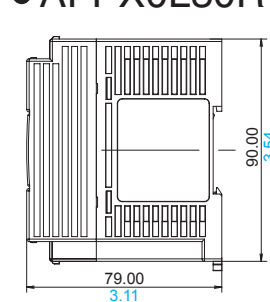

### ● AFPX0L40R AFPX0L40MR

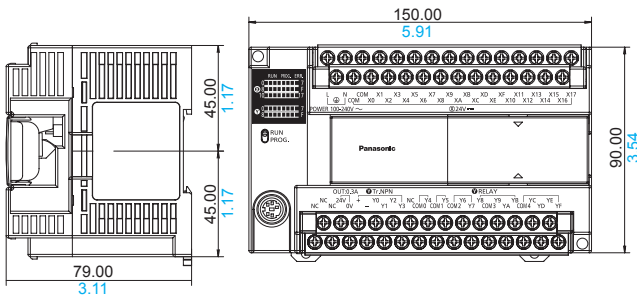

### ● AFPX0L60R AFPX0L60MR

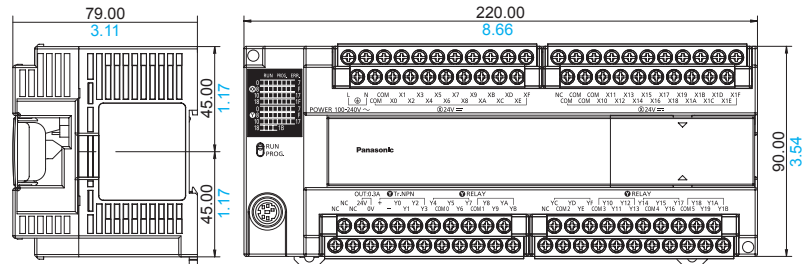

## ● Installation dimensions

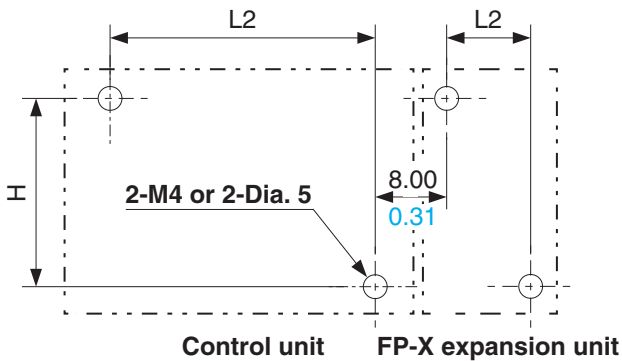

(Unit: mm in)

| Item                | Model        | L2          | H             |
|---------------------|--------------|-------------|---------------|
| FP-X0 control unit  | L14R         | 78.00 3.07  | 82.00<br>3.22 |
|                     | L30R         | 122.00 4.80 |               |
|                     | L40R , L40MR | 142.00 5.59 |               |
|                     | L60R , L60MR | 212.00 8.35 |               |
| FP-X expansion unit | E14 , E16    | 52.00 2.05  |               |
|                     | E30          | 92.00 3.62  |               |

(Tolerance: ± 0.5)

Please contact.....

## Panasonic Electric Works SUNX Suzhou Co.,Ltd.

■No.97.Huoju Road, New District Suzhou, Jiangsu province, China P.R.215009  
 ■Telephone: +86-512-6843-2580 ■Facsimile: +86-512-6843-2590

All Rights Reserved © Panasonic Industrial Devices SUNX Suzhou Co.,Ltd. 2012