



FF-ST2 Series

Type 2 Safety Light Curtains

DESCRIPTION

The FF-ST2 Series is designed for hazardous point-of-operation or access detection industrial machine safeguarding applications. Its enhanced output stage design provides longer cable length through M12 plugs. The Honeywell patented push-pull type OSSD outputs allow for low impedance at any time, while regular open collector type OSSD outputs have high impedance when OFF. As a result, the M12 limited wire section is no longer a constraint.

ASIC technology provides fast response times compared to the micro-processor technology commonly used for safety light curtains. The FF-ST2 light curtain response times are worst-case response times including the sensor and the output stage, and possible OSSD outputs failure modes. Fast response times contribute to shortened safety distances and reduced overall machine size.

The sturdy metal housing (including zamak end caps), and a small window that reduces exposure to the environment, allow the FF-ST2 to operate in most harsh duty applications.

Accessories include mounting kits, connectors, power supply, and relay modules.

FEATURES

- Type 2 per IEC61496-1/2, SIL2 per IEC61508
- Resolutions: 18 mm, 30 mm, 80 mm
- Protection heights: 200 mm to 1400 mm (18 mm resolution) or 200 mm to 1800 mm (30 mm and 80 mm resolutions)
- Scanning range: 0.25 m to 10 m
- Patented, unique solid state safety OSSD outputs allow longer cable length
- M12, 5 pole plugs
- ASIC technology provides fast response times
- Metal housing and reduced window size provide sturdy design
- Optimized overall size with reduced inactive zones
- Different function packages available

⚠ DANGER

IMPROPER SAFETY PRODUCT USE IN THE US

- Type 2 safety light curtains as defined by IEC/EN 61496-1 and IEC/EN 61496-2 do not meet US OSHA 1910.217, US ANSI B11.1, B11.2, B11.19 and B11.20 requirements. Although Type 2 safety products are acceptable for certain applications outside the US, they are not generally acceptable in the US due to current US regulations and standards.
- In the US, Type 2 safety light curtains may be used under limited circumstances as defined by the ANSI/R15.06-1999 standard. In Canada, IEC/EN 61496-1 and IEC/EN 61496-2 are recognised as product standards, however application standards do not typically allow Type 2 light curtain use.
- Do not use Type 2 safety products in the US if the applicable standard requires a control reliable solution.
- For Risk Assessment, refer to ANSI TR3 and ANSI/R15.06-1999 for the USA and refer to the Ministry of Labour for Canada.
- Consult with local safety agencies before installing a Type 2 safety light curtain product.

Failure to comply with these instructions will result in death or serious injury.

POTENTIAL APPLICATIONS

- Automotive plant floor industry
- Food and beverage industry
- Handling industry
- Machine tool industry
- Packaging industry
- Paper industry
- Special machines

FF-ST2 Series

SPECIFICATIONS

Characteristic	Parameter
Resolution (min. object detection size)	18 mm, 30 mm, 80 mm
Nominal scanning range	0.25 m to 10 m
Angle of divergence	max. $\pm 5^\circ$ above 3 m (as per IEC/EN 61496-2)
Emitting light source	infrared, pulsed, 880 nm
Supply voltage	24 Vdc ($\pm 20\%$) for the emitter and the receiver
Power consumption	5 W max. for the emitter, 5 W max. for the receiver
Output type	2 safety solid state outputs, push-pull/PNP type with Normally Open characteristics
Response time	see mounting dimension drawing
Switching capability	350 mA max. at 24 Vdc
Restart time after power up	>1 s (automatic mode)
Restart time after beam release	80 ms (without EDM), 150 ms (with EDM)
Leakage current	0.25 mA
Load impedance	70 Ohm min., 5 kOhm max.
Voltage drop	<2.3 Vdc
Load turn-on voltage	5 V min. on resistive loads, 7 V min. on inductive loads
Test pulse width/recurrence	2 pulses (width 200 us and 75 us), separated by 300 us, frequency from 3.3 ms to 8 ms (depending on height)
Protections	short-circuits and cross-faults, overloads (0.4 A max./0 Vdc; 0.9 A max./24 Vdc), reversed polarity, micro-cut-off 10 ms (100% voltage breakdown, 10 Hz)
Max. cable length	100 m [328.08 ft] (capacitance: 10 nF)
External contact type	relay contact, or static (solid state) PNP or static (solid state) NPN (automatic recognition - no push-pull output allowed)
Filtering time	20 ms by default, 150 ms on the EDM input
Voltage switching thresholds (high/low)	14.5 Vdc min., 4.5 Vdc (complies with IEC 61131-2, for type 2 sensors)
Input current (high/low)	20 mA; 10 mA at 24 Vdc
Max. voltage	29 Vdc
Housing material	aluminum alloy
End cap material	zamak
Window material	PMMA (Polymethylmethacrylate)

FUNCTION PACKAGES

Models	External Device Monitoring (EDM)	Automatic Restart (AUTO)	Restart Interlock (RES)
FF-ST2 Standard A	X	X	-
FF-ST2 Standard M	X	-	X

Type 2 Safety Light Curtains

MOUNTING DIMENSIONS (For reference only: mm)

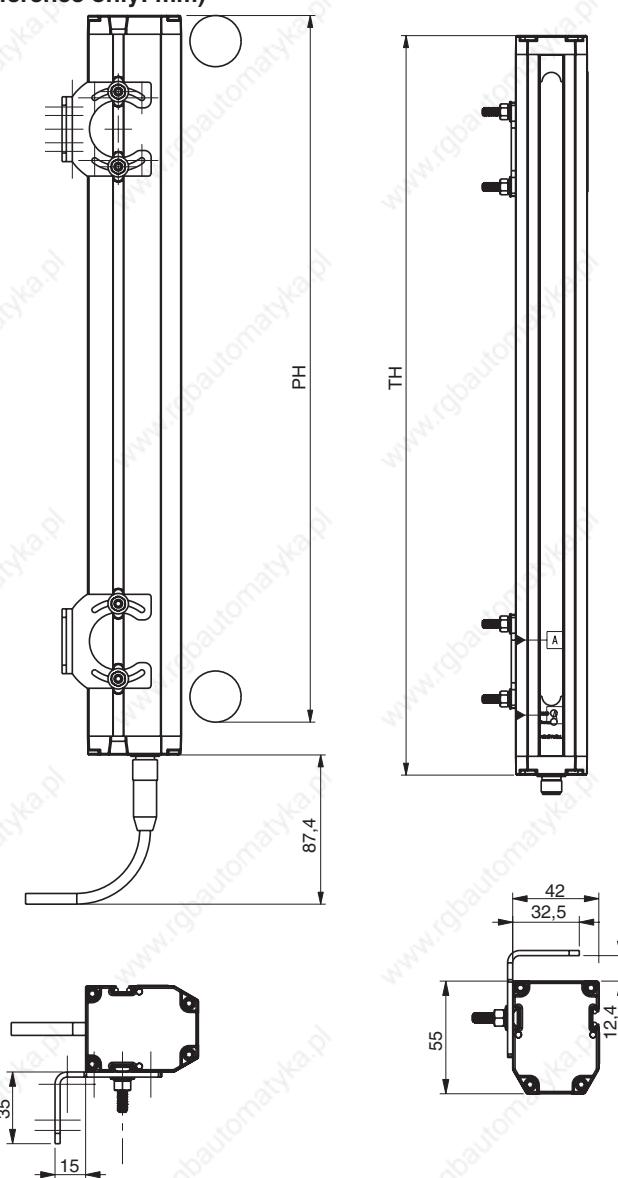

FF-ST2X_XM2	02	03	04	05	06	07	08	09	10	12	14	16	18
Protection Height PH (mm)													
18 mm resolution	210	306	402	498	594	690	786	882	978	1170	1362	NA	NA
30 mm, 80 mm resolution	222	318	414	510	606	702	798	894	990	1182	1374	1566	1758
Total Height TH (mm)	242	338	434	530	626	722	818	914	1010	1202	1394	1586	1778
Response Time (ms)													
18 mm resolution	11	12	12.5	13	14	14.5	15.5	16	16.5	18	19.5	NA	NA
30 mm resolution	11	12	12.5	13	14	14.5	15.5	16	16.5	18	19.5	21	22
80 mm resolution	13.5	14.5	15.5	16	17	18	19	20	21	23	24.5	26.5	28.5

NA: not available

FF-ST2 Series

ORDERING INFORMATION

Function package Automatic restart with external device monitoring
 Connection types M12, 5 pole on emitter and receiver

FF-ST2 Standard A

These on/off sensors are designed to be directly interfaced to the machine final switching devices (e.g. contactors), negating the need for a dedicated interface module.

RECEIVER WIRING DIAGRAM

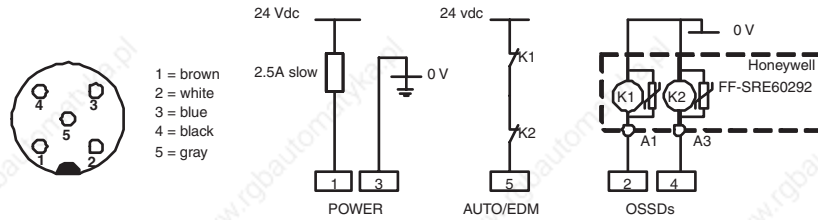

FINGER DETECTION

Resolution 18 mm, Scanning Range 0.25 m to 10 m	
Protective Height (mm)	Catalog Listing
200	FF-ST2B02CM2
300	FF-ST2B03CM2
400	FF-ST2B04CM2
500	FF-ST2B05CM2
600	FF-ST2B06CM2
700	FF-ST2B07CM2
800	FF-ST2B08CM2
1000	FF-ST2B10CM2
1200	FF-ST2B12CM2
1400	FF-ST2B14CM2

HAND, LIMB OR BODY DETECTION

Resolution 30 mm, Scanning Range 0.25 m to 10 m		Resolution 80 mm, Scanning Range 0.25 m to 10 m	
Protective Height (mm)	Catalog Listing	Protective Height (mm)	Catalog Listing
200	FF-ST2C02CM2	200	FF-ST2C02LM2
300	FF-ST2C03CM2	300	FF-ST2C03LM2
400	FF-ST2C04CM2	400	FF-ST2C04LM2
500	FF-ST2C05CM2	500	FF-ST2C05LM2
600	FF-ST2C06CM2	600	FF-ST2C06LM2
700	FF-ST2C07CM2	700	FF-ST2C07LM2
800	FF-ST2C08CM2	800	FF-ST2C08LM2
900	FF-ST2C09CM2	900	FF-ST2C09LM2
1000	FF-ST2C10CM2	1000	FF-ST2C10LM2
1200	FF-ST2C12CM2	1200	FF-ST2C12LM2
1400	FF-ST2C14CM2	1400	FF-ST2C14LM2
1600	FF-ST2C16CM2	1600	FF-ST2C16LM2
1800	FF-ST2C18CM2	1800	FF-ST2C18LM2

Type 2 Safety Light Curtains

ORDERING INFORMATION

Function package Manual restart interlock with external device monitoring
 Connection types M12, 5 pole on emitter and receiver

FF-ST2 Standard M

These on/off sensors are designed to be directly interfaced to the machine final switching devices (e.g. contactors), eliminating the need for a dedicated interface module.

RECEIVER WIRING DIAGRAM

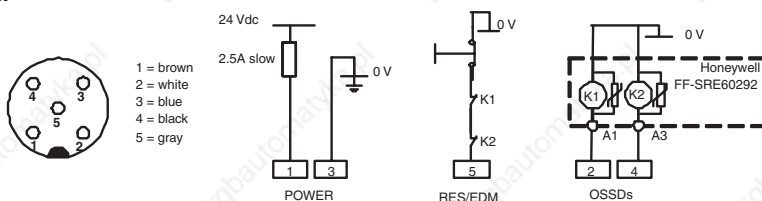

FINGER DETECTION



Resolution 18 mm, Scanning Range 0.25 m to 10 m	
Protective Height (mm)	Catalog Listing
200	FF-ST2B02BM2
300	FF-ST2B03BM2
400	FF-ST2B04BM2
500	FF-ST2B05BM2
600	FF-ST2B06BM2
700	FF-ST2B07BM2
800	FF-ST2B08BM2
1000	FF-ST2B10BM2
1200	FF-ST2B12BM2
1400	FF-ST2B14BM2

HAND, LIMB OR BODY DETECTION

Resolution 30 mm, Scanning Range 0.25 m to 10 m		Resolution 80 mm, Scanning Range 0.25 m to 10 m	
Protective Height (mm)	Catalog Listing	Protective Height (mm)	Catalog Listing
200	FF-ST2C02BM2	200	FF-ST2C02KM2
300	FF-ST2C03BM2	300	FF-ST2C03KM2
400	FF-ST2C04BM2	400	FF-ST2C04KM2
500	FF-ST2C05BM2	500	FF-ST2C05KM2
600	FF-ST2C06BM2	600	FF-ST2C06KM2
700	FF-ST2C07BM2	700	FF-ST2C07KM2
800	FF-ST2C08BM2	800	FF-ST2C08KM2
900	FF-ST2C09BM2	900	FF-ST2C09KM2
1000	FF-ST2C10BM2	1000	FF-ST2C10KM2
1200	FF-ST2C12BM2	1200	FF-ST2C12KM2
1400	FF-ST2C14BM2	1400	FF-ST2C14KM2
1600	FF-ST2C16BM2	1600	FF-ST2C16KM2
1800	FF-ST2C18BM2	1800	FF-ST2C18KM2

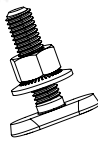
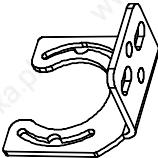
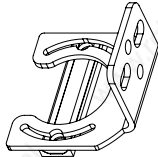
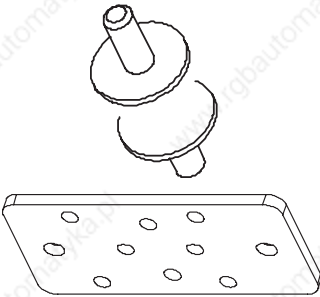

FF-ST2 Series

ACCESSORIES

Catalog Listing	Picture	Description
FF-SGZ001001		Basic mounting kit includes two M5 dovetail shape bolts, two M5 nuts and two rip-lock washers. (These are already included in the FF-ST package.) Order two kits for a complete set to use with emitter and receiver.
FF-SYZ634178		Right angle bracket kit includes two right angle brackets with four sets of M5 bolts, nuts and washers. Order two kits for a complete set to use with emitter and receiver.
FF-SYZ634189		Adjustable bracket kit includes two right angle brackets with four sets of M5 bolts, nuts and washers. Allows adjustments in azimuth directions of $\pm 4^\circ$ with front access of the adjusting screws. Order two kits for a complete set to use with emitter and receiver)
FF-SYZAD		Kit includes two straight brackets and four anti-vibration dampers (mounting hardware included). In case of high vibration applications, order: <ul style="list-style-type: none"> • Two FF-SYZAD kits for light curtain systems with protection heights below 1000 mm. • Three FF-SYZAD kitS for light curtain systems with protection heights greater or equal to 1000 mm, but less than 1800 mm. • Four FF-SYZAD kits for light curtain systems with protection heights equal to 1800 mm.
FF-SXZCAM125U02-S FF-SXZCAM125U05-S FF-SXZCAM125U05-90S FF-SXZCAM125U10-S FF-SXZCAM125U10-90S		M12 single-ended cordsets, female, 5 pin 2 m, straight 5 m, straight 5 m, right angle 10 m, straight 10 m, right angle

Type 2 Safety Light Curtains

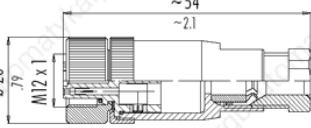
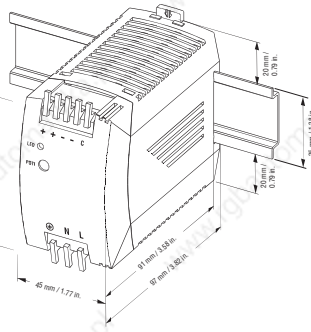
ACCESSORIES (continued)

Catalog Listing	Picture	Description
FF-SXZCOM125		M12 screw connector, female, straight, 5 pin
FF-SXZPWR050		<p>ac to dc power supply (to be ordered separately as an option)</p> <ul style="list-style-type: none"> • UL508 listed, UL1950, cUL/CSA-C22.2 No. 950-M90, EN/IEC 60950, EN 50178 (Class 2 rated for low power Installations) • Input voltage: 85 Vac to 264 Vac (43 Hz to 67 Hz) • Output voltage: 24 Vdc to 28 Vdc adjustable • Rated continuous load (at 60 °C [140 °F] max.): 2.1 A at 24 Vdc/ 1.8 A at 28 Vdc • Power: 50 W • Dimensions: 75 mm x 45 mm x 97 mm • DIN rail mounting • Weight: 240 g
FF-SRE60292 FF-SRE30812		<p>Expansion relay modules for the FF-ST2 Standard A and Standard M models</p> <ul style="list-style-type: none"> • 22.5 mm width, 4 NO/2 NC safety relay outputs • 90 mm width, 7 NO/1 NC safety relay outputs <p>(See separate product data sheet for detailed information.)</p>
FF-SRM200P2		<p>Muting module</p> <ul style="list-style-type: none"> • Connection of one or two safety devices • Modes of operation: unidirectional or bidirectional muting, mutual exclusion • Connection of two or four auxiliary muting sensors • 24 Vdc • Category 4 per EN 954-1 • Programmable max. muting time • Crossfault monitoring of inputs • Self-monitored muting lamp output • 3 NO safety relay outputs • Static outputs for output status and diagnostic information • 45 mm [1.77 in]



WARNING **MISUSE OF DOCUMENTATION**

- The information presented in this product sheet is for reference only. Do not use this document as a product installation guide.
- Complete installation, operation, and maintenance information is provided in the instructions supplied with each product.

Failure to comply with these instructions could result in death or serious injury.

Warranty/Remedy

Honeywell warrants goods of its manufacture as being free of defective materials and faulty workmanship. Honeywell's standard product warranty applies unless agreed to otherwise by Honeywell in writing; please refer to your order acknowledgement or consult your local sales office for specific warranty details.

Honeywell warrants goods of its manufacture as being free of defective materials and faulty workmanship. If warranted goods are returned to Honeywell during the period of coverage, Honeywell will repair or replace, at its option, without charge those items it finds defective. **The foregoing is buyer's sole remedy and is in lieu of all warranties, expressed or implied, including those of merchantability and fitness for a particular purpose. In no event shall Honeywell be liable for consequential, special, or indirect damages.**

While we provide application assistance personally, through our literature and the Honeywell web site, it is up to the customer to determine the suitability of the product in the application.

Specifications may change without notice. The information we supply is believed to be accurate and reliable as of this printing. However, we assume no responsibility for its use.

Automation and Control Solutions

Sensing and Control

Honeywell

1985 Douglas Drive North

Minneapolis, Minnesota 55422

www.honeywell.com

Sales and Service

Honeywell serves its customers through a worldwide network of sales offices, representatives and distributors. For application assistance, current specifications, pricing or name of the nearest Authorized Distributor, contact your local sales office or:

E-mail: info.sc@honeywell.com

Internet: www.honeywell.com/sensing

Phone and Fax:

Asia Pacific	+65 6355-2828
	+65 6445-3033 Fax
Europe	+44 (0) 1698 481481
	+44 (0) 1698 481676 Fax
Latin America	+1-305-805-8188
	+1-305-883-8257 Fax
USA/Canada	+1-800-537-6945
	+1-815-235-6847
	+1-815-235-6545 Fax

Honeywell

107169-10-EN FR26 GLO
July 2007

Copyright 2007 Honeywell International Inc. All rights reserved.