

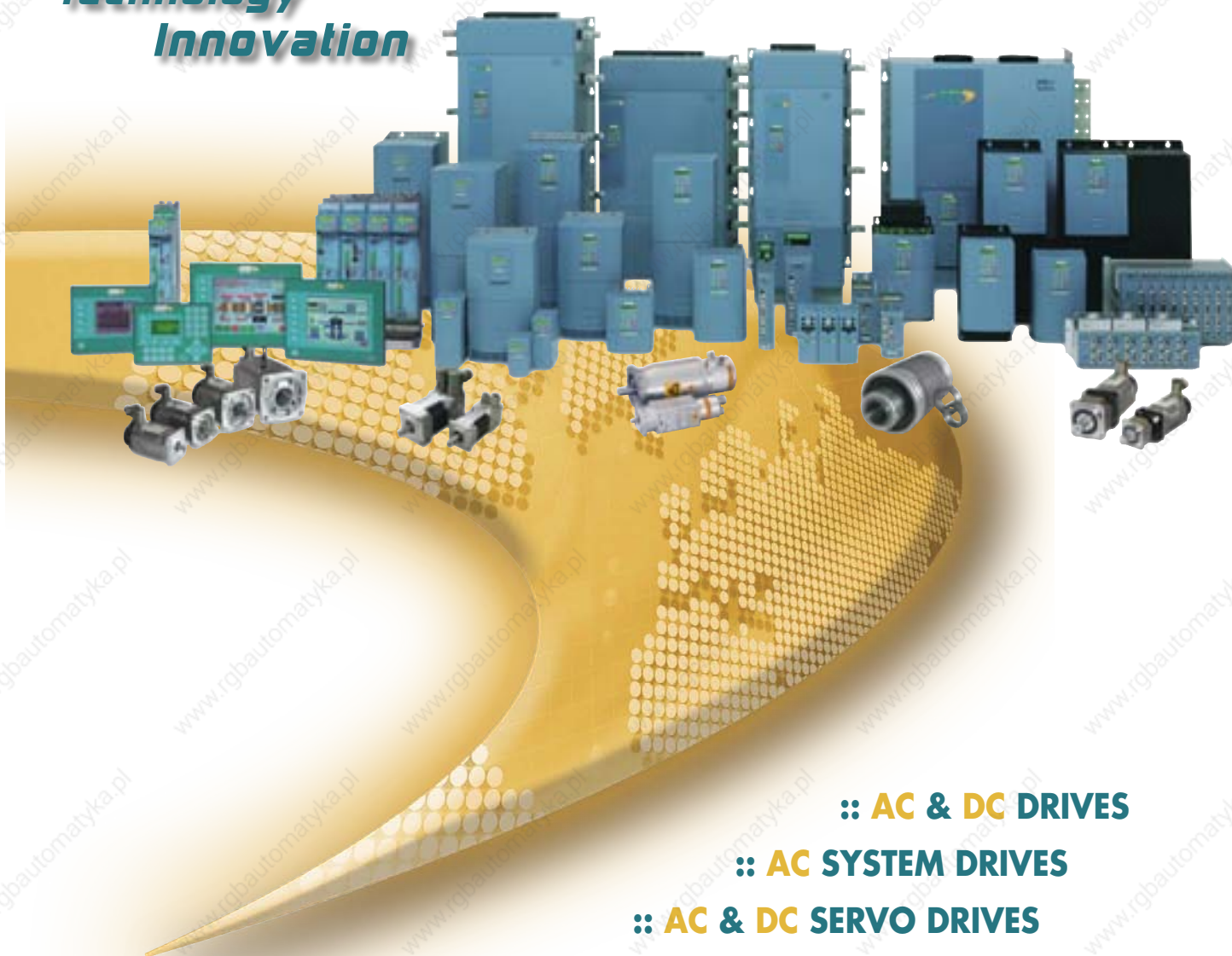

# Products Catalog

**Vision**  
**Technology**  
**Innovation**



**:: AC & DC DRIVES**

**:: AC SYSTEM DRIVES**

**:: AC & DC SERVO DRIVES**

**:: AC & DC SERVO MOTORS**

**:: HMI TOUCHSCREENS**



In August of 2005, SSD Drives joined Parker Hannifin Automation Group and became known as Parker SSD Drives. Parker Hannifin is the world's leading diversified manufacturer of motion and control technologies and systems, providing precision-engineered solutions for a wide variety of commercial, mobile, industrial and aerospace markets. The company employs more than 50,000 people in 46 countries around the world.

Parker SSD Drives has four main manufacturing facilities, including one each in the United Kingdom, France, Germany and the United States, and a sales presence in more than 40 countries. The company employs about 1,000 people worldwide and manufactures AC and DC drives, as well as servo drives, motors, and systems for leading original equipment manufacturers, end users, and integrators for automated industrial process applications. Parker SSD Drives serves global target markets such as plastics, converting, packaging, extrusion, printing, pulp and paper, primary metals and general industrial automation.

Parker SSD Drives offers complementary technology, products, and customers, adding its leadership in industrial automation and drives technology to Parker's existing strong presence in the precision electromechanical market.

The combination of vision, talents and skills from Parker and Parker SSD Drives ensures that together we will have all the capabilities needed to compete successfully in serving a broad range of industrial customers around the world. This combination creates an exciting new force in global automation.

For more information on Parker and Parker SSD Drives, visit our web sites at [www.parker.com](http://www.parker.com) and [www.ssddrives.com](http://www.ssddrives.com).

**NEW**

**5-MODE DRIVE**

- :: V/F Inverter ::
- :: Sensorless Inverter ::
- :: Vector Inverter ::
- :: AC Brushless Servo ::
- :: Active Front End ::



**Page 6**

**TOUCHSCREENS**

- :: Multilingual Interface ::
- :: Integrated Web Server ::
- :: CompactFlash Drive ::
- :: 3 to 10.4 in. ::



**NEW**

**TS8000**

**Page 17**

 **PRODUCT SELECTOR**

 **AC SYSTEM DRIVES**

 **HMI**

 **AC DRIVES**

 **DC DRIVES**

 **LINK**

 **SOFTWARE**

 **TRAINING**



# Product Selector

## AC SYSTEM DRIVES

Drives	0	20A	200A	2000A
Frequency converter for asynchronous and brushless motors, Common Bus version	890CS/CD Series - 1.5 to 180A			P. 10
Frequency converter for asynchronous and brushless motors, Stand Alone version	890SD Series - 1.5 to 1681A			P. 12

## AC DRIVES

Drives	0	7.5HP	150HP	1500HP
V/F single/three phase inverter with integrated braking and Fieldbus options	650 Series - 0.25 to 10HP			P. 21
Single/three phase sensorless inverter with integrated braking and Fieldbus options	650V Series - 0.25 to 150HP			P. 21
Single/three phase V/F, sensorless and vector inverter with Fieldbus options	690+ Series - 0.75 to 1600HP			P. 26

## DC DRIVES

Drives	0	5A	100A	3000A
Single phase non-isolated analog converter	506/507/508 Series - 3 to 12A			P. 35
Single phase 2Q isolated analog converter	512C Series - 4 to 32A			P. 36
Single phase 4Q isolated analog converter	514C Series - 4 to 32A			P. 37
Three phase 2Q/4Q digital converter with Fieldbus options	590+ Series - 15 to 2700A			P. 38

# Contents

## AC SYSTEM DRIVES

**6** 890 Series  
Overview

**10** 890 CS/CD Series  
Common Bus version

**12** 890 SD Series  
Stand Alone version

## HMI TOUCHSCREEN

**17** TS8000 Series  
Touchscreen Operator panel

## AC DRIVES

**21** 650 Series  
Single/three phase V/F inverter  
with integrated braking and Fieldbus  
option

**21** 650V Series  
Single/three phase sensorless  
inverter with integrated braking and  
Fieldbus option

**26** 690+ Series  
Single/three phase line regenera-  
tive vector inverter (4 modes) with  
Fieldbus option

**32** EMC Filters  
Full range of inverter-dedicated filters

**33** Reactors  
Full range of inverter-dedicated  
reactors

## DC DRIVES

**35** 506/507/508 Series - 3 to 12A  
Single phase analog non-  
isolated converter

**36** 512C Series - 4 to 32A  
Single/three phase 2Q  
isolated analog converter

**37** 514C Series - 4 to 32A  
Single/three phase 4Q  
isolated analog converter

**38** 590+ Series - 15 to 2700A  
Three phase 2Q/4Q digital  
converter with Fieldbus option

**39** 590+ Series - 15 to 2700A  
DRV version

**43** EMC Filters  
Full range of converter-  
dedicated filters

**44** Reactors  
Full range of converter-  
dedicated reactors

**LINK**

- 48** LINK System  
Fiber optic based control system
- 

**SOFTWARE**

- 50** DSE - Drive System Explorer  
On-line programming and diagnostic software for 890 Series Converters
- 

- 51** DS18000  
On-line programming and diagnostic Software for TS8000 Series touch screen
- 

- 52** ConfigEd Lite  
Off-line programming software for inverters and converters
- 

- 53** ConfigEd Lite+  
On-line programming diagnostic software for inverters and converters
- 

- 54** Drive System Designer (DSD)  
Configuration software for LINK systems
- 

**TRAINING**

- 55** Training Courses  
Training and refresher courses
-



# Parker SSD Drives Worldwide

Parker SSD Drives is a manufacturer of AC, DC, Servo drives and motors. We are renowned for our reliable, innovative, state-of-the-art products, application experience and global support.

- Austria
- Belgium
- Cyprus
- Czech Republic
- Denmark
- France
- Germany
- Greece
- Holland
- Hungary
- Iceland
- Ireland
- Italy
- Lithuania
- Moldova
- Poland
- Portugal
- Romania
- Slovenia
- Spain
- Sweden

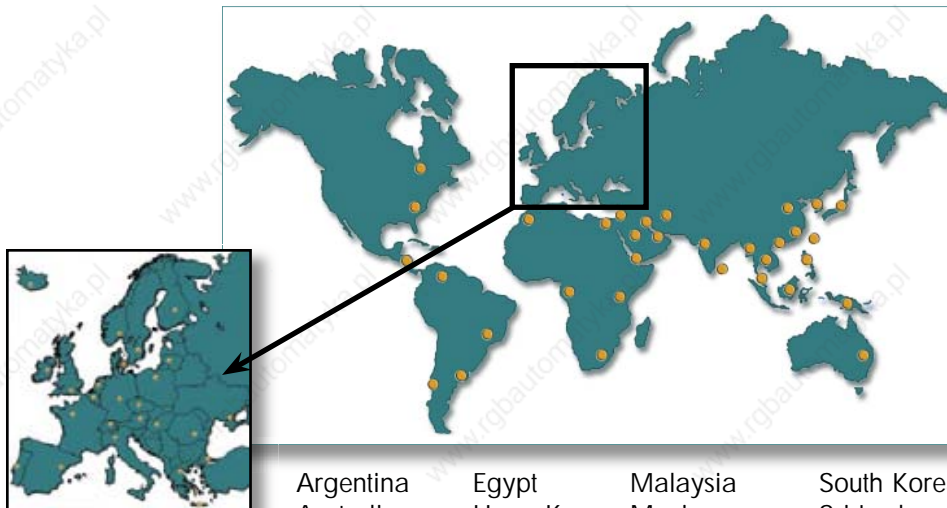

- |            |           |              |             |
|------------|-----------|--------------|-------------|
| Argentina  | Egypt     | Malaysia     | South Korea |
| Australia  | Hong Kong | Mexico       | Sri Lanka   |
| Bangladesh | India     | Morocco      | Taiwan      |
| Brazil     | Indonesia | New Zealand  | Thailand    |
| Canada     | Iran      | Nigeria      | UAE         |
| Chile      | Israel    | Peru         | USA         |
| China      | Japan     | Philippines  | Vietnam     |
| Colombia   | Jordan    | Saudi Arabia |             |
| Costa Rica | Kenya     | Singapore    |             |
| Ecuador    | Kuwait    | South Africa |             |

## PRODUCTION SITES

### USA - Charlotte, NC



**Production:** AC Drives, DC Drives, LINK Products, Drive Systems

### UK - Littlehampton



**Production:** AC Drives, DC Drives, AC Servo Drives, Drive Systems

### Germany - Bad Schönborn



**Production:** AC Servo Drives, AC Servo Motors

### France - Dijon



**Production:** AC Servo Drives & Motors, DC Servo Drives & Motors

# AC890

from 1.5 to 1681A

## DESCRIPTION

AC890 System Drives are modular AC drive units that can be combined to form a complete multi-section drive system, saving space, reducing wiring, and providing unmatched system performance.

The AC890 can control everything from induction motors to servo motors. AC890 provides V/F, sensorless vector, closed-loop flux vector and servo position control; from simple AC motor control sections to more demanding sections. The AC890 comes in a wide variety of sizes and ratings and input and output types, making it the right solution for virtually any motion control project.



### 5-MODE FREQUENCY CONVERTER:

V/F, SENSORLESS VECTOR, FLUX VECTOR, SERVO DRIVE, LINE REGENERATIVE (AFE)

BUILT-IN EMC FILTERS

2 PERFORMANCE LEVELS (ADVANCED AND HIGH PERFORMANCE)

EN954-1 CAT. 3 CERTIFIED OPTIONAL SAFE STOP

COMMS OPTIONS AVAILABLE



**COMMON BUS Drives (CD)** are individual motor output sections that easily connect to a **COMMON BUS Supply (CS)** with a unique, easy-to-install DC bus bar system (SSD Rail).

### COMMON BUS MADE EASY

DC bus terminals are located at the top of each drive section. Easy to use screw clamps secure the high power bus bars. This low cost, compact design significantly reduces wiring in common bus systems, saving time and material cost.

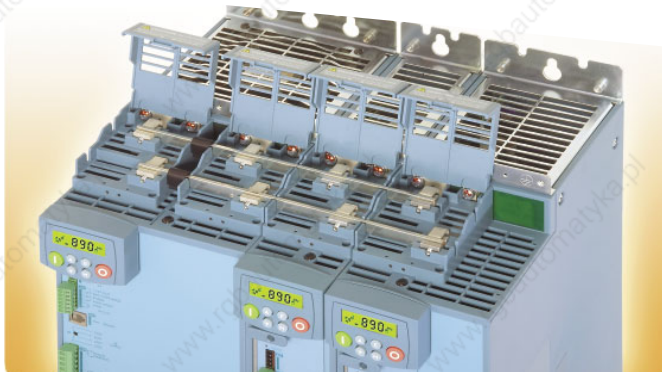

### COMMON BUS Drives (CD)

- Have internal DC fuses
- Need no reactors
- Provide access to all feedback and networking options

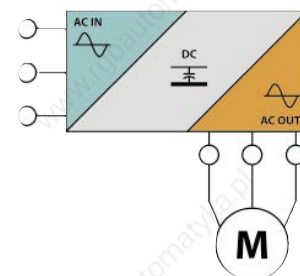
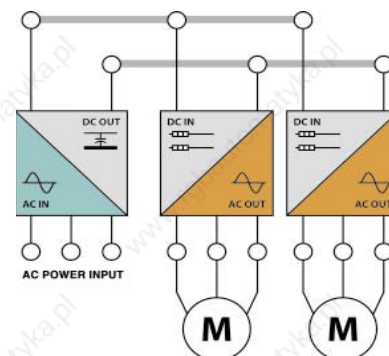

### STANDALONE Drives (SD)

The AC890 Standalone Drives are complete AC-input-to-AC motor output controller with power input and output terminals, and access to all feedback and networking options.





**Induction motors**  
Velocity and Torque Control

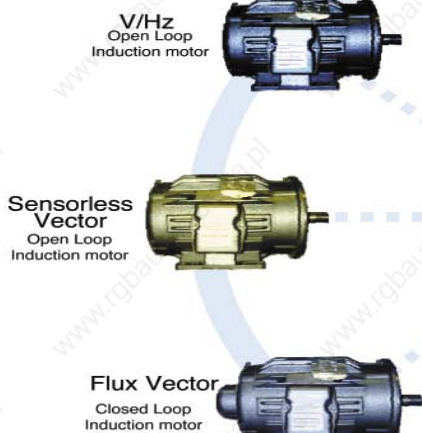

CONSTANT TORQUE RATED  
150% OL 60 sec.

**Servo motors**  
Motion and Position Control



SERVO RATED  
200% OL 4 sec.

**SPECIFICATIONS**

**Power Supply**

890CS: 208–500Vac ±10%  
890CD: 320/560–705Vdc  
890SD: 380–500Vac ±10% (Frames E thru K: 380–460Vac ±10%)  
0–45°C (Derate 2%/°C to 50°C max - Frame sizes G thru K: 0–40°C)

**Operating Temperature**

**Maximum Humidity**

**Altitude**

**Degree of Protection**

85% non-condensing  
1000m ASL (Derate 1%/100m 1000–4000m max)  
IP20: Frame sizes B,C,D, E, F  
IP00: Frame sizes G, H, J  
IP52: Frame size K

**Inputs/Outputs**

Analog Inputs:

4 total, 2 configurable  
(0-10V, ±10V, 0-20mA, 4-20mA)  
+2 configurable (0-10V, ±10V)  
Analog Outputs:  
2 configurable (0-10V, ±10V)  
Digital Inputs:  
7 configurable (24V)  
Digital I/O:  
2 configurable (24V)  
Relay Digital Output:  
1 configurable (24V)\*  
\*3 additional 230V rated dry contacts (frames E-K)

Analog Outputs:

Digital Inputs:

Digital I/O:

Relay Digital Output:

**890CD/890SD CONTROL BOARD**

- :: Programming Port USB
- :: Torque and Speed Analog Outputs
- :: Health Contact
- :: 24Vdc Control Supply - Programming without Power Supply
- :: Digital I/O
- :: Motor Thermistor Input
- :: Running and Zero Speed Signal Outputs

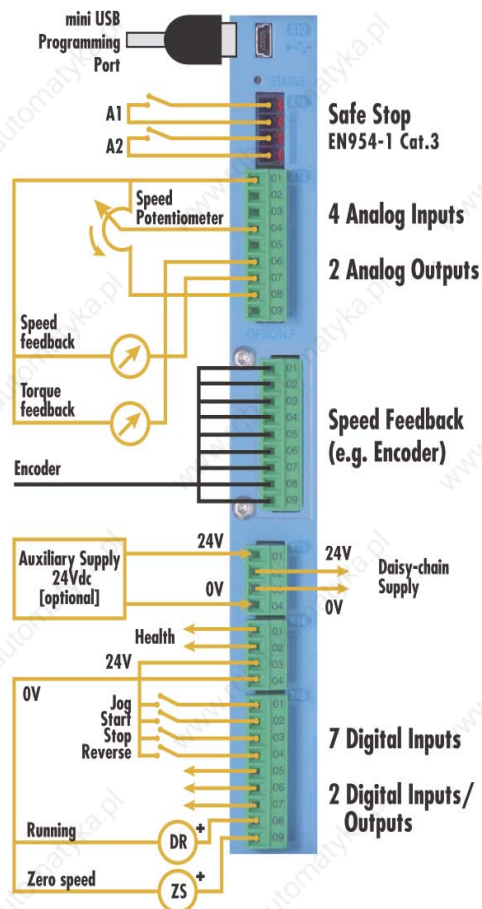

# AC890

## PERFORMANCE LEVELS

AC890 frequency converters offer the level of performance that best suits your application needs. With 2 different performance levels, AC890 system allows the maximum flexibility of use.

### STANDARD PERFORMANCE

Basic LINK VM function blocks: math functions, Boolean logic, timers, counters, One shots, threshold comparators, latches, plus: motion control firmware with added position loop, motion control function blocks, move incremental, move absolute, move home, line drive master ramp and section control, winder blocks (SPVV, CPW), full function PID, state machine, and others.

### HIGH PERFORMANCE

All Advanced Performance features, plus: Library of pre-engineered application specific LINK VM function blocks such as: shaftless printing, cut-to-length, precision winding, traversing, and others.

## SHAFTLESS REGISTRATION CONTROL SOLUTIONS FOR PRINTING

Mechanical line shafts for printing are easily replaced with individual AC890 drives, capable of precise synchronization and printing registration adjustment to each section, guaranteeing perfect alignment of each color. AC890 HIGH PERFORMANCE LEVEL features a library of pre-engineered application specific LINK VM function blocks, including shaftless printing, cut-to-length, precision winding, traversing, and others.

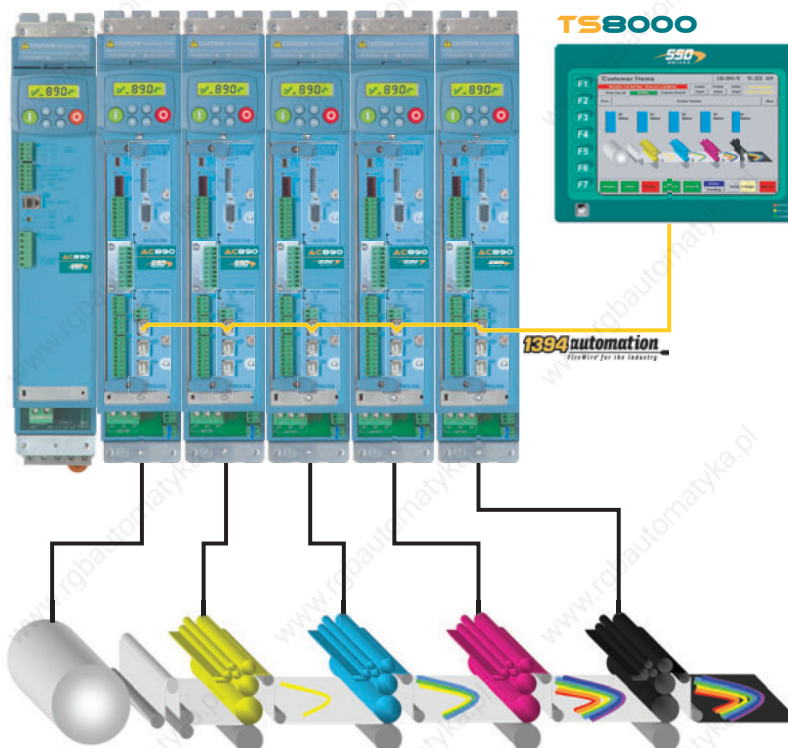

FireWire protocol (IEEE1394) ensures data synchronization for the printing register control.



- 125µS Cycle time
- Time Synchronization
- Deterministic Network

### ACTIVE FRONT END: LINE REGENERATIVE SYSTEMS

Common Bus Drive sections can also be configured as ACTIVE-FRONT-END INPUT SECTIONS, providing true line-regenerative 4-quadrant control with no harmonics and 1.0 power factor.

#### REQUIREMENTS

- ⋮ Pre-charging Circuit
- ⋮ LCL Filter

#### PERFORMANCE

- ⋮ Fully Bidirectional Power Flow
- ⋮ Overload 150% for 60 secs
- ⋮ Sinusoidal Input Current
- ⋮ Complies with IEEE 519

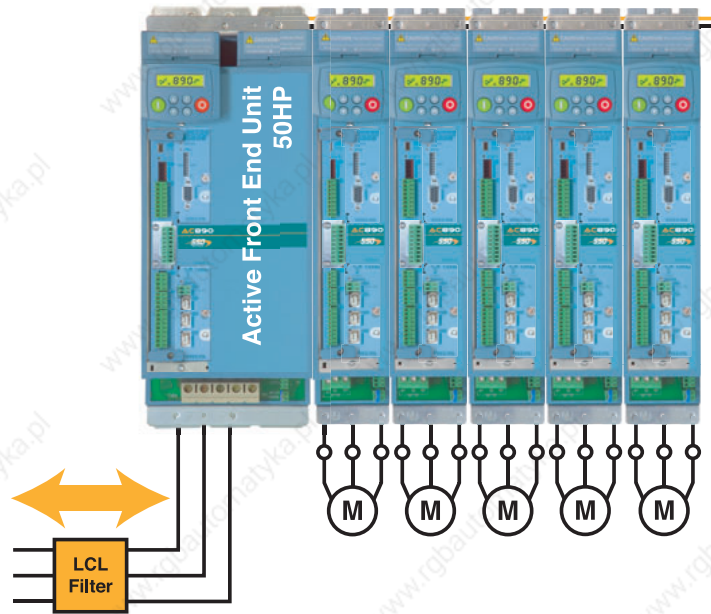

Larger AC890 systems can be matched with separate higher power Active Front End units. Multiple rows of AC890 Common Bus Drives are bridged together using Common Bus Adapter modules.

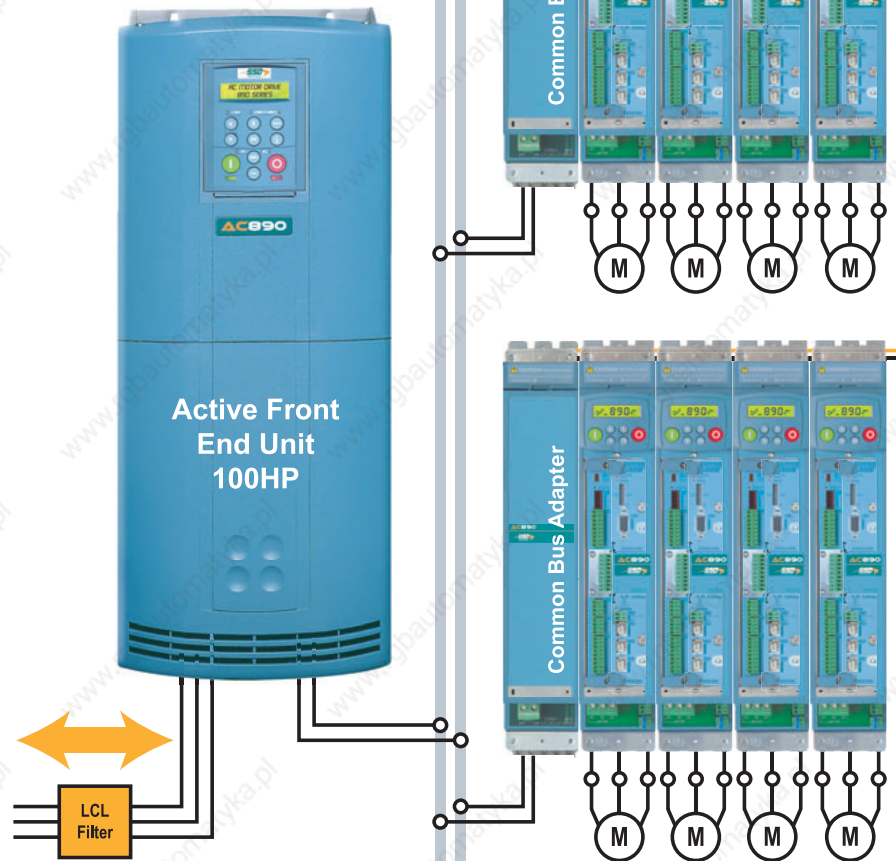
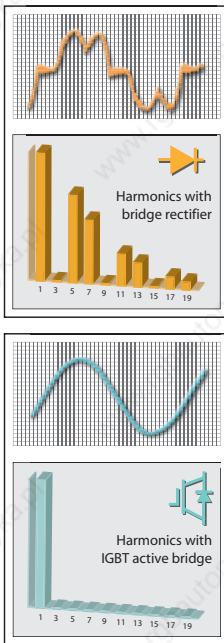



# AC890

## 890 Series CS/CD

890 Series CS/CD units provide a common bus solution for multi-section drive applications. Multiple 890 Series CD Common Bus Drive inverter sections can be combined with a single 890 Series CS Common Bus supply unit, achieving substantial space savings and peripheral component savings within the enclosure. Additional 890 Series CS supply units may be paralleled to provide greater DC bus supply amperage.



### HOW TO PICK A CS

- Select the 890CD (common-bus drives), one for each section.
- Select the 890CS (common-bus supply) module by adding the HP (or currents) of all the CD drives.
- Select a reactor and braking resistor kit.
- Order the common bus bar and exhaust duct kit from the options section.

## 890CS Power Supply Unit

up to 162A

- POWER SUPPLY 208-500VAC
- BUILT-IN DYNAMIC BRAKING UNIT
- DC BUS SUPPLY OUTPUT
- DIAGNOSTIC OPERATOR PANEL

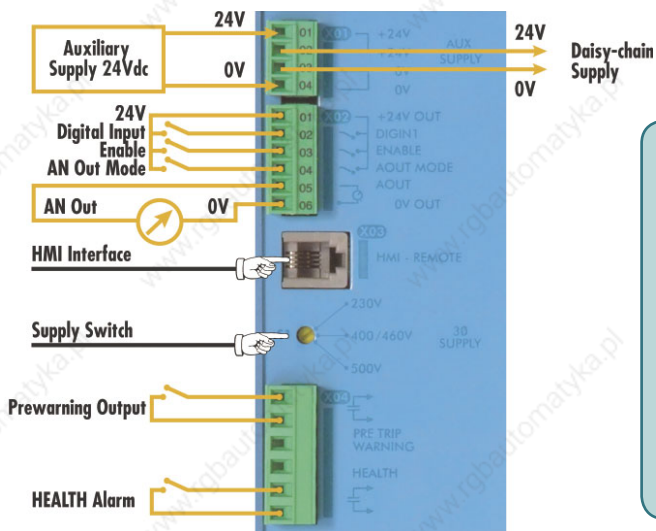

**890CS CONTROL BOARD**

- :: 24Vdc Supply Control
- :: HMI Interface Connection
- :: Three-phase Supply Selector
- :: Configurable Analog Output
- :: Prewarning Output
- :: Alarm Output

Part Number	Frame	HP@460Vac	HP@230Vac	Input Amps
<b>AC890 Common Bus Supplies used with 230 - 500Vac (+/-10%) 3 phase</b>				
890CS/5/0032B/B/00/N/EN	B	25	10	32
890CS/5/0054B/B/00/N/EN		45	20	54
890CS/5/0108D/B/00/N/EN	D	75	40	108
890CS/5/0162D/B/00/N/EN		135	60	162



# 890CD Inverters

## from 1.5 to 180A

**320, 650, 705VDC POWER SUPPLY**  
**STANDARD EQUIPPED KEYPAD**  
**COMMON OPTIONS WITH 890SD**  
**COMMS OPTIONS AVAILABLE**

Part Number	Frame	HP@ 230Vac	Output Amps@ 230Vac
-------------	-------	------------	---------------------

**AC890 Common Bus Drives 208 - 230Vac (+/-10%)**

890CD/2/0003B/N/00/A/US	B	0.75	3
890CD/2/0005B/N/00/A/US		1.5	5.5
890CD/2/0007B/N/00/A/US		2	7
890CD/2/0011B/N/00/A/US		3	11
890CD/2/0016B/N/00/A/US		5	16.5
890CD/2/0024C/N/00/A/US	C	7.5	24
890CD/2/0030C/N/00/A/US		10	30

Part Number	Frame	HP@ 460Vac	Output Amps@ 460Vac
-------------	-------	------------	---------------------

**AC890 Common Bus Drives 380 - 500Vac (+/-10%)**

890CD/5/0002B/N/00/A/US	B	1	2
890CD/5/0003B/N/00/A/US		1.5	3.5
890CD/5/0004B/N/00/A/US		2	4.5
890CD/5/0006B/N/00/A/US		3	5
890CD/5/0010B/N/00/A/US		5	8
890CD/5/0012B/N/00/A/US		7.5	12
890CD/5/0016B/N/00/A/US		10	14
890CD/5/0024C/N/00/A/US	C	15	24
890CD/5/0030C/N/00/A/US		20	27
890CD/5/0039D/N/00/A/US	D	25	35
890CD/5/0045D/N/00/A/US		30	40
890CD/5/0059D/N/00/A/US		40	52
890CD/4/0073E/N/00/A/US	E	50	73
890CD/4/0087E/N/00/A/US		60	87
890CD/4/0105F/N/1F/A/US	F	75	100
890CD/4/0145F/N/1F/A/US		100	130
890CD/4/0156F/N/1F/A/US		125	156
890CD/4/0180F/N/1F/A/US		150	180

Note: The 890 comes in two performance level configurations, Advanced and High. The part #'s shown above 890CD/x/xxxxx/x/xx/A/xx are for Advanced models. For High Performance models, replace the Performance Level field designator with an H.

**VAC SYSTEM DRIVES**

# AC890

## 890SD Series from 1.5 to 1681A

890SD Series (Stand Alone) frequency converters are independent units that can be powered either with mains three phase voltage or via DC bus. 890SD Series comes in a wide choice of sizes, suitable for every type of application, from small industrial machines to high-powered large plants (e.g. rolling mills, paper mills). They are also ideal for applications where single units are machine mounted (e.g. printing units).



- DIRECT MAINS SUPPLY OR VIA DCBUS**
- BUILT-IN DYNAMIC BRAKING UNIT**
- STANDARD WITH KEYPAD**
- COMMON OPTIONS WITH 890CD**
- COMMS OPTIONS AVAILABLE**

Part Number	Frame	HP@ 230Vac	Output Amps@ 230Vac
-------------	-------	---------------	------------------------

**AC890 Stand-alone Drives 208-240Vac (+/-10%) Input 3-phase**

890SD/2/0003B/B/00/A/US	B	0.75	3
890SD/2/0005B/B/00/A/US		1.5	5.5
890SD/2/0007B/B/00/A/US		2	7
890SD/2/0011B/B/00/A/US		3	11
890SD/2/0016B/B/00/A/US		5	16.5
890SD/2/0024C/B/00/A/US	C	7.5	24
890SD/2/0030C/B/00/A/US		10	30

*Note: The 890 comes in two performance level configurations, Advanced and High. The part #'s shown above 890SD/x/xxxxx/x/xx/A/xx are for Advanced models. For High Performance models, replace the Performance Level field designator with an H.*

Part Number	Frame	HP@ 460Vac	Output Amps@ 460Vac
<b>AC890 Stand-alone Drives 380 -500Vac (+/-10%) Input -3 Phase: Frames B thru D</b>			
<b>380 -460Vac (+/-10%) Input -3 Phase: Frames E and Higher</b>			
890SD/5/0002B/B/00/A/US	B	1	2
890SD/5/0003B/B/00/A/US		1.5	3.5
890SD/5/0004B/B/00/A/US		2	4.5
890SD/5/0006B/B/00/A/US		3	5
890SD/5/0010B/B/00/A/US		5	8
890SD/5/0012B/B/00/A/US		7.5	12
890SD/5/0016B/B/00/A/US		10	14
890SD/5/0024C/B/00/A/US	C	15	24
890SD/5/0030C/B/00/A/US		20	27
890SD/5/0039D/B/00/A/US	D	25	35
890SD/5/0045D/B/00/A/US		30	40
890SD/5/0059D/B/00/A/US		40	52
890SD/4/0073E/B/00/A/US	E	50	73
890SD/4/0087E/B/00/A/US		60	87
890SD/4/0105F/B/1F/A/US	F	75	100
890SD/4/0145F/B/1F/A/US		100	130
890SD/4/0156F/B/1F/A/US		125	156
890SD/4/0180F/B/1F/A/US		150	180
890SD/4/0216G/ * /1F/A/US		G	175
890SD/4/0250G/ * /1F/A/US	200		250
890SD/4/0316G/ * /1F/A/US	250		316
890SD/4/0361G/ * /1F/A/US	300		361
890SD/4/0420H/ * /1F/A/US	H	350	420
890SD/4/0480H/ * /1F/A/US		400	480
890SD/4/0520H/ * /1F/A/US		450	520
890SD/5/0590J/ * /1F/A/US	J	500	590
890SD/5/0685K/ * /1F/A/US	K(2xG)	600	685
890SD/5/0798K/ * /1F/A/US	K(2xH)	700	798
890SD/5/0988K/ * /1F/A/US	K(2xH)	800	988
890SD/5/1028K/ * /1F/A/US	K(3xG)	900	1028
890SD/5/1120K/ * /1F/A/US	K(2xJ)	1000	1120
890SD/5/1197K/ * /1F/A/US	K(3xH)	1000	1197
890SD/5/1482K/ * /1F/A/US	K(3xH)	1300	1482
890SD/5/1681K/ * /1F/A/US	K(3xJ)	1500	1681

\* The Braking switch is optional on these models—B is braking, N is no brake..

Note: The 890 comes in two performance level configurations, Advanced and High. The part #'s shown above 890SD/x/xxxxx/x/xx/A/xx are for Advanced models. For High Performance models, replace the Performance Level field designator with an H.

# AC890

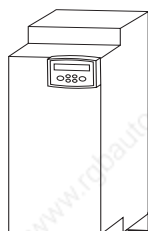

Frame Sizes B/C/D

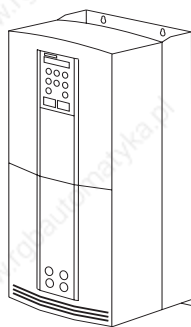

Frame Sizes E/F

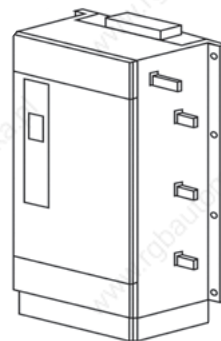

Frame Sizes G/H/J

## DIMENSIONS

Frame	H	W	D
890 Frame B	17.1 (433)	2.9 (72)	10.2 (258)
890 Frame C		4.6 (116)	
890 Frame D		6.3 (160)	
890 Frame E	26.3 (668)	10.1 (257)	12.3 (312)
890 Frame F	28.3 (720)		13.4 (355)
890 Frame G	41.0 (1042)	17.9 (456)	18.3 (465)
890 Frame H	46.3 (1177)	22.5 (572)	
890 Frame J	50.7 (1.288)	26.6 (675)	
890 Frame K	For K Frame Dimensions- Consult Factory		

Dimensions are in inches (mm).

## CABLES AND CONNECTORS

### Cables

Part Number	Description
CM471050	890 USB Programming Cable
8905/FWCBL200/00	200 mm FireWire Cable (B Frame to a B, C, and D Frame)
8905/FWCBL280/00	280 mm FireWire Cable (C, D Frame to a B, C, and D Frame)
8905/FWCBL1000/00	1000 mm FireWire Cable (Rack to Rack)
8905/FWCBL4500/00	4500 mm FireWire Cable (Rack to Enclosure)

### Bus Bar System

Part Number	Description
BH465850	1 m DC SSD Rail/Bus Bar 140A (UL)
BC465938U200	200 mm Insulator for DC Bus Bars
BA469216	Grounding Bus Bar 1m (CS/CD only)

### Assembly Kit

Part Number	Description
BA465900	Clips for Fitting on DIN rail
BA465887	Control Cable Support
BA465888	Supply Cable Support
8905/DUCTKIT/190	Duct Kit (1 m Exhaust Duct for Frames B, C, and D + 1 Fan Kit Rated at 190 CFM)



**OPTIONS**

**Feedback**

Part Number	Description
8902/E1/00/FF	EnDat 2.1 Encoder (SinCos, Heidenhain)
8902/EQ/00/FF	Incremental Quadrature Encoder
8902/HR/00/FF	Hiperface Encoder (SinCos, Stegmann)
8902/RE/00/FF	Resolver

**Comms Options**

Part Number	Description
8903/FA/00/FF	FireWire 1394a Communication Module
8903/DN/00/FF	DeviceNet Fieldbus Communication Module
8903/PB/00/FF	Profibus Fieldbus Communication Module
8903/CN/00/FF	ControlNet Fieldbus Communication Module
8903/CB/00/FF	CanOpen Fieldbus Communication Module
8903/EN/00/FF	Ethernet* Fieldbus Communication Module

\*Available soon

**Keypad**

Part Number	Description
6511	4-digit LCD Keypad*
6901	Alphanumeric Multilingual Keypad**
6502	Remote Mounting Kit for 6901 Keypad Including 3m Cable

\* Standard Equipment for sizes B/C/D

\*\* Standard Equipment for sizes E/F/G/H/J/K

**Firewire Repeaters**

Part Number	Description
LA471480	Firewire Repeater 100Mb/100ft

**INTERNATIONAL STANDARDS**

**Conforms to EC Directive 89/336/EEC in compliance with standard:**

- EN61800-3 (Environment 2)

**Conforms to EC Directive 73/23/EEC in compliance with standard:**

- EN50178 (Low Voltage)

**Complies with UL508C safety standard**

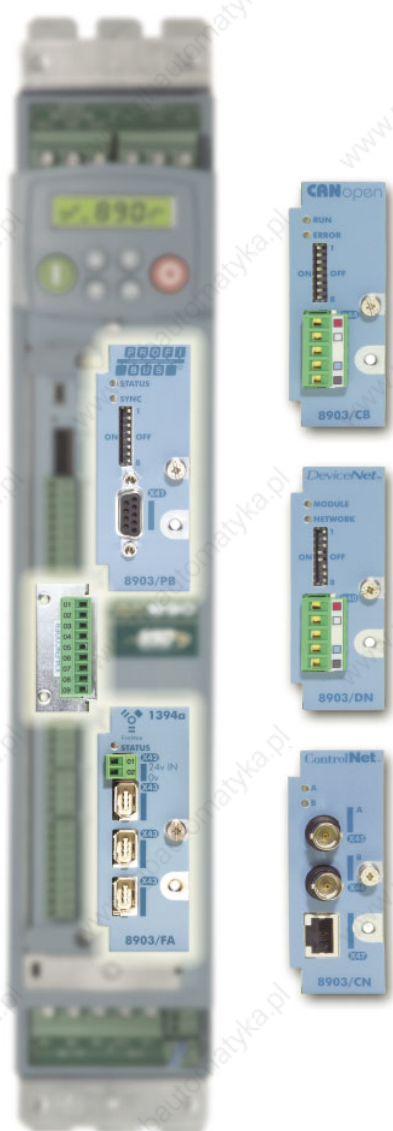

EMC Filters	P. 32
Line Reactors	P. 33
Braking Resistors	P. 16
DSE Programming Software	P. 50

**890 Braking Resistor Kits**

NEMA ICS 3-301.62 Dynamic braking stop option. Min. 100% fit from base speed with 6X motor inertia and 4 stops per hour. Includes the overload, protective cage and enclosure top or panel mounting.

**230V**

Frame	CT HP	VT HP	Part Number	Ohms	Amps	Watts	L x W x H
<b>890 CS</b>							
B1	10		LA471377	20	4.3	370	13.5x4x5
B2	20		LA471378	10	8.7	757	13.5x7x5
D1	40		LA471379	6	13.7	1126	13.5x10x5
D2	60		LA471380	4.0	19.4	1505	13.5x13x5
<b>890 SD</b>							
B	1	-	LA471355	200	0.71	100	6.5x1x1.6
B	2	-	LA471356	100	1	100	6.5x1x1.6
B	3	-	LA471358	56	1.9	200	6.5x1.2x2.4
B	5	-	LA471385	25	3.9	380	13.5x4x5
C	7.5	10	LA471385	25	3.9	380	13.5x4x5
C	10	15	LA471386	15	5.0	375	13.5x4x5

**460V**

Frame	CT HP	VT HP	Part Number	Ohms	Amps	Watts	L x W x H
<b>890 CS</b>							
B1	25		LA471349	40	4	740	13.5x7x5
B2	45		LA471350	22.5	7.1	1134	13.5x10x5
D1	90		LA471351	12	11	1505	13.5x13x5
D2	135		LA471352	9.0	15.8	2247	13.5x10x7.5
<b>890 SD</b>							
B	1		LA471353	500	0.35	60	4x1x1.6
B	2		LA471355	200	0.71	100	6.5x1x1.6
B	3		LA471355	200	0.71	100	6.5x1x1.6
B	5		LA471356	100	1	100	6.5x1x1.6
B	7.5		LA471357	100	1.4	200	6.5x1.2x2.4
B	10		LA471358	56	1.9	200	6.5x1.2x2.4
C	15		LA471359	56	3.0	500	13.2x1.2x2.4
C	20		LA471361	30	5.0	750	13.5x7x5
D	25		LA471361	30	5	750	13.5x7x5
D	30		LA471362	25	5.5	756	13.5x7x5
D	40		LA471350	22.5	7.1	1134	13.5x10x5
E	50	60	LA471364	18	7.9	1123	13.5x10x5
E	60	75	LA471365	15	8.7	1135	13.5x10x5
F	75	100	LA471367	8	13.7	1502	13.5x13x5
F	100	125	LA471367	8	13.7	1502	13.5x13x5
F	125	150	LA471369	6	19.4	2258	13.5x10x5
F	150	-	LA471369	6	19.4	2258	13.5x10x5
G	200	250	LA471370	3	39	4563	20x18x10
G	250	300	LA471372	2.25	45	4556	20x18x10
G	300	350	LA471372	2.25	45	4556	20x18x10
H	350	400	LA471375	1.50	55	4538	20x18x10
H	400	450	LA471375	1.50	55	4538	20x18x10
H	450	500	LA471375	1.50	55	4538	20x18x10
J	500	550	LA471376	1.20	61	4465	20x18x10

# TS8000

## DESCRIPTION

The TS8000 is a user-friendly, powerful graphical HMI touchscreen and much more. It seamlessly communicates to numerous peripheral devices including SSD Drive products, all the major PLC brands and many other motion control and instrumentation platforms. This is all possible with the standard RS-232, RS-485 and Ethernet communication ports as well as popular Fieldbus option cards. The TS8000 truly has a handle on all of your industrial automation control needs.

The TS8000 is available in a wide array of popular sizes: 3", 6", 8" and 10.4" for easy enclosure or operator console mounting.

- MULTILINGUAL GRAPHICAL INTERFACE**
- PRE-ENGINEERED PROJECTS**
- BUILT-IN WEB SERVER**
- COMPACTFLASH CARD SLOT**
- INTEGRATED PROTOCOL CONVERSION**
- SOFTWARE AND PROGRAMMING CABLE INCLUDED**



## SPECIFICATIONS

<b>Power Supply</b>	24Vdc ±20%
<b>Operating Temperature</b>	0–50°C
<b>Degree of Protection</b>	IP66/NEMA 4
<b>Touchscreen</b>	Resistive Analog
<b>Operator Keypad Entry</b>	TS8003: 3" screen 8 prog. keys - 5 navigation - 12 numeric - 7 dedicated TS8006: 6" touchscreen and 5 programmable keys TS8008: 8" touchscreen and 7 programmable keys TS8010: 10" touchscreen and 8 programmable keys CompactFlash Type I or Type II cards

### Memory Card

### Communication Ports

- Programming USB 1.1 Type B Connection
- Programming Serial RS232 via RJ12
- Communication Serial RS232 via RJ12 · RS485 via RJ45
- Ethernet 10/100 Base-T · RJ45 connector

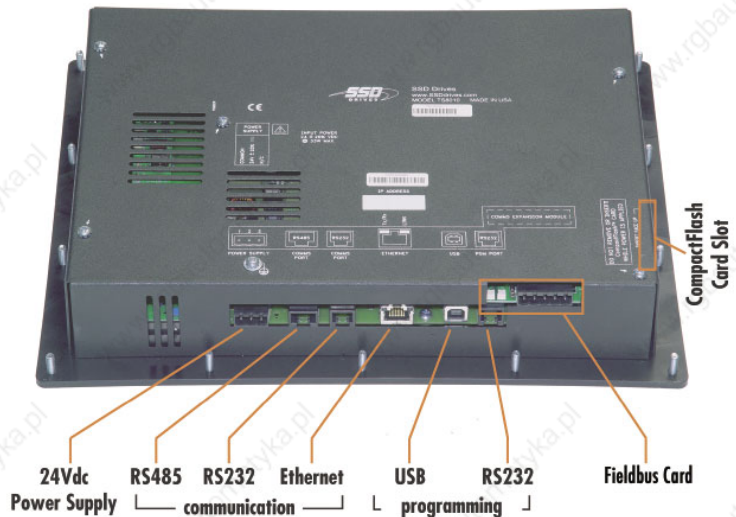

**HMI FEATURES**

**Multilingual Interface**

Programming and Display in:

- Dutch
- English
- French
- German
- Italian
- Spanish

Unicode\* Support for:

- Japanese
- Thai
- Korean
- Chinese (Traditional)
- Chinese (Simplified)
- Others Available

**Application Diagram**



**TS8000** is compatible with most of the major industrial PLC brands, such as:

- ⌘ ALLEN BRADLEY
- ⌘ FESTO
- ⌘ GENERAL ELECTRIC
- ⌘ IDEC
- ⌘ IMO
- ⌘ KLOCKNER MOELLER
- ⌘ MATSUSHITA
- ⌘ MITSUBISHI
- ⌘ MODICON
- ⌘ OMRON
- ⌘ PLC DIRECT/KOYO
- ⌘ SIEMENS
- ⌘ TELEMECANIQUE
- ⌘ TOSHIBA

**Pre-Engineered Projects**

- Library with over 4000 symbols
- Support for BMP, JPG, WMF graphic files
- Database
- Graphical Trends
- Alarm Logs



\*All trademark names and associated marks are owned by their respective companies.



**APPLICATIONS**

**Punch machine**

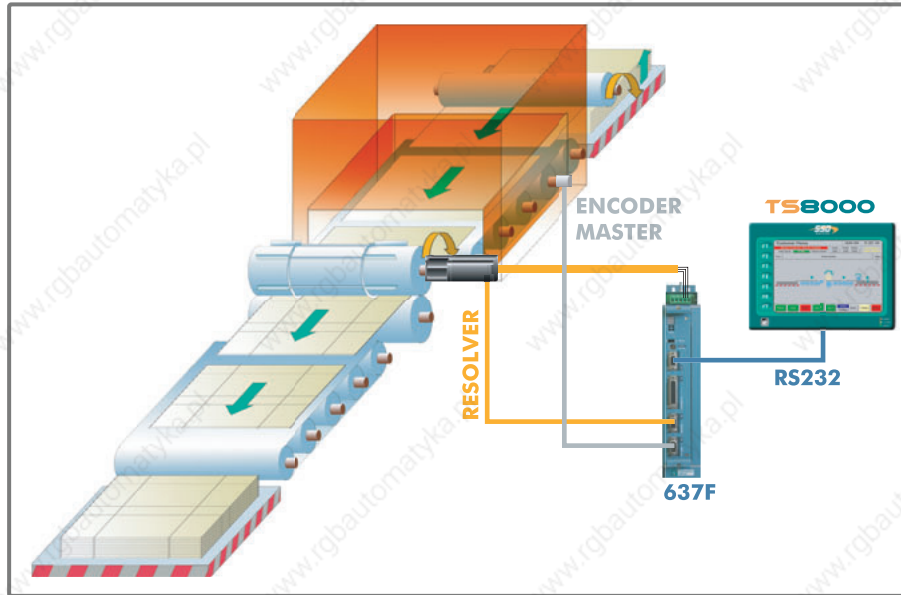

**Slitter**

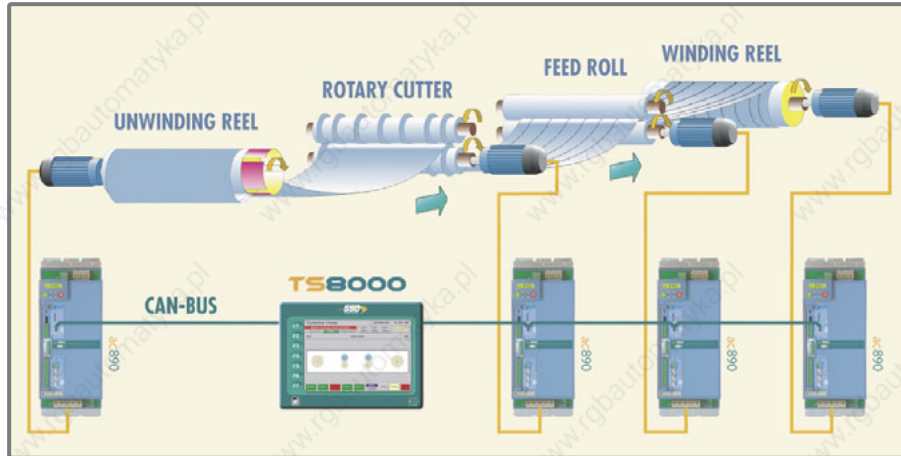

**Cut-to-Length**

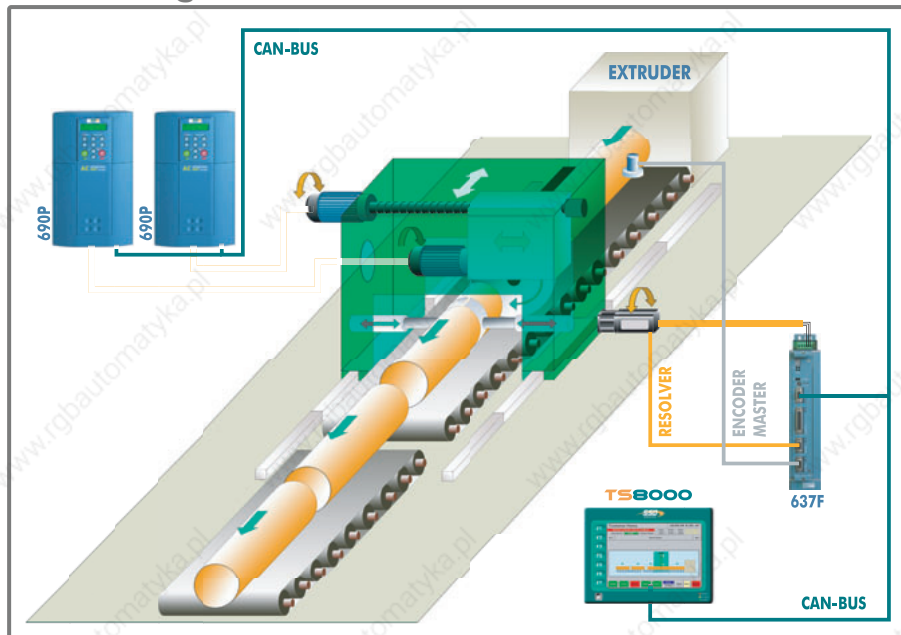

**DIMENSIONS AND WEIGHT**

Model	TS8003	TS8006	TS8008	TS80010
Screen	3.5" FSTN	5.7" STN	7.7" DSTN	10.4" TFT
Colors	2	256	256	256
Pixels	128 x 64	320 x 240	640 x 480	640 x 480
a	7.45 (189.2)	8.83 (224.3)	10.32 (262.0)	12.83 (325.8)
b	5.85 (148.6)	7.08 (179.8)	8.18 (207.8)	9.50 (241.3)
c	2.1 (52.0)	2.3 (58.4)	2.20 (56)	2.20 (56)
d	6.04 (153.4)	7.42 (188.5)	8.91 (226.3)	11.55 (293.3)
e	4.44 (112.8)	5.67 (144)	6.77 (172.0)	8.27 (210.1)
Weight	1.96 (0.89)	3.00 (1.36)	3.84 (1.74)	5.53 (2.51)

\*Dimensions in inches (mm), weight in lbs. (kg.)

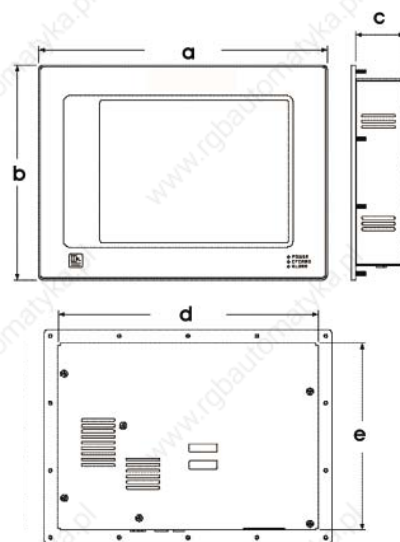

**HMI TOUCHSCREEN**

Part Number	Disc Code
8000/CB/00	CANopen Fieldbus Option Card
8000/DN/00	DeviceNet Fieldbus Option Card
8000/LK/00	Link RTN Fieldbus Option Card
8000/FA/00	Firewire Fieldbus Option Card
8000/PB/00	Profibus Fieldbus Option Card
LA471103	TS8000 Launch Kit: TS8006, Doc. CD, Table Bracket, Cables, Power Supply and Lit.
8000/OL/03	Protective Overlay Material - TS8003 (1 pack of 10)
8000/OL/06	Protective Overlay Material - TS8006 (1 pack of 10)
8000/OL/08	Protective Overlay Material - TS8008 (1 pack of 10)
8000/OL/10	Protective Overlay Material - TS8010 (1 pack of 10)

**CUSTOM OEM OVERLAY OPTION**

The custom OEM overlay option enables an OEM to quickly and easily customize the TS8000 to match your product or machine color scheme. You provide your 3 color choices from the PANTONE MATCHING SYSTEM, as shown in the graphic to the right, and in short order you have a customized TS8000. Please consult your sales representative for program details and restrictions.

**NO HASSLE**  
**COST EFFECTIVE**  
**QUICK TURNAROUND**

**OEM OPTIONS**

Part Number	Disc Code	Min. Quantity
TS8003/xx/00	MultiLine - TS8000 Series 3"	250
TS8006/xx/00	Touchscreen - TS8000 Series 6"	100
TS8008/xx/00	Touchscreen - TS8000 Series 8"	100
TS8010/xx/00	Touchscreen - TS8000 Series 10"	100

**Product labels provided by the OEM/Customer**

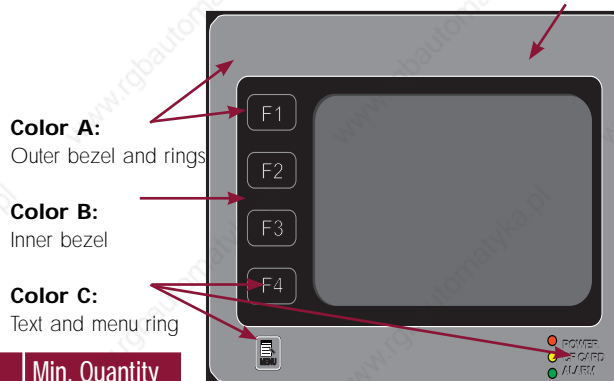

**INTERNATIONAL STANDARDS**

**Complies with standards:**

- EN61010-1
- EN61326
- EN55011 Class A



# 650/650V Series

## V/F and Sensorless Inverter

### from 0.3 to 150HP

#### DESCRIPTION

The 650 series inverters provide basic speed control of standard three phase AC motors from 0.3 to 10 HP (0.25 to 7.5 Kw). They are full of useful features including pre-programmed applications - all designed to simplify set-up, installation and operation.

The 650V series inverters provide simple, no-fuss speed control of standard three-phase AC motors from 0.3 to 150 HP. Sensorless vector provides exceptional dynamic response.

With the 650 series you are in control of your application immediately - no complicated set-up procedures, no confusing menu navigation: just quick and easy operation straight from the box.

- PRE-LOADED MACRO APPLICATIONS**
- BUILT-IN EMC FILTERS**
- EXTREMELY SIMPLE SET-UP AND PROGRAMMING**
- REMOVABLE KEYPAD**
- EXTREMELY COMPACT**
- MOTOR THERMISTOR INPUT**



**AC DRIVES**

#### SPECIFICATIONS

<b>Supply</b>	Single Phase 220–240Vac ±10% Three Phase 220–240Vac ±10% Three Phase 380–460Vac ±10%
<b>Operating Temperature</b>	0–40°C
<b>Altitude</b>	1000m ASL (Derate 1%/100m between 1000 and 5000m max)
<b>Overload</b>	150% for 30 seconds (heavy duty) 110% for 30 seconds (standard duty)
<b>Output Frequency</b>	0-240Hz
<b>Degree of Protection</b>	IP20
<b>Control</b>	V/F Control with linear or quadratic law Sensorless Vector Control (650V)

#### 650 Inputs/Outputs

Analog Inputs:	2 total, 1 (0-10V) + 1 (4-20mA)
Analog Outputs:	1 (0V/10V)
Digital Inputs:	3 configurable (24V)
Digital Relay Outputs:	1 configurable
Digital Inputs or Outputs:	1 configurable (24V)
Motor Thermistor Input:	1

#### 650V Inputs/Outputs

Analog Inputs:	2 total, 1 (0-10V) + 1 (4-20mA)
Analog Outputs:	1 (0V/10V)
Digital Inputs:	5 configurable (24V), 2 for encoder input
Relay Digital Outputs:	1 configurable
Digital Inputs or Outputs:	2 configurable (24V)
Motor Thermistor Input:	1

#### Reference Supplies

Digital I/O:	24Vdc (50mA)
Analog I/O:	10Vdc (10mA)

Frames C/D/E/F

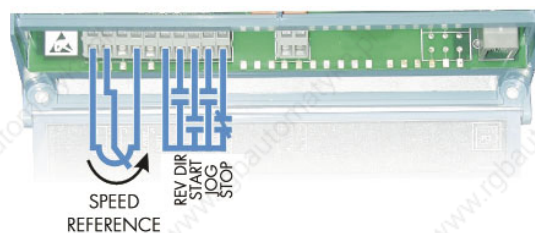

Frames 1/2/3

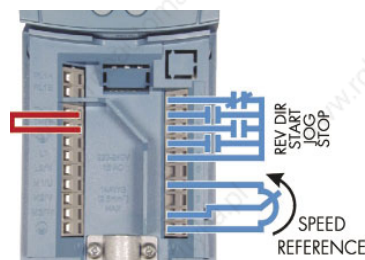

**USER FRIENDLY**

- No language to learn
- Simplified menu, displaying only key parameters
- Programmable software with remote keypad option

**Programming**

Keypad 6511 is used for inverter configuration and control. The keypad includes a 4-digit backlit LCD display, depicting:

- Motor rotation and direction indicator
- Local/Remote operating Indicator
- Diagnostic or Parameter Indicator
- Units of measurement

The standard keypad mounted on the inverter is removable; it comes with remote mounting on panel board (up to 3m max. distance) as an option. The 650V also includes a P3 port that can be used for programming the inverter with CELite software.

**Pre-loaded Applications**

Select from 5 pre-loaded applications to automatically configure inputs/outputs and adapt the parameter list of the drive:

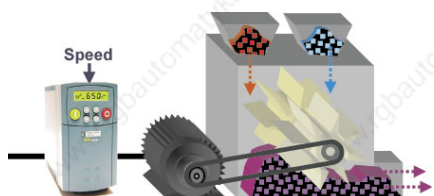
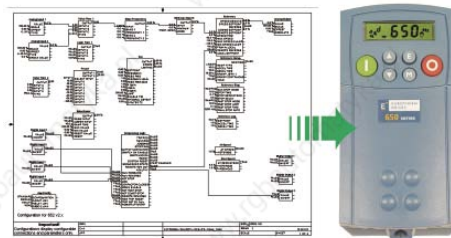

**Basic Speed Control:** voltage or current speed reference with digital start/stop and direction.

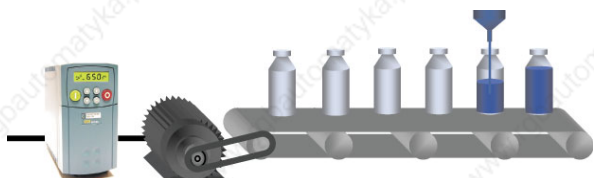

**Preset Speed:** select up to 8 pre-programmed speed references using digital input combinations.

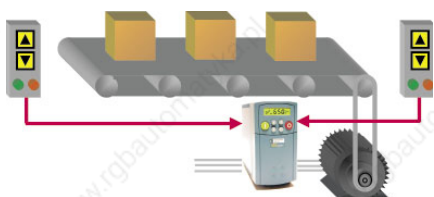

**Increase/Decrease:** increase and decrease speed via digital inputs.

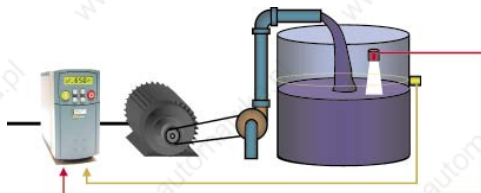

**Manual/Auto Control:** switch between a local and a remote speed reference signal.



**PID Control:** control pressure, flow, temperature and other variables by monitoring the feedback transducer.



**650/650V Series 220–240Vac Single/Three Phase Controllers**

Part Number	Frame	Power in HP Heavy (Standard) Duty	Current in A Heavy (Standard) Duty
+650(V)/00F3/230/SNN*	1	0.3	1.5
+650(V)/00F5/230/SNN*		0.5	2.2
+650(V)/00F7/230/SNN*		0.75	3
+650(V)/0001/230/SNN*		1	4
+650(V)/0002/230/SNN*	2	2	7
+650(V)/0003/230/SBN	3	3	9.6
+650(V)/0005/230/SBN		5	16.4
650V/0007/230/1BN	C	7.5 (10)	22 (28)
650V/0010/230/1BN		10 (15)	28 (42)
650V/0015/230/1BN		15 (20)	42 (54)
650V/0020/230/1BN	D	20 (25)	54 (68)
650V/0025/230/1BN		25 (-)	68 (-)
650V/0030/230/1BN	E	30 (40)	80 (104)
650V/0040/230/CBN	F	40 (50)	104 (130)
650V/0050/230/CBN		50 (60)	130 (154)
650V/0060/230/CBN		60 (75)	154 (192)

**650/650V Series 380–460Vac Three Phase Controllers**

Part Number	Frame	Power in HP Heavy (Standard) Duty	Current in A Heavy (Standard) Duty
+650(V)/00F5/460/SBN	2	0.5	1.5
+650(V)/00F7/460/SBN		0.75	2
+650(V)/0001/460/SBN		1	2.5
+650(V)/0002/460/SBN		2	4.5
+650(V)/0003/460/SBN		3	5.5
+650(V)/0005/460/SBN	3	5	9
+650(V)/0007/460/SBN		7.5	12
+650(V)/0010/460/SBN		10	16
650V/0015/460/1BN	C	15 (20)	23 (27)
650V/0020C/460/1BN		20 (25)	27 (34)
650V/0025/460/1BN	D	25 (30)	38 (45)
650V/0030/460/1BN		30 (40)	45 (52)
650V/0040D/460/1BN		40 (50)	52 (65)
650V/0050/460/1BN		50 (60)	73 (87)
650V/0060/460/1BN	E	60 (75)	87 (105)
650V/0075/460/CBN		75 (100)	100 (125)
650V/0100/460/CBN	F	100 (125)	130 (156)
650V/0125/460/CBN		125 (150)	156 (180)
650V/0150/460/CBN		150 (-)	180 (-)

\* Single-phase supply only and no brake switch  
 + (V) To be added to Part Number for the Sensorless version  
 Note: Overload values:  
 150% Heavy Duty for 30 seconds  
 110% Standard Duty for 30 seconds

**DCU BRAKING RESISTOR KITS**

NEMA ICS 3-301.62 Dynamic braking stop option. Min. 100% flt from base speed with 6X motor inertia and 4 stops per hour. Includes the overload, protective cage and enclosure top or panel mounting.

**230V**

Frame	Heavy Duty HP	Standard Duty HP	Part Number	Ohms	Amps	Watts	L x W x H
3	3	-	LA471358	56	1.9	202	6.5x1.2x2.4
3	5	-	LA471358	56	1.9	202	6.5x1.2x2.4
C	7.5	10	LA471406	30	3.5	368	13.5x4x5
C	10	15	LA471406	30	3.5	368	13.5x4x5
D	15	20	LA471386	15	5.0	375	13.5x4x5
D	20	25	LA471378	10.0	8.7	757	13.5x7x5
D	25	x	LA471378	10.0	8.7	757	13.5x7x5
E	30	40	LA471407	7.0	10.40	757	13.5x7x5
F	40	50	LA471379	6	13.7	1126	13.5x10x5
F	50	60	LA471380	4.0	19.4	1505	13.5x13x5
F	60	75	LA471380	4.0	19.4	1505	13.5x13x5

**460V**

Frame	Heavy Duty HP	Standard Duty HP	Part Number	Ohms	Amps	Watts	L x W x H
2	0.5	0.50	LA471353	500	0.3	60	4x1x2
2	0.75	0.75	LA471353	500	0.3	60	4x1x2
2	1	1.00	LA471353	500	0.3	60	4x1x2
2	1.5	2	LA471353	500	0.3	60	4x1x2
2	2	2	LA471355	200	0.7	100	6.5x1x2
2	3	3	LA471355	200	0.7	100	6.5x1x2
3	5	5	LA471356	100	1.0	100	6.5x1x1.6
3	7.5	7.5	LA471357	100	1	200	6.5x1.2x2.4
3	10	10	LA471358	56	2	200	6.5x1.2x2.4
C	15	20	LA471359	56	3	500	13.2x1.2x2.4
C	20	25	LA471405	60	3.5	735	13.5x7x5
D	25	30	LA471361	30	5	750	13.5x7x5
D	30	40	LA471361	30	5	750	13.5x7x5
D	40	50	LA471350	22.5	7.1	1134	13.5x10x5
E	50	60	LA471364	18	7.9	1123	13.5x10x5
E	60	75	LA471365	15	8.7	1135	13.5x10x5
F	75	100	LA471367	8	13.7	1502	13.5x13x5
F	100	125	LA471367	8	13.7	1502	13.5x13x5
F	125	150	LA471369	6	19.4	2258	13.5x10x5
F	150	-	LA471369	6	19.4	2258	13.5x10x5

## Dimensions and Weight

Frames 1, 2, 3

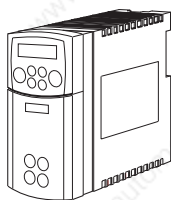

Frames C, D, E, F

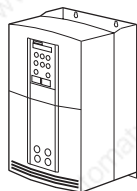

Frame	H	W	D	Weight
1	5.6 (143)	2.9 (73)	5.6 (142)	2.0 (0.85)
2	7.9 (201)	2.9 (73)	6.8 (173)	3.0 (1.4)
3	10.2 (260)	3.8 (96)	7.9 (200)	6.0 (2.7)
C	13.7 (348)	7.9 (201)	8.1 (208)	20 (9.3)
D	17.8 (453)	9.9 (252)	9.6 (245)	38 (17.4)
E	26.3 (668)	10.1 (257)	12.2 (312)	72 (32.5)
F	28.9 (720)	10.1 (257)	14.0 (355)	92.4 (41)

All dimensions are in inches (mm). Weight is in lbs. (kg).

## OPTIONS

Part Number	Description
6901	Alphanumeric Operator Panel
6052	Remote mount Kit for removable operator panel for 650V C/D/E/F - (3m cable included)
6511/RS232/00	Remote mounted keypad (Frames 1-3)
6513/00	Serial communications techbox RS-485 (Frames 1-3)
6514/00	Cloning Module

## INTERNATIONAL STANDARDS

**Conforms to EC Directive 89/336/EEC in compliance with standard:**

- EN61800-3

**Conforms to EC Directive 73/23/EEC in compliance with standard:**

- EN50178 (Low Voltage)

**Complies with UL508C safety standards**



EMC Filters	P. 32
Line Reactors	P. 33
Braking Resistors	P. 24
Programming Software	P. 52

# 690+ Series Integrator

## V/F, Sensorless, Vector Inverter from 1 to 1600 HP

### DESCRIPTION

The 690+ Series is a single range of AC drives designed to meet the requirements of all variable speed applications from simple single motor speed control through the most sophisticated integrated multi-drive systems. The heart of the 690+ is a highly advanced 32-bit microprocessor-based motor control model which provides exceptional dynamic performance. Add a host of communications and control options to tailor the drives to meet your exact requirements.



**4-MODE INVERTER: V/F, SENSORLESS VECTOR, FLUX VECTOR, LINE REGENERATIVE**

**SET-UP, PROGRAMMING AND COMMUNICATION PROTOCOLS IN COMMON WITH 590+ SERIES INTEGRATOR**

**FUNCTION BLOCK PROGRAMMING**

**BUILT-IN EMC FILTERS**

**TORQUE AT ZERO SPEED**

### SPECIFICATIONS

#### Supply

Single phase 220–240Vac ±10%  
 Three phase 220–240Vac ±10%  
 Three phase 380–460Vac ±10%  
 Three phase 380–500Vac ±10% (from 2.2 to 90kW by request)

#### Operating Temperature

Heavy duty 0–45°C (40°C with IP40 protection) (Derate 2%/°C up to 50°C max)  
 Standard duty 0–40°C (35°C with IP40 protection) (Derate 2%/°C up to 50°C max)

#### Altitude Overload

1000m ASL (Derate 1%/100m between 1000 and 5000m max)

#### Output frequency

0–1000Hz

#### Degree of protection

IP20 (Sizes G/H/J IP00)

#### Inputs/Outputs

Analog Inputs: 4 total, 2 configurable (0-10V, ±10V, 0-20mA, 4-20mA)  
 2 configurable (0-10V, ±10V)  
 Analog Outputs: 3 total, 1 configurable (0-10V, ±10V, 0-20mA, 4-20mA)  
 2 configurable (0-10V, ±10V)  
 Digital Inputs: 7 configurable (24V)  
 Relay Digital Outputs: 3 configurable  
 Motor Thermistor Input: 1

#### Reference supplies

Digital I/O: 24Vdc (150mA)  
 Analog I/O: +10Vdc, -10Vdc (10mA)

#### Auxiliary supply (only sizes F–K)

110Vac ±10% (on request 220Vac ±10%)

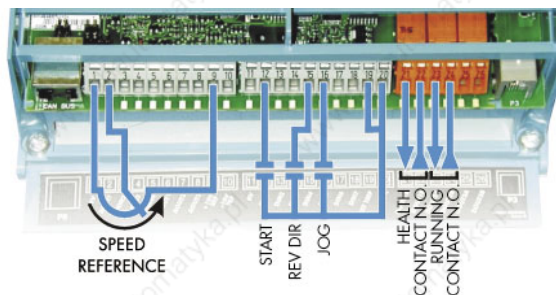



## FUNCTION BLOCK PROGRAMMING

Function Block Programming is a tremendously flexible control structure that allows an almost infinite combination of user functions to be realized with ease. Each control function (an input, output, process PID for example) is represented as a software block that can be freely interconnected to all other blocks to provide any desired action.

The drive is dispatched with the function blocks pre-configured as a standard AC drive so you can operate it straight from the box without further adjustments. Alternatively you can pick pre-defined Macros or even create your own control strategy, often alleviating the need for an external PLC.

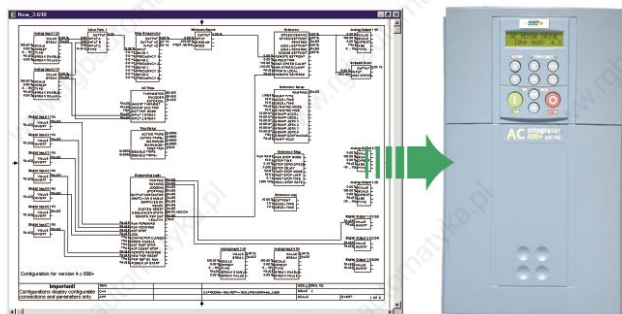

### FUNCTION BLOCKS INCLUDE:

- Inputs
- Outputs
- Ramps
- Encoder
- Raise/Lower
- Skip Frequencies
- Process PID
- Local/Remote
- Brake Control
- Auto Restart
- Spinning Load Start
- Custom Screens
- Trip History
- Password
- Value Functions
- Logic Functions

### STANDARD MACROS:

- Basic Speed Control
- Forward/Reverse
- Raise/Lower
- Process PID
- Preset Speeds
- Winder Control

## 6901KEYPAD

The 6901keypad is designed for programming and controlling the inverter quickly and easily. Its back-lit, 32-digit alphanumeric display with ergonomic keys provides access to all functions in a logical menu.

### Features:

- Mounting on the 690+ or remote panel mounting
- Local control of running, speed and direction
- Customized menu and parameters
- Password and function lockout
- Quick setup menu



### Multilingual

English · French · German · Spanish · Italian · Polish · Portuguese · Swedish

### Quick Setup

Preloaded application macros to avoid complex configurations for simple applications

### Autotune

Automatic survey of motor data necessary to obtain the maximum performance

### Customized Display

Customized screens with engineering units for specific applications

### Internal Links

Interconnecting function blocks

## Systems Board Expansion

This expansion module includes functions for phase control and register control. Installed inside the 690+ behind the control board, it adds to the inverter:

- 5 Additional configurable digital inputs/outputs
- 2 Additional encoder Inputs
- 2 High-speed register inputs
- Upgrade of analog input resolution (from 10 to 12 bit + sign)

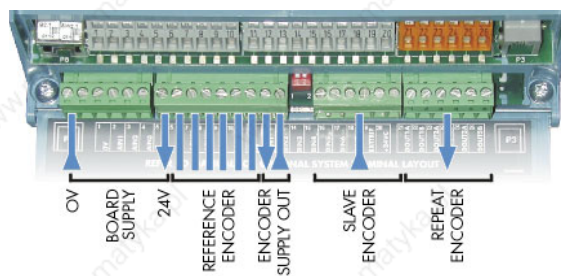

**AC DRIVES**

**690+ Series**

Part Number	Heavy Duty		Standard Duty		Frame	Built-in Reactor	Built-in Brake Switch
	HP	Output Current (A)	HP	Output Current (A)			
<b>220-240 (±10%) Vac Supplies– Single Phase and Three Phase</b>							
690+0001/230/...*	1	4	–	–	B	–	YES
690+0002/230/...*	2	7	–	–		–	YES
690+0003/230/...*	3	10.5	–	–		–	YES
690+0005/230/...	5	16.5	–	–		–	YES
690+0007/230/...	7.5	22	10	28	C	DC	YES
690+0010C/230/...	10	28	15	42		DC	YES
690+0015/230/...	15	42	20	54	D	DC	Optional
690+0020/230/...	20	54	25	68		DC	Optional
690+0025/230/...	25	68	–	–		DC	Optional
690+0030/230/...	30	80	40	104	E	AC	Optional
690+0040/230/...	40	104	50	130	F	AC	Optional
690+0050/230/...	50	130	60	154		AC	Optional
690+0060/230/...	60	154	75	192		AC	Optional
690+0060/230/...	60	154	75	192		AC	Optional
<b>380-460 (±10%) Vac Supplies– Three Phase</b>							
690+0001/460/...	1	2.5	–	–	B	–	YES
690+0002/460/...	2	4.5	–	–		–	YES
690+0003/460/...	3	5.5	–	–		–	YES
690+0005/460/...	5	9.5	–	–		–	YES
690+0007/460/...	7.5	11	–	–		–	YES
690+0010B/460/...	10	14	–	–	C	–	YES
690+0015/460/...	15	21	20	27		DC	YES
690+0020C/460/...	20	27	25	34	D	DC	YES
690+0025/460/...	25	38	30	45		DC	Optional
690+0030/460/...	30	45	40	52		DC	Optional
690+0040D/460/...	40	52	50	65	E	DC	Optional
690+0050/460/...	50	73	60	87		AC	Optional
690+0060/460/...	60	87	75	105		AC	Optional
690+0075/460/...	75	100	100	125		AC	Optional
690+0100/460/...	100	130	125	156	F	AC	Optional
690+0125/460/...	125	156	150	180		AC	Optional
690+0150/460/...	150	180	–	–		AC	Optional
690+0175/460/...	175	216	200	260	G	External	Optional
690+0200/460/...	200	250	250	302		External	Optional
690+0250/460/...	250	316	300	361		External	Optional
690+0300/460/...	300	361	350	420		External	Optional
690+0400/460/...	400	480	450	545	H	External	Optional
690+0450/460/...	450	520	500	590		External	Optional

Table continued on page 29

Part Number	Heavy Duty		Standard Duty		Frame	Built-in Reactor	Built-in Brake Switch
	HP	Output Current (A)	HP	Output Current (A)			
380-460 (±10%) Vac Supplies– Three Phase <i>(continued from page 28)</i>							
690+0500/460/...	500	590	550	650	J	External	Optional
690K0600/460/2G... **	600	685	700	798	K	AC	Optional
690K0700/460/2H... **	700	798	800	912		AC	Optional
690K0800/460/2H... **	800	988	900	1120		AC	Optional
690K0900/460/3G... ***	900	1028	1000	1197		AC	Optional
690K1000/460/2J... **	1000	1120	1100	1235		AC	Optional
690K1000/460/3H... ***	1000	1197	1200	1368		AC	Optional
690K1300/460/3H... ***	1300	1482	1500	1681		AC	Optional
690K1500/460/3J... ***	1500	1681	1600	1852		AC	Optional

\*Add a '-1' suffix for controllers using a single-phase supply

\*\*Two parallel stacks

\*\*\*Three parallel stacks

Note: Overload values: 150% Heavy Duty for 1 minute  
110% Standard Duty for 1 minute

Frame	Overall Dimensions		
	H	W	D
B	9.17 (233)	6.95 (176.5)	7.15 (181)
C	13.70 (348)	7.91 (201)	8.19 (208)
D	17.80 (453)	9.92 (252)	9.65 (245)
E	26.30 (668)	10.10 (257)	12.30 (312)
F	28.30 (720)	10.10 (257)	14.0 (355)
G	41.00 (1042)	17.90 (456)	18.30 (465)
H	46.30 (1177)	22.50 (572)	18.30 (465)
J	50.70 (1288)	26.60 (677)	18.30 (465)
K*	79.00 (2007)	128.00 (3251)	24.00 (610)
K**	79.00 (2007)	144.00 (3658)	24.00 (610)

Frames B/C/D/E/F

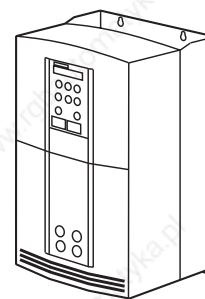

Frames G/H/J

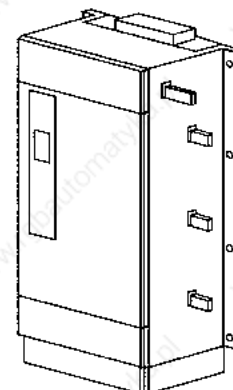

Dimensions are in inches (mm)

\* 6-Pulse input (12-pulse optional)

\*\* 6-Pulse input (18-pulse optional)

K-frame dimensions include modified NEMA 12 ventilated enclosures with flange disconnect

**690+ Braking Resistor Kits**

NEMA ICS 3-301.62 Dynamic braking stop option. Min. 100% flt from base speed with 6X motor inertia and 4 stops per hour. Includes the overload, protective cage and enclosure top or panel mounting.

**230V**

Frame	Heavy Duty HP	Standard Duty HP	Part Number	Ohms	Amps	Watts	L x W x H
B	1	-	LA471358	56	1.9	202	6.5x1.2x2.4
B	2	-	LA471358	56	1.9	202	6.5x1.2x2.4
B	3	-	LA471358	56	1.9	202	6.5x1.2x2.4
B	5	-	LA471358	56	1.9	202	6.5x1.2x2.4
C	7.5	10	LA471406	30	3.5	368	13.5x4x5
C	10	15	LA471406	30	3.5	368	13.5x4x5
D	15	20	LA471386	15	5.0	375	13.5x4x5
D	20	25	LA471378	10.0	8.7	757	13.5x7x5
D	25	x	LA471378	10.0	8.7	757	13.5x7x5
E	30	40	LA471407	7.0	10.40	757	13.5x7x5
F	40	50	LA471379	6	13.7	1126	13.5x10x5
F	50	60	LA471380	4.0	19.4	1505	13.5x13x5
F	60	75	LA471380	4.0	19.4	1505	13.5x13x5

**460V**

Frame	Heavy Duty HP	Standard Duty HP	Part Number	Ohms	Amps	Watts	L x W x H
B	1	1	LA471356	100	1	100	6.5 x 1 x 1.6
B	2	2	LA471356	100	1	100	6.5 x 1 x 1.6
B	3	3	LA471356	100	1	100	6.5 x 1 x 1.6
B	5	5	LA471404	100	1.9	361	13.5x4x5
B	7.5	7.5	LA471404	100	1.9	361	13.5x4x5
B	10	10	LA471404	100	1.9	361	13.5x4x5
C	15	20	LA471359	56	3.0	500	13.2x1.2x2.4
C	20	25	LA471405	60	3.5	735	13.5x7x5
D	25	30	LA471361	30	5	750	13.5x7x5
D	30	40	LA471361	30	5	750	13.5x7x5
D	40	50	LA471350	22.5	7.1	1134	13.5x10x5
E	50	60	LA471364	18	7.9	1123	13.5x10x5
E	60	75	LA471365	15	8.7	1135	13.5x10x5
F	75	100	LA471367	8	13.7	1502	13.5x13x5
F	100	125	LA471367	8	13.7	1502	13.5x13x5
F	125	150	LA471369	6	19.4	2258	13.5x10x5
F	150	-	LA471369	6	19.4	2258	13.5x10x5
G	200	250	LA471370	3	39	4563	20x18x10
G	250	300	LA471372	2.25	45	4556	20x18x10
G	300	350	LA471372	2.25	45	4556	20x18x10
H	350	400	LA471375	1.50	55	4538	20x18x10
H	400	450	LA471375	1.50	55	4538	20x18x10
H	450	500	LA471375	1.50	55	4538	20x18x10
J	500	550	LA471376	1.20	61	4465	20x18x10



## COMMUNICATION OPTIONS

The Technology Box allows 690+ to integrate with different Fieldbus protocols.

- LINK
- DeviceNet
- ControlNet
- ProfiBus
- ModBus RTU
- Ethernet
- CANopen
- LonWorks
- EI Bisynch/RS422/RS485



Part Number		Description
6901/00		Keypad 6901
6052/00		Remote mounting Kit for operator panel 6901 (3m cable included)
690+ - Size B	690+ - Other sizes	Communication Technology Box
6053/PROF/00	6055/PROF/00	Profibus
6053/EI00/00	6055/EI00/00	Modbus/RS422/RS485/EI Bisynch
6053/LINK/00	6055/LINK/00	Link
6053/DEV/00	6055/DEV/00	DeviceNet
6053/CNET/00	6055/CNET/00	ControlNet
6053/CAN/00	6055/CAN/00	CanOpen
6053/LON/00	6055/LON/00	LonWorks
6053/ENET/00	6055/ENET/00	Ethernet
AH467489U001	Standard	P3 port for 5703/1
690+ - Size B	690+ - Other sizes	Feedback Technology Box
LA467461	6054/HTTL/00	Encoder HTL

## INTERNATIONAL STANDARDS

**Conforms to EC Directive 89/336/EEC in compliance with standard:**

- EN61800-3

**Conforms to EC Directive 73/23/EEC in compliance with standard:**

- EN50178 (Low Voltage)

**Complies with UL508C safety standards**



EMC Filters	P. 32
Line Reactors	P. 33
Braking Resistors	P. 30
Programming Software	P. 52

# EMC Filters

## DESCRIPTION

A Range of custom designed optional EMC (Electromagnetic Compatibility) filters are available for use with the Parker SSD Drives product range. These have been carefully designed to provide cost effective and easily implemented solutions for a variety of standard installations.



## SPECIFICATIONS

Operating temperature 0–40°C

### AC Drive Filters Technical Specifications

Part Number	Rating	Filter Part Number	Filter Style Mounting Kit	IP40 Wall	Emission Standard	Max. Cable Length
<b>AC Drive Filters</b>						
650/ 650V (200v)	Frame 1, 2,& 3	Order with Drive	INT	–	B	25m
650/650V (400v)	Frame 1, 2,& 3	Order with Drive	INT	–	A	25m
605/690+	Frame A & B	Order with Drive	INT	–	B	25m
<b>Filters for ONLY Grounded Neutral (TN) AC supplies up to 460V</b>						
650V/690+	Frame C	C0465513U036	FP	BA465514U036	B	50m
650V/690+	Frame D	C0465513U070	FP	BA465514U070	B	50m
650V/690+	Frame E	C0465513U105	FP	BA465514U105	B	50m
650V/690+	Frame F	C0465513U215	FP	–	B	50m
<b>Filters for Grounded Neutral (TN) or Ungrounded (IT) AC supplies up to 480V</b>						
650V/690+	Frame C	C0465515U036	FP	BA465514U036	A	50m
650V/690+	Frame D	C0465515U070	FP	BA465514U070	A	50m
650V/690+	Frame E	C0465515U105	FP	BA465514U105	A	50m
650V/690+	Frame F	C0465515U215	FP	–	A	50m
690+	Frame G	C0464517	MOD	–	A	300m
690+	Frame H	C0464517 (2X)	MOD	–	A	300m
690+	Frame J	C0464517 (2X)	MOD	–	A	300m

\* External filters available for cable runs longer than those specified

Please refer to your local sales office for details of EMC filters > 800A

The 590+ filters must be used in conjunction with the appropriate 2% impedance AC line reactor

INT = Internal Filter, factory installed within the drive module.

FP = Space saving Footprint Filter that fits behind the drive.

MOD = Module filter that must be mounted adjacent to the drive.

Emission Standard A = EN55011 Class A (Industrial EMC environment of EN50081-2)

Emission Standard B = EN55011 Class B (Residential, commercial and light industrial EMC environment of EN50081-1)

# Three-Phase Line Reactors

## DESCRIPTION

Line reactors are used for reducing the harmonics of the supply current and protecting the inverter input stage from possible voltage peaks on the power mains.



## SPECIFICATIONS

**Operating Temperature** 40°C

### 230V

Part Number	HP	Amp	Description
C0470653	1	4	Reactor 3-phase 3.00 mh
C0353011	1.5	8	Reactor 3-phase 1.50 mh
C0353011	2	8	Reactor 3-phase 1.50 mh
C0470638	3	12	Reactor 3-phase 1.25 mh
C0353012	5	18	Reactor 3-phase 0.80 mh
C0353013	7.5	25	Reactor 3-phase 0.50 mh
C0353014	10	35	Reactor 3-phase 0.40 mh
C0353015	15	45	Reactor 3-phase 0.30 mh
C0353016	20	55	Reactor 3-phase 0.25 mh
C0353017	25	80	Reactor 3-phase 0.20 mh
C0353017	30	80	Reactor 3-phase 0.20 mh
C0470654	40	100	Reactor 3-phase 0.15 mh
C0353018	50	130	Reactor 3-phase 0.10 mh
C0470058	60	160	Reactor 3-phase 0.075 mh

### 460V

Part Number	HP	Amp	Description
C0470650	1	2	Reactor 3-phase 12 mh
C0470651	2	4	Reactor 3-phase 6.50 mh
C0352782	3	8	Reactor 3-phase 5.00 mh
C0470652	5	8	Reactor 3-phase 3.00 mh
C0352783	7.5	12	Reactor 3-phase 2.50 mh
C0352785	10	18	Reactor 3-phase 1.50 mh
C0352786	15	25	Reactor 3-phase 1.20 mh
C0352901	20	35	Reactor 3-phase 0.80 mh
C0352901	25	35	Reactor 3-phase 0.80 mh
C0352902	30	45	Reactor 3-phase 0.70 mh
C0352903	40	55	Reactor 3-phase 0.50 mh
C0352904	50	80	Reactor 3-phase 0.40 mh
C0352904	60	80	Reactor 3-phase 0.40 mh
C0352905	75	100	Reactor 3-phase 0.30 mh
C0352906	100	130	Reactor 3-phase 0.20 mh
C0470057	125	160	Reactor 3-phase 0.15 mh
C0470045	150	200	Reactor 3-phase 0.11 mh
C0470046	200	250	Reactor 3-phase 0.09 mh
C0470047	250	320	Reactor 3-phase 0.075 mh
C0470048	300	400	Reactor 3-phase 0.06 mh
C0470049	350	500	Reactor 3-phase 0.05 mh
C0470049	400	500	Reactor 3-phase 0.05 mh
C0470050	500	600	Reactor 3-phase 0.04 mh

**Dimensions and Weight**

Part Number	Height	Width	Depth	Weight
C0353010	3.1 (79)	6 (152)	4.8 (122)	8 (3.2)
C0353011	3.1 (79)	6 (152)	4.8 (122)	7 (3.1)
C0353012	3.1 (79)	6 (152)	4.8 (122)	9 (4.0)
C0353013	3.4 A(86)	7.2 (183)	5.6 (142)	11 (5.0)
C0353014	3.8 (97)	7.2 (183)	5.6 (142)	14 (6.3)
C0353015	4.8 (122)	9.0 (229)	7.0 (178)	23 (10)
C0353016	4.0 (102)	9.0 (229)	7.0 (178)	24 (11)
C0353017	5.6 (142)	10.8 (274)	8.2 (208)	43 (19)
C0353018	4.8 (122)	9.0 (229)	7.0 (178)	30 (14)
C0470650	2.8 (71)	4.4 (112)	4.0 (102)	4 (1.9)
C0470651	2.9 (72)	4.4 (112)	4.0 (102)	4 (1.9)
C0470652	3.1 (79)	6.0 (152)	4.8 (122)	7 (3.2)
C0470653	2.9 (72)	4.4 (112)	4.0 (102)	4 (1.9)
C0470654	5.6 (142)	10.8 (274)	8.2 (208)	47 (21)
C0353007	3.6 (92)	4.4 (112)	4.0 (102)	6 (2.7)
C0353009	3.4 (86)	6.0 (152)	3.4 (86)	13 (5.9)
C0352782	3.4 (86)	6.0 (152)	3.4 (86)	5.0 (11)
C0352783	3.1 (79)	6.0 (152)	4.8 (122)	10 (4.5)
C0352785	3.4 (86)	6.0 (152)	4.8 (122)	12 (5.4)
C0352786	3.4 (86)	7.2 (183)	5.6 (142)	14 (6.3)
C0352901	3.8 (97)	7.2 (183)	5.7 (145)	16 (7.3)
C0352902	4.8 (122)	9.0 (229)	7.0 (178)	28 (13)
C0352903	4.8 (122)	9.0 (229)	7.0 (178)	27 (12)
C0352904	5.6 (142)	10.8 (274)	8.3 (211)	51 (23)
C0352905	5.8 (147)	10.8 (274)	8.2 (208)	51 (23)
C0352906	5.8 (147)	10.8 (274)	8.4 (213)	58 (26)
C0470057	5.6 (142)	10.8 (274)	8.4 (213)	50 (22)
C0470045	6.3 (160)	10.8 (274)	8.4 (213)	67 (31)
C0470046	6.7 (170)	14.4 (366)	11.2 (284)	106 (45)
C0470047	6.7 (170)	14.4 (366)	11.2 (284)	125 (57)
C0470048	7.3 (185)	14.4 (366)	11.2 (284)	155 (71)
C0470049	7.8 (198)	14.4 (366)	11.3 (287)	180 (82)
C0470050	8.3 (211)	14.4 (366)	11.3 (287)	210 (96)

All dimensions are in inches (mm) and weights are in lbs. (kg)



# 506/507/508 Series

## Single Phase Analog Converters

### 3 to 12A

#### DESCRIPTION

The 506/507/508 Series is an advantageous control method for small-size DC motors. Available in 3, 6 and 12A sizes, with selectable supply powers between 110 and 230Vac, they are ideal for speed or torque control in wound field or permanent magnet DC motors.

#### COMPACT STRUCTURE

**DEGREE OF PROTECTION IP20**

**DIN RAIL MOUNTING**

**SELECTABLE POWER SUPPLY 110V OR 230V**

**TACHOGENERATOR OR ARMATURE FEEDBACK**



#### SPECIFICATIONS

**Supply**

110–120V (±10%), or 220–240V (±10%) single phase 50–60Hz (±5%)

**Operating Temperature**

0–45°C , up to 1000m ASL without derating

**Degree of protection**

IP20

**Field output**

2A

**Inputs/Outputs**

Analog Inputs

2

Digital Inputs

1 configurable (24V)

Type	Armature Current [A <sub>dc</sub> ]	Input Voltage [Vac]	Armature Voltage [V <sub>dc</sub> ]	Field Voltage [V <sub>dc</sub> ]
506/03/120	3	110-120	90	100
506/03/240		220-240	180	210
507/06/120	6	110-120	90	100
507/06/240		220-240	180	210
508/12/120	12	110-120	90	100
508/12/240		220-240	180	210

#### Dimensions and Weight

Type	H	W	D	Weight
506	55 (140)	4.1 (104)	3.1 (79)	1.3 (0.6)
507			3.5 (89)	1.5 (0.7)
508				

All dimensions are in inches (mm). Weight is in lbs. (kg).

#### OPTIONS

Part Number	Description
LA054664	Fuse Kit for 506/507
LA050062	Fuse Kit for 508
LA464345U002	Setpoint isolator (0-10mA)
LA464345U003	Setpoint isolator (4-20mA)

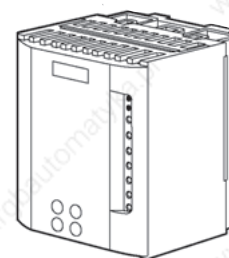

EMC Filters	P. 43
Line Reactors	P. 44

#### INTERNATIONAL STANDARDS

**Conforms to EC Directive 89/336/EEC according to standard:**

- EN61800-3 (Environment 1 and 2 with external filter)

**Conforms to EC Directive 73/23/EEC according to standard:**

- EN50178 (Low Voltage)

**Complies with UL508C safety standards**



# 512C Series

## Single phase Analog Isolated Converters

### 4 to 32A

#### DESCRIPTION

512C Series non-regenerative converters with single phase AC supply offer speed or torque full control for wound field or permanent magnet DC motors. Isolated control circuitry and extremely linear speed and current loops make the 512C ideal for single and multi-motor applications.

#### ISOLATED CONTROL CIRCUITRY

**SELECTABLE SUPPLY POWER 110V – 415V**

**CE MARKED - EMC CONFORMITY**

**MULTIPLE INPUTS FOR SPEED/CURRENT REFERENCE**

**DIGITAL OUTPUT FOR ZERO SPEED AND HEALTH**

**EXTREMELY LINEAR CONTROL LOOPS**



#### SPECIFICATIONS

<b>Supply</b>	110–115V, 220–240V or 380–415V (±10%) selectable, single phase
<b>Operating Temperature</b>	0–40°C, up to 1000m ASL without derating
<b>Overload</b>	150% for 60 seconds
<b>Degree of protection</b>	IPOO
<b>Field Output</b>	3Adc
<b>Inputs/Outputs</b>	3 total
Analog Inputs	1 (0V/10V)
Analog Outputs	1 configurable (24V)
Digital Inputs	1 configurable (24V)
Relay Digital Outputs	2 configurable

Part	Armature Current [Adc]	Input Voltage [Vac]	Armature Voltage [Vdc]	Field Voltage [Vdc]
512C/040/120	4	110 - 115	90	100
512C/040/240		220 - 240	180	210
512C/040/460		380 - 415	320	360
512C/080/120	8	110 - 115	90	100
512C/080/240		220 - 240	180	210
512C/080/460		380 - 415	320	360
512C/160/120	16	110 - 115	90	100
512C/160/240		220 - 240	180	210
512C/160/460		380 - 415	320	360
512C/320/120	32	110 - 115	90	100
512C/320/240		220 - 240	180	210
512C/320/460		380 - 415	320	360

#### Dimensions and Weight

Type	H	W	D	Weight
512C/040	9.4 (240)	6.2 (160)	3.3 (90)	3.3 (1.5)
512C/080				3.5 (1.6)
512C/160			4.8 (130)	6.6 (3)
512C/320				

All dimensions are in inches (mm). Weight is in lbs. (kg).

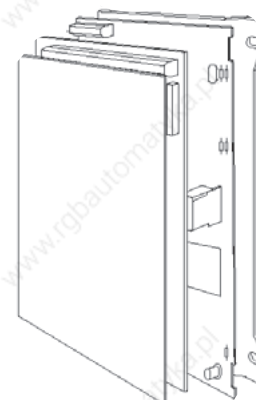

#### INTERNATIONAL STANDARDS

**Complies with EC Directive 89/336/EEC in compliance with standard:**

- EN61800-3 (Environment 1 and 2 with external filter)

**Complies with EC Directive 73/23/EEC in compliance with standard:**

- EN50178 (Low Voltage)

**Complies with UL508C safety standards**



# 514C Series

## Single phase Analog Isolated Regenerative Converters from 4 to 32A

### DESCRIPTION

The range of 514C Series regenerative converters, with single phase AC supply, offers full four-quadrant control of wound field or permanent magnet DC motors. It is ideal for applications requiring accurate braking of high-inertia loads or their fast and precise deceleration. 514C Series and its non-regenerative version 512C have been designed to offer the ideal solution for speed control of single and multi-motor applications.

### FOUR-QUADRANT REGENERATIVE CONTROL

**SELECTABLE SUPPLY 110V – 500V**

**CE MARKED - EMC CONFORMITY**

**INTEGRATED CONTACTOR CONTROL**

**MULTIPLE INPUTS FOR SPEED/CURRENT REFERENCE**

**EXTREMELY LINEAR CONTROL LOOPS**



### SPECIFICATIONS

#### Supply

Auxiliary: 110/120Vac or 220/240Vac ±10% selectable

Power: 110–480Vac selectable

#### Operating Temperature

0–40°C

#### Altitude

Up to 1000m ASL without derating

#### Overload

150% for 60 seconds

#### Degree of protection

IPOO

#### Field supply

3Adc

#### Inputs/Outputs

Analog Inputs 5 total

Analog Outputs 4 (±10V)

Digital Inputs 3 total, 1 (10V) and 2 (10-24V)

Relay Digital Outputs 2

Part Number	Armature Current [Adc]	Input Voltage [Vac]	Armature Voltage [Vdc]	Field Voltage [Vdc]
514C/040/120	4	110 - 480 selectable	90	100
514C/040/240			180	210
514C/040/460			320	360
514C/080/120	8		90	100
514C/080/240			180	210
514C/080/460			320	360
514C/160/120	16		90	100
514C/160/240			180	210
514C/160/460			320	360
514C/320/120	32		90	100
514C/320/240			180	210
514C/320/460			320	360

### Dimensions and Weight

Type	H	W	D	Weight
514C/04	9.4 (240)	6.2 (160)	3.5 (89)	3.5 (1.6)
514C/08				
514C/16			4.8 (130)	6.6 (3)
514C/32				

All dimensions are in inches (mm). Weight is in lbs. (kg).

### INTERNATIONAL STANDARDS

**Conforms to EC Directive 89/336/EEC in compliance with standard:**

- EN61800-3 (Environment 1 and 2 with external filter)

**Conforms to EC Directive 73/23/EEC in compliance with standard:**

- EN50178 (Low Voltage)

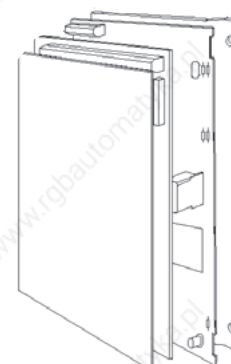

**CE MARKED**

# 590+ Integrator Series

## DC Digital Converters from 15 to 2700A

### DESCRIPTION

The Integrator Series is a single family of both AC drives (690+) and DC drives (590+) that provides the benefits of common programming, setup and communications across both technologies. The 590+ Integrator Series highly advanced DC drive meets the demands of the most complex motor control applications. Extensive application software (including winder control as standard) together with Function Block Programming and configurable I/O creates a total drive system in a single module.



**COMMON PROGRAMMING, SETUP AND COMMUNICATION PROTOCOLS WITH 690+  
DRV VERSION WITH BUILT-IN CONTACTOR AND FUSES  
OPEN AND CLOSED LOOP WINDER/UNWINDER CONTROL AS STANDARD  
RATINGS UP TO 2700A AND SUPPLY VOLTAGE UP TO 690V  
FUNCTION BLOCK PROGRAMMING  
BUILT-IN FIELD REGULATOR**

### SPECIFICATIONS

#### Power Supply

110–220V (±10%) Three phase  
220–500V (±10%) Three phase  
500–600V (±10%) Three phase  
500–690V (±10%) Three phase

#### Operating Temperature

0–45°C (sizes from 15 to 270A);  
0–40°C (sizes ≥ 380A)

#### Altitude

500m ASL (Derate 1%/200m from 500m to 5000m max)

#### Degree of protection

IP00 (Size 1 IP20)

#### Overload

200% for 10 seconds, 150% for 30 seconds

#### Inputs/Outputs

5 Analog Inputs configurable (12 bit + sign)  
3 Analog Outputs (10 bit + sign):  
- 1 Armature current Output (±10V or 0–10V)  
- 2 Configurable  
9 Digital Inputs (24V, max 15mA):  
- 1 Program Stop  
- 1 Coast Stop  
- 1 External Alarm  
- 1 Start-Run  
- 5 Configurable  
3 Digital Outputs configurable

#### Reference supply

Digital I/O : 24Vdc (200mA)  
Analog I/O : +10Vdc –10Vdc (10mA)

#### Auxiliary supply

110Vac ±10% (on request 220Vac ±10%)

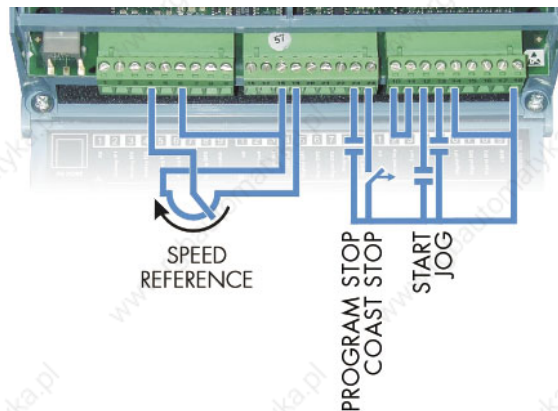



## FUNCTION BLOCK PROGRAMMING

Function Block Programming provides a variety of functions:

- PID Control**
- Calculation of diameter**
- Calculation of required speed**
- Calculation of compensation**
- Calculation of taper**
- Digital ramp**
- Preset speed**

Interconnecting pre-configured functions allow complex speed control without need of external units.

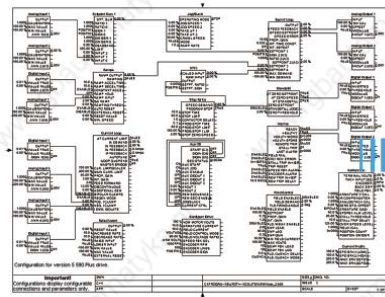

## DRV Version

### DESCRIPTION

590+ Series introduces a new and radical approach in DC drive design: the DRV philosophy. All auxiliary power components are integrated inside each 590+ DRV unit: AC line contactor, AC line fuses, DC fuse (regenerative versions only), field fuses, optional motor blower starter and auxiliary voltage transformer. This type of construction allows great space saving inside control panels, reducing time and cost of wiring.



**DRV**



**NO DRV**



**DRV**

220-460 (±10%) Vac Supplies -Three Phase						
Part Number		Nominal Output (HP)		DRV Output Current (Amps)	Controller Output Current (Amps)	Frame
DRV*	Controller **	230V Supply	460V Supply			
955+8R0007	-	3	7.5	15	-	1
955+8R0020		10	20	35		
955+8R0030		15	30	55		
955+8R0040		20	40	70		
955+8R0050		25	50	90		
955+8R0060		30	60	110		
955+8R0075		40	75	125		
955+8R0100		50	100	165		
955+8R0125	590+243/500	60	125	206	243	3
955+8R0150		75	150	243		
955+8R0200-D4	590+380/500	100	200	360	380	4
955+8R0250-D4	590+500/500	125	250	425	500	
955+8R0300-D4		150	300	490		
955+8R0400-D4	590+725/500	200	400	700	725	
955+8R0500-D4	590+830/500	250	500	815	830	
955+8R0600-D5	590+1580/500	-	600	1000	1580	5
955+8R0700-D5		-	700	1200		
955+8R0800-D5		-	800	1334		
955+8R0900-D5		-	900	1500		
955+8R0600	590+1050/500	-	600	1050	1050	7a (N or R)
955+8R0900	590+1450/500	-	900	1450	1450	7b (N or R)
955+8R1000	590+2000/500	-	1000	1600	2000	
955+8R1000		-	1250	2000		
955+8R1500	590+2400/500	-	1500	2400	2400	

\*Replace 'R' for regenerative with 'N' for non-regenerative; \*\*Replace 590+ for regenerative with 591+ for non-regenerative  
 Consult factory for 575, 660, 690 Vac part numbers and higher HP ratings.

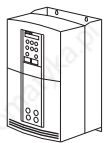

Frames 1/2



Frame 3

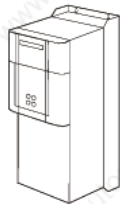

Frame 4

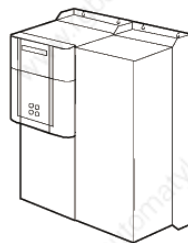

Frame 5

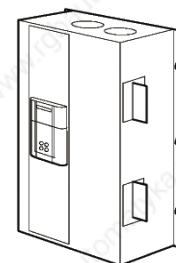

Frame 7

**Dimensions and Weight**

Frame	Controller			DRV		
	Height	Width	Depth	Height	Width	Depth
1	-	-	-	14.7 (373)	7.7 (196)	9.0 (229)
2	-	-	-	21.5 (546)		11.6 (295)
3	19.7 (500)	9.8 (250)	6.7 (170)	25.25 (641)	17 (432)	9.13 (232)
4	27.6 (700)	10.0 (253)	14.2 (358)	37.75 (946.1)	21 (533.3)	15.11 (383.7)
5		20.0 (506)	14.2 (358)	54.25 (1378)	38 (965.1)	18.47 (469.2)
7aN	37.6 (955)	33.5 (851)	16.4 (417)	68 (1727.2)	60 (1524)	16 (406.4)
7aR	55.4 (1407)	33.5 (851)	16.4 (417)	68 (1727.2)	60 (1524)	16 (406.4)
7bN	37.6 (955)	33.5 (851)	16.4 (417)	68 (1727.2)	60 (1524)	18 (457.2)
7bR	55.4 (1407)	33.5 (851)	16.4 (417)	68 (1727.2)	60 (1524)	18 (457.2)

## OPTIONS

### Keypad 6901

Operator Panel 6901 is designed for programming and controlling the inverter quickly and easily. Its back-lit, 32 digit alphanumeric display with ergonomic keys provides access to all functions in a logical menu.

**MOUNTING ON THE 590+ OR REMOTE PANEL MOUNTING**

**LOCAL CONTROL OF RUNNING, SPEED AND DIRECTION**

**CUSTOMIZED MENU PARAMETERS**

**PASSWORD FUNCTION LOCKOUT**

**CONFIGURE DRIVE MENU**



### Multilingual

English · French · German · Spanish · Italian · Polish · Portuguese · Swedish

### Fast Setup

Preloaded application macros avoid complex configurations for simple applications

### Autotune

Automatic survey of motor data necessary to obtain the maximum performance

### Internal Link

Interconnecting function blocks

## COMMUNICATION OPTIONS

The Technology Box allows 690+ to integrate with different Fieldbus protocols.

- LINK
- DeviceNet
- ControlNet
- ProfiBus
- Ethernet
- ModBus
- ModBus Plus
- CANopen
- EI Bisynch/RS422/RS485

## 590+ DRV CONTROL TRANSFORMER

**OPERATION WITH 208 THROUGH 500VAC SUPPLIES**

**MOUNTS INSIDE THE FRAME 1 AND 2 DRV'S**

**NOT NEEDED ON DRV'S ABOVE 100 HP (AT 500VDC)**

To order: Add -CX to the 590+ DRV part number

## BLOWER MOTOR STARTER

590+ DRV Blower Motor Starter option uses a manual motor circuit controller to provide motor overload and branch circuit protection for a single or three-phase AC blower motor. It mounts inside 590+ DRV DC Drives.

## UL LISTING AND CSA CERTIFICATION

**INSTANTANEOUS MAGNETIC SHORT-CIRCUIT PROTECTION**

**THERMAL OVERLOAD PROTECTION WITH ADJUSTABLE TRIP CURRENT SETTING**

**START/STOP-RESET SWITCHING WITH "TRIPPED" PUSHBUTTON INDICATION**

**NORMALLY -OPEN AUXILIARY CONTACT WIRED TO TERMINAL**



Amps	Part Number	
	Frames 1 & 2	All Others
0.16-0.25	955+BMS025	955-BMS250
0.25-0.40	955+BMS040	955-BMS40
0.40-0.63	955+BMS063	955-BMS630
0.63-1.00	955+BMS100	955-BMS11
1.00-1.60	955+BMS160	955-BMS161
1.60-2.50	955+BMS250	955-BMS251
2.50-4.00	955+BMS400	955-BMS41
4.00-6.30	955+BMS630	955-BMS631

**ARMATURE VOLTAGE FEEDBACK UNIT 5590**

This unit provides a means of isolating and attenuating motor armature voltage to levels compatible with drive input signals to give cost effective voltage feedback. It is designed specifically for use with analog drives.

- SUITABLE FOR MOTOR VOLTAGES 100-550V**
- IR COMPENSATION UP TO 11%**
- DIN RAIL MOUNTING**
- BI-DIRECTIONAL OPERATION**
- TRIM OUTPUT POTENTIOMETER**

Description	Part Number
Armature Voltage Feedback Unit	5590

**DIAGNOSTIC UNIT 5570**

An easy to use hand held diagnostic unit. The 5570 can be used in conjunction with the 514C and 5401 field controller. It gives access to 27 key test points on the drives, rapidly decreasing commissioning time and simplifying troubleshooting.

- LCD AND LED READOUTS**
- ACCESS TO 27 TEST POINTS**
- OSCILLOSCOPE/RECORDER OUTPUT**

Description	Part Number
Diagnostic Unit	5570

**THREE-PHASE LINE FILTER**

The filter provides additional protection against spikes induced on the AC line by DC controllers on 460Vac systems. It is recommended when accessories (such as blower motors) are connected to the same main supply as the controller without isolation.

Description	Part Number
Three-Phase Line Filter	LA048357
Fuse Kit for Three-Phase Line Filter	LA353837



# EMC Filters

## DESCRIPTION

A Range of custom designed optional EMC (Electromagnetic Compatibility) filters is available for use with the Parker SSD Drives product range. These have been carefully designed to provide cost effective and easily implemented solutions for a variety of standard installations.



### DC Drive Filters Technical Specifications

Part Number	Rating	Filter Part Number	Filter Style Mounting Kit	IP40 Wall	Emission Standard	Max. Cable Length
<b>DC Drive Filters</b>						
506/507/508	3,6,12A	C0389115	FP	-	B	50m
512C/ 514C	4,8,16A	C0389113	FP	-	B	50m
512C/ 514C	32A	C0389114	FP	-	B	50m
590+/955+	15A	C0467844U015	MOD	-	A	50m
590+/955+	35,40A	C0467844U040	MOD	-	A	50m
590+/955+	70A	C0467844U070	MOD	-	A	50m
590+/955+	110A	C0467844U110	MOD	-	A	50m
590+/955+	165A	C0467844U165	MOD	-	A	50m
590+/955+	180A	C0388965U180	MOD	-	A	50m
590+/955+	270, 360A	C0389456	MOD	-	A	50m
590+/955+	450A	C0389456 (2X)	MOD	-	A	50m
590+/955+	720, 800A	C0389456 (3X)	MOD	-	A	50m

\* External filters available for cable runs longer than those specified

Please refer to you local sales office for details of EMC filters > 800A

The 590+ filters must be used in conjunction with the appropriate 2% impedance AC line reactor.

INT = Internal Filter, factory installed within the drive module.

FP = Space saving Footprint Filter that fits behind the drive.

MOD = Module filter that must be mounted adjacent to the drive.

Emission Standard A = EN55011 Class A (Industrial EMC environment of EN50081-2)

Emission Standard B = EN55011 Class B (Residential, commercial and light industrial EMC environment of EN50081-1)

# Line Reactors

## THREE PHASE LINE REACTORS

These reactors are intended for use with the 590 Series three-phase controllers. They may be used when voltage transformation or supply isolation is not required. Line reactors:

- Reduce the level of voltage notching on the supply
- Limit total radiated RF interference
- Reduce current spikes in the supply lines during commutation of the SCR bridge.

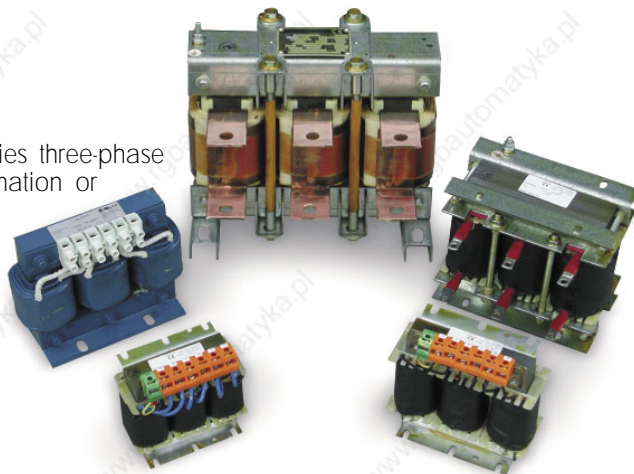

**COMPACT DESIGN**  
**UL AND CSA APPROVALS THROUGH 110A**  
**RATING FOR 230 AND 480VAC SUPPLIES**  
**TAB TERMINAL CONNECTIONS**

Horsepower (UL and CSA approval through 110A)					
230Vac	460Vac	DC Amps	Description	Part Number	
10	20	35	Reactor 50 µH (UL/CSA)	C0352378	
20	40	70	Reactor 50 µH (UL/CSA)	C0352379	
30	60	110	Reactor 50 µH (UL/CSA)	C0352380	
50	100	180	Reactor 50 µH	C0055255	
60	150	250	Reactor 25 µH	C0057960	
100	200	360	Reactor 25 µH	C0057961	
150	300	550	Reactor 25 µH	C0057962	
200	400	720	Reactor 25 µH	C0057963	

Dimensions					
Amps	Height	Width	Depth	Weight	
35	4.5 (114)	6.1 (155)	4.75 (121)	8 (3.6)	
70	5.5 (140)	6.1 (155)	4.75 (121)	11 (5.0)	
110	5.5 (140)	6.1 (155)	4.75 (121)	15 (6.8)	
180	13.0 (330)	7.5 (191)	6.25 (159)	27 (12.3)	
250	15.0 (380)	11.0 (280)	10.0 (255)		
360	15.0 (380)	11.0 (280)	10.0 (255)		
550	15.7 (398)	14.5 (366)	12.0 (306)		
720	15.7 (398)	14.5 (366)	12.0 (306)		

All dimensions are in inches (mm) and weights are in Lb. (Kg).

## THREE-PHASE LINE REACTORS FOR EMC

These reactors are used with EMC filters for DC controllers that must meet CE standards.

**CE APPROVED**  
**RATING TO 180A**

Three-Phase Line Reactors (CE approved)	
Size* DC Amps	Part Number
15	C0466449U015
40	C0466449U040
70	C0463037
110	C0463038
180	C0463039

\*Above 180 Amps use the standard line reactors listed above

**ARMATURE DC CONTACTOR OPTION**

For use with 590+ frames 1 and 2, this assembly provides a 3-pole DC loop contactor (includes dynamic braking contact) that isolates the motor from the drive. Dynamic braking requires an additional braking resistor kit. Note: Do not order with dynamic braking contact option, contact included in assembly.

**1 TO 100 HP**

Horsepower		
240Vdc	500Vdc	Part Number
1 - 7.5	1 - 15	955+ADC30
10 - 15	20 - 30	955+ADC60
20 - 40	40 - 75	955+ADC130
50	100	955+ADC220

**DYNAMIC BRAKING RESISTORS**

The dynamic braking resistor kits are designed for stopping a motor at full load current from base speed with 2 times motor energy, three times in rapid succession (NEMA ICS 3-302.62 dynamic braking stop option). Dynamic braking provides a low initial cost solution when motor braking can be less precise. When braking is required frequently in the application (for example, unwinds), a regenerative drive would be a better solution.

- COMPACT DESIGN**
- ROOF/PANEL MOUNTING**
- HORSEPOWER RATED FOR EASIER SELECTION**
- INTEGRAL COVERS FOR ADDED SAFETY**

240Vdc DB Resistors		
HP	Ohms	Part Number
5	8.6	CZ353160
7.5	6.04	CZ353161
10	4.6	CZ353162
15	3	CZ353163
20	2	CZ353164
25	2	CZ353165
30	1.4	CZ353166
40	1	CZ353167
50	1	CZ353168
60	0.742	CZ353169
75	0.58	CZ353170
100	0.452	CZ353171
125	0.384	CZ353172
150	0.325	CZ353173
200	0.255	CZ353174
250	0.196	CZ353175
300	0.176	CZ353176
400	0.137	CZ353177
500	0.1	CZ353178

500Vdc DB Resistors		
HP	Ohms	Part Number
3	62	CZ353134
5	36	CZ353135
7.5	36	CZ353136
10	20	CZ353137
15	12	CZ353138
20	10	CZ353139
25	7	CZ353140
30	7	CZ353141
40	4.5	CZ353142
50	4.5	CZ353143
60	4	CZ353144
75	2.8	CZ353145
100	2	CZ353146
125	1.71	CZ353147
150	1.28	CZ353148
200	1.11	CZ353149
250	0.768	CZ353150
300	0.72	CZ353151
400	0.504	CZ353152
500	0.38	CZ353153
600	0.38	CZ353154
700	0.288	CZ353155
800	0.23	CZ353156
900	0.23	CZ353157
1000	0.2	CZ353158

**DYNAMIC BRAKING CONTACT**

All 590+ DRVs (except 125 and 250 HP) require a separate dynamic braking contact kit if dynamic braking is required. The kits through 100 HP use a four-pole AC contactor pre-wired to connect to the 590+ terminals. Above 100 HP, kits use a single-pole DC contactor that requires 120Vac control power to close. The dynamic braking contact must be factory installed and requires a larger panel. The dynamic braking contact kits are designed to meet NEMA dynamic braking requirements (see dynamic braking resistors above).

**500VDC RATED  
MEET NEMA DYNAMIC BRAKING STANDARDS**

HP (500Vdc Rated & Meets NEMA Standards)		
240Vdc	500Vdc	Part Number
1 - 10	1 - 20	955+DBC35
15 - 20	30 - 40	955+DBC70
25 - 30	50 - 60	955+DBC110
0 - 50	75 - 100	955+DBC162
150 - 700	300 - 1500	955-DBC2400*
800 - 1000	1750 - 2000	955-DBC3000*

\*Factory installed option only.



Options for 590+ Series	Part Number
Remote mounting and bezel and lead	6052
<b>Communication and Technology Box</b>	
Standard	P3 port for 5703/1
Profibus	6055/PROF/00
Modbus/RS422/RS485/EIBisynch	6055/E100/00
LINK	6055/LINK/00
DeviceNet	6055/DNET/00
ControlNet	6055/CNET/00
CanOpen	6055/CAN/00
Ethernet	6055/ENET/00
P3 port for 5703/1	Standard
<b>Speed Feedback Technology Box</b>	
Analog Tachometer (included)	AH385870U001
Encoder feedback 5Vdc	AH387775U005
Encoder feedback 12Vdc	AH387775U012
Encoder feedback 15Vdc	AH387775U015
Encoder feedback 24Vdc	AH387775U024
Microtach feedback for acrylic fiber	AH386025U002
Microtach feedback for glass fiber	AH386025U001

**INTERNATIONAL STANDARDS**

**Conforms to EC Directive 89/336/EEC in compliance with standard:**

- EN61800-3 (Environment 1 and 2 with external filter)

**Conforms to EC Directive 73/23/EEC in compliance with standard:**

- EN50178 (Low Voltage)

**Complies with UL508C safety standards**



EMC Filters	P. 43
Line Reactors	P. 44
Programming Software	P. 52

**LINK**

# LINK- Fiber Optic Based Drive Control System



## DESCRIPTION

Link 2 (evolved from LINK launched in 1990) is a multitask distributed control system that enables motor speed regulation by means of drives, input devices and operator interfaces, all interconnected via fiber optic cable, which replaces traditional signal copper multiple cables (50% saving in wiring time and cost compared to the standard system) and is immune from any electromagnetic disturbance or interference. This feature, together with distributed control system (each LINK unit is equipped with its own microprocessor and RAM) at high speed communication (2.7 MBaud, event-driven) allows the hardware to be placed in the most convenient position (DCS).

Each LINK system may comprise any combination of closed/open loop inverter (690P Series) and DC drives (590+ Series), digital and analog I/O modules, communication interfaces with most Fieldbus protocols available on the market. It also includes DDE Interface that is supported by most SCADA supervision software packages for an integrated process control that ensures a high quality standard of the final product.

The most important parts of a LINK2 control system are described below. Other interface and components are available, which contribute to making LINK2 the world's most flexible control system. Please contact Parker SSD Drive Engineering Department to discuss your application in detail.

### SUITABLE FOR AC AND DC DRIVES

### TOTAL CONFIGURABILITY FOR THE MOST ADVANCED MULTI-DRIVE SYSTEMS

### HIGH SPEED, NOISE IMMUNE FIBER OPTIC

### FIELDBUS INTEGRATION

### REMOTE ASSISTANCE AND PROGRAMMING

### REAL TIME PEER-TO-PEER COMMUNICATION

### L5300 LinkRack

The L5300 is a processor and memory unit with 85–265Vac power supply, designed to accommodate up to 4 plug-in modules. Rear connection allows direct panel or DIN rail mounting.

### L5392 LinkStation

The operator station L5392 is a color LCD touchscreen with processor and memory, powered by 85–265Vac, and designed to accommodate up to 4 plug-in modules in the rear of the unit. The operator screens are configurable into 6 bands, with any of the following combinations:

- Operator pushbuttons, each of them independently configurable
- Digital ramps for setting reference and feedback variables
- Variable display indicators
- Machine state and alarm indicators



**L5331 - Digital I/O LINKCard**

The L5331 module provides 16 x 24V digital input/output channels. Each channel can be independently configured as an input or output. All terminals are plug-in type and easily accessible on the front of the module, and have LED indication of "ON" state. High speed inputs for encoder or pulsecounter are also available.

**L5341 - Analog I/O LINKCard**

The L5341 module has 8 analog inputs and 2 analog outputs. Each channel is bipolar with a 14bit (13bit + sign) resolution. The ±10V power supply outputs enable use with external devices, including potentiometers and transducers. All terminals are plug-in type.

**L5311 - RTN [Fiberoptic] LINKCard**

The L5311 module has the task of transmitting and receiving via fiber optic all signals coming from the other units of the LINK system, thus integrating the unit in the network at 2.7Mbaud.

**L5351 - DeviceNet LINKCard**

The L5351 module enables LINK system to interface to a DeviceNet based system.

**L5352 - Ethernet LINKCard**

The L5352 module enables LINK system to interface to an Ethernet based system.

**L5312 - FireWire LINKCard**

The L5312 module enables LINK system to interface to a FireWire based system.

**L5353 - Profibus LINKCard**

The L5353 module enables LINK system to interface to a Profibus based system.

**L5354 - ControlNet LINKCard**

The L5354 module enables LINK system to interface to a ControlNet based system.



**L5201 - Remote Analog I/O Unit**

The L5201 is a remote independent module, providing 5 analog inputs and 1 analog output plus fiber optic interface. Particularly suitable for machine mounting.

**L5202 - Remote Digital I/O Unit**

The L5202 is a remote independent module, providing 12 digital 24V inputs or outputs, independently configurable, plus fiber optic interface. Particularly suitable for machine mounting.

**DRIVE SYSTEM DESIGNER – Revolutionary System of Software Design**

Drive System Designer (DSD) is the configuration software of LINK systems. Owing to its exclusive Autoconfigure function, all speed controls are automatically carried out by entering basic drive/process data only.



**LINK**

# DSE890

This is the "online" programming, monitoring and diagnostic software platform for AC890 Series frequency converters.

PC and converter communicate via Mini USB port and, by chain supplying the 24Vdc auxiliaries of the various 890 units, it is possible to configure the entire system from a single location via FireWire1394. Thanks to the on-line help, users can obtain the optimum drives configuration without need to navigate through complicated parameter menus. Advanced programming is carried out through a set of pre-engineered templates in order to create the required configuration.

During drive operation, it is possible to monitor every parameter either as a digital value or as a function in the "Chart Recorder".

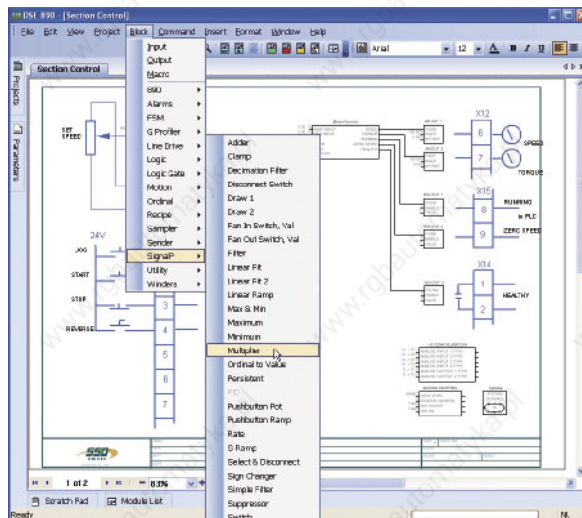

- CREATES, INSTALLS AND MODIFIES CONFIGURATIONS**
- DRAG-AND-DROP ICON STRUCTURE**
- GRAPHICAL INTERFACE**
- DATA LOGGING**
- COMPATIBLE WITH WINDOWS XP**

Part Number	Description
DSE890 RUN-TIME	Programming software package including USB cable and license. Runtime Version
DSE890 DEVELOPMENT	Programming software package including USB cable and license. Development Version
Options	
CM471050	USB programming cable

### System Requirements

- PC with Pentium™ III processor or later
- Minimum resolution 800 x 600
- Minimum 64MB RAM installed
- OS Microsoft® Windows XP
- USB port for connection with drive
- Mouse or other similar device

### Requirements for updating

- Internet connection to download updates from our site [www.SSDdrives.com](http://www.SSDdrives.com)



# DSI8000

The DSI8000 is a powerful set of icon-based, configuration, display, control and data logging tools uniquely designed to take full advantage of the TS8000 series architecture. Most applications can be quickly set up using a step-by-step process to configure communications protocols, define data tags, and create a user-friendly interface. A full complement of drag and drop graphical symbols yield professional results in record time. Advanced features such as programming, data logging, and the configuration of the TS8000's web server are intuitive and easily enabled. Also, ask about our Pre-engineered templates!

- CREATES, INSTALLS AND MODIFIES CONFIGURATIONS**
- DRAG-AND-DROP ICON STRUCTURE**
- GRAPHICAL INTERFACE**
- DATA LOGGING**
- WEB SERVER**
- COMPATIBLE WITH WINDOWS 2000/XP**

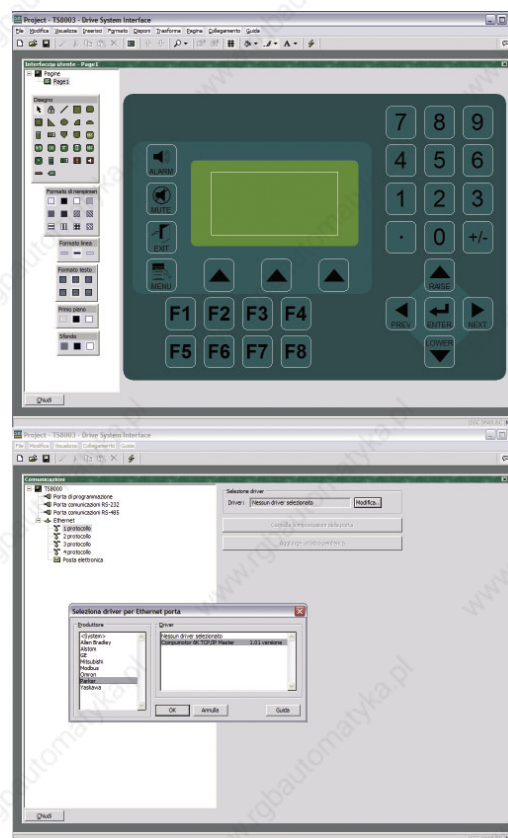

Part Number	Description
DSI 8000	Programming software package includes all cables and licenses

### System requirements

- PC with Pentium™ III processor or later
- Minimum resolution 800 x 600
- Minimum 64MB RAM installed
- OS Microsoft® Windows 2000, Windows XP
- USB port for connection to TS8000
- Mouse or other similar device

### Requirements for updating

- Internet connection to download updates from our site [www.SSDdrives.com](http://www.SSDdrives.com)

**SOFTWARE**

# ConfigEd Lite

ConfigEd Lite is a graphical interface software used to configure off-line all Parker SSD Drives inverters and 590+ Series converters.

Drive programming is simplified by basic function blocks that can be configured and interconnected in order to create the required configuration. Pre-configured macros allow users to adapt the drive to various types of applications.

Once completed, the configuration is installed into the drive via serial port by means of the cable supplied with the package.

- CREATES, INSTALLS, MODIFIES AND RETRIEVES CONFIGURATIONS**
- POWERFUL AND VERSATILE FUNCTION BLOCKS**
- GRAPHICAL INTERFACE**
- PRE-CONFIGURED MACRO**
- COMPATIBLE WITH WINDOWS 9X/ME/2000/NT/XP**

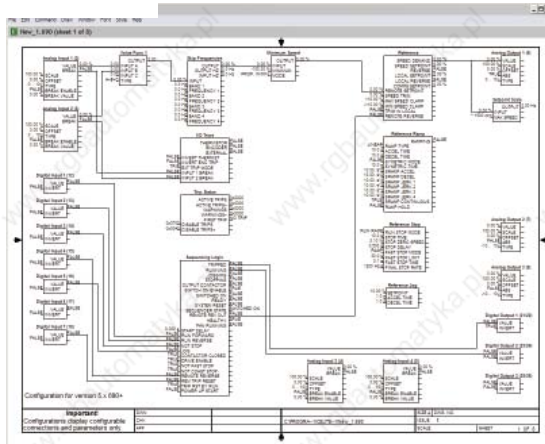

Part Number	Description
402-NU5	Programming software package including CM351909 cable and license
<b>Options</b>	
CM351909	3m standard cable, for connection to PC Drive connection and Adapter DB9-RJ11

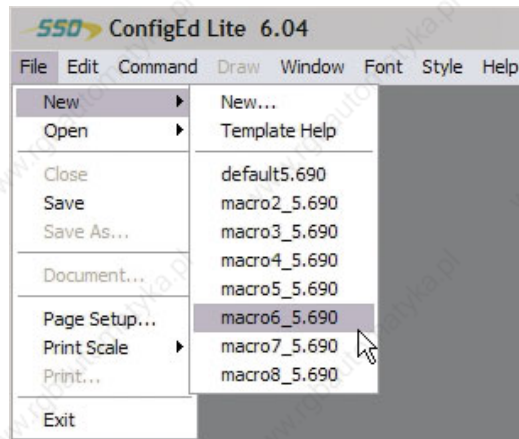

### System requirements

- PC with Pentium™ processor or later
- Minimum resolution 800 x 600
- Minimum 32MB of RAM installed
- OS Microsoft® Windows 9X/ME, Windows NT, Windows 2000, Windows XP
- Serial port for connection to P3 port on drive
- Mouse or other similar device

### Requirements for updating

- Internet connection to download updates from our site [www.SSDdrives.com](http://www.SSDdrives.com)

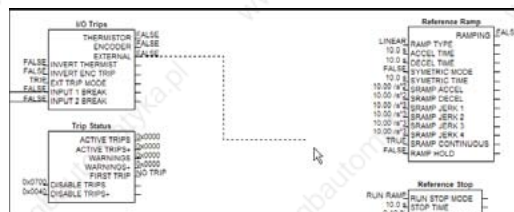

# ConfigEd Lite Plus

ConfigEd Lite Plus is the software for on-line programming, parameter setting, monitoring and troubleshooting 650V and 690+ Series inverters and 590+ Series converters.

With its guided startup procedure, users can configure the drive with few simple steps, thus obtaining best performance without need to navigate through complicated parameter menus.

During drive operation, it is possible to monitor every parameter either as a digital value or as a function in the "Chart Recorder".

Advanced programming is carried out through a set of pre-engineered templates in order to create the required configuration.

## BUILT-IN STARTUP FUNCTION

## ON-LINE PROGRAMMING AND TROUBLESHOOTING

## 4-CHANNEL CHART RECORDER

## POWERFUL AND VERSATILE FUNCTION BLOCKS

## PRE-CONFIGURED MACROS

## COMPATIBLE WITH WINDOWS 98/ME/2000/NT/XP

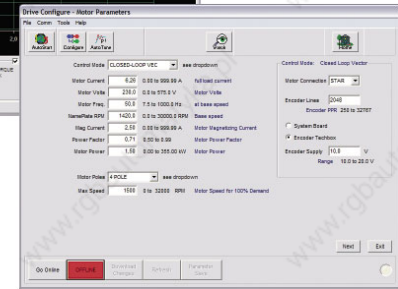
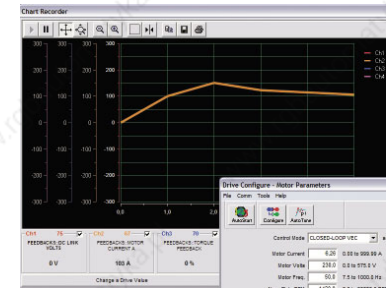
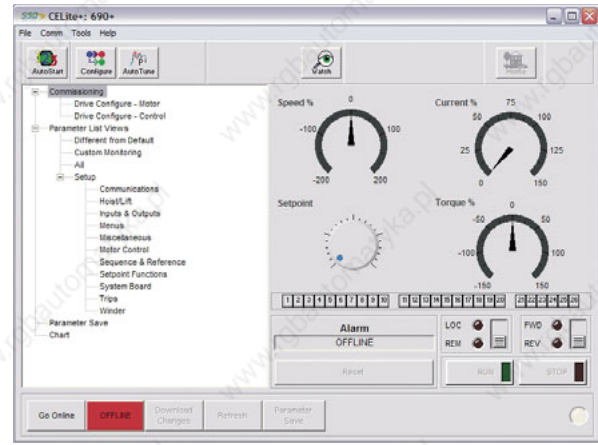

Part Number	Description
CEL+NU1	Programming software package with license
<b>Options</b>	
CM351909	3m standard cable, for connection to PC Drive connection and Adapter DB9-RJ11

## System requirements

- PC with Pentium™ II 233MHz processor or later
- Minimum resolution 800 x 600
- Minimum 32MB RAM installed
- OS Microsoft® Windows 98/ME, Windows NT, Windows 2000, Windows XP
- Internet Explorer 4.01 or later (for DHTML applications)
- Serial port for connection to P3 port of the drive
- Mouse or other similar device

## Requirements for updating

- Internet connection to download updates from our site [www.SSDrives.com](http://www.SSDrives.com)

**SOFTWARE**

# DSD - Drive System Designer

Drive System Designer (DSD) is a software package used to configure LINK systems. DSD employs a graphical interface and configurable function blocks that offer unlimited, interconnectable control schemes to create the desired configuration.

The full package includes the Auto Configure option, a powerful software that enables the user to configure a multi-drive system with an exclusive guided procedure. Starting from a simple diagram of the line, machine or process, users can set the various parameters (line speed, tension, etc.) and functions (winder, taper, dancer, etc.) for each motor, then the software will automatically configure the complete system based on the user inputs.

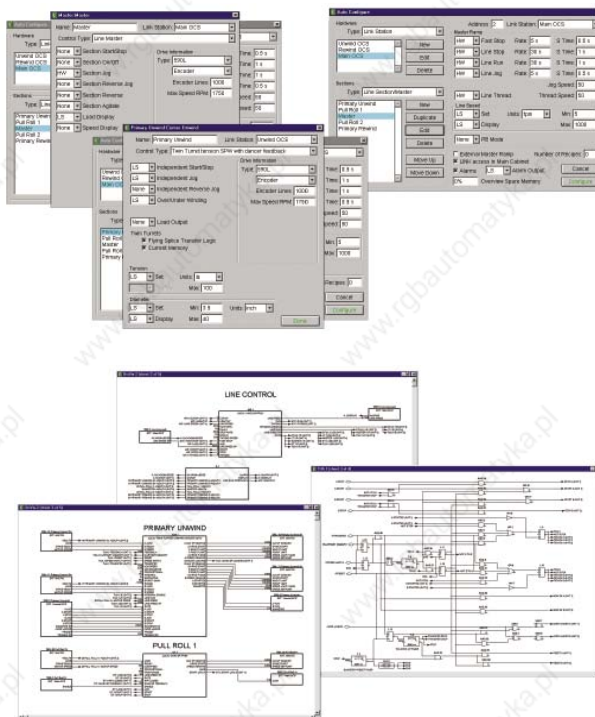

- REMOTE ASSISTANCE VIA MODEM
- MULTIDRIVE SYSTEM CONFIGURATION
- LINK SYSTEM CONFIGURATION
- ON-LINE PROGRAMMING AND TROUBLESHOOTING
- GRAPHICAL INTERFACE
- COMPATIBLE WITH WINDOWS 98/ME/2000/NT/XP

Part Number	Description
DSD RUN-TIME	Programming software package with CM353470 cable and license Runtime Version - LINK™ system monitoring
DSD DEVELOPMENT	Programming software package with CM353470 cable and license Development Version - Development and configuration of LINK™ systems
DSD AUTOCONFIGURE	Programming software package with hardware key, CM353470 cable and license Autoconfigure Version - Development and standard or guided configuration of LINK™ systems
DSD UPD	Drive System Designer update
<b>Options</b>	
CM353470	3m standard cable with connectors for PC/Insulator → Drive/Link connection and Surge Adapter DB9-RJ11

### System requirements

- PC with Pentium™ II 233MHz or later
- Minimum resolution 800 x 600
- Minimum 32 MB RAM installed
- OS Microsoft® Windows 9X/ME, Windows NT, Windows 2000, Windows XP
- Serial port for connection to the servodrive P3 port
- Mouse or other similar device

### Requirements for updating

- Internet connection for downloading updates from our site [www.SSDrives.com](http://www.SSDrives.com) (by subscription only)



## Training Classes

To improve your knowledge of how to install and program our products, and optimize their performance in your applications, we offer specific training courses.

### C-225 Digital DC Drives

*Covers all SSD Drives Digital DC Series Drives*

- DC Motors and Controls
- 590+ Series Overview
- MMI and Parameter Structure
- Block Diagram Configuration
- CE Lite Software
- Troubleshooting



### C-235 Digital AC/Vector Drives

*Covers Standard SSD Drives AC Controllers*

- AC Motor and Controls
- 650 & 690+ Series Overview
- Hardware Options
- MMI and Parameter Structure
- CE Lite Software
- Troubleshooting

### C-236 890/DSE Advanced AC Drives

*Covers the New 890 AC Controller*

- AC Motors
- 890 Series Overview
- Hardware
- MMI and Parameter Structure
- CE Lite Software
- Troubleshooting

### C-241 DSD Runtime & LINK Fundamentals

*Maintenance Level Class Focuses on Supporting an Existing LINK System*

- LINK Overview
- LINK Hardware
- LINK Drives MMI and Parameter Structure
- DSD Runtime—LINK Graphical Configuration Software

### C-242 DSD Development & LINK Fundamentals

*Engineering Level Class Focuses on Designing New LINK Systems*

- LINK Overview
- LINK Hardware
- LINK Drives MMI and Parameter Structure
- Design with LINK Function Blocks
- LINK Graphical Configuration Software—DSD Development

### C-243 Communications/Advanced Applications

*Using Communication Gateways and Advanced LINK Function Blocks*

- DeviceNet
- ProfiBus
- ControlNet
- ModBus
- EtherNet
- Winders

### C-250 TS8000 HMI Programming

*Using Communication Gateways and Advanced LINK Function Blocks*

- DSI Software
- HMI Basics
- Scripting
- Tags
- Communications
- Logging and Trending

# OTHER PRODUCTS FROM PARKER AUTOMATION

## USA



### Human-Machine Interface and Integrated Machine Control CTC

Tel: (513) 831 2340  
(800) 233 3329  
Fax: (513) 831 5042



### Servo and Stepper Motion Control Systems Compumotor

Tel: (707) 584 7558  
(800) 358 9070  
Fax: (707) 584 2446



### Rotary and Linear Servo Motors Custom Servo Motor

Tel: (507) 354 1616  
(866) 506 3573  
Fax: (507) 354 1611

### Trilogy

Tel: (281) 226 7750  
Fax: (281) 226 7760



### Electromechanical Positioning Systems Daedal

Tel: (724) 861 8200  
(800) 245 6903  
Fax: (724) 861 3330



### Electromechanical Actuator Products Actuator Division

Tel: (330) 336 3511  
Fax: (330) 336 3335



### Electromechanical Gearheads Bayside

Tel: (516) 484 5353  
(800) 305 4555  
Fax: (516) 629 8000

## International Electromechanical Locations

### Parker Hannifin plc DIGIPLAN England

Tel: 44 (0) 1202 69 9000  
Fax: 44 (0) 1202 69 5750

### Parker Hannifin GmbH Hauser Germany

Tel: 49 (0) 781 509 0  
Fax: 49 (0) 781 509 176

### Parker Hannifin SpA SBC Italy

Tel: 39 02 6601 2478  
Fax: 39 02 6601 2808

### Parker Hannifin Hong Kong Ltd. Tel: 852 2428 8008 Fax: 852 2480 4256

### Parker Hannifin Singapore Pte Ltd. Tel: 65 261 5233 Fax: 65 265 5125

### Parker Hannifin Korea Ltd. Tel: 82 31 379 2200 Fax: 82 31 377 9710

### Parker Hannifin Taiwan Co. Ltd. Tel: 886 2 8787 3780 Fax: 886 2 8787 3782



anything  Possible.™

**Parker Hannifin Corporation**  
Electromechanical Automation Div.  
6035 Parkland Blvd.  
Cleveland, OH 44124  
Tel: (800) 358 9068  
[www.parkermotion.com](http://www.parkermotion.com)  
Email: [emn\\_sales@parker.com](mailto:emn_sales@parker.com)  
[emn\\_support@parker.com](mailto:emn_support@parker.com)

**UK****SSD Drives Ltd**

New Courtwick Lane  
Littlehampton  
West Sussex BN17 7RZ  
Tel: +44 (0)1903 737000  
Fax: +44 (0)1903 737100

**DENMARK****SSD Drives AB**

Enghavevej 11  
DK-7100  
Veile  
Tel: +45 (0)70 201311  
Fax: +45 (0)70 201312

**ITALY****SSD Drives SPA**

Via Gran Sasso 9  
20030 Lentate Sul Seveso  
Milano  
Tel: +39 (0362) 557308  
Fax: +39 (0362) 557312

**CANADA****SSD Drives Inc.**

4391 Harvester Road, Unit #1  
Burlington  
Ontario L7L 4X1  
Tel: +1 (905) 333 7787  
Fax: +1 (905) 632 0107

**FRANCE****SSD Drives SAS**

15 Avenue de Norvège  
Villebon sur Yvette  
F-91953 Courtaboeuf Cedex  
Paris  
Tel: +33 - 1 69 18 51 51  
Fax: +33 - 1 69 18 51 59

**SWEDEN****SSD Drives AB**

Montörgaten 7, SE-302 60  
Halmstad  
Tel: +46 (0)35-17 73 00  
Fax: +46 (0)35-10 84 07

**CHINA****SSD Drives Ltd**

Room 1603, Hua Teng Edifice  
302# Jin Song San Qu  
Chaoyang District,  
Beijing 100021  
P.R. China

**GERMANY****SSD Drives GmbH**

Von-Humboldt-Strasse 10  
64646 Heppenheim  
Tel: +49 (6252) 798200  
Fax: +49 (6252) 798205

**U.S.A.****SSD Drives Inc.**

9225 Forsyth Park Drive  
Charlotte, North Carolina  
28273  
Tel: +1 (704) 588 3246  
Fax: +1 (704) 588 3249

*Local availability and service support also in:*

ARGENTINA • AUSTRALIA • AUSTRIA • BANGLADESH • BELGIUM • BRAZIL • CHILE • COLOMBIA • COSTA RICA • CROATIA  
• CYPRUS • CZECH REPUBLIC • DENMARK • ECUADOR • EGYPT • GREECE • HONG KONG • HUNGARY • ICELAND • INDIA  
• INDONESIA • IRAN • IRELAND • ISRAEL • JAPAN • JORDAN • KENYA • KOREA • KUWAIT • LITHUANIA • MALAYSIA  
• MEXICO • MOLDOVA • MOROCCO • NETHERLANDS • NEW ZEALAND • NIGERIA • NORWAY • PERU • PHILIPPINES  
• POLAND • PORTUGAL • ROMANIA • SAUDI ARABIA • SINGAPORE • SLOVAKIA • SLOVENIA • SOUTH AFRICA • SPAIN  
• SRI LANKA • SWITZERLAND • TAIWAN • THAILAND • TURKEY • UNITED ARAB EMIRATES • UKRAINE • VIETNAM

Local address:



[www.SSDdrives.com](http://www.SSDdrives.com)