

## SINUMERIK 880 Software Versions 1/2/3/4/5/6 Installation Instructions

Installation Guide

11.91 Edition

Service Documentation

**General Documentation**

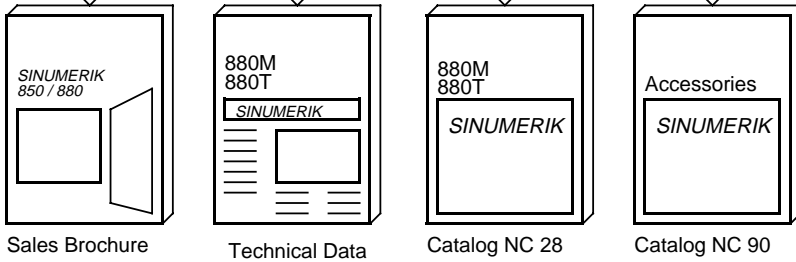

**User Documentation**

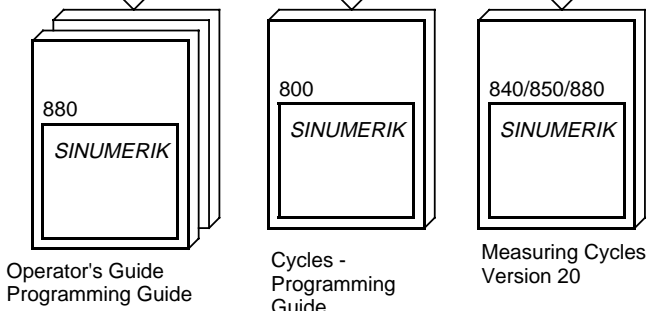

**User/Manufacturer/Service Documentation**

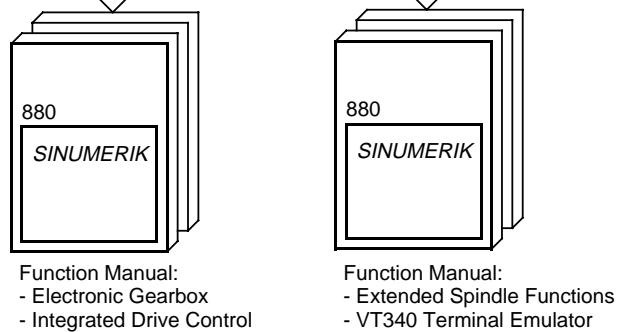

**Manufacturer Documentation**

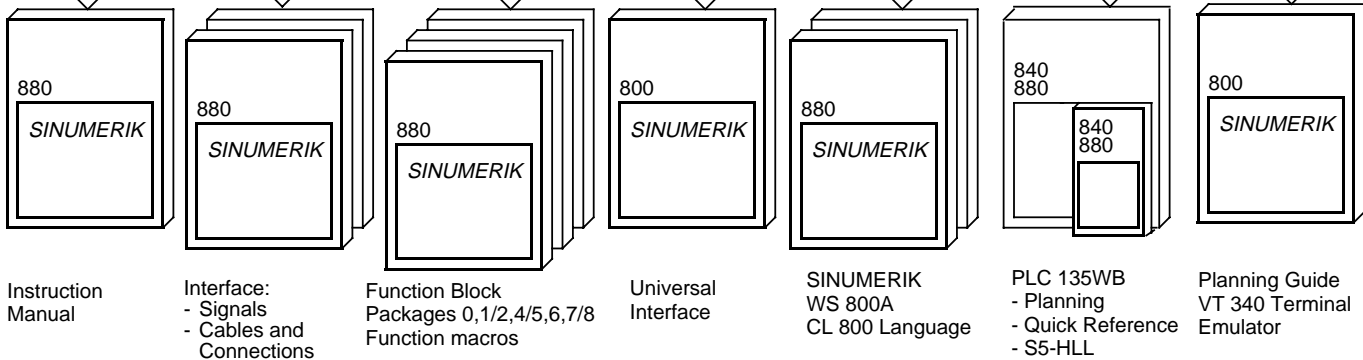

**Hersteller-Dokumentation**

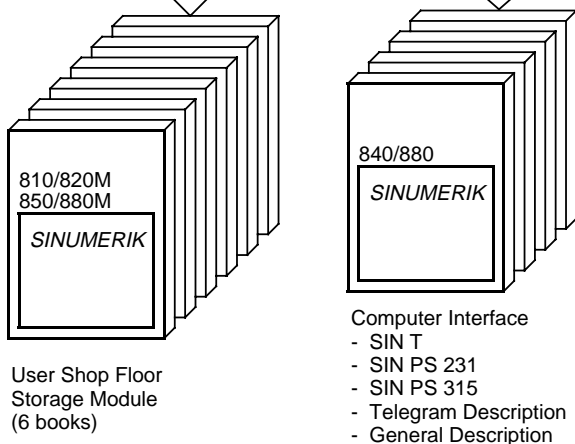

**Service-Dokumentation**

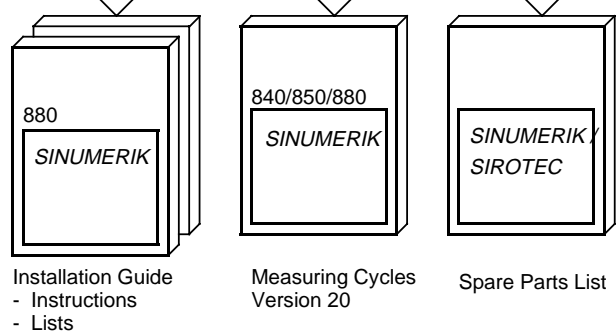

# **SINUMERIK 880 Software Versions 1/2/3/4/5/6 Installation Instructions**

**Installation Guide**

**Service Documentation**

**Valid for:**

<i>Control</i>	<i>Software Version</i>
SINUMERIK 880M/880ME	1, 2, 3, 4, 5 and 6
SINUMERIK 880N/880NE	4
SINUMERIK 880T/880TE	1, 2, 3, 4, 5 and 6

**November 1991 Edition**

**Printing history**

Brief details of this edition and previous editions are listed below.

The status of each edition is shown by the code in the "Remarks" column.

*Status code in "Remarks" column:*

- A** . . . New documentation.
- B** . . . Unrevised reprint with new Order No.
- C** . . . Revised edition with new status.  
If factual changes have been made on the page since the last edition, this is indicated by a new edition coding in the header on that page.

<b>Edition</b>	<b>Order No.</b>	<b>Remarks</b>
08.89	6ZB5 410-0CP02-0AA0	<b>C</b>
09.90	6ZB5 410-0CP02-0AA2	<b>C</b>
11.91	6ZB5 410-0CP02-0AA3	<b>C</b>

Other functions not described in this documentation might be executable in the control. This does not, however, represent an obligation to supply such functions with a new control or when servicing.

This publication was produced on the Siemens 5800 Office System.  
Subject to change without prior notice.

The reproduction, transmission or use of this document or its contents is not permitted without express written authority. Offenders will be liable for damages. All rights, including rights created by patent grant or registration of a utility model or design, are reserved.

# Preliminary Remarks

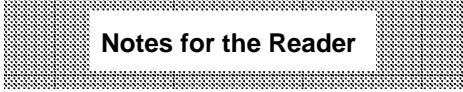
A rectangular box with a halftone background pattern. Inside the box, the text "Notes for the Reader" is centered in a bold, sans-serif font.

## Notes for the Reader

The SINUMERIK 880 Installation Guide is subdivided into two separate manuals:

- Installation Instructions
- Installation Lists

The "Installation Instructions" discuss the installation and start-up procedures, from installation of the system through to the testing of the most important functions.

The supplementary manual, which is entitled "SINUMERIK 880, Installation Lists", provides additional aids in the form of lists and detailed information on NC and PLC machine data and setting data as well as lists of control and programmer alarms.

The installation instructions and lists apply to a specific software version only. A new installation guide is required for each new software version. Old installation guides can be used only in part for new software versions.

Preconditions and Visual Inspection	1
Installation Checklist	2
Drive Optimization	3
Overview of Modules and Standard Jumperings	4
Voltage and Functional Tests	5
Standard Installation Sequence	6
PLC 135 WB Description	7
Machine Interface	8
NC Machine Data/PLC Machine Data/ NC Setting Data	9
Machine Operation / Service Data	10
Function Description	11
Alarms	12
Notes on Fault Procedure	13
Lists of Abbreviations	14

# Contents

	Page
<b>1</b>	<b>Preconditions and Visual Inspection</b> . . . . . 1-1
1.1	Preconditions . . . . . 1-1
1.2	Visual inspection . . . . . 1-1
1.2.1	Notes on handling modules . . . . . 1-1
1.2.2	Earthing . . . . . 1-2
1.2.3	Position encoders . . . . . 1-4
1.2.4	Cable laying . . . . . 1-4
1.2.5	Cables . . . . . 1-4
1.2.6	Shielding . . . . . 1-4
1.2.7	Interference suppression . . . . . 1-4
1.2.8	Operator panel . . . . . 1-5
1.2.9	Overall condition . . . . . 1-5
1.2.10	Batteries . . . . . 1-5
1.3	Export version . . . . . 1-6
1.4	Export version for China (Software Version 3 only) . . . . . 1-6
<b>2</b>	<b>Installation Checklist</b> . . . . . 2-1
2.1	Incompatibility . . . . . 2-4
2.2	Conversion sequence . . . . . 2-5
<b>3</b>	<b>Drive Optimization</b> . . . . . 3-1
3.1	Direct control of feed axes - checking and adjustment . . . . . 3-1
3.2	Definition of maximum setpoint and tachogenerator compensation . . . . . 3-3
3.3	Multigain factor NC MD 260* . . . . . 3-4
3.4	Servo gain factor ( $K_v$ factor) . . . . . 3-5
3.5	Acceleration NC MD 276* . . . . . 3-7
3.6	Position monitoring . . . . . 3-9
3.6.1	Exact stop limit coarse and fine (NC MD 204* to 208*) . . . . . 3-9
3.6.2	Clamping tolerance (NC MD 212*) . . . . . 3-9
3.6.3	Zero speed control . . . . . 3-9
3.7	Contour control . . . . . 3-10

<b>4</b>	<b>Overview of Modules and Standard Jumperings</b>	4-1
4.1	Overview of modules	4-1
4.1.1	Operator panel module locations	4-3
4.1.2	Central controller module location	4-4
4.2	Power supply units	4-6
4.2.1	6EW1 861-2A. power supply unit (in central controller for two-tier racks) and 6EW1 861-2B. power supply unit (in central controller for single-tier racks)	4-6
4.2.2	6EW1 861-3AA power supply unit (in operator panel)	4-9
4.3	CPU modules	4-11
4.3.1	6FX1 120-4BB02 communications CPU (COM CPU) and operator panel CPU (BT CPU)	4-11
4.3.2	6FX1 120-5BB NC CPU	4-13
4.3.3	6FX1 121-3BA SERVO CPU	4-14
4.3.4	6FX1 120-6BA PLC CPU	4-15
4.3.5	6FX1 121-8BC or 6FX1 136-8BA multiport	4-16
4.3.6	6FX1 124-0BA dualport	4-20
4.3.7	6FX1 128-1BB memory module	4-21
4.3.8	6FX1 126-7BA memory module	4-21
4.4	EPROM/RAM submodule	4-22
4.4.1	6FX1 128-4B. EPROM submodule	4-22
4.4.2	6FX1 126-0B. EPROM-RAM submodule	4-23
4.4.3	6FX1 135-3BA00 submodule (SMD)	4-24
4.4.4	6FX1 126-6BA submodule (SMD)	4-24
4.4.5	6FX1 126-6BB00 submodule (SMD)	4-25
4.4.6	6FX1 134-2BA01 RAM submodule (128kB) 6FX1 134-2BC01 RAM submodule (without battery)	4-25
4.5	6FX1 121-4B. measuring circuit module	4-26
4.6	Fast input/outputs in the servo area (SINUMERIK 880N only)	4-30
4.6.1	Mixed I/O module	4-30
4.6.2	INPUT module 6FX1125-7BA00 (257)	4-33
4.6.3	OUTPUT module 6FX1122-8BA01 (228)	4-34
4.7	6FX1 121-2BB02 interface module	4-35
4.8	6FX1 126-1AA03 video module	4-36
4.9	6FX1 126-4AA colour image memory	4-38
4.10	Colour monitor	4-38
4.11	6FX1 124-6AA02 input/output module	4-41
4.12	6FX1 125-7BA input module	4-42
4.13	6FX1 122-8B output module	4-44
4.14	6FX1 126-5AA.. interface submodule for electronic handwheels	4-46
4.15	Machine control panel	4-47
4.16	32-bit servo CPU	4-48
4.17	Memory submodule for 32-bit servo CPU	4-48
4.18	HMS measuring circuit module (High-resolution Measuring system)	4-49
4.19	I/V hybrid (I/V: Current/voltage conversion)	4-49
4.20	ACC (Analog Current Control) printed circuit board	4-51
4.21	SIPOS incremental encoder	4-51
4.22	SIPOS absolute encoder	4-51
4.23	Jumpering module	4-52
4.24	Enables and evaluations on the jumpering module	4-52



<b>5</b>	<b>Voltage and Functional Tests</b>	5-1
5.1	Voltage test	5-1
5.1.1	Voltage supply	5-1
5.1.2	Limit temperature	5-2
5.1.3	Fan monitoring	5-2
5.1.4	Direct voltage+ 5V	5-3
5.1.5	Direct voltage + 5V external	5-3
5.2	Functional test	5-5
5.2.1	CPU monitor	5-5
5.2.2	EPROM check	5-5
5.2.3	Brightness adjustment	5-7
5.3	Drift compensation (from Software Version 03)	5-8
<b>6</b>	<b>Standard Installation Sequence</b>	6-1
6.1	Standard installation shown as a flowchart	6-2
6.1.1	NC ON (overall reset chart and setting standard NC MD)	6-3
6.1.2	NC machine data	6-4
6.1.3	PLC machine data	6-5
6.1.4	Alarm processing	6-6
6.1.5	Axis installation (simplified flowchart)	6-7
6.1.6	Spindle installation	6-8
<b>7</b>	<b>135 WB PLC Description</b>	7-1
7.1	General	7-1
7.2	Installation	7-2
7.2.1	Self-diagnostics program	7-2
7.2.2	System initialization program	7-3
7.2.3	Timeout analysis	7-4
7.2.4	Error list for PLC 135 WB	7-4
7.2.5	PLC-PG 685/PG 750 link	7-5
7.3	Installation of the 135 WB PLC	7-6
7.4	PLC DIAGNOSTICS	7-7
7.5	PLC STATUS	7-8
7.5.1	Operation of PLC STATUS	7-8
7.5.2	PLC STATUS selection	7-9
7.6	135 W PLC description	7-10
7.6.1	General	7-10
7.6.2	Installation of the 135 W PLC	7-10
7.6.3	Operator input	7-10

<b>8</b>	<b>Machine Interface</b>	8-1
8.1	Actual-value input measuring circuit (6FX1121-4B.. module)	8-1
8.1.1	Connector pin assignments	8-1
8.1.2	Differential input	8-2
8.1.3	Equivalent circuit diagram with differential input	8-3
8.1.4	Equivalent circuit diagram for actual-value input with integrated EXE	8-4
8.1.5	Complement with integrated EXE	8-5
8.1.6	Input signals with integrated EXE	8-6
8.1.7	Diagnostics help on the ACC board	8-7
8.2	Setpoint output measuring circuit (6FX1121-4B.. module)	8-9
8.2.1	Connector pin assignments	8-9
8.2.2	Equivalent circuit diagram of the set speed output (for one axis)	8-10
8.3	Serial interface (V.24 (RS 232C) + 20 mA)	8-11
8.4	Handwheel interface module (6FX1 126-5AA..)	8-12
8.4.1	Connector pin assignments	8-12
8.4.2	Equivalent circuit diagram	8-12
8.5	Short-circuiting connector for actual-value input	8-13
8.6	Measuring pulse inputs (sensors)	8-13
<b>9</b>	<b>NC Machine Data/PLC Machine Data/NC Setting Data</b>	9-1
9.1	General	9-1
9.1.1	Control configuration	9-1
9.1.2	Notes on configuration	9-4
9.2	Mode selection	9-7
9.2.1	Installation mode "INITIAL CLEAR"	9-8
9.2.2	Normal mode (with MD modification)	9-10
9.2.3	Installation mode	9-12
9.3	NC machine data	9-12
9.3.1	General	9-12
9.3.2	Position control, input and measuring system resolution	9-13
9.3.3	Input units	9-14
9.3.4	Other machine data	9-15
9.3.5	NC MD description	9-15
9.3.5.1	General values	9-16
9.3.5.2	Channel-specific values	9-89
9.3.5.3	Axis-specific values/spindle-specific values	9-94
9.3.5.4	Machine data bits	9-182
9.4	PLC machine data	9-268
9.4.1	General	9-268
9.4.2	PLC MD description	9-270
9.4.2.1	PLC machine data for the operating system	9-270
9.4.2.2	PLC MD for function blocks	9-284
9.4.2.3	PLC MD for user	9-284
9.4.3	PLC MD bits	9-285
9.4.3.1	PLC MD bits for operating system (DB 63)	9-288
9.4.3.2	General PLC MD bits	9-310
9.4.3.3	PLC MD bits for function blocks (DB 64)	9-316
9.4.3.4	PLC MD bits for user (DB65)	9-320
9.5	NC machine data and IAR machine data when using integrated drive control	9-321
9.5.1	New or modified NC machine data	9-322

9.5.2	New or modified NC machine data bits .....	9-323
9.5.3	New IAR machine data .....	9-324
9.5.4	New IAR machine data bits .....	9-326
9.6	Cycle machine data (Cycle MD) .....	9-327
9.7	NC setting data (SD) .....	9-329
9.7.1	General .....	9-329
9.7.2	Zero offsets (ZO) .....	9-330
9.7.3	R parameters .....	9-331
9.7.4	Spindle setting data .....	9-332
9.7.5	Setting data for the synchronous mode .....	9-333
9.7.6	General NC setting data .....	9-335
9.7.7	Channel-specific NC setting data .....	9-335
9.7.8	Axial NC setting data .....	9-335
9.7.9	Spindle-specific setting data .....	9-336
9.7.10	General NC setting data .....	9-338
9.7.11	Setting data bits for the synchronous mode .....	9-339
9.7.12	NC setting data bits for serial interfaces .....	9-342
9.7.13	Channel-specific NC setting bits .....	9-346
9.7.14	Axial NC setting data bits .....	9-347
9.8	Cycle setting (cycle SD) .....	9-348
<b>10</b>	<b>Machine Operation/Service Data .....</b>	<b>10-1</b>
10.1	Jog mode .....	10-1
10.2	Programmed operation .....	10-2
10.3	Functional test with NC test tape .....	10-2
10.4	Axis and spindle service data .....	10-3
10.4.1	Axis service data .....	10-3
10.4.2	Spindle service data .....	10-4
<b>11</b>	<b>Function Description .....</b>	<b>11-1</b>
11.1	Axis movements (available soon) .....	11-1
11.2	Spindle control .....	11-1
11.2.1	Corresponding data .....	11-1
11.2.2	S analog (M3, M4, M5) .....	11-1
11.2.3	M19 (oriented spindle stop) .....	11-2
11.2.4	Spindle influencing by PLC .....	11-10
11.3	Approach to reference point .....	11-12
11.3.1	Corresponding MD .....	11-12
11.3.2	Automatic identification of direction with approach to reference point .....	11-12
11.3.2.1	Approach to reference point without automatic identification of direction .....	11-12
11.3.2.2	Approach to reference point with automatic identification of direction .....	11-15
11.3.3	Reference point approach via program .....	11-17
11.4	Leadscrew error compensation .....	11-17
11.4.1	Corresponding data .....	11-17
11.4.2	Function description .....	11-18
11.5	Rotary axis functions .....	11-26
11.5.1	Corresponding data .....	11-26
11.5.2	Function description .....	11-26
11.6	Warm restart .....	11-28

11.6.1	Corresponding data .....	11-28
11.6.2	Function description .....	11-28
11.7	Axis-specific resolutions (from Software Version 3) .....	11-32
11.7.1	Corresponding data .....	11-32
11.7.2	General remarks on the axis-specific resolutions .....	11-32
11.7.3	Input, display and position control resolution .....	11-33
11.7.4	Block diagram of the resolutions .....	11-34
11.7.5	Resolution codes .....	11-35
11.7.6	Permissible combinations .....	11-36
11.7.7	The influence of resolution on speed .....	11-38
11.7.8	Maximum speed for thread cutting .....	11-41
11.7.9	Maximum traverse range .....	11-42
11.7.10	Influence on the display .....	11-45
11.7.11	Influence on the modes/function .....	11-45
11.8	Data Protection .....	11-47
11.8.1	Data areas .....	11-47
11.8.2	Data backup with the programmer .....	11-48
11.8.2.1	Introduction .....	11-48
11.8.2.2	Using diskettes .....	11-48
11.8.2.3	File handling .....	11-53
11.8.2.4	Interface settings .....	11-58
11.8.2.5	How to transfer from the SINUMERIK 840 to the programmer .....	11-59
11.8.2.6	How to transfer from the programmer to the SINUMERIK 880 .....	11-61
11.9	Remote Programmer Function .....	11-63
11.10	Coordinate transformation .....	11-71
11.10.1	Corresponding data .....	11-71
11.10.2	Function description of coordinate transformation .....	11-71
11.10.3	The transformation data set .....	11-73
11.10.4	Transformation parameters .....	11-75
11.10.5	Machine data for fictitious axes .....	11-77
11.10.6	NC PLC interface signals .....	11-78
11.10.7	Explanation of the programming and operation of coordinate transformation .....	11-79
11.10.8	Examples of coordinate transformation .....	11-81
11.10.8.1	Example of the coordinate transformation TRANSMIT .....	11-81
11.10.8.2	Example of 2D coordinate transformation .....	11-82
11.10.8.3	Example of 3D coordinate transformation .....	11-83
11.11	Description of 880N specific functions .....	11-84
11.11.1	Technology nibbling/punching .....	11-84
11.11.1.1	Tangential axis (option) .....	11-84
11.11.1.2	Clamp protection (option) .....	11-86
11.11.2	Laser and Plasma Machining Technology .....	11-98
11.11.2.1	Laser power control (option) .....	11-98
11.11.3	Analog tangential angle output (option) from software version 4.2 .....	11-111
11.11.4	Clamp protection for laser and plasma machining (deselectable clamp avoidance) .....	11-114
11.11.5	Suppression of auxiliary function outputs to the VDI interface .....	11-114
11.11.5.1	Laser S functions not transferred to the VDI interface .....	11-114
11.11.6	Rapid M functions .....	11-115
11.11.7	Repositioning .....	11-117
11.11.8	Tool change .....	11-120
11.11.9	Defined areas .....	11-124
11.11.9.1	General notes (difference description of interface) .....	11-124
11.11.9.2	Interface 880N tool management .....	11-125
11.11.10	Communication between the NC and the PLC via the special interface .....	11-127
11.11.10.1	Signals from the NC .....	11-127
11.11.10.2	Signals to the NC .....	11-128
11.11.10.3	Signals from/to the NC .....	11-130

<b>12</b>	<b>Alarms</b> .....	12-1
12.1	List of alarms .....	12-1
12.2	Alarm numbers and groups / clearing of alarms .....	12-1
12.2.1	Display of alarms on the CRT .....	12-2
12.2.2	Display representation .....	12-3
12.2.3	Alarm numbers and groups/clearing alarms (SV 6) .....	12-6
12.2.4	Diagnostics/selection of further alarms .....	12-7
12.2.5	Effects of alarms .....	12-7
12.2.6	Listing of alarms/alarm description (SV 6) .....	12-8
<b>13</b>	<b>Notes on Fault Procedure</b> .....	13-1
13.1	General .....	13-1
13.2	Faults in operator panel area .....	13-2
13.3	Table of faults .....	13-3
13.4	Module exchange .....	13-5
<b>14</b>	<b>List of Abbreviations</b> .....	14-1

# 1 Preconditions and Visual Inspection

## 1.1 Preconditions

The following preconditions must be satisfied prior to commissioning:

- Electrical and mechanical installation of the machine must have been completed and the axes prepared for operation.

**These points are to be confirmed by the customer.**

- Customer PLC program is operational and pretested.
- Measuring system has been installed and wired as far as the SINUMERIK (see Section 1.2.3).
- Cables are connected to the machine. Cable shields run to the controller neutral point as specified in the Interface Description. Flexible earth wires have been installed (see Section 1.2.2). Check that the earthing concept has been kept to!
- Customer personnel support for work on the interface unit, work on machine, machine operation, customer-generated PLC program and the UMS configured by the customer is guaranteed.

**Recommendation:**

First limit travel ranges (greater clearance distances) by displacing the end stop ("EMERGENCY STOP" cam).

- The specified machine data must be available.
- Test tapes must be available for checking machine-specific functions.

## 1.2 Visual inspection

### 1.2.1 Notes on handling modules

- Synthetic or rubber soiling, and in particular synthetic flooring and carpeting, may produce static charging amounting to several kV in human beings. Integrated circuits are sensitive as far as any high-voltage discharge is concerned.
- Even with the controller disconnected, static charging may cause damage, e.g. short-circuiting across the VCC RAM printed conductors which may corrupt the data in the buffered CMOS RAM memories or burn out the printed conductors.
- It is critical therefore that attention should be paid to the notes below during visual inspection and throughout the entire commissioning process in order to prevent damage as a result of incorrect handling.
- Never touch the printed conductors and components without first discharging on an earthed system part.
- Modules and power supply cables should only be withdrawn or inserted with the controller disconnected.

**Note:**

When replacing modules or in the event of a fault during commissioning, all ICs in sockets must be checked for correct location and fit.

### Special notes on handling modules with MOS chips

MOS is a technology used to manufacture LSI digital circuits. "MOS" stands for **Metal-Oxide Semiconductor**.

The principal advantages of MOS technology are as follows:

- Simple transistor design
- High component density
- Extremely low power consumption.

Special safety regulations apply to modules with MOS chips. For this reason they are specially marked:

Identification on packaging:

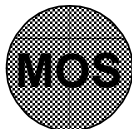

Caution!  
Observe safety regulations!

**MOS**

#### Caution!

The printed circuit board is fitted with MOS chips. To prevent these chips from being irreparably damaged, equipotential bonding must be ensured prior to installing the PCB. Remove the PCB together with the conductive foam plastic from the packaging and touch an earthed system part. do not touch the printed conductors and components!

Identification on printed circuit board:

**M  
O  
S**

#### Additional notes:

- Do not open the special packaging unnecessarily
- Store only in the black (conductive) foam plastic
- Do not bring into contact with plastic materials (possibility of static charging)
- Disconnect power supply prior to installation and removal.

### 1.2.2 Earthing

Proper earthing to divert external malfunctions is vital for trouble-free operation. It must be ensured that the earth wires are not kinked and have the necessary cross-section (see also Interface Description, Part 2 and Operating Instructions).

Earthing must be carried out as described in the "SINUMERIK 880 Instruction Manual" and the "Distributed Machine I/O Devices Instruction Manual" (extract from the Instruction Manual).

**Earthing concept** (extract from the Instruction Manual)

- Earthing meets the requirements of the DIN VDE 0160.
- The same earthing concept applies to the NC, PLC, drives and machines.
- The earth connections are routed to a central earthing point in a star layout.
- Equipotential bonding of the external components is by means of the equipotential bonding strip.
- Safety earth terminal.

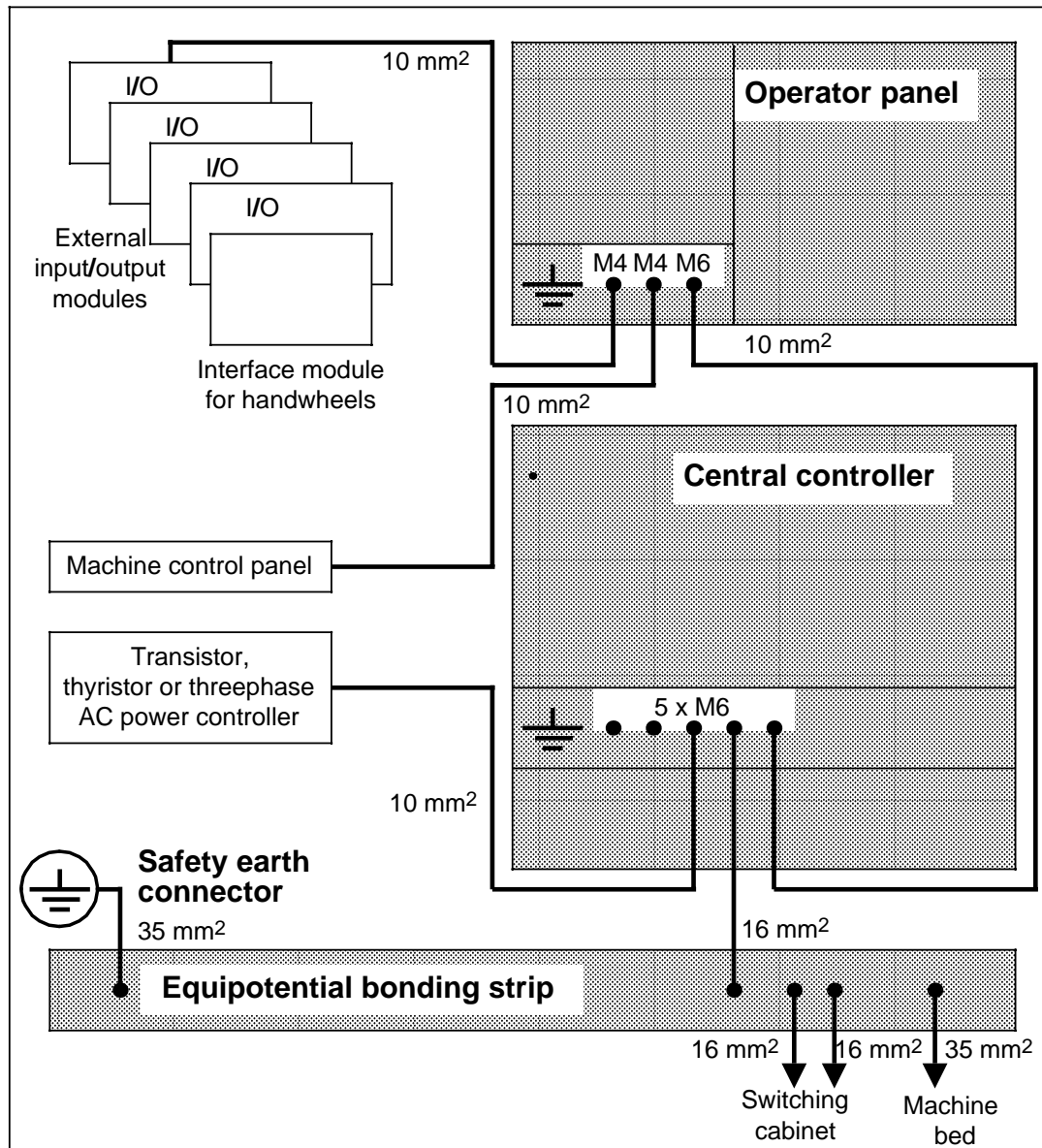

Example of equipotential bonding strip location (earthing concept)



### 1.2.3 Position encoders

Particular attention is to be paid to the prescribed installation of the graduated scales (air gap etc.) and the pulse encoders (coupling) (see also Installation and Adjustment Instructions of the Manufacturer).

Check for correct wiring and fixed location of the connectors.

If the customer has inserted adapter plugs in the measuring circuit lines, a check must be made for proper connection, strain relief and above all the prescribed shielding.

Other makes of position encoder may result in inaccuracy and surface quality problems beyond our control.

See Section 8.1.2 for the characteristics of digital measuring systems with a differential output.

### 1.2.4 Cable laying

It should be ensured as far as possible that power cables and control cables are isolated. Do not produce earth loops since such loops or non-regulation earthing may generate a ripple voltage affecting the speed controller setpoint. Smooth running at minimum speeds is then no longer guaranteed.

Check that the cables are properly run and that trailing cables are correctly laid. Any kinking must be avoided. Comply with the permissible bending radii.

### 1.2.5 Cables

Check all cables in accordance with the cable and equipment overview (see Interface Description, Part 2). This applies particularly to cables produced by the customer.

A random check should be made on at least one connector. Particular attention must be paid to conductive elastomer connections.

In the event of failure to comply with our guidelines, the responsible sales point must be advised and any necessary corrective measures instigated.

### 1.2.6 Shielding

The overall shields of all cables running to or from the controller must be earthed at the controller via the connectors (see Interface Description, Part 2). Only SINUMERIK connectors are permissible because other connectors cause interference.

### 1.2.7 Interference suppression

All d.c. and a.c. relays must be interference-suppressed using suitable means, as must a.c. or three-phase motors (e.g. lubricating pumps and the like). Observance of the prescribed measures for interference suppression should be checked on a random basis (also refer to the Instruction Manual).

## 1.2.8 Operator panel

Check that the pushbuttons, keys, lamps, symbols and screen are in order.

It is imperative for operation of the SINUMERIK 880 that the operator panel is connected to the central controller by means of optical fibres or copper cable. The COM CPU and OP CPU (operator panel CPU) cannot be started up without the connecting cable.

(See Interface Description, Part 2 for cables).

The link to the central controller can also be displayed on the operator panel (see Section 13).

## 1.2.9 Overall condition

Check the module mounts and cover plates.

Check that the front panel screws have been tightened (M connection).

Check that the accessory pack is complete.

Check that all unassigned slots have a blanking plate.

### The accessory pack must contain the following:

- Log book
- Complete parts list (The parts list is included with the original delivery note and must be inserted in the log book).
- Transparent covers and symbols for customer keys.
- Instruction manual
- Delivery bill with the options ordered.

## 1.2.10 Batteries

The battery for the NC and PLC data memory (internal PLC) is located on the bottom right-hand side in the central controller. It is accessible from the front for replacement purposes. To this end the cover on the power supply unit must be moved downwards. The battery should only be replaced under power so that the stored data (part programs, setting data, ...) is not lost.

The battery voltage is continuously monitored. Alarm 1 is displayed on the NC screen if the voltage drops below 2.7 V. In this case the control must not be switched off until a new battery has been inserted.

### Battery type:

Unit end 1990:	3.4 V/5 Ah	From beginning 1991:	3 alkali batteries
	TL 2200		1.5 V (baby)
	IEC-R-14 (baby cell)		
	guaranteed life one year		

The battery for the machine data memory is soldered in position on the machine data card. This card is located on the dualport or multiport. Alarm 6 is displayed on the screen if the battery voltage drops to such an extent that buffering of the NC MDs is no longer guaranteed. The typical service life of the battery on the machine data card is 5 years (2 years guaranteed). It may only be replaced together with the 128k-RAM (6FX1134-2BA).

Since 9/89 a machine data card has been used which no longer has a soldered-in battery but is backed up by the central battery.

## 1.3 Export version

The following functions cannot be set on the SINUMERIK 880TE and SINUMERIK 880ME controls:

- 2nd/4th serial interfaces (C 62)
- 3D machining (C 61)
- Selecting 2D interpolation (from Software Version 04: 3D interpolation) in more than two channels at a time causes the machine to shut down with alarm 81: "More than two 2D interpol.". The interface signal "mode group ready" is cancelled with all mode groups. Machining can only be resumed after the NC has been switched off and powered up again.
- If the option computer link (via active serial interface) is available only the first **or** third serial interface on the control can be operated.
- Computer link via SINEC H1 option.
- up to software version 2:  
Input/position control resolution 0.0001 mm/0.00005 mm  
Input/position control resolution 0.00001 inch/0.000005 inch
- from software version 3:  
Input resolution < 10<sup>-3</sup> mm/degrees  
Input resolution < 10<sup>-4</sup> inch/degrees

Conversion from the export version to the normal version and vice versa can only be performed by the Gerätewerk Erlangen (GWE).

From Software Version 3 the export version differs from the normal version in the system program EPROMs of the COM area.

## 1.4 Export version for China (Software Version 3 only)

The following functions cannot be set on the SINUMERIK 880TEC and SINUMERIK 880MEC controls:

- 2nd/4th serial interfaces (C 62)
- 4D machining
- Selecting 3D interpolation in more than two channels at a time causes the machine to shut down with alarm 81: "More than two 3D interpol.". The interface signal "mode group ready" is cancelled with all mode groups. Machining can only be resumed after the NC has been switched off and powered up again.
- If the option computer link (via active serial interface) is available only the first **or** third serial interface on the control can be operated.
- Computer link via SINEC H1 option
- from Software version 3:  
Input resolution < 10<sup>-3</sup> mm/degrees  
Input resolution < 10<sup>-4</sup> inch/degrees

Conversion from the export version for China to the normal version and vice versa can only be performed by the Gerätewerk Erlangen (GWE). The export version for China differs from the normal version in the system program EPROMs of the COM area.

## 2 Installation Checklist

880 M	<input type="checkbox"/>	880 T	<input type="checkbox"/>	F-Nr.	_____
880 N	<input type="checkbox"/>				

### Installation sequence

Section 1 of the Installation Guide, Interface Description Part 2 and the information presented in the Instruction Manual must be carefully observed!

Copy the installation checklist, fill it out, and enclose it in the log book after installation.

Make a cross next to Yes or No after each section has been completed.

Enter all required values where stated.

Information relating to the individual sections is provided in the Installation Guide.

### Initial installation

Name ..... Office ..... Date .....

Manufacturer ..... Address .....

### Re-installation

Name ..... Office ..... Date .....

Customer ..... Address .....

- Are the prerequisites for installation per Section 1 fulfilled? Yes  No
- Visual inspection: Mains connection, EMERGENCY STOP, grounding concept, grounding of the position encoders, cabling, shielding, external machine control panel, logic submodule (I/O submodule), input/output modules, overall state OK? Yes  No

3. Version of the control software:

- BT .....
- COM .....
- NC1 .....
- NC2 .....
- NC3 .....
- NC4 .....
- Servo1 .....
- Servo2 .....
- Servo3 .....
- Servo4 .....
- PLC1 .....
- PLC2 .....
- UMS .....

4. Voltage test: Voltage at power supply units ..... (tol. 230 V + 6 %/- 10%)  
 Voltage at I/O module ..... (20-30 V, inc. ripple)

5. Standard installation completed and customer-specific machine data entered? Yes  No

6. PLC program entered and tested (safety functions)? Yes  No

7. Position control loops of axes installed and the following checked:  
 Axis speeds / tachogenerator compensation / multigain / servo gain (KV factor) / acceleration / exact positioning / position control loop monitors / analog spindle speed / spindle positioning traversing ranges? Yes  No

8. All conventional functions tested? (10 mm programmed = 10 mm on machine) Yes  No

Function test performed with test program (by customer)? Yes  No

## 9. Data backup

In the event of a liability case (e.g. exchange of software to remedy errors)  
SIEMENS AG is not liable for the loss, damage, or reacquisition of lost data.

Were backup copies made of the following data:

- |   |                              |                             |
|---|------------------------------|-----------------------------|
| • NC machine data                         | Yes <input type="checkbox"/> | No <input type="checkbox"/> |
| • PLC machine data                        | Yes <input type="checkbox"/> | No <input type="checkbox"/> |
| • Cycle machine data                      | Yes <input type="checkbox"/> | No <input type="checkbox"/> |
| • Cycle setting data                      | Yes <input type="checkbox"/> | No <input type="checkbox"/> |
| • Zero offsets                            | Yes <input type="checkbox"/> | No <input type="checkbox"/> |
| • Setting data                            | Yes <input type="checkbox"/> | No <input type="checkbox"/> |
| • R parameter                             | Yes <input type="checkbox"/> | No <input type="checkbox"/> |
| • Tool offsets                            | Yes <input type="checkbox"/> | No <input type="checkbox"/> |
| • UMS (as source floppy or source code)   | Yes <input type="checkbox"/> | No <input type="checkbox"/> |
| • PLC user program + data blocks          | Yes <input type="checkbox"/> | No <input type="checkbox"/> |
| Were these data deposited at the machine? | Yes <input type="checkbox"/> | No <input type="checkbox"/> |

Installation checklist completely filled  
out (including options), inserted in the  
log book and deposited at the control?

Yes  No

## 10. Were the following functions explained to the customer:

- |   |                              |                             |
|---|------------------------------|-----------------------------|
| Drift compensation, reference point adjustment        | Yes <input type="checkbox"/> | No <input type="checkbox"/> |
| Marginal software conditions as per revision bulletin | Yes <input type="checkbox"/> | No <input type="checkbox"/> |
| Did the customer sign the installation report?        | Yes <input type="checkbox"/> | No <input type="checkbox"/> |

**Signatures****Initial installation****Re-installation**

## 2.1 Incompatibility

### Software version 5.1:

From software version 5.1 the RESTART EPROMS on the NC CPU have to be exchanged.

Where the 186 SERVO CPU is used:

The EPROM type has been changed. For software version 5.1 onwards 120 ns EPROMS (fast 27512 EPROMS, access with 0 waits) are used.

### Please take care when duplicating!

Otherwise errors may occur.

GWE order number: 372094

### Software version 6.1:

The PLC CPU can only be used with an ACOP (advanced coprocessor) from software version 6.1.

MRPD no.:                   6FX 1138-6BL01  
                                  6FX 1138-6BK01

A different EPROM board is used for the PLC basic program. The EPROMS (type: 271001) are flow soldered and can no longer be duplicated!!

MRPD no.:                   6FX 1145-8BA00.

SINUMERIK 880 must be equipped with the following multiport/dualport to carry out the "Read/write date/time" function:

Multiport memory           (with clock) 6FC 1136-8BA01 or

Multiport memory           (with clock) 6FC 1124-8BA03

If a 386 SERVO CPU is used, SINUMERIK 880 single-tier version must be equipped with the following dualport versions:

6FX 1124-0BA02 or 6FX 1124-0BB02.

The clock cycle must be reprogrammable!

At least multiport version 6FX 1136-8BA.. must be used with the two-tier version.

Changes to the embargo regulations:

The following measures were necessary in software version 6.1 because of the changes to the embargo regulations:

- Spline interpolation disabled
- No restrictions in the use of serial interfaces (2nd/4th RS 232 C (V.24) is permitted)

Software version 6.1 also offers texts in the Russian language (J72). A requirement for this is the large character EPROM (27C64) with the Cyrillic character set on the video module (item number: 570 800 7024.00).

## 2.2 Conversion sequence

Conversion from software version 01 or 02 to software version 3 and from software version 3 to 4 must be carried out in the correct sequence.

Conversion sequence for conversion from software version 4 to 5.1 and from software version 5.1 to 6.1:

1. Using the incompatibility list check that all the conditions for conversion have been fulfilled and that all PLC packages, ... etc. required for the system are available.
2. Make backup of the following current data on an external memory:
  - NC machine data
  - PLC machine data
  - MD cycles and SD cycles
  - IAR MD
  - Setting data and zero offsets
  - Tool data (all tool offset areas)
  - R parameters (all channels if necessary)
  - Main programs/subroutines (cycle inhibit not loaded)
  - ASM (if in RAM)
  - PLC programs and data blocks (if in RAM)
3. Switch off the system.
4. Remove old software and load new software:
 

NC	860 (812 to SV 02)
PLC	861 (813 to SV 02)
COM	862 (814 to SV 02)
SERVO	863 (816 to SV 02)
OP	864 (815 to SV 02)

The RESTART EPROMS must be exchanged on the NC CPU!

5. Apply controller inhibit for all axes (in the hardware).
6. Turn rotary switch on COM CPU to the "1" position.
7. Switch on system
8. Carry out standard installation as follows:
 

(s. also Installation Guide, Section 9.2.1)

  - 8.1 Press "Machine data" softkey.
  - 8.2 Press "Clear NC MD" softkey.
  - 8.3 Press "Load NC MD" softkey.
  - 8.4 Press "Clear PLC MD" softkey.
  - 8.5 Press "Load PLC MD" softkey.
  - 8.6 Press "Clear Cycle MD" softkey.
  - 8.7 Press "More" key.
  - 8.8 Press "Start IAR MD" softkey.
  - 8.9 Press "RECALL" key.
  - 8.10 Press "NC data" softkey.
  - 8.11 Press "Format user memory" softkey.



- 8.12 Press "Clear part program memory" softkey.
- 8.13 Press "RECALL" key.
- 8.14 Read in backed up NC MD and PLC MD through the serial interface (interface 1 or 3).
- 8.15 Press "NC data" softkey.
- 8.16 Press "Format user memory" softkey.
- 8.17 Press "Clear part program memory".
- 8.18 Press "RECALL" key.
- 8.19 Press "PLC functions" softkey.
- 8.20 Select desired PLC.
- 8.21 Press "PLC initial" softkey.
- 8.22 Press "PLC 1 initial" softkey
- 8.23 Press "PLC 2 initial" softkey, if available.
- 8.24 Press "RECALL" key.
- 8.25 Press "RECALL" key.
9. Turn rotary switch on COM CPU to "0" position.
10. Press "Set up end PW" softkey power ON.
11. Check that all NC MD and PLC MD have correct values according to the Installation Guide Lists and/or Revision Note.
12. The following NC MD have to be altered manually:  
NC MD 157: 880T 8161  
880M 8261.
13. Return to installation mode by turning the rotary switch to the "1" position.
14. Press "Format user memory" softkey.
15. Leave installation mode by turning the rotary switch to the "0" position.

Steps 13 to 15 only have to be carried out if MD have been altered in point 11 which affect the user memory (tool offset, tool offset areas).

16. Read in backed up setting data, tool offsets, R parameters, main programs/subroutines (define as cycles if necessary) and zero offsets via the serial interface.
17. Install PLC and install required PLC packages.
18. Remove axis-specific controller inhibit (in the hardware) and traverse the axes.
19. Enter alterations (hardware and software) in log book.
20. Carry out a test run using the customer's programs (if available).

## 3 Drive Optimization

### 3.1 Direct control of feed axes - checking and adjustment

Simplified block diagram of the drive control loop

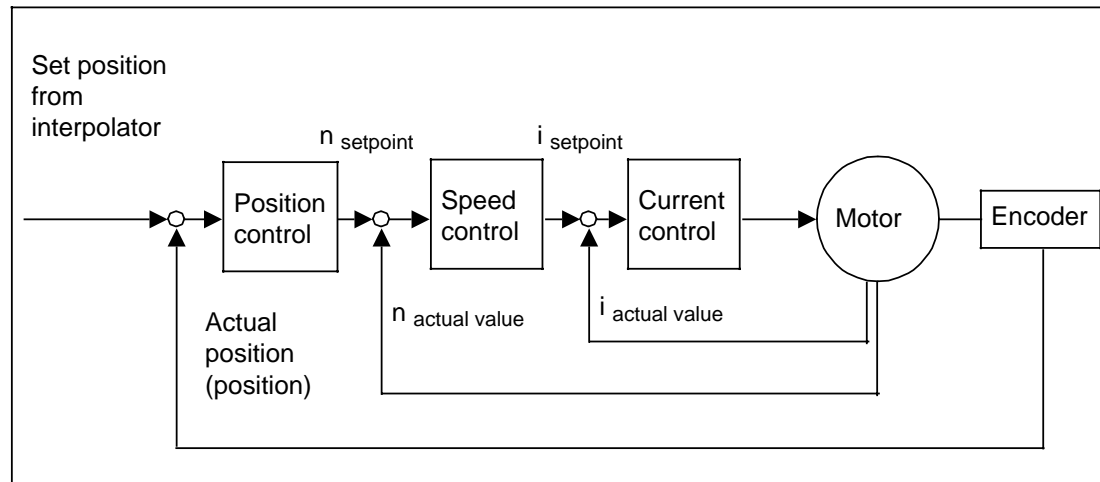

Before the position control is started up the speed control and the count control of the drive must have been started up and optimized.

When you start up the position controller first check the actual position before optimizing the position setpoint.

The following must be determined before starting work:

- The direction of travel of the feed axis (as stated by the customer or to ISO)
- The polarity of the speed setpoint voltage on the controller for axis movement in positive direction (as stated by the customer or by testing with a battery box)

With NC MD 564\* bit 1 (sign inversion speed setpoint) and NC MD 564\* bit 2 (sign inversion actual position) you can influence the control direction of the position control (see flowchart).

3.1 Direct control of feed axes - checking and adjustment

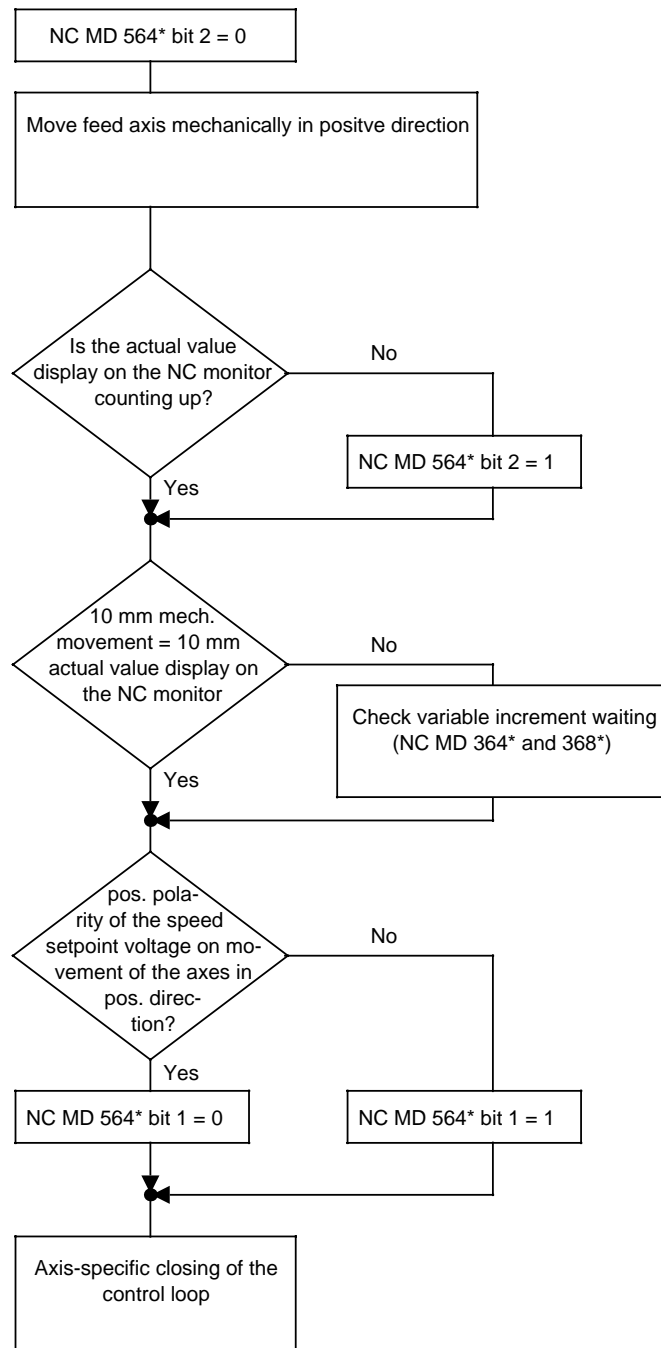

## 3.2 Definition of maximum setpoint and tachogenerator compensation

The axis-specific maximum speeds NC MD 280\* to 292\* requested by the customer are assigned to a tachogenerator voltage.

It should be borne in mind that a control reserve of roughly 5 % is also required.

The performance limits are set by the measuring-circuit board (10 V) or by the drive control unit.

### Definition of maximum setpoint:

The setpoint (command value) is specified under NC MD 268\*. In this way the output voltage is limited by the NC. In operation the limit entered under NC MD 268\* must not be reached.

The maximum allowable setpoint is 10 V.

Conversion to input datum:  $10\text{ V} = 8191\text{ units}$

The maximum setpoint is to be entered in accordance with the maximum allowable input voltage of the drive control unit.

a) Maximum permissible input voltage of drive control unit 10 V:

Input under NC MD 268\* : 8191 units

The maximum axis speed is already reached at 9.5 V on account of the control reserve of 5 %.

b) The drive control unit must be limited to an input voltage of less than 10 V:

Input under NC MD 268\* :  $< 8191\text{ units}$

### Example

Up to a setpoint of 5 V the value entered is 4100. The maximum axis speed must be reached at 4 V.

In general terms the setpoint should be as high as possible since better control response can be achieved with a higher setpoint voltage.

### 3.3 Multgain factor NC MD 260\*

A multgain factor must be entered in NC MD 260\* to calculate the set speed. It is thus possible to operate axes at different maximum speeds and the same servo gain factors with full utilization of the setpoint input.

Axes traversing in continuous-path operation must have the same servo gain factor. For this reason, the multgain factor must be determined for each axis using the following equation:

Metric measuring system:

$$\text{Multgain} = \frac{3 \cdot 10^7}{V_{\max} [\text{mm/min}]} \cdot \frac{U_{\max} [\text{V}]}{10 \text{ V}}$$

$V_{\max}$  . . . . . max. axis-specific speed

$U_{\max}$  . . . . . speed set voltage at max. speed

Inch measuring system:

$$\text{Multgain} = \frac{3 \cdot 10^7}{V_{\max} \cdot 25.4 [\text{inch/min}]} \cdot \frac{U_{\max} [\text{V}]}{10 \text{ V}}$$

### 3.4 Servo gain factor ( $K_v$ factor)

A high servo gain value is required to ensure that only minor contour deviations occur in continuous-path operation.

However, an excessive servo gain value results in instability, overshoot and, possibly, impermissible machine loading.

The maximum allowable servo gain factor depends on:

- Response time constant
- Deadtime of the drive
- Behaviour of the controlled system
- Quality of machine.

The servo gain factor ( $K_v$ ) is defined as follows:

$$K_v = \frac{\text{Speed}}{\text{Following error}} \quad \frac{[\text{m/min}]}{[\text{mm}]}$$

If an empirical value for the servo gain factor is known for the machine, this value is set and a check is performed for overshoot or instability.

#### Important:

A precondition for correct setting of the  $K_v$  factor is good speed controller optimization.

#### Setting of servo gain factor

Reduce acceleration (NC MD 276\*). The overshoot behaviour is the decisive factor in assessing the maximum servo gain factor. Consequently, the acceleration setting must be such that the drive remains below its current limit.

Should the drive reach an acceleration value of 1 m/s<sup>2</sup>, half the value should be selected for reasons of safety:

$$0.5 \text{ m/s}^2 \hat{=} \text{Input } 50$$

The servo gain ( $K_v$ ) is entered under NC MD 252\* using the following conversion equation:

$$\begin{aligned} K_v (0.01 \text{ s}^{-1}) &= \frac{5000}{3} \cdot K_v \left[ \frac{\text{m/min}}{\text{mm}} \right] \\ &= 1666 \cdot K_v \left[ \frac{\text{m/min}}{\text{mm}} \right] \end{aligned}$$

For servo gain factor ( $K_v$ ) 1, therefore, the numerical value 1666 is entered.

The least favourable axis in terms of dynamics contributing to continuous-path operation should be assumed to assess whether the positioning behaviour is error-free and whether the set maximum value has been correctly selected.

Setpoint voltage  $n_{set}$  with respect to the speed controller is measured using an Oscillomink or storage oscilloscope. Different feedrates are used.

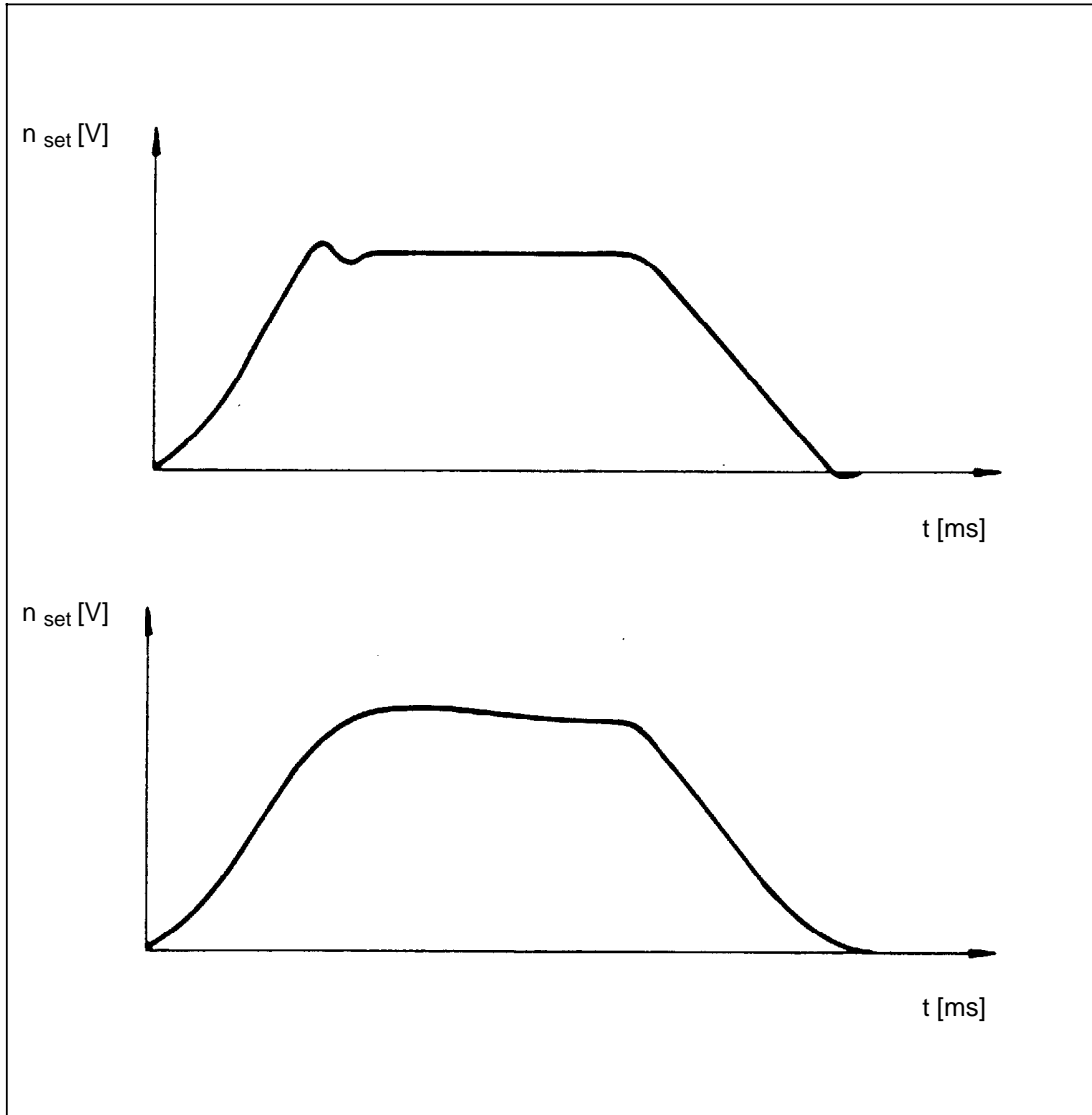

In particular, braking is to be observed with higher voltage gain on the oscilloscope or Oscillomink.

Overshoot may also occur on account of the following factors:

- Acceleration excessive (current limit reached)
- Speed loop rise time excessive
- Fault in speed controller (re-optimization may be necessary)
- Mechanical backlash
- Canting of mechanical components
- Load fluctuations (perpendicular axis)

For safety reasons a servo gain factor should be selected which is at least 10 % smaller than the maximum possible value. Axes working together in continuous-path operation must have the same servo gain factor.

### Checking the servo gain factor

The magnitude of the following error is shown by the service display of the individual axes (see Diagnosis Description for selection). If the drift has been compensated, the values displayed for the positive and negative traversing directions are identical.

Finally, the servo gain factor entered for all axes must be checked during operation via the following error display.

Precise continuous-path operation requires equal dynamic axis behaviour, i.e. the same following error must occur at the same speed.

Any differences must be compensated in terms of multgain or at the actual-speed potentiometer (tachogenerator compensation).

## 3.5 Acceleration NC MD 276\*

The axes are accelerated and braked with the input accelerations

$$b \cdot 10^{-2} \text{ [m/s}^2\text{]}$$

Running up to speed and positioning are thus possible with accuracy and speed and with minimum strain on the machine.

The customer should be advised of the max. axis acceleration for which the machine is suitable. This value (assuming the drive is not overloaded) is entered under NC MD 276\*.

These values are normally situated between 0.3 m/s<sup>2</sup> and 2 m/s<sup>2</sup>

### Checking or determining the acceleration values:

Setting:	NC MD 276*
Condition:	Overshoot-free acceleration or positioning at rapid traverse speed (acceleration stop limit) Under maximum load conditions (heavy workpieces on table)
Measuring equipment:	Recorder or storage cathode-ray oscillograph
Measuring point:	Set speed and possibly actual current and speed controller output



Once the acceleration has been set, the rapid traverse speed is selected and the actual currents and possibly speed controller output are simultaneously recorded. It can thus be seen whether or not the current limit has been reached. The drive may briefly reach the current limit. However, this must only occur in the rapid traverse range. Before the rapid traverse speed or the position are reached, the rpm servo and current control must return to the normal range (current limit **not** reached!).

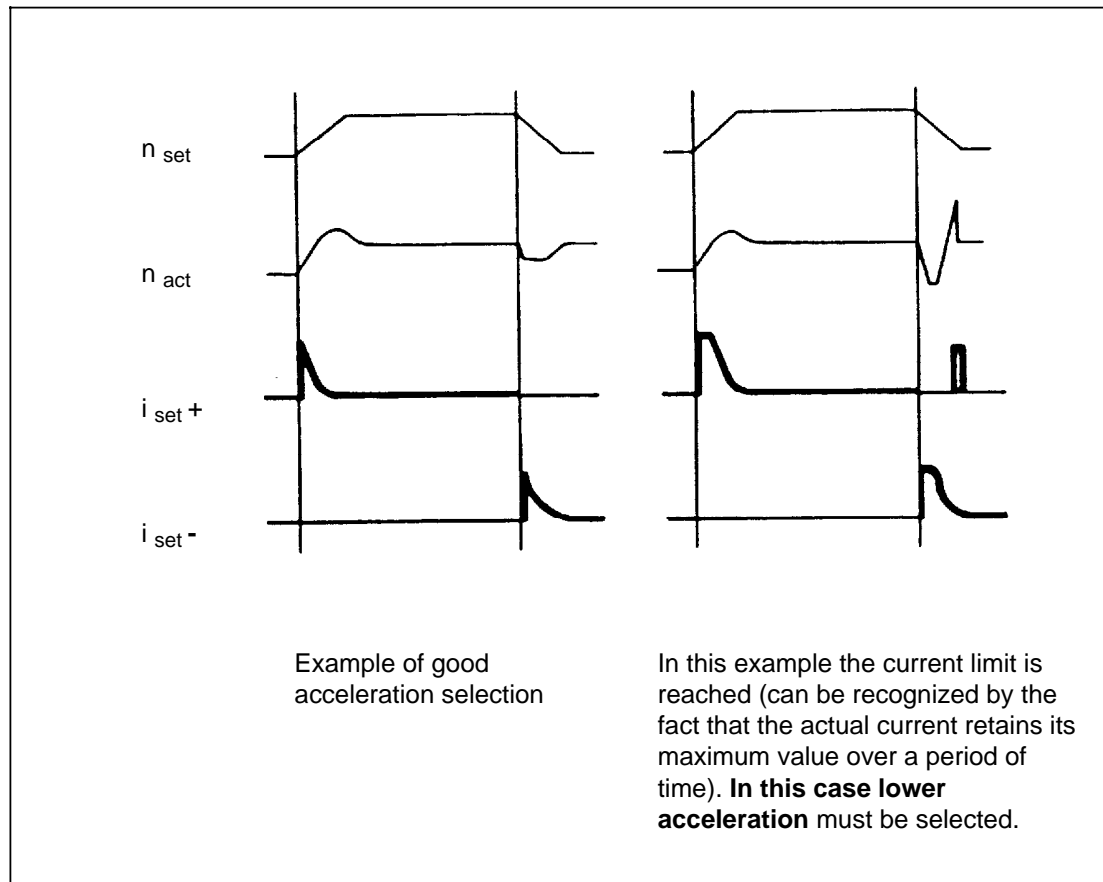

*Relationship between acceleration and actual current*

Slight changes in load (sluggishness, effect of lubrication) must not result immediately in the current limit being reached. Consequently, at least a 10 % lower acceleration value should be entered.

At the customer's request, acceleration may be further reduced to minimize the load on the mechanical components. The axes may be given different acceleration values, even if they are to interpolate with each other.

## 3.6 Position monitoring

### 3.6.1 Exact stop limit coarse and fine (NC MD 204\* to 208\*)

The position approached is checked. Should the following error be greater than the value entered under NC MD 204\* to 208\*, then the "MOTION" LED does not go out.

#### Exception:

The stop tolerance range is not monitored with the axis clamped!

#### Setting

Positioning accuracy is dependent on the quality of the position control loop and speed control loop.

The standard deviation is to be determined by observing the following error at rest.

The input value should be between 10  $\mu\text{m}$  and 50  $\mu\text{m}$  in accordance with the customer's requirements and the positioning accuracy achieved. However, it should be at least twice the maximum deviation of the following error at rest.

### 3.6.2 Clamping tolerance (NC MD 212\*)

The machine manufacturer must endeavour to minimize the position deviation, i.e. as far as possible below the exact stop limit NC MD 204\* to 208\*. For the clamping tolerance range NC MD 212\* the value entered must be approx. twice that under NC MD 204\* to 208\*. Alarm 112\* is displayed when one of the axes at rest (after the time under NC MD 372\* has elapsed) is forced out of position (clamping active and servo enable cancelled).

### 3.6.3 Zero speed control

To make sure that an axis moves into position within the prescribed time (depending on servo gain factor, acceleration, ...), positioning is monitored. This monitoring is set with NC MD 212\* and NC MD 372\*. The exact description is located in NC MD 372\*.

### 3.7 Contour control

Contour control operates in accordance with the following principle:

Following completion of acceleration or deceleration, the following error of the position-controlled axis remains constant. Drive load changes (e.g. interrupted cutting or heavy-duty machining) are compensated by the speed controller (PI action). A change in the following error at constant set speed only occurs when the speed controller reaches a limit as a result of the drive being overloaded (e.g. tool failure). This change is used as the condition for triggering contour control.

A tolerance band is permitted for the maximum contour deviation to prevent erroneous tripping of the control system as a result of minor speed fluctuations. In addition, a delay is required after each change in speed before the control can be activated.

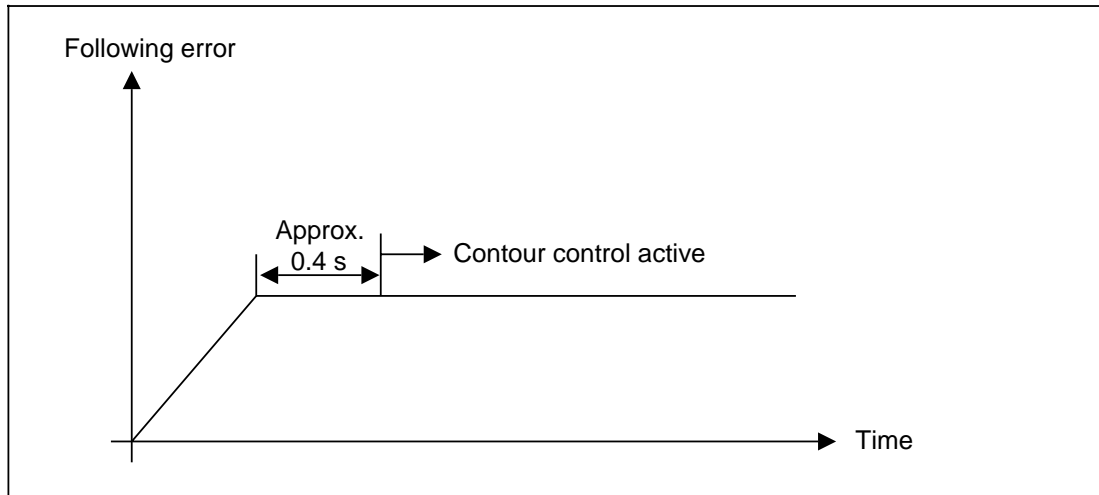

*Activation of contour control at constant set speed*

Good contour machining is only possible if all axes together performing interpolation movements have been set to the same closed-loop gain (also applies to rotary axes).

The servo gain factor should be as high as possible.

In addition to the values in NC MD 252\* (servo gain factor) and NC MD 260\* (multgain) set as machine data in the NC, the servo gain is determined by the tachogenerator compensation in the speed controller, variable increment evaluation, gear ratios etc.

NC MD 332\* and 336\* are used to influence contour monitoring.

The speed from which the contour is to be active is input in units/min (IS) under NC MD 336\*. with the axis at rest, contour is also active when a value of 0 is entered. At rest, the zero-speed control checks for impermissible axis movements.

The tolerance band is entered in encoded form (see table next page) in NC MD 332\* for the permissible contour deviation.

The input value for the desired tolerance band can be determined from the following set of curves (with position control resolution 0.5 μm):

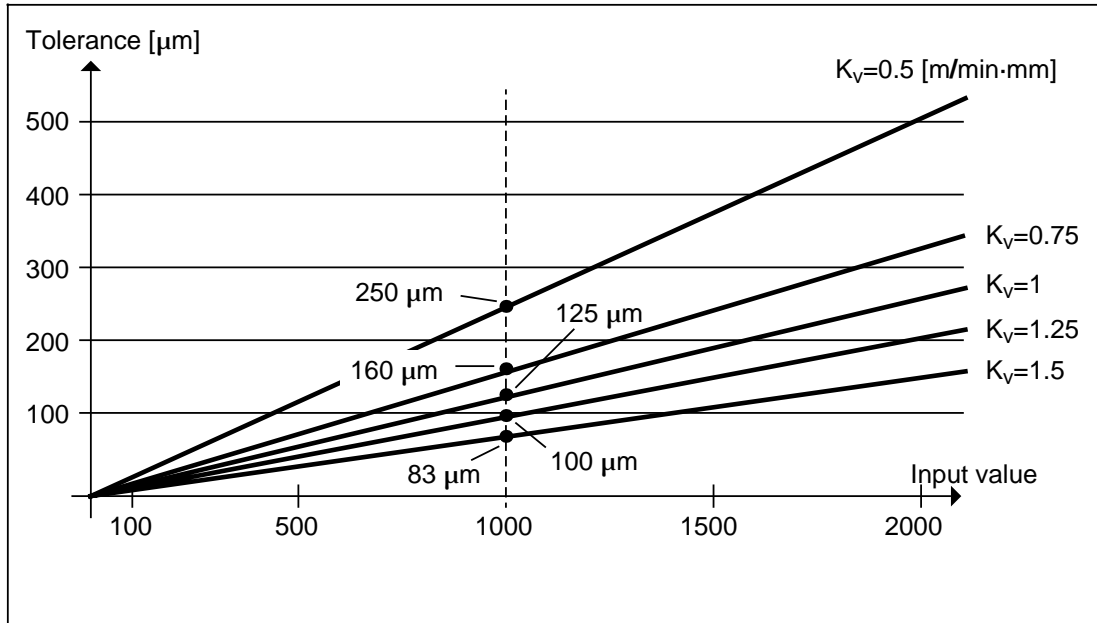

The input value for the desired tolerance band can be determined from the following equation (with position control resolution 0.5 μm).

$$\text{Tolerance band } [\mu\text{m}] = \frac{\text{NC MD 332}^* \cdot 125}{K_v \text{ factor} \cdot 1000}$$

The selected tolerance band is as follows:

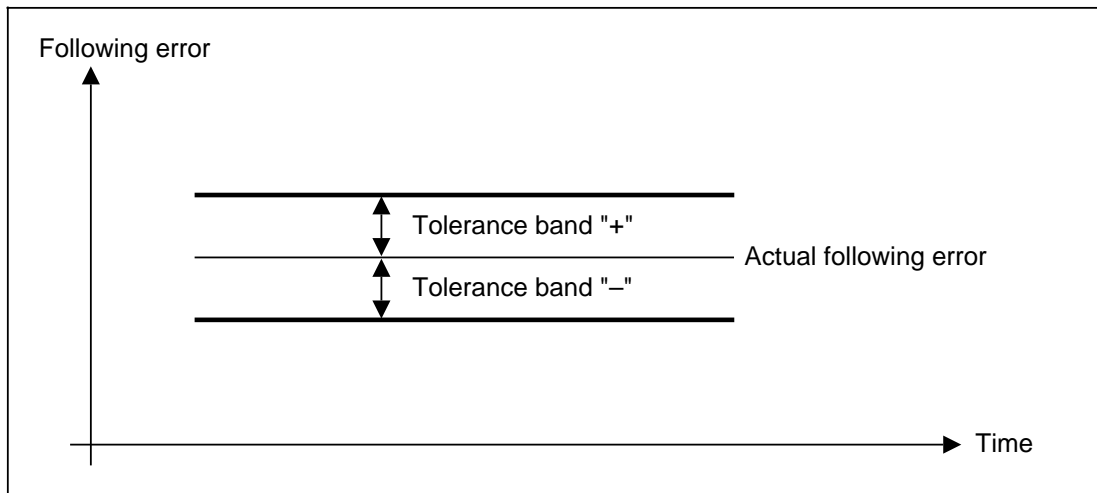

*Tolerance band for contour control at constant set speed*

The current contour deviations can be displayed for the individual axes in the diagnostics menu under softkey "SERVICE STATUS".

If the set position changes contour monitoring becomes inactive. This means that no monitoring could be active for circular interpolation. To provide machine protection in this case as well, the signs of the following error, set position and actual position are constantly compared. If they are unequal contour monitoring is switched off and Alarm 116\* given.

On operation of monitoring, Alarms 116\* are activated and the drives are braked to the current limit by specifying setpoint "0". In addition, the enabling signals for the speed controllers are cancelled and follow-up operation is selected. The alarms can only be cancelled using "RESET" (M2/M30).

Alarms 116\* are activated as soon as the specified tolerance band is exceeded or when the axis reaches the new speed within the time specified by the servo gain factor on acceleration or deceleration of the drives.

It can be concluded from operation of Alarms 116\* that the speed control loop is poorly optimized, that the servo gain factor selected for this machine is too high, or that the tolerance band is too small.

To ensure that the contour control is functioning correctly, the servo gain factor set should correspond to MD 252\*.

## 4 Overview of Modules and Standard Jumperings

In this Section only those modules are listed which are not contained in the Instruction Manual or the Interface Description Part 2.

### 4.1 Overview of modules

	<b>Order No.</b>
<b>Power supply unit in central controller</b> , 230 V, AC, 40 A	6EW1 861-2A.
<b>Power supply unit in central controller</b> , 230 V, AC, 40 A (with encoder power supply)	6EW1 861-2B.
<b>Power supply unit in operator</b> , 230 V, AC, 15 A	6EW1 861-3A.
<b>COM CPU and OP CPU</b>	6FX1 120-4BB02
<b>NC CPU</b>	6FX1 120-5BB01
<b>Servo CPU</b> , 16 bit	6FX1 121-3BA01
<b>Servo CPU</b> , 32 bit	6FX1 136-3BA01
<b>PLC CPU</b> , 135 WB, 256 Kbytes	6FX1 120-6BA01
<b>PLC CPU</b> , 135 WB, 128 Kbytes	6FX1 120-6BB01
<b>PLC CPU</b> , 135 WB, 128 Kbytes	6FX1 138-6BK01
<b>PLC CPU</b> , 135 WB, 256 Kbytes	6FX1 138-6BL01
<b>Multiport</b> , for two-tier racks or	6FX1 121-8BC02
<b>Multiport</b> , for two-tier racks (with clock)	6FX1 136-8BA01
<b>Multiport</b> , for two-tier racks (without clock)	6FX1 136-8BB00
<b>Dualport</b> , for single-tier racks (with clock)	6FX1 124-0BA03
<b>Dualport</b> , for single-tier racks (without clock)	6FX1 124-0BB01
<b>EPROM/RAM memory module</b> with 32 Kbyte RAM	6FX1 128-1BB00
<b>Basic module</b> for part program memory	6FX1 126-7BA01
<b>EPROM submodule</b> , 256 Kbytes without EPROMs (UMS)	6FX1 128-4BA00
<b>Basic module</b> for part program memory	6FX1 126-7BA01
<b>EPROM submodule</b> , 128 Kbytes without EPROMs (UMS)	6FX1 128-4BB00
<b>EPROM submodule</b> , 128 Kbytes with 2 EPROMs 27512	6FX1 128-4BC00
<b>EPROM submodule</b> , 128 Kbytes with 4 EPROMs 27512	6FX1 128-4BD00
<b>EPROM submodule</b> , 64 Kbytes (PLC user program)	6FX1 130-5BB00
<b>EPROM submodule</b> , 256 Kbytes (PLC user program)	6FX1 145-8BA00
<b>RAM submodule</b> , 128 Kbyte RAM in SMD (PP memory + UMS)	6FX1 126-6BA00
<b>RAM submodule</b> , 256 Kbyte RAM in SMD (PP memory + UMS)	6FX1 135-3BA00
<b>RAM submodule</b> , 128 Kbytes (MD card)	6FX1 134-2BC01
<b>Interface module</b>	6FX1 121-2BB02
<b>Video module</b> (for 1 <sup>st</sup> operator panel)	6FX1 126-1AA03
<b>KYRU</b> (for 2 <sup>nd</sup> operator panel)	6FX1 143-3BA01
<b>Colour display memory module</b>	6FX1 126-4AA00

<b>SPC Measuring circuit modules</b> , from to	6FX1 121-4BA02 6FX1 121-4BK02
<b>HMS Measuring circuit modules</b> , 40 mm	6FX1 145-6BA00
<b>HMS Measuring circuit modules</b> , 20 mm	6FX1 145-6BB00
<b>ACC module</b>	6FX1 142-0BA01
<b>I/O submodule</b> , with 3 input connectors	6FX1 124-6AA..
<b>Input submodule</b>	6FX1 124-6AB
<b>Input module</b> , 64 inputs	6FX1 125-7BA00
<b>Output module</b> , 32 outputs 0.5 A each	6FX1 122-8BC02
<b>Output module</b> , 32 outputs 2 A each	6FX1 122-8BD02
<b>Mixed I/O module</b>	6FX1 138-4BA01
<b>Analog input module</b>	6FX1 136-1BA01
<b>EU interface module (EU-MPC)</b>	6FX1 132-1BB01
<b>EU interface module (CU-MPC)</b>	6FX1 132-0BA01
<b>Interface DMP</b>	6FX1 144-2BA00
<b>Handwheel submodule</b>	6FX1 126-5AA..
<b>SINEC CP 231A/SINEC H1 interface</b>	6FX1 123-1BA01
<b>CP 315 basic module active serial interface</b>	6FX1 131-5BA00
<b>CP 373 expansion module active serial interface</b>	6FX1 137-3BA00

### 4.1.1 Operator panel module locations

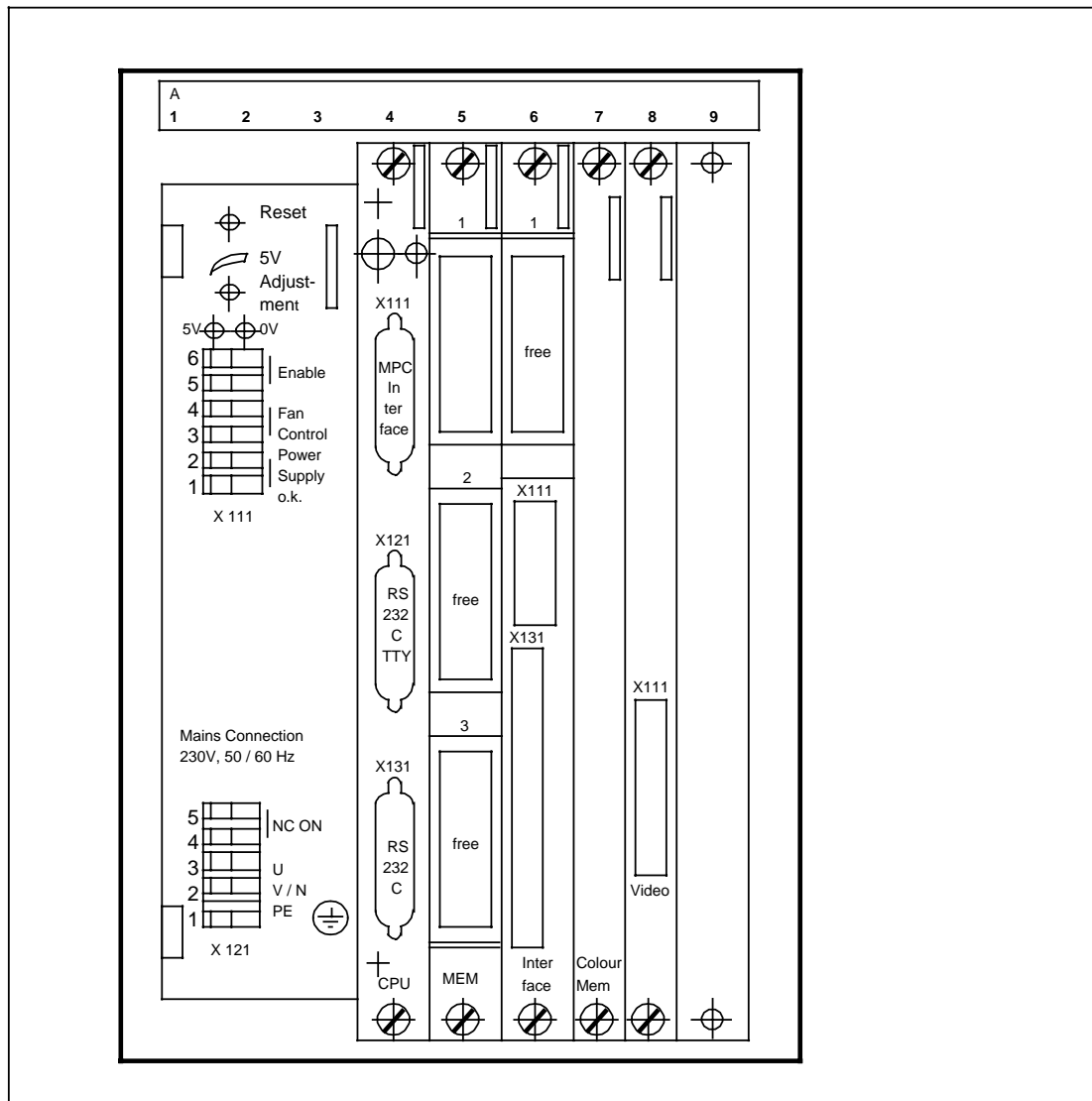

#### Module location    Order designations

1	6EW1 861-3A
2	6EW1 861-3A
3	6EW1 861-3A
4	6FX1 120-4BB02
5	6FX1 128-1BB00
6	6FX1 121-2BB02
7	6FX1 126-4AA
8	6FX1 126-1AA03
9	Reserve

#### Note:

Module 6FX1 126-4AA is omitted with the green monochrome monitor.



## 4.1.2 Central controller module location

The SINUMERIK 880 is currently supplied in 6 versions. The exact slot assignment and the components used in each version can be found in the current catalog.

### Bus structure - bus link

The versions differ in the size (single-tier/ two-tier) and in the bus configuration (local bus).

In the latest bus modules the local buses are connected by bus links according to the version ordered. For this reason the bus links must not be moved or removed as this would alter the characteristics of the control stated in the contract.

The bus links are on the back of the bus module on the first and last slots of each local bus of an edge connector. The edge connectors are connected to one another by a bus link 6FX1 126-5BA (local bus extension).

### Note:

The bus links are only visible when the back plate of the central controller has been removed.

### Jumpers

A jumper is inserted inside the bus PCB between the first and last CPUs next to each location not carrying a module with link bus plug-in contact. Any jumper missing ahead of the last CPU is not recognized during the start-up routine by the COM CPU and proper operation is no longer possible. These jumpers are correctly inserted at the factory in subsequent CPU addition (e.g. installation of NC CPUs, servo CPUs, PLC CPUs). In the event of a subsequent CPU addition (e.g. installation of a second NC CPU), the jumper next to the module location of the retrofitted CPU has to be removed. Otherwise, the CPU concerned cannot be started.

Example of jumpering (single-tier rack, version 1):

- 2 NC CPUs, 2 Servo CPUs:

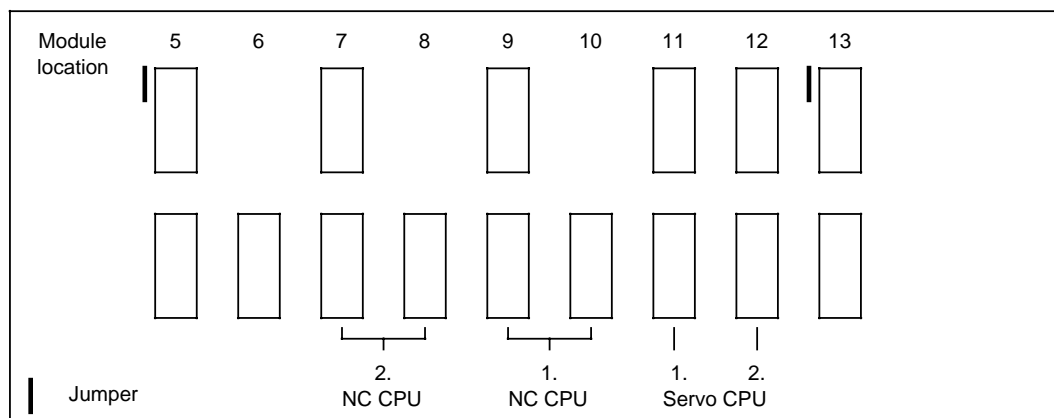

### Comment

If the jumper at location 13 is not connected, the PLC at location 17 does not start (LED flashes 6 times). If a third servo CPU is to be retrofitted, the jumper at location 13 has to be removed.

- 1 NC CPU, 1 Servo CPU:

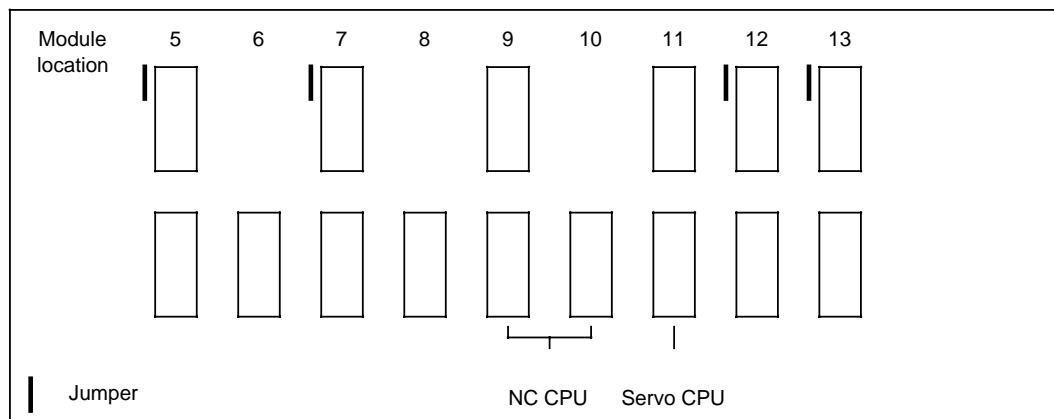

### Comment



If the jumper at location 7 is not connected, none of the CPUs to the right of this location starts.

### Note:

The jumpers are visible from the module side.

## 4.2 Power supply units

### 4.2.1 6EW1 861-2A. power supply unit (in central controller for two-tier racks) and 6EW1 861-2B. power supply unit (in central controller for single-tier racks)

Connections on front panel	Remarks
	230 V AC/ 50 Hz
	Earth
Ext 24 V DC	External 24 V DC voltage can be monitored. A facility offered by the machine manufacturer to monitor the 24 V auxiliary voltage.
Fault Indicator 24 V DC	Relay output: external 24 V DC monitor has responded if relay contact
Fan	Relay output: fan monitor has responded if relay contact closed.
Measuring sockets 5 V DC	Internal 5 V can be set or measured (performed at factory).
5 - 6.5 V DC	External voltage for sensors remote from machine. Voltage may be set. Not a standard feature
3.4 V	Battery voltage may be checked.
NC ON	<b>Caution!</b> <b>Must not be wired parallel to NC ON in the operator panel power supply unit! Use control switch with 2 contacts or relay!</b> <b>The NC ON cable must be shielded.</b> <b>(For NC ON see also Interface Description, Part 2).</b>

	Undervoltage monitor active when ...	Monitored voltage
a) <sup>1)</sup>	S2 closed	5 V
b) <sup>1)</sup>	S3 closed	5 V to 6.5 V <sub>ext</sub>
c)	S4 closed	15 V
d)	S5 closed	- 15 V

	Overvoltage monitor active when ...	Monitored voltage
e) <sup>1)</sup>	S12 closed or S2 closed and R 246 soldered in	5 V
f) <sup>2)</sup>	S10.1 closed	5 V to 6.5 V <sub>ext</sub>
g)	S6 closed	15 V
h)	S7 closed	- 15 V

	Undervoltage monitor active when	Monitored voltage
i)	S9 closed	Input voltage

	Voltage monitor active when ...	Monitored voltage
j)	S1 closed	Auxiliary voltage

	All monitors (a) to (j) active when ...
k) <sup>3)</sup>	S8 in position YE

	All monitors (a) to (j) inactive when ...
l) <sup>3)</sup>	S8 switched over

### Location of jumpers on printed circuit board

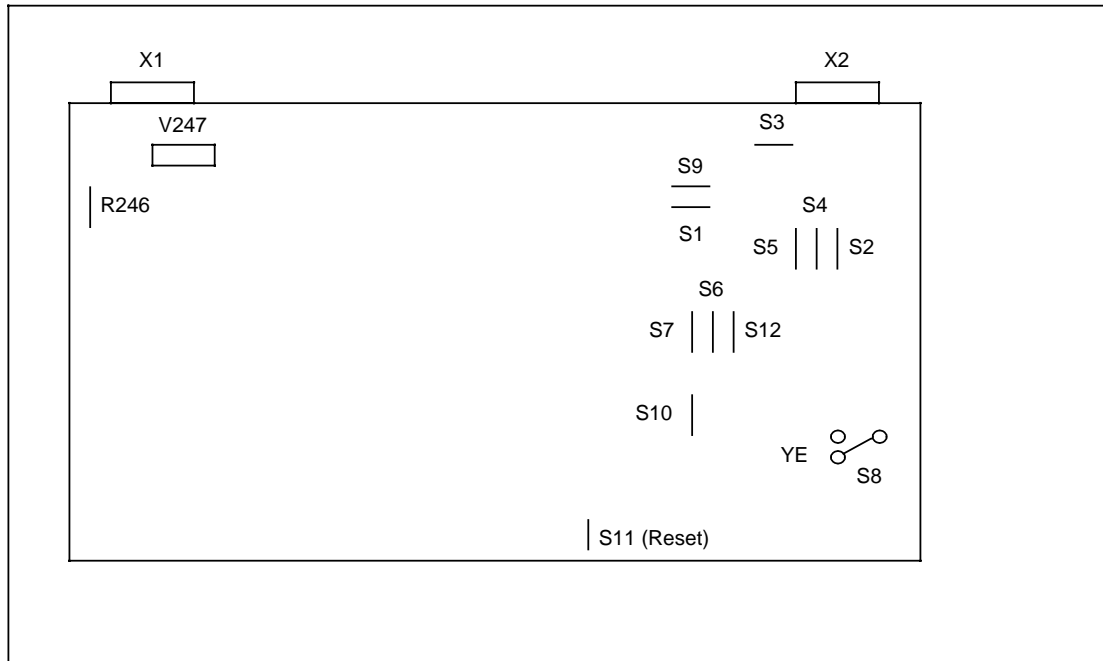

All jumpers are closed or in the switch position shown.

#### Caution!

- With S2 open (undervoltage monitor for internal 5 V disconnected), any 5 V overvoltage results in irreparable damage to thyristor V247 unless resistor R246 is additionally unsoldered. Thyristor V247 is tripped in the event of an overvoltage and briefly reduces the internal 5 V to zero. 5 V overvoltage monitoring is still assured by S12.
- If the 5 V sandwich module is not available, jumper S3 must be opened and jumper S10.1 switched to S10.2.
- Switch S8 should only be used from the test panel:  
With S8 open (all monitors disconnected), a 5 V overvoltage also results in irreparable damage to thyristor V247 unless R246 is unsoldered.

#### Voltages on power supply unit

$$U_N = 230 \text{ V}$$

1L+	(1.2)	X10/7 - X10/8	14.78 V	14.78 V*
2L+	(2.6)	X11.1 - X11/3(M2)	13.7 V	14.7 V*
3L+	(5.2)	X12.6 - M5	- 15.0 V	- 12.8 V*
U <sub>ref2</sub>	(8.5)	X13/18 - M2	2.5 V	2.5 V*
U <sub>ref3</sub>	(5.6)	N573/2 - M5	- 2.5 V	- 2.5 V*
V <sub>DD</sub>	(8.6)	X13/13 - M2	5.1 V	5.1 V*

\* Values for unloaded output

### 4.2.2 6EW1 861-3AA power supply unit (in operator panel)

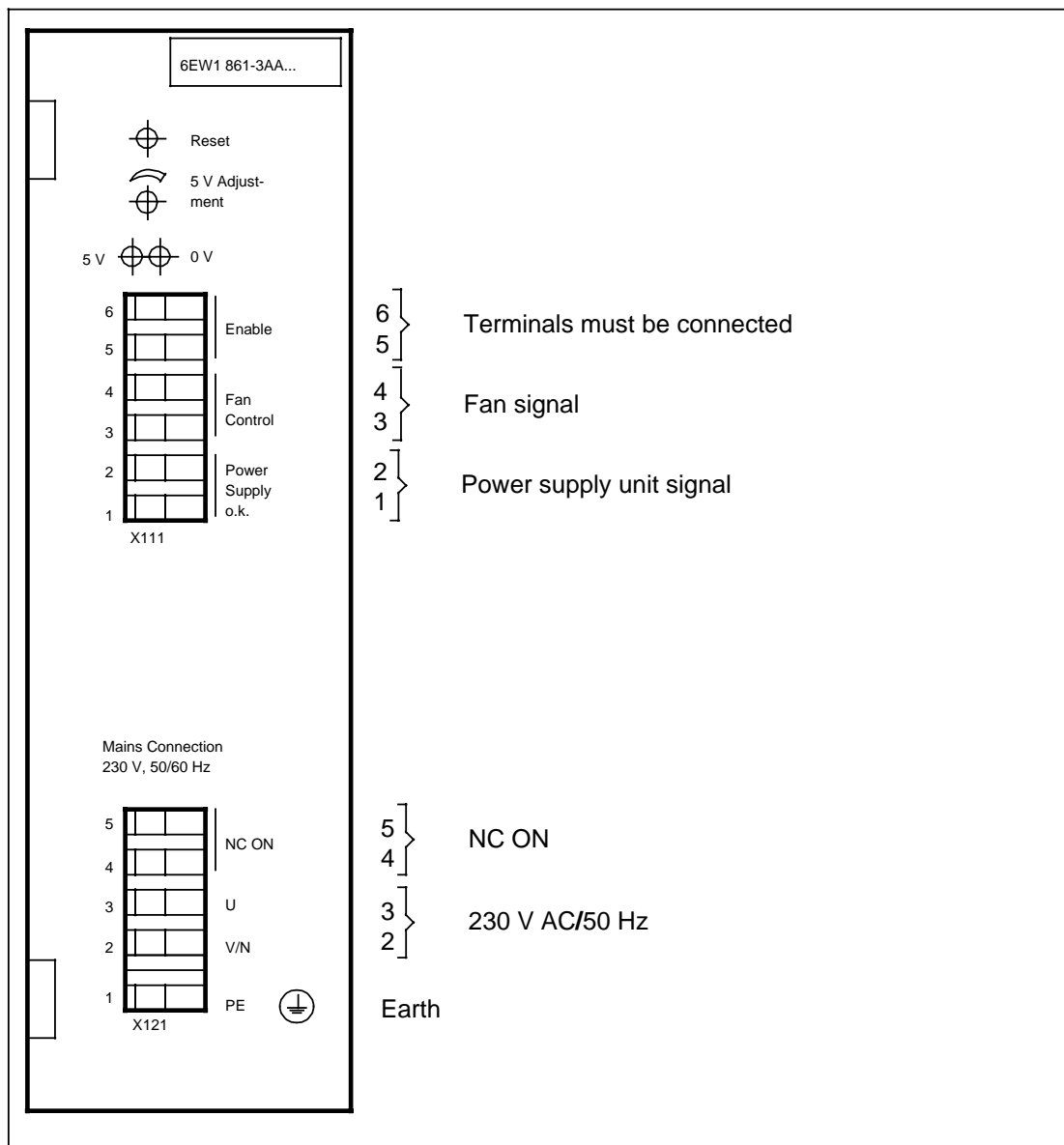

**Caution!**

'NC ON' at the operator panel power supply unit must not be wired parallel to 'NC ON' at the central controller power supply unit (Use control switch with 2 contacts or relay).

### Location of jumpers and measuring points on 6EW1 861-3AA power supply unit

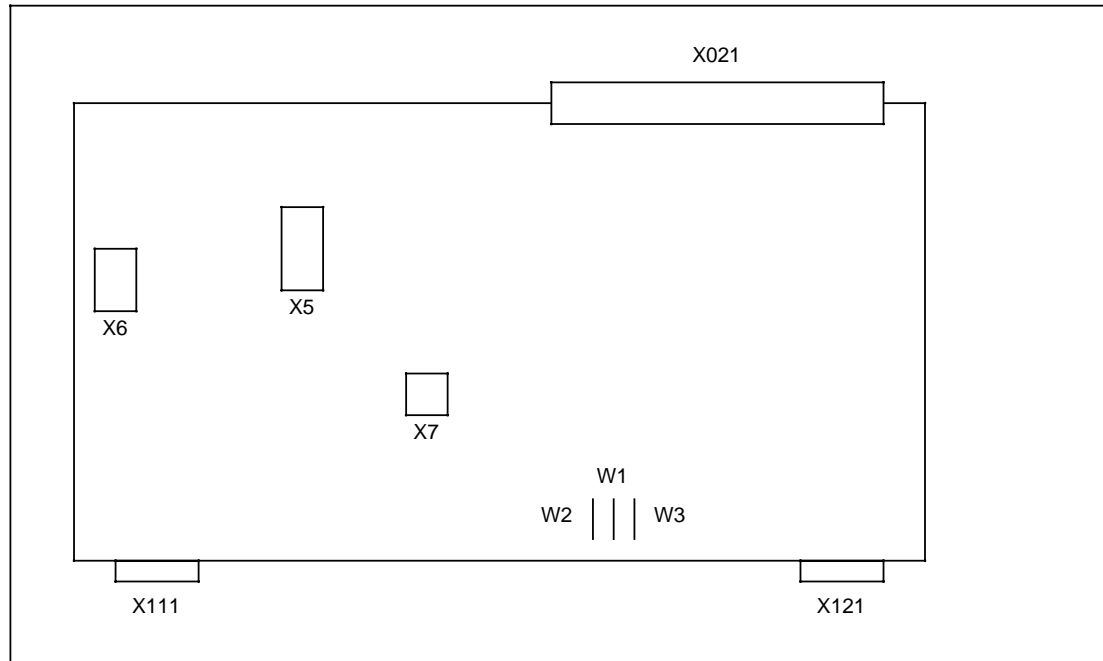

W1	Open
W2	Closed
W3	Open
X5	All jumpers closed
X6	Test pins, secondary side
X7	Test pins, primary side

## 4.3 CPU modules

### 4.3.1 6FX1 120-4BB02 communications CPU (COM CPU) and operator panel CPU (BT CPU)

The communications CPU operates in SYSTEM 800 as a single board computer. In SINUMERIK 880 it is installed in the operator panel (BT CPU) and in the central controller (COM CPU).

#### **Memory**

The following is installed on the module:

- |  |         |            |       |
|--|---------|------------|-------|
| • Internal user memory                       | maximum | 128 Kbytes | RAM   |
| • 2 initial program loaders (RESTART EPROMS) | maximum | 64 Kbytes  | EPROM |

The top part of the user memory (maximum 16 Kbytes) is simultaneously used as a link memory to the multiport controller.

the system software submodules are slotted into memory module 6FX1 128-1BB.

#### **Interfaces**

The module has two serial interfaces for connecting peripheral devices which can handle maximum 9600 baud:

X121	Serial interface 1	BT CPU	(RS232C/TTY)	
X131	Serial interface 2	BT CPU	(RS232C)	- optional
X121	Serial interface 3	COM CPU	(RS232C/TTY)	
X131	Serial interface 4	COM CPU	(RS232C)	- optional
X111	BT CPU and COM CPU:	Operator panel and numerical control are linked via optic fibre cable or copper cable.		

#### **Monitoring**

A watchdog is triggered regularly by the software for monitoring correct program processing. If a fault occurs, the bus signal is activated and the fault is displayed by the LED on the front panel of the module.

Jumperings:	D-E	closed *	
	A-B (R13)	closed *	interface 1
	A-B (R24)	closed *	interface 2

\* Jumperings are closed at the factory.

#### **Caution!**

After the COM CPU has been removed the user memory must be formatted and the part program memory must be erased!



**Connector assignment to operator panel cable**

**MPC INTERFACE**

Connector type: Subminiature D / 25-way

Connector no.: X 111

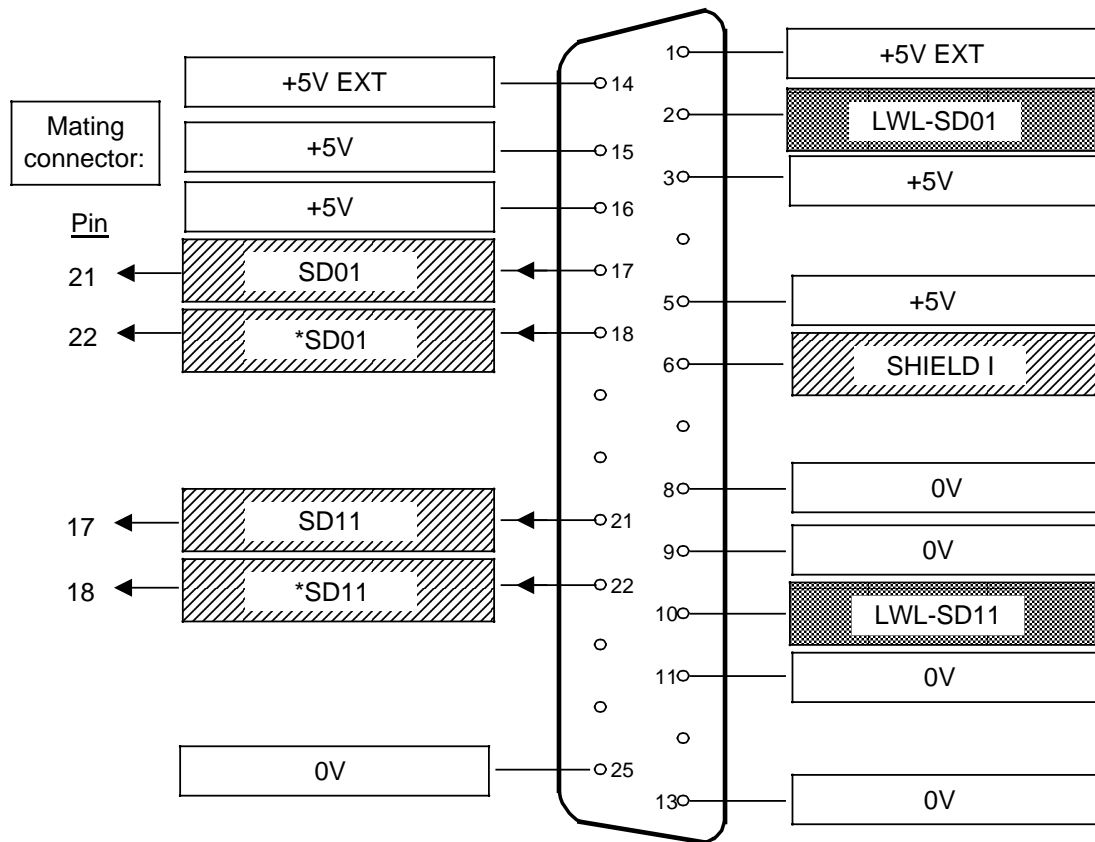

**Explanation:**

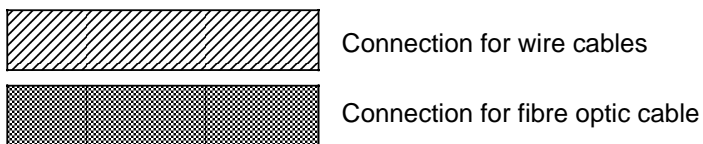

Connector code (code no. 1.1)



**Explanation:**

For connectors → ○ Pin removed  
● Pin not removed

For front panel of printed circuit board → ○ With hole  
● Without hole

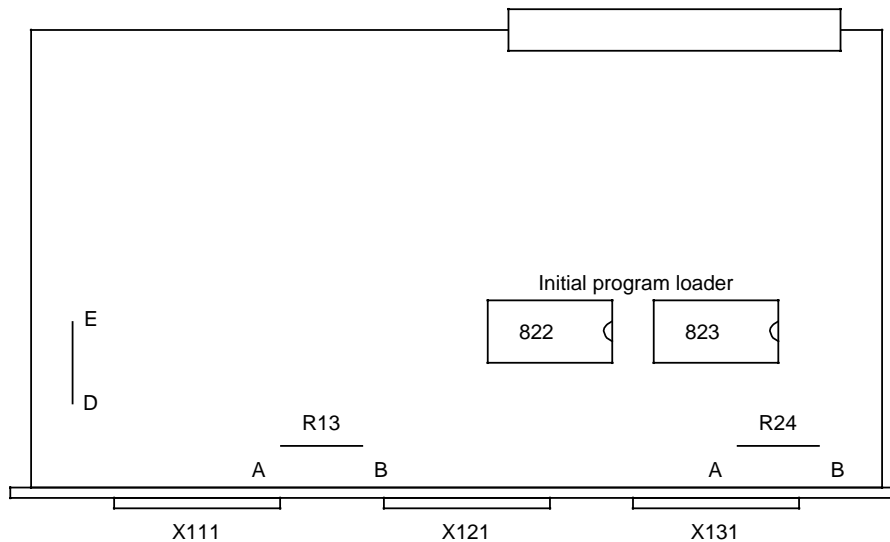
**Printed board showing connector X111 position****4.3.2 6FX1 120-5BB NC CPU**

The NC CPU operates in SINUMERIK 880 as a single board computer.

**Memory**

- Internal user memory max. 64 Kbytes - RAM
  - 2 initial program loaders (RESTART EPROMS) max. 64 Kbytes - EPROM
- are to be found on the board.

The system software is loaded onto memory module 6FX1 128-1BB.

**Bus interfaces**

The module has three independent bus systems:

- Internal bus: to access data from the user memory, initial program loader, status register and module identifier register.
- Local bus: for connecting external, dedicated I/Os.
- Communications bus: for data exchange between several processors and access to common I/Os. Bus arbitration by bus arbiter.

**Jumperings**

No jumperings required.

**Caution!**

Before removing the NC CPU, the channel-specific R parameters, the cycle SDs and the cycle MDs must be backed up, as these are stored on the NC CPU!

### 4.3.3 6FX1 121-3BA SERVO CPU

The servo CPU operates in SINUMERIK 880 as a single board computer. It releases the NC CPU from position and spindle control tasks.

#### **Monitoring**

A watchdog is triggered regularly by the software for monitoring correct program processing. If a fault occurs, a bus signal is activated and the fault is displayed by the LED on the front panel of the module. A fault may have occurred because either the maximum axis/spindle number has been exceeded or because the servo CPU has been overloaded by leadscrew error compensation (check the set position control sampling interval).

#### **Jumperings**

Jumpering of module code on the PAD with jumpers W1 and W2.

#### **Position of jumpers on the servo CPU**

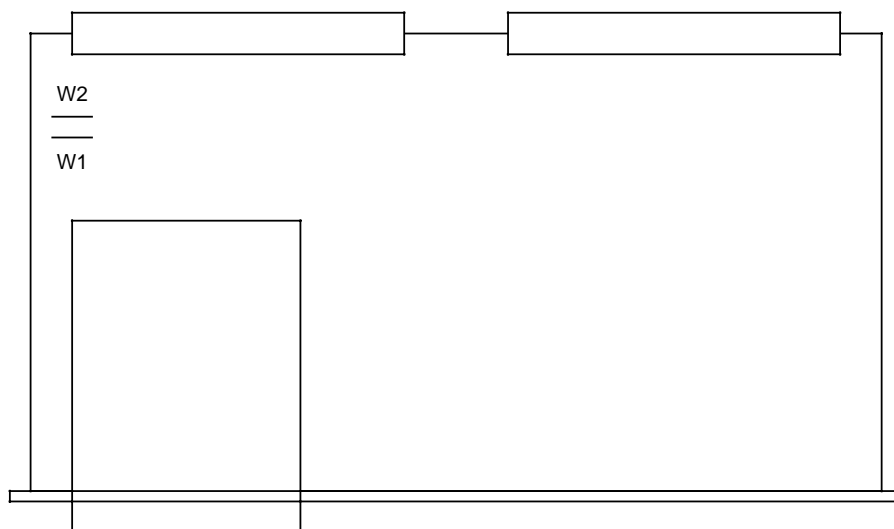

W1, W2 closed - designed on the module

#### **Note:**

The initial program loader software is contained in the system software module, which means that when the software is changed the servo CPU does not have to be removed.

### 4.3.4 6FX1 120-6BA PLC CPU

The PLC CPU operates in SINUMERIK 880 as a single board computer.

#### **Memory**

- Internal user memory 64 Kbytes - RAM
  - 2 initial program loaders (RESTART-EPROMS) max. 64 Kbytes - EPROM
- are to be found on the board.

#### **Brief description**

- The CPU module has 2 96-way backplane connectors, the lower of the two being connected to the local bus. The upper backplane connector is connected to the communications bus.
- A red LED displays error and stop states.
- The initial program loader EPROMS contain the hardware initialization program and the self-diagnostics program for the CPU.
- Battery back-up of the user memory is carried out by the power supply unit battery of the central controller.
- The user memory and the system program memory with the function macros are stored on an external memory module (6FX1 128-1BB). The user memory is either a 64 Kbyte RAM or a 64 Kbyte EPROM (the submodule is slotted into the upper receptacle) and a 32 Kbyte RAM (for data blocks only) which are located on the basic memory board. The submodule containing the system program is slotted into the lower receptacle of the memory module.

#### **Jumperings**

No jumperings required.

### 4.3.5 6FX1 121-8BC or 6FX1 136-8BA multiport

The memory/multiport operates in SINUMERIK 880 (two-tier) as a central link memory, via which the various CPUs of the multi-processor system exchange data. Data relevant to the system (e.g. machine data) are also stored here.

Access is via the bus interfaces.

X041: Local bus on the COM CPU  
X031: Communications bus 1  
X011: Communications bus 2

The module carries the following:

- Arbitration logic circuit to control bus access according to fixed priorities
- Programmable address decoder (PAD)
- On-board RAM memory
- Plug-in memory submodule
- Temperature monitor
- System clock generator
- Two measuring pulse inputs ("inprocess measurement) - non-floating
- Four 24 V inputs according to DIN 19240 (available soon)
- NC Ready (NC BB2) relay output: 20 to 30 V DC
  - 1A with ohmic load
  - 0.5 A with inductive load
  - 2 Hz switching frequency

#### Temperature monitoring

Temperature switch (S4) for central monitoring of the ambient temperature inside the control frame assembly for compliance with 50° C limit.

If the monitor is triggered, F24.2 is reset to 0 and NC alarm 2 "overtemperature" is given. F24.2 should be analyzed by the user in order to perform controlled machine shutdown.

#### Caution!

Because the power supply unit buffer uses the multiport, all the data (including machine data) must be saved before disconnecting the module.

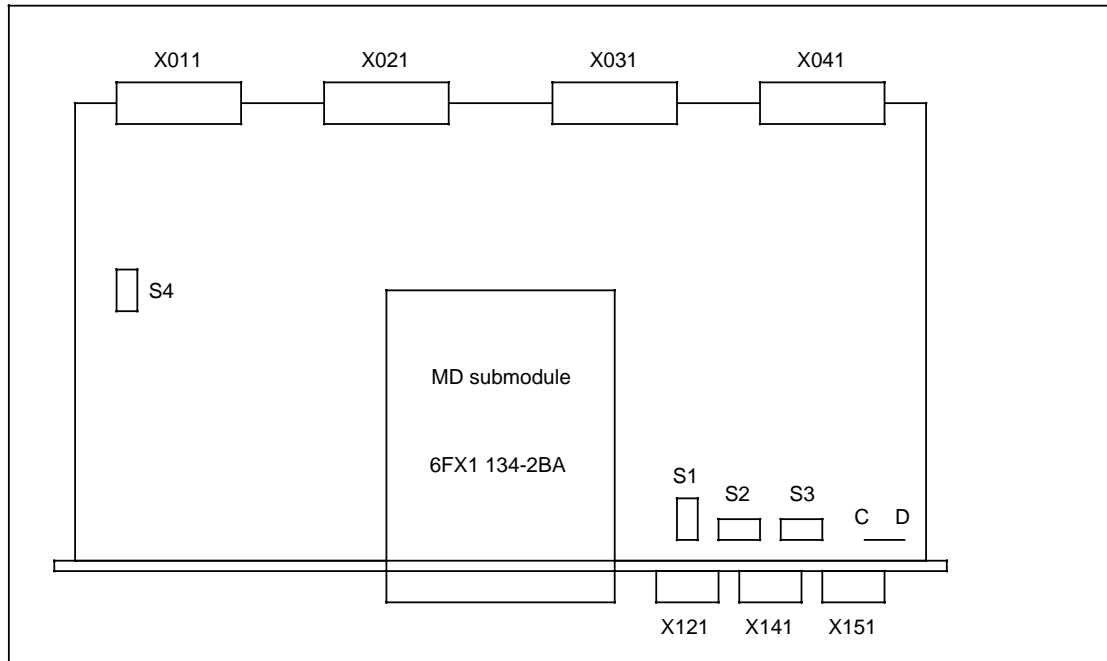



**Location of jumpers and switches on the multiport**

- S1 - DIP-FIX(active signal level, measuring pulse inputs)
- S2 - DIP-FIX(signal level, measuring pulse input sensor 1)
- S3 - DIP-FIX(signal level, measuring pulse input sensor 2)
- S4 - Temperature sensor

Jumper C-D - Open as standard  
(Connection M<sub>ext</sub> (24V) front panel)

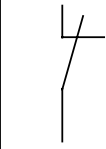
NC READY connection (connector X151) is describes in Interface Part 2.

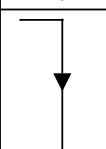
**Jumperings (measuring pulse inputs)**

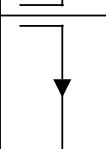
			Sensor 1				Sensor 2			
Operation	Edge	Level	S1.1	S1.2	S2.1	S2.2	S1.3	S1.4	S3.1	S3.2
"open collector" relay contact		open (+ 5V)	closed	open	closed	closed	closed	open	closed	closed
		closed (0V)	open	closed	closed	closed	open	closed	closed	closed
TTL (5V)		+ 5V	closed	open	closed	closed	closed	open	closed	closed
		0V	open	closed	closed	closed	open	closed	closed	closed
24V		+ 24V	closed	open	open	open	closed	open	open	open
		0V	open	closed	open	open	open	closed	open	open

Technical specifications of the measuring pulse inputs:

a. TTL jumpering or "open collector"

Voltage "High"	4.2	to	5.25 Volts
Voltage "Low"	- 1.5	to	1.7 Volts
Power consumption			10 mA

b. Jumpering 24V, DC

Voltage "High"	13	to	30 Volts
Voltage "Low"	- 3	to	5 Volts
Power consumption			10 mA

The maximum delay between receipt of the edge and storage of the actual value is 10  $\mu$ s. The two measuring pulse inputs are non-floating. The maximum cable length to the encoder is 5 m.

**Caution!**

Only **one** of the two measuring pulse inputs must be switched active by the NC program with @ 720.

Terminal block X121

1	0	Measuring pulse	Sensor 1
2	0		
3	0		
4	0	Measuring pulse	Sensor 2
5	0		
6	0		



### 4.3.6 6FX1 124-0BA dualport

The memory/dualport operates in the SINUMERIK 880 (single-tier). See the description of the multiport for function scope and jumperings.

#### Location of jumpers and switches on the dualport

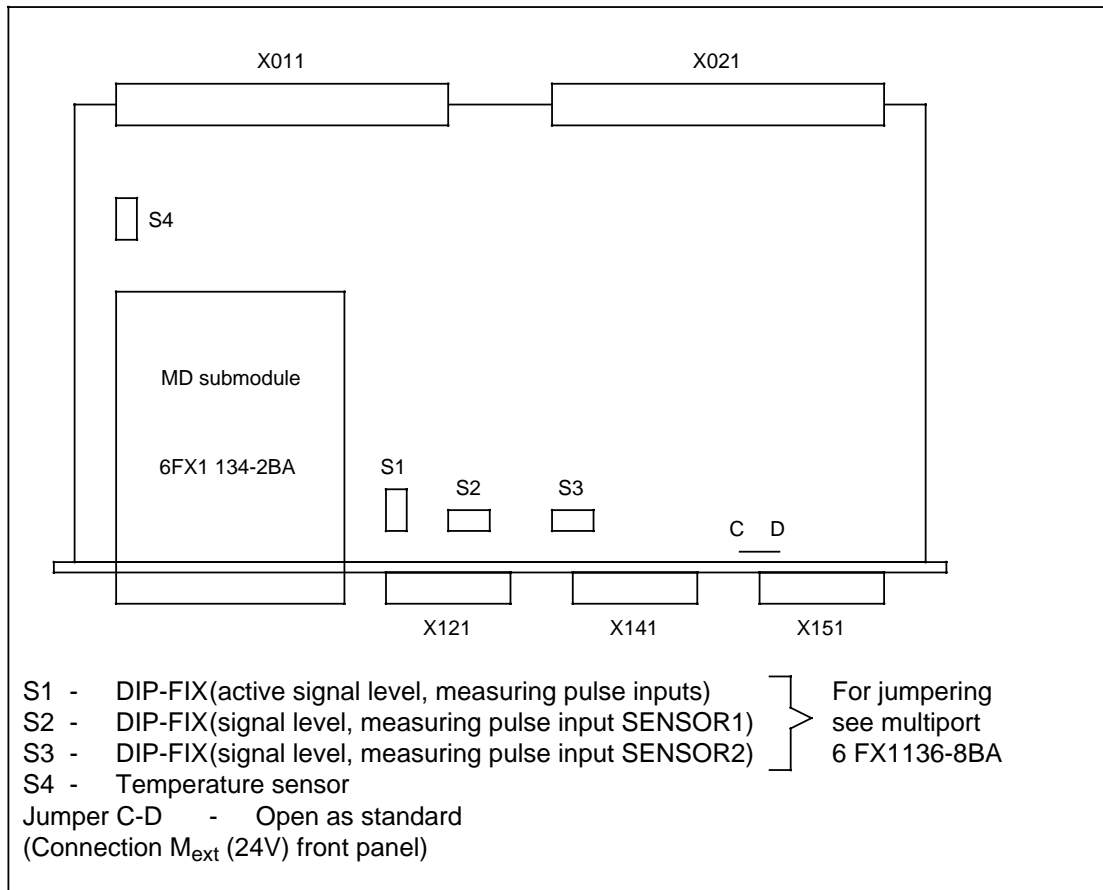

#### Caution!

As the power supply unit battery backup uses the dualport, all the data (including machine data) must be saved before disconnecting the module.

### 4.3.7 6FX1 128-1BB memory module

In SINUMERIK 880 this module is a memory for:

- COM/BT CPU 6FX1 120-4BB (system software and user memory submodule)
- NC CPU 6FX1 120-5BB (system software)
- PLC CPU 6FX1 120-6BA (operating system and PLC user program)

#### Memory submodules

The memory module can either operate as a pure RAM module or as a combined RAM/EPROM module. 32 Kbytes of CMOS RAM which can be battery backed are always available on the basic memory board. Up to three memory submodules can be slotted into the module to extend the memory.

#### Jumperings

No jumperings are required.

### 4.3.8 6FX1 126-7BA memory module

The module operates in SINUMERIK 880 as a basic module for plug-in RAM submodules (part program memory).

#### Memory submodules

The following submodules are used:

- 6FX1 126-6BA (128 Kb)
- 6FX1 135-3BA (256 Kb)

#### Jumperings

W1 and W2 are closed (designed on the module).

#### Jumperings on memory module 6FX1 126-7BA

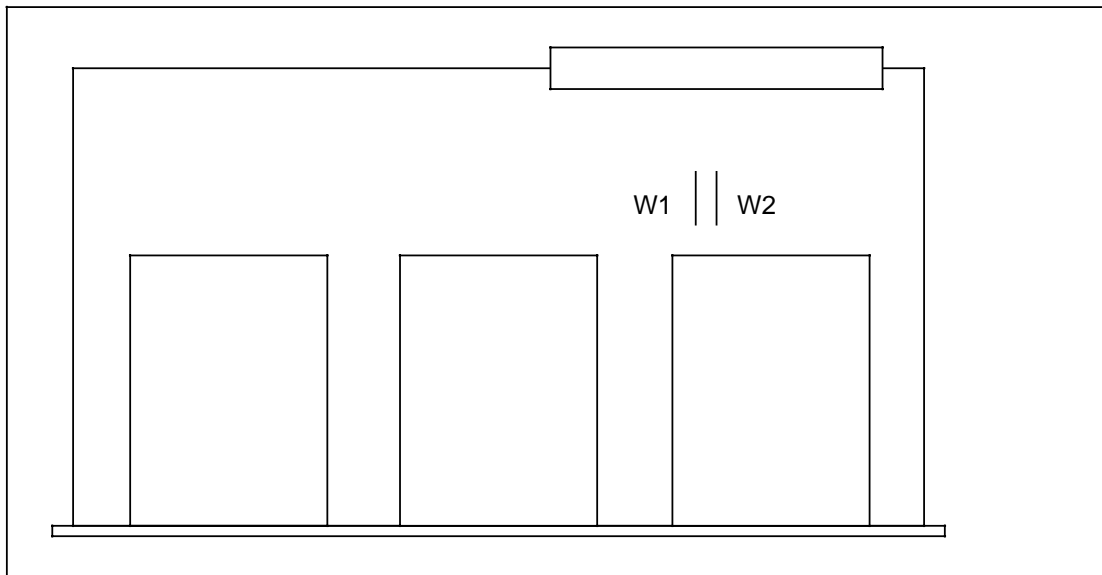

## 4.4 EPROM/RAM submodule

### 4.4.1 6FX1 128-4B. EPROM submodule

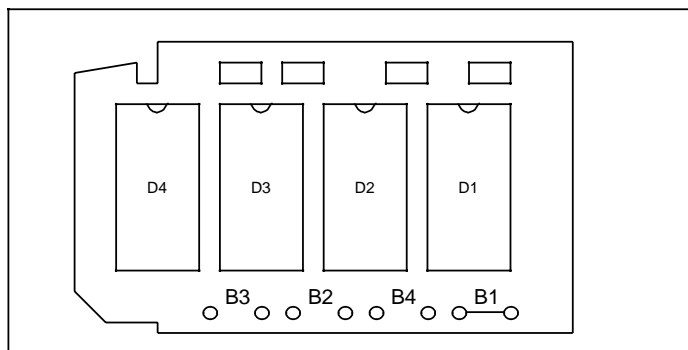

In SINUMERIK 880 this submodule is used to store the system software and also as a user memory submodule with EPROM Type 27512. If the submodules are delivered with software, the submodule designation refers to the software delivered with it. In case of doubt, the submodule type can be identified with reference to the GWE item number. This is 570 **284** ... and is derived from the machine-readable product designation (6FX1 **128-4**).

If only two memory chips are used, insert them in sockets D1 and D3.

#### Jumperings

Memory \ Jumper	1	2	3	4
2* 27512 (128 Kbytes)				X
4* 27512 (256 Kbytes)	X			X

X=Jumper closed

#### 4.4.2 6FX1 126-0B. EPROM-RAM submodule

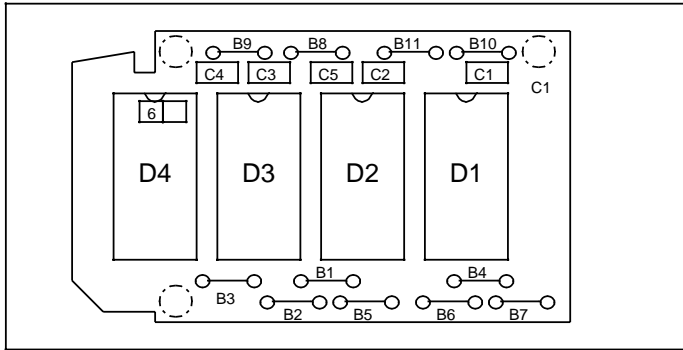

In SINUMERIK 80 this submodule can be used as a user memory submodule and as a memory for the PLC user program (EPROM Type 27256).

**Note:**

RAM submodules 6FX1 126-0BL and 6FX1 126-0BM cannot be used in the PLC.

**Jumperings**

Jumper \ Memory	1	2	3	4	5	6	7	8	9	10	11
2* 27256 (64 Kbyte)			X		X	X		X		X	
4* 27256 (128 Kbyte)	X		X		X	X		X		X	
2* 6264 (16 Kbyte)		X			X		X		X		X
4* 6264 (32 Kbyte)	X	X			X		X		X		X

X=Jumper closed

- All jumpers not required are drilled open.
- If required (on 27256!), jumper B8 must be created with a wire jumper (jumper not easily accessible).
- Capacitor C5 must be removed if the submodule is used as a user memory submodule.
- The submodule with 2\*27256 is suitable for use as a memory for the PLC user program (program number 162).
- If only two memory chips are used, they are inserted in sockets D1 and D3.

### 4.4.3 6FX1 135-3BA00 submodule (SMD)

This submodule serves as a part program memory and as a memory for the data programmed on the WS800 (user memory submodule). It has a storage of 256 KB. The data is lost when the submodule is removed.

It is used in the following modules on SINUMERIK 880:

- 6FX1 126-7BA01
- 6FX1 128-1BB00 (insertion only in bottom slot as user memory submodule)

#### Jumperings

No jumperings required.

### 4.4.4 6FX1 126-6BA submodule (SMD)

This submodule serves as a part program memory and as a memory for the data programmed on the WS800 (user memory submodule). It has a storage capacity of 128 KB. The data is lost when the submodule is removed.

It is used in the following modules in SINUMERIK 880:

- 6FX1 126-7BA
- 6FX1 128-1BB (insertion only in bottom slot as user memory submodule)

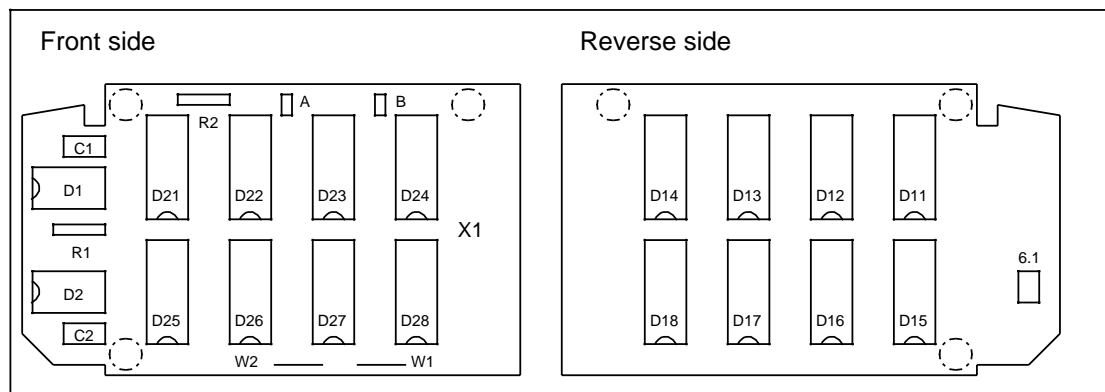

Memory: 128 Kbyte CMOS-RAM (HM 6264)

#### Jumperings

- W1 Closed
- W2 Open

#### 4.4.5 6FX1 126-6BB00 submodule (SMD)

This submodule serves as a memory for the PLC user program and has a storage capacity of 64 KB. It is inserted in the top slot of module 6FX1 128-1BB. The data is lost when the submodule is removed.

##### **Jumperings**

No jumperings required.

#### 4.4.6 6FX1 134-2BA01 RAM submodule (128kB) 6FX1 134-2BC01 RAM submodule (without battery)

This submodule serves as a memory for machine data and as a link memory. It is used in the multiport/dualport and includes a lithium battery (Type: 5135 Tadiran/3.6 V). The battery has a life of approx. 2.8 years. If Alarm 6 occurs (battery alarm - machine data), the complete RAM submodule should be renewed. Alarm 6 is given when the battery voltage falls below 2.8 V.

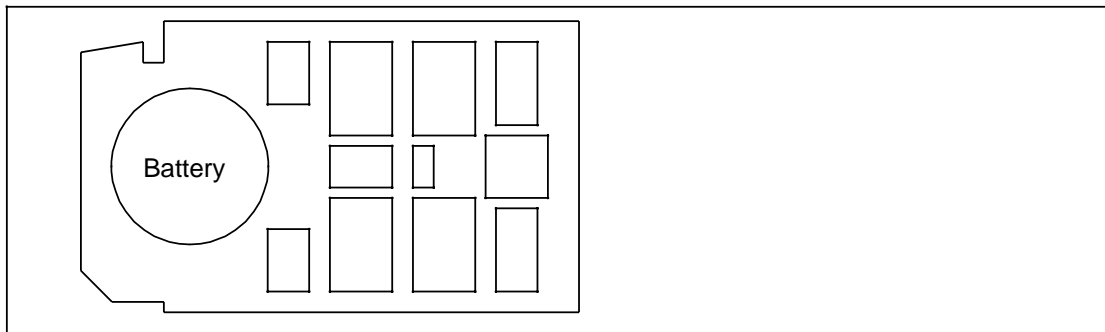

##### **Links**

No links are provided.

##### **Jumperings**

No jumperings required.

##### **Caution!**

Since september 1989 a RAM submodule has been used without a soldered-in battery and is supplied with power from the central backup battery (in addition to the power supply). Now all NC/PLC MDs etc. are lost if the multiport, dualport or RAM submodule is removed.

## 4.5 6FX1 121-4B. measuring circuit module

Printed circuit board type 6FX1 121-4B. is a module for interfacing 3 axes with analog speed controllers and incremental position encoders to System 800 NC controls.

The printed circuit board comprises the following functions for each axis:

- Actual position generation
- Analog set value output  
Range:  $\pm 10$  V, resolution: 1.2 mV
- Servo enable  
+ 24 V control output, 100 mA, P switch, short-circuit-proof
- Inputs for inprocess measurement  
axis-specific + 24 v inputs and a bus test signal (not analyzed on SINUMERIK 880)

### Actual position generation

The actual position generation comprises a CMOS gate array (SPC = Speed and Position Controller) integrating the hardware required for the following functions:

- Actual position generation with four-fold pulse multiplication
- Approach to reference point
- Monitoring with
  - Encoder slipped cycles
  - Encoder open circuit

### Servo enable

The "set value 0 relay" has been omitted. However, provisions have been made to ensure that the servo enables at the measuring circuit and the PLC outputs are deselected when the control is switched off before a voltage surge is output at the set speed value output of the measuring circuit (as a result of asynchronous voltage collapse of the +15 V and -15 V voltage supply).

This is an especially important point in the installation and start-up phase when the drive servo enables may be permanently preset.

The signal driving the P switch is not floating, so that the M (0 V ref) potential of the control and that of the drive controller input must be the same.

The P switch is protected against:

- overloading, by internal current limiting and thermal overload protection
- reverse currents and demagnetization voltage peaks, by a diode network.

Incremental measuring systems with:

- rectangular output signals or
- sinusoidal output signals

can be connected to the printed circuit board.

For measuring systems with sinusoidal output signals, EXE submodules have to be connected to the printed circuit board. This facility is available only on printed circuit board version 6FX1 121-4BB01. The maximum possible sampling frequency of the measuring system is shown in the following table.

Encoder input signal	EXE submodule type	Max. encoder sampling frequency	Multiplication factor
Rectangular	- - -	1 MHz	4
Sinusoidal	03390 03395	20 KHz 10 KHz	20 40

EXE submodules on the printed circuit board

PCB axis No.	EXE submodule
1	03390 or 03395
2	03390 or 03395*)
3	03390 *)

### Encoder power supply

As standard, the encoders are supplied with

$$U_{\text{PCB connector}} = + 5.0\text{V} + 1 \%$$

To compensate for voltage drop in the supply lines, the encoders can be supplied with

$$U_{\text{PCB connector}} = + 5\text{V EXT.}$$

The 5 V EXT voltage can be adjusted at the power supply unit for all axes together (not provided as standard). In exceptional cases, a single encoder supply voltage can be set additionally with a series resistor (see figure next page).

- Open changeover switch
- Solder in series resistor

$$\text{Value: } R = \frac{U}{I_{\text{Encoder}}}$$

U = Overvoltage measured at encoder.

\*) If PCB axis No. 2 is equipped with a ten-fold EXE SUBMODULE, PCB axis No. 3 cannot be equipped with an EXE submodule



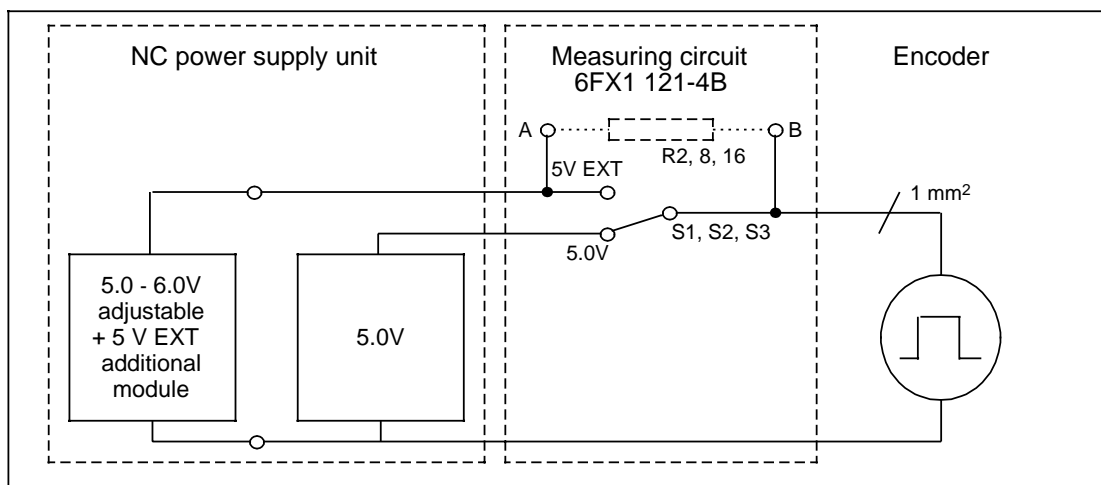

Voltage for the encoder power supply

### Jumperings on the circuit board

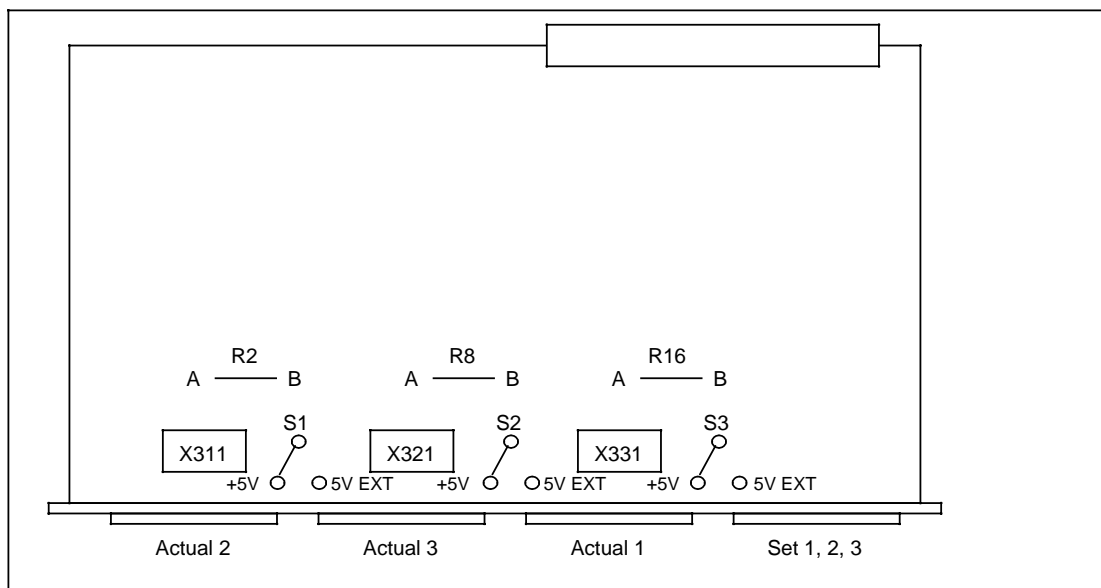

As standard, the encoders are supplied with + 5V + 1 %.

Axis No.	Changeover switch	Position
1	S3	+ 5V
2	S1	+ 5V
3	S2	+ 5V

To compensate for voltage drop in the supply lines, the encoders can be supplied with + 5 V EXT if the power supply unit is equipped with a + 5 V EXT submodule (Power supply 6EW1 861-2B.).

With resistors R2, R8 and R16 it is possible to adapt the voltage to the distance to the encoder (wire resistor, 3 Watts, type G0202).

Axis No.	Changeover switch	Position	Resistor
1	S3	+ 5V EXT	R16
2	S1	+ 5V EXT	R2
3	S2	+ 5V EXT	R8

The EXE inputs must be disconnected from the differential receiver inputs by removing the relevant jumper plugs (if equipped with internal EXE 03390 or 03395).

Axis No.	Jumper plug
1	X 331
2	X 311
3	X 321

Separate encoder supply voltages can be set with resistors R2, R8 and R16 (not provided as standard).

### Jumperings

The SINUMERIK 880 counts through the modules from left to right when the POWER ON signal is given and jumpers them automatically.

## 4.6 Fast input/outputs in the servo area (SINUMERIK 880N only)

The SINUMERIK 880N has input/output modules in the local bus area of the servo CPU. Either a mixed I/O module is used (Section 4.6.1) or an input and an output module (Section 4.6.2 and 4.6.3).

### 4.6.1 Mixed I/O module

From Software Version 4 the SINUMERIK 880N is supplied with the mixed I/O module (6FX 1138-4BA01) as a standard. This module has 16 digital inputs (floating, 2 isolated groups of 8), 16 digital outputs (floating, 24 V/400 mA, 2 isolated groups of 8, short-circuit proof) and 4 analog outputs ( $\pm 10V/3 mA$ ). The assignment of the individual input/outputs is as follows:

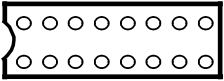
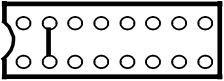
Mixed I/O module	Socket X1 (DIP-FIX switch) digital input/outputs	Socket X1 (DIP-FIX switch) digital input/outputs
		

The DIP-FIX switches are on top of the edge connector for the local bus.

#### Caution!

It is essential to connect the external earths. Otherwise no function controls from external are possible!!!

**Analog outputs**

Front connector designation: X111

Signal	Function	Pin
shield	Shield front panel potential	1
aouts 1	Analog output signal 1: laser voltage 1	9
aoutg 1	Earth analog output signal 1: laser voltage 1	2
shield	Shield front panel potential	10
aouts 2	Analog output signal 2: laser voltage 2	3
aoutg 2	Earth analog output signal 2: laser voltage 2	11
shield	Shield front panel potential	4
aouts 3	Analog output signal 3	12
aoutg 3	Earth analog output signal 3	5
shield	Shield front panel potential	13
aouts 4	Analog output signal 4	6
aoutg 4	Earth analog output signal 4	14
shield	Shield front panel potential	7
-	free	15
-	free	8

### Digital inputs/outputs

Front connector designation: X121

Byte/bit	Function	Pin	
out 0.0	Initiate punch	1	
out 0.1	I-Kill (integrator short-circuit)	20	
out 0.2	M*26	2	*=0 to 3 configurable
out 0.3	M*27	21	NC MC 5056 bits 2+3
out 0.4	Configurable fast M function (MD 243)	3	
out 0.5	Punch active	22	
out 0.6	M*22	4	
out 0.7	M*24	23	
mext 1	M ext for output byte 0	5	
out 1.0	Mx00/Mx10	24	x=1 to 4 configurable
out 1.1	Mx01/Mx11	6	NC MD 5028 Bit 6+7
out 1.2	Mx02/Mx12	25	
out 1.3	Mx03/Mx13	7	
out 1.4	Mx04/Mx14	26	
out 1.5	Mx05/Mx15	8	
out 1.6	Mx06/Mx16	27	
out 1.7	Mx07/Mx17	9	
mext 2	M ext for output byte 1	28	
in 0.0	Punch outside the workpiece	10	
in 0.1	No rapid stop of all axes	29	
in 0.2	No rapid stop of all axes	11	
in 0.3	Override laser voltage 1 $2^0$	30	
in 0.4	Override laser voltage 1 $2^1$	12	
in 0.5	Override lase voltage 1 $2^2$	31	
in 0.6	RESET 2nd output byte fast M function	13	
in 0.7	Disable all rapid outputs	32	
mext 3	M ext for input byte 0	14	
in 1.0	Override retrace $2^0$	33	
in 1.1	Override retrace $2^1$	15	
in 1.2	Override retrace $2^2$	34	
in 1.3	Retrace active	16	
in 1.4	Retraction on the contour	35	
in 1.5	Travel to point of interruption	17	
in 1.6	Manual initiation of the punch	36	
in 1.7	Nibbel dry run	18	
mext 4	M ext for input byte 1	37	
-	free	19	

**4.6.2 INPUT module 6FX1125-7BA00 (257)**

Socket X1 = all switches OFF

Socket X2 = all switches ON

Connector designation: X 111

Slot: Local bus of the servo area

Byte/bit	Function	Pin
0.0	Punch outside the workpiece	1
0.1	No rapid stop of all axes	20
0.2	No rapid stop of all axes	2
0.3	Override laser voltage 1 $2^0$	21
0.4	Override laser voltage 1 $2^1$	3
0.5	Override laser voltage 1 $2^2$	22
0.6	RESET 2nd output byte fast M function	4
0.7	Disable all rapid outputs	23
	M ext for input byte 0	5

Bit 0.0 must always be 1 signal, if the axes are to be traversed (wire-break protection)

Bit 1 Bit 2 These bits must be 1, if the axes are to be traversed.

Byte/bit	Function	Pin
1.0	Override retrace $2^0$	24
1.1	Override retrace $2^1$	6
1.2	Override retrace $2^2$	25
1.3	Retrace active	7
1.4	Retraction on the contour	26
1.5	Travel to point of interruption	8
1.6	Manual initiation of the punch	27
1.7	Nibbel dry run	9
	M ext for input byte 1	28

**Caution!**

It is essential to connect the external earths. Otherwise no function controls from external are possible!!!

### 4.6.3 OUTPUT module 6FX1122-8BA01 (228)

Socket X1 = all switches OFF

Connector designation: X 121

Slot: Local bus of the servo area

Byte/bit	Function	Pin
0.0	Initiate punch	1
0.1	I-Kill (integrator short-circuit)	2
0.2	M*26	3
0.3	M*27	4
0.4	M*28	6
0.5	Punch active	7
0.6	M*22	8
0.7	M*24	9
	M ext.	5

\*=0 to 3 configurable  
 (NC MD 5056 bits  
 2+3)

Byte/bit	Function	Pin
1.0	Mx00/Mx10	10
1.1	Mx01/Mx11	11
1.2	Mx02/Mx12	12
1.3	Mx03/Mx13	13
1.4	Mx04/Mx14	15
1.5	Mx05/Mx15	16
1.6	Mx06/Mx16	17
1.7	Mx07/Mx17	18
	M ext.	14

x=1 to 4 configurable  
 (NC MD 5028 bits  
 6+7)

Connector designation X 111:  
 0 V as designated  
 24 V as designated

**Caution!**

It is very essential to connect the external earths. Otherwise no function controls from external are possible!!!

## 4.7 6FX1 121-2BB02 interface module

Module 6FX1 121-2BB02 is used in SINUMERIK 880. It is a double-height Eurocard and carries out the following functions in the control:

- Links the operator panel keyboard via bus II with the system bus
- Links the I/O modules (a maximum of 4 I/O modules can be connected to the system bus)
- Provides an interface for a memory submodule (RAM or EPROM) with max. 128 Kbyte memory capacity (not used in SINUMERIK 880)
- Provides two identical interfaces for sensors in "inprocess measurement" mode (for SINUMERIK 810 only).

In the case of SINUMERIK 880, the module is inserted in the operator panel unit. The inputs for "inprocess measurement" can then not be used.

Connector: X111: Not used with SINUMERIK 880  
X131: Bus cable to I/O module

### Jumperings

A - B  $M_{\text{ext}}$  connected to 0 V

### Position of jumpers on interface module 6FX1 121-2BB02

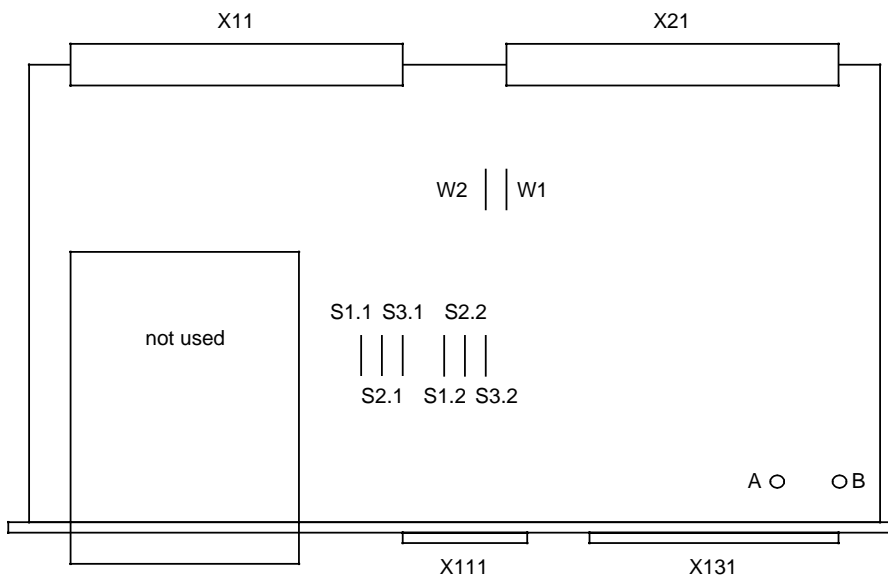

Jumper A - B - Open  
W1, W2 - Closed  
S1 - S3 - Jumpering for Probe (of no relevance to SINUMERIK 880)



## 4.8 6FX1 126-1AA03 video module

The CPU board is used to control monochrome and colour monitors in CHARACTER and GRAPHICS MODE. The GPM DISPLAY MEMORY expansion board is required for GRAPHICS MODE in colour.

The CPU has the following interfaces:

- NC bus: connector X02831
- GPM: connector X02833
- Monitor rack: connector X111

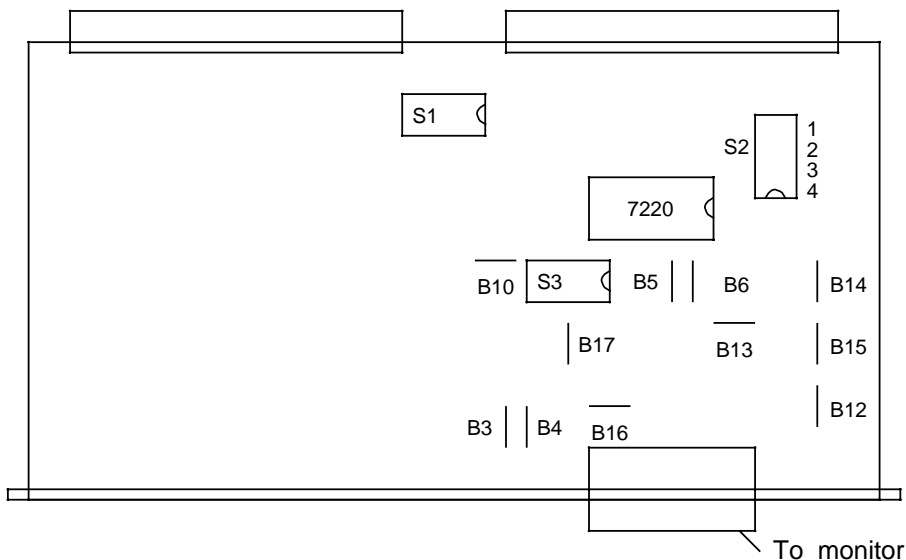

Switch, Jumper	Jumpering
S1	
S2	
S3	
B3	
B4	
B5	
B6	
B10	
B12	
B13	
B14	
B15	
B16	
B17	

Date: 7/85

\* Jumper 4-5 must be removed if a monochrome monitor is used

**Note:**

It is important to check S1 and S3, because these jumperings are not always set for SINUMERIK 850/SINUMERIK 880 on a module which is supplied as a spare part.

## 4.9 6FX1 126-4AA colour image memory

No jumperings are required.

### 4.10 Colour monitor

#### **Notes on adjustment:**

The colour monitor adjustment must only be carried out by trained personnel using the correct tools (balancing screwdriver etc.).

The guidelines issued by the Federal German Employers' Liability Insurance Association for Precision Mechanics and Electrical Engineering must always be followed:

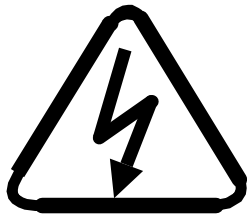

CAUTION!

High voltage  
Danger to life

The monitors are generally correctly adjusted at the factory; however, aging and the effect of heat can make readjustment necessary.

The colour potentiometers are located on the printed circuit board and can be accessed relatively easily through the operator panel cover. They are permanently set and should not be altered unless absolutely necessary.

The potentiometers for focus and contrast can also be accessed through the operator panel cover.

The potentiometers for picture hold and adjustment are located on the basic board and are very difficult to access (partially covered by the picture tube).

Potentiometers must only be altered using a suitable balancing screwdriver.

VR	403	Vertical adjustment picture centre
VR	506	Horizontal adjustment picture centre
VR	402	Picture height
L	501	Picture width
VR	401	Vertical picture scrolling
VR	502	Horizontal picture scrolling

## PCB CRT VR and connector location

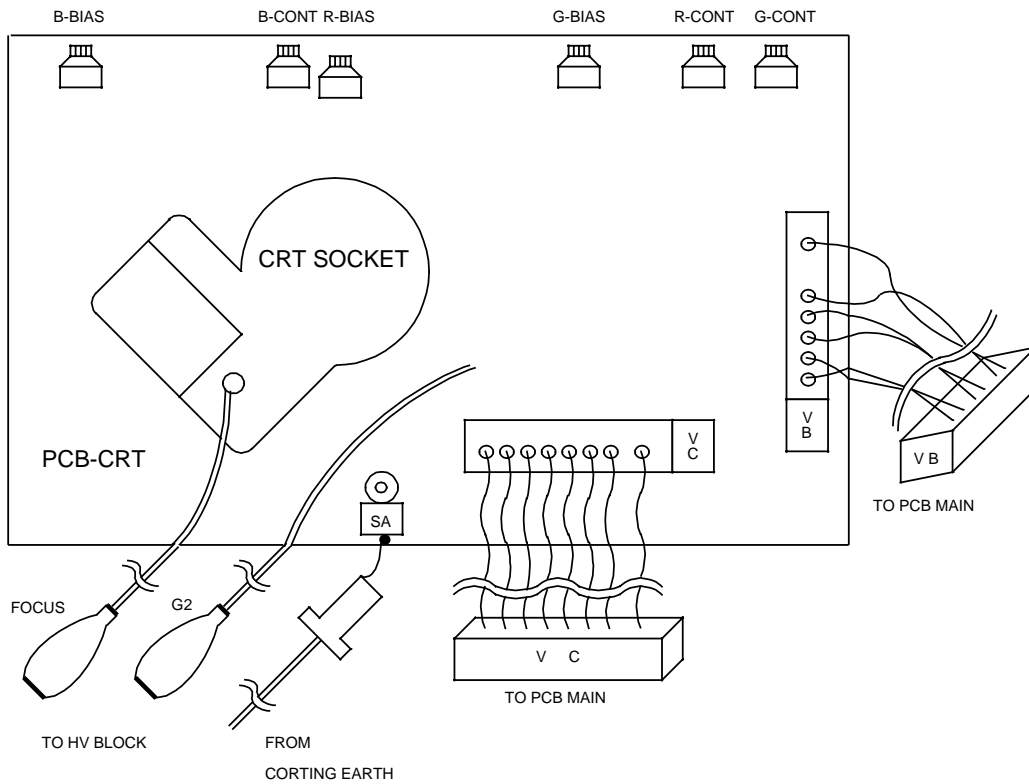

R: Red channel  
G: Green channel  
B: Blue channel

BIAS: Voltage adjustment of each cathode

CONT: Signal output level adjustment

VR 201 R-CONT

VR 231 G-CONT

VR 261 B-CONT

VR 202 R-BIAS

VR 202 R-BIAS

VR 262 B-BIAS

PCB MAIN connector, VR location

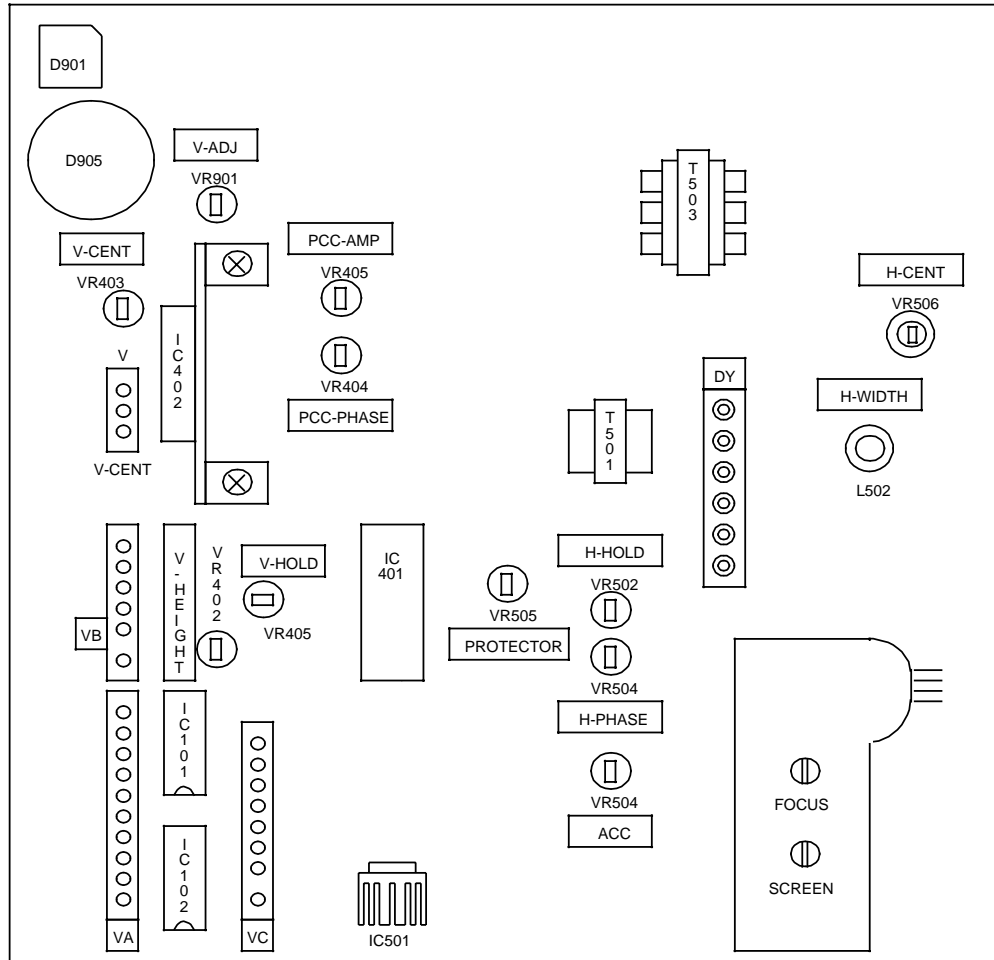

## 4.11 6FX1 124-6AA02 input/output module

### **General functional description**

With printed circuit board 6FX1124-6AA02 the machine operator panel and machine control panel can be linked economically to the central control logic via the operator panel bus.

64 (8 x 8 bits) non-floating inputs, 24 (3 x 8 bits) non-floating short-circuit-proof 0.5 A outputs and 8 non-floating 100 mA outputs which are not short-circuit-proof are located on the module.

The module is designed in such a way that it can be attached behind the machine control panel.

In SINUMERIK 880 4 modules are addressable, the two coding switches S1 and S2 (inputs and outputs separate) are used to select the board.

The module has a 50-way ribbon cable connector through which data, addresses and control signals are transferred to the operator panel. The machine control panel is connected by three 34-way plug connectors (X02405, X02404, X02402) and one 10-way plug connector. X02404 connects 32 input signals to the machine control panel and X02405 has a further 32 input signals for connecting signals for customer applications. X02402 can be assigned with 32 output signals for customer applications.

<b>Input voltage</b>	"High" :	+14V	to	30 V
	"Low" :	- 3V	to	5 V

<b>Input current</b>	"High" :	>4.35 mA	to	< 6.55 mA
	"Low" :	0 mA	to	< 0.03 mA

I/O MODULE                      6FX1124-6AA02

- 32 inputs 24 V
- 32 inputs 24 V (10 of which have a double assignment -> expansion module for machine control panel)
- 24 400 mA outputs, 24 V, short-circuit-proof.  
A short circuit is indicated by red LED V35, V36 or V37.
- 8 100 mA outputs, 24 V, not short-circuit-proof
- Voltage connection to +24 V and M-out

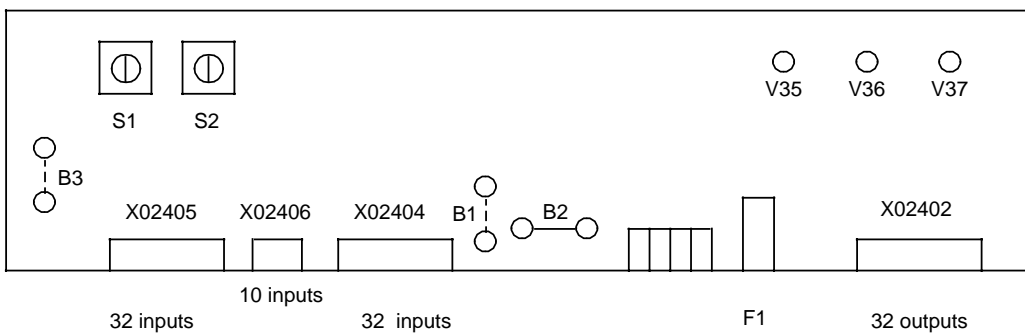

**State of jumpers:**

- B1 open
- B2 closed
- B3 open

F1... 6.3 A fuse  
 for outputs and external  
 machine control panel

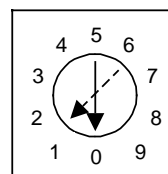

S1,S2

Red LED	V 37	V 36	V 35	No LED
Module 1	AB64	AB65	AB66	AB67
Module 2	AB68	AB69	AB70	AB71
max. current	400 mA	400 mA	400 mA	100 mA

**Note:**

Simultaneity factor 50 %

	Module 1	Module 2	Module 3	Module 4
S1 (inputs)	0	1	2	3
S2 (outputs)	0	1	2	3

**4.12 6FX1 125-7BA input module**

Module 6FX1 125-7BA is used on the NC, servo and PLC local bus as an input module for process signals (+24 V level). 64 isolated inputs are located on the module. Interference on the mass line (caused by circulating currents) is suppressed by optocouplers. All input signals on the module are also filtered through RC elements. In this way inductive and capacitive interference shorter than two milliseconds is eliminated.

**Initial address setting on input module 6FX1 125-7BA**

Initial address (hex.)	Input byte (dec.)	Socket X1 (DIP FIX)	Socket X2	Socket X2
- - - 0 0	0 - 7			
- - - 0 8	8 - 15			
- - - 1 0	16 - 23			
- - - 1 8	24 - 31			
- - - 2 0	32 - 39			
- - - 2 8	40 - 47			
- - - 3 0	48 - 55			
- - - 3 8	56 - 63			
- - - 4 0	64 - 71			
- - - E 0	224 - 231			
- - - E 8	232 - 239			
- - - F 0	240 - 247			
- - - F 8	248 - 255			



### **Location of jumper sockets and jumpers on input module 6FX1 125-7BA**

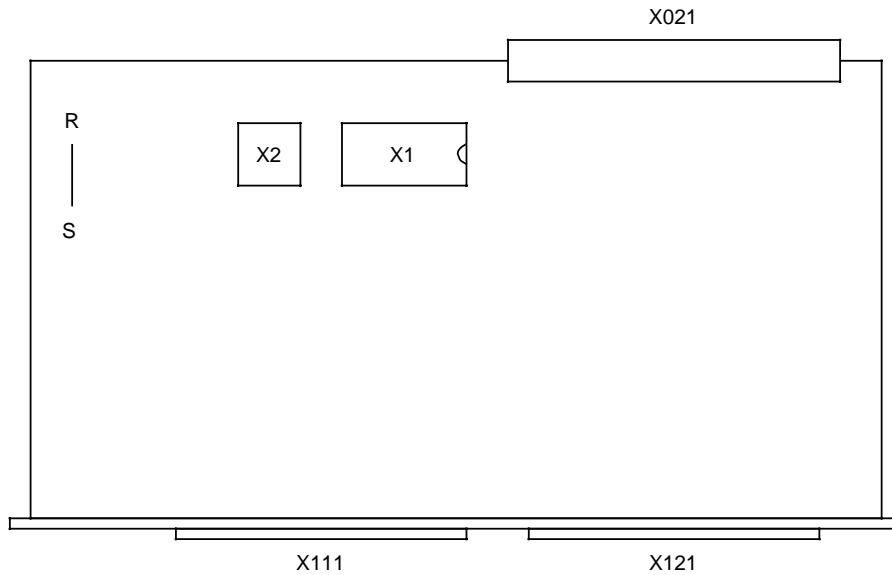

- X1 - Initial address setting  
X2 - All 3 jumpers (U-P, M-N, K-L) are closed as standard
- Jumper R - S - Closed as standard

### **4.13 6FX1 122-8B output module**

In the SINUMERIK 800 system, module 6FX1 122-8B can be installed on the NC servo and PLC local bus.

As usual with SINUMERIK systems, the outputs have an externally connected +24 V power supply at a faston connector (X111 and X141). The module has a total of 32 isolated outputs in groups of 16 available via 2 front-panel connectors (X121 and X131) at the interface.

The outputs are short-circuit-proof and can be connected in parallel for increased capacity. Output overloading and short circuits are indicated by a visual alarm (red LED) on the module front panel. Monitoring is word by word.

#### ***Equipment variants of the output module***

- 0.5 A version (6FX1 122-8BA) with 20 mm front panel. This version can be operated with a 100 % simultaneity factor if installed in a system with good supply of intake air.
- 2 A version (6FX1 122-8BB) with 40 mm front panel. This version can be operated only with a 50 % simultaneity factor.

**Initial address setting on output module 6FX1 122-8B**

Initial address (hex.)	Input byte (dec.)	Socket X1 (DIP FIX)	Jumpers
			F H S P O O O O O O O O E G R U
- - - 0	0 - 3		O O O O O O O O
- - - 4	4 - 7		O O O O O O O O
- - - 8	8 - 11		O O O O O O O O
- - - C	12 - 15		O O O O O O O O
- - 1 0	16 - 19		O O O O O O O O
- - 1 4	20 - 23		O O O O O O O O
- - 1 8	24 - 27		O O O O O O O O
- - 1 C	28 - 31		O O O O O O O O
- - F 0	240 - 243		O O O O O O O O
- - F 4	244 - 247		O O O O O O O O
- - F 8	248 - 251		O O O O O O O O
- - F C	252 - 255		O O O O O O O O

**Note**

Jumpers E-F, G-H, R-S and U-P are used for the laboratory test. These jumpers are ignored when the output module is used.

**Location of jumper sockets and jumpers on output module 6FX1 122-8B**

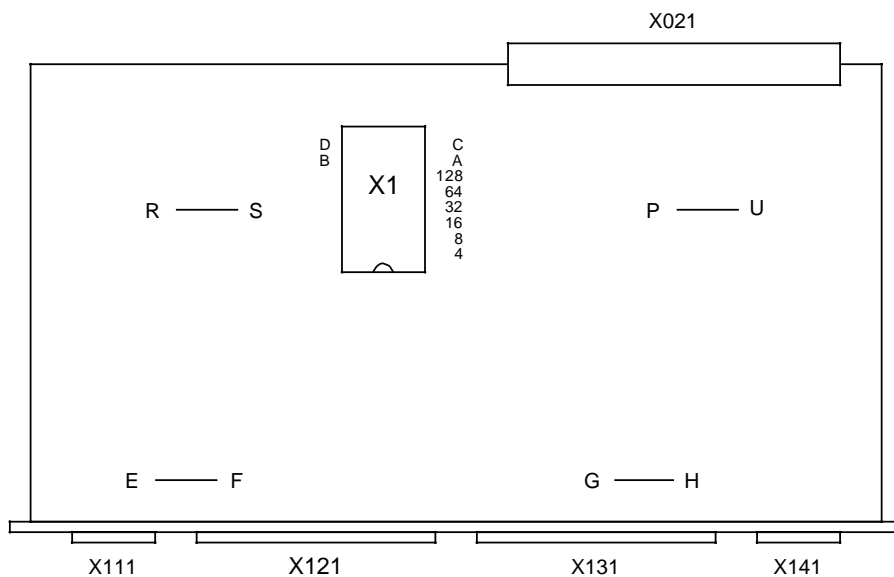

X1 - Initial address setting  
 Jumpers  
 E-F, G-H, R-S, U-P - Open

**4.14 6FX1 126-5AA.. interface submodule for electronic handwheels**

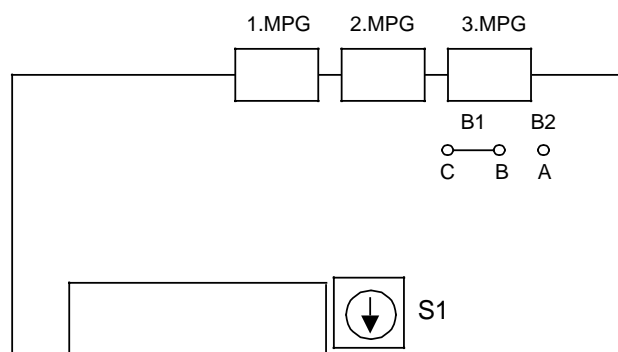

State of jumpers:

B1 (B-C) closed  
 B2 (A-B) open

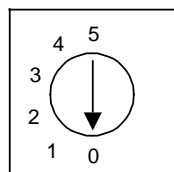

**S1** S1 always in 0 position!

### 4.15 Machine control panel

The following machine control panels:

6FX1124-2BA00 T version

6FX1123-6BA00 M version

are used in the SINUMERIK 880 system and contain all the control elements required for setup mode and controlling program processing and EMERGENCY STOP.

The above machine control panels can be expanded with any on of four different expansion modules. These modules have axis rotary switches and the necessary rapid traverse override switches.

The expansion modules can be economically linked to the central control logic via the I/O module.

The machine control panel also contains the module 6FX1 123-7BA which has a RS 232 C interface.

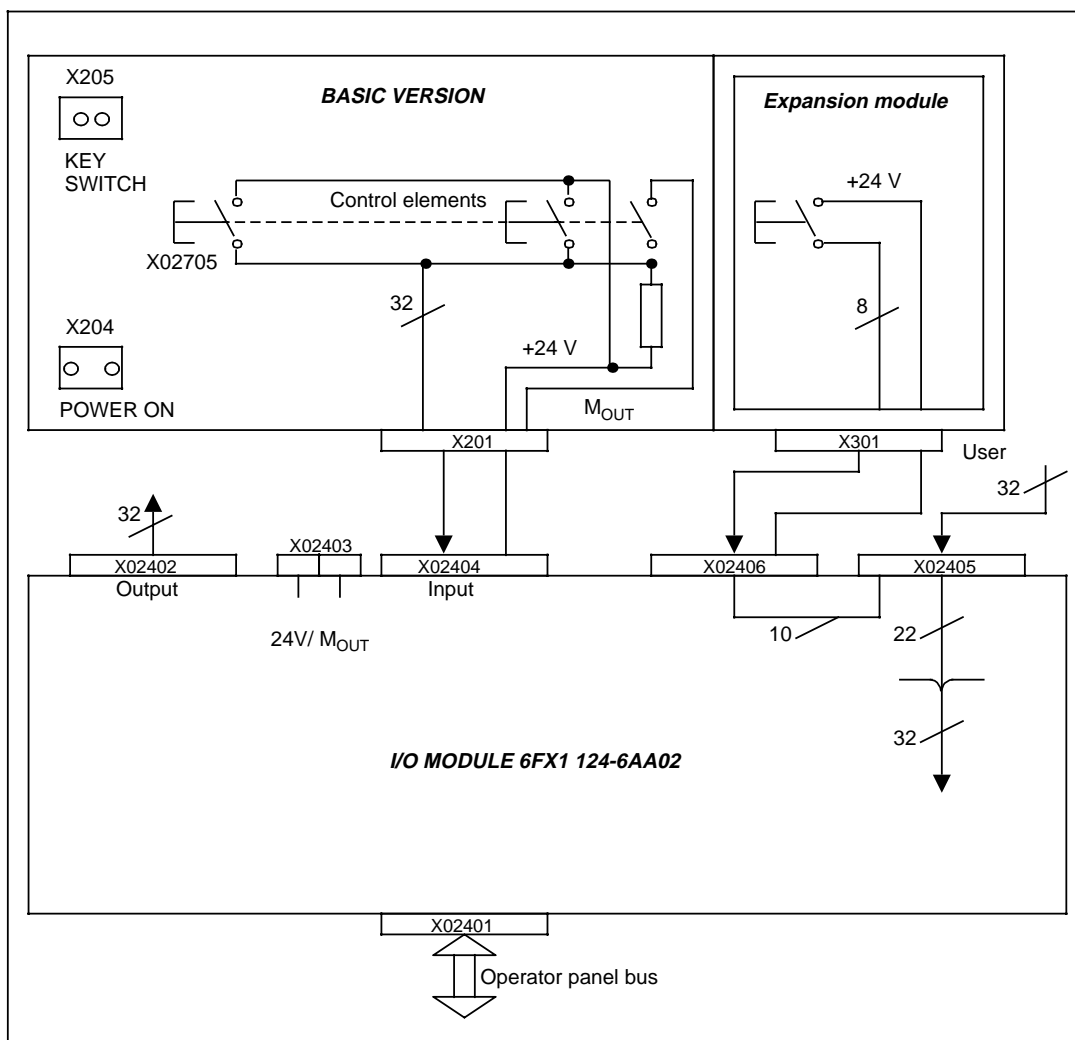

Machine control panel I/O module block diagram

## 4.16 32-bit servo CPU

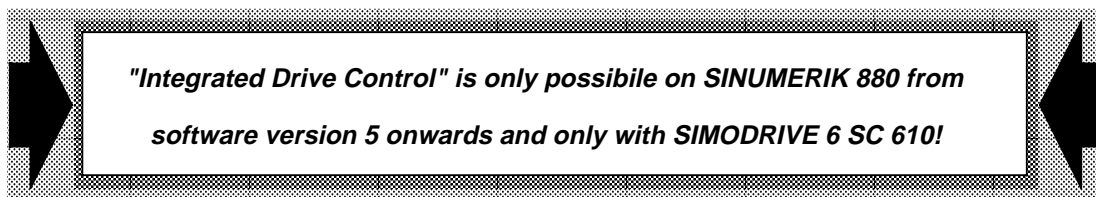

The 32-bit servo CPU is supplied with the two processors 80386 and 80387 (coprocessor). The 32-bit servo CPU plus the memory submodule described in Section 3.1.2 has the following order number:

Order number:	
6 FC3 986-1RQ (D 14)	1. 32-bit servo CPU
6 FC3 986-1RR (D 15)	2. 32-bit servo CPU
6 FC3 986-1RS (D 16)	3. 32-bit servo CPU

## 4.17 Memory submodule for 32-bit servo CPU

The servo software is arranged separately on a memory card (0.5 Mbyte).

The memory card is inserted from the front on the servo CPU.

Order number:	
6 FX1 124-1CB00	Memory submodule for 32-bit servo CPU

Function	Designation:	PROM location:
SERVO 386	570.865.0012.50	D02
	570.865.0013.50	D03
	570.865.0016.50	D06
	570.865.0017.50	D07

#### 4.18 HMS measuring circuit module (High-resolution Measuring system)

This module offers 3 measuring circuit inputs for the position or speed data. The basic module of the measuring circuit has no setpoint output. The measuring circuit card is available in several variants. The following measuring circuit cards can be used on the SINUMERIK 880 with integrated drive control:

Order number:	
6 FC3 986-3JL (K70)	HMS single width (20 mm)
6 FC3 986-3JR (K75)	HMS double width (40 mm)

The double-width measuring circuit card is required for the SIPOS absolute encoder function. In addition, the measuring circuit card contains the absolute submodule.

#### 4.19 I/V hybrid (I/V: Current/voltage conversion)

As standard, the HMS measuring circuit module can only be used for SIPOS encoders with unconditioned voltage signals. As an option, it is also possible to connect linear scales with unconditioned current signals when plugging an I/V hybrid on the respective jumpering socket (X111, X121, X131) in place of the short-circuiting plug. This direct connection is only possible for lines up to 18 m long for reasons of interference immunity. When using longer lines, a converter box must be provided which converts the current signals into voltage signals. For correct connection of the I/V hybrid, Please refer to the relevant mounting instructions.

Order number:	
I/V hybrid:	6FC3 988-7CN

Amplifier for unconditioned current signals (l > 18 m)	
Order number:	6FC9 320-4HM12

### Mounting on the HMS board 6FC3 986 - 3JR (L)

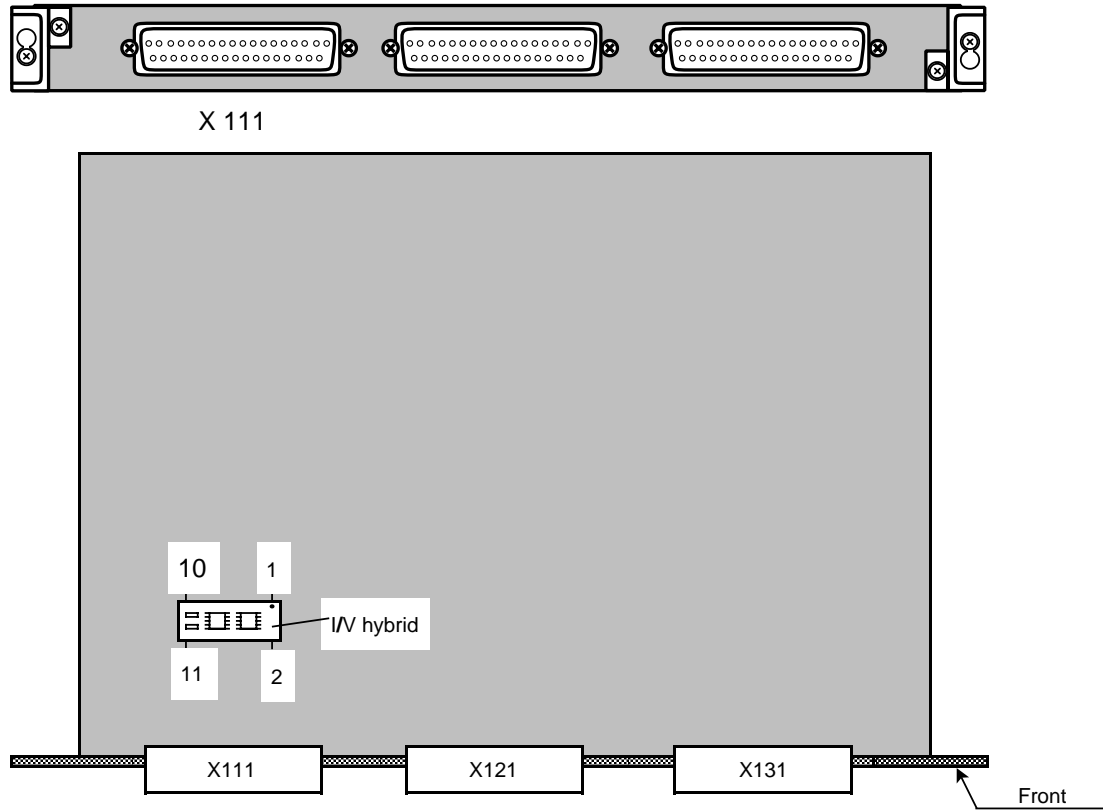

As shown in this sketch, the I/V hybrid is inserted with pins 2 and 11 pointing towards the front. The coloured point on the hybrid marks pin 1. All three inputs X111 to X131 can be retrofitted with a I/V hybrid.

## 4.20 ACC (Analog Current Control) printed circuit board

The analog current control is on a single-width module, passive on the local bus like the measuring circuit modules.

Order number:	
6FC3 986-3JJ (K68)	ACC printed circuit board

### 4.21 SIPOS incremental encoder

In the integrated drive control, the SIPOS incremental encoder is used as a high-resolution speed measurement system, i.e. it performs the function of a tachometer. The encoder must therefore be attached directly to the motor.

The encoder can also be used as an indirect measuring position measuring system at the motor or directly at the ball screw.

Order number:	
6FC9 320-3CS (WKF Fürth)	SIPOS incremental encoder (connector mounted axially)
6FC9 320-3CW (WKF Fürth)	SIPOS incremental encoder (connector mounted radially)

### 4.22 SIPOS absolute encoder

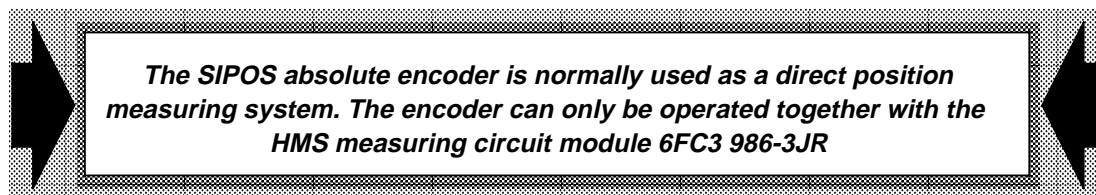

Order number:	
6FC9 320-3CT (WKF Fürth)	SIPOS absolute encoder (connector mounted axially)
6FC9 320-3CV (WKF Fürth)	SIPOS absolute encoder (connector mounted radially)



## 4.23 Jumpering module

When using integrated drive control, the complete axis control and the R-S-T processor are incorporated in the control and the closed-loop control card in the driving unit can be omitted.

In this case, the control card must be replaced by the jumpering module which performs the following functions:

- Reception and distribution of the transistor triggering signals
- Transmission of actuator error messages to the control
- Evaluation of the "Terminal 65" function
- Separate evaluation of motor overtemperature in addition to standard evaluation

## 4.24 Enables and evaluations on the jumpering module

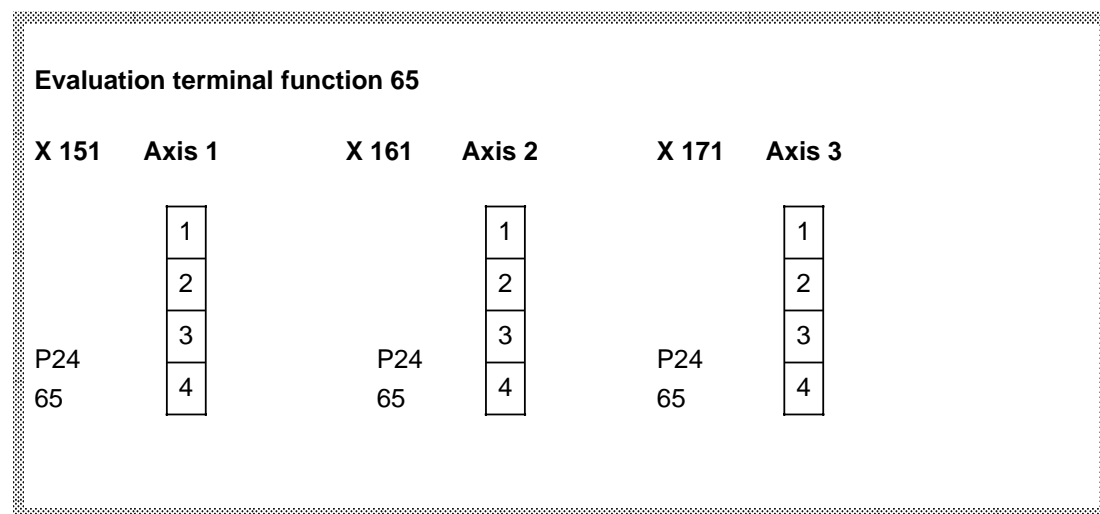

Bridges between terminals 3 and 4 of the 4-way Weidmüller connector set must be provided as standard. As a result, the terminal 65 function is triggered by the control only by software.

This function is initiated as in standard systems, e.g. by cancelling the controller enable. In addition, the function can also be initiated by the customer by interconnecting terminals 3 and 4.

## 5 Voltage and Functional Tests

### 5.1 Voltage test

#### 5.1.1 Voltage supply

The SINUMERIK 880 is fitted with two power supply units.

- Operator panel power supply unit 6EW1 861-3AA (5 V/15 A)  
Voltage: 230 V + 6%, - 10%
- NC power supply unit 6EW1 861-2.. (5 V/40 A)  
Voltage: 230 V + 6%, -10%

#### **Caution!**

NC-ON for the operator power supply unit must **not** be connected in parallel with NC-ON for the central controller power supply unit. Use control switch with 2 contacts.

The connection conditions and voltage supply limit data should be checked **prior** to powering up (see Interface Description Part 2).

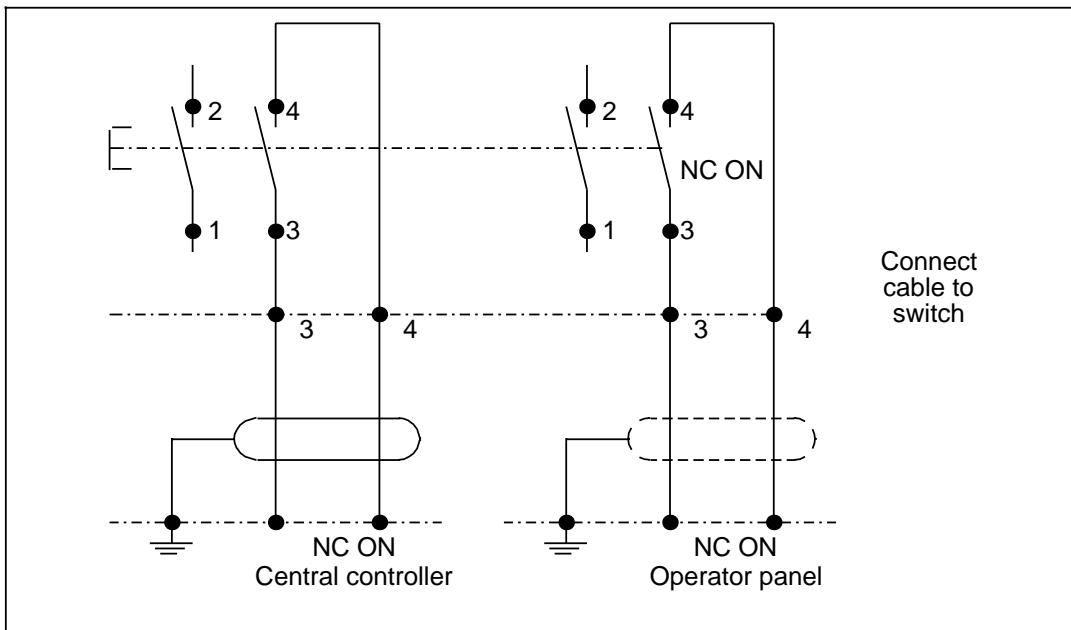

Two-contact switch - circuit diagram for NC ON

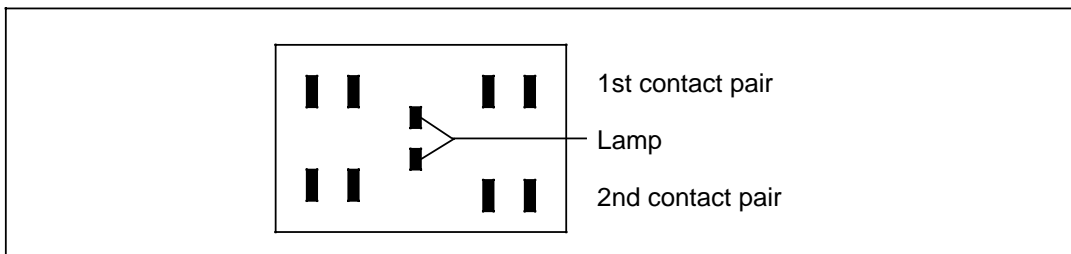

Switch circuit diagram for NC ON on SIEMENS machine control panel

### 5.1.2 Limit temperature

Ambient temperature 0 ... 55°C

The NC ambient temperature is measured using a temperature sensor on the multiport/dualport and monitored for the upper limit. If the temperature sensor detects an excessive temperature, the control outputs Alarm 2 (overtemperature) on the NC screen.

### 5.1.3 Fan monitoring

In addition, each of the two fans in the NC power supply unit is monitored by means of one NTC thermistor. Thermistor response need not necessarily result directly in the NC being shut down since any such response only activates relay K648, which the user can then evaluate for himself.

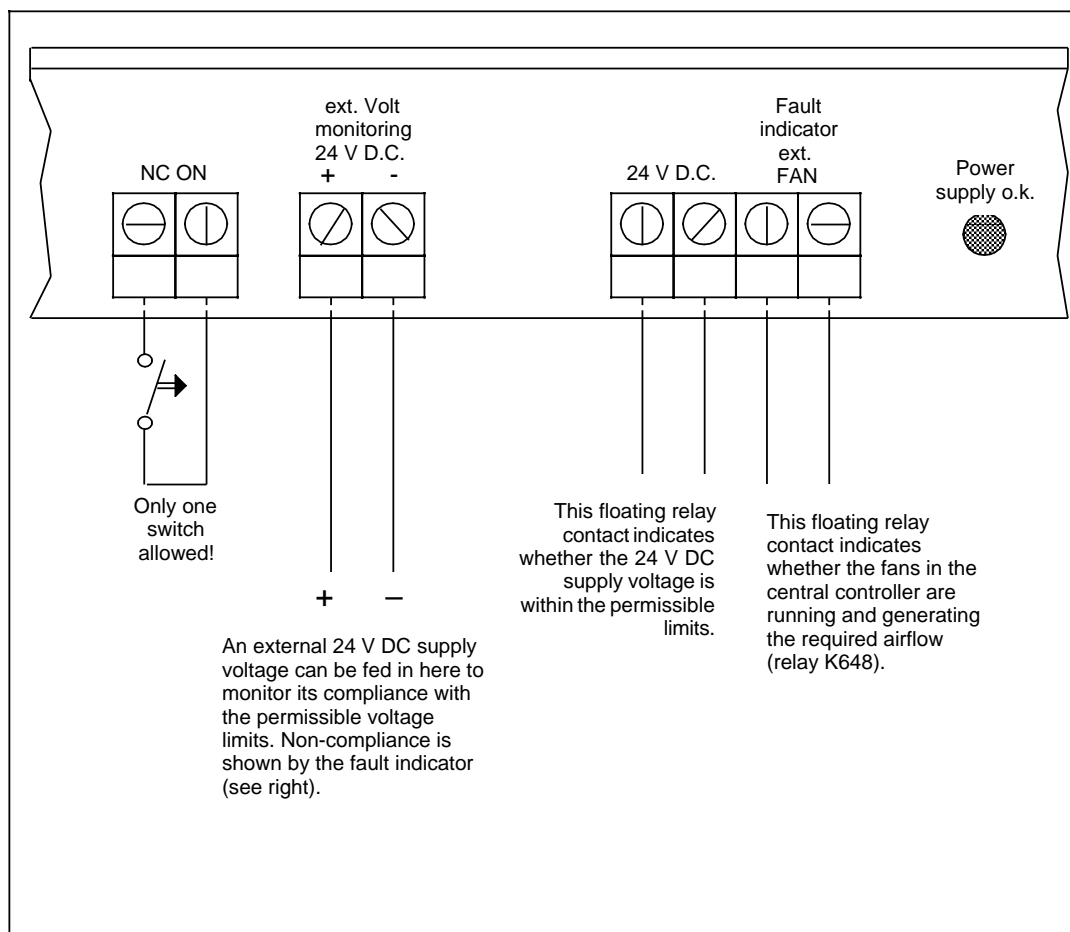

Central controller power supply unit

### 5.1.4 Direct voltage+ 5V

The 5 V voltage may be measured at all power supply units across the sockets provided and may be adjusted using a potentiometer. The voltage is already set at the factory to approx. + 5.15 V (on account of the line voltage drops), so this voltage is not normally adjusted.

The fault-free operating status is indicated on the NC power supply unit by means of a green LED on the front PCB.

### 5.1.5 Direct voltage + 5V external

With the 6EW1 861-2B power supply unit (power supply in the 40A central controller) and additional controllable voltage of 5V to 6.5V is available with which encoder distances of more than 35 m are possible. This power supply unit is an option (option P24) and can only function with the 6FX1 121-4B measuring circuit modules and the new HMS measuring circuit modules.

For this controllable voltage to be fed from the power supply unit via the measuring circuit modules to the appropriate encoders it is necessary to set jumpers on the measuring circuit modules (see module 6FX1 121-4B. in section 4).

On the power supply the adjustable voltage is set as follows:

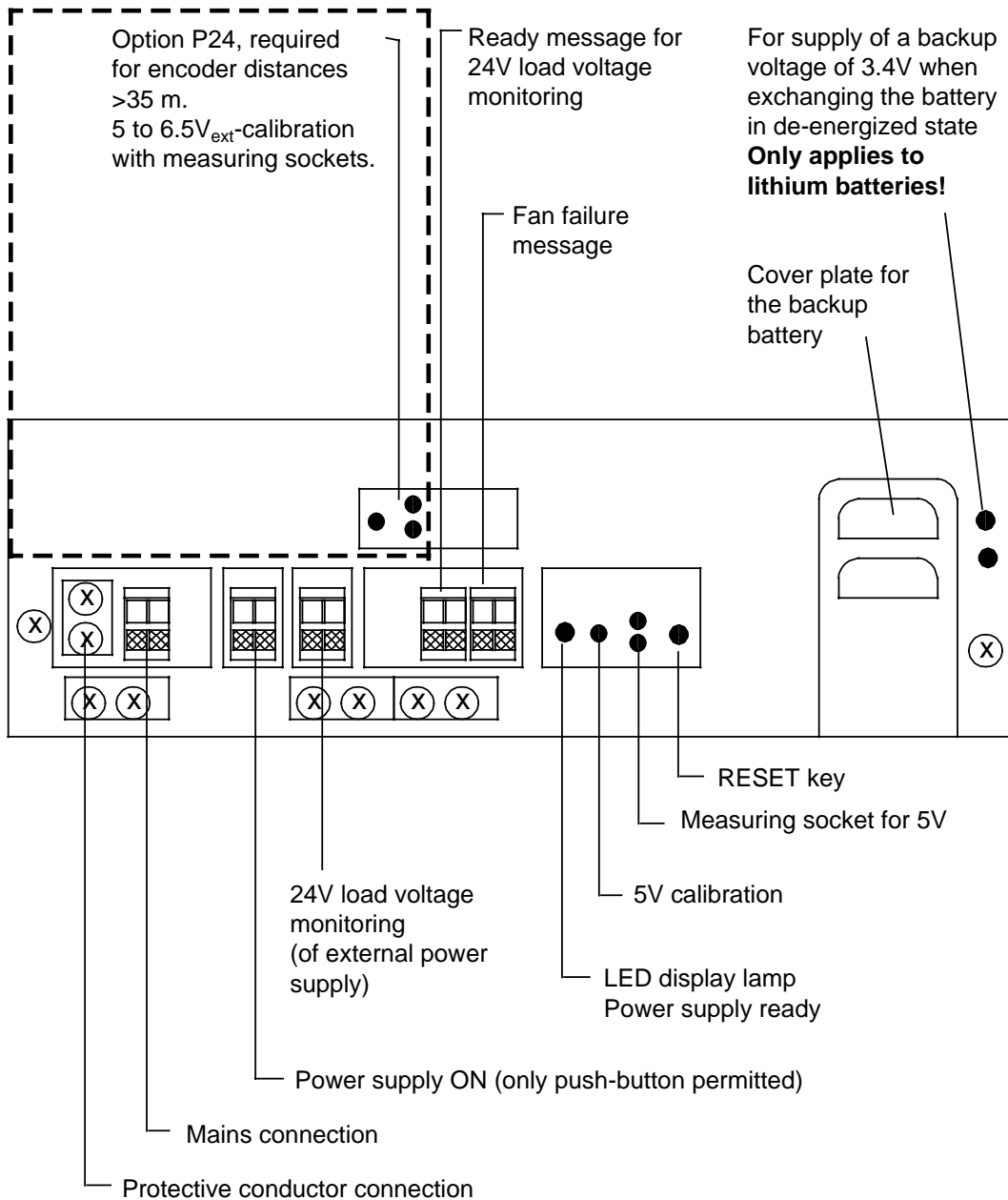

***From 1991 onwards all controls will be supplied with alkali batteries.***

***These controls have a new kind of battery compartment. It is not possible to convert from lithium battery to alkali battery use.***

## 5.2 Functional test

### 5.2.1 CPU monitor

The LEDs on the 6FX1 120-4BB in the operator panel (OP CPU) and NC (COM CPU) provide information as to the status of the control.

When the monitor responds (LEDs light up), the axes are shut down and the PLC outputs are disconnected by the control.

During run-up of the control (POWER ON routines), both LEDs light up. In these routines it is determined which modules are in the rack and whether an operator panel is connected.

The OP CPU (operator panel CPU) and COM CPU monitor each other. If either fails to signal during the power on routines, the other remains in the STOP condition. Any interruption in the connection between the operator panel and the NC is also indicated (e.g. defective cable, OP CPU, COM CPU) by the four LEDs flashing simultaneously on the operator panel (alarm indication, motion, feed hold, program active).

#### ***LEDs remain on after powering up or come on during operation if:***

- the connection between the operator panel and NC is interrupted (faulty cable etc.)
- the module jumperings are incorrect
- a module in the COM or operator panel area is defective
- the CPU is looping or was in a loop for a lengthy period, causing the monitor to trigger
- see Section 13 for additional meanings.

### 5.2.2 EPROM check

A cross-check sum test of the system program memory is performed with each switching on operation (in the POWER ON routines) and during operation on a cyclic basis. Any discrepancy between the specified and actual sums is indicated by the control in different ways.

The following error messages are possible:

- Operator panel EPROM error  
 Memory ERROR always appears in the first line on the screen after the EPROM CHECK has responded.
- Check sum error  
 EPROM MODULE NUMBER is displayed on the screen if one or more EPROMs exhibit an incorrect check sum in an EPROM submodule.
- COM-CPU EPROM error  
 The LED on the COM CPU flashes continuously; there is no display on the screen.
- NC-CPU EPROM error  
 Alarm message "NC CPU failed" and/or Alarms 64-66, 70-80 are displayed on the screen.

**EPROM number breakdown**

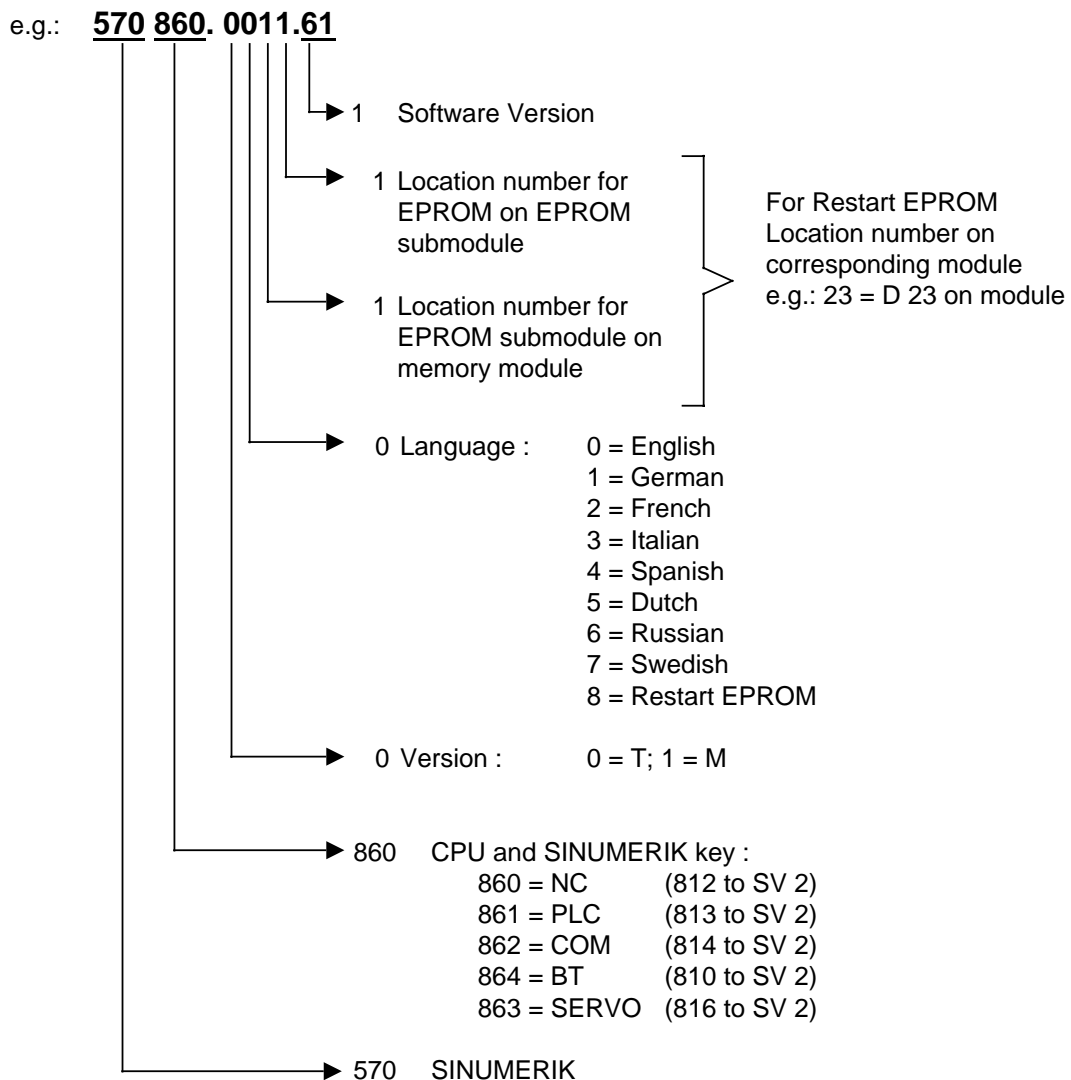

### 5.2.3 Brightness adjustment

The SINUMERIK 880 is available with two types of screen:

- a) 12" Monochrome monitor
- b) 12" Colour monitor (option)

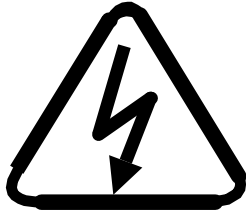

**Caution!**

High voltage approx. 16 kV in visual display unit and at high-voltage transformer, anode lead and anode terminal at CRT.

The brightness of the monochrome monitor may be adjusted using a potentiometer located in front of the CRT unit and accessible from the outside. The contrast may also be adjusted using a 10-turn potentiometer at the monitor adapter. However, this potentiometer is **not** accessible from the outside.

The brightness of the colour monitor may be adjusted by means of a potentiometer, which is only accessible with very great difficulty from the outside.

The contrast and focus may also be adjusted using a potentiometer in each case. These potentiometers are only accessible after removing the lower section of the monitor casing.

Correct adjustment of the picture hold, height, width, contrast etc. is usually performed at the factory. Alterations to the potentiometer settings on the monitor PCB should only be performed by trained personnel using special tools (epoxy resin screw drivers).

The guidelines issued by the Federal German Employers' Liability Insurance Association for Precision Mechanics and Electrical Engineering (Berufsgenossenschaft der Feinmechanik und Elektrotechnik) should be observed.







### 5.3 Drift compensation (from Software Version 03)

On SINUMERIK 880 drift compensation is semi-automatic, because the operator must activate it. If the axes (of the CNC) and drives are in closed-loop control, drift compensation may be performed.

The drift has exceeded the permissible value specified in machine data 204\* and 208\* if the LED fails to go out after travel (axis stopped). Drift compensation must be performed.

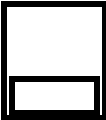
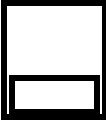
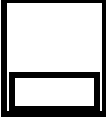
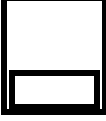

**Operation:**

	DIAG-NOSIS		Press softkey 'DIAGNOSIS'
	MACH. DATA		Press softkey 'MACH. DATA'
	NC MD		Press softkey 'NC MD'
	AXIAL DATA 1		Press softkey 'AXIAL DATA 1'
	2720		Enter numerical value 2720 (1st axis) and actuate SEARCH key
or	2721		With the EDIT key the following error is calculated separately for each axis
	⋮		
	⋮		
or	2731		The EDIT key must be pressed for every axis
			Actuate RECALL key (return) three times

Drift compensation must be performed individually for all axes.

Drift compensation may also be performed manually by changing the value in MD 272\* until the following error at rest is zero (check the service data for the axes).

**Caution!**

With very precise machines, drift compensation should be performed several times daily on account of the temperature differences during operation since drift directly affects the following error.

From Software Version 03 an "automatic drift compensation" can be programmed on SINUMERIK 880.

With both @361 (axis actual value machine related) and @362 (axis actual value machine related incl. following error) the drift can be calculated as follows from the following error and entered in NC MD 272\* in a subroutine:

R1 = axis number  
R0 = following error/drift

**Example:**

@361	R0	R1	Axis actual value machine related
@362	R2	R1	Axis actual value machine related incl. following error
R0	=	R0 - R2	The following error is in R0
Conversion of the following error including the servo gain factor (NC MD 252*) and the multgain (NC MD 260*) in VELO.			
Enter the result additively in NC MD 272* (drift).			
:			
:			
:			
R4	=	R1 + 2720	
@400	R4	R0	Check whether following error is ZERO.

**Restrictions:**

- SINUMERIK 880 with Software Version 3
- For linear axes (more complicated for rotary axis)
- When the subroutine is called (@361+@362 to NC MD 272\*) the axis in question must be stopped.

## 6 Standard Installation Sequence

Comply with the following sequence for standard installation of the SINUMERIK 880:

1. Connect the control and external components in accordance with the 880 operating instructions (Instruction Manual), the Interface Description Part 2 and the universal interface description.
2. Check the cables and connections with reference to the Interface Description, Part 2.
3. Note Section 1 of the Installation Guide.
4. Axes and spindles, also speed controller, already installed.
5. Hardware for controller-disable connected for all axes and spindles.
6. All PLC input/output modules and handwheels connected.
7. Perform installation routines in Section 9.2.1.
8. Note Section 6.1.
9. Check all data, especially NC MD, PLC MD and setting data, for permissible values (see Section 9).
10. Note Section 2 of the Installation Guide and append the Checklist to the completed log book.

## 6.1 Standard installation shown as a flowchart

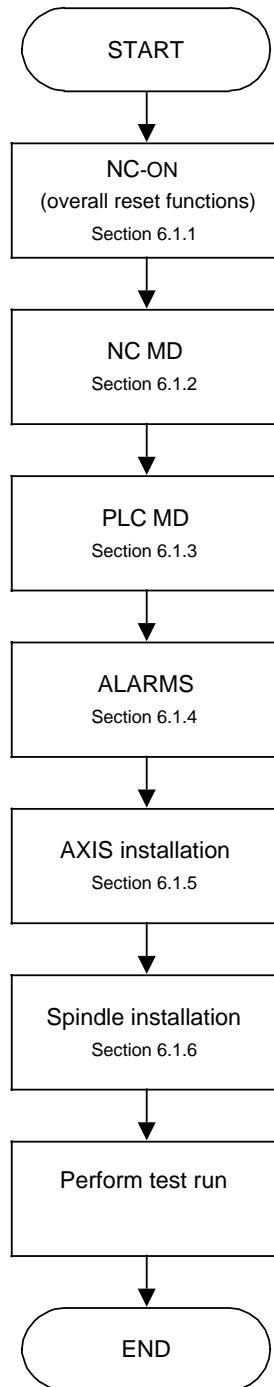

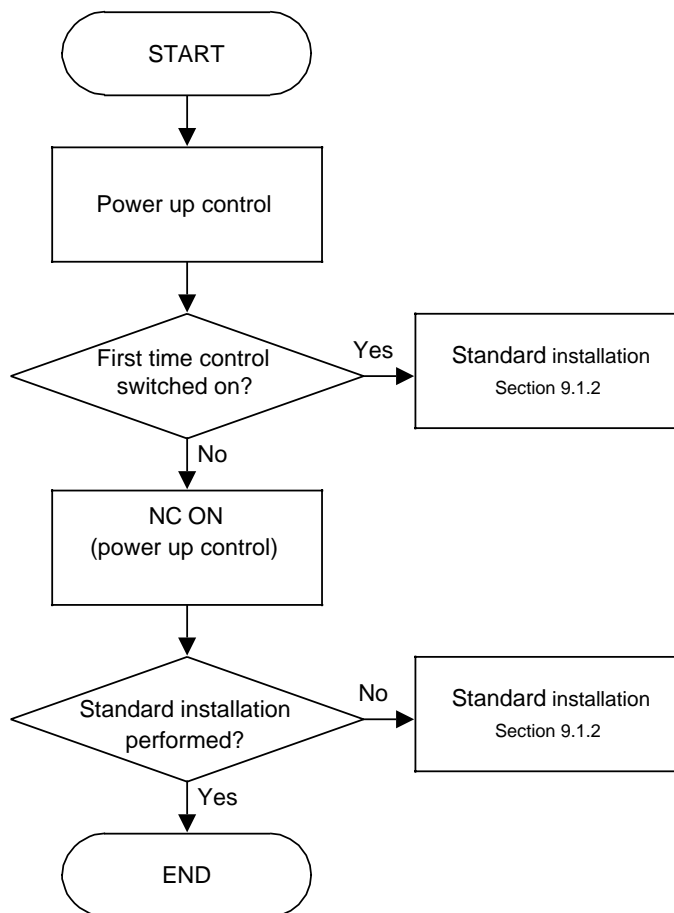
**6.1.1 NC ON (overall reset chart and setting standard NC MD)**

### 6.1.2 NC machine data

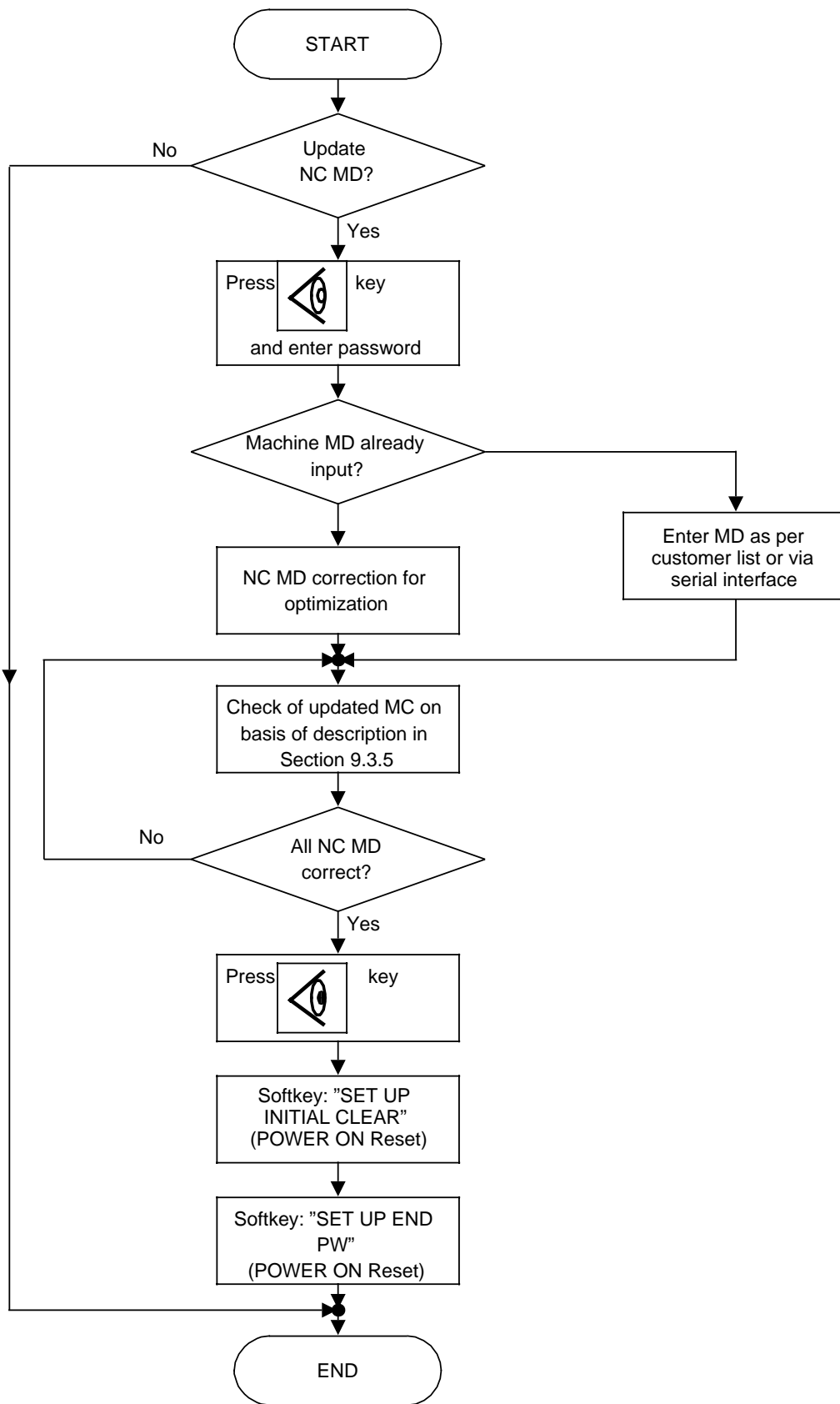

### 6.1.3 PLC machine data

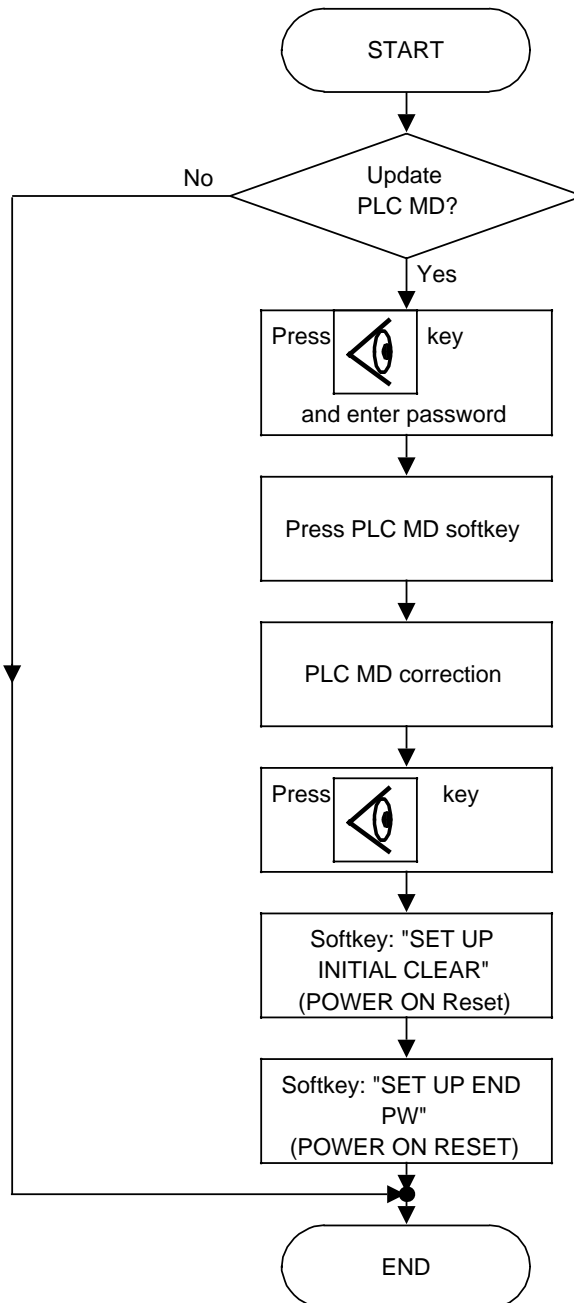

### 6.1.4 Alarm processing

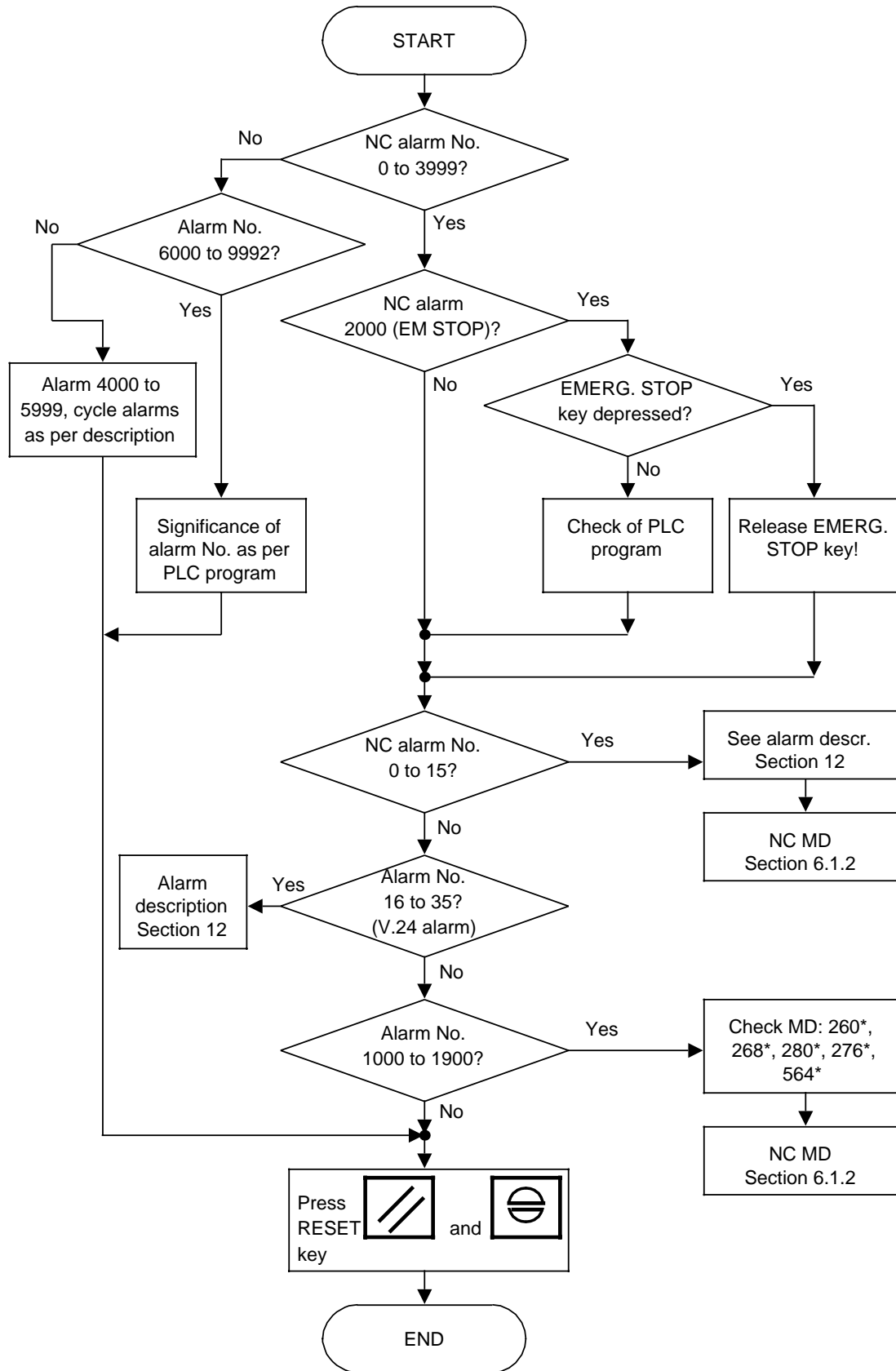



## 6.1.5 Axis installation (simplified flowchart)

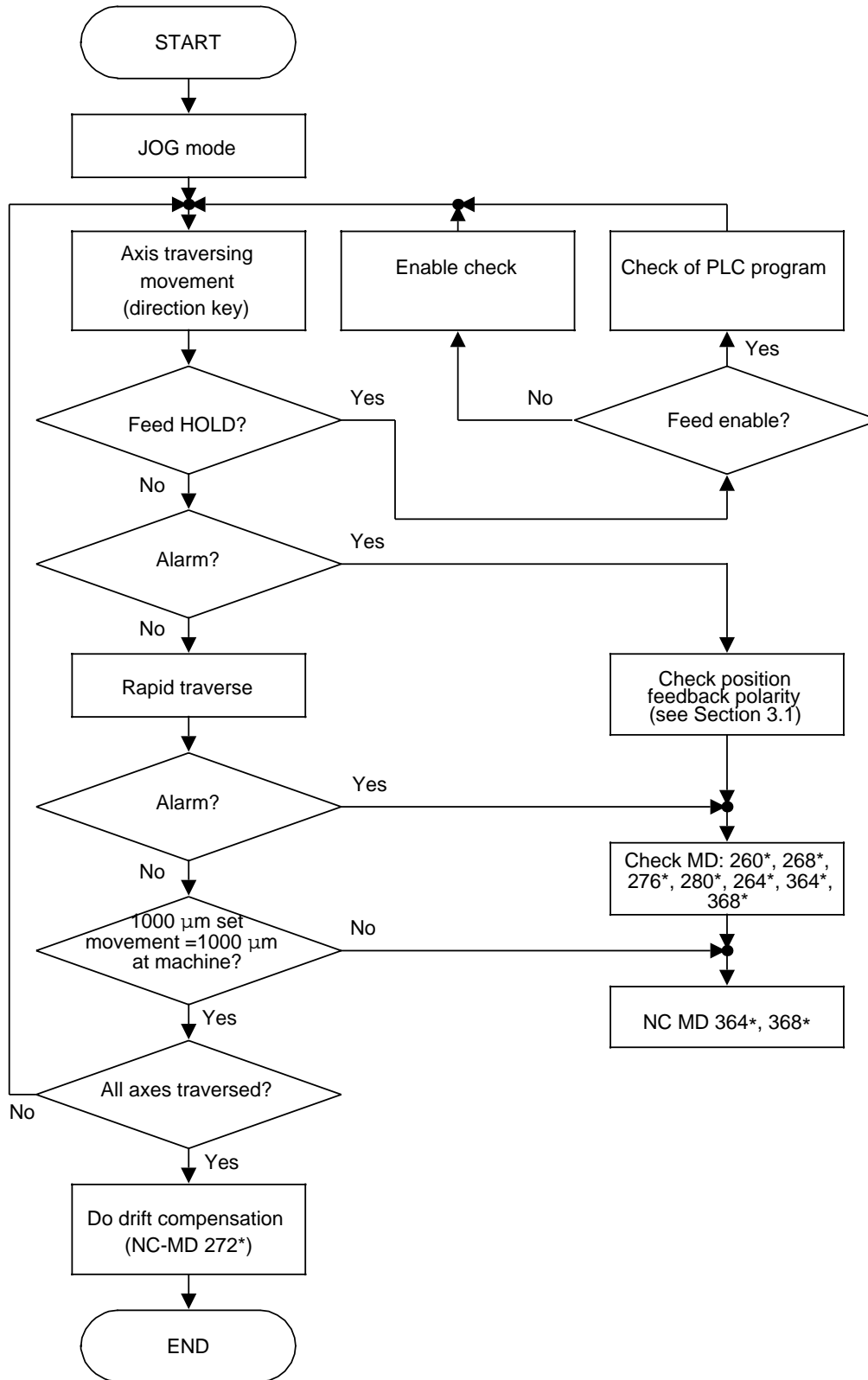

### 6.1.6 Spindle installation

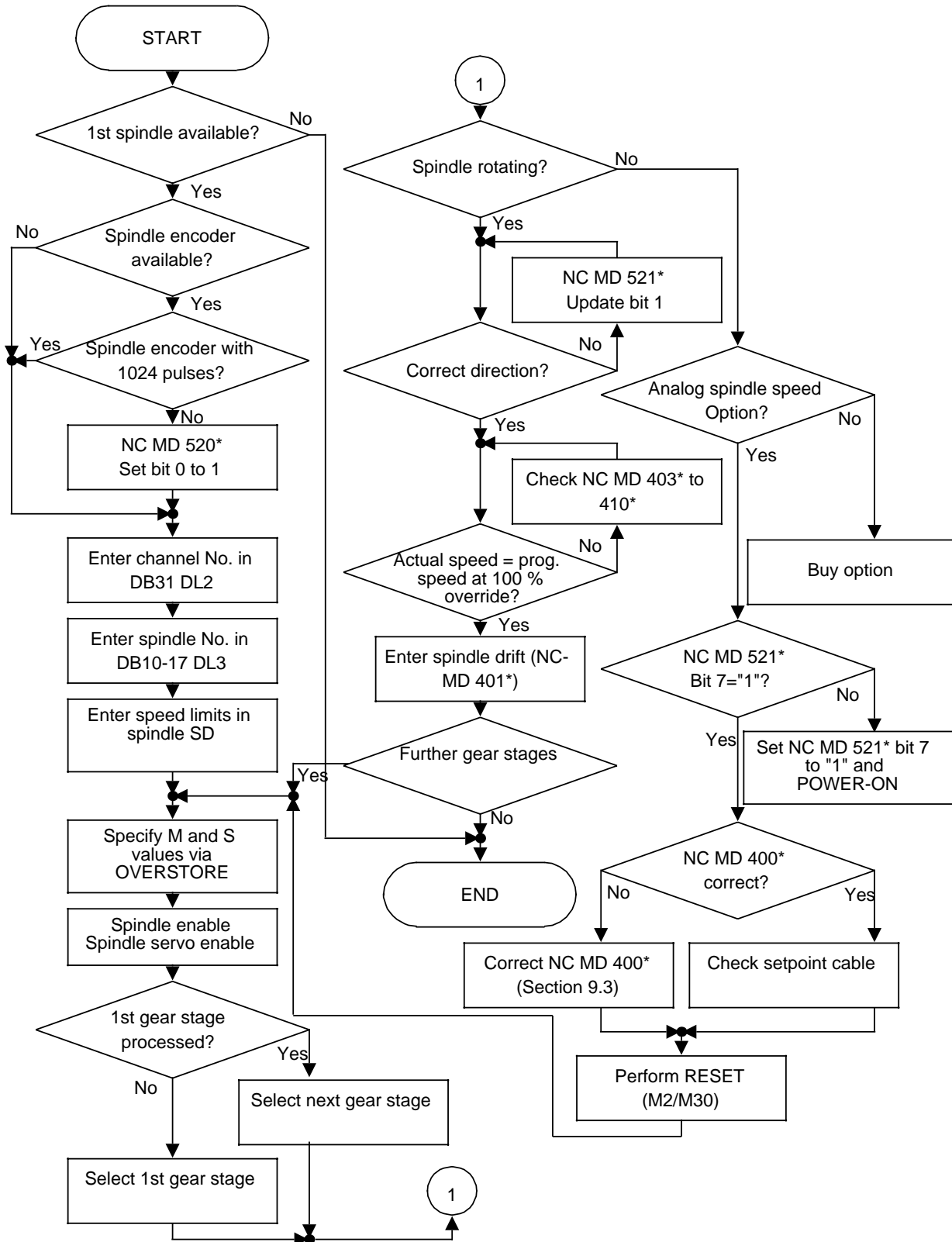

## 7 135 WB PLC Description

### 7.1 General

On SINUMERIK 880 (from Software Version 4) the PLC CPU 135 WB (basic version) is used. This PLC runs as a "RAM machine", i.e. the operating system and the user program are loaded from the EPROM into internal RAM on a general reset. This makes processing considerable faster.

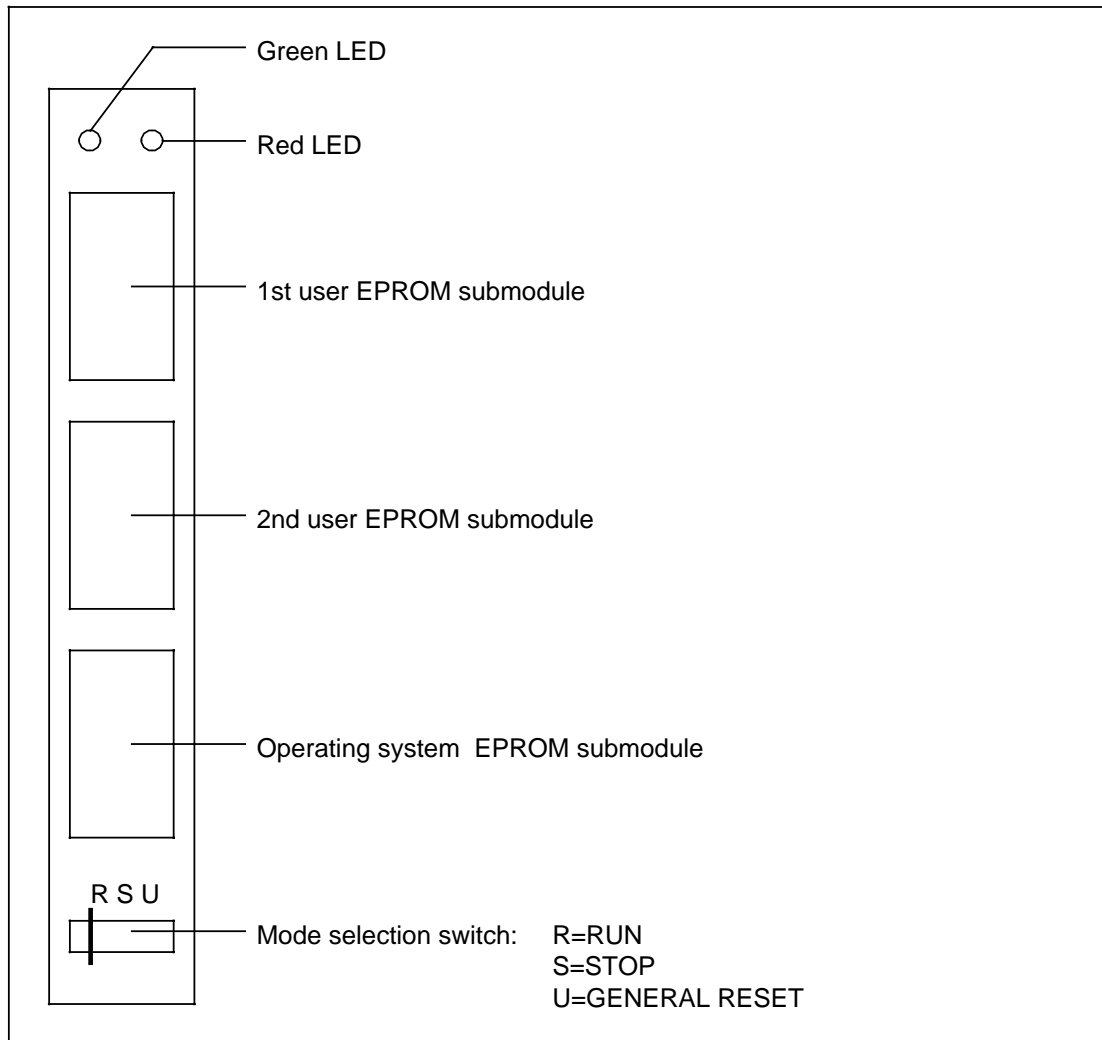

Front view of 135 WB

Its performance can be expanded, depending on the control frame configuration, by connecting up to a total of 2 PLC CPUs. The technical data and notes on programming are contained in the Planning Guide (Configuring Instructions) entitled "Configuring the 135 WB PLC".

## 7.2 Installation

Installation of the PLC 135WB is subordinate to the installation of the numerical machine tool control (NC). The CPU of the PLC has subordinate functions in this case.

When the NC branches into the "Setting up mode initial clear" mode a setting up bit is set. In the NC, deletion and loading of NC and PLC machine data or parameter assignment for the system program can be executed, with the aid of which setting up of PLC 135 WB is controlled.

### 7.2.1 Self-diagnostics program

After switching on the mains voltage, the interface control runs a self-diagnostics program. This program tests the most important hardware components and initializes the software required for system start up.

If errors in the system are recognized, the LED on the front plate displays the error (Table 6.1).

LED	Significance
Continuous (green only)	Cyclic operation
Continuous (red only)	Stop state
Continuous ( red and green)	INITIAL CLEAR required (initial power on or data loss)
Flashing	<ul style="list-style-type: none"> <li>once Error with cross-check sum via the system program</li> <li>twice Error in the CPU RAM test</li> <li>3 times Error Timer 0 (process-internal timer) or Watchdog error</li> <li>4 times Error in monitoring test for timeout</li> <li>5 times Acces to link RAM not possible. This can also happen, for example, if a power failure takes place while a large file is being copied etc.</li> <li>6 times Error with test access to link RAM</li> <li>7 times Error in system initialization program</li> <li>9 times <i>SINUMERIK 840</i>: synchronisation error in PG link</li> <li>10 times Error of the internal coprocessor (COP) register or in the step address counter (SAZ) creation</li> <li>11 times Command delegation to word processor (WOP)</li> <li>12 times Processing of binary commands</li> <li>13 times Processing of OR, bracket expressions, NOP-or BLD-commands</li> <li>14 times Processing of block calls and jump commands</li> <li>15 times Processing of timer and counter operations</li> <li>16 times Addressing in data memory</li> <li>17 times Command execution mode</li> <li>18 times Test address comparator machine code (MC5) and interrupt processing via coprocessor</li> <li>19 times Monitoring test for timeout with access of the coprocessor to the user memory</li> <li>20 times ACOP redesign not plugged in</li> </ul>

## 7.2.2 System initialization program

After the self-diagnostics program has been run through, the system initialization program is requested.

In its first section, the data required for running the organization program are set up. This setting up includes:

- Stack organization,
- Segmentation for word processor and coprocessor,
- Entries in the location-dependent CPU interrupt table,
- Task priority lists,
- Setting up task data,
- Initialization of counts and periodic values.

In the second section the system initialization program defines the type of start up after switching on the mains voltage. The following points are checked:

- Whether the switch-on test pattern is missing (i.e. data lost)
- Whether there is a battery interrupt
- If the setting-up bit is set
- Request from the "automatic warm restart after setting-up initial clear"
- STOZUS operating status bit set (acquisition of interrupt event or continuation of the STOP state, see Section 8)
- Cold restart or warm restart attempt aborted.

If the STOZUS identifier is set, the control remains in the STOP state.

If, in the second section, (testing of run-up after switch on the mains voltage) the STOZUS identifier is not set, but one of the other conditions is fulfilled, an automatic cold restart is executed; a warm restart of the Control only occurs if none of the mentioned conditions are fulfilled.

Initial clear with subsequent bootstrapping of the user memory (URLOE = 1) is always required.

- If first setting up has been carried out,
- Data loss has occurred by removing the PLC CPU or, in the case of power failure, due to simultaneous battery voltage failure.

If the mains voltage fails during active processing checks, the processing checks are aborted by the programmer. The system initialization program causes a cold restart.

### 7.2.3 Timeout analysis

A write access to the communication or local bus is executed by the bus interface. The processor immediately receives an acknowledgement and continues. (Buffered access to communication/local bus). If a timeout occurs during such an access, the current state of the registers of the processor and coprocessor give no information as to the cause of the timeout.

The user can switch off buffered accesses to the communication and local bus (e.g. to test STEP 5 programs during the installation phase) via machine data (PLC operating system MD bits 6049.0). These accesses are then slower because the processor only receives an acknowledgement when the whole bus cycle has finished.

Machine data 6049.0 must be set in order to be able to determine the exact cause of a timeout.

### 7.2.4 Error list for PLC 135 WB

The operating system can detect malfunctioning of the central processor, errors in the system program or the effects of erroneous programming on the part of the user.

If, while executing a command, the interpreter encounters another error which will result in a program interrupt, it branches to the STOP loop.

A more exact error analysis can be carried out with the help of the PG 685 or 750 or the detailed error code which is integrated into the control. The interrupt stack at the programmer and/or the NC in the PLC status display in DB 1 in DW 160 to 163 and the detailed error code, which are all described in Section 8 of the Installation List, are available for this purpose.

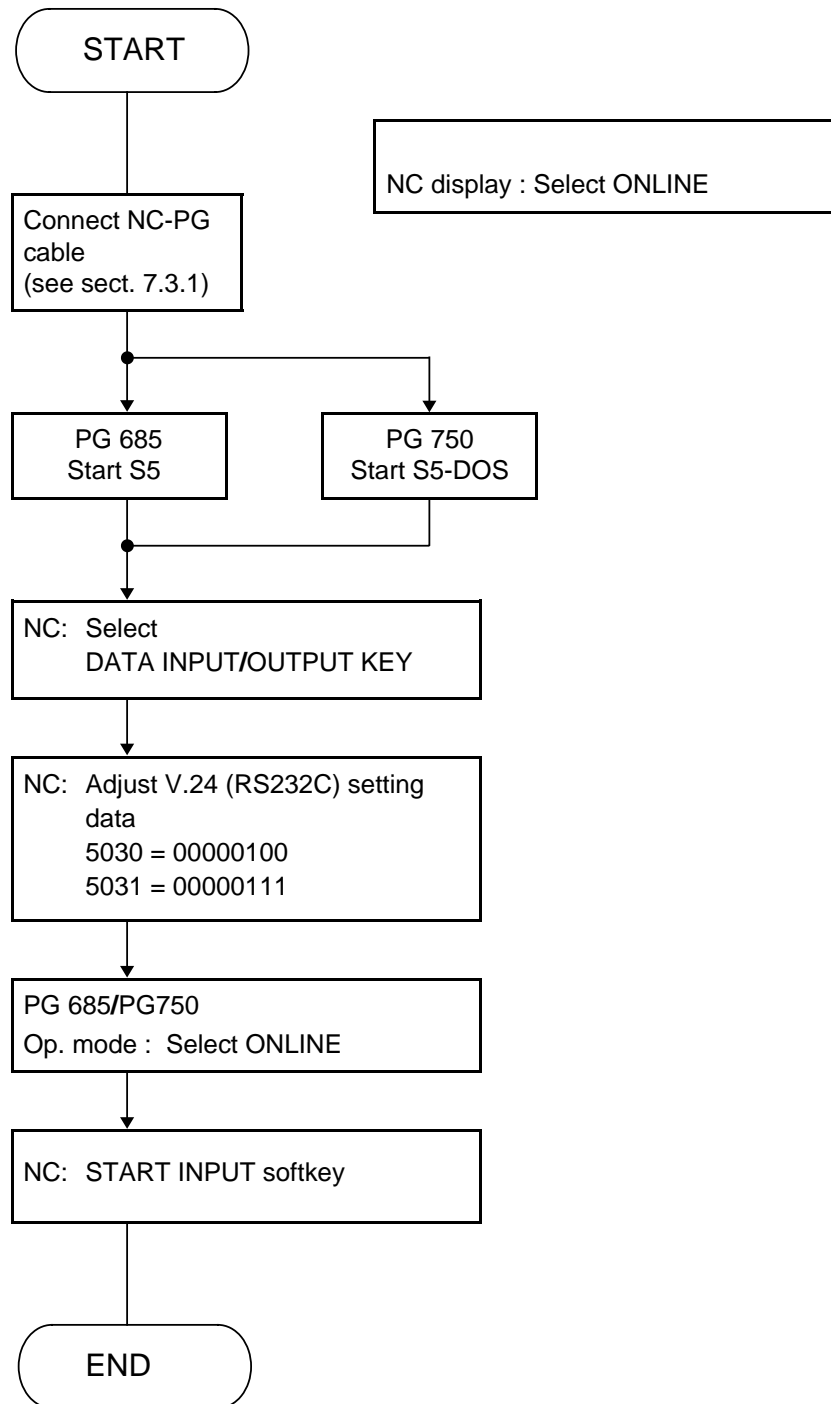
**7.2.5 PLC-PG 685/PG 750 link**

### 7.3 Installation of the 135 WB PLC

During installation the 135WB PLC is in the stop condition (red LED). For installation purposes, the 135 WB PLC is subordinated to the COM CPU; it therefore does not have any operating control elements.

For initial start-up, the standard NC machine data are loaded first and then, depending on the number of PLC CPUs, NC MD 5038 bits 0 and 1 are set.

**Operator input:**

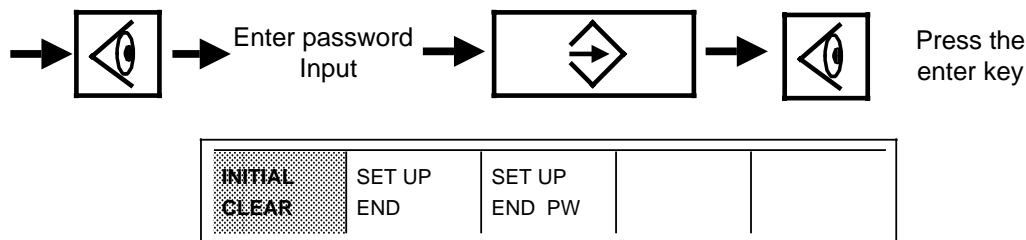

The control is in the "INITIAL CLEAR" mode.  
 The PLC MD then have to be erased and the standard machine data loaded.

**Operator input:**

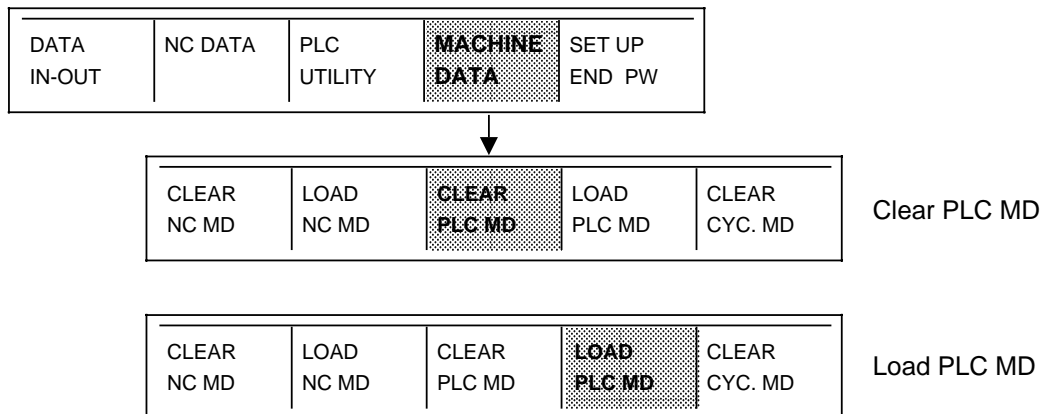

The standard machine data are loaded.



The "INITIAL CLEAR" function is executed next.

**Operator input:**

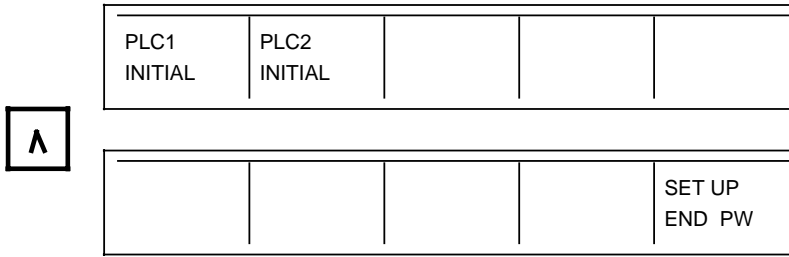

**7.4 PLC DIAGNOSTICS**

In "PLC DIAGNOSTICS" mode, counters, timers, input words, output words, flag words and data words can be read. Inputs, outputs, flag words and data words may be overwritten after entering the password.

In all operating modes the "DIAGNOSTICS" softkey is in the first row (with the exception of "PRESET" mode where the "DIAGNOSTICS" softkey is not displayed at all).

**Operator input:**

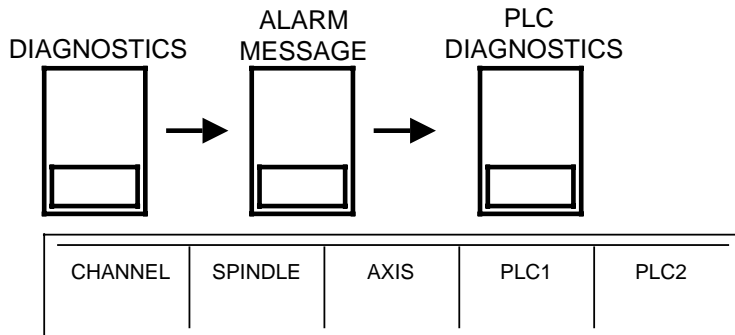







These softkey functions should be selected one after the other

This softkey menu is displayed

## 7.5 PLC STATUS

In "PLC STATUS" mode, counters and timers can be read, and input words, output words, flag words, data words and double data words can be read and written. These words may only be written following an enabling operation as a result of entering the password. An overview of the blocks available in the PLC (DB, SB, PB, FB, OB) may also be selected. The interrupt stack can be called using an additional softkey.

### 7.5.1 Operation of PLC STATUS

Key		PRESELECTION:	Each existing byte number can be preselected
Key		Page FORWARDS:	Byte number incremented by one
Key		Page BACKWARDS:	Byte number decremented by one
Key		INPUT:	Change value in selected word or bit number by re-entering
Key		RECALL:	Return to previous display
Key		EXTEND SOFTKEY MENU:	Extend called display

### 7.5.2 PLC STATUS selection

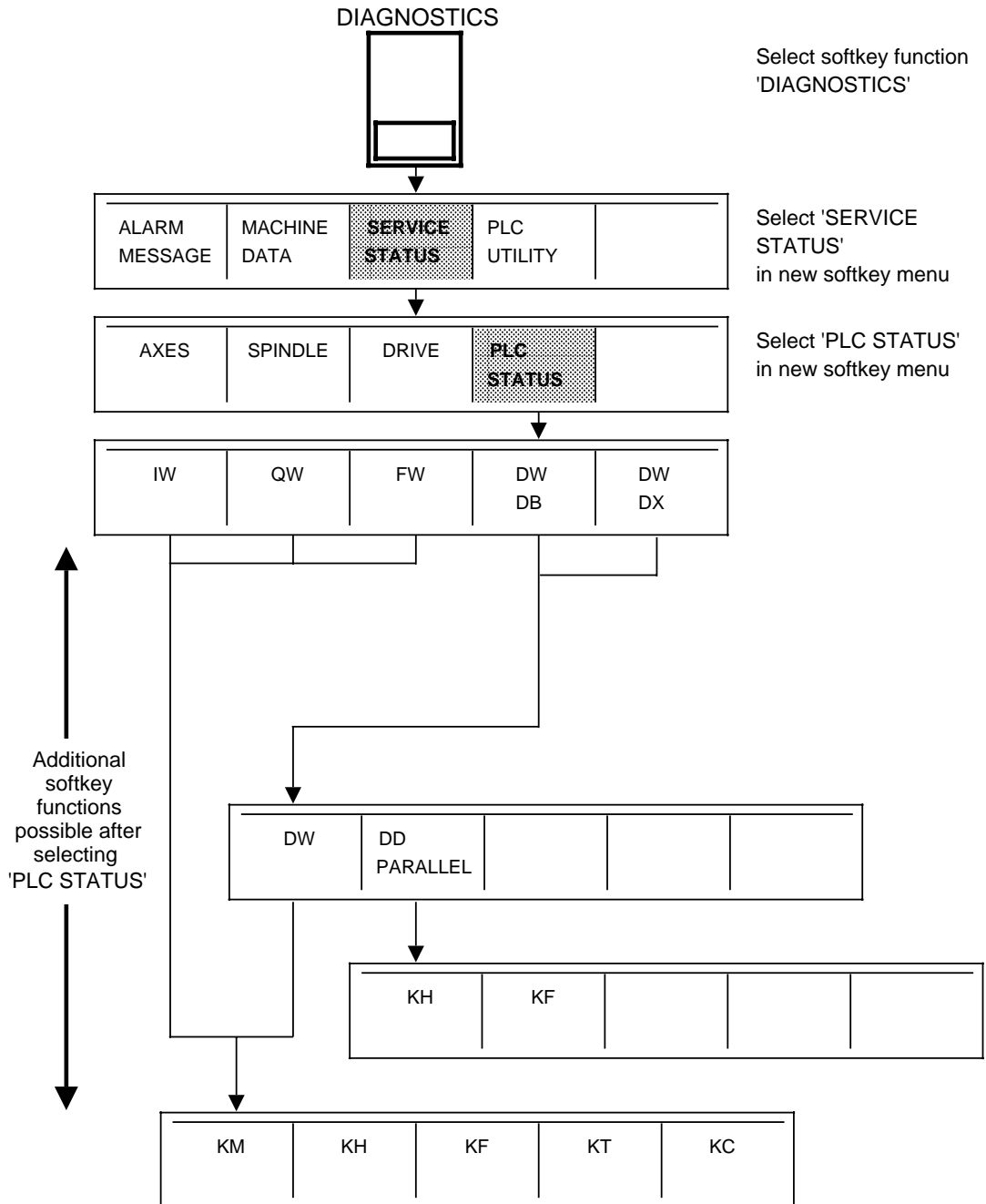

## 7.6 135 W PLC description

### 7.6.1 General

SINUMERIK 880 is supplied with an integrated 135 W PLC (basic version). Depending on the control frame configuration, a maximum of 4 PLC CPUs can be connected for performance expansion. Technical data and notes on programming are contained in the Planning Guide, "Programming the 135 W PLC".

### 7.6.2 Installation of the 135 W PLC

The 135 W PLC is in the stop condition (red LED) when the power is switched on. For installation purposes, the 135 W PLC is subordinated to the COM CPU. It therefore has no control elements.

For initial start-up, the standard NC machine data are loaded first and then, depending on the number of PLC CPUs, NC MD 5038 bits 0 - 3 are set.

**Operator input:**

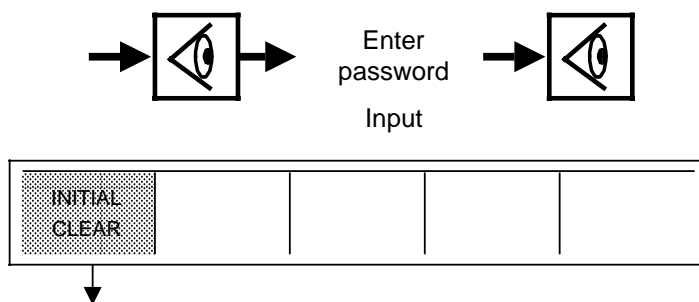

The control is in the "SET UP INITIAL CLEAR" mode. The PLC MD then have to be erased and the standard machined data loaded.

### 7.6.3 Operator input

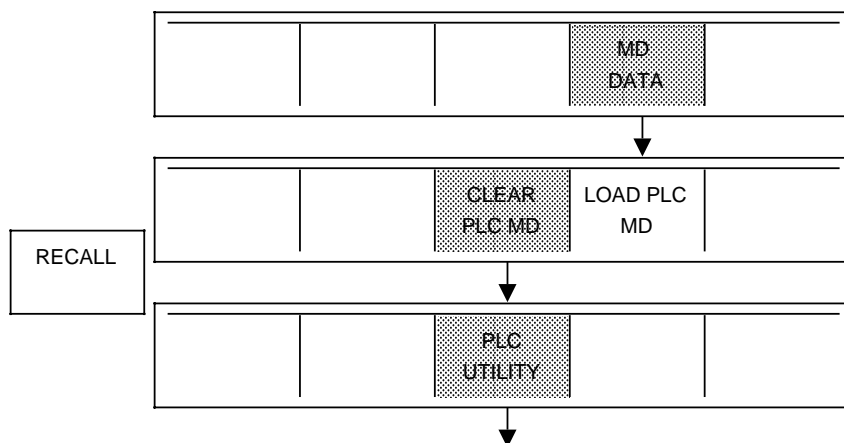

The standard machine data are loaded.

The General Initial Clear function is executed next.

**Operator input:**

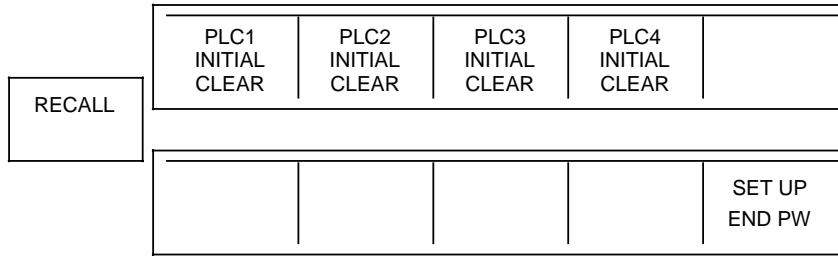

## 8 Machine Interface

### 8.1 Actual-value input measuring circuit (6FX1121-4B.. module)

#### 8.1.1 Connector pin assignments

The actual values are supplied to the CNC via 15-pin connectors (measuring circuit module 6FX1 121-4BA to 6FX1 121-4BK).

1st	actual-value connector	encoder 1
2nd	actual-value connector	encoder 2
3rd	actual-value connector	encoder 3

Incremental rotary encoders (e.g. ROD 426) for linear axes or incremental linear encoders with EXE external pulse-shaper electronics (e.g. LS703 and EXE603 linear scales) are connected.

The input signals to the measuring-circuit modules are identical for both encoders. The 6FX1 121-4B. . module is also available with integrated EXE. In this case the signals are routed from the measuring head directly to the measuring-circuit modules and are converted at the module into TTL signals (also see Section 8.1.5).

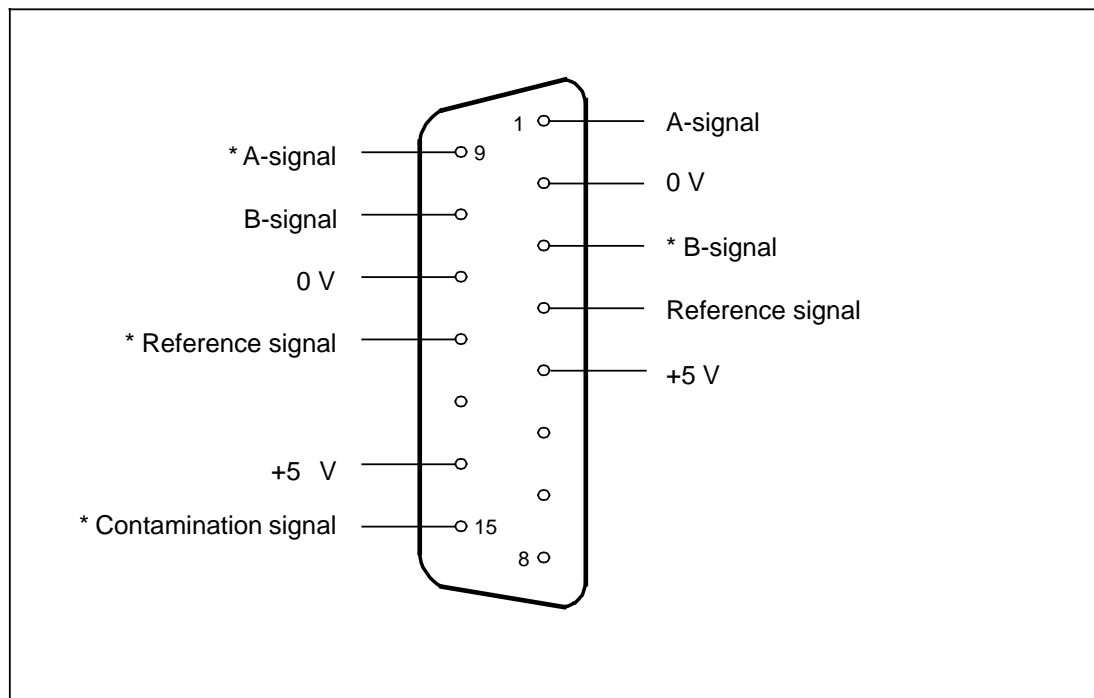

*Actual value connector pin assignments*

### 8.1.2 Differential input

Input signals and characteristics for digital measuring systems with differential output.

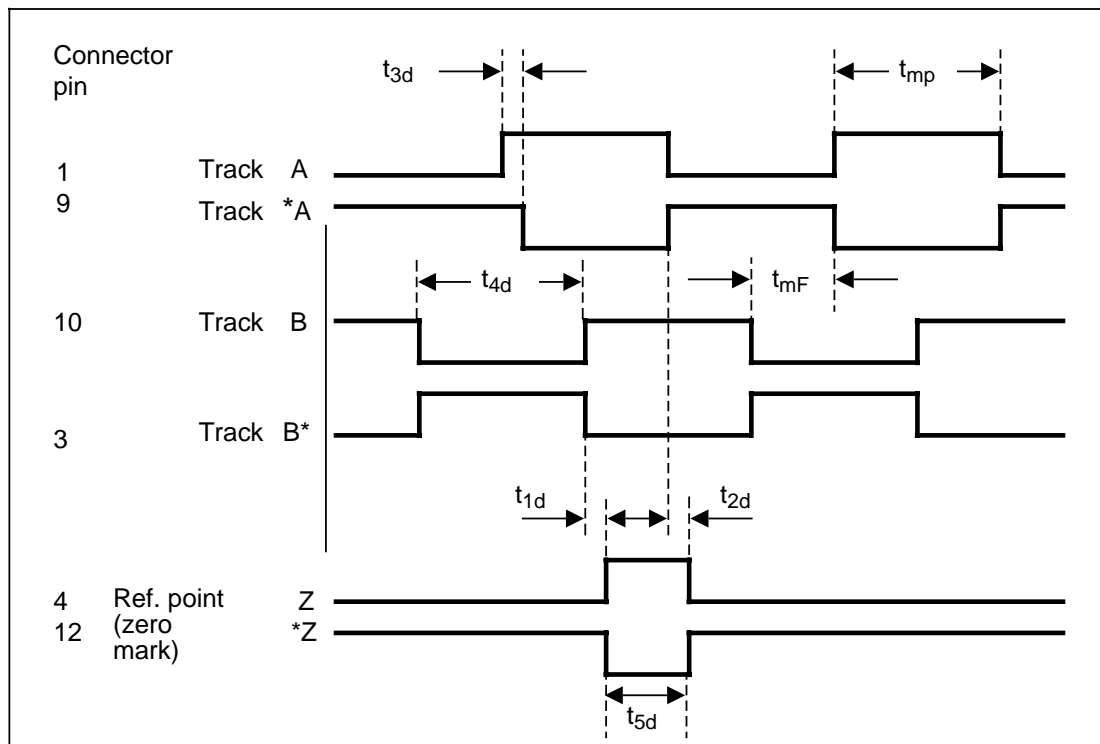

Input signals for digital measuring systems with differential output

Some important characteristics:

- Encoder supply voltage ..... 5 V  $\pm$  5 %
- Ripple of the power supply ..... 100 m V<sub>pp</sub>
- Current per encoder system ..... 300 mA
- Ohmic input resistance ..... 470 Ohm
- Dynamic input resistance ..... 110 Ohm
- Differential input voltage  
e.g. between A and \*A ..... 1 V
- Differential input voltage max. .... 10 V
- Maximum input frequency at 90°  
phase displacement between  
A and B track pulses ..... 1 MHz (without EXE)  
300 kHz (with EXE)
- Minimum pulse width  $t_{mp}$  ..... 400 ns
- Minimum edge spacing (change) ..... 350 ns
- Noise immunity (DIN 57847) - noise signal width ..... 3 kV
- Maximum cable length to the encoder using  
SINUMERIK cables ..... 35 metres
- Minimum spacing between two successive  
edges  $t_{mF}$  ..... 200 ns
- $t_{1d}$  and  $t_{2d}$  ..... 60 ns
- Maximum spacing between two successive  
edges of a track  $t_{3d}$  ..... 20 ns
- Condition for reference track (zero mark) ..... Z = high,  
if A and B = high
- Rate of change (all signals) ..... 1 V /  $\mu$ s
- Minimum length of the zero mark  $t_{5d}$  ..... 200 ns

### 8.1.3 Equivalent circuit diagram with differential input

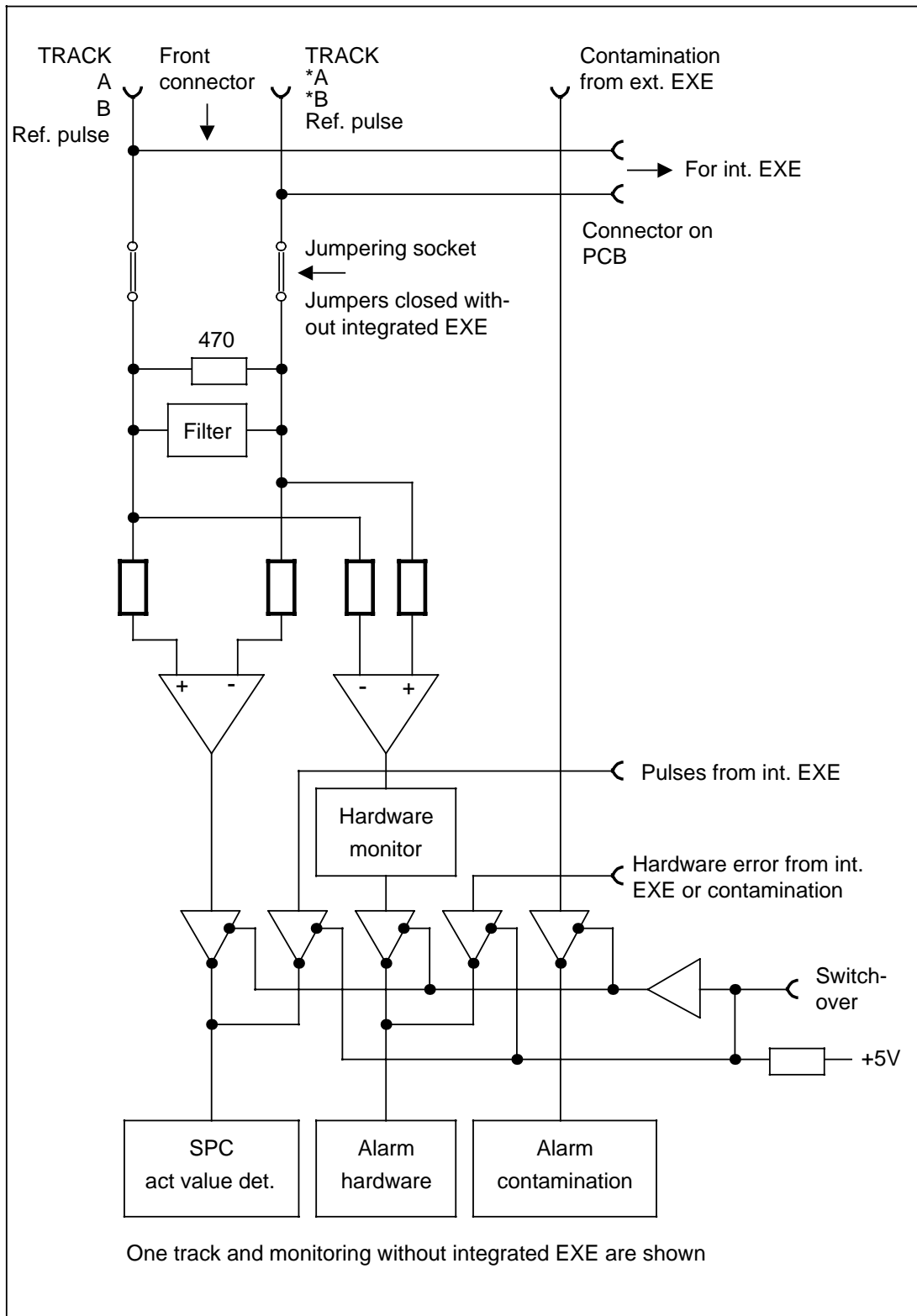

Equivalent circuit diagram with differential input



### 8.1.4 Equivalent circuit diagram for actual-value input with integrated EXE

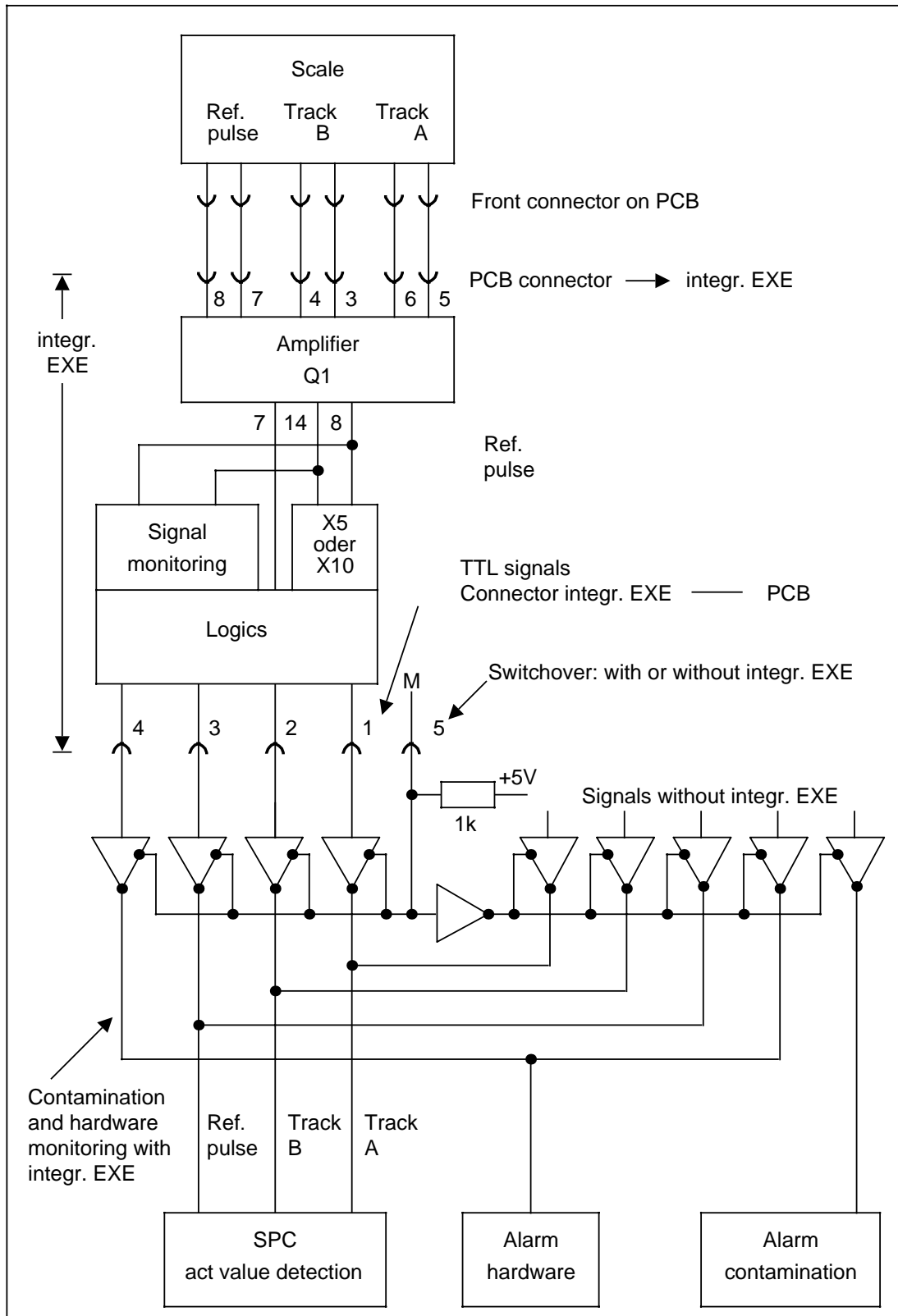

Equivalent circuit diagram for actual-value input with integrated EXE

### 8.1.5 Complement with integrated EXE

A complement of up to three 5-fold EXEs or up to two 10-fold EXEs is possible with the 6FX1 121-4B. measuring circuit module.

The permissible combinations with the maximum complement are as follows:

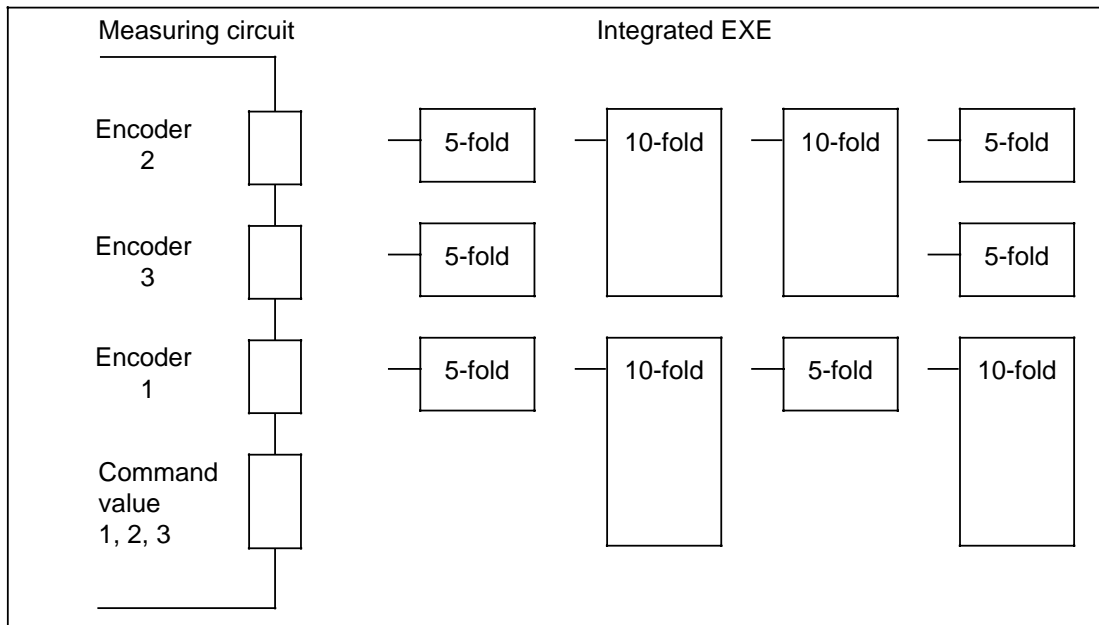

Different complements with integrated EXEs

Width	Machine-readable product designation (MRPD)	MRPD	Axis		
			1 X 131	2 X 111	3 X 121
20 mm	6FX1 121-4BA01	K 20			
40 mm	6FX1 121-4BB01	K 21			
20 mm	6FX1 121-4BC01	K 22			
40 mm	6FX1 121-4BD01	K 23	5		
40 mm	6FX1 121-4BE01	K 24	5	5	
40 mm	6FX1 121-4BF01	K 25	5	5	5
40 mm	6FX1 121-4BG01	K 26	10		
40 mm	6FX1 121-4BH01	K 27	10	10	
40 mm	6FX1 121-4BJ01	K 28	10	5	
40 mm	6FX1 121-4BK01	K 29	10	5	5

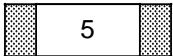
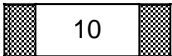
 5 -fold EXEs     
  10 -fold EXEs

Machine-readable product designation of the measuring circuit module according to complement of EXEs, and relevant module widths.

### 8.1.6 Input signals with integrated EXE

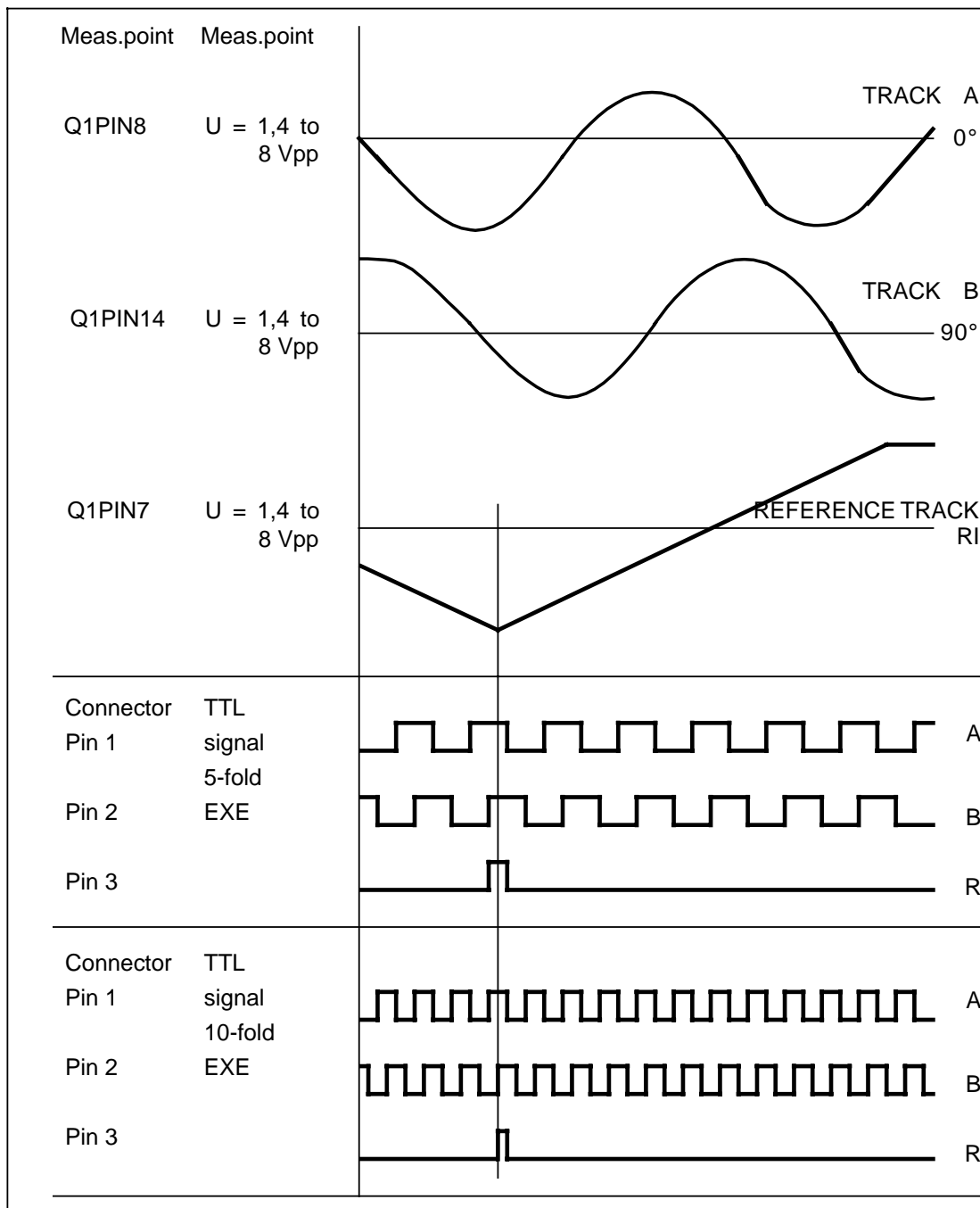

Input signals with integrated EXE

#### Additional data

- Measurements of Q1 signals performed earth-free with respect to measuring point U<sub>0</sub>.
- Phase angle 90° ± 12° of 0°/90°
- Response threshold for fault signal U = (0.7 ± 0.5) Vpp behind amplifier Q1
- Signal size, input EXE tracks A and B approx. 11 µA
- Reference track approx. 3.5 µA

### 8.1.7. Diagnostics help on the ACC board

The analog current closed-loop control, the triggering circuits for the transistors and the interface to the drive units are contained on the ACC board for three axes.

If the drive parameters do not behave as they should, it is possible to check parameters, such as the actual and setpoint values of electric currents on the edge connectors X1 to X4.

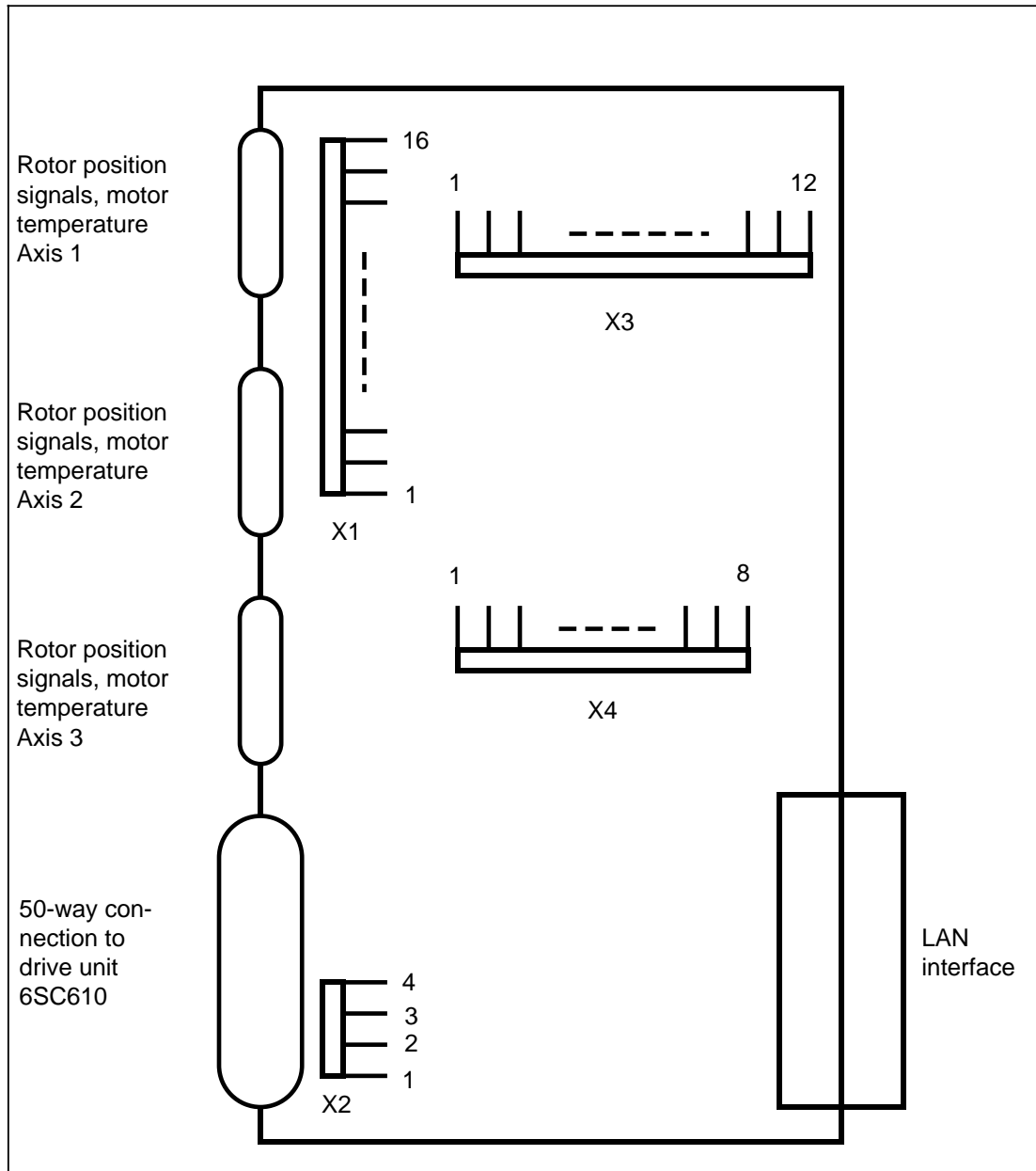

Block diagram of the ACC module

**Measuring point assignments**

<b>X1</b>	1	1G1+	<b>Axis 1</b>			
	2	1G1 -				
	3	1G2+				
	4	1G2 -				
	5	Pulse disable				
	6	Status fault/ready drive unit				
	<b>X2</b>	7	2G1+	<b>Axis 2</b>		
		8	2G1 -			
		9	2G2+			
		10	2G2 -			
		11	Pulse disable			
		<b>X3</b>	12		3G1+	<b>Axis 3</b>
			13		3G2 -	
			14		3G2+	
			15		3G2 -	
			16		Pulse disable	
<b>X2</b>	1	Terminal 65 axis 2				
	2	Controller disable drive				
	3	Pulse disable drive				
	4	Terminal 65 axis 1				
<b>X3</b>	1	Normalized current actual value axis 1				
	2	Current setpoint value (controller) axis 1				
	3	Additional current setpoint value axis 1				
	4	Current setpoint value (DAC) axis 1				
	5	Normalized current actual value axis 3				
	6	Current setpoint value (controller) axis 3				
	7	Additional current setpoint value axis 3				
	8	Current setpoint value (DAC) axis 3				
	9	Normalized current actual value axis 2				
	10	Current setpoint value (controller) axis 2				
	11	Additional current setpoint value axis 2				
	12	Current setpoint value (DAC) axis 2				
<b>X4</b>	1	+2.5 V				
	2	- 2.5 V				
	3	Controller disable axis 3				
	4	Controller disable axis 2				
	5	Controller disable axis 1				
	6	- 10 V				
		+10 V				
	8	Not assigned				

## 8.2 Setpoint output measuring circuit (6FX1121-4B.. module)

### 8.2.1 Connector pin assignments

The set speeds and axis-specific servo enable signals (non-floating switch contact) are output from the control via a 25-pin connector.

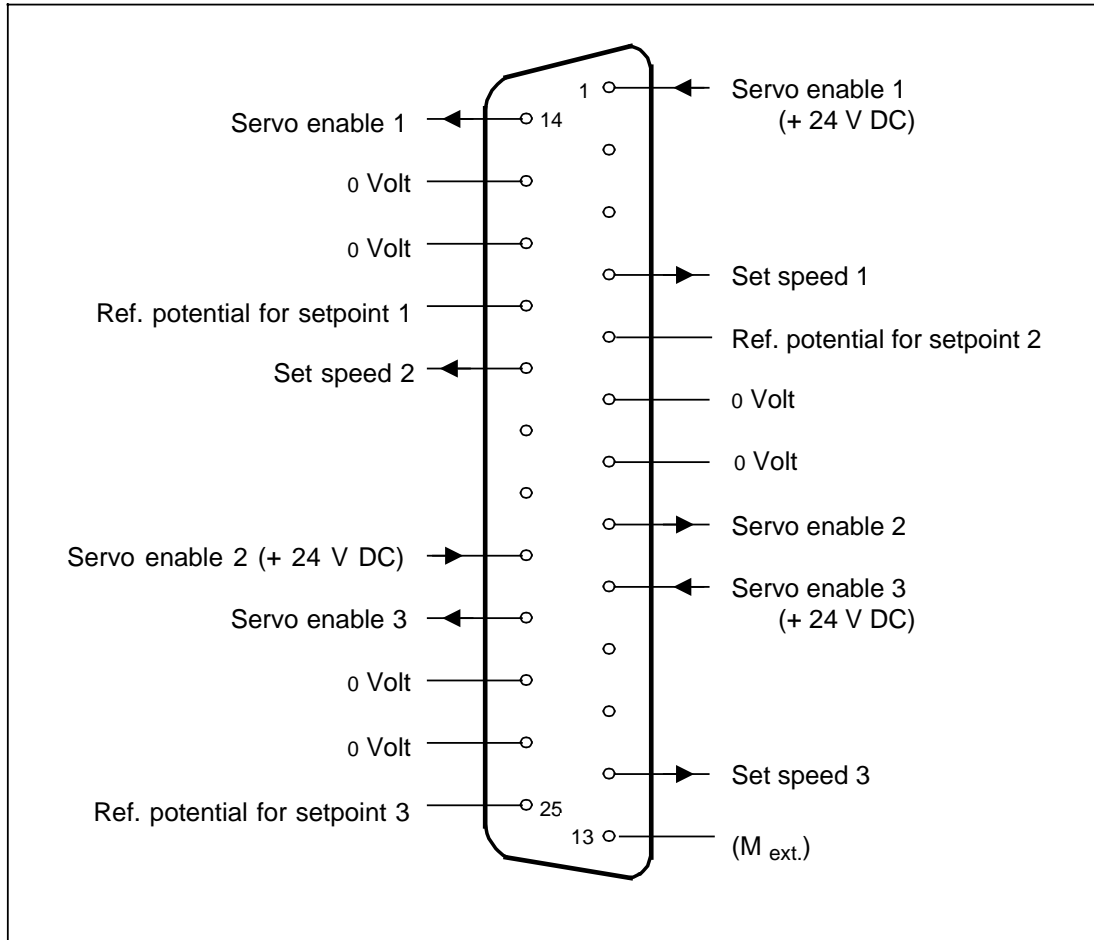

Set value connector pin assignments

#### Characteristics:

- Analog setpoint
  - Voltage Max.  $\pm 10$  V (hardware limit  $\pm 14$  V)
  - Current Max. 2 mA
- Servo enable
  - Supply voltage 20 to 30 V DC incl. ripple
  - Current Max. 100 mA (short-circuit proof)
  - Non-floating switching transistor

**8.2.2 Equivalent circuit diagram of the set speed output (for one axis)**

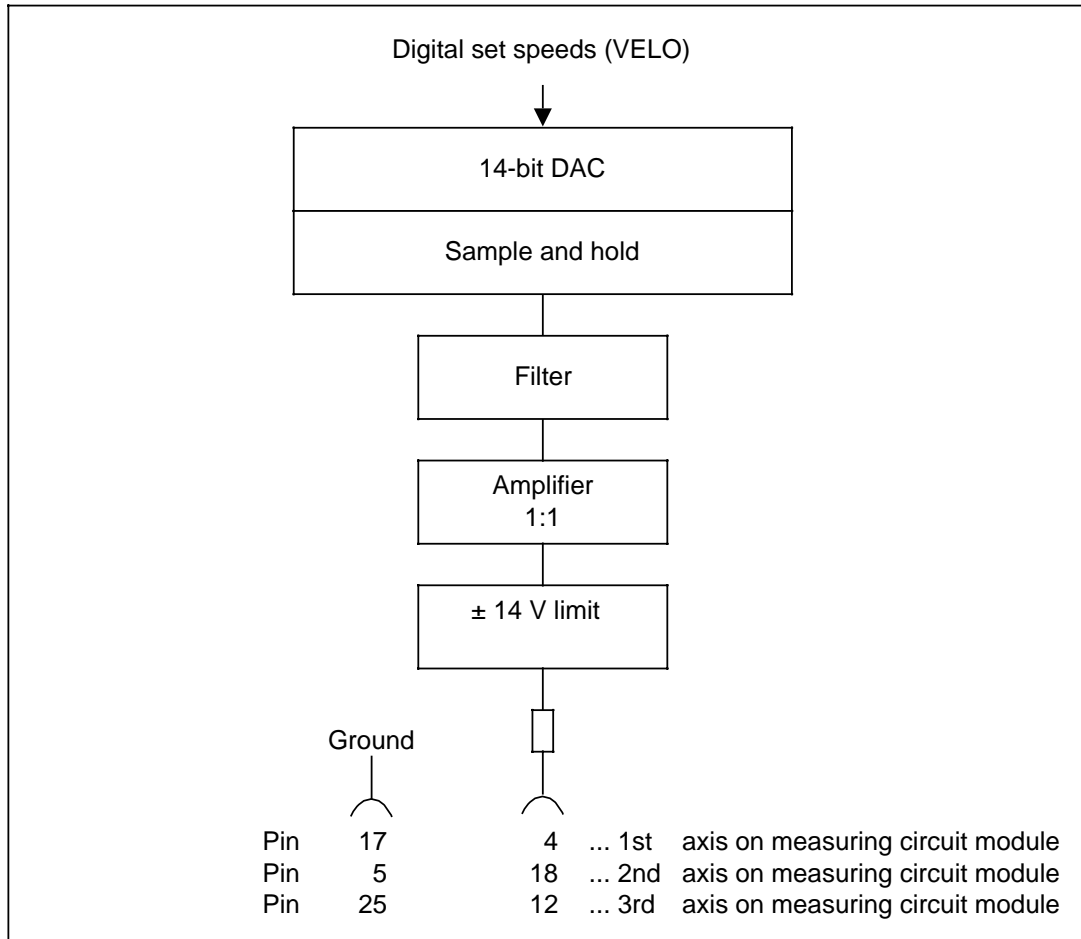

*Equivalent circuit diagram of the set speed output*

### 8.3 Serial interface (V.24 (RS232C) + 20 mA)

The SINUMERIK 880 has up to 4 serial interfaces:

Interface 1 V.24 (RS232C) + 20 mA	OP CPU	6FX1120-4	X121 (Standard)
Interface 2 V.24 (RS232C)	OP CPU	6FX1120-4	X131 (Option)
Interface 3 V.24 (RS232C) + 20 mA	COM CPU	6FX1120-4	X121 (Standard)
Interface 4 V.24 (RS232C)	COM CPU	6FX1120-4	X131 (Option)

**Note:**

Only full duplex operation of the 20 mA interface is possible. A detailed description of the serial interfaces is included in the "UNIVERSAL INTERFACE" Planning Guide (Configuring Instructions).

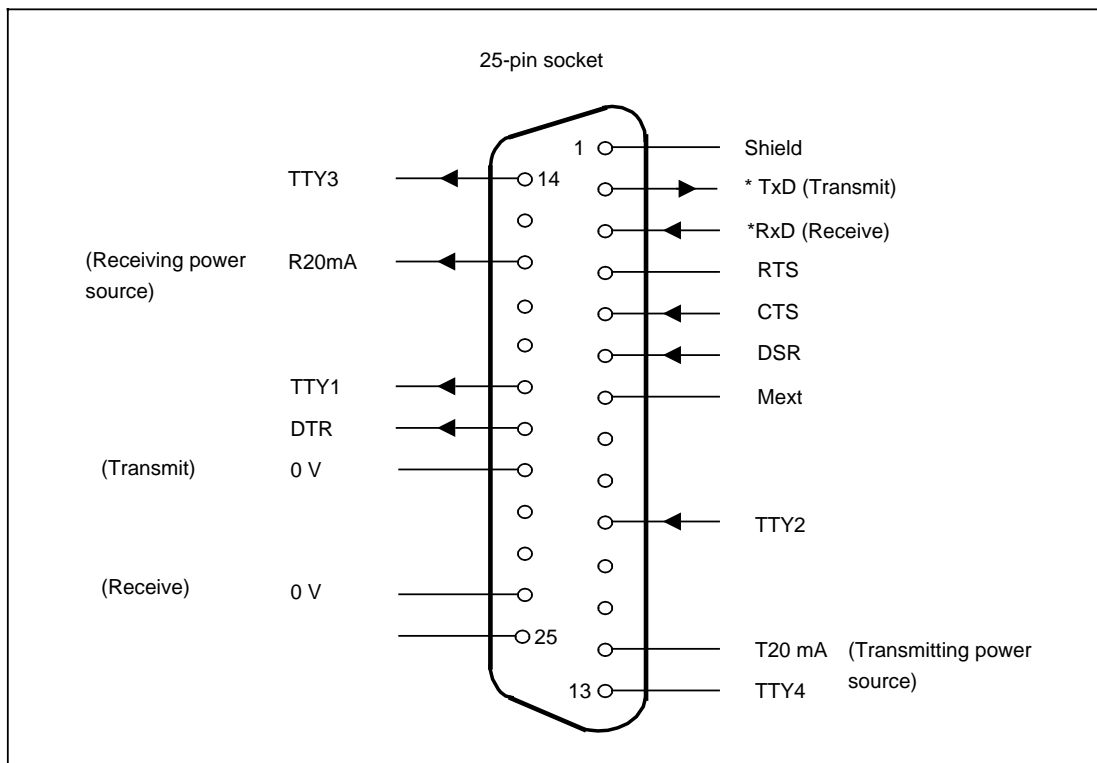

Interface assignment

**Characteristics**

- V.24 (RS232C): Level  $\pm 12$  V  
Signals \*RxD and \*TxD are low active
- 20 mA: Active or passive, determined in connector



### 8.4 Handwheel interface module (6FX1 126-5AA..)

#### 8.4.1 Connector pin assignments

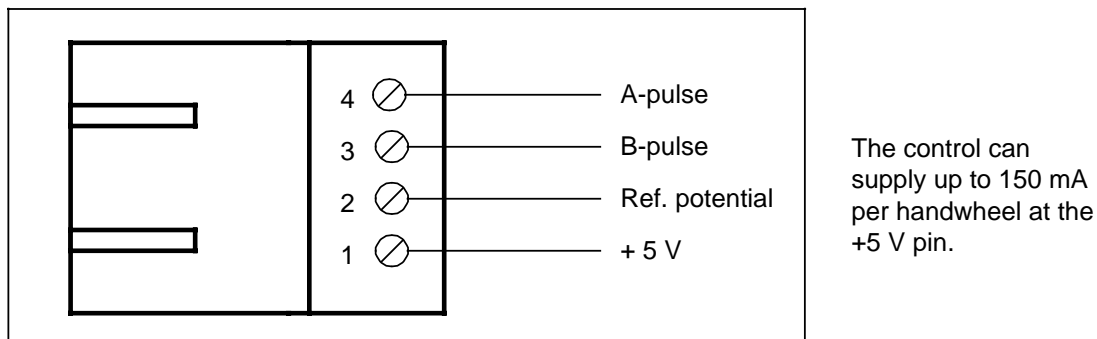

The handwheel voltage supply and the pulses from the handwheel are routed via a 4-pin connector.

#### 8.4.2 Equivalent circuit diagram

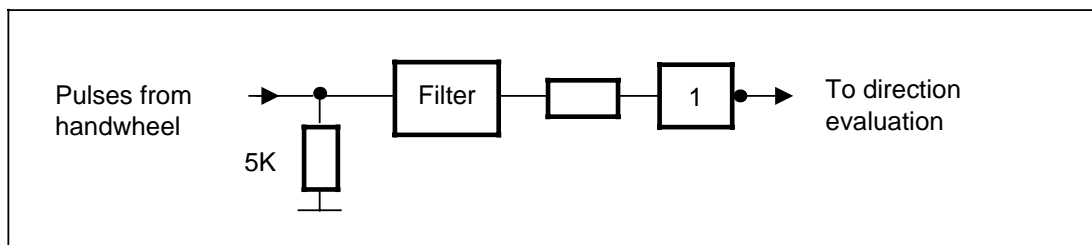

Two pulses A and B with 90° offset are output when changing from one latched position to the next (pulse-interval ratio 1 : 1). The outputs are at a low level in the latched positions.

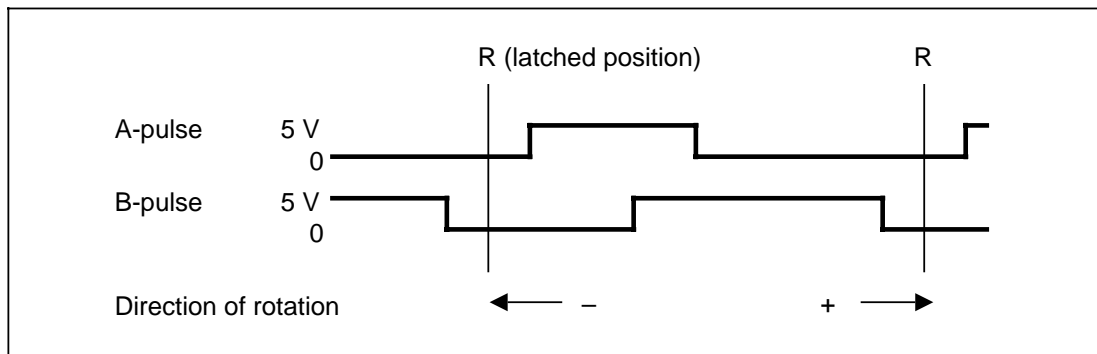

Max. frequency	5 kHz
Low level:	0.9 V
High level:	3.6 V
Voltage:	max. 5.25 V

## 8.5 Short-circuiting connector for actual-value input

The short-circuiting connectors for System 3 and 8 digital measuring systems may **not** be used for the SINUMERIK 800 in view of the different pin assignments.

The connector is used to test the system and measuring circuits with no encoders connected or with no axis available if a modification to the NC MD 560\* bit 0 is not practical.

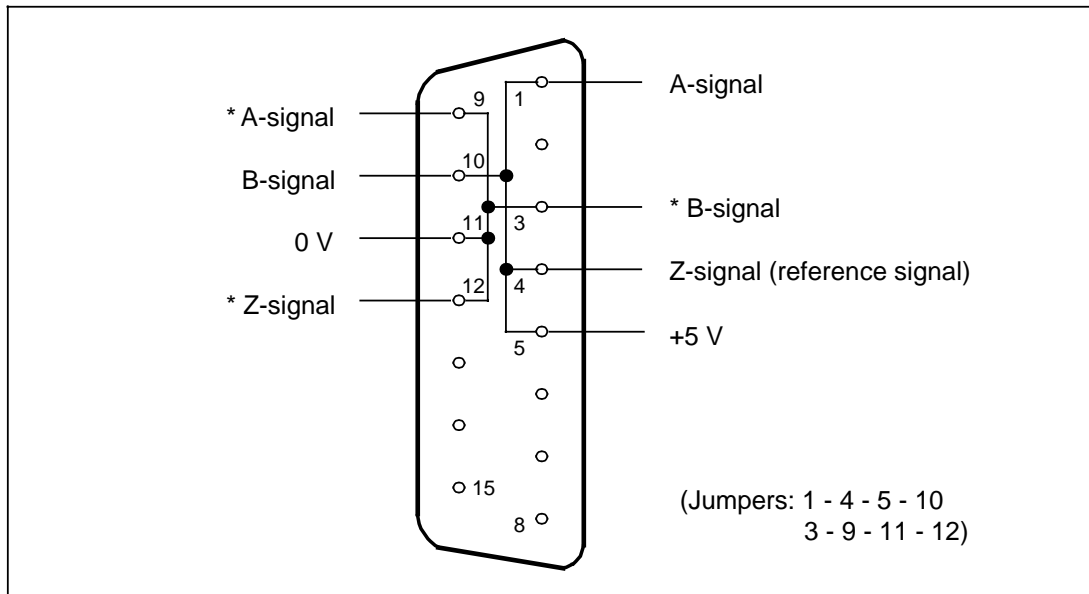

*User-manufacture of connector*

## 8.6 Measuring pulse inputs (sensors)

Jumpering see Section 4.7 (6FX1 136-8BA...).

**Note:**

Only one of the two measuring pulse inputs must be switched active by the NC program with @ 720.

## 9 NC Machine Data/PLC Machine Data/ NC Setting Data

### 9.1 General

The NC machine data (NC MD) are used to match the NC to the machine tool. They should be carefully determined and optimized during installation, unless the machine manufacturer or end user specifies fixed settings.

Input is in an MD card (128 Kbyte RAM) on the multiport or dualport, which is battery-protected against loss of data in the event of the control being disconnected (see also Section 4).

The NC MD may be entered in initial clear mode via the V.24 (RS232) interface at any time and in normal operation both manually and via the V.24 interface if the password has been specified.

#### 9.1.1 Control configuration

When installing and, to a certain extent, in the course of operation (warm restart) the following parts can be configured flexibly:

- NC CPUs
- Servo CPUs
- Measuring circuit modules
- PLC CPUs
- Input/output modules
- PLC expansion units
- Mode groups
- Channels
- TO areas
- Axes
- Spindles

All of these areas are related to the other areas, some directly and some indirectly.

A distinction is made between the software configuration and hardware configuration of SINUMERIK 880.

The *software* configuration defines the number of axes and spindles the system possesses and the distribution to the mode groups and channels. The control is adapted to the requirements of the machine.

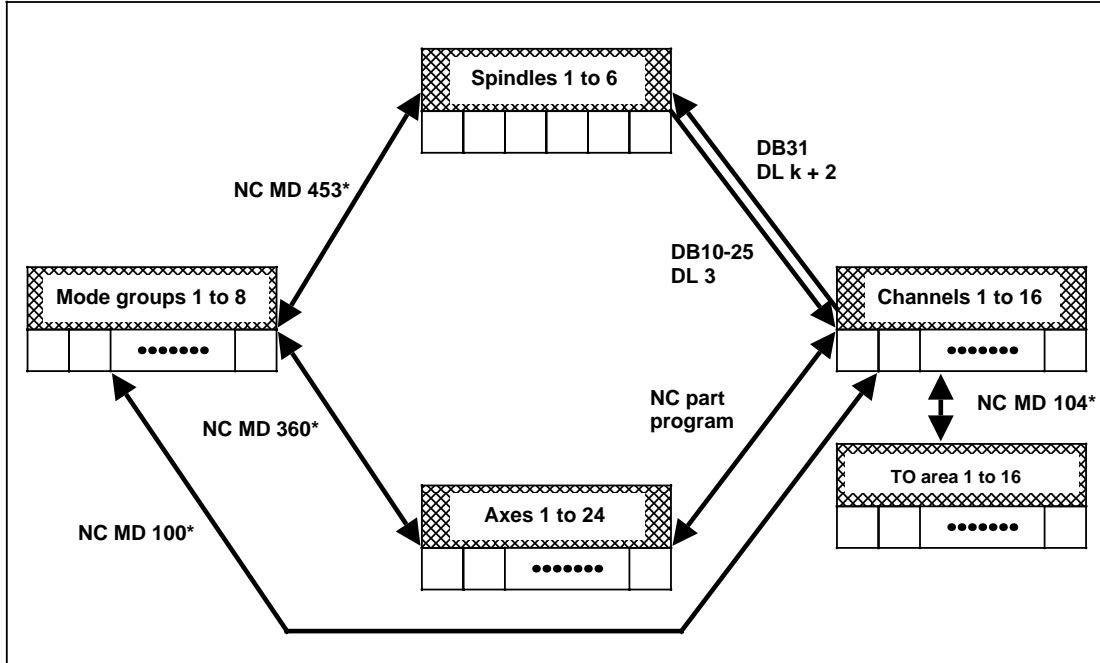

The *hardware* configurations adapt the software to the existing control hardware. The hardware configuration defines how much CPU power is available (number of CPUs), and how much and which modules must be inserted to attain the required limit data as regards position control scan time and block preparation time.

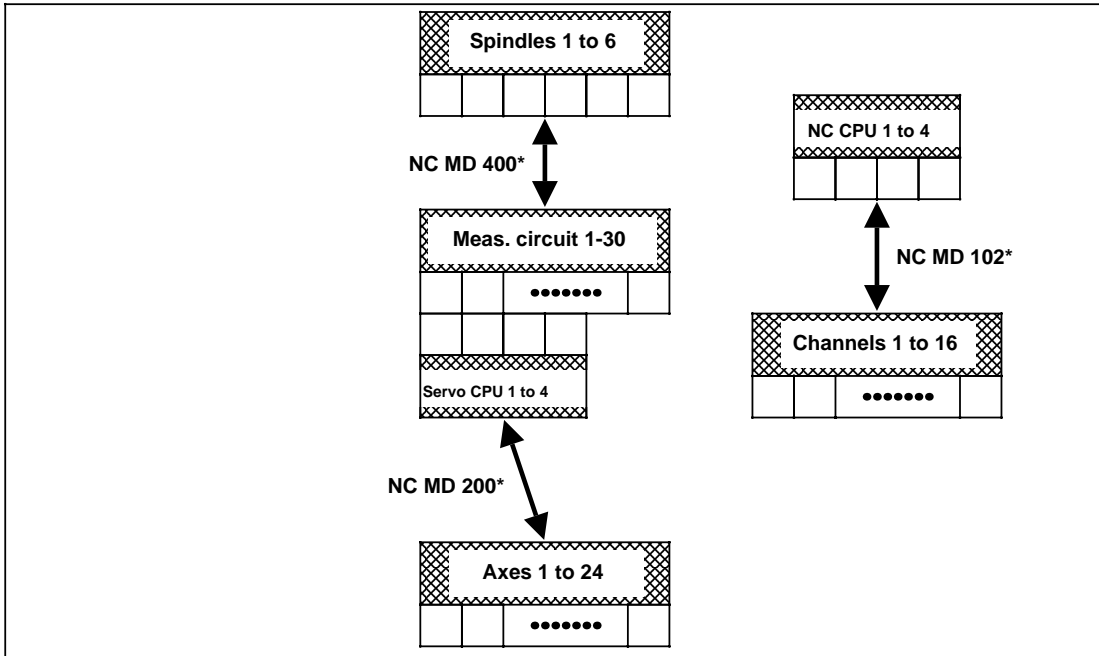

With the same machines (same software configurations) and same PLC user program it is possible, to adapt the required CPU power of the control to the requirements of the customer by hardware configuration.

The hardware and software configurations shown together:

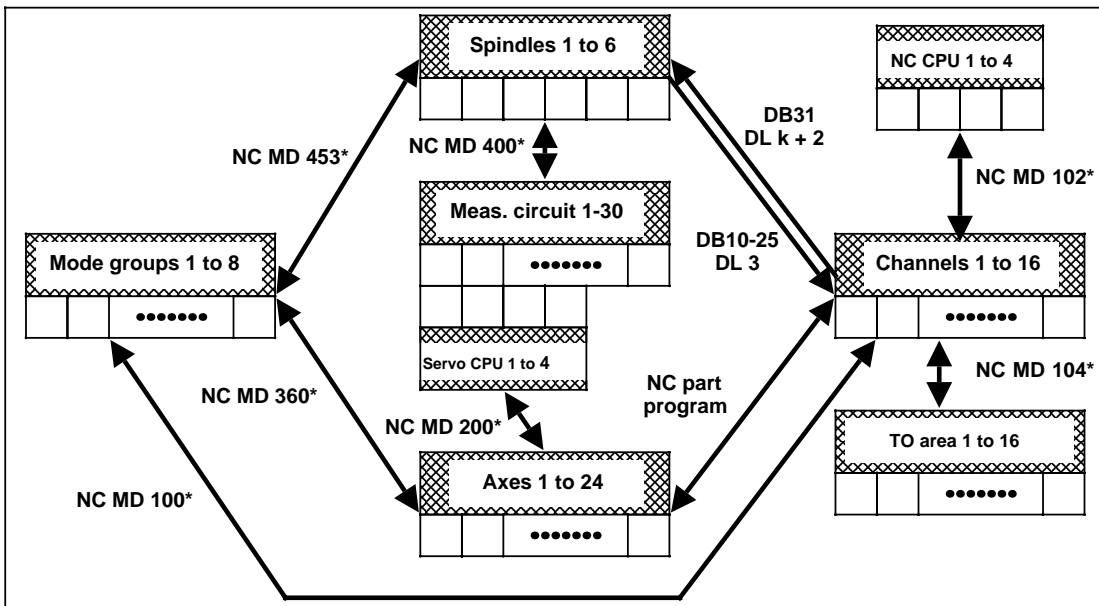

## 9.1.2 Notes on configuration

Up to eight mode groups and 16 channels are feasible in the SINUMERIK 880. Machine data is used to specify the assignment of channels to mode groups, i.e. the mode groups are at a higher level than the channels. Machine data is also used to assign the available axes to the mode groups. Up to 30 measuring circuits (24 axes and 6 spindles) are possible. A maximum of 8 channels can be assigned to one mode group.

In principle, each channel can be compared with its own NC. Each channel may only process its own program, controlled via the PLC. However, channels belonging to the same mode group may only be operated with the same mode; channels assigned to different mode groups as per the machine data may be operated simultaneously with different modes.

The axes are assigned to the channels in the part program, and not via machine data. This means that an axis can operate in various channels within a given mode group, but not simultaneously.

It is possible to inhibit a given axis in a specific channel (NC machine data) to prevent a collision due to a programming error.

The operator can select the various declared mode groups and channels via the operator panel keyboard. At least one channel and one axis must be assigned to each mode group. Mode groups without spindles are permitted.

A channel may only operate the axes in its mode group. An axis may only operate in its assigned mode group. The warm restart function makes it possible to modify the system configuration (assignment to mode groups) without having to re-approach the reference points (see Section 11.6 for warm restart).

On the SINUMERIK 880, a maximum of 4 channels can be activated per NC CPU. With the maximum number of 4 NC CPUs (depending on the version ordered: 1 to 7), therefore, up to 16 channels can be activated. NC machine data is used to determine which NC CPU a channel operates on or whether a channel exists at all. The more channels are activated on an NC CPU the greater the block preparation time. If especially computationally intensive functions are selected (TRANSMIT, 2D/3D coordinate transformation, 3D/5D helical interpolation, etc.) four channels per NC CPU can no longer be activated (alarm "NC CPU failed"). So only up to two channels per NC CPU can be implemented with TRANSFORMATIONS. It might be necessary to increase the standard interpolation time of 20 ms in this case as well (NC MD 155).

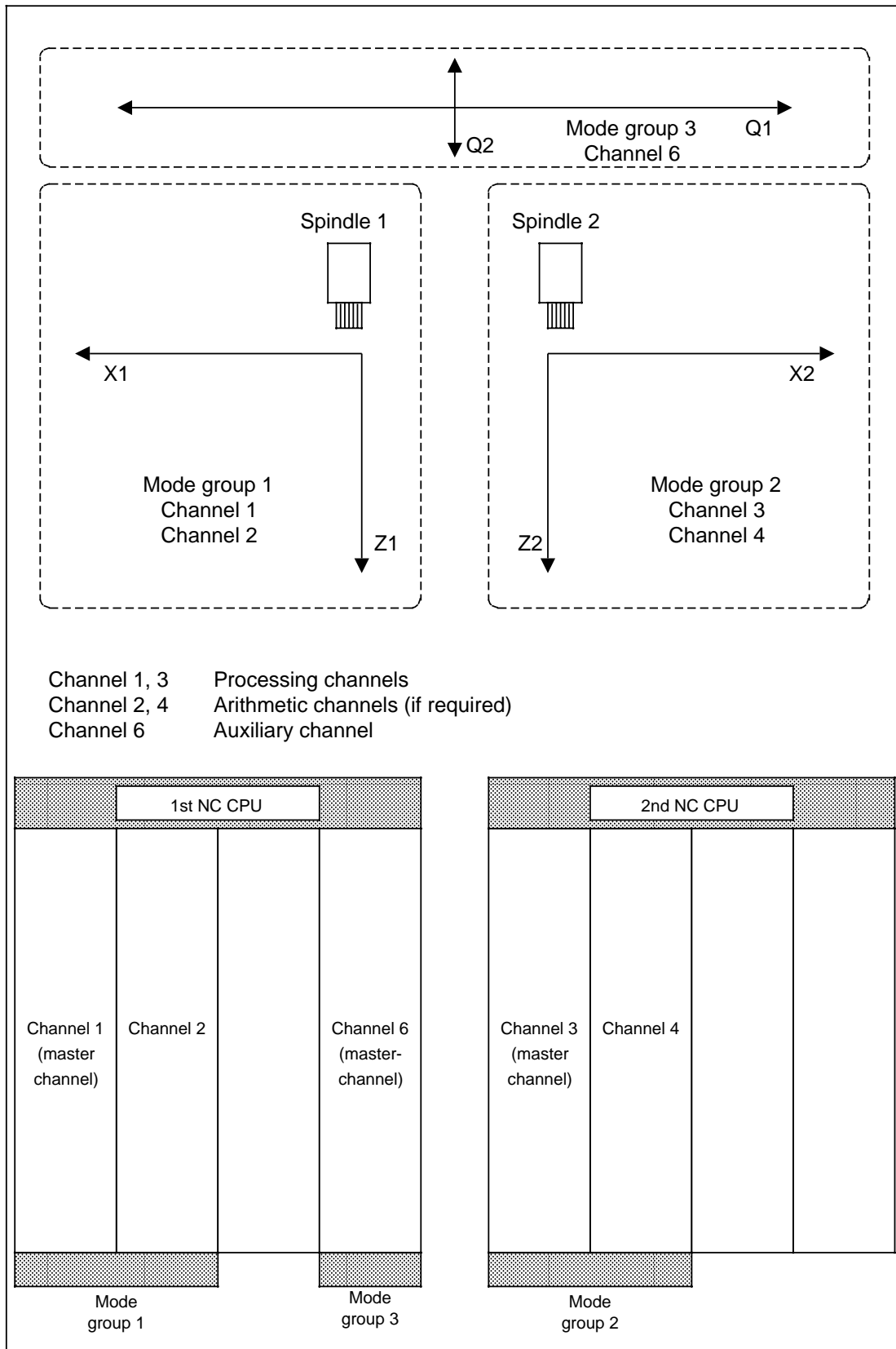

Typical system configuration (double slide machine with two spindles and loading/unloading device)

### ***Function of master channel***

In a mode group the channels are processed in ascending order. The first channel in a group (the one with the lowest number) is declared the master channel of the group in the control. On key reset (RESET on machine control panel), it has the task of executing the following functions:

- Clear all reset alarms specific to mode group
- Clear all axial reset alarms in mode groups
- Synchronize all axes in mode groups
- Clear all spindle-specific reset data in mode groups
- Servo reset for axes in mode groups

The master channel also has a special function at the channel-specific interface (DB 10 - 25):

In the event of the following signals being specified in the master channel of a mode group, they are also valid in all the other channels of the same group:

- RESET (DL 0 bit 6)
- Operating mode (DL 0 bits 0 to 3)
- Feedrate override active (DL 1 bit 5)
- Rapid traverse override active (DR 1 bit 5)
- DRF (DL0 bit 7)

If these signals are specified not in the master channel of a mode group, but in another channel of the same group, they are valid only in the channel concerned.

#### ***Exception:***

DRF and operating mode can be specified only in the master channel, but is valid for the whole mode group.



### 9.2 Mode selection

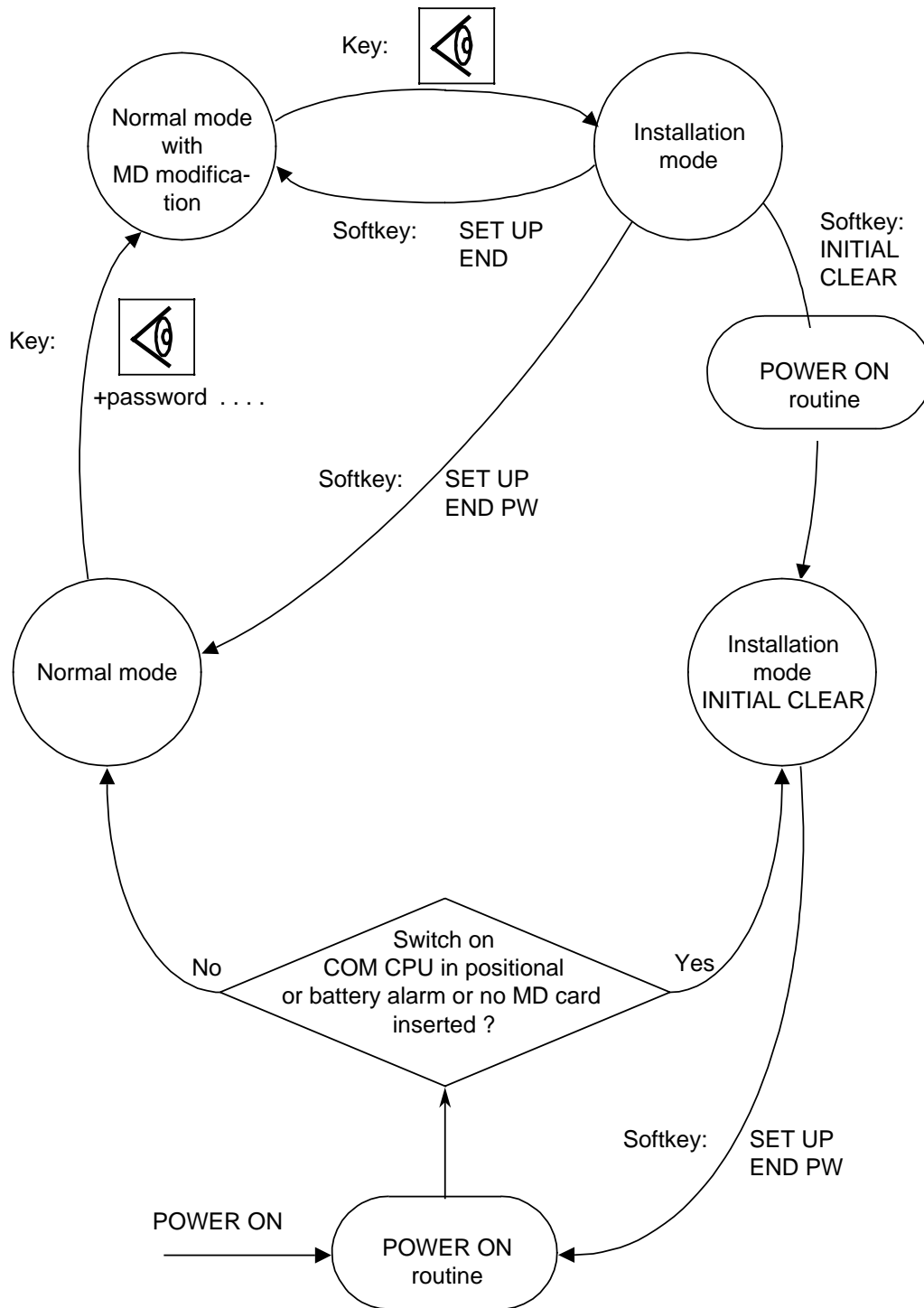

## 9.2.1 Installation mode "INITIAL CLEAR"

### **Standard installation sequence**

In the following installation sequence, it is assumed that neither the NC nor the PLC section of the control has already been started up.

Section 1 (Preconditions and visual inspection) of the Installation Guide must be observed.

All cables and modules, in particular all I/O modules (6FX1 124-6AA..) must be inserted or connected and correctly jumpered.

The NC MD and NC MD bits important for the PLC are dealt with after the installation sequence.

The installation sequence is mandatory since the NC machine data must be input prior to formatting the user memory and clearing the part program memory.

### **Mandatory sequence:**

1. NC initial clear  
Move switch on COM CPU (6FX1120-4BB) to position 1 and operate "POWER ON Reset"; (reset key on power supply unit or switch the system on). The control is in the "INITIAL CLEAR" installation mode.

2. Depress "MACHINE DATA" softkey.

**Caution!** From approx. the end of 1989 the option bits are already set in the factory so that points 3 and 4 must be ignored if the control is in the same state as on delivery.

3. Depress "CLEAR NC MD" softkey; NC machine data is cleared.
4. Depress "CLEAR NC MD" softkey; NC machine data is cleared.
5. Depress "LOAD NC MD" softkey; NC standard machine data is loaded.
6. Depress "CLEAR PLC MD" softkey; PLC machine data is cleared.

7. Press "Recall"  key; return to basic display

8. Depress "NC DATA" softkey.
9. Depress "FORMAT USER M. " softkey  
The following data is erased:
  - Tool offsets
  - Setting data
  - R parameters
  - MIB parameters
  - Zero offsets

The following data is preset:

- The setting data for serial interface 3 is preset
- The MIB parameters are formatted according to NC MD 4 and 5
- The tool offset memory is formatted according to the Option bits and NC MD 210 to 226
- The working range limits are preset to max. values
- Spindle speed limit (S100) is preset

10. Depress "CLEAR PART PR" softkey; the part program memory is formatted according to Option bits and cleared.
11. Read in PLC and NC machine data if available via the serial interface. In installation mode, the setting data bits for the serial interfaces are selected by depressing the "DATA IN-OUT" softkey and can be matched manually to the external input/output device.

**Caution!** The option bits must not be overwritten (check!)

12. Depress "NC DATA" softkey.
13. Depress "FORMAT USER M." softkey.
14. Depress "CLEAR PART PR" softkey.

15. Press "RECALL"  key; return to basic display.

16. Depress "PLC DATA" softkey.

17. Depress "PLC 1 INITIAL" softkey.

18. Depress "PLC 2 INITIAL" softkey if corresponding PLC CPU installed.

19. Press "RECALL"  key; return to basic display.

20. Move switch on 6FX1 120-4BB COM CPU to position 0.

21. Depress "SET UP END PW" softkey POWER ON is performed (see Section 9.2).

No NC MD and PLC MD may be entered, displayed or edited manually in the installation mode.

The PLC is in cyclic operation and flag F24.3 is set, so the basic program performs no processing between the interface and the NC.

In view of the fact that no NC MD and PLC MD can be transmitted to the PLC in the "INITIAL CLEAR" installation mode, the PLC may assume a deliberate stop status. This applies to package 1 (tool management) etc.

### 9.2.2 Normal mode (with MD modification)

In normal operation machine data can be read, manually edited and read in via the V.24 (RS232) interface. The machine data is selected using the "DIAGNOSTICS" softkey.

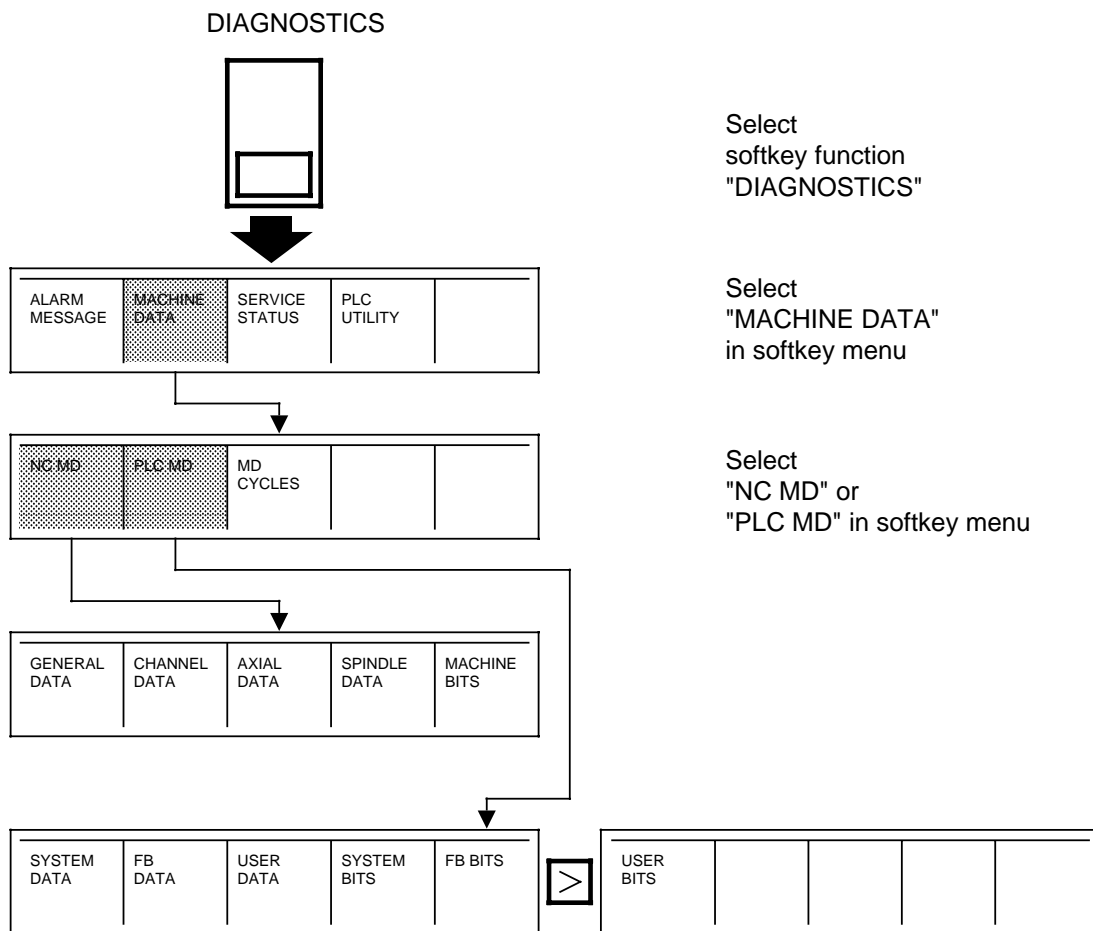

**Caution!**

The following operations are carried out from software version 06:

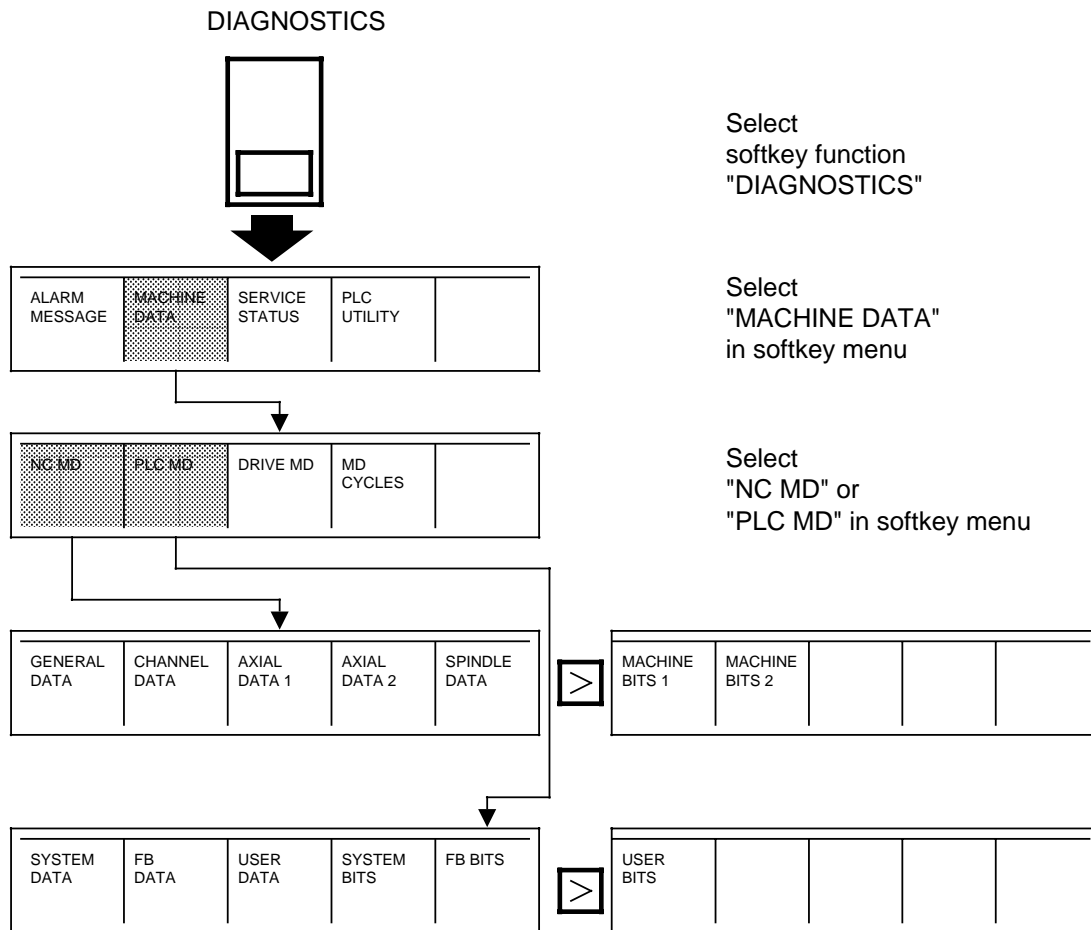

Machine data cannot be edited until the password has been entered.

**Enabling MD input**

- Press "Start "  key and enter password ....

**Inhibiting MD input**

- Press "Start "  key and "SET UP END PW" softkey.

## 9.2.3 Installation mode

Three functions can be activated in the installation mode

- "INITIAL CLEAR" softkey: Software-triggered hardware reset (POWER ON) executed as shown in Section 9.2 mode selection
- "SET UP END" softkey: Jump to normal mode with MD modification without cancelling the password
- "SET UP END PW": Jump to normal mode and cancellation of the password. The machine data cannot be edited without entering the password.

## 9.3 NC machine data

### 9.3.1 General

Breakdown of NC machine data:

- NC MD 0 - 999: General values
- NC MD 1000 - 1999: Channel-specific values
- NC MD 2000 - 3999: Axis-specific values
- NC MD 4000 - 4999: Spindle-specific values
- NC MD 5000 - 5199: General bits
- NC MD 5200 - 539\*: Spindle-specific bits
- NC MD 5400 - 559\*: Channel-specific bits
- NC MD 5600 - 596\*: Axis-specific bits
- NC MD 6000 - 6999: Leadscrew error compensation flags
- NC MD 1000\* - 1799\*: Axis-specific values
- NC MD 1800\* - 1999\*: Axis-specific bits

Effectiveness of individual machine data:

- configuration-specific data (e.g.: MD 200\*, 400\*, 156, ...) after POWER ON
- axis-specific data (e.g.: MD 204\*, 240\*, ...) after RESET (mode group-specific)
- spindle-specific data (e.g.: MD 520\*, Bit 1, ...) after NC STOP/NC START
- display-specific data (e.g.: MD 5007, Bit 7, ...) immediately

A guarantee that **all** machine data will become active immediately according to the function specified here (RESET, NC STOP/START) can **not** be given. Some information on activation can be found in the installation lists.

In case of doubt, users are advised to execute the POWER ON routine since this activates **all** NC MD (exceptions: MD 4, 5, 8, 13, 210 to 226, 5012).

This is the case when

- a) the NC is switched off and on  
or
- b) the "SET UP END PW" or "INITIAL CLEAR" softkey is pressed after the MD input in the installation mode.

After editing certain MDs, the memory has to be reformatted.

- NC MD 4 "FORMAT USER M." softkey
- NC MD 5 "FORMAT USER M." softkey
- NC MD 8 "CLEAR PART PR" softkey
- NC MD 13 "FORMAT USER M." softkey
- NC MD 210 to 226 "FORMAT USER M." softkey
- NC MD 5015 "CLEAR PART PR" softkey

**Caution!**

For safety reasons "POWER ON" should generally be performed (switch control off/on) after editing NC machine data.

### 9.3.2 Position control, input and measuring system resolution

In the case of the SINUMERIK 880, position control resolution and input resolution may be entered independently (NC MD 5002). However, in order to ensure a closed position control loop, the pulses from the digital measuring system and the precision of the control must be matched to one another.

The new units of measurement used are "unit (MS)" for position control resolution and "unit (IS)" for input resolution.

The following applies:

- 1 unit (MS) = 2 units of position control resolution
- 1 unit (IS) = 1 unit of input resolution

**Example:**

Given a position control resolution of 0.0005 mm and an input resolution of 0.001 mm, then  
 1 unit (IS) = 1 unit (MS) = 1  $\mu$ m

For the input, position control and display resolution (from Software Version 3) see NC MD 5002 and NC MD 1800\*.

### 9.3.3 Input units

**Unit (MS) = 2 units of position control resolution (MS reference system)**

e.g. 1 unit of position control resolution = 1/2 μm  
 (MD 5002 = \_\_\_\_010) 1 unit (MS) = 1 μm

**Unit (IS) = 1 unit of input resolution (IS reference system)**

e.g. 1 unit of input resolution = 1 μm  
 (MD 5002 = \_010\_\_\_\_) 1 unit (IS) = 1 μm

**VELO ...smallest unit of digital-analog converter (DAC) for setpoint conversion**

Given a 14-bit DAC then:  $1 \text{ VELO} = \frac{10}{8192} = 1.22 \text{ mV}$

Sampling time settings on the servo CPUs (NC MD 155 + 160 to 163) :

		Ratio of interpolation to position control MD 160 to 163				
		1 : 2		1 : 4		1 : 8
Interpolations [ms]	Sampling time [ms]	Max. No. of axes/spindles per servo CPU	Sampling time [ms]	Max. No. of axes/spindles per servo CPU	Sampling time [ms]	Max. No. of axes/spindles per servo CPU
10	5	Depending on Software Version (see NC MD 160 to 163)	2.5	Depending on Software Version (see NC MD 160 to 163)	disabled	Depending on Software Version (see NC MD 160 to 163)
12	6		3		1.5	
14	7		3.5		disabled	
16	8		4		2	
18	9		4.5		disabled	
20	10		5		2.5	
22	11		5.5		disabled	
24	12		6		3	
26	13		6.5		disabled	
28	14		7		3.5	
30	15	7.5	disabled			

If **disabled** sampling times are selected, positioning and speed control are no longer ensured. Up to Software Version 2 only the interpolation time of 20 ms is enabled.



### 9.3.4 Other machine data

All machine data and machine data bits not described in the Installation Guide must be set to **ZERO**.

### 9.3.5 NC MD description

To maintain clarity in spite of the large number of machine data the MDs for axes, spindles and channels are marked with a "\*" specifies **which** axis, spindle or channel it is, the "\*" must only be replaced by a number beginning with zero.

"*"	0	Axis 1,	Spindle 1,	Channel 1
	1	.	.	.
	2	.	.	.
	3	.	.	.
	4	.	.	.
	5	.	Spindle 6	.
	.	.	.	.
	.	.	.	.
	15	.	.	Channel 16
	.	.	.	.
	.	.	.	.
	.	.	.	.
	23	Axis 24	.	.

### 9.3.5.1 General values

<b>0</b>	<b>Pre-limit switch (to Software Version 2)</b>		<b>0</b>
Standard value	Lower input limit	Upper input limit	Units
<b>20 000</b>	<b>0</b>	<b>99 999 999</b>	<b>units (MS)</b>

**Active: After POWER ON**

From Software Version 3 the pre-limit switch must be entered axis-specific in the NC-MD 1100\*.

The distance by which braking is to be prematurely initiated should be entered if the instantaneous speed is greater than the speed stored in NC MD 1. Consequently, only insignificant overrunning of the position of the software limit switch in circular interpolation can be ensured.

Unless in rapid traverse, overrunning the pre-limit switch activates Alarm 2034.

**Recommendation:**

With program control, the value selected should be slightly greater than the braking distance from rapid traverse to NC MD 1.

Traversing movements likely to overrun the software limit switch position are not even initiated (Alarm 2065 is activated).

**Exception:**

Circular interpolation, helical interpolation

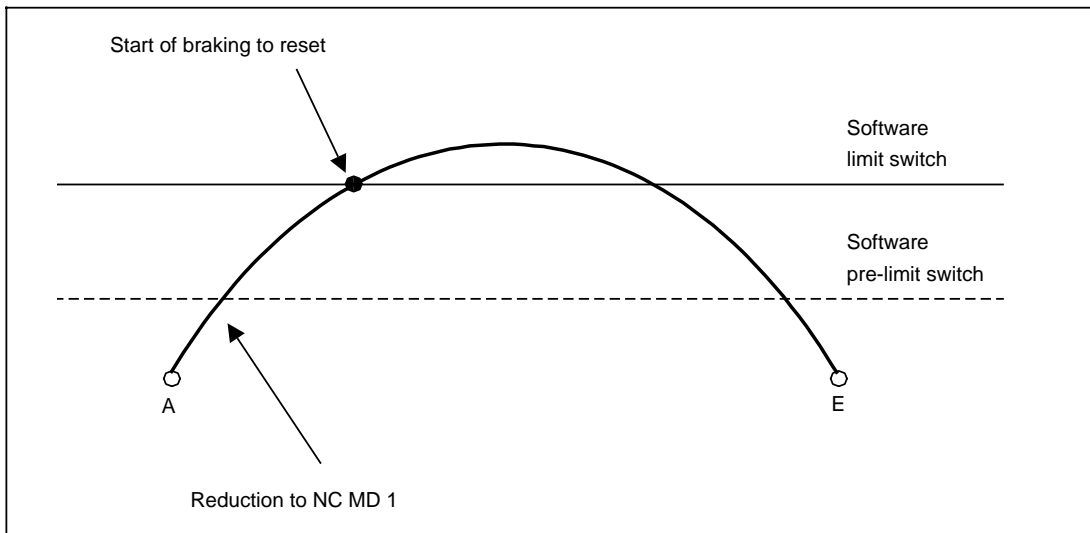

1		Speed behind prelimit switch		1	
Standard value	Lower input limit	Upper input limit	Units		
500	0	100 000	1000 units min (IS)		

**Active: Immediately**

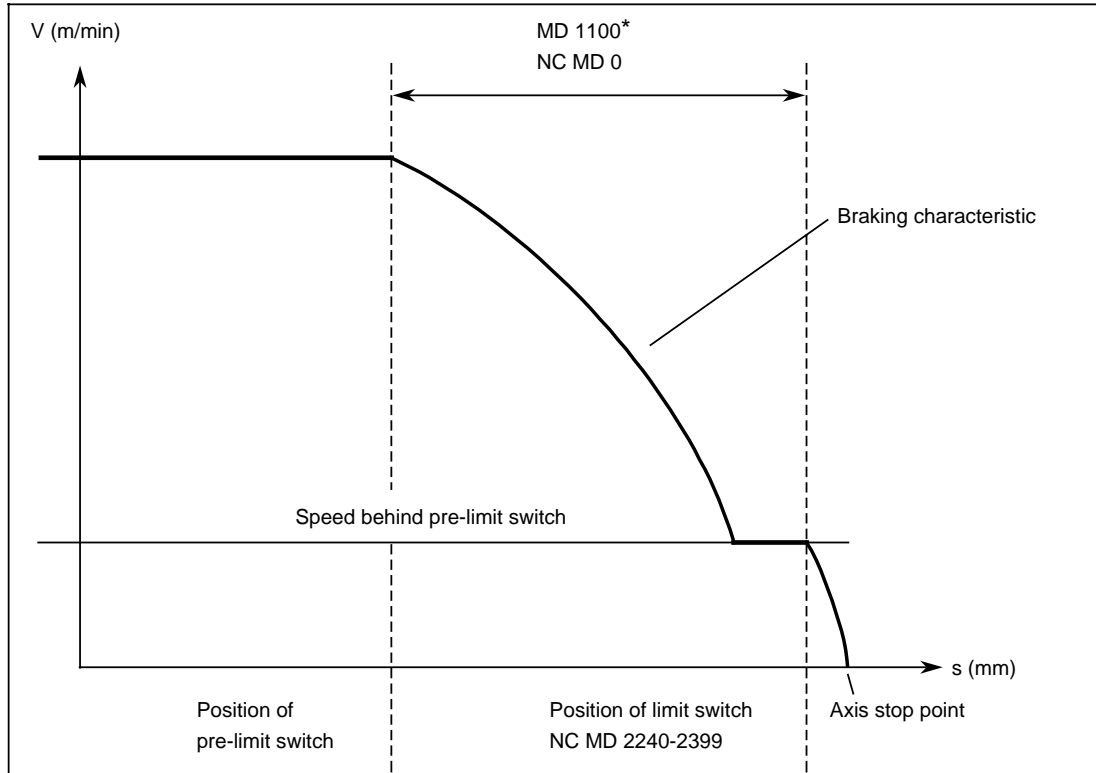

**Note:**

NC MD 1 has no effect if the value 0 is entered in NC MD 0 (up to Software Version 2) or in NC MD 1100\* (from Software Version 3).

<b>3</b>	<b>Corner deceleration rate</b>			<b>3</b>
Standard value	Lower input limit	Upper input limit	Units	
<b>500</b>	<b>0</b>	<b>100 000</b>	<b>1000 units</b> <b>min (IS)</b>	

**Active: Immediately**

In continuous-path mode (G64), block transitions are covered without any feedrate reduction, i.e. the tool path is rounded at points of discontinuity over the contour as a function of the traversing rate.

As a result of function G62 (contouring with feedrate reduction), the tool path feedrate is reduced to the rate entered in NC MD 3, provided the selected feed was higher.

The radiusing is thus reduced at discontinuous block transitions.

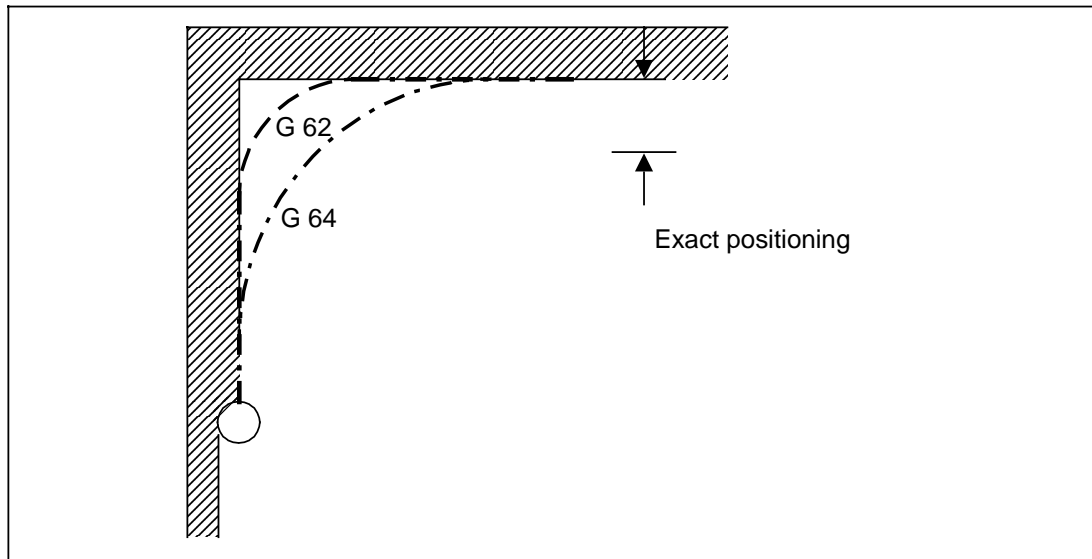

<b>4 MIB parameters for standard cycles (Siemens) 4</b>			
Standard value	Lower input limit	Upper input limit	Units
<b>450</b>	<b>450</b>	<b>500</b>	<b>-</b>

**Active: After user memory has been formatted**MIB = **M**achine **I**nput **B**uffer

The MIB parameters are required for input of variables for the cycles and blueprint programming if entered on the basis of the drilling and milling patterns or contour definition patterns at the controller. NC MD 4 refers to the standard cycles or patterns. If standard cycles and patterns are used in the SINUMERIK 880, NC MD 4 must be defined. The following applies:

NC MD 4 = 500            0 MIB parameters  
 NC MD 4 = 450            49 MIB parameters

The value to be entered is specified by Siemens AG.  
 The entered value must not coincide with the value in NC MD 5.

**Caution!**

Any modification to this value is not valid until the user memory has been formatted ("FORMAT USER M." softkey).

<b>5</b>	<b>EZS parameters for customer</b>			<b>5</b>
Standard value	Lower input limit	Upper input limit	Units	
<b>200</b>	<b>100</b>	<b>449</b>	<b>-</b>	

**Active: After user memory has been formatted**

MIB = **M**achine **I**nput **B**uffer

The MIB parameters are required for input of variables for the cycles and blueprint programming which the customer has generated himself using the programming workstation.

- Reference plane
- Drilling/boring depth
- Final machining allowance
- Chamfer etc.

The machine manufacturer must specify how many MIB parameters he requires. The following applies:

NC MD 5 = 100            0 MIB parameters  
 NC MD 5 = 200        100 MIB parameters  
 NC MD 5 = 449        349 MIB Parameters

The entered value must not coincide with NC MD 4.

**Caution!**

Any modification to this value is not valid until the user memory has been formatted ("FORMAT USER M." softkey).

**Example:**

NC MD4 ... 450  
 NC MD5 ... 200

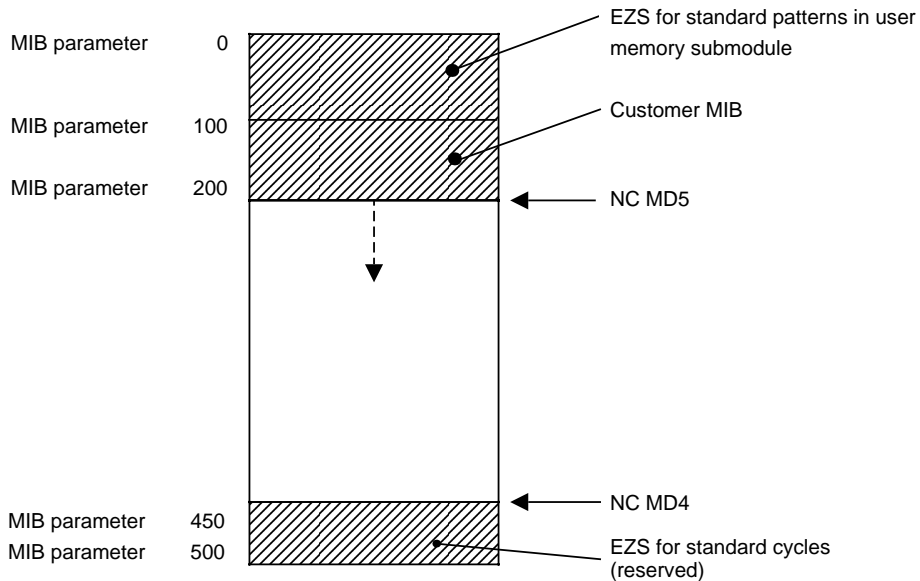

<b>6</b>	<b>Threshold for CRC insertion blocks</b>			<b>6</b>
Standard value	Lower input limit	Upper input limit	Units	
<b>0</b>	<b>0</b>	<b>2 000</b>	<b>units (IS)</b>	

**Active: In next block**

One or more intermediate blocks for linear compensating movement(s) are inserted for transitions from a circular contour to a straight contour or to another circular contour (see Programming Guide). With these compensating movements, the programmed feedrate is maintained along the cutter centre path; during machining, however, the feedrate is maintained with respect to the workpiece contour. This results in differences in feedrate. In order to prevent drops in speed if the travel is inadequate, the compensating movements beneath threshold "d" are shortened or omitted as follows:

Full self-adjustment:

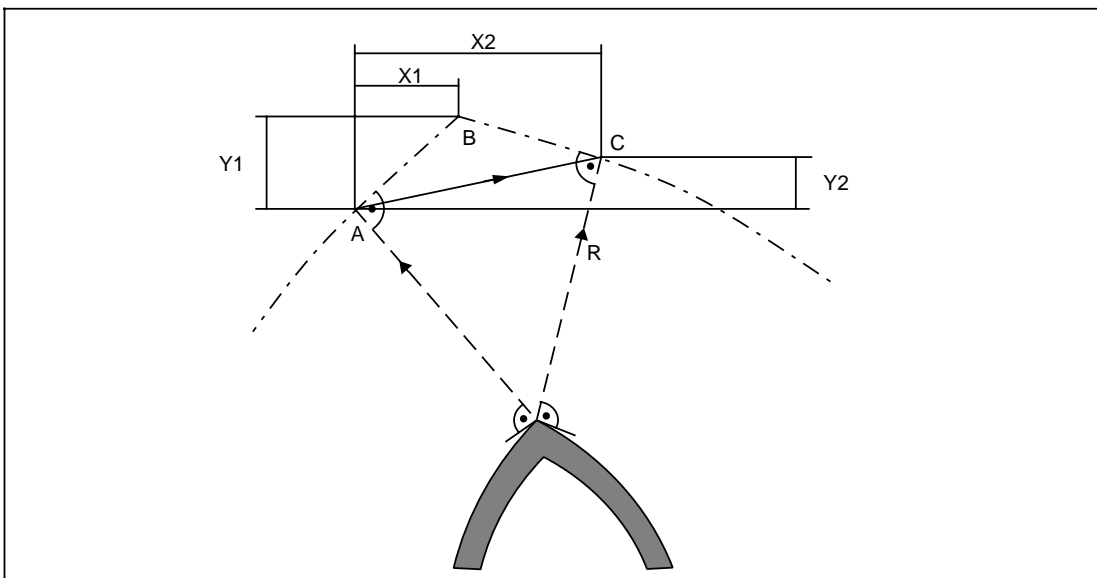

Shortened self-adjustment A C:

No self-adjustment:

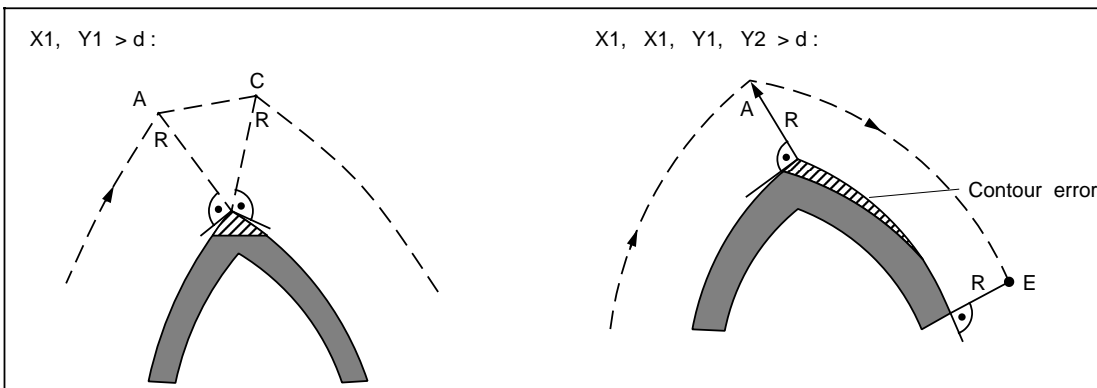

<b>7</b>	<b>Circle end position monitoring</b>			<b>7</b>
Standard value	Lower input limit	Upper input limit	Units	
<b>5</b>	<b>0</b>	<b>32 000</b>	<b>units (IS)</b>	

**Active: In next block**

Before a circular block is processed, the NC checks the "correctness" of the programmed values by determining the difference in radii for the starting and end positions. If the difference exceeds the upper limit specified above, the block is not cleared for processing. Alarm 2048 (circle end point error) is displayed.

If the difference is less than but not equal to zero, the centre point parameters are corrected since it is assumed that the end position has been correctly programmed. The circle is then traversed on the basis of the new centre point.

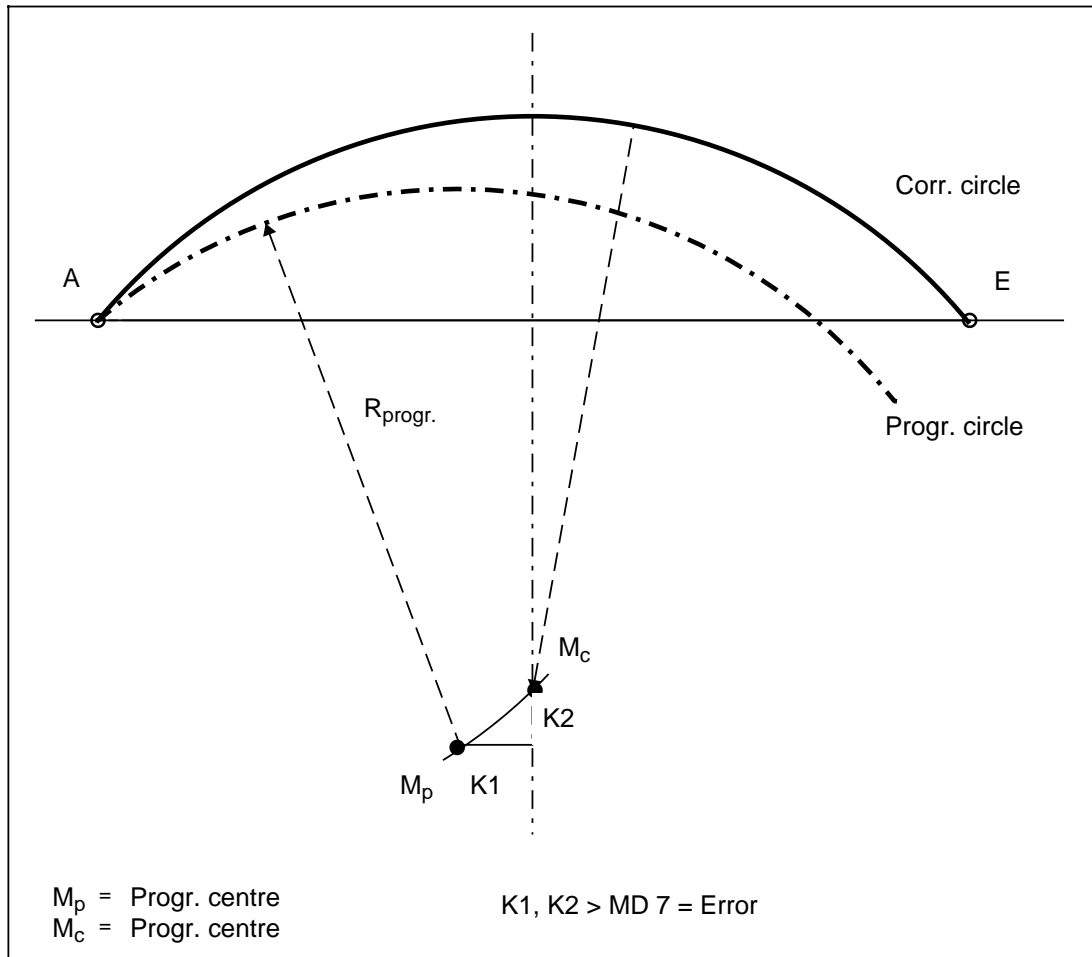

Circle end position monitoring



<b>Maximum number of part programs (to Software Version 2)</b>			
<b>8</b>			<b>8</b>
Standard value	Lower input limit	Upper input limit	Units
<b>200</b>	<b>1</b>	<b>1 000</b>	<b>-</b>

**Active:**    **Up to SV 2:**    after part program memory has been cleared  
                  **From SV 3:**    after POWER ON

For each part program provided, the SINUMERIK 880 (Software Version 2) reserves a small memory area (11 bytes) for program organization purposes. 1000 part programs can be input but far fewer programs are usually stored in the memory at any one time, so a significant memory area would have to remain empty. To prevent this, matching to the part programs actually anticipated can be performed.

#### Caution!

Any modification to this value is not valid until the contents of the part program memory have been erased (softkey "CLEAR PART PR")!

With **Software Version 3** the organization of the part program memory was changed so that when programs are erased the memory area becomes free immediately without "REORG". To achieve this an organization with pages and sectors was chosen.

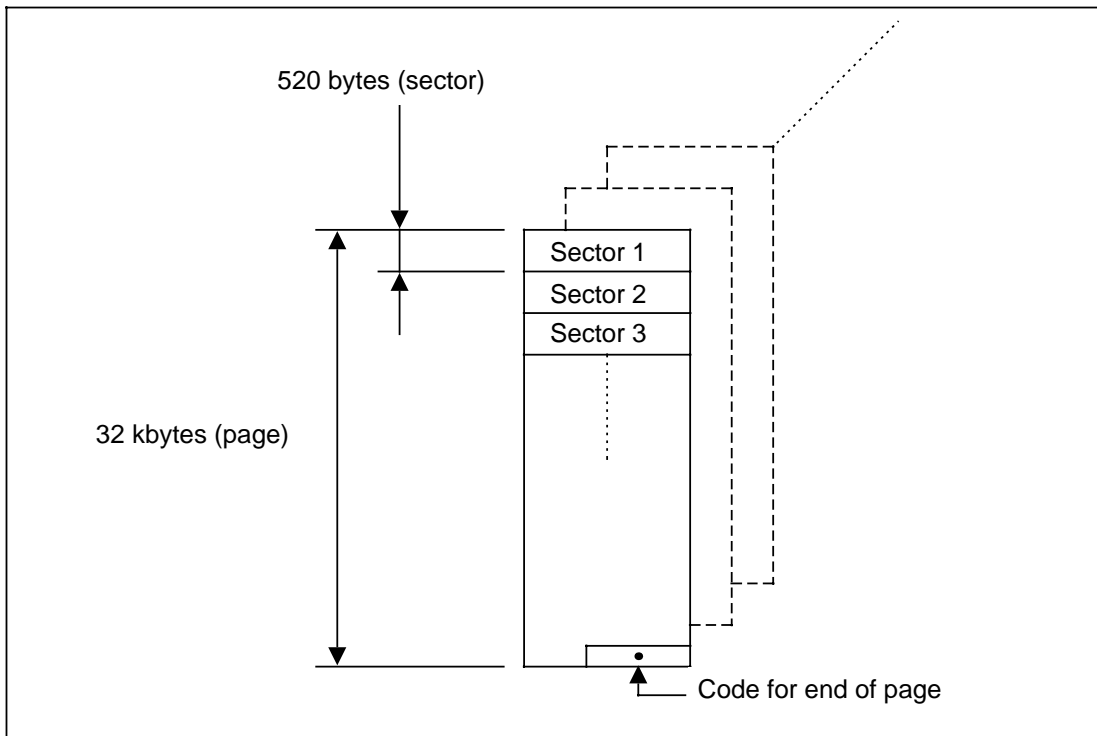

The maximum number of part programs which can be stored at one time from Software Version 3 no longer depends on NC MD8 but on the memory capacity (see the following table):

Memory capacity [ Kbytes ]	Number of free sectors	Max. number of part programs
32	56	55
64	119	115
96	181	175
128	245	237
256	494	477
384	745	720
512	994	960

The max. number of programs assumes that none of the programs stored is longer than 506 characters.

9		Error window for repositioning		9	
Standard value	Lower input limit	Upper input limit	Units		
200	0	32 000	units (IS)		

**Active: In next block**

Automatic interrupt during circular machining (G2/G3) is followed by departure from the contour in JOG mode.

Repositioning is required in JOG mode prior to NC restart.

Alarm 3018 is output and the program is not started if the axis after NC start is outside the tolerance entered in NC MD 9 (hatched area).

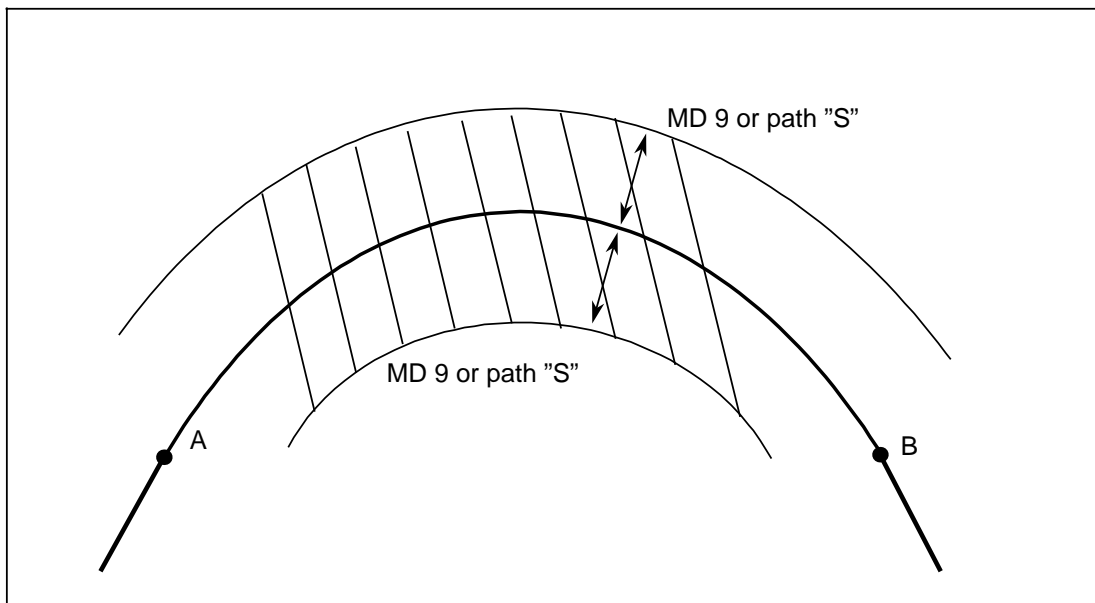

*Tolerance range defined in NC MD 9*

<b>10</b>	<b>Feed after block search</b>			<b>10</b>
Standard value	Lower input limit	Upper input limit	Units	
<b>1 000</b>	<b>0</b>	<b>100 000</b>	<b>1000 units min (IS)</b>	

**Active: In next block**

If the machining program is not initiated at the start but rather at an existing block using block search, the programmed rate may not be suitable for the traversing path (G95 or G96 active, but no spindle rotation; very small F value programmed).

If the axes are not at the starting point of the first block selected by block search but instead are in some other position, the controller would output the programmed speed of the travel block. This could possibly result in critical situations; consequently, the value entered under NC MD 10 is used for travel after block search as far as the first starting position. The speed input applies to a feedrate override of 100 %.

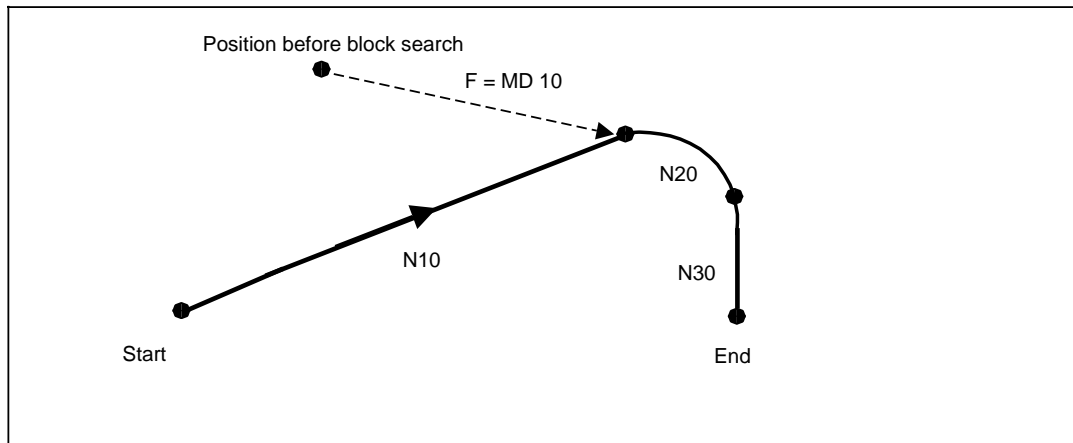

Diagrammatic example

**Caution!**

MD 10 is not active in the event of block search to a block with G00.

***From software version 4.2, the programmed feedrate from the part program is always used to traverse to the end point of the target block if value 0 is entered in NC MD 10.***

<b>13</b>	<b>Number of tool offset parameters</b>			<b>13</b>
Standard value	Lower input limit	Upper input limit	Units	
<b>10</b>	<b>10</b>	<b>32</b>	-	

**Active: After user memory has been formatted**

Each tool offset has as a standard feature up to ten tool offset parameters (TO parameters) with fixed allocation. These parameters may be expanded by the user to 32 as and when required. These expanded TO parameters (10 to 32) must be allocated by the user using the programming workstation. As the number of TO parameters assigned to a tool offset increases, so the number of tool offsets available to the user decreases since a fixed memory area is assigned to the tool offsets as a whole.

Parameter	Tool offset		Remarks
10	204	409	Reset
11	186	372	
12	170	341	
13	157	315	
14	146	292	
15	136	273	
16	128	256	
17	120	240	
18	113	227	
19	107	215	
20	102	204	
21	97	195	
22	93	186	
23	89	178	
24	85	170	
25	81	163	
26	78	157	
27	75	151	
28	73	146	
29	70	141	
30	68	136	
31	66	132	
32	64	128	

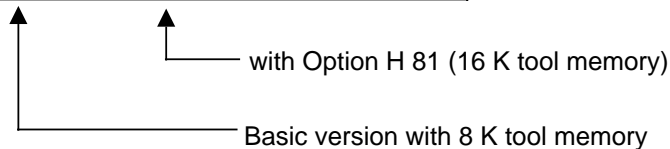

**Note:**

32 tool offset parameters possible with SINUMERIK 880 from Software Version 3.

**Caution!**

A change only becomes active after formatting the user memory (softkey "FORMAT USER M.").

<b>14, 15</b> <b>16, 17</b>	<b>Measuring cycles machine data</b> <b>Measuring cycles setting data</b>		<b>14, 15</b> <b>16, 17</b>
Standard value	Lower input limit	Upper input limit	Units
<b>0</b>	<b>0</b>	<b>199</b>	<b>-</b>

The measuring cycles machine data and measuring cycles setting data are located in the channel-specific R parameters. Areas for measuring cycles MD and for measuring cycles SD are specified in the R parameters for each NC machine data (NC MD 14-17). If these areas coincide, the corresponding R parameters for the measuring cycles setting data take priority. The measuring cycles machine data are inhibited via the identification number (ID number), while the measuring cycles setting data are inhibited by means of a key switch as a function of NC MD 5005 bit 3. Inhibiting with all measuring cycles data is only active from the keyboard. Since these machine data are for the general areas of the measuring cycles MD and measuring cycles SD, a measuring cycles MD/SD area in the channel-specific R parameters is identical for each channel.

The measuring cycles MD and measuring cycles SD are fully assigned by the Option B78 (measuring cycle version 10) and FB package 1 (tool management).

During standard installation the following values are entered in the NC machine data:

NC MD 14 = 100	from	} password-protected R parameters
NC MD 15 = 199	to	
NC MD 16 = 110	from	} keyswitch-protected R parameters
NC MD 17 = 133	to	

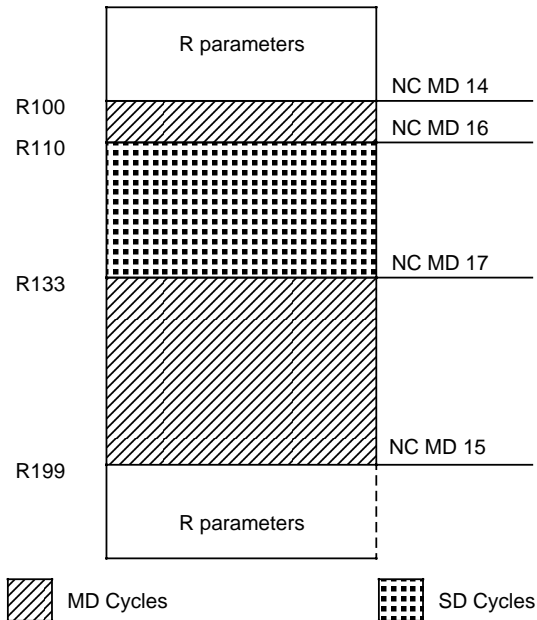

The measuring cycles (option B78) of version 20 are no longer located in R parameters R110 to R199, but the newly created cycle MDs and cycle SDs in Software Version 3. For reasons of compatibility it is still possible to define certain R parameters as measuring MDs/SDs and to protect them from unwanted input with a password or keyswitch.

<b>18</b>	<b>Zero offset group</b>			<b>18</b>
Standard value	Lower input limit	Upper input limit	Units	
<b>1</b>	<b>0</b>	<b>10</b>	<b>-</b>	

This MD has only an internal significance when using the Siemens cycle L960.

<b>19</b>	<b>Next cutting edge for grooving cycle L93</b>			<b>19</b>
Standard value	Lower input limit	Upper input limit	Units	
<b>0</b>	<b>0</b>	<b>10</b>	<b>-</b>	

The grooving cycle L93 and the measuring cycles (option B78) use two-edged tools. The second edge is assumed to be addressed with the tool offset  $D_{x+1}$  (first edge ... $D_x$ ). If, however, the Siemens tool management of SINUMERIK 880 is used (cycle MD 7000 bits 4 to 1), the tool offset number for the second edge is transferred from the tool management in an R parameter. If, for reasons of compatibility, the tool management of SINUMERIK 850 (only when upgrading from 850 to 880) or a tool management from another manufacturer is used, a P memory (in the TO memory) must be input in NC MD 19.

NC MD 19 specifies the P memory (in the TO memory) where the reference to the next cutting edge is located when multiple edge tools are used. The reference can only be located in P memories 5 to 10.

<b>20</b>	<b>Basic angle for nutating head</b>			<b>20</b>
Standard value	Lower input limit	Upper input limit	Units	
<b>0</b>	<b>0</b>	<b>±180 000</b>	<b>10<sup>-3</sup> deg.</b>	

For description see NC MD 5010 (5D tool length compensation).



<b>21</b>	<b>Power of the spindle (from Software Version 3)</b>			<b>21</b>
Standard value	Lower input limit	Upper input limit	Units	
<b>0</b>	<b>0</b>	<b>9999</b>	<b>kW</b>	

For an exact description and meaning see technology calculator (option).  
Without a technology calculator NC MD 21 is meaningless.

<b>23</b>	<b>Number of buffer pairs for CP 231 (from Software Version 3)</b>			<b>23</b>
Standard value	Lower input limit	Upper input limit	Units	
<b>16</b>	<b>1</b>	<b>16</b>	<b>-</b>	

**Active: After POWER ON**

<b>24</b>	<b>Number of buffer pairs for CP 315-1 (from Software Version 3)</b>			<b>24</b>
Standard value	Lower input limit	Upper input limit	Units	
<b>16</b>	<b>1</b>	<b>16</b>	<b>-</b>	

**Active: After POWER ON**

For exact description see computer link.

<b>25</b>	<b>Number of buffer pairs for CP 315-2 (from Software Version 3)</b>			<b>25</b>
Standard value	Lower input limit	Upper input limit	Units	
<b>16</b>	<b>1</b>	<b>16</b>	<b>-</b>	

**Active: After POWER ON**

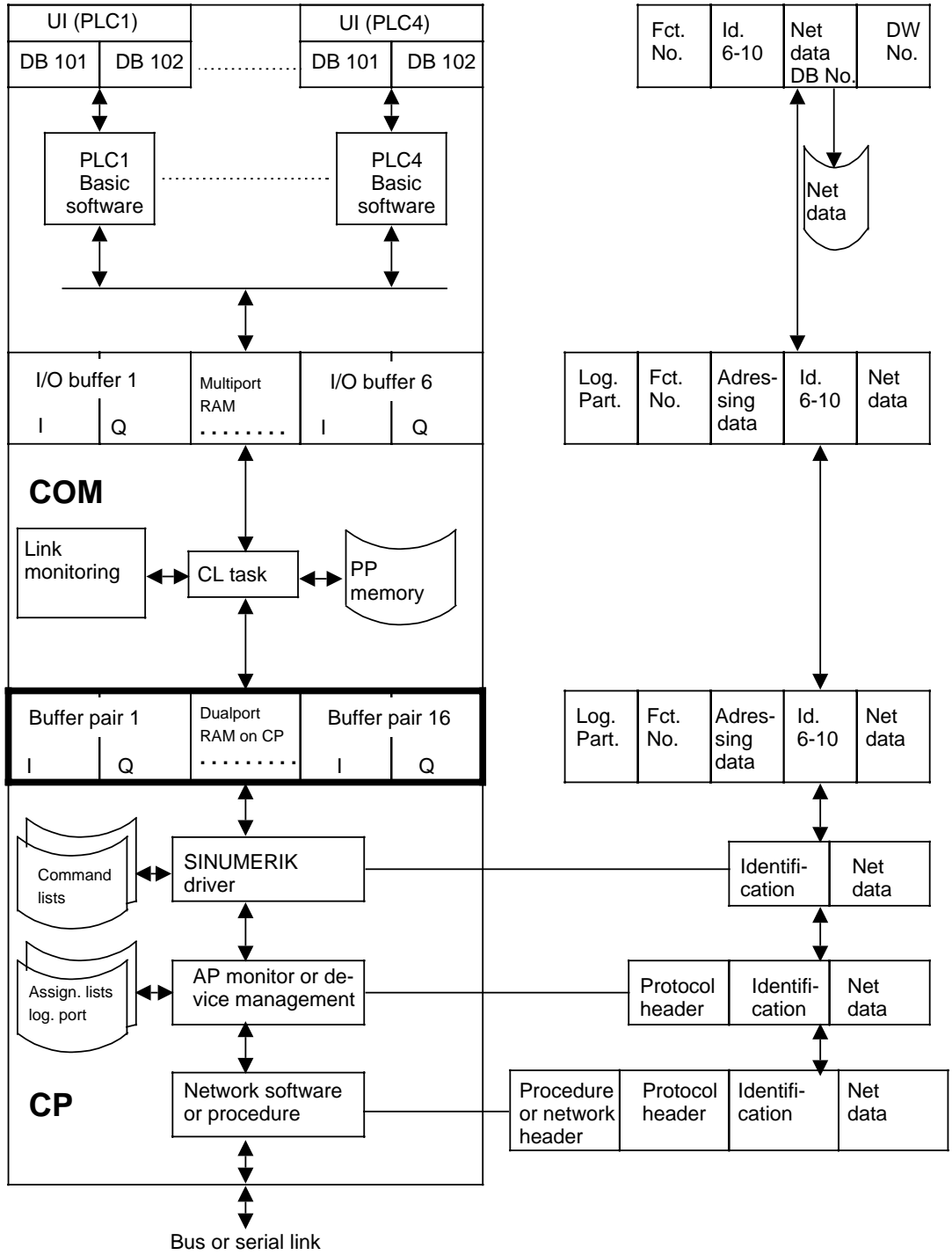

<b>26</b>	<b>UP net data length CP 231 (from Software Version 3)</b>			<b>26</b>
Standard value	Lower input limit	Upper input limit	Units	
<b>234</b>	<b>0</b>	<b>256</b>		

**Active: After POWER ON**

Specifies the maximum net data length in the message (including 10 byte identifier).

**Note:**

For reasons of compatibility with SINUMERIK 850 234 bytes are used.

<b>27</b>	<b>UP net data length CP 315-1 (from Software Version 3)</b>			<b>27</b>
Standard value	Lower input limit	Upper input limit	Units	
<b>234</b>	<b>0</b>	<b>256</b>		

**Active: After POWER ON**

Specifies the maximum net data length in the message (including 10 byte identifier).

**Note:**

For reasons of compatibility with SINUMERIK 850 234 bytes are used.

<b>28</b>	<b>UP net data length CP 315-2 (from Software Version 3)</b>			<b>28</b>
Standard value	Lower input limit	Upper input limit	Units	
<b>234</b>	<b>0</b>	<b>256</b>		

**Active: After POWER ON**

Specifies the maximum net data length in the message (including 10 byte identifier).

**Note:**

For reasons of compatibility with SINUMERIK 850 234 bytes are used.

<b>30</b>	<b>Number of sectors in execution memory (from Software Version 6.1)</b>		<b>30</b>
Standard value	Lower input limit	Upper input limit	Units
<b>10</b>	<b>2</b>	<b>2500</b>	<b>Sector</b>

**Active: After POWER ON**

During "Execution from external", the part program is read into a circular buffer while other part programs are being read out and executed. The circular buffer is part of the part program memory. The size of the circular buffer is defined in NC MD by the number of sectors (1 sector = 507 bytes).

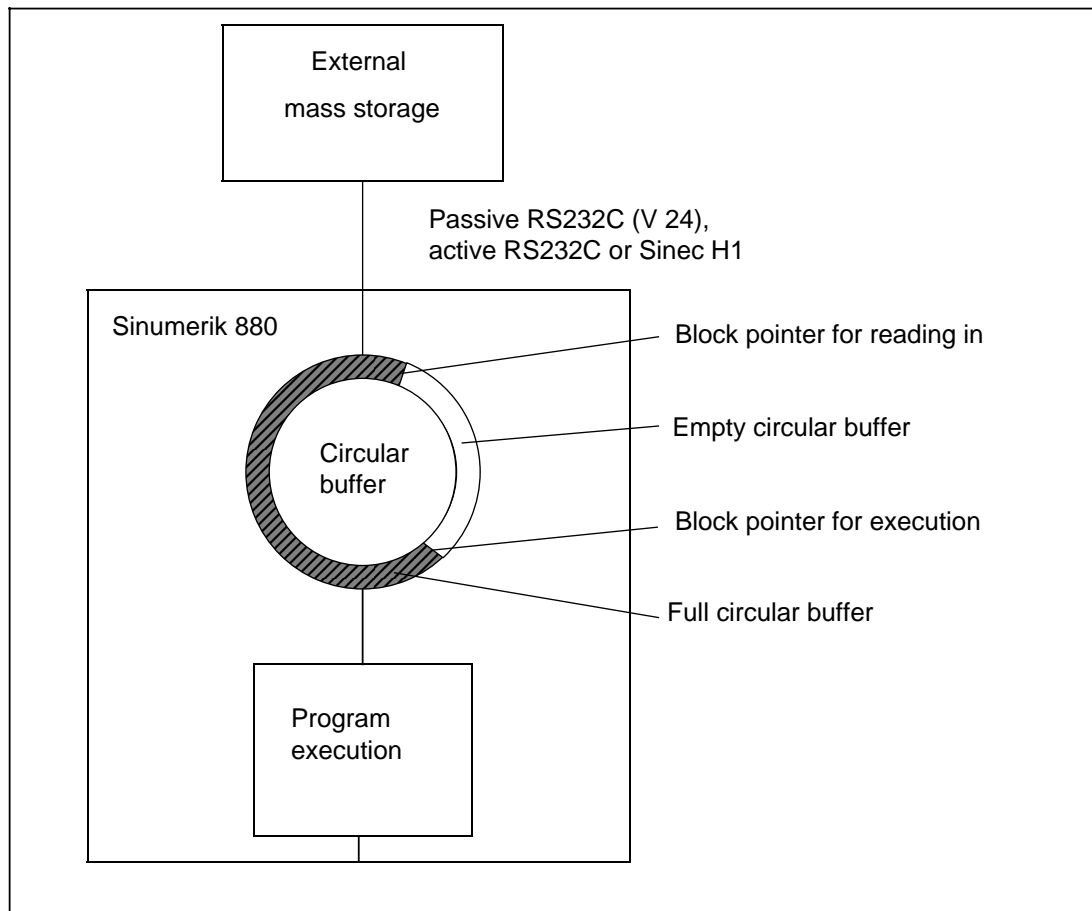

If the defined rotary buffer sectors are not available on NC START (either occupied by part programs or the part program memory is too small), the control reduces the circular buffer size to the maximum possible number of sectors.

Additional machine data (MD 130x, MD 5148-5152, optional bit)

After the function, "Execution from external" has been activated, the part program memory must be deleted.

**Interface signals**

Channel-specific signals to NC channel (program modification):

DB 10 - DB 25 DL2, bit 15 "Execution from external"

Channel-specific signals from NC channel (select softkey):

DB 10 - DB 25 DR14, bit 7 "Execution from external"

**Read/write NC data from PLC:****FB61/ FB62**

Functional description	Data type	Limit value	Value (WER 1 - WER 3)	Number format (ZFPN) FB61	Number format (ZFPN) FB62	Maximum value
Program length						
Main program length	HPLGNC	0-9999		B0, F0		
Subroutine length	UPLGNC	0-999		B0, F0		

<b>31</b>		<b>Time-out for computer link (from Software Version 5)</b>		<b>31</b>	
Standard value	Lower input limit	Upper input limit	Units		
<b>10</b>	<b>0</b>	<b>9999</b>	<b>S</b>		

**Active: After POWER ON**

Function:

If a part program is sent by the numerical control to the host computer, time-out must be switched on and the necessary response message must be received within the set time.

Behaviour:

- When transmission is triggered by the host computer: file transfer is returned to initial state.
- When transmission is triggered by the operator (PLC): file transfer is returned to initial state; Message to operator (error no. 3105).

Activating the function with machine data 31:

0 - Time-out function not activated.

- \* - Value in seconds until file transfer is aborted (exact value: set value - 4%).  
Standard value: 10  
Maximum value: 9999

<b>100-130</b>	<b>Positions 2 to 32 of feedrate override switch</b>		<b>100-130</b>
Standard value	Lower input limit	Upper input limit	Units
<b>see below</b>	<b>0</b>	<b>150</b>	<b>%</b>

**Active: Immediately**

Use can be made of a feedrate override switch with up to 32 positions. The % figures may be allocated as required, only the far left switch position (position 1) being fixed at 0%. If 0% is allocated to another switch position, the feed hold LED does not light up, unlike in position one.

Allocations of more than 150% are possible, but this value is set as the limit inside the NC.

Standard values:

1, 2, 4, 6, 8, 10, 20, 30, 40, 50, 60, 70, 75, 80, 85, 90, 95, 100, 105, 110, 115, 120,; other NC MD (NC MD 122 to 130) are set to 0.

<b>131-146</b>	<b>Positions 1 to 16 of spindle override switch</b>		<b>131-146</b>
Standard value	Lower input limit	Upper input limit	Units
<b>see below</b>	<b>50</b>	<b>130</b>	<b>%</b>

**Active: When all channels of mode group are in the STOP state**

Assignment to max. 16 spindle override switch positions as required.

The following standard values are entered when setting the standard NC MD:

50, 55, 60, 65, 70, 75, 80, 85, 90, 95, 100, 105, 110, 115, 120.

<b>147-154</b>		<b>Positions 1 to 8 of rapid traverse override switch</b>		<b>147-154</b>	
Standard value	Lower input limit	Upper input limit	Units		
<b>see below</b>	<b>0</b>	<b>100</b>	<b>%</b>		

**Active: Immediately**

Standard values:

1, 10, 50, 100, 100, 100, 100, 100.

NC MD	147	.....	1
	148	.....	10
	149	.....	50
	⋮		⋮

Rapid traverse override must be activated by means of PLC interface signals.

<b>155</b>		<b>Interpolation time</b>		<b>155</b>	
Standard value	Lower input limit	Upper input limit	Units		
<b>10</b>	<b>to Software Version 2:</b> <b>5</b>		<b>15</b>	<b>2 ms</b>	
<b>20</b>	<b>from Software Version 3:</b> <b>10</b>		<b>30</b>	<b>ms</b>	

**Active: After POWER ON**

The increased flexibility provided by the servo CPU permits users to increase and decrease sampling times (sampling time = time after which the control outputs a new set speed to the axes) compared with the standard 5 ms, as well as interpolation time (standard value 20 ms). The interpolation time is entered as an absolute value in NC MD 155.

**Example:**

NC MD 155 ... value 10 20 ms interpolation time.

The interpolation time in NC MD 155 corresponds very closely with NC MD 160 to 163 (Section 4.2.8). Only in this way the exact sampling time can be determined and checked. If an admissible value is entered in MD 155, the control automatically operates with the value 10.

**Caution!**

With standard Software Version 1 and 2, the value 10 in NC MD 155 must not be altered without consulting the Siemens AG system engineers in Nuremberg-Moorenbrunn, otherwise serious positioning errors and incorrect speed control might error.

From software version 5:

Refer also to NC MD 160-163 when using integrated drive control (IAR).

<b>155</b>	<b>Interpolation time (from Software Version 6)</b>		<b>155</b>
Standard value	Lower input limit	Upper input limit	Units
<b>20</b>	<b>12</b>	<b>30</b>	<b>ms</b>

The interpolation time is entered as an absolute value.

The following values are quoted relative to the interpolation time:

- Sampling interval for speed controller(MD 160...163)
- Sampling interval for position controller (MD 466\* for spindles, IAR MD 108\* for axes)

<b>156</b>	<b>Servo enable cutoff delay</b>		<b>156</b>
Standard value	Lower input limit	Upper input limit	Units
<b>200</b>	<b>0</b>	<b>1 000</b>	<b>ms</b>

**Active: After POWER ON**

The speed controller enable (servo enable) on the measuring circuit is removed after the set delay. The servo enable is available on the measuring circuit once per axis/spindle and is supplied by the control according to mode group-specific criteria.

The effect of this delay that has been input is as follows:

1. After the interpolator has reached the programmed position, the clamping tolerance (MD 212\*) is activated after this delay has elapsed. At this instant the following error must therefore be smaller than the clamping tolerance. The delay selected should be such that the maximum following error (rapid traverse) can be suppressed. In the event of an error, the servo enable on the measuring circuit is removed and Alarm 112\* (zero-speed control) is displayed.

This only applies when NC-MD 372\* (zero-speed control delay) is set to 0.

2. Delay for removal of the servo enable on the measuring circuit after "EMERGENCY STOP" and other errors or faults resulting in immediate shutdown of the axes (e.g. contour control).
3. Delay for removal of the servo enable on the measuring circuit if the servo enable signal for a moving axis is cancelled by the interface unit.

Any modification to MD 156 is only active after "POWER ON".

From software version 5:

This NC machine data is no longer relevant if intergrated drive control (IAR) is used. (see IAR MD 156\*)



<b>157</b>	<b>Control type for standard cycles</b>			<b>157</b>
Standard value	Lower input limit	Upper input limit	Units	
<b>see list</b>	<b>see list</b>	<b>see list</b>	-	

**Active: After memory has been formatted**

The identifiers in the following list are analyzed by the SIEMENS standard cycles to permit branching in the cycles for the specific control (e.g. recessing cycle with/without tool management, ...).

SINUMERIK	Identifier	Software version	Entry in MD 157
805 T	06		
805 M	07		
810 T	11		
810 M	12		
810 G	13		
810 W	14		
820 T	21		
820 M	22		
820 G	23		
820W	24		
840 T	41		
840 M	42		
850 T/M	50		
850 T	51		
850 M	52		
880 T/M	80	6.1	8061
880 T	81	6.1	8161
880 M	82	6.1	8261
880 G	83	5.1	8251
880 N	–	4.1	8241

It is necessary to make the entry on standard installation otherwise the Siemens standard cycles cannot run perfectly. The software version to be entered is always the software version of the NC function area (system) (see also list).

**Function area combination**

<b>Function area SINUMERIK 880</b>	Jan 88	June 88	Feb 89	March 89	May 89	June 89	Jan 90	Feb 90	Aug 90	Sept 90	April 91
<b>Collective designation of the software version</b>	<b>01</b>	<b>02</b>	<b>02/ 59</b>	<b>02/ 75</b>	<b>3.1</b>	<b>3.2</b>	<b>3.3</b>	<b>4.1</b>	<b>4.2</b>	<b>4.3</b>	<b>4.4</b>
Operating area system submodule 1	01	01	01	01	31	32	33	41	42	42	44
Operating area system submodule 2	–	–	–	–	31	32	33	41	42	42	44
Operating area bootstrap, restart	01	02	02	02	31	31	31	31	31	31	31
COM area system submodule 1	01	01	59	59	31	32	33	41	42	42,43	44
COM area system submodule 2	01	01	01	01	31	32	33	41	42	42	44
COM area bootstrap, restart	01	02	02	02	31	31	31	31	31	31	31
ASM area standard T and M	03	03/ 60	03/ 60	03/ 60	41	41	41	41	41	41	41
NC area system submodule 1	01	01	59	60	31	32	33	41	42	42,43	44
NC area system submodule 2	–	–	–	–	31	32	33	41	42	42	44
NC area bootstrap, restart	01	02	02	02	31	31	31	31	31	31	31
Servo area 16 bit	01	02	02	75	31	32	33	41	42	42	44
Servo area 32 bit	–	–	–	–	–	–	–	–	–	–	–
PLC area 135 W system	01	02	02	02	31	31	32	–	–	–	–
PLC area 135 W bootstrap, restart	54	54	54	54	31	31	31	–	–	–	–
PLC area 135 WB with COP	–	–	–	–	–	–	–	41	42	42	44
PLC area 135 WB with ACOP	–	–	–	–	–	–	–	–	–	–	–
PLC 135 W/WB											

Table continued on next page

<b>Function area SINUMERIK 880</b>	Jan 88	June 88	Feb 89	March 89	May 89	June 89	Jan 90	Feb 90	Aug 90	Sept 90	April 91
<b>Collective designation of the software version</b>	<b>01</b>	<b>02</b>	<b>02/ 59</b>	<b>02/ 75</b>	<b>3.1</b>	<b>3.2</b>	<b>3.3</b>	<b>4.1</b>	<b>4.2</b>	<b>4.3</b>	<b>4.4</b>
PLC package 0 (Basic functions)	51	53	53	53	54	54	55	55	55	55	55
PLC package 1 (Tool management - active magazine)	-	-	-	-	P	P	P	P57	01	02	02
PLC package 2 (Tool management - background magazine)	-	-	-	-	P	P	P	P57	P57	02	02
PLC package 4 (Computer link)	-	-	-	-	P	P	P	P58	56	01	01
PLC package 5 (Computer link/ transfer tool data)	-	-	-	-	P	P	P	P74	77	01	01
PLC package 6 (Code carrier/ transfer tool data)	-	-	-	-	P	P	P	P73	74	01	01
PLC package 7 (Code carrier/ address coding)	-	-	-	-	-	-	-	-	-	P70	P70
PLC package 8 (PLC controlled data input/output)	-	-	-	-	-	-	-	-	-	P50	P50

<b>Function area</b> SINUMERIK 880	Jan 88	June 88	Feb 89	March 89	May 89	June 89	Jan 90	Feb 90	Aug 90	Sept 90	April 91
<b>Collective designation of the software version</b>	<b>01</b>	<b>02</b>	<b>02/59</b>	<b>02/75</b>	<b>3.1</b>	<b>3.2</b>	<b>3.3</b>	<b>4.1</b>	<b>4.2</b>	<b>4.3</b>	<b>4.4</b>
PLC S5-155U											
PLC basic program	-	-	-	-	-	-	-	-	-	P50	P50
PLC package 0 (Basic functions)	-	-	-	-	-	-	-	-	-	P50	P50
PLC package 1 (Tool management - active magazine)	-	-	-	-	-	-	-	-	-	-	
PLC package 2 (Tool management - background magazine)	-	-	-	-	-	-	-	-	-	-	
PLC package 4 (Computer link)	-	-	-	-	-	-	-	-	-	P50	P50
PLC package 5 (Computer link/ transfer tool data)	-	-	-	-	-	-	-	-	-	-	
PLC package 6 (Code carrier/ transfer tool data)	-	-	-	-	-	-	-	-	-	-	
PLC package 7 (Code carrier/ address coding)	-	-	-	-	-	-	-	-	-		
PLC package 8 (PLC controlled data input/output)	-	-	-	-	-	-	-	-	-		

Table continued on next page

<b>Function area</b> SINUMERIK 880	Jan 88	June 88	Feb 89	March 89	May 89	June 89	Jan 90	Feb 90	Aug 90	Sept 90	April 91
<b>Collective designation of the software version</b>	<b>01</b>	<b>02</b>	<b>02/ 59</b>	<b>02/ 75</b>	<b>3.1</b>	<b>3.2</b>	<b>3.3</b>	<b>4.1</b>	<b>4.2</b>	<b>4.3</b>	<b>4.4</b>
KYRU	-	-	-	-							
CP231 SINEC H1	-	-	-	-	31	31	31	13	13	13	
CP 315 - Active RS 232 C (V.24) (incl. CP373)	-	-	-	-	31	31	31	12	12	12	
SIN PS231/NML (CL configur- ing software) CP/M	-	-	-	-	1.5	1.5	1.5	1.5	1.5	1.5	
SIN PS315 (CL configuring software) CP/M	-	-	-	-	1.1	1.2	1.2	5.1	7.0	7.0	
SINT (Test software for CP231/CP315) CP/M	-	-	-	-	1.1	1.1	1.1	2.4	3.0	3.0	
SIN PS315 (CL configuring software) MS DOS	-	-	-	-	-	-	-	-	-	-	
SINT (Test software for CP231/CP315) MS DOS	-	-	-	-	-	-	-	-	-	-	
Measuring cycles (Option B78) SV 02/75 (with R para- meters) SV 4 (with MD cycles)	V05 - -	V05 - -	V05 - -	10 - -	10 - -	10 - -	10 - -	10 20	10 20	10 21	10 21
Measuring cycles (Option B80 - Supplement to B78) SV 02/75 (with R para- meters) SV 4 (with MD cycles)	- -	- -	- -	05 -	05 -	05 -	05 -	05 20	05 20	05 21	05 21
WS800 (NC workstation)	1.5	1.5	1.5	1.5	2.1	2.1	2.1	2.1	2.1	2.1	
WS800 A (NC workstation)								1.0	1.0	1.0	
PG software (S5 DOS step)	03	03	03	03	03	03	03	04 04+	04 04+	04 04+	

<b>158</b>	<b>Measuring speed (from Software Version 4)</b>		<b>158</b>
Standard value	Lower input limit	Upper input limit	Units
<b>250</b>	<b>0</b>	<b>12 000</b>	<b>1000 units</b> <b>min (IS)</b>

**Active: After POWER ON**

When measuring in JOG mode (option 74) pressing the softkey "MEASURE" starts the axis. The measuring speed is entered in NC MD 158 and is valid for a feedrate override of 100%.

The measuring speed applies until the probe is disengaged.

<b>159</b>	<b>Retraction path (from Software Version 4)</b>		<b>159</b>
Standard value	Lower input limit	Upper input limit	Units
<b>10 000</b>	<b>0</b>	<b>±99 999 999</b>	<b>units (IS)</b>

**Active: After POWER ON**

When measuring in JOG mode (option B74), after the probe has been disengaged it is retracted a short distance. The direction of retraction is automatically checked by the control because an incorrect direction of retraction could cause destruction of the probe. The control also checks whether manual retraction with at least the incremental path of NC MD 159 was performed. Before this no further axis movements are possible. Retraction is not possible with rapid traverse.

**Example:** Tool gauging

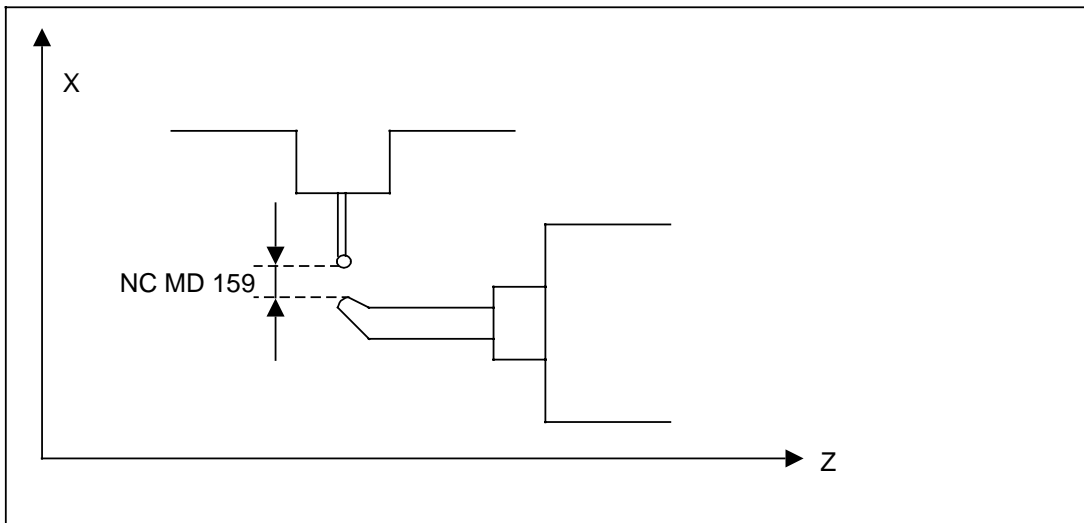

<b>160-163</b>		<b>Sampling interval ratio interpolation to speed control (from Software Version 5)</b>		<b>160-163</b>	
Standard value	Lower input limit	Upper input limit	Units		
<b>see Notes</b>	<b>0</b>	<b>80</b>	<b>-</b>		

**Active: After POWER ON**

The same machine often incorporates axes and spindles of different dynamic response, which means that different control settings with different values of sampling interval are needed. With MD 160...163 it is possible to set the ratio between the interpolation clock pulse and the speed controller clock pulse specifically for each 32-bit servo CPU.

Therefore:

- MD 160 for the first servo CPU
- MD 161 for the second servo CPU
- MD 162 for the third servo CPU
- MD 163 for the fourth servo CPU

The interpolation time is established in MD 155. Together with MD 160...163 this gives the sampling intervals of the speed controllers of the individual servo CPUs.

**Notes**

- The **only** values of sampling interval permitted for the speed controllers are **1 ms and 0.5 ms**. The values for MD 160...163 must be chosen so that the sampling intervals are within the permitted limits.
- If the entries produce off-limit values, the "Parameter error" alarm will be triggered.
- Mixed operation with 16-bit and 32-bit servo CPUs continues to be possible with SINUMERIK 880. Therefore, the standard value of MD 160...163 is still 4. The standard value for the interpolation time is still 20. However, this combination is not permitted for the 32-bit servo CPU so sensible alternative values must be entered.

**Example**

MD 160... ...163				
MD 155	12	20	24	40
12	1 ms	–	0.5 ms	–
20	–	1 ms	–	0.5 ms

*Examples of permitted combinations and the resulting sampling intervals*

The following table shows the correlation between NC MD 160 to 163 and NC MD 155 (interpolation time) (valid for software version 6.3 only).

Interpolation time MD155  [ms]	Ratio of interpolation to position control MD 160 to 163					
	1:2		1:4		1:8	
	Position control sampling time [ms]	Max. number of axes/spindles per servo CPU	Position control sampling time [ms]	Max. number of axes/spindles per servo CPU	Position control sampling time [ms]	Max. number of axes/spindles per servo CPU
8	4	4	2	2	1	1
10	5	6	2.5	3	disabled	
12	6	7	3	4	1.5	2
14	7	8	3.5	5	disabled	
16	8	10	4	6	2	3
18	9	11	4.5	6	disabled	
20	10	12	5	7	2.5	4
22	11	13	5.5	8	disabled	
24	12	15	6	9	3	5
26	13	16	6.5	10	disabled	
28	14	17	7	10	3.5	5
30	15	18	7.5	11	disabled	
Computing time per axis approx.	0.8ms		0.65ms		0.6ms	

The values given in the table are a guide!

Differences caused by other configurations (e.g. active leadscrew error compensation, electronic gearbox, M19 over several revolutions, ...) are possible.

If dynamic feedforward control and tacho compensation are also activated, the computing time required is increased by approx. 0.1 ms per axis.

The computing time required by the SERVO CPU for an electronic gearbox following axis is approx. 2.3 ms (2.4 ms) for 3 leading axes with (without) dynamic feedforward control and tacho compensation.



<b>160-163</b>	<b>Ratio of interpolation to position control (up to Software Version 4)</b>		<b>160-163</b>
Standard value	Lower input limit	Upper input limit	Units
<b>4</b>	<b>0</b>	<b>8</b>	<b>—</b>

**Active: After POWER ON**

Since a single machine often has axes with high and low dynamic performance, the ratio between interpolation and position control (sampling time) can be varied specifically according to the servo CPU on the SINUMERIK 880.

NC MD 160	Ratio of interpolation to position control for	1st servo CPU
NC MD 161	- " -	2nd servo CPU
NC MD 162	- " -	3rd servo CPU
NC MD 163	- " -	4th servo CPU

Ratios of 1:2, 1:4 or 1:8 (inputs 2, 4 or 8) are permitted (1:4 means that the position control operates 4 times more often than the interpolation).

If other values are entered, the control automatically assumes a division ratio of 1:4.

On axes with high dynamic response, a division ratio of 1:8 (fine interpolation) can be used to reduce the surface roughness during machining.

**Caution:**

These machine data have a different meaning if integrated drive control (IAR) is used.

<b>160-163</b>	<b>Scan ratio of interpolation to rpm servo control</b>		<b>160-163</b>
Standard value	Lower input limit	Upper input limit	Units
<b>4</b>	<b>0</b>	<b>16000</b>	<b>—</b>

<b>168</b>	<b>Sampling interval, system clock</b>			<b>168</b>
Standard value	Lower input limit	Upper input limit	Units	
<b>0</b>	<b>0</b>	<b>4</b>	<b>see Table</b>	

In order to allow mixed operation with 16-bit and 32-bit servo CPUs it must be possible to vary the setting of the system clock. The actual values are taken from the measuring circuit at the system clocking rate.

MD 168	Clock pulse
0	Automatic selection
1	1 ms
2	0.5 ms
4	0.25 ms

*Sampling interval, system clock*

The value 4 (0.25 ms) must be entered when using drive control systems on the 32-bit servo CPU. If invalid values or zero are entered, the system clock will be selected automatically and the following values set:

- 0.5 ms, if only 16-bit servo CPUs are plugged
- 0.25 ms, if at least one 32-bit servo CPU is plugged.

<b>172</b>	<b>Number of simulation tool parameters</b>			<b>172</b>
Standard value	Lower input limit	Upper input limit	Units	
<b>8</b>	<b>0</b>	<b>8</b>	<b>-</b>	

With this MD, the number of dimensioning parameters for a simulation tool data record can be freely selected.

The more parameters are selected, the smaller the number of possible simulation tool data records (constant memory area).

<b>173</b>		<b>Number of simulation channels (from Software Version 3)</b>		<b>173</b>	
Standard value	Lower input limit	Upper input limit	Units		
<b>1</b>	<b>1</b>	<b>2</b>	<b>-</b>		

**Active: After user memory has been formatted**

Specifies how many simulation channels are available on the control.

- SINUMERIK 880M: Input value 1  
 SINUMERIK 880T:
  - Single slide simulation: Input value 1
  - Double slide simulation: Input value 2  
(NC MD 5009 bit 7 = 1)

**Note:**

A modification only becomes active after softkey "FORMAT USER M."

<b>174-176</b>		<b>Simulation mode of representation for plane 1 to 3 (from Software Version 3)</b>		<b>174-176</b>	
Standard value	Lower input limit	Upper input limit	Units		
<b>0</b>	<b>0</b>	<b>7</b>	<b>-</b>		

**Active: After simulation start**

- NC MD 174 Simulation mode of representation for plane 1      2nd - 3rd axis  
 NC MD 175 Simulation mode of representation for plane 2      1st - 3rd axis  
 NC MD 176 Simulation mode of representation for plane 3      1st - 2nd axis

With this machine data you can define from which direction the three-dimensional simulation process is to be seen. In this way it is possible to adapt simulation to the machine. For every simulation plane the mode of representation must be defined as shown in the following table.

For the graphic tool check the mode of representation is taken from "mode of representation for plane 1" for the M version and from "mode of representation for plane 2" for the T version. Tools whose position is only determined in the program (cutter, drill, measuring tools) are displayed without paying attention to the mode of representation.

**Mode of representation (MR) for entry in NC MD 174 to 176**

**Plane 1 (M)      2nd - 3rd axis**

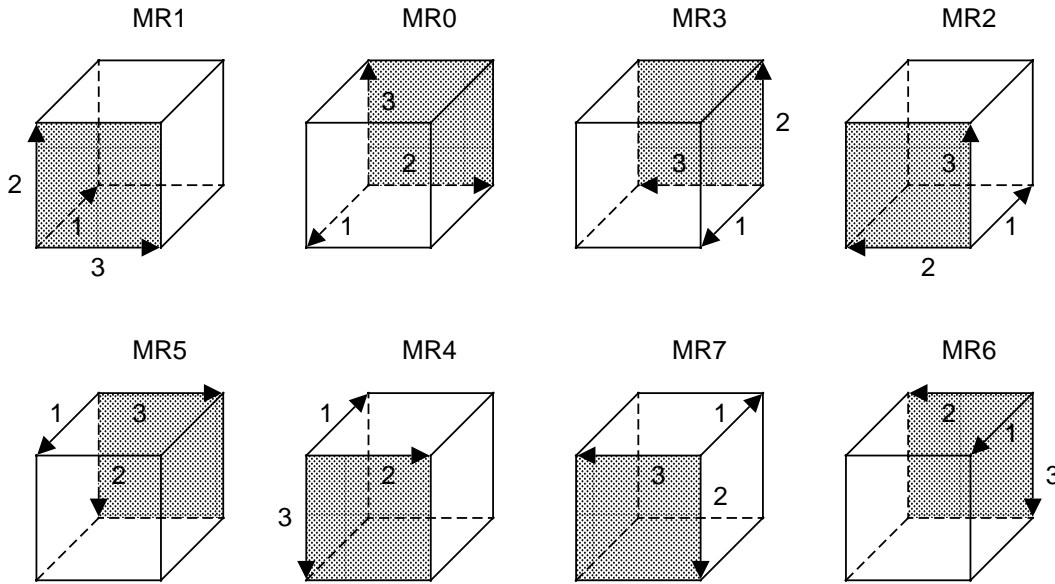

**Plane 2 (M)      1st - 3rd axis**

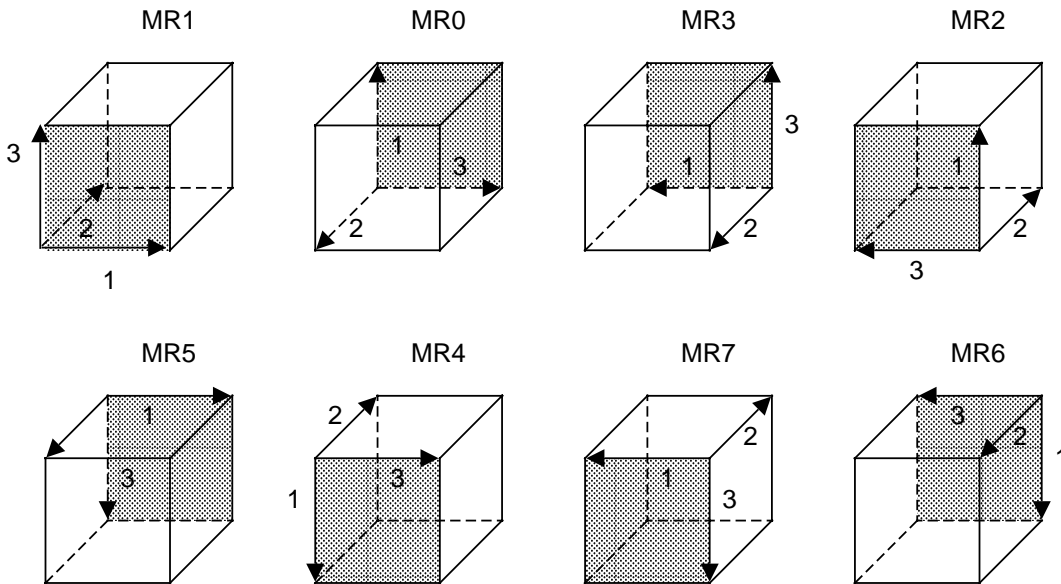

**Plane 3 (M) 1st - 2nd axis**

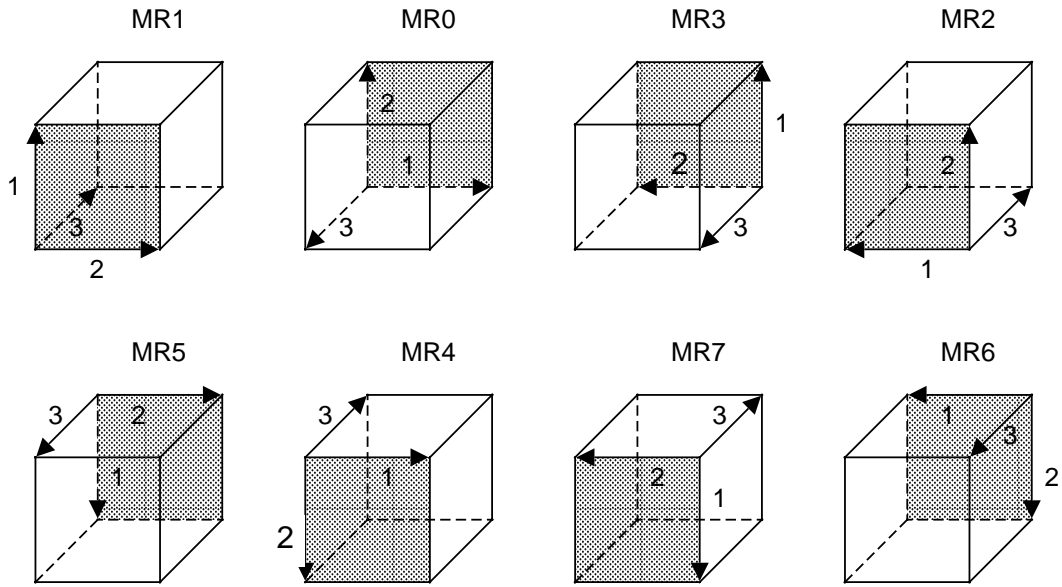

**Plane 2 (T) 1st - 3rd axis**

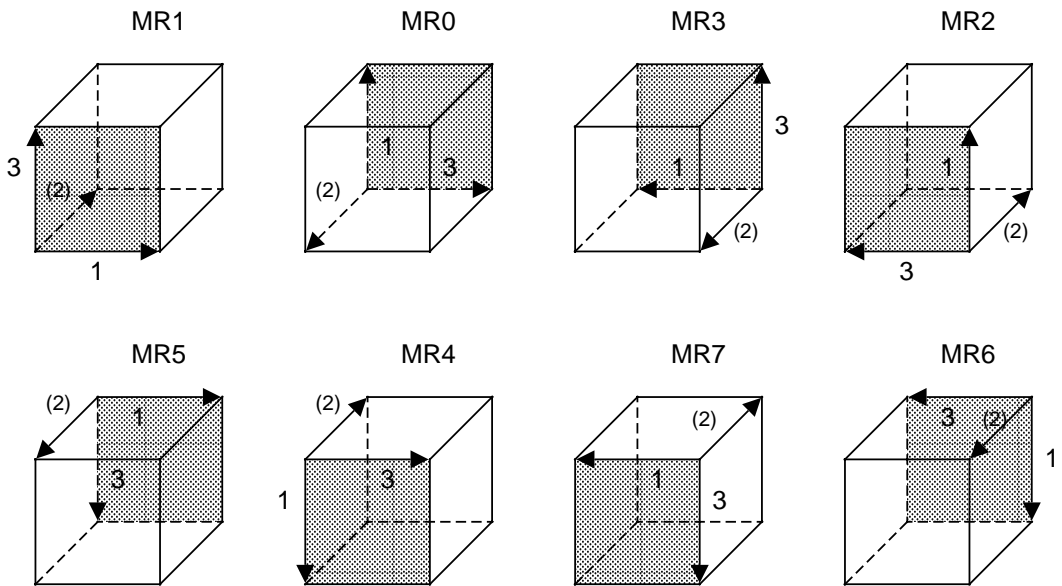

### Plane 2 (TT)

Overall MR 2 or 6

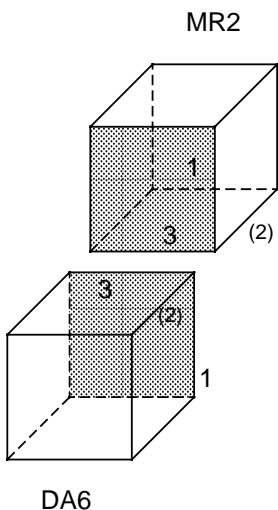

Overall MR 5 or 7

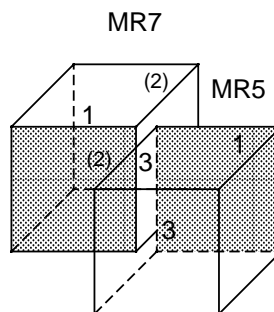

Overall MR 0 or 4

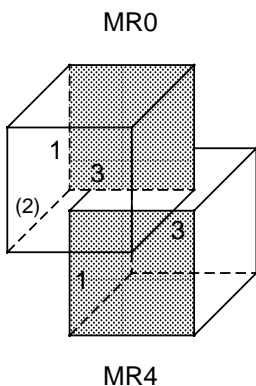

Overall MR 1 or 3

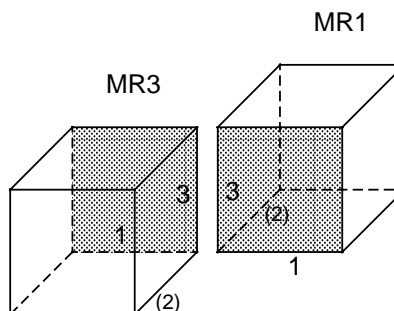

If two slides are represented at once the modes of representation of both channels must match (see option shown above).

The mode of representation of slide 1 determines the overall mode of representation for this combination. As slides 1 and 2 can be exchanged each of the diagrams shown above shows two modes of representation.

<b>180-199</b>	<b>Coding simulation functions (from Software Version 3)</b>		<b>180-199</b>
Standard value	Lower input limit	Upper input limit	Units
<b>see below</b>	<b>see below</b>	<b>see below</b>	

**Active: In next block**

In order to be able to perform machine-related responses in real time for graphic simulation, individual simulation functions must be adapted to the auxiliary functions defined by the manufacturer with NC MD 180 to 199.

(For an exact description see Section 11.).

One or two auxiliary functions can be selected per response. Each of these auxiliary functions is described by a data block consisting of two NC MD.

The following auxiliary functions can be defined:

NC MD 180 / 181	Tool change simulation channel 1	
NC MD 182 / 183	Tool change simulation channel 2	
NC MD 184 / 185	Tool offset selection	
NC MD 186 / 187	Spindle turning (1st auxiliary function)	right
NC MD 188 / 189	Spindle turning (2nd auxiliary function)	left
NC MD 190 / 191	Spindle stopped (1st auxiliary function)	stop
NC MD 192 / 193	Spindle stopped (2nd auxiliary function)	in position
NC MD 194 / 195	Erase unmachined part	
NC MD 196 / 197	Draw unmachined part	
NC MD 198 / 199	Synchronization mark for double slide operation.	

Standard machine data:

NC MD	Input Value	Function	Aux. funct.
180/181	63/0	Tool change Simulation channel 1	T...
182/183	63/0	Tool change Simulation channel 2	T...
184/185	64/0	Tool offset selection	D...
186/187	21/3	Spindle turning    right	M03
188/189	21/4	Spindle turning    left	M04
190/191	21/5	Spindle stopped    stop	M05
192/193	21/19	Spindle stopped    in position	M19
194/195	21/100	Erase unmachined part	M100
196/197	21/101	Draw unmachined part	M101
198/199	21/46	Synchronization mark for doubleslide operation	M46

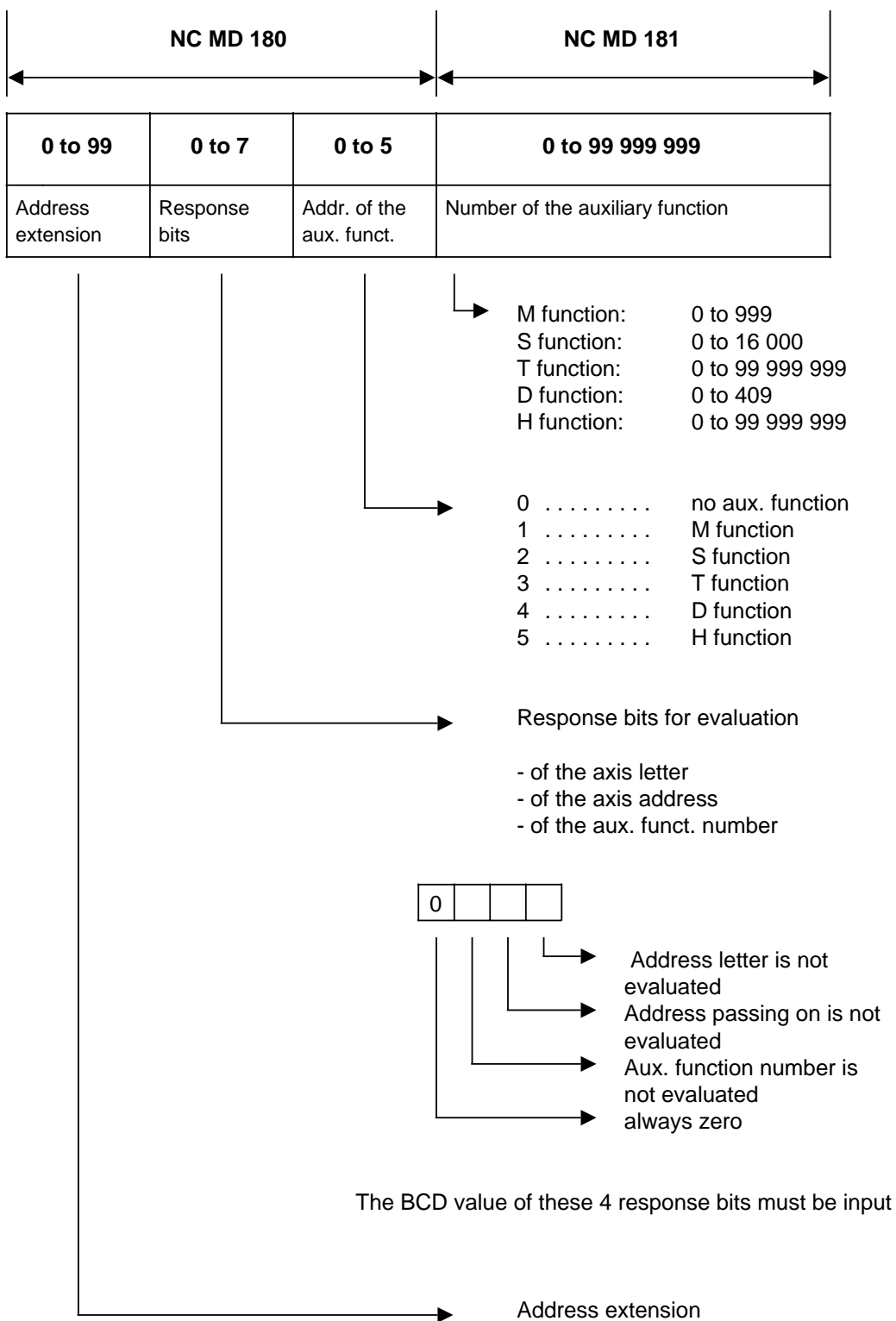



<b>200</b>	<b>PLC serial interface</b>			<b>200</b>
Standard value	Lower input limit	Upper input limit	Units	
<b>3</b>	<b>1</b>	<b>4</b>	<b>-</b>	

**Active: After POWER ON**

In DB 37 the PLC is able to input and output any data via the serial interface entered in MD 200 (20 mA or RS 232) (see Interface Description Part 1). The interface on the COM CPU is preset with the standard value 3.

MD 200 can be overwritten with FB 61/62, provided the interface is not busy.

<b>208</b>	<b>Max. tool wear [parameter P5/P6] (from Software Version 4)</b>			<b>208</b>
Standard value	Lower input limit	Upper input limit	Units	
<b>999 999</b>	<b>1</b>	<b>999 999 99</b>	<b>*)</b>	

**Active: After POWER ON**

When inputting the tool wear into length 1 (tool parameter P5) and length 2 (tool parameter P6) via the keyboard on the NC operator panel, a check is made to see whether the max. permissible value was exceeded (NC MD 208).

This prevents the tool offset (the wear!) from being unintentionally modified by a large value.

**Note:**

The tool wear can be declared invalid with NC MD 5007 bit 6.

<b>209</b>	<b>Max. tool wear [parameter P7] (from Software Version 4)</b>			<b>209</b>
Standard value	Lower input limit	Upper input limit	Units	
<b>999 999</b>	<b>1</b>	<b>999 999 99</b>	<b>*)</b>	

**Active: After POWER ON**

Meaning as for NC MD 208 but for tool wear of the tool nose/cutter radius (tool parameter P7).

\*) 1 position before the decimal point and 5 positions after the decimal point in mm/inches according to the reset position for IS.

<b>210</b>	<b>Number of TO areas</b>			<b>210</b>
Standard value	Lower input limit	Upper input limit	Units	
<b>1</b>	<b>1</b>	<b>16</b>	<b>-</b>	

**Active: After user memory has been formatted**

**Notes:**

For pallet changers or double-slide machines, the TO memory may be subdivided into max. 16 TO areas. The advantage of such a breakdown is that the individual TO areas can be invoked with D numbers D0 to Dx, i.e. programs may be exchanged between the slides in the case of a double-slide machine since both tool turrets can be addressed with D numbers D0 to D8.

With regard to protective measures, it may also be advisable to prevent individual channels from accessing specific tool offsets.

The number of areas is specified by means of NC MD 210. The input limits are at 1 to 16 TO areas. If 0 is entered, a TO area is made available. A value exceeding 16 is limited internally to 16. At the same time, Alarm 47 is activated.

Under NC MD 211 to 226 the limits for the individual TO areas are defined with the initial TO numbers. The last TO area ranges from the last value specified under NC machine data 211 to 226 to the maximum tool offset number (observe NC MD 13).

**Caution!**

A change to NC MD 210 is not valid until the "FORMAT USER M." softkey has been pressed.

NC MD No.	Significance	Standard value
<b>211</b>	Initial TO number for TO area 1	1
<b>212</b>	Initial TO number for TO area 2	0
<b>213</b>	Initial TO number for TO area 3	0
<b>214</b>	Initial TO number for TO area 4	0
<b>215</b>	Initial TO number for TO area 5	0
<b>216</b>	Initial TO number for TO area 6	0
<b>217</b>	Initial TO number for TO area 7	0
<b>218</b>	Initial TO number for TO area 8	0
⋮	⋮	⋮
<b>226</b>	Initial TO number for TO area 16	0

The initial D numbers of TO areas 1 to 16 should be entered in ascending order. If not, only one TO area is set internally and Alarm 47 is activated.

**Example:**

NC MD	13	10	Number of TO parameters	
NC MD	210	4	Number of TO areas	
NC MD	211	1	Initial D number for TO area	1
NC MD	212	30	Initial D number for TO area	2
NC MD	213	55	Initial D number for TO area	3
NC MD	214	150	Initial D number for TO area	4
NC MD	215	0	Initial D number for TO area	5
	.		.	
	.		.	
NC MD	226	0	Initial D number for TO area	16

TO areas are assigned to the channels in NC MD 104\*.

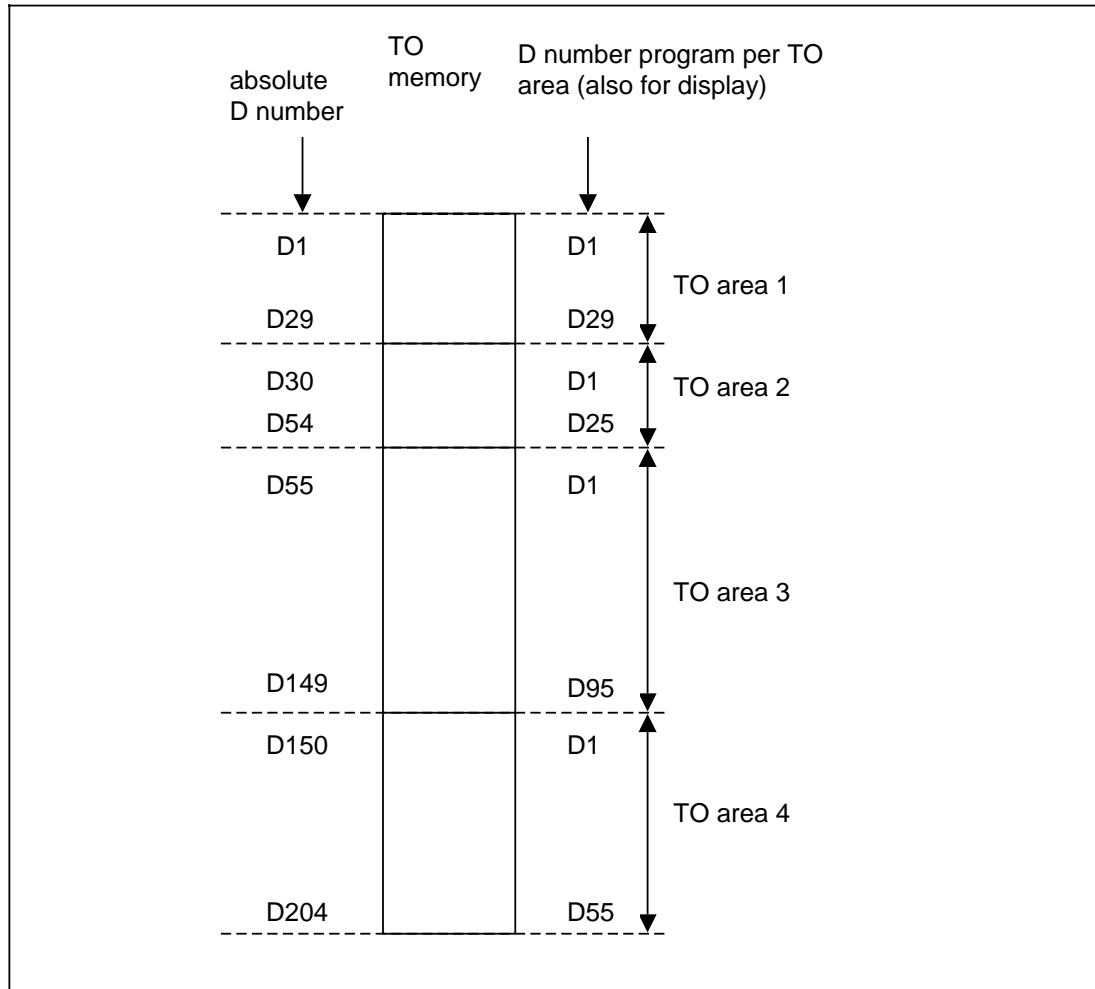

Example for the organisation of TO areas

**Caution!**

A change to NC MD 211 to 226 is not valid until the "FORMAT USER M." softkey has been pressed.

<b>227</b>	<b>User menu for PRESET (from Software Version 3)</b>			<b>227</b>
Standard value	Lower input limit	Upper input limit	Units	
<b>0</b>	<b>0</b>	<b>255</b>	<b>-</b>	

**Active: When this mode is next selected**

If on selecting PRESET mode the standard system basic menu for this mode is **not** to appear on the screen any user menu can be defined as the new basic menu for this mode by specifying the user menu number.

If the value 0 is entered the standard system basic menu appears when this mode is selected.

**Note:**

A modification of the NC MD only becomes valid the next time this mode is selected.

<b>228</b>	<b>User menu for MDI automatic (from Software Version 3)</b>			<b>228</b>
Standard value	Lower input limit	Upper input limit	Units	
<b>0</b>	<b>0</b>	<b>255</b>	<b>-</b>	

**Active: When this mode is next selected**

Meaning as for NC MD 227, but for MDI AUTOMATIC mode.

<b>229</b>	<b>User menu for JOG/INC (from Software Version 3)</b>			<b>229</b>
Standard value	Lower input limit	Upper input limit	Units	
<b>0</b>	<b>0</b>	<b>255</b>	<b>-</b>	

**Active: When this mode is next selected**

Meaning as for NC MD 227, but for JOG or INC.

<b>230</b>	<b>TO area for simulation channel 1 (up to Software Version 2)</b>			<b>230</b>
Standard value	Lower input limit	Upper input limit	Units	
<b>0</b>	<b>0</b>	<b>255</b>	<b>-</b>	

**Active: When this mode is next selected**

NC MD 230 specifies the TO area number for the simulation channel. A TO area already defined for an NC channel must be assigned to the simulation channel, otherwise the simulation tool offsets cannot be input via the operator panel.

<b>230</b>	<b>User menu for REPOS (from Software Version 3)</b>			<b>230</b>
Standard value	Lower input limit	Upper input limit	Units	
<b>0</b>	<b>0</b>	<b>255</b>	<b>-</b>	

**Active: When this mode is next selected**

Meaning as for NC MD 227, but for REPOS.

<b>231</b>	<b>User menu for AUTOMATIC (from Software Version 3)</b>			<b>231</b>
Standard value	Lower input limit	Upper input limit	Units	
<b>0</b>	<b>0</b>	<b>255</b>	<b>-</b>	

**Active: When this mode is next selected**

Meaning as for NC MD 227, but for AUTOMATIC.

<b>232</b>	<b>User menu for REFPOINT (from Software Version 3)</b>			<b>232</b>
Standard value	Lower input limit	Upper input limit	Units	
<b>0</b>	<b>0</b>	<b>255</b>	<b>-</b>	

**Active: When this mode is next selected**

Meaning as for NC MD 227, but for REFPOINT

<b>233</b>	<b>No. of the PLC In the DB 38 (from Software Version 3)</b>			<b>233</b>
Standard value	Lower input limit	Upper input limit	Units	
<b>0</b>	<b>0</b>	<b>2</b>		

**Active: When next display is selected**

With the function "file transfer operator prompt" you define via the MD to which PLC the data will be transferred.

<b>240</b>	<b>Tangential axis (only SINUMERIK 880N)</b>		<b>240</b>
Standard value	Lower input limit	Upper input limit	Units
<b>0</b>	<b>0</b>	<b>24</b>	<b>-</b>

This machine data specifies the name of the tangential axis. The name corresponds to the decimal value from MD 568\*.

**Example:**

Name of the axis: C  
 MD 568\* = 00000101 MD 240 = 5

<b>242</b>	<b>Tool revolver axis (only SINUMERIK 880N)</b>		<b>242</b>
Standard value	Lower input limit	Upper input limit	Units
<b>0</b>	<b>0</b>	<b>24</b>	<b>-</b>

This machine data specifies the name of the tool revolver axis. The name corresponds to the decimal value from MD 568\*.

<b>243</b>	<b>M function for laser machining</b>		<b>243</b>
Standard value	Lower input limit	Upper input limit	Units
<b>0</b>	<b>1</b>	<b>99</b>	

This M function is output from the PLC as an M function **and** as a fast M function Q 0.4 in the SERVO.

It is used:

- a) In laser plasma machining to switch of the function avoid clamps and to switch on the laser with the fast M function Q 0.4 in the SERVO. The clamps are then taken to be a working area limitation. Every M function from the Mx20 group deletes the function avoid clamps and the fast M function Q 0.4 and is therefore a laser switch-off function. The input value must not correspond to M functions with a fixed assignment.
- b) If the "Analog tangential angle output" is active, the analog value output is also switch on.



<b>244</b>	<b>Parallel axis for tangential axis</b>			<b>244</b>
Standard value	Lower input limit	Upper input limit	Units	
<b>0</b>	<b>0</b>	<b>24</b>	<b>-</b>	

This machine data specifies the name of the parallel axis to the tangential axis. The name corresponds to the decimal value from MD 568\*.

**Example:**

Name of axis: C1 MD568\* = 0001 0101 MD244=21

<b>245</b>	<b>Reduced F val. in the clamp protect. area</b>			<b>245</b>
Standard value	Lower input limit	Upper input limit	Units	
<b>0</b>	<b>0</b>	<b>99 999 999</b>	<b>1000 units</b> <b>min (IS)</b>	

Another feedrate than the programmed feedrate can be specified for clamp protection in an area defined via R parameters in Y. This, for example, makes a lower feedrate in the clamp protection area possible. The programmed speed is not exceeded in the clamp protection area.

<b>246</b>	<b>Tool change position in Y</b>			<b>246</b>
Standard value	Lower input limit	Upper input limit	Units	
<b>0</b>	<b>0</b>	<b>99 999 999</b>	<b>units</b>	

This machine data specifies the tool change position in Y. This position is approached automatically when tool change is implemented.

<b>247</b>	<b>M function for T code modification</b>			<b>247</b>
Standard value	Lower input limit	Upper input limit	Units	
<b>0</b>	<b>0</b>	<b>9 999</b>	<b>-</b>	

M function to trigger tool change.

<b>251</b>	<b>Channel for auxiliary function of the 1st simulation channel to PLC (from Software Version 4)</b>			<b>251</b>
Standard value	Lower input limit	Upper input limit	Units	
<b>15</b>	<b>1</b>	<b>16</b>	<b>-</b>	

**Active: After POWER ON**

<b>252</b>	<b>Channel for auxiliary function of the 2nd simulation channel to PLC (from Software Version 4)</b>			<b>252</b>
Standard value	Lower input limit	Upper input limit	Units	
<b>16</b>	<b>1</b>	<b>16</b>	<b>-</b>	

**Active: After POWER ON**

From Software Version 4 auxiliary functions of the simulation channel can be output to the PLC during graphic simulation (e.g. T function for flexible tool management).

As the NC PLC interface is structured channel-specifically (16 NC channels), but no channels are provided for graphic simulation, the user can select via machine data which simulation channel he will assign to which NC channel:

**Note:**

Output channels assigned to NC processing (NC PLC interface must not be used to output simulation functions).

The form in which the auxiliary functions are to be read out is determined in machine data 540\*, 544\* and 546\*. The procedure here is the same as that of the NC.

The simulation program can be halted in the PLC user program with auxiliary function blocks with read-in disable, for example, to be able to declare new tools from the PLC with a programmed D No.

<b>260</b>	<b>No. of M function for selecting C axis mode</b>			<b>260</b>
Standard value	Lower input limit	Upper input limit	Units	
<b>-1</b>	<b>-1</b>	<b>9 999</b>	<b>-</b>	

<b>261</b>	<b>No. of M function for deselecting C axis mode</b>			<b>261</b>
Standard value	Lower input limit	Upper input limit	Units	
<b>-1</b>	<b>-1</b>	<b>9 999</b>	<b>-</b>	

**Active: When all channels of mode group are in the STOP state**

The C axis mode is selected and deselected by means of M functions. The numbers of the functions can be issued for specific customers.

When issuing the numbers, ensure that they do not conflict with other M functions. Generally speaking, the following values should not be used:

0, 1, 2, 3, 4, 5, 17, 19, 30, 36, 37

Used the address extension as for spindles when programming.

**Example**

MD 260=123  
 MD 261=456

M1=123 L<sub>F</sub>            Selection of C axis mode for spindle 1  
 M3=456 L<sub>F</sub>            Deselection of C axis mode for spindle 3

<b>730-739</b>	<b>1st transformation parameter 1 to 10 (from Software Version 4)</b>		<b>730-739</b>
Standard value	Lower input limit	Upper input limit	Units
<b>0</b>	<b>-99 999 999</b>	<b>99 999 999</b>	<b>units (IS)</b>

**Active: After POWER ON**

NC MD 740 to 749    2nd transformation, parameter 1 to 10  
 NC MD 750 to 759    3rd transformation, parameter 1 to 10  
 NC MD 760 to 769    4th transformation, parameter 1 to 10  
 NC MD 770 to 779    5th transformation, parameter 1 to 10  
 NC MD 780 to 789    6th transformation, parameter 1 to 10  
 NC MD 790 to 799    7th transformation, parameter 1 to 10  
 NC MD 800 to 809    8th transformation, parameter 1 to 10

The transformation parameters are required for the 2D/3D coordinate transformation.  
 For description see NC MD 5060 to 5069 and Section 11.

<b>876-899</b>	<b>Leading axis coupled motion axis (from Software Version 3)</b>		<b>876-899</b>
Standard value	Lower input limit	Upper input limit	Units
<b>0</b>	<b>0</b>	<b>24</b>	<b>-</b>

**Active: After POWER ON**

With the definition of these coupled axis pairings you define which axis it will be coupled if a leading axis is programmed.

There are up to 12 coupled axis pairings.

	Coupled axis	Leading axis	Coupled axis	Leading axis	Coupled axis	Leading axis	Coupled axis	Leading axis
<b>NC MD</b>	883	882	881	880	879	878	877	876

	891	890	889	888	887	886	885	884
<b>NC MD</b>								

	899	898	897	896	895	894	893	892
<b>NC MD</b>								

The axis number must be entered in the MD as follows:

- 0 ..... no axis
- 1 ..... 1st axis (NC MD 5640 Bit 7 = 1)
- 2 ..... 2nd axis (NC MD 5641 Bit 7 = 1)
- ⋮
- 11 ..... 11th axis (NC-MD 5650 Bit 7 = 1)
- ⋮
- ⋮

Only in the coupled axis combinations (NC MD 5156 to 5182) do you define how the coupled axis pairings will behave (coupled motion in same direction/opposite direction/...) and with which G function they will be activated.

The following must be observed for coupled axis pairings (in case of error Alarm 84 is output):

- a. The axes of a coupled axis pairing must belong to the same mode group.
- b. The axes of a coupled axis pairing must have the same position control resolution and the same display resolution.
- c. The axes of a coupled axis pairing must belong to the same type of axis:

Rotary axis ..... : MD 564\*, 5  
 Actual value display modulo 360 degrees . : MD 560\*, 7  
 Modulo progr. for rotary axes ..... : MD 572\*, 2  
 Rounding axis ..... : MD 560\*, 3  
 Rounding up to whole/half degree ..... : MD 560\*, 2  
 Auxiliary axis ..... : MD 572\*, 0  
 Facing axis ..... : MD 572\*, 1

- d. The axes of a coupled axis pairing must be able to be programmed in the same channels MD 576\*, 7 - 0 and MD 580\*, 7 - 0.
- e. The axes of a coupled axis pairing must be available (NC MD 564\* Bit 7 = 1).
- f. Neither axis of a coupled axis pairing can be a fictitious axis (NC MD 564\* Bit 6 = 0).
- g. One leading axis can be coupled to several axes.

**Example:**

Coupled axis		Leading axis		Coupled axis		Leading axis		Coupled axis		Leading axis		Coupled axis		Leading axis	
883		882		881		880		879		878		877		876	
<b>0</b>	<b>0</b>	<b>6</b>	<b>1</b>	<b>5</b>	<b>1</b>	<b>4</b>	<b>1</b>								

- h. The leading axis of a coupled axis pairing can **not** at the same time be the coupled axis of the same pairing (also observe NC MD 5156 to 5188).

NC MD	Coupled axis	Leading axis	Coupled axis	Leading axis	Coupled axis	Leading axis	Coupled axis	Leading axis
		883	882	881	880	879	878	877
	<b>0</b>	<b>0</b>	<b>0</b>	<b>0</b>	<b>3</b>	<b>2</b>	<b>2</b>	<b>1</b>

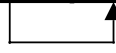
 not possible

- i. The leading axis of a coupled axis pairing can at the same time be the coupled motion axis of another pairing (observe also NC MD 5156 to 5183).
- j. A leading axis can **not** be coupled to itself.

NC MD	Coupled axis	Leading axis	Coupled axis	Leading axis	Coupled axis	Leading axis	Coupled axis	Leading axis
		883	882	881	880	879	878	877
	<b>0</b>	<b>0</b>	<b>0</b>	<b>0</b>	<b>0</b>	<b>0</b>	<b>1</b>	<b>1</b>

- k. A coupled axis can be coupled to several leading axes, if the leading axes are in different coupled motion pairings and these coupled axis pairings are not active at the same time.

The definition of the coupled axis pairings can be changed with a warm restart without power on (for warm restart see also Section 11.6).



930		Assignment of FA to NC CPU (electronic gearbox from Software Version 5 and synchronous spindle from Software Version 6)		930			
Standard value		Lower input limit		Upper input limit		Units	
0		0		7		-	

**Active: After warm start**

The information entered in this machine data identifies which NC CPU will be used for calculating the particular electronic gearbox (ELG) grouping. The assignments of all 3 following axes (FA) are defined with NC MD 930.

Structure of MD 930

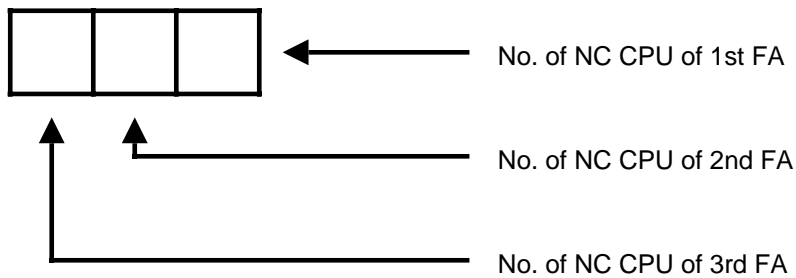
**Examples:**

- 0 1 1 Calculation of FA1 and FA2 occurs on NC CPU I
- 0 2 1 Calculation of FA1 occurs on NC CPU I, of FA02 on NC CPU II

This machine data becomes effective with **warm start**.

<b>932</b>	<b>Assignment of synchronous spindles to NC CPUs (from Software Version 6)</b>			<b>932</b>
Standard value	Lower input limit	Upper input limit	Units	
<b>0</b>	—	—	<b>Special format</b>	

The information entered in this machine data identifies which NC CPU will perform the calculations for the individual pairs of synchronous spindles.

The structure of MD 932 is as follows:

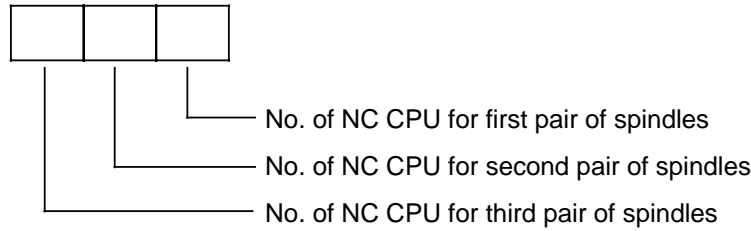

**Notes**

- In MD 930 the ELG pairs are assigned similarly to the NC CPUs.
- The sum of the pairs of synchronous spindles and ELG pairs must not be more than three. Therefore, the individual boxes in MD 930 and 932 may only be used in one of the two machine data with a value not equal to zero.
- The given NC CPU must process the master channel of the mode group of the spindles.
- When making the entry, remember that the numbers of the NC CPUs are not checked.

<b>940/ 960/980</b>	<b>Global C axis No. of following spindles 1/2/3 (from Software Version 6)</b>			<b>940/ 960/980</b>
Standard value	Lower input limit	Upper input limit	Units	
<b>0</b>	<b>0</b>	<b>24</b>	—	

Each following spindle must be assigned a C axis in MD 461\*. As in MD 461\*, the global axis No. of this C axis must be entered here too.

940/ 960/980	Global axis number of the following axis 1/2/3 (ELG from Software Version 5)			940/ 960/980
Standard value	Lower input limit	Upper input limit	Units	
<b>0</b>	<b>0</b>	<b>24</b>		

**Active: After warm start**

The leading and following axes of the ELG groupings must be configured. To do this, the global axis numbers of the following axes and the associated leading axes are entered in the appropriated machine data. All following and leading axes have the standard default "0" (no axis).

The global axis number of the following axis must be entered as positive integer. If "0" is entered, this ELG is not calculated.

For setting the compensatory controller, it is possible to activate a built-in test function with this MD.

The structure of the MD:

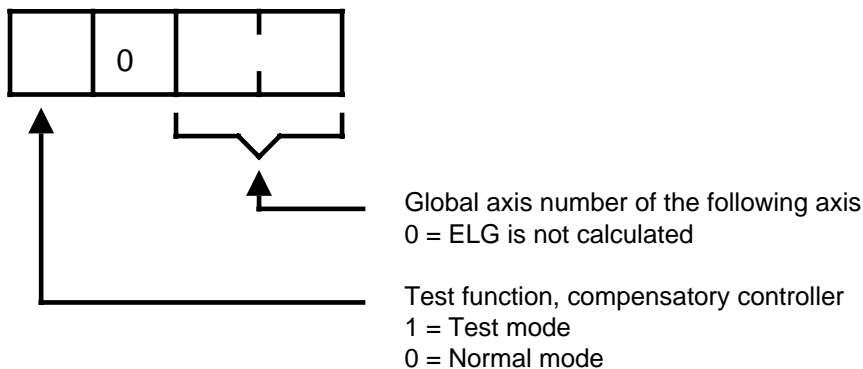

With this test function, a disturbance on the leading axis can be simulated. The test mode is switched on and off with **warm start**.

**ELG MD (from Software Version 5)**

<b>941-942</b>	<b>Global axis number of the first and second fictitious leading axis for following axis 1</b>		<b>941-942</b>
Standard value	Lower input limit	Upper input limit	Units
<b>0</b>	<b>0</b>	<b>24</b>	

<b>961-962</b>	<b>Global axis number of the first and second fictitious leading axis for following axis 2</b>		<b>961-962</b>
Standard value	Lower input limit	Upper input limit	Units
<b>0</b>	<b>0</b>	<b>24</b>	

<b>981-982</b>	<b>Global axis number of the first and second fictitious leading axis for following axis 3</b>		<b>981-982</b>
Standard value	Lower input limit	Upper input limit	Units
<b>0</b>	<b>0</b>	<b>24</b>	

**Active: After warm start**

The global axis numbers for the fictitious leading axes must be entered as positive integers. If the axis number "0" is entered for a fictitious leading axis, this leading axis is considered to be not available.

The MD values become active with **warm start**.

943/ 963/983	Configuration of leading spindles to following spindles 1/2/3 (from Software Version 6)			943/ 963/983
Standard value	Lower input limit	Upper input limit	Units	
<b>0</b>	–	–	<b>Special format</b>	

The global spindle numbers of the leading spindles of the individual pairs of synchronous spindles are entered in this machine data. Also established is whether the setpoint or the actual value of the leading spindle is to be used as the control value for the following spindle.

The structure of the machine data is as follows:

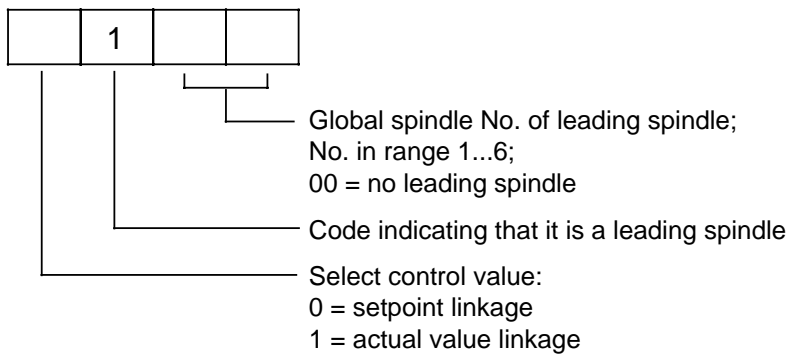

### Notes

- The two spindles of a pair of synchronous spindles must be calculated on the same NC CPU.
- One spindle may not be a following spindle in two different pairs of synchronous spindles.
- A following spindle may not be declared as the leading spindle of another pair (i.e. no cascading possible).
- The position-control sampling intervals of the leading spindle and following spindle must be identical in the following cases:
  - for setpoint linkage
  - for a defined value of angular offset between leading spindle and following spindle.

### Examples

- First spindle as leading spindle in first pair of synchronous spindles with setpoint linkage:  
MD 943 = 0101
- Third spindle as leading spindle in second pair of synchronous spindles with actual value linkage:  
MD 963 = 1103

**ELG MD (from Software Version 5)**

<b>943/ 944/945</b>	<b>Global axis number of the first, second and third real leading axis for following axis 1</b>			<b>943/ 944/945</b>
Standard value	Lower input limit	Upper input limit	Units	
<b>0</b>	<b>0</b>	<b>1106</b>		

<b>963/ 964/965</b>	<b>Global axis number of the first, second and third real leading axis for following axis 2</b>			<b>963/ 964/965</b>
Standard value	Lower input limit	Upper input limit	Units	
<b>0</b>	<b>0</b>	<b>1106</b>		

<b>983/ 984/985</b>	<b>Global axis number of the first, second and third real leading axis for following axis 3</b>			<b>983/ 984/985</b>
Standard value	Lower input limit	Upper input limit	Units	
<b>0</b>	<b>0</b>	<b>1106</b>		

**Active: After warm start**

The global axis numbers of the 1st/2nd/3rd real leading axes must be entered as positive integers. If "0" is entered for an axis number, this leading axis is not considered for setpoint calculation of the following axis. In addition, the information as to whether the leading axis is an axis or a spindle and whether the setpoint value (only possible for axis) or the actual value is to be used as command variable.

The MD values become active with **warm start**.

Structure of the MD for definition of the real leading axes:

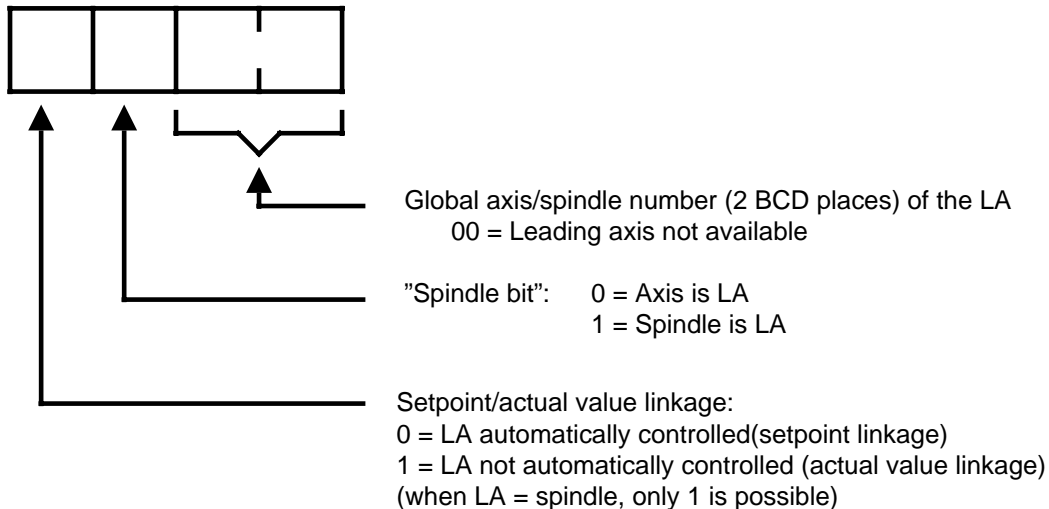

### Examples for entry:

3rd axis as real LA with setpoint linkage (standard case)

Enter 0003 or 3

2nd spindle as real leading axis with actual value linkage

Enter 1102

When configuring the ELG groupings (definition of leading and following axes) the following must be observed:

- All axes in an ELG grouping (LA and FA) must belong to the same mode group. Programming is possible in different NC channels.
- All axes in an ELG grouping (LA and FA) must be calculated on the same NC CPU.
- A following axis must not be declared as leading axis for another following axis (cascading is not possible).
- A leading axis can be assigned to several following axes.
- The ELG groupings can be reconfigured via the machine data. With "warm start", the new ELG groupings are transferred.
- All axes in an ELG grouping must be available (NC-MD 564\*, bit 6=0).
- The axes in an ELG grouping can be of different type (round axis, linear axis MD 564\*, bit 5) or have different display resolution (MD 1800\*, bits 4-7).
- The position control sampling times of leading and following axes must be identical in following cases
  - with setpoint linkage
  - when applying on-the-fly synchronization between leading and following axis (both for actual value and setpoint linkage).
- A leading axis can be switched in the follow-up mode. To make sure that the hardware monitoring of the actual value encoder is active, a setpoint output must be assigned to this leading axis.
- For an overlaying movement (FA overlay, on-the-fly synchronization, semi-automatic centering), the following axis requires a free NC channel.

<b>946/ 966/986</b>	<b>Control par. for compensatory controller of following spindles 1/2/3 (P-component) (from Software Version 6)</b>		<b>946/ 966/986</b>
Standard value	Lower input limit	Upper input limit	Units
<b>0</b>	<b>0</b>	<b>16 000</b>	<b>0.001</b>

<b>947/ 967/987</b>	<b>Control par. for compensatory controller of following spindles 1/2/3 (I-component)</b>		<b>947/ 967/987</b>
Standard value	Lower input limit	Upper input limit	Units
<b>0</b>	<b>0</b>	<b>16 000</b>	<b>0.001</b>

The control behaviour of the PI-action compensatory controller is set with this machine data.

### Setting the compensatory controller

The recommended method of setting the compensatory controller is as follows (taking FS 1 as an example):

- Increase tolerance bands for "Fine/Coarse synchronism" (flag old values):
  - Enter ca. 500 in MD 952
  - Enter ca. 1000 in MD 953
- Preset control parameters for compensatory controller:
  - Start value for P-component (MD 946) ca. 1000
  - Start value for I-component (MD 947) ca. 400
- Select synchronous mode (G201)
- Drive the spindle (e.g. with overstore) and observe IS:FINE SYNCHRONISM and COARSE SYNCHRONISM (e.g. in the service function "PLC STATUS")
- Increase MD 946 and 947 in steps of 100 until the two interface signals remain as steady as possible over the whole speed range (different values of speed can be issued with the aid of the override switch); changes to the I-component (MD 947) will have a great effect.
- Check the settings:
  - Drive spindle at maximum speed
  - Decelerate the spindle (e.g. M19 or IS:SPINDLE DISABLE)
  - Spindle must remain stable and must not oscillate; otherwise the parameters of the compensatory controller must be reduced
- Reduce the tolerance bands for "Fine/Coarse synchronism" in steps and repeat the setting of the control parameters. Keep repeating the whole procedure until the optimum is reached.
- Reset the tolerance bands for "Fine/Coarse synchronism" to their original values.



**Limit values**

Tests on actual machines have shown that the following limits for machine data should not be exceeded:

- for the P-component (MD 946/966/986) approx. 5000
- for the I-component (MD 947/967/987) approx. 1200

**Notes**

- Changes to these values become operative immediately.
- The response of the compensatory controller to speed deviations can be influenced by means of the "sensitivity reduction, compensatory controller" bit (MD 502x, bit 1, x = 1, 2, 3 for FS 1, 2, 3).

**ELG MD (from Software Version 5)**

<b>946/ 947/948</b>	<b>Control parameters for compensat. controller of the following axis 1 (P, I, D components)</b>		<b>946/ 947/948</b>
Standard value	Lower input limit	Upper input limit	Units
<b>0</b>	<b>0</b>	<b>16 000</b>	<b>0.001</b>

<b>966/ 967/968</b>	<b>Control parameters for compensat. controller of the following axis 2 (P, I, D components)</b>		<b>966/ 967/968</b>
Standard value	Lower input limit	Upper input limit	Units
<b>0</b>	<b>0</b>	<b>16 000</b>	<b>0.001</b>

<b>986/ 987/988</b>	<b>Control parameters for compensat. controller of the following axis 3 (P, I, D components)</b>		<b>986/ 987/988</b>
Standard value	Lower input limit	Upper input limit	Units
<b>0</b>	<b>0</b>	<b>16 000</b>	<b>0.001</b>

**Active: After warm start**

Together with the built-in test function (see MD 940 for FA1) the automatic control behaviour of the PID compensatory controller can be set with these machine data.

Any change to these values is active immediately.

Values between 800 and 1000 have resulted from machine tests as guide values.

With the help of the machine data "Sensitivity attenuation compensatory controller", the response of the compensatory controller to speed deviations can be influenced.

**ELG MD (from Software Version 5)**

<b>950/ 970/990</b>	<b>Time constant parallel model for following axis 1/2/3</b>			<b>950/ 970/990</b>
Standard value	Lower input limit	Upper input limit	Units	
<b>0</b>	<b>0</b>	<b>16 000</b>	<b>0.1 ms</b>	

**Active: After warm start**

This machine data is needed in order to allow for the setpoint values in the compensatory controller caused by the fictitious leading axis and the overlaying movement of the following axis.

This parallel model must be set to the time constant of the position control loop of the following axis (time constant  $T = 1/K_V$ ). When a feedforward control is used, the effective  $K_V$  factor must be used for this formula. The time constant is automatically included in the calculation when determining the effective  $K_V$  factor (see MD 951, 971 and 991).

This automatically determined time constant must be changed and reoptimized if necessary owing to the influence of the speed controller.

**ELG MD (from Software Version 5)**

<b>951/ 971/991</b>	<b>Effective <math>K_V</math> factor of following axis 1, 2, 3</b>			<b>951/ 971/991</b>
Standard value	Lower input limit	Upper input limit	Units	
<b>0</b>	<b>0</b>	<b>16 000</b>	<b>0.01 s<sup>-1</sup></b>	

**Active: After warm start**

The effective  $K_V$  factor is required for following error compensation and must therefore be determined precisely. A routine can be activated for the purpose which calculates the effective  $K_V$  factor and enters it in the MD.

Without feedforward control, this value corresponds to that in MD 252\*. With dynamic feedforward control, it is greater by a factor of approx. 1.5 to 2.

In order to determine this factor, an ELG (at least the LA) must be defined. The value "0" must be entered in MD 951, 971 and/or 991. The following axis is then traversed e.g. in JOG mode preferably with 100 % feed override. The velocity must have no particular value that is it should be as large as possible (at least 50 % of rapid traverse velocity) in order to increase the accuracy of calculation.

Once the following axis has been traversing for several seconds (5 to 10) at constant velocity, the effective  $K_V$  factor and the time constant of the parallel model are determined within the control and entered into the relevant machine data.

In order to determine the effective  $K_V$  factor, the compensatory controller must be switched off.

951/ 971/991	<b>Effective servo gain factor of following spindles 1/2/3 (from Software Version 6)</b>			951/ 971/991
Standard value	Lower input limit	Upper input limit	Units	
<b>0</b>	<b>0</b>	<b>16 000</b>	<b>0.01 s<sup>-1</sup></b>	

The effective servo gain factor ( $K_v$ ) is needed for the compensation of following error and so must be determined with precision. The value can be calculated automatically.

Calculation of the effective servo gain factor must be completed before following error compensation is activated.

The calculation must be repeated if the dynamic response of the following spindle is changed.

**Notes**

- The units for the servo gain factor are different from those of spindle gain factor. Since the data is also used for the ELG pairs, the normal units for axes have been chosen here. Therefore, the values in MD 951/971/991 differ from the corresponding values in MD 435\* to 442\* by the factor 1.666... .
- If the synchronous mode is to be employed with different gear ratios, the effective servo gain factor must be identical for each ratio.

**Procedure for automatic calculation**

- The compensatory controller and following error compensation must be off (SD 5004/5006/ 5008, bit 4 and MD 5021/5022/5023, bit 0).
- The setting of tachogenerator compensation must have been completed.
- Synchronous mode must have been selected for the appropriate pair of spindles (G201).
- Zero must be entered in MD 951/971/991 initially.
- The leading spindle is then driven at high speed and 100% override. The following spindle runs in synchronism.
- After several seconds of constant running, the effective servo gain factor appears in MD 951/971/991 and the time constant of the relevant parallel model in MD 950/970/990.

**ELG MD (from Software Version 5)**

<b>952-953</b>		<b>Tolerance band for synchronism fine and coarse of the following axis 1</b>		<b>952-953</b>
Standard value		Lower input limit	Upper input limit	Units
<b>fine</b>	<b>40</b>	<b>0</b>	<b>16 000</b>	<b>units (MS)</b>
<b>coarse</b>	<b>100</b>			

<b>972-973</b>		<b>Tolerance band for synchronism fine and coarse of the following axis 2</b>		<b>972-973</b>
Standard value		Lower input limit	Upper input limit	Units
<b>fine</b>	<b>40</b>	<b>0</b>	<b>16 000</b>	<b>units (MS)</b>
<b>coarse</b>	<b>100</b>			

<b>992-993</b>		<b>Tolerance band for synchronism fine and coarse of the following axis 3</b>		<b>992-993</b>
Standard value		Lower input limit	Upper input limit	Units
<b>fine</b>	<b>40</b>	<b>0</b>	<b>16 000</b>	<b>units (MS)</b>
<b>coarse</b>	<b>100</b>			

**Active: After warm start**

During LINK ACTIVE, the positional deviation of the following axis to the leading axes is monitored with the tolerance band "Synchronism fine" and "Synchronism coarse".

If the positional deviation FA/LA is greater than the tolerance band, the corresponding PLC interface signal "Synchronism fine" or "Synchronism coarse" is set to 0 signal.

With the message "Synchronism fine" or "Synchronism coarse", the positional synchronism of the following axis can thus be tested.

<b>952/ 972/992</b>	<b>Fine synchronism for following spindles 1/2/3 (from Software Version 6)</b>			<b>952/ 972/992</b>
Standard value	Lower input limit	Upper input limit	Units	
<b>40</b>	<b>0</b>	<b>16 000</b>	<b>Units (MS)</b>	

<b>953/ 973/993</b>	<b>Coarse synchronism for following spindles 1/2/3</b>			<b>953/ 973/993</b>
Standard value	Lower input limit	Upper input limit	Units	
<b>100</b>	<b>0</b>	<b>16 000</b>	<b>Units (MS)</b>	

The position difference between leading spindle and following spindle is monitored in the synchronous mode. It is performed with the two tolerance bands "Fine synchronism" and "Coarse synchronism".

For each tolerance band there is an interface signal that is set when the position difference between leading spindle and following spindle fluctuates within the band.

This allows the positional synchronism between leading spindle and following spindle to be interrogated by the PLC user program by means of IS: FINE SYNCHRONISM and COARSE SYNCHRONISM.

**Note**

Any changes to these values become operative immediately.

**ELG MD (from Software Version 5)**

<b>954/ 974/994</b>	<b>Emergency retraction threshold for following axis 1/2/3</b>			<b>954/ 974/994</b>
Standard value	Lower input limit	Upper input limit	Units	
<b>400</b>	<b>0</b>	<b>16 000</b>	<b>units (MS)</b>	

**Active: Immediately**

With LINK ACTIVE the positional deviation of the following axis to the leading axes can be monitored with the machine data "Emergency retraction threshold".

If the positional deviation FA/LA exceeds this threshold value, it can very quickly be output by means of a digital hardware signal. In addition, an NC alarm ("FA emergency retraction") and a PLC interface signal "EMERGENCY retraction active" are set.

For the very fast message "EMERGENCY retraction" (in the position control cycle) the mixed peripherals module (N79) must be used in the servo area.

Changes to the machine data value become active immediately.

**ELG MD (from Software Version 5)**

<b>955/ 975/995</b>	<b>%warning threshold <math>n_{max}</math> and <math>a_{max}</math> for following axis 1/2/3</b>			<b>955/ 975/995</b>
Standard value	Lower input limit	Upper input limit	Units	
<b>90</b>	<b>0</b>	<b>100</b>	<b>%</b>	

**Active: After warm start**

The following axis is limited to maximum acceleration at maximum velocity (MD 276\*, 280\*).

In addition, in both cases a warning threshold is checked whose value is defined as a percentage of the maximum value in MD9\*5. The percentage value applies for both limits.

If, for example, 50 is entered in MD 276\* as acceleration, a PLC interface signal is output in the standard setting if the value of 45 is exceeded.

If the calculated set velocity/set acceleration of the following axis is greater than the specified values, the associated interface signals are set at the PLC interface.

954/ 974/994	<b>Emergency retraction threshold for following spindles 1/2/3 (from Software Version 6)</b>			954/ 974/994
Standard value	Lower input limit	Upper input limit	Units	
<b>400</b>	<b>0</b>	<b>16 000</b>	<b>Units (MS)</b>	

The position difference between leading spindle and following spindle is monitored in the synchronous mode. In addition to the two tolerance bands for "Fine synchronism" and "Coarse synchronism" (MD 952/972/992 and MD 953/973/993) there is also emergency retraction monitoring with the threshold value "Emergency retraction threshold".

If the position difference exceeds this threshold value, the "Emergency retraction" alarm is triggered and IS: EMERGENCY RETRACTION ACTIVE set. However, this will only happen if the emergency retraction monitoring has been activated (SD bit "Enable emergency retraction" set).

When the mixed I/O module in the servo area is used, the "Emergency retraction" signal can also be output as a digital signal (see section on "Hardware signal - emergency retraction"). This is much faster (at position controller clock pulse speed) than evaluating the interface signal.

**Note**

Any changes to these values become operative immediately.

955/ 975/995	<b>Speed and acceleration warning thresholds for following spindles 1/2/3</b>			955/ 975/995
Standard value	Lower input limit	Upper input limit	Units	
<b>90</b>	<b>0</b>	<b>100</b>	<b>%</b>	

Warning thresholds for the speed and acceleration of the following spindle are established with this machine data.

The input values describe the percentages of the actual limit values for speed and acceleration (depending on the actual gear ratio, spindle operating mode, etc.). The limit values are determined by the minima of the relevant values for leading spindle and following spindle.

If these warning thresholds are exceeded, IS: SPEED WARNING THRESHOLD CROSSSED and ACCELERATION WARNING THRESHOLD CROSSSED are set. The PLC user program can then reduce the programmed speed accordingly.



**ELG MD (from Software Version 5)**

<b>956/ 976/996</b>	<b>Waiting time automatically controlled correction for following axis 1/2/3</b>			<b>956/ 976/996</b>
Standard value	Lower input limit	Upper input limit	Units	
<b>16000</b>	<b>0</b>	<b>16000</b>	<b>1 ms</b>	

**Active: After warm start**

If disturbances occur in the leading axes, the following axis changes over to automatically controlled correction, i.e. travel with actual values as command variable. When the waiting time specified above has expired, the system switches over from automatically controlled correction to normal correction (FA in follow-up mode).

Effect of the input values (case distinction):

- 0 : No automatically controlled correction : Immediately normal correction
- 1 ... 15000 : First automatically controlled correction: after expiry of the waiting time, switchover to normal follow-up mode
- 15001 and greater : Permanent automatically controlled correction; no switching over to normal follow-up mode

<b>956/ 976/996</b>	<b>Automatically controlled correction delay for following spindles 1/2/3 (form Software Version 6)</b>			<b>956/ 976/996</b>
Standard value	Lower input limit	Upper input limit	Units	
<b>16 000</b>	<b>0</b>	<b>16 000</b>	<b>ms</b>	

If a fault such as triggering of the zero speed control of an axis stops the mode group to which the leading spindle is assigned, the leading spindle will go into follow-up mode and the following spindle will go initially into "automatically controlled correction".

In this status only the actual values of the leading spindle are then used as the control values the following spindle (even when parameters have been assigned for setpoint linkage).

After the preset delay, the following spindle is changed over from automatically controlled correction to the normal follow-up mode in which there is a rapid deceleration at maximum deceleration current. Then only the actual values of position are held and the linkage between leading spindle and following spindle is no longer maintained.

There are three different cases for entering delay time values:

- Value 0: No automatically controlled correction; immediate changeover to normal follow-up mode in the event of leading spindle malfunction.
- Values 1...15 000: Automatically controlled correction initially; changeover to normal follow-up mode after delay.
- Values over 15 000: Automatically controlled correction only; no changeover to normal follow-up mode.

### 9.3.5.2 Channel-specific values

<b>100*</b>	<b>Channel valid in operating mode group</b>		<b>100*</b>
Standard value	Lower input limit	Upper input limit	Units
<b>Channel no.</b> 1, 2, 3=1 <b>Channel no.</b> >3=0	<b>0</b>	<b>8</b>	-

**Active: After POWER ON**

In the SINUMERIK 880 up to eight mode groups can be selected. All channels are assigned to the corresponding mode groups by means of NC-MD 100\*. At least 1 channel and no more than 8 channels may be assigned to a mode group. The assignment can be altered with a warm restart without POWER ON reset (also see Section 11.6 for warm restart). Channels do not have to be activated in ascending order.

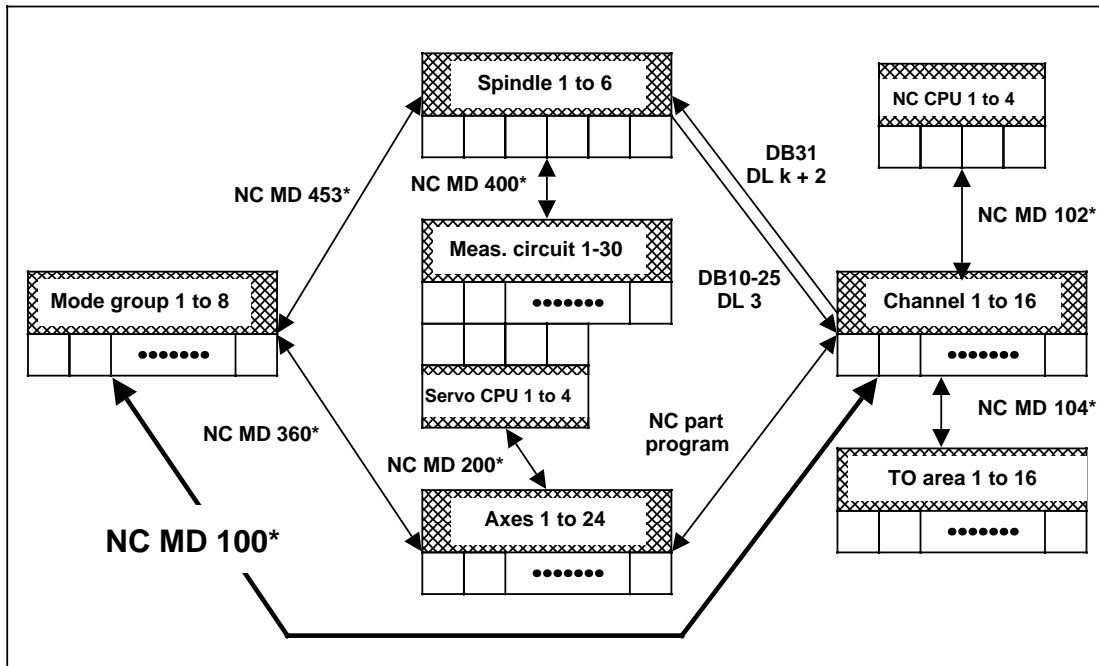

<b>102*</b>	<b>Number of corresponding NC CPU</b>		<b>102*</b>
Standard value	Lower input limit	Upper input limit	Units
<b>Channel no. 1, 2, 3=1 Channel no. &gt;3=0</b>	<b>0</b>	<b>4</b>	<b>-</b>

**Active: After POWER ON**

No more than two NC CPUs may be used with the SINUMERIK 880 (the maximum number depends on the version). All available channels are assigned to the corresponding NC CPU by means of NC MD 102\*. A channel is deemed to be available if it has been assigned to a mode group (MD 100\* = 0 means no assignment). Up to 4 channels may be assigned to one NC CPU.

All activated channels can be distributed to the available NC CPUs in any order. However, at least **one channel** must be available on every NC CPU.

The number of channels activated on one NC CPU should only be that which is actually used otherwise processor power is wasted (block preparation time can increase).

For the maximum number of channels per NC CPU also see section 9.1.2.

**Typical channel assignment:**

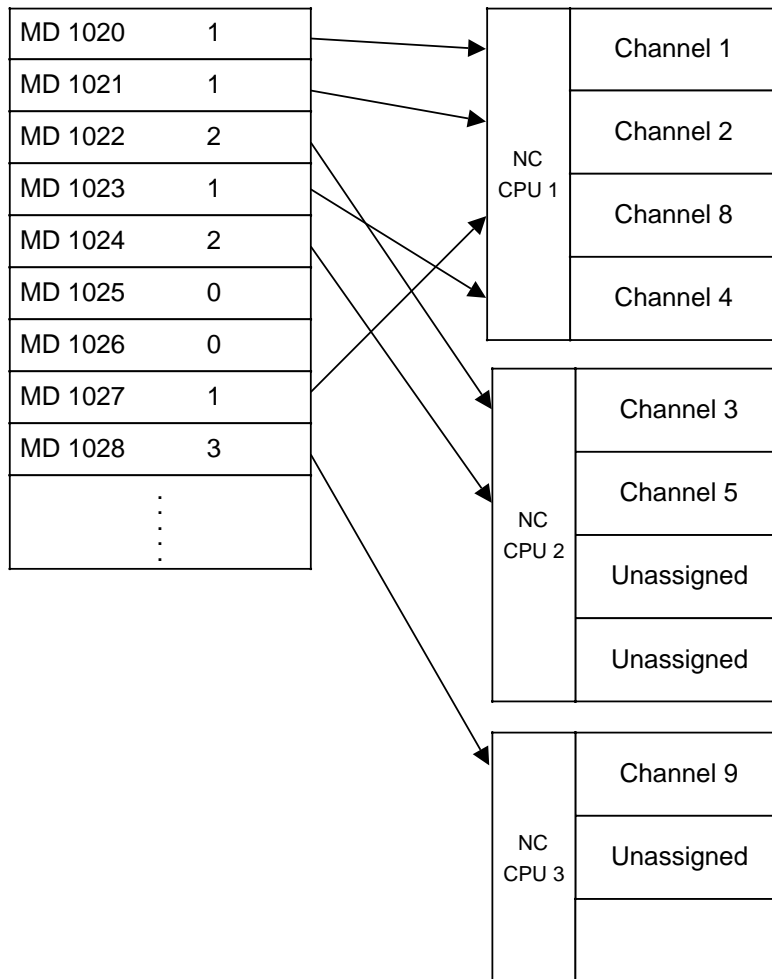

<b>104*</b>	<b>TO area for channel</b>			<b>104*</b>
Standard value	Lower input limit	Upper input limit	Units	
<b>1</b>	<b>1</b>	<b>16</b>	<b>-</b>	

**Active: After user memory has been formatted**

The TO area for each available channel is entered in this MD. The maximum value is to be selected in accordance with NC-MD 210. (see also MD 210, 211-226)

<b>106*</b>	<b>Number of released program</b>			<b>106*</b>
Standard value	Lower input limit	Upper input limit	Units	
<b>0</b>	<b>see below</b>	<b>see below</b>	<b>-</b>	

**Active: In next block**

When 0 is entered, all programs at the first processing level are released for this channel. If only a specific program at the first processing level can be activated in a given channel, the program number should be entered at this point.

This can be useful if only one particular movement is to be carried out in a channel, e.g. for loaders, tool palleting, ... .

Main programs: 1 to +9999  
 Subroutine/cycles: -1 to -999  
 and subroutines: 0

<b>108*-120*</b>	<b>Reset position for G groups (from Software Version 3)</b>			<b>108*-120*</b>
Standard value	Lower input limit	Upper input limit	Units	
<b>see below</b>	<b>see below</b>	<b>see below</b>	<b>-</b>	

Up to Software Version 2 a predefined reset position (different for SINUMERIK 880T and SINUMERIK 880M) was selected for the G groups after NC start of a program (AUTOMATIC/MDA) in a channel.

From Software Version 3 the reset position for the G groups 1, 3, 6, 8, 12 and 15 can be defined channel-specific.

Only the G functions of the corresponding G group listed in the table below can be entered in the NC MD 108\* to 120\*. The reset position for G group 9 (G70/G71) is defined in NC MD 5112 with the input resolution.

Standard value	NC MD for reset pos.	G-group												
G01	108*	1	G13	G12	G06	G35	G34	G33	G03	G02	G11	G10	M/T G01	G00
		2												G09
M: G17 T: G18	110*	3									G09	G19	T G18	M G17
		4										G42	G41	M/T G40
		5												G53
G54	112*	6									G57	G56	G55	M/T G54
		7						G74	G92	G59	G58	G26	G25	G04
M: G60 T: G64	114*	8									G62	T G64	G63	T G60
		9											G71	G70
		10			G89	G88	G87	G86	G85	G84	G83	G82	G81	M/T G80
		11										G68	G91	M/T G90
M: G94 T: G95	118*	12									G97	G96	T G95	M G94
		13				G111	G110	G48	G348	G248	G148	G347	G247	G147
		14											G51	M/T G50
G150	120*	15			G159	G158	G157	G156	G155	G154	G153	G152	G151	M/T G150
		16									G135	G133	G131	G130
		17									G235	G233	G231	G230
		18									G335	G333	G331	G330
0	122*	19												0

For group allocation and the description of the G functions see programming guide.

130*		Serial interface for "Execution from external" (from Software Version 6.1)		130*	
Standard value	Lower input limit	Upper input limit	Units		
3	0	4	-		

This machine data is used to select the interface (RS232C, file transfer) which is to be started for the channel in question for the "Execution from external" function.

Channel no.    x = 0            Channel 1  
                   x = 1            Channel 2  
                   etc.

Interface            0: no interface

Interface            1-4: 1st - 4th RS232C (V.24) interface

Interface            5: file transfer

**Note:**

The serial interface 3 (COM CPU) is used for programming the PLC with the programmer.

Using the 1st and 2nd serial interface for "Execution from external" is not recommended because the net data rate is lower than the 3rd and 4th serial interface used for computer link/file transfer.

Additional machine data: (MD 30, MD 5148-5152, option "Execution from external").

### 9.3.5.3 Axis-specific values / spindle-specific values

Up to 40 axes are possible and envisaged in terms of software to keep the NC system software universal and to be prepared for future developments. However, with the SINUMERIK 880, only the first 24 axes can be activated and implemented in terms of hardware (real and fictitious axes).

The significance of the NC MD changes therefore in increments of 40 NC MD numbers, e.g.

NC MD	2040	Coarse exact positioning for	1st axis
	2041	Coarse exact positioning for	2nd axis
	.	.	.
	.	.	.
	.	.	.
	.	.	.
	2063	Coarse exact positioning for	24th axis
	2064	Coarse exact positioning for	25th to 40th axes
	to	(not relevant to SINUMERIK 880)	
	2079		
	2080	Fine exact positioning for	1st axis
	.		
	.	etc.	

The last position of the NC MD number is represented by the symbol "\*" for the sake of clarity (e.g. 204\* = coarse exact positioning). When the NC MD are displayed and input, the actual figure must be inserted for this symbol "\*" in accordance with axis, spindle or channel.



<b>200*</b>	<b>Axis assignment (up to Software Version 3)</b>		<b>200*</b>
Standard value	Lower input limit	Upper input limit	Units
<b>see below</b>	<b>0</b>	<b>1 003 040</b>	<b>-</b>

**Active: After POWER ON**

On machines that can be ordered as modular systems, it must be possible to flexibly assign the axes actually available on the machine to the measuring circuit modules. Which servo CPU is to control the individual axes must also be defined. MD 200\* is used to specify at which measuring circuit module or encoder (measuring circuit actual value input) the actual position values are to be received and the set speed values output.

⋮	⋮	⋮	⋮
Measuring circuit module No.	Encoder No. (measuring circuit)	Servo CPU No.	Servo CPU axis No. (entered automatically by the control)

- Possible values:
- 00 00 00 00      Axis not available on machine (permissible only with MD 564\* bit 7 = 0)
  - 01 01 01 00      1st measuring circuit module, 1st encoder, 1st servo CPU
  - ⋮
  - 04 02 02 00      4th measuring circuit module, 2nd encoder, 2nd servo CPU
  - ⋮
  - ⋮
  - 10 03 04 00      10th measuring circuit module, 3rd encoder, 4th servo CPU

**Caution!**

No other values are allowed.

All servo CPUs and all measuring circuit modules are in the same bus so that the servo CPUs and the measuring modules are counted through from left to right. There can be no gaps in the numbering as the control preforms the numbering automatically on power-up. This makes jumpering using jumpers or switches unnecessary.

MD no.	Control	Standard MD
2000	880 T/ M	1 0 1 0 1 0 1
2001	880 T/ M	1 0 2 0 1 0 2
2002	880 M	1 0 3 0 1 0 3

In the central controller rack measuring circuit modules do not have to be plugged in directly adjacently (free slots can be left between measuring circuit modules without gaps arising in the numbering).

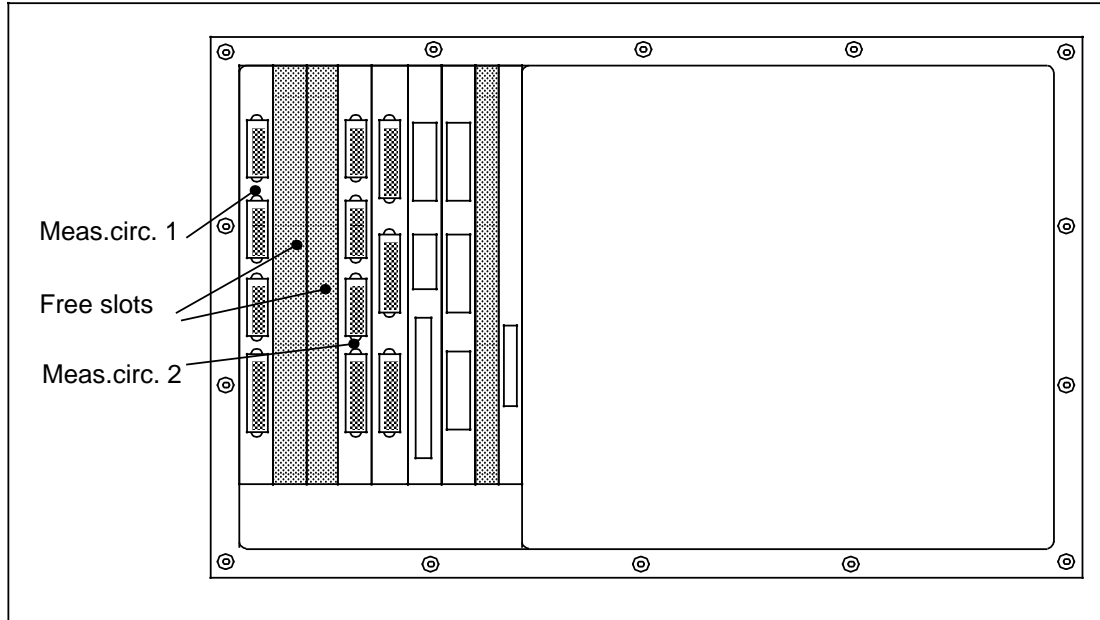

The number of the encoder (measuring circuit) on the measuring circuit module is determined in this way.

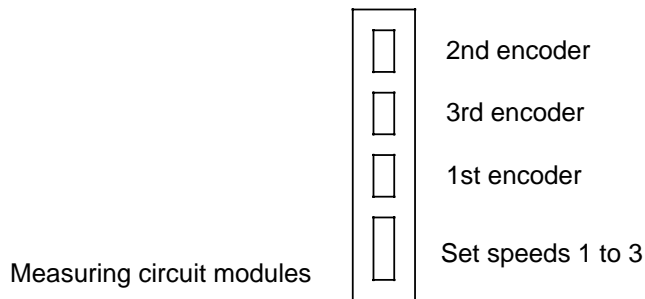

<b>200*</b>	<b>Axis assignment indirect measuring system (replacing the tachometer) (from Software Version 4)</b>		<b>200*</b>
Standard value	Lower input limit	Upper input limit	Units
<b>See: value range</b>	<b>0</b>	<b>1003040</b>	<b>-</b>

In the case of machines of modular construction, flexible assignment of the axes actually provided on the machine to the measuring circuit modules is necessary.

The servo CPU used for position control of the various axes (and speed control too in the case of integrated drive control) must also be defined and on which of the measuring circuit modules or on which encoder (measuring circuit actual value input) the actual position or speed values are to be received.

This information is defined in NC MD 200\*. MD 200\* has the following format:

In each case 2 decimal points			
Measuring circuit module No.	No. of encoder (measuring circuit)	No. of servo CPU	Axis No. of servo CPU (entered by the software)

1st encoder

2nd encoder

3rd encoder

measuring circuit module

**Value range (also see example):**

Measuring circuit module no.: 1...10  
Encoder number: 1...3  
Servo CPU number: 1...4  
Servo CPU axis number: entered by the control, enter 0.

**Notes:**

- For integrated drive control, only HMS measuring circuit modules are allowed.
- Measuring circuit modules and servo CPUs are numbered as before.
- The numbering of the measuring circuit inputs (encoders) has been changed. Encoders now numbered from top to bottom starting with 01 (see diagram above).
- Measuring circuit modules are numbered from left to right starting with 01.
- Servo CPUs are numbered from left to right starting with 01.
- When different servo CPUs are provided, the 32-bit servo CPU must always be inserted in the first position on the subrack (extreme left).

Examples for MD 200*	
00 00 00 00	Axis not available on the machine (only permissible with NC MD 564* bit 7 = 0)
01 01 01 00	1st measuring circuit module, 1st encoder, 1st servo CPU
02 03 02 00	2nd measuring circuit module, 3rd encoder, 2nd servo CPU
10 01 04 00	10th measuring circuit module, 1st encoder, 4th servo CPU

All servo CPUs and all measuring circuit modules are in the same bus so that the servo CPUs and the measuring modules are counted through from left to right. There can be no gaps in the numbering as the control preforms the numbering automatically on power on. This makes jumpering using jumpers, switches or dip fix unnecessary. In the central controller rack measuring circuit modules do not have to be plugged in directly adjacently (free slots can be left between measuring circuit modules without gaps arising in the numbering).

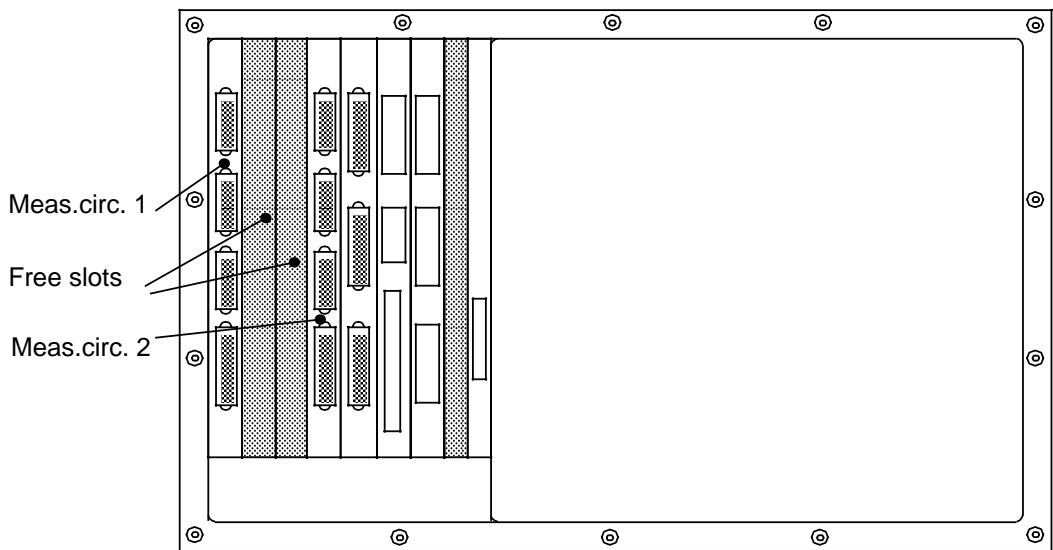

**Note:**

The axis actual value and the axis setpoint (analog set speed) of an axis can be connected on separate measuring circuit modules. However, the axis actual value and the axis setpoint of one axis must not be distributed to measuring circuit modules of different types (SPC measuring circuit modules 6FX1121-4B. and HMS measuring circuit modules 6FX1145-6BA..) .`

<b>204*</b>	<b>Exact stop limit coarse</b>			<b>204*</b>
Standard value	Lower input limit	Upper input limit	Units	
<b>40</b>	<b>0</b>	<b>16 000</b>	<b>units (MS)</b>	

**Active: When all channels of the mode group are in STOP state**

A higher value may be entered in the "exact stop limit coarse" than in the "exact stop limit fine". Consequently, block change to the next machining block is initiated correspondingly earlier.

If this function is not required, it may be disabled by inputting equal exact positioning values in both machine data (coarse and fine stop).

The exact stop limit coarse is active with the following:

- G00
- Block ahead of G04
- Block ahead of setting data
- Block ahead of which only auxiliary functions are programmed
- Single block without G60/G09
- Jog
- Incremental feed
- Program end

**Note:**

The exact stop limit coarse is not approached in continuous-path operation G64 (Exception: G00 G64 exact stop coarse). There is no sequential error as a result of a large number of consecutive positioning operations since the closed-loop position controller is not "shut down" as a result of the exact stop limit, but instead the second block is already processed ahead of the end position of the first block.

The actual travel is now:

Remainder of first block plus second block etc. If the axis remains stationary for an instant, e.g. because another axis is about to move or because there is no axis movement in this program block, the following error is adjusted to 0 and the axis remains precisely in position.

<b>208*</b>	<b>Exact stop limit fine</b>		<b>208*</b>
Standard value	Lower input limit	Upper input limit	Units
<b>10</b>	<b>0</b>	<b>16 000</b>	<b>units (MS)</b>

**Active: When all channels of the mode group are in STOP state**

A traversing movement is complete when the axis has reached the set position +/- the entered exact stop limit fine.

If the set position is not within this range, the position control light remains lit and the block is considered incomplete.

**Remedy**

E.g. Drift compensation

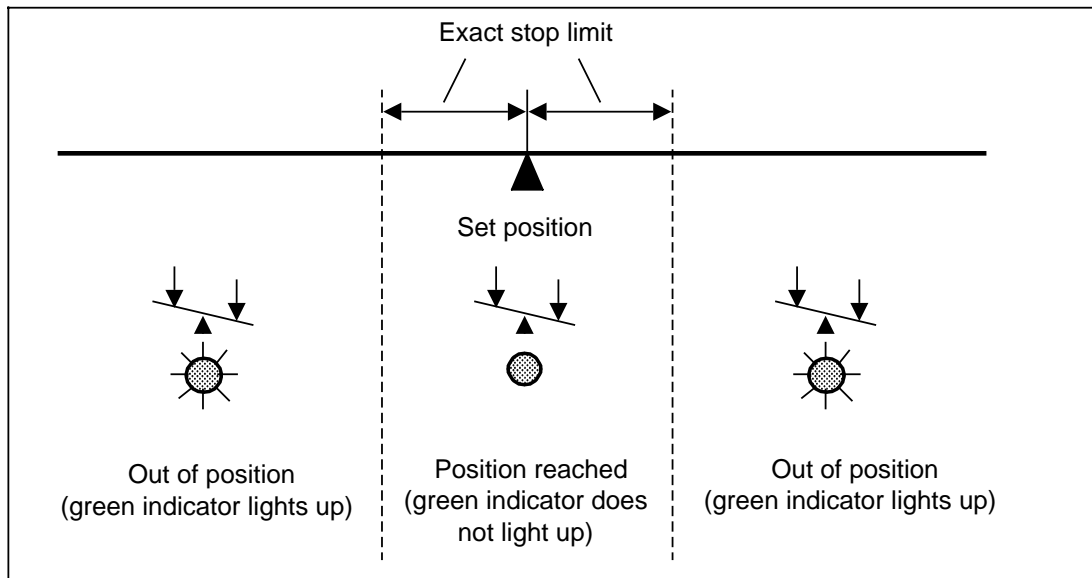

The exact stop limit fine is active with the following:

- G09/G60
- Block ahead of G33

**Note**

In continuous path mode (G64) neither the exact stop limit coarse nor the exact stop limit fine is approached (exception: G00).

<b>212*</b>	<b>Clamping tolerance</b>			<b>212*</b>
Standard value	Lower input limit	Upper input limit	Units	
<b>100</b>	<b>0</b>	<b>16 000</b>	<b>units (MS)</b>	

**Active: When all channels of the mode group are in STOP state**

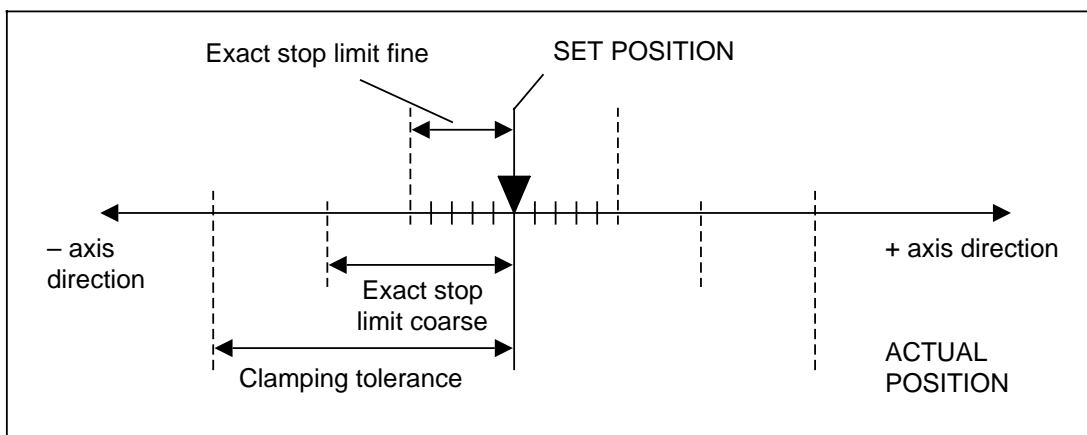

The NC monitors the position at rest (holding of position). Alarm 112\* is displayed if the clamping tolerance is exceeded after the delay for position monitoring (NC MD 156 or NC MD 372\*).

The following conditions may occur:

- a) If the servo enable signal for an axis is cancelled by the interface controller, this means that the axis is no longer held in position by the NC. The interface controller must hold the axis in position itself by means of clamping. As a result, the clamped axis may be forced out of position due to mechanical influences.
- b) The axis may be forced out of position as a result of major mechanical forces or faults in the drive.

The clamping tolerance entered must be ***greater than the exact stop limits fine and coarse***.

<b>220*</b>	<b>Backlash compensation</b>			<b>220*</b>
Standard value	Lower input limit	Upper input limit	Units	
<b>0</b>	<b>-255</b>	<b>255</b>	<b>units (MS)</b>	

**Active: When all channels of the mode group are in STOP state**

In the case of axes with indirect measuring systems, mechanical backlash results in corruption of the traverse path. On reversal of the direction of movement, traverse is either shortened or extended by the amount of backlash, depending on the design.

**Positive backlash (normal conditions)**

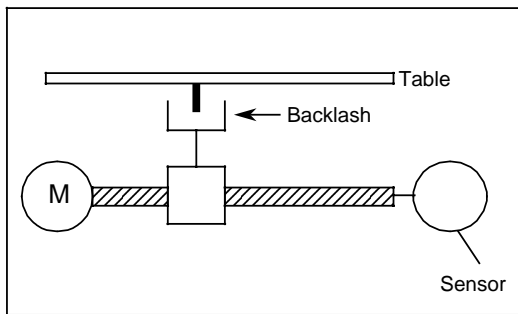

*Actual sensor value ahead of actual value (table): Table travel too short*

**Negative backlash**

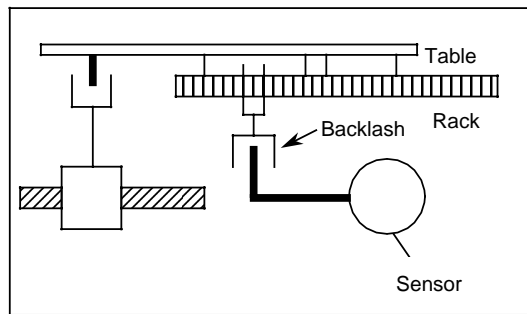

*Actual value (table) ahead of actual sensor value: Table travel too far*

With positive backlashes the compensation value (amount of backlash) is entered as a positive value and with negative back lashes it is entered as a negative value. The backlashes in NC MD 220\* are compensated by the control every time the axes in question changes direction (in all modes and types of interpolation).



<b>224*</b>	<b>First software limit switch (positive direction)</b>		<b>224*</b>
Standard value	Lower input limit	Upper input limit	Units
<b>+99 999 999</b>	<b>-99 999 999</b>	<b>99 999 999</b>	<b>units (MS)</b>

**Active: When all channels of the mode group are in STOP state**

A software limit switch may also be used instead of the customary range limit switch (hardware limit switch). The absolute position of the positive range limit for each axis is input.

The software limit switches cannot fulfil their function properly until the reference point has been approached.

The software limit switches are always approached at the rate entered under NC MD 1, unless a slower rate has been selected in the current motion block. Braking to zero speed is performed so far ahead of the software limit switch that this switch is precisely reached but not overrun (e.g. in jog mode). In certain circumstances the software limit switch can be overrun (see NC MD 0).

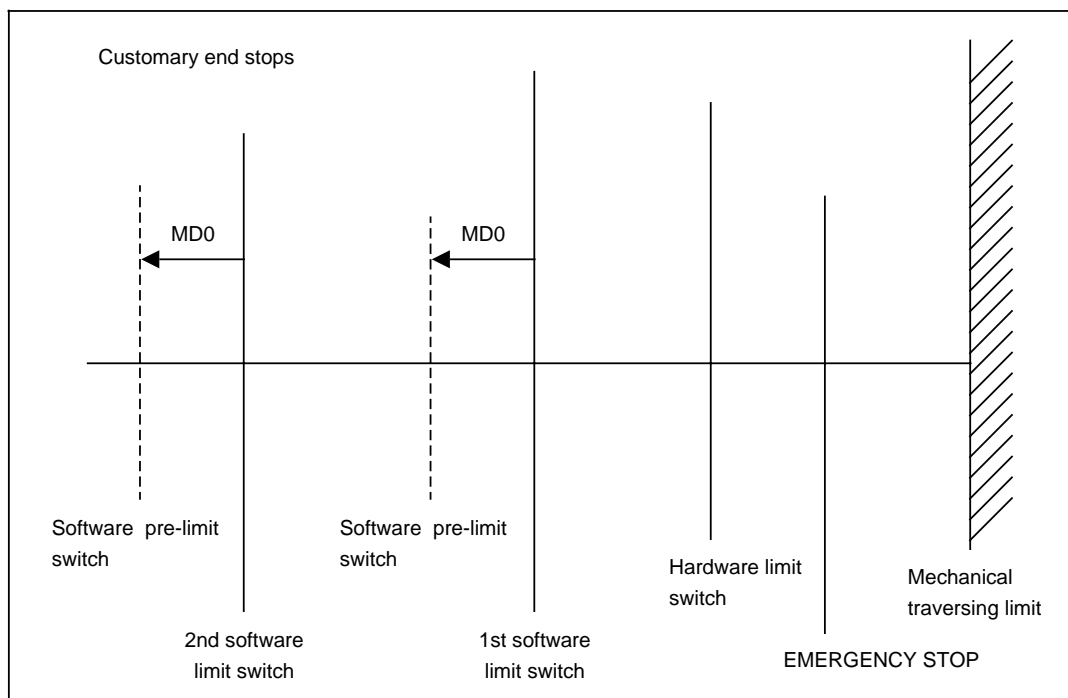

**Note:**

In the case of axes traversed in interpolation, all axes are shut down if the range limit of one axis has been reached. However, stopping without contour violation is only guaranteed if NC MD 5003 bit 7 ("No deceleration at limit switch") has not been set, i.e. during braking over acceleration ramp.

<b>228*</b>	<b>First software limit switch (negative direction)</b>			<b>228*</b>
Standard value	Lower input limit	Upper input limit	Units	
<b>-99 999 999</b>	<b>0</b>	<b>99 999 999</b>	<b>units (MS)</b>	

**Active: When all channels of the mode group are in STOP state**

Same significance as for NC MD 224\* but for traversing limit in negative direction.

<b>232*</b>	<b>Second software limit switch (positive direction)</b>			<b>232*</b>
Standard value	Lower input limit	Upper input limit	Units	
<b>99 999 999</b>	<b>-99 999 999</b>	<b>99 999 999</b>	<b>units (MS)</b>	

**Active: When all channels of the mode group are in STOP state**

A second limit switch position in the positive direction may be specified. Which of the two software limit switches 1 or 2 is to be active is selected by the PLC by means of an interface signal (Interface Description DB32 DL<sub>K+1</sub>/bit 1).

e.g. DB 32 DL1     Bit 1 = 0 ..... First software limit switch active for 1st axis  
                          Bit 1 = 1 ..... Second software limit switch active for 1st axis

**Example of application:**

Reduction of permissible traversing range with tailstock in position.

<b>236*</b>	<b>Second software limit switch (negative direction)</b>			<b>236*</b>
Standard value	Lower input limit	Upper input limit	Units	
<b>-99 999 999</b>	<b>-99 999 999</b>	<b>99 999 999</b>	<b>units (MS)</b>	

**Active: When all channels of the mode group are in STOP state**

Same significance as for NC MD 232\* but in negative direction. Selection by PLC program DB32 DL<sub>K+1</sub>/bit 0 (see Interface Description Part 1).

<b>240*</b>	<b>Referencepoint value</b>		<b>240*</b>
Standard value	Lower input limit	Upper input limit	Units
<b>0</b>	<b>-99 999 999</b>	<b>99 999 999</b>	<b>units (MS)</b>

**Active: When all channels of the mode group are in STOP state**

The difference between the absolute machine zero and the fixed reference point is entered for the respective axis. These values are set as actual values for approach to the reference point (see Section 11.3 for reference point approaches).

From Software Version 5 see also NC MD 1808\* if an absolute encoder is used.

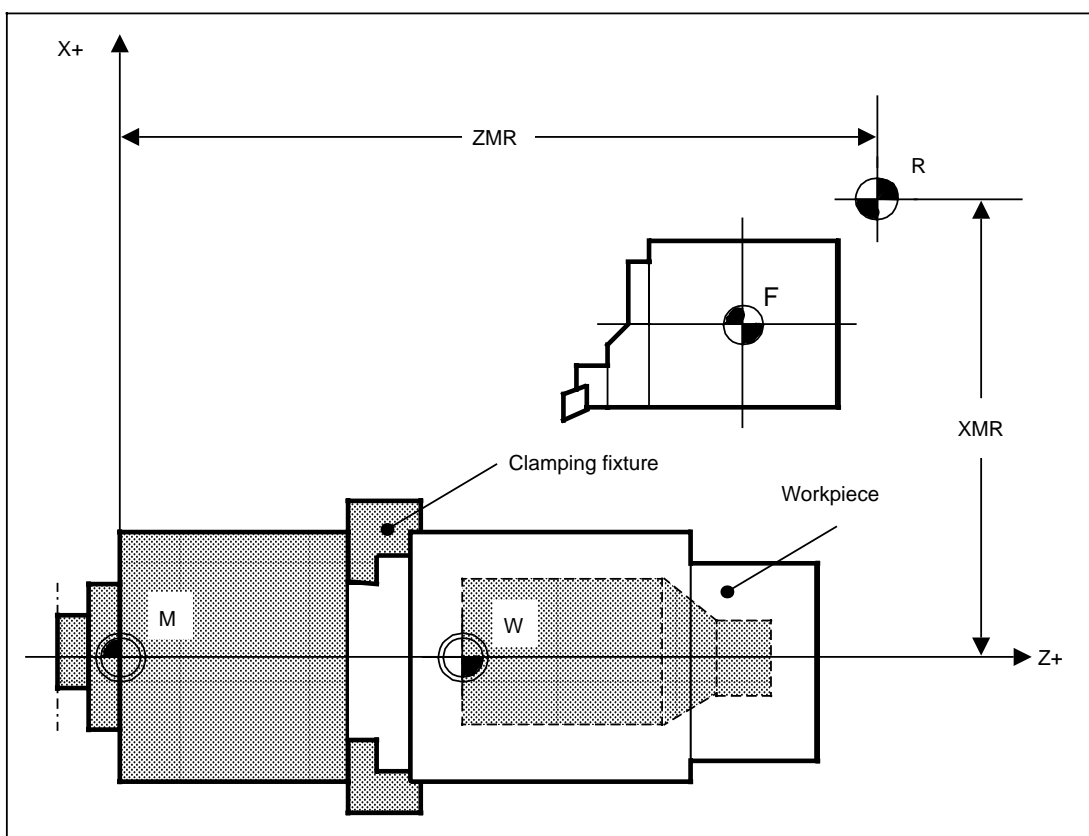

*Example: lathe*

- F ... Slide reference point
- M ... Machine zero
- W ... Workpiece zero
- R ... Reference point
- XMR ... Reference point coordinate in X direction
- ZMR ... Reference point coordinate in Z direction

<b>244*</b>	<b>Reference point shift</b>		<b>244*</b>
Standard value	Lower input limit	Upper input limit	Units
<b>0</b>	<b>-9 999</b>	<b>9 999</b>	<b>units (MS)</b>

**Active: When all channels of the mode group are in STOP state**

The measuring-system reference points may be shifted by means of reference point shift. Consequently, instead of mechanical shifting or rotating of the measuring system (and thus the "deceleration" cam), the reference point may be shifted electrically up to  $\pm 9\,999$  units. The reference point shift path is traversed at the cutoff speed (NC MD 284\*) which must already be reached at the operating cam (for reference point approach see also Section 11.3).

The reference point shift is also effective with automatic reference point approach (NC MD 560\* bit 6).

Without reference point shift, the reference point is 2000 units behind the first zero mark after the operating cam has become free again.

**With positive input** the axis travels in the positive direction by the input value beyond the normal reference point (2000 units after zero mark).

**With negative input** the axis travels, after overrunning the zero mark, to the value resulting from the difference between 2000 units + the input value. Given a reference point shift of more than approx. 2000 units, the axis reverses in the direction of travel (reverse backlash).

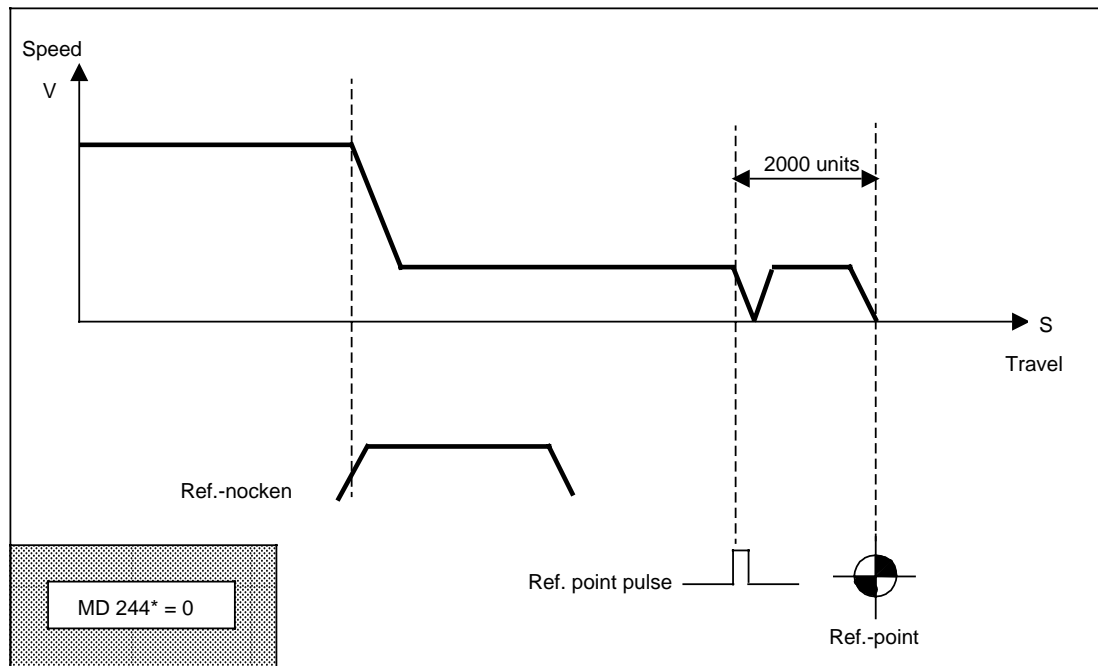

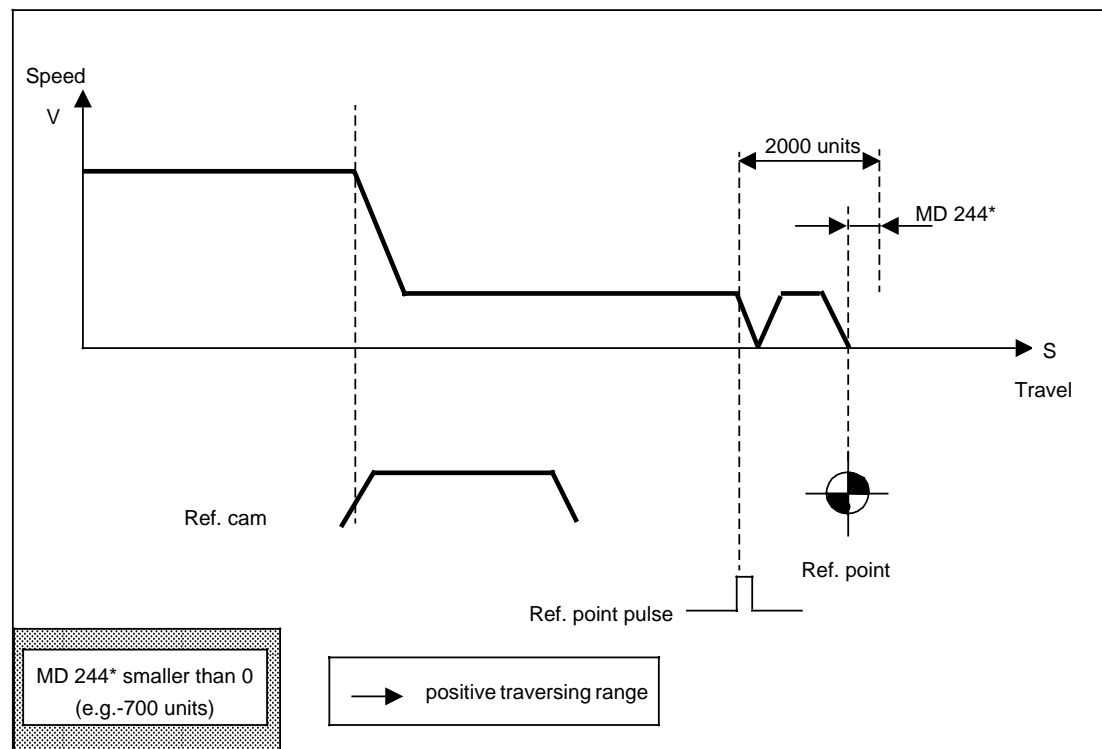
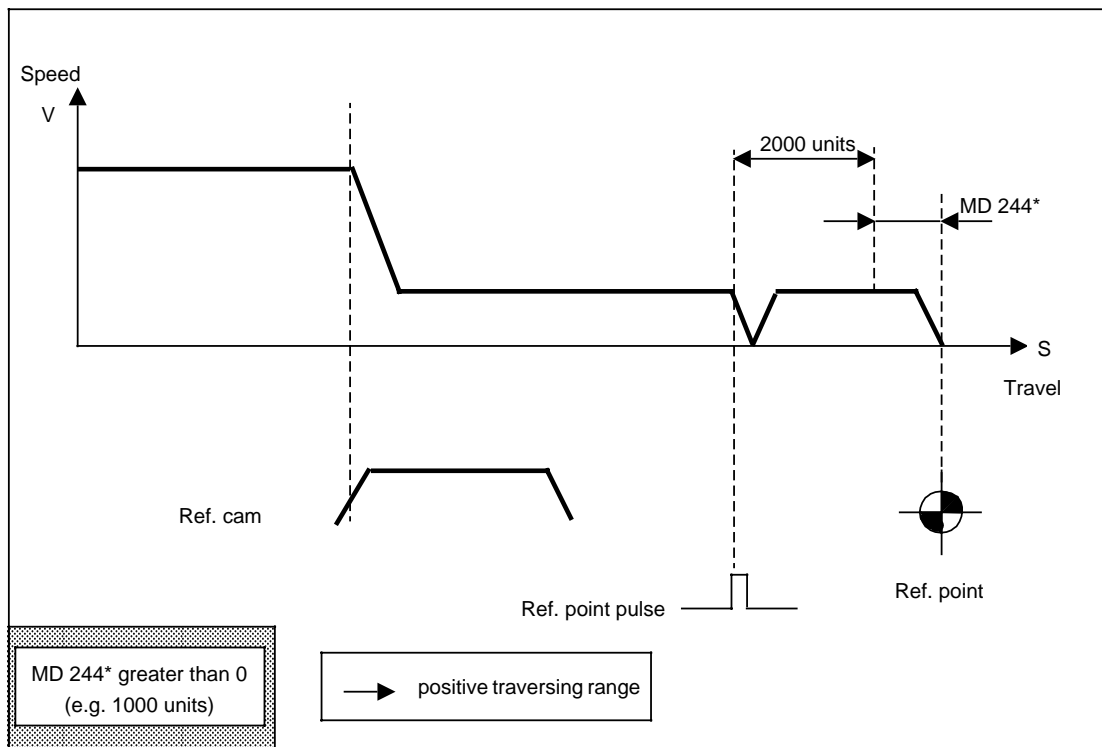

<b>248*</b>	<b>Tool reference value (available soon)</b>			<b>248*</b>
Standard value	Lower input limit	Upper input limit	Units	
<b>0</b>	<b>-99 999 999</b>	<b>99 999 999</b>	<b>units (IS)</b>	

**Active: When all channels of the mode group are in STOP state**

For machines with tool measuring attachments, the reference point of the measuring attachment relative to the machine zero must be known for automatic determination of the tool geometry data.

The absolute position of the crosshair must be input.

<b>252*</b>	<b>Servo gain factor (Kv factor)</b>			<b>252*</b>
Standard value	Lower input limit	Upper input limit	Units	
<b>1 666</b>	<b>0</b>	<b>10 000<sup>1)</sup></b>	<b>0.01 s<sup>-1</sup></b>	

**Active: When all channels of the mode group are in STOP state**

When inputting the servo gain factor, it must be borne in mind that the gain factor of the overall position control loop is dependent on other control loop parameters. Strictly speaking therefore, a distinction must be made between a "desired servo gain factor" (above NC MD) and an "actual servo gain factor" (obtained at the machine). Only if all control loop parameters have been correctly adjusted with respect to each other are these servo gain factors equal. These parameters are as follows:

- Max. speed (MD 280\*)
- Multgain (NC MD 260\*)
- Tacho-generator compensation at speed controller
- Tacho-generator at drive

The input value of 1 666 is equivalent to a servo gain factor of 1.

**Notes:**

Axes to work together in continuous-path operation **must** exhibit precisely the same gain in the position control loop (i.e. same speed same following error = 45° inclination).

Any deviations will result in contour defects!

Only axes **never** contributing to continuous-path operation may be defined with different values (determination of servo gain factor). The actual servo gain factor can be checked using the following error (in the service displays). Please note that using the following error (in the service displays). Please note that drift compensation must be performed before the check is made.

1) Multgain factor • servo gain factor must be <3.9 • 10<sup>8</sup>.

<b>260*</b>	<b>Multgain</b>			<b>260*</b>
Standard Value	Lower input limit	Upper input limit	Units	
<b>2400</b>	<b>0</b>	<b>64 000*</b>	<b><math>\frac{\text{min.}}{1000 \text{ units}}</math> (MS)</b>	

**Active: When all channels of the mode group are in STOP state**

The multgain factor serves to match the controlled system to the servo gain factor specified via NC-MD 252\*. Multgain is a strict multiplication factor for the entered servo gain factor entered and should be used as **digital tachogenerator matching** in view of the very fine adjustment facilities.

After correct input or matching of the multgain, a servo gain factor corresponding precisely to the input value must be set for the axis concerned.

**Note:**

Matching the actual servo gain factor using the servo gain factor NC MD (NC MD 252\*) is not to be recommended since different input values would then be obtained for the individual axes, although all axes would have the same gain in the position control loop.

$$\text{Multgain} = \frac{3 \cdot 10^7}{V_{\max} [\text{1000 units/min}]} \cdot \frac{U_{\max} [\text{V}]}{10 [\text{V}]}$$

$V_{\max}$  ... Maximum axis speed NC MD 280\*

$U_{\max}$  ... Set speed voltage at maximum axis speed

Maximum speed [ 1000 units/min ]	Maximum set speed		
	4 volts	8 volts	9 volts
24000	–	1000	1125
22000	–	1090	1227
20000	–	1200	1350
18000	–	1332	1500
16000	–	1500	1687
15000	–	1600	1800
14000	–	1714	1928
12000	–	2000	2250
10000	–	2400	2700
8000	–	3000	3375
6000	–	4000	4500
5000	2400	4800	5400
4000	3000	6000	6750
3000	4000	8000	9000
2000	6000	12000	13500
1000	12000	24000	27000
750	16000	32000	36000
500	24000	48000	–
375	32000	–	–
187	64000	–	–

\* Note on the input limit  
Multgain [NC MD 260\*] · servo gain factor s [NC MD 252\*] < 3.9 · 10<sup>8</sup>

<b>264*</b>	<b>Threshold for drive error (up to Software Version 4)</b>		<b>264*</b>
Standard value	Lower input limit	Upper input limit	Units
<b>9 600</b>	<b>0</b>	<b>15 000</b>	<b>VELO</b>

The specified set speed is monitored. Alarm 156\* is activated if the specified set speed is too high (measuring circuit and drive error).

The input value must be greater than the highest definition amount entered under NC MD 268\* for the maximum set speed.

**Guide value**

Approx. 20 % higher than NC MD 268\*

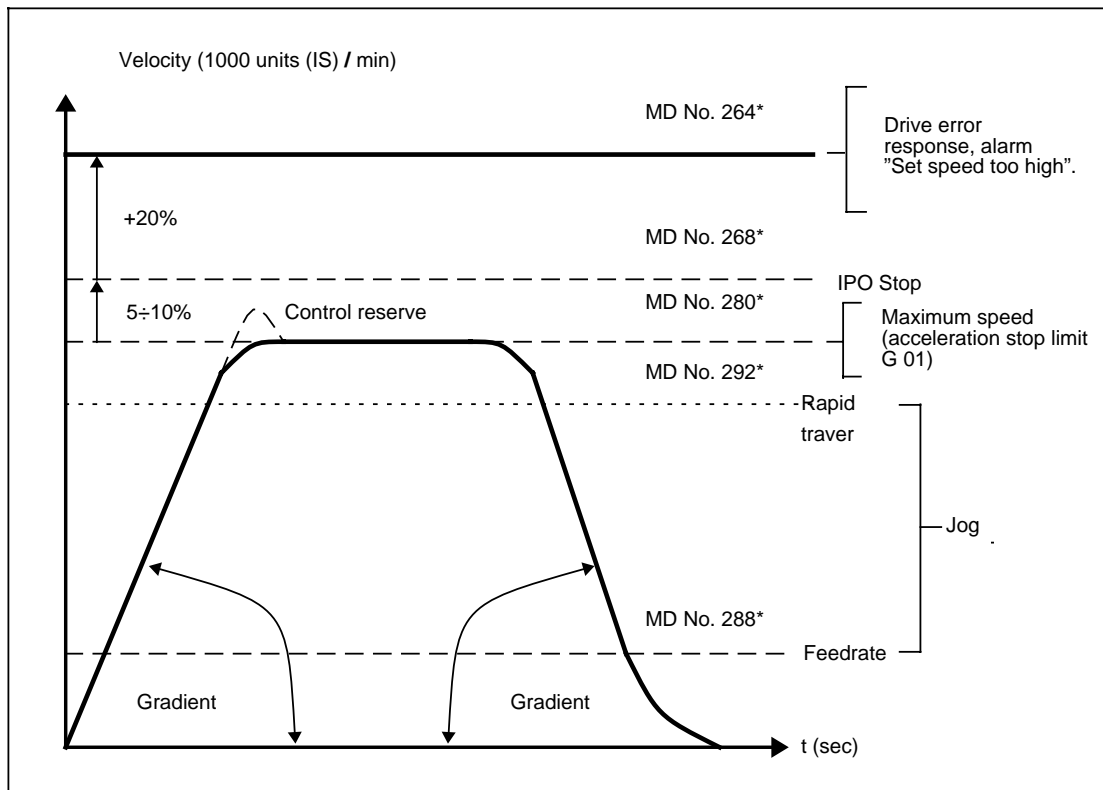



Examples for MD 200*:	
00 00 00 00	Axis not available on the machine (only permissible with NC MD 564* bit 7 = 0)
01 01 01 00	1st measuring circuit module, 1st encoder, 1st servo CPU
02 03 02 00	2nd measuring circuit module, 3rd encoder, 2nd servo CPU
10 01 04 00	10th measuring circuit module, 1st encoder, 4th servo CPU

**Caution:**

The following values apply if integrated drive control is used (IAR from Software Version 5):

<b>264*</b>		<b>Threshold for drive errors (from Software Version 5)</b>		<b>264*</b>	
Standard value	Lower input limit	Upper input limit	Units		
<b>12 000</b>	<b>0</b>	<b>500 000</b>	<b>1000 units/ min (IS)</b>		

**Active: When all channels of the mode group are in STOP state**

The specified setpoint speed is monitored. Alarm 156\* is triggered when too high a setpoint speed has been specified (measuring circuit and drive error).

The amount entered must be greater than the greatest definition amount of the maximum setpoint speed entered in NC MD 268\*.

**Guide value**

Approx. 20% greater than NC MD 268\*

<b>268*</b>	<b>Maximum set speed (IPO Stop) (up to Software Version 4)</b>		<b>268*</b>
Standard value	Lower input limit	Upper input limit	Units
<b>8 192</b>	<b>0</b>	<b>8 192</b>	<b>VELO</b>

This input specifies the maximum voltage value to be output as the set speed. This maximum value depends on any existing setpoint limits in the speed controller (usually 10 V). Alarm 104\* (DAC limit reached) is given when the limit is exceeded.

**Caution!**

It must, however, be possible to reach the maximum speed (rapid traverse) safely, i.e. tachogenerator compensation is to be performed such that reading and adjustment inaccuracies as a result of speed fluctuations during operation do not result in the IPO Stop limit being reached (e.g. maximum speed = 9 to 9.5 V).

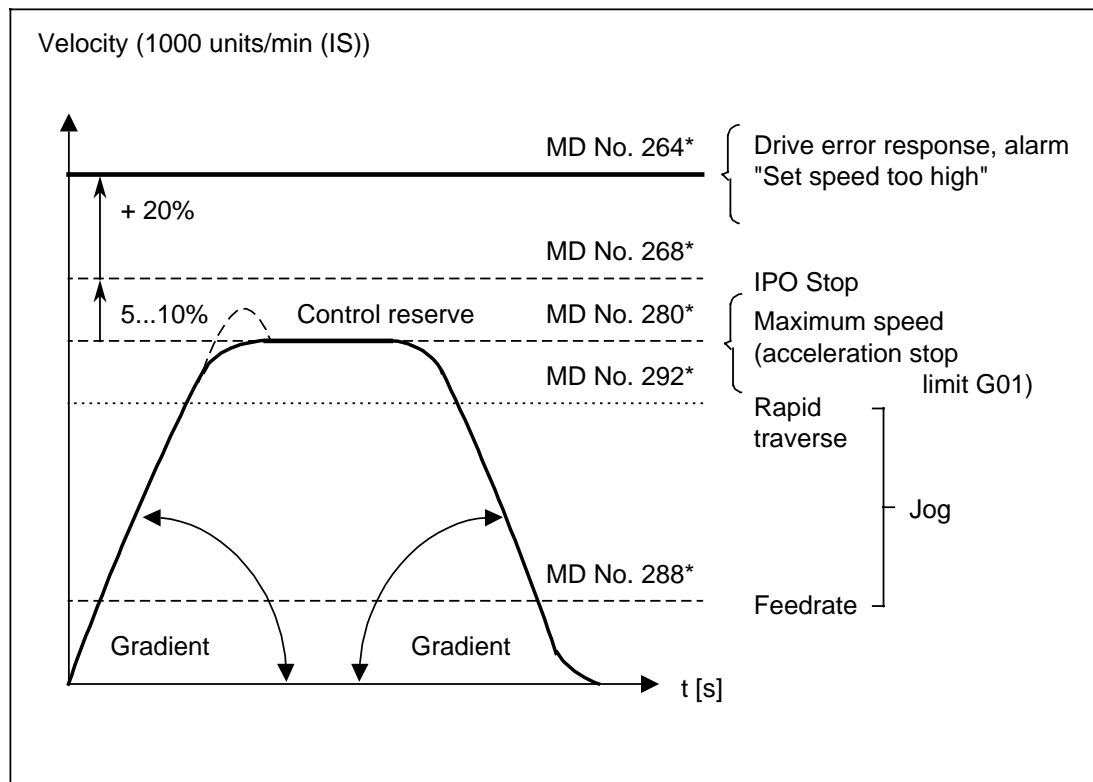

<b>268*</b>	<b>Maximum set speed (IPO Stop) (from Software Version 5)</b>			<b>268*</b>
Standard value	Lower input limit	Upper input limit	Units	
<b>10000</b>	<b>0</b>	<b>500000</b>	<b>1000 units / min (IS)</b>	

This input specifies the maximum set speed for the axis. The maximum value depends on any existing setpoint limits in the speed controller.

If this limit is exceeded, the interpolator is interrupted.

<b>272*</b>	<b>Drift compensation</b>			<b>272*</b>
Standard value	Lower input limit	Upper input limit	Units	
<b>0</b>	<b>-500</b>	<b>500</b>	<b>VELO</b>	

**Active: When all channels of the mode group are in STOP state**

The temperature drift of analog electronic components (primarily in the motor control unit) causes the axes to wander from their set position until the counter-setpoint is so great on account of the existing following error that it corresponds to the temperature drift.

If the green LED  no longer goes off although the axis is turning, the following error caused by the drift has taken on such a large value that a drift compensation has become necessary otherwise the axes will no longer be able to be moved. Drift compensation must be entered manually and modified until the following error at rest has settled at approximately 0.

From Software Version 3 semi-automatic drift compensation is possible (see Section 5.3).

<b>276*</b>		<b>Acceleration</b>		<b>276*</b>	
Standard value	Lower input limit	Upper input limit	Units		
<b>50</b>	<b>0</b>	<b>4000</b>	<b>10 000 units (IS)</b> <b>s<sup>2</sup></b>		

**Active: Immediately**

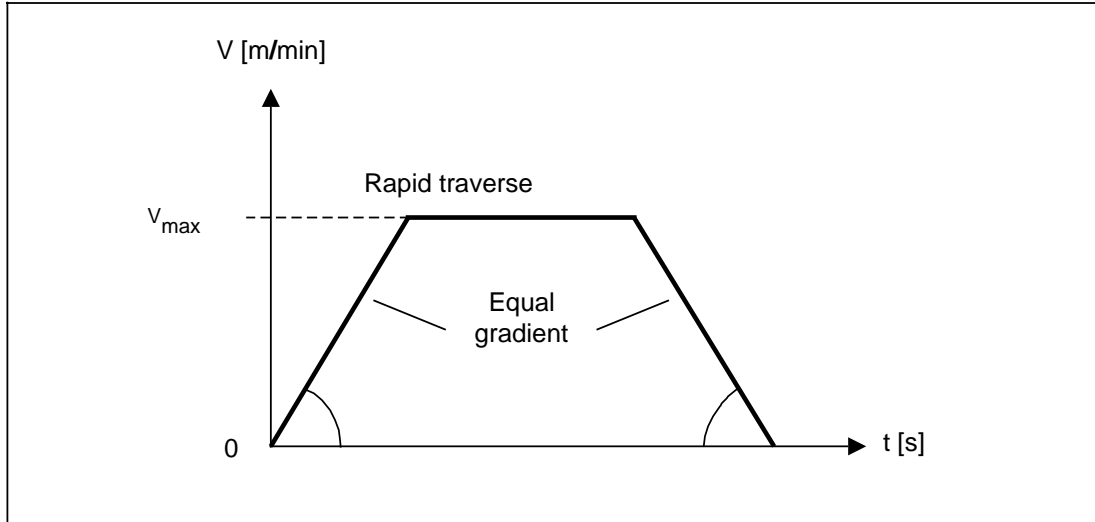

*Acceleration and braking characteristic*

The axes need not be set to equal acceleration values. The controller assumes the lowest acceleration value of the interpolating axes involved. The values also apply to deceleration (braking).

The acceleration in NC MD 276\* is active on every acceleration or braking process (speed change) of the axis.

**Exception:**

On reference point approach the axis is braked as fast as possible on reaching the zero mark. For this reason a small value must be selected for the reference point creep speed (NC MD 284\*). If alarms occur the axis concerned is also braked as fast as possible (see also alarm description).

**Note:**

Values of 50 ... 150 (= 0.5 ... 1.5 m/s<sup>2</sup>) are usual for a standard machine. For rotary axes the angular acceleration must be entered here.

<b>280*</b>	<b>Maximum speed</b>			<b>280*</b>
Standard value	Lower input limit	Upper input limit	Units	
<b>10 000</b>	<b>0</b>	<b>4 900 000</b>	<b><math>\frac{1000 \text{ units}}{\text{min}}</math> (IS)</b>	

**Active:** When all channels of the mode group are in STOP state

**Caution:**

The following values apply if integrated drive control is used

<b>280*</b>	<b>Maximum speed</b>			<b>280*</b>
Standard value	Lower input limit	Upper input limit	Units	
<b>10 000</b>	<b>0</b>	<b>4 900 000</b>	<b><math>\frac{1000 \text{ units}}{\text{min}}</math> (IS)</b>	

The limit speed up to which the axis may accelerate (**rapid traverse limit**) is entered. Traversing is performed at this speed with programmed rapid traverse G00. This MD is also used to calculate multigain. All programmed and entered speeds are referenced to this MD.

The maximum permissible speed depends on the position control resolution, the input resolution and the interpolation time (see NC MD 1800\*).

<b>284*</b>	<b>Reference point cutoff speed</b>			<b>284*</b>
Standard value	Lower input limit	Upper input limit	Units	
<b>300</b>	<b>0</b>	<b>4 900 000</b>	<b><math>\frac{1000 \text{ units}}{\text{min}}</math> (IS)</b>	

**Active:** When all channels of the mode group are in STOP state

The cutoff speed is active during approach to the reference point as soon as the reducing cam is reached, i.e. the "Deceleration" signal is active (see NC MD 244\*). The feedrate override switch is not taken into account, except in the first position (0%). The value input must not exceed the maximum speed (NC MD 280\*) (for reference point approach see also Section 11.3).

**Guide value:**

A reasonable upper limit is 1 m/min, but values between 100 and 500 mm/min are better, depending on the servo gain factor.

<b>288*</b>		<b>Feed jog</b>		<b>288*</b>	
Standard value	Lower input limit	Upper input limit	Units		
<b>2 000</b>	<b>0</b>	<b>4 900 000</b>	<b>1000 units</b> <b>min (IS)</b>		

**Active: When all channels of the mode group are in STOP state**

The input value applies to travel in JOG mode with the feedrate override switch in the 100% position. The value entered must not exceed the max. speed (NC MD 280\*).

<b>292*</b>		<b>Rapid jog</b>		<b>292*</b>	
Standard value	Lower input limit	Upper input limit	Units		
<b>5 000</b>	<b>0</b>	<b>4 900 000</b>	<b>1000 units</b> <b>min (IS)</b>		

**Active: When all channels of the mode group are in STOP state**

The input value applies to travel in JOG mode with the rapid traverse override key actuated and with the rapid traverse override switch in the 100% position.

The value entered must not exceed the max. speed (NC MD 280\*).

This value is not used for programmed rapid traverse G00. Programmed rapid traverse G00 is specified by the maximum speed NC MD 280\*.

**Guide value:**

A value lower than rapid traverse G00 should be selected to make allowance for the operator's response time.

<b>296*</b>		<b>Reference point approach speed</b>		<b>296*</b>	
Standard value	Lower input limit	Upper input limit	Units		
<b>10 000</b>	<b>0</b>	<b>4 900 000</b>	<b>1000 units</b> <b>min (IS)</b>		

**Active: When all channels of the mode group are in STOP state**

If the direction key leading to the reference point (selectable using NC MD 564\*) is depressed in "reference point approach" mode, the axis accelerates to the reference point approach speed (exception: axis already at deceleration cam or automatic reference point approach selected, see also NC MD 244\*).

The value entered must not exceed the max. speed (NC MD 280\*).

For reference point approach see also Section 11.3.

<b>300*</b>	<b>Incremental feedrate</b>			<b>300*</b>
Standard value	Lower input limit	Upper input limit	Units	
<b>500</b>	<b>0</b>	<b>4 900 000</b>	<b>1000 units min (IS)</b>	

**Active: When all channels of the mode group are in STOP state**

The input feedrate is active only with incremental feed (INC1 ... 10 000).  
 The value entered must not exceed the max. speed (NC MD 280\*).

The feedrate during traversing with the handwheel in modes INC1 ... 10 000 is determined exclusively by the handwheel.

From Software Version 5 with ELG: "On-the-fly synchronization between LA/FA".

The following axis traverses the established path difference to the synchronization position as an overlay movement at incremental velocity.

<b>304*</b>	<b>Interpolation parameter</b>			<b>304*</b>
Standard value	Lower input limit	Upper input limit	Units	
<b>1</b>	<b>0</b>	<b>3</b>	<b>-</b>	

**Active: In next block**

In the case of circular movements (G2/G3) and thread cutting (G33, G34, G35), the individual axes must be assigned an interpolation parameter:

- 0 = No interpolation parameter
- 1 = Interpolation parameter I for 880 M/ T
- 2 = Interpolation parameter J for 880 M
- 3 = Interpolation parameter K for 880 M/ T

Standard MD: X axis ..... I  
 Y axis ..... J  
 Z axis ..... K

A number of axes may bear the same interpolator name.

**Programming for same interpolator names:**

G2 X5 C10 J20 J20 LF

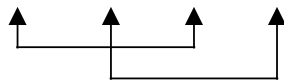

Assignment: 1st interpolator to 1st programmed axis  
 2nd interpolator to 2nd programmed axis

Axes without interpolator names cannot perform circular movements, helical movements and thread cutting.



<b>308*</b>	<b>Cutoff frequency of C axis encoder (from Software Version 5)</b>			<b>308*</b>
Standard value	Lower input limit	Upper input limit	Units	
<b>500</b>	<b>0</b>	<b>16 000</b>	<b>kHz</b>	

**Active: After POWER ON**

The cutoff frequency of the actual-value encoder for the C axis is entered in the machine data, the value being taken from the manufacturer's documentation.

If the cutoff frequency is exceeded it is possible for pulses from the encoder to be lost; which will cause an error in the actual value acquisition. The C axis mode cannot be used any more.

If the critical frequency is not exceeded, the C axis is automatically resynchronized. The interface signal "spindle synchronized" changes from 0 1.

- The defined servo gain factor (MD 252\*) must correspond to the actual condition if the cutoff frequency monitoring is to function correctly (check following error).

<b>312*</b>	<b>Feedforward control factor (from Software Version 5)</b>			<b>312*</b>
Standard value	Lower input limit	Upper input limit	Units	
<b>0</b>	<b>0</b>	<b>1000</b>	<b>0.1 %</b>	

With the help of the feedforward control, the synchronous error resulting from the following error between the following axis and the leading axes should be greatly reduced.

In the feedforward control, the part set value multiplied by the feedforward control factor is taken directly to the speed controller input. It is applied to the input of the position controller directly in the case of static feedforward control or with a PT-1 element delayed by the time constant specified in machine data (392\*) in the case of dynamic feedforward control. If the feedforward control factor 0 is entered, no feedforward control is calculated for the relevant axis.

In order to activate the feedforward control, MD 5016 bit 0 must be set.

The feedforward control factor can be adapted according to the machine stability and the acceleration/deceleration of the axis. The following error reduces in accordance with the feedforward control factor when feedforward control is applied.

A factor of 1000 in the steady state corresponds to a following error of virtually 0. Note however that overshoots occur with this setting. If this is not desired, a correspondingly lower value must be entered and the time constant for the feedforward control must be entered in MD 392\*.

The effect of this MD can be seen from the service display of the FA by considering the following error.

<b>316*</b>	<b>Pointer compensation (+)</b>			<b>316*</b>
Standard value	Lower input limit	Upper input limit	Units	
<b>0</b>	<b>0</b>	<b>249</b>	<b>MD offset*)</b>	

**Active: After POWER ON**

The NC activates leadscrew error compensation after reaching the reference point. Consequently, the CNC must be informed by means of MD 316\* as to which of the 1000 - 2000 possible compensation points represents the reference point for the axis in question (see Section 11). If leadscrew error compensation is not direction-dependent, the same value 316\* must also be entered in MD 320\* (for leadscrew error compensation see Section 11).

<b>320*</b>	<b>Pointer compensation (-)</b>			<b>320*</b>
Standard value	Lower input limit	Upper input limit	Units	
<b>0</b>	<b>0</b>	<b>249</b>	<b>MD offset**)</b>	

**Active: After POWER ON**

If leadscrew error compensation is direction-dependent, the compensation curves are separate for positive and negative traversing movements. Consequently, 2 compensation indicators (MD 316\* for "+" and MD 320\* for "-") are also required. The value refers to the compensation point corresponding to the reference point (for leadscrew error compensation see Section 11).

\*) MD offset signifies instead 6127 127 for axes on servo CPU 1  
 6300 50 for axes on servo CPU 2  
 \*\*) MD offset signifies instead 6028 028

<b>324*</b>		<b>Distance between two leadscrew error compensation points</b>		<b>324*</b>	
Standard value	Lower input limit	Upper input limit	Units		
<b>0</b>	<b>0</b>	<b>32 000</b>	<b>units (MS)</b>		

**Active: After POWER ON**

The distance between two grid elements in leadscrew error compensation is based on the following:

- Permissible tolerance band
- Maximum pitch of the sum check error characteristic of the spindle/measuring system
- (Maximum number of compensation points

(for leadscrew error compensation s see also Section 11).

<b>328*</b>		<b>Leadscrew error compensation value</b>		<b>328*</b>	
Standard value	Lower input limit	Upper input limit	Units		
<b>0</b>	<b>0</b>	<b>100</b>	<b>units (MS)</b>		

**Active: After POWER ON**

The compensation value depends on the permissible tolerance band for the axis position. The value for the tolerance band or a slightly smaller value is input to make use of the full bandwidth for each compensation (for leadscrew error compensation s see also Section 11).

<b>332*</b>	<b>Contour control tolerance band</b>		<b>332*</b>
Standard value	Lower input limit	Upper input limit	Units
<b>1000</b>	<b>0</b>	<b>32 000</b>	<b>units (MS)</b>

**Active: When all channels of the mode group are in STOP state**

The following error is proportional to the speed after acceleration or deceleration (i.e. in the steady state), so no fluctuations in the following error must develop at constant speed as this would result in contour deviations. However, minor fluctuations in the following error triggering control processes are allowed.

Entering a tolerance band is intended to prevent false tripping of the contour control due to slight hunting resulting from operational control processes.

The input value for the required tolerance band can be determined from the following set of curves (with position control resolution 0,5 µm): For an exact description see Section 3.8.

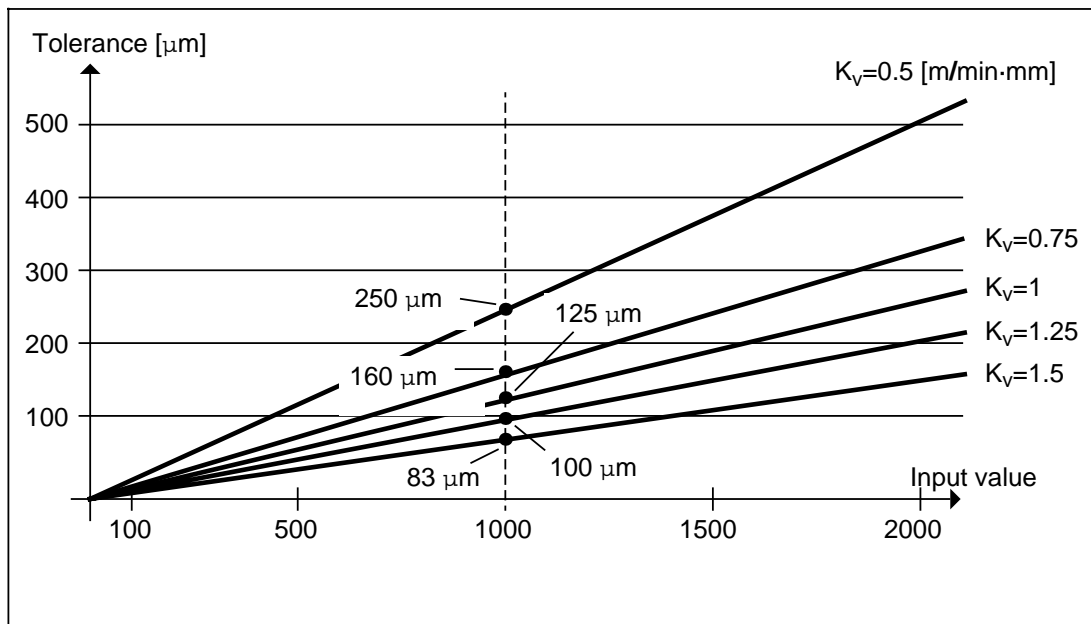

<b>336*</b>		<b>Contour threshold speed</b>		<b>336*</b>	
Standard value	Lower input limit	Upper input limit	Units		
<b>5</b>	<b>0</b>	<b>16 000</b>	<b>1000 units min (IS)</b>		

**Active: When all channels of the mode group are in STOP state**

The speed above which contour control is to be active is input. No contour control is active below this axis-specific threshold speed. With the axis at a standstill, the zero-speed control monitors excessive axis movements (Alarm 112\*). See Section 3.8 for a detailed description.

<b>340*</b>		<b>Tool change position</b>		<b>340*</b>	
Standard value	Lower input limit	Upper input limit	Units		
<b>0</b>	<b>-99 999 999</b>	<b>99 999 999</b>	<b>units (MS)</b>		

**Active: After POWER ON**

For SINUMERIK 880T only the following applies:

In the tool change cycle, the maximum retract position at which collision-free tool changing is possible is calculated by the NC from the tool and workpiece data. This NC MD makes it possible to specify a maximum retract position, e.g. to protect machine parts located behind.

<b>344*</b>		<b>Rotary axis modulo value for leadscrew error compensation</b>		<b>344*</b>	
Standard value	Lower input limit	Upper input limit	Units		
<b>0</b>	<b>-92 160 000</b>	<b>92 160 000</b>	<b>units (MS)</b>		

**Active: When all channels of the mode group are in STOP state**

From Software Version 6.1, the modulo value is also active with the "C axis on-the-fly synchronization". For this, the value must be set correctly according to the position controller resolution (3 600, 36 000, 360 000, 3 600 000, 36 000 000).

The value of the compensation area for a rotary axis is to be input. A value of 360 000 (=One revolution of the rotary table) is usually a practical value.  
 If values greater than 360 000 are input it is important to make sure that a corresponding number of leadscrew error compensation points is made available (for lead screw error compensation see Section 11).

**If ELG is used: (from Software Version 5)**

If the following axis is a rotary axis the modulo value of the rotary axis must entered in MD 344\*. 360 000 is usually a practical value.

<b>348*</b>	<b>Minimum working range for simulation (from Software Version 3)</b>		<b>348*</b>
Standard value	Lower input limit	Upper input limit	Units
<b>- 5000</b>	<b>- 999 999</b>	<b>0</b>	<b>0.3 mm or inch</b>

<b>352*</b>	<b>Maximum working range for simulation (from Software Version 3)</b>		<b>352*</b>
Standard value	Lower input limit	Upper input limit	Units
<b>5000</b>	<b>0</b>	<b>999 999</b>	<b>0.3 mm or inch</b>

**Active: After simulation start**

The machine data specify the value range for each NC axis in simulation:  
 For every NC axis there is a minimum and a maximum value. Only the machine data of the axes which are being simulated are relevant. In double-slide simulation the working range is defined by the axis of the first simulation channel. The unit depends on NC MD 5002 bit 4.

It is important to make sure that the resolution is inversely proportional to the working range. If you wish to observe details of the simulation, select the working range to be as small as possible. Moreover you must select working range so that all absolute values move within this area. The absolute value can be composed of the following components.

Absolute value =    programmed value  
                           + settable zero offset  
                           + programmable zero offset  
                           + length correction (LK)  
                           + tool nose/cutter radius compensation (TNRC/CRC)

Internally the simulation space is selected to be twice as large as the working range so that circles whose centre are outside the working range can be calculated. The centre of the working range (max. working range + min. working range) / 2) of the facing axis on turning machines must be 0, i.e.: max. working range = - (min. working range). The resolution is determined by the simulation axis with the largest working range. This gives the smallest unit of simulation with:

**Example:**

$$\frac{\text{max. working range} - \text{min. working range}}{32768}$$

$$\frac{+16 \text{ m} - (-16 \text{ m})}{32768}$$

If the display area on the screen is 550 pixels, a window size results for which the resolution (smallest unit of simulation) is exactly 1/2 pixels. This is the limit value from which the calculation precision can affect the display.

$$1 \text{ Pixel} = 2 \cdot (\text{smallest simulation unit})$$

$$\text{Window} = 550 \text{ Pixel} = 1100 (\text{smallest simulation unit})$$

$$= 1100 \cdot \frac{\text{max. working range} - \text{min. working range}}{32768}$$

$$= \frac{\text{max. working range} - \text{min. working range}}{30}$$

The smallest simulation window with which impositions are not yet visible is the 30th part of the size of the working range. The smallest unit which can be displayed (= 1 Pixel) then corresponds to the 16500th part of the size of the working range.

<b>360*</b>	<b>Axis valid in mode group</b>			<b>360*</b>
Standard value	Lower input limit	Upper input limit	Units	
<b>1</b>	<b>1</b>	<b>8</b>	<b>-</b>	

**Active: After warm start**

This NC MD is used to specify axis allocation to the individual mode groups, i.e. a channel only traverses the axes of its own mode group and not those of other groups. Within any one mode group, several channels can process an axis consecutively, provided that axial synchronization of the block end value is performed for this axis (NC STOP NC START) if previously traversed by another channel.

Up to Software Version 2: Mode group without axes are **not** permissible (Alarm 3023 on NC START).

From Software Version 3: Mode group without axes are permissible.

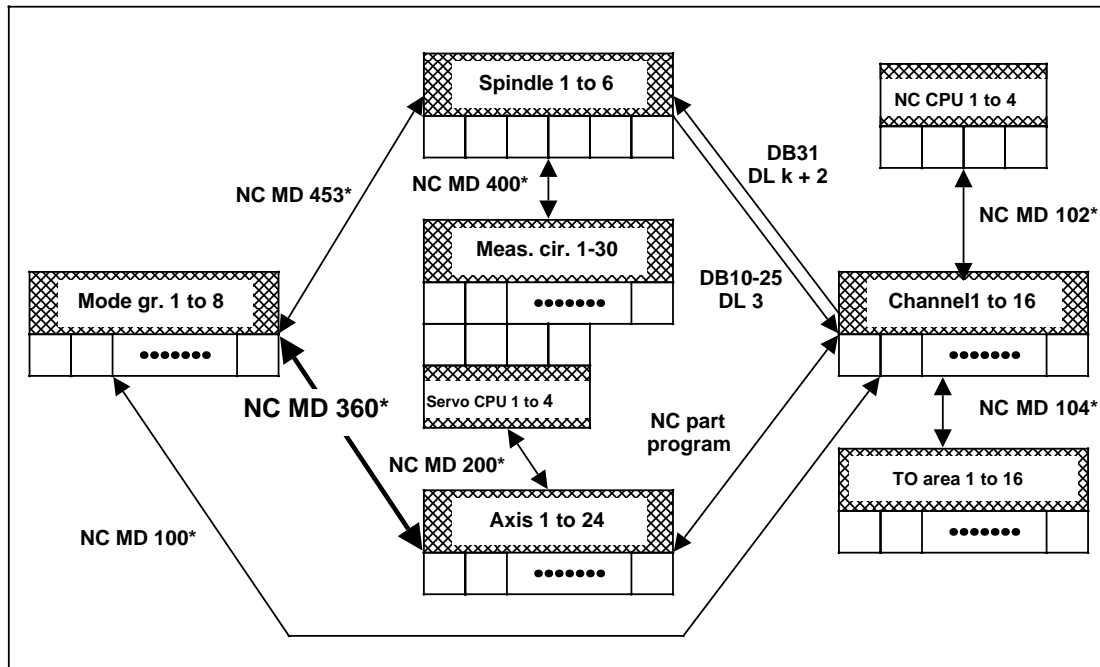

With the warm start function, axes can be placed in another mode group without having to carry out a hardware reset. The reference point of the axes is not lost (for warm restart see also Section 11.6).



<b>364*</b>	<b>Pulses for variable increment weighting</b>			<b>364*</b>
Standard value	Lower input limit	Upper input limit	Units	
<b>1</b>	<b>0</b>	<b>65 000</b>	<b>-</b>	

**Active: After RESET**

For description see also NC MD 368\*.

To produce a closed position control loop it is necessary to atune the pulses coming from the digital measuring system and the position control resolution to one another.

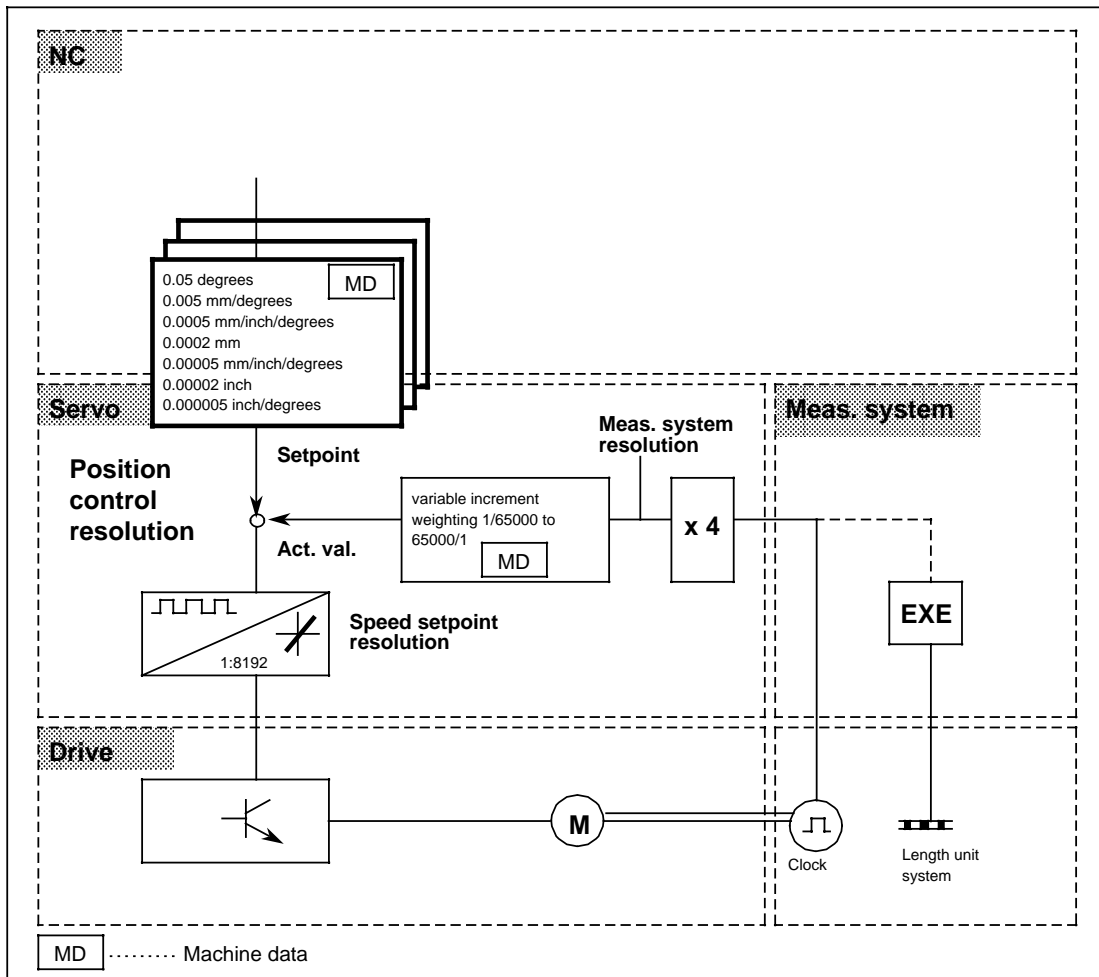

For the connection between display resolution, input resolution and position control resolution see NC MD 5002 or 1800\*.

**Caution:**

This machine data has another meaning if integrated drive control is used.

<b>368*</b>	<b>Travel for variable increment weighting</b>		<b>368*</b>
Standard value	Lower input limit	Upper input limit	Units
<b>1</b>	<b>0</b>	<b>65 000</b>	<b>-</b>

**Active: After RESET**

Variable pulse weighting (MD 364\*, MD 368\*):

In order to generate a closed position control loop, the pulses from the digital measuring system and the position control accuracy of the controller must be matched to one another. This can be done using the following parameters:

Parameter	Symbol	Significance
Position control resolution	b	Position control resolution of controller
Leadscrew pitch (lead)	s	Pitch of lead screw or for rotary axes fixed at 360 degrees
Pulses per revolution	p	Number of pulses of ROD encoder per revolution
Mechanical gearing	r	Mechanical gearing between motor and ROD encoder (if fitted)
Grating constant	g	Period spacing on a linear scale
EXE multiplier	f	5-fold EXE means that pulses from the scale are multiplied by 5

## Block diagram of the position control parameters

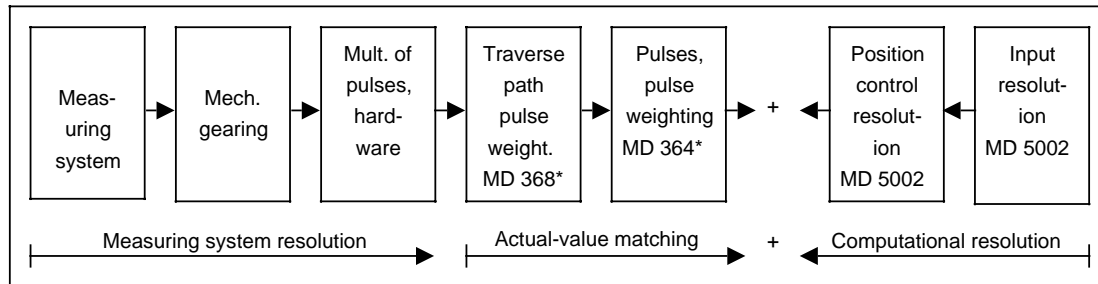

In order to determine machine data 364\* and 368\*, the pulse number for the encoder and appropriate traverse path must be known at the machine. The value of the traverse path is to be entered in MD 368\* as a function of NC MD 5005 (see examples). The pulse number of the encoder for this traverse path multiplied by all subsequent multiplications (EXE, measuring-system gearing, hardware 4-fold multiplication on measuring-circuit module) is to be entered in MD 364\*, provided the machine data values do not exceed 65 000. In this case, both values must be divided by a common multiple.

**Caution:**

This machine data has another meaning if integrated drive control is used.

**Examples illustrating determination of possible position control parameters:**

1. Determination of MD 364\* and 368\*

1.1 The ROD encoder is mounted directly on the leadscrew:

**Example:** s = 10 mm

p = 2500 pulses per revolution

b = 1/2 10<sup>-3</sup> mm

$$\text{MD 368}^* = \frac{s}{b} = \frac{10 \text{ mm}}{1/2 \cdot 10^{-3} \text{ mm}} = 20000 \quad \text{MD 364}^* = p \cdot 4 = 2500 \cdot 4 = 10000$$

1.2 The ROD encoder is mounted on the motor with gearing between the motor and leadscrew:

**Example 1:** s = 0.2 inch

p = 1000 pulses per revolution

r = 1 : 2 ( 2 revolutions of motor = 1 revolution of leadscrew)

b = 1/2 10<sup>-4</sup> inch

$$\text{MD 368}^* = \frac{s \cdot r}{b} = \frac{0.2 \text{ inch} \cdot 1/2}{1/2 \cdot 10^{-4} \text{ inch}} = 2000 \quad \text{MD 364}^* = p \cdot 4 = 1000 \cdot 4 = 4000$$

**Example 2:** Same values as above but b = 1/2 10<sup>-3</sup> mm

$$\text{MD 368}^* = \frac{s \cdot r}{b} = \frac{0.2 \text{ inch} \cdot 25.4 \text{ mm/inch} \cdot 1/2}{1/2 \cdot 10^{-3} \text{ mm}} = 5080 \quad \text{MD 364}^* = p \cdot 4 = 1000 \cdot 4 = 4000$$

1.3 A linear scale with EXE is used:

**Example:** g = 0.02 mm

f = 10

b = 1/2 10<sup>-3</sup> mm

$$\text{MD 368}^* = \frac{g}{b} = \frac{0.02 \text{ mm}}{1/2 \cdot 10^{-3} \text{ mm}} = 40 \quad \text{MD 364}^* = f \cdot 4 = 10 \cdot 4 = 40$$

1.4 A rotary axis is used:

**Example:** p = 18 000 pulses per revolution

f = 5

b = 1/2 10<sup>-3</sup> degrees

$$\text{MD 368}^* = \frac{360}{b} = \frac{360 \text{ degrees}}{1/2 \cdot 10^{-3} \text{ degrees}} = 720000 \quad \text{MD 364}^* = p \cdot f \cdot 4 = 18000 \cdot 5 \cdot 4 = 360000$$

In view of the fact that the values exceed 65 000, both values must be divided by a common factor (e.g. factor=100) MD 368\*=**7200** MD 364\*=**3600**

<b>364*</b>	<b>Pulses for variable increment weighting (up to Software Version 4)</b>			<b>364*</b>
Standard value	Lower input limit	Upper input limit	Units	
<b>1</b>	<b>0</b>	<b>65 000</b>	<b>-</b>	

For description see also NC MD 368\*.

To produce a closed position control loop it is necessary to atune the pulses coming from the digital measuring system and the position control resolution to one another.

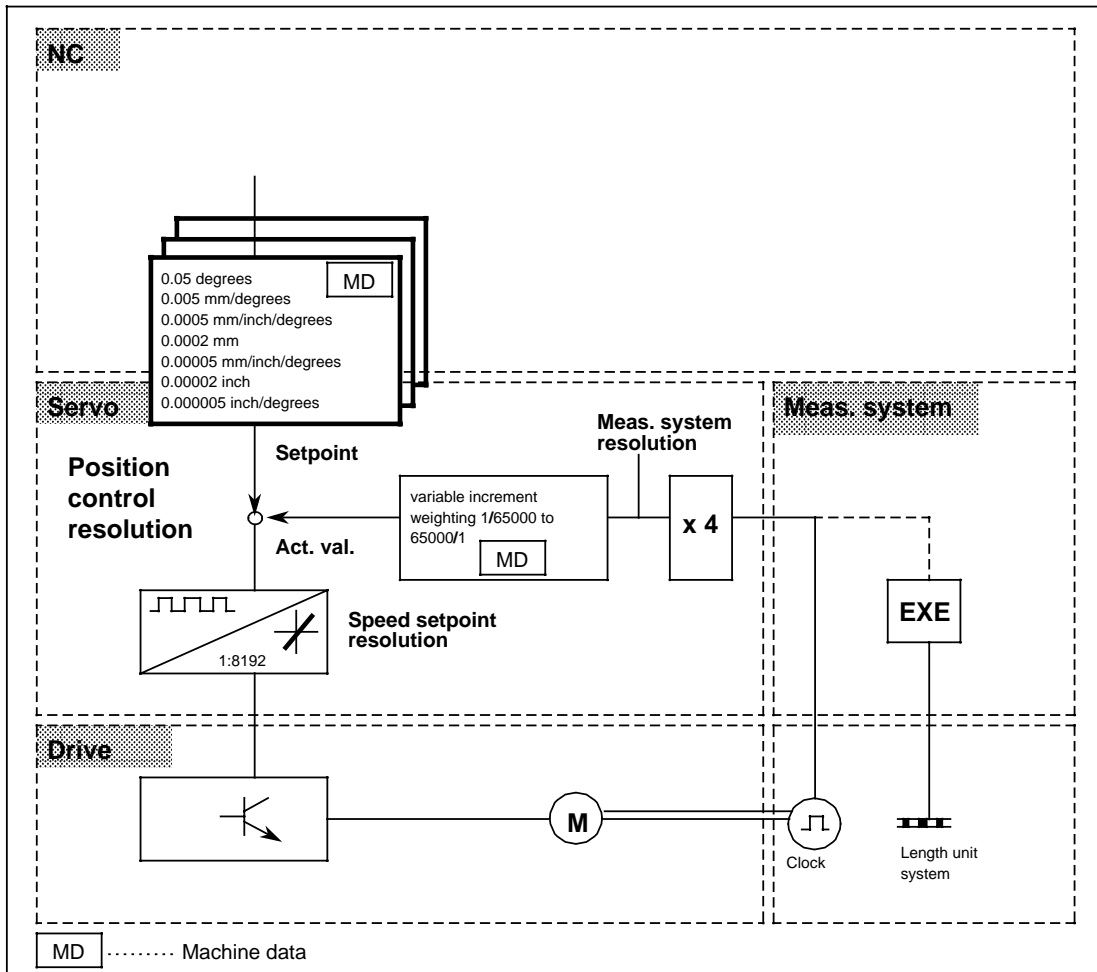

For the connection between display resolution, input resolution and position control resolution see NC MD 5002 or 1800\*.

<b>368*</b>	<b>Travel for variable increment weighting (up to Software Version 4)</b>		<b>368*</b>
Standard value	Lower input limit	Upper input limit	Units
<b>1</b>	<b>0</b>	<b>65 000</b>	<b>-</b>

Variable pulse weighting (MD 364\*, MD 368\*):

In order to generate a closed position control loop, the pulses from the digital measuring system and the position control accuracy of the controller must be matched to one another. This can be done using the following parameters:

Parameter	Symbol	Significance
Position control resolution	b	Position control resolution of controller
Leadscrew pitch (lead)	s	Pitch of lead screw or for rotary axes fixed at 360 degrees
Pulses per revolution	p	Number of pulses of ROD encoder per revolution
Mechanical gearing	r	Mechanical gearing between motor and ROD encoder (if fitted)
Grating constant	g	Period spacing on a linear scale
EXE multiplier	f	5-fold EXE means that pulses from the scale are multiplied by 5

Block diagram of the position control parameter

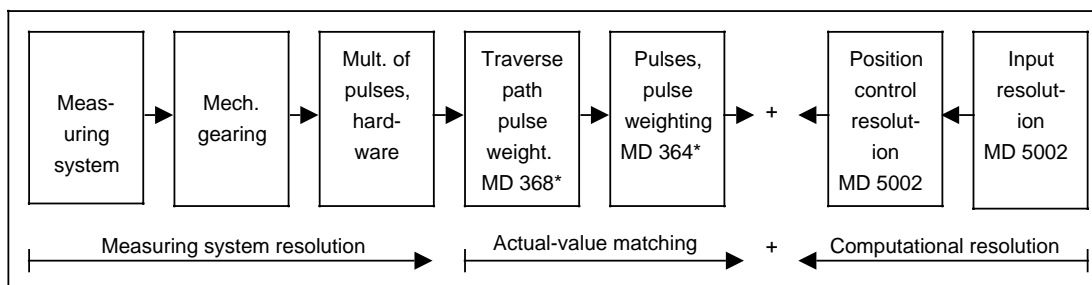

In order to determine machine data 364\* and 368\*, the pulse number for the encoder and appropriate traverse path must be known at the machine. The value of the traverse path is to be entered in MD 368\* as a function of NC MD 5005 (see examples). The pulse number of the encoder for this traverse path multiplied by all subsequent multiplications (EXE, measuring-system gearing, hardware 4-fold multiplication on measuring-circuit module) is to be entered in MD 364\*, provided the machine data values do not exceed 65 000. In this case, both values must be divided by a common multiple.

**Examples illustrating determination of possible position control parameters:  
(up to Software Version 4)**

## 1. Determination of MD 364\* and 368\*

## 1.1 The ROD encoder is mounted directly on the leadscrew:

**Example:**  $s = 10 \text{ mm}$  $p = 2500 \text{ pulses per revolution}$  $b = 1/2 \cdot 10^{-3} \text{ mm}$ 

$$\text{MD 368}^* = \frac{s}{b} = \frac{10 \text{ mm}}{1/2 \cdot 10^{-3} \text{ mm}} = 20000 \quad \text{MD 364}^* = p \cdot 4 = 2500 \cdot 4 = 10000$$

## 1.2 The ROD encoder is mounted on the motor with gearing between the motor and leadscrew:

**Example 1:**  $s = 0.2 \text{ inch}$  $p = 1000 \text{ pulses per revolution}$  $r = 1 : 2 \text{ (2 revolutions of motor = 1 revolution of leadscrew)}$  $b = 1/2 \cdot 10^{-4} \text{ inch}$ 

$$\text{MD 368}^* = \frac{s \cdot r}{b} = \frac{0.2 \text{ inch} \cdot 1/2}{1/2 \cdot 10^{-4} \text{ inch}} = 2000 \quad \text{MD 364}^* = p \cdot 4 = 1000 \cdot 4 = 4000$$

**Example 2:** Same values as above but  $b = 1/2 \cdot 10^{-3} \text{ mm}$ 

$$\text{MD 368}^* = \frac{s \cdot r}{b} = \frac{0.2 \text{ inch} \cdot 25.4 \text{ mm/inch} \cdot 1/2}{1/2 \cdot 10^{-3} \text{ mm}} = 5080 \quad \text{MD 364}^* = p \cdot 4 = 1000 \cdot 4 = 4000$$

## 1.3 A linear scale with EXE is used:

**Example:**  $g = 0.02 \text{ mm}$  $f = 10$  $b = 1/2 \cdot 10^{-3} \text{ mm}$ 

$$\text{MD 368}^* = \frac{g}{b} = \frac{0.02 \text{ mm}}{1/2 \cdot 10^{-3} \text{ mm}} = 40 \quad \text{MD 364}^* = f \cdot 4 = 10 \cdot 4 = 40$$

## 1.4 A rotary axis is used:

**Example:**  $p = 18\,000 \text{ pulses per revolution}$  $f = 5$  $b = 1/2 \cdot 10^{-3} \text{ degrees}$ 

$$\text{MD 368}^* = \frac{360}{b} = \frac{360 \text{ degrees}}{1/2 \cdot 10^{-3} \text{ degrees}} = 720\,000 \quad \text{MD 364}^* = p \cdot f \cdot 4 = 18\,000 \cdot 5 \cdot 4 = 360\,000$$

In view of the fact that the values exceed 65 000, both values must be divided by a common factor (e.g. factor=100)  $\text{MD 368}^* = \mathbf{7200}$   $\text{MD 364}^* = \mathbf{3600}$

**Caution:**

If integrated drive control is used (IAR Software Version 5 ) machine data 364\* and 368\* have the following meaning:

<b>364*</b>	<b>Pulses variable incremental weighting indirect measuring system (from Software Version 5)</b>			<b>364*</b>
Standard value	Lower input limit	Upper input limit	Units	
<b>1</b>	<b>0</b>	<b>16000</b>		

**Active: After RESET**

<b>368*</b>	<b>Traversing path variable incremental weighting indirect measuring system (from Software Version 5)</b>			<b>368*</b>
Standard value	Lower input limit	Upper input limit	Units	
<b>1</b>	<b>0</b>	<b>16000</b>		

**Active: After RESET**

MD 364\* and 368\* are used to adapt the fineness of the indirect measuring system to the axis-specific position control resolution . With the variable incremental weighting, the value of the pulses coming from the measuring system are adapted to the programmed position control resolution of the control.

*In the integrated drive control, machine data MD 364\* and 368\* are also used for weighting the speed information. This is similar to multgain in a standard servo control. These machine data must therefore always be given for integrated drive control.*



In order to determine NC MDs 364\* and 368\*, the traversing path of the axis which corresponds to a certain number of pulses for the indirect measuring system must be known. The value of the traversing path is specified in NC MD 364\* and depends on the position control resolution (NC MD 1800). The corresponding number of pulses of the encoder multiplied by all subsequent multiplication factors must be entered in NC MD 368\*. Common factors must be cancelled.

#### Block diagram of position control parameters:

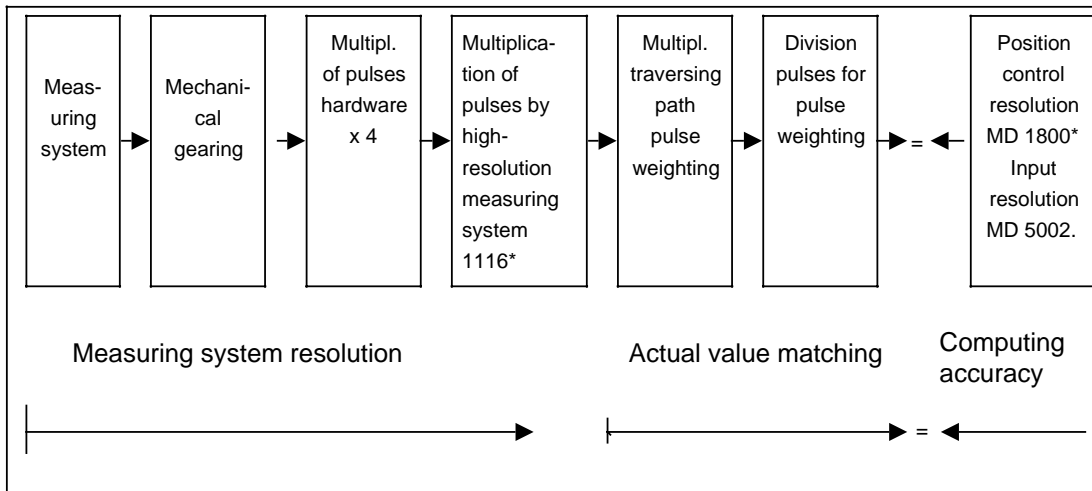

#### Example:

The incremental shaft encoder is attached to the motor and a gearing is to be found between the motor and the ball screw.

Symbol	Meaning
b	Position control resolution of control (NC MD 1800*)
s	Ball screw pitch
p	Number of pulses of rotary measuring system per revolution
r	Mechanical gearing between motor and rotary system
g	Periodic spacing on a linear measuring system
f	Pulse multiplication factor of high resolution measuring system (NC MD 1116*)

S = 10 mm  
n = 2500 pulses per revolution  
b =  $1/2 \cdot 10^{-3}$  mm  
r = 1 : 2 (2 revolutions of motor = 1 revolution of ball screw)  
f = 32

$$\text{NC MD 368}^* = \frac{s \times r}{b} = \frac{10 \text{ mm} \times 1/2}{1/2 \times 10^{-3} \text{ mm}} = 1000$$

that is: 10000 IS increments correspond to 1 motor revolution.

$$\text{NC MD 364}^* = p \times 4 \times f = 2500 \times 4 \times 32 = 320000$$

After cancelling **NC MD 368**\* = 1, **NC MD 364**\* = 32

**Note:**

See also IAR 128\*...132\* for direct measuring system.

372*		Zero-speed control delay		372*	
Standard value	Lower input limit	Upper input limit	Units		
200	0	1 000	ms		

**Active: After POWER ON**

The time after which clamping tolerance NC MD 212\* is activated during positioning (digital zero) is entered in this datum. The time selected must be such that the maximum following error can be suppressed. If this is not the case: Alarm 112\*.

If NC MD 372\* = 0, the value from NC MD 156 "Servo enable cutoff delay" is assumed as the delay for zero-speed control.

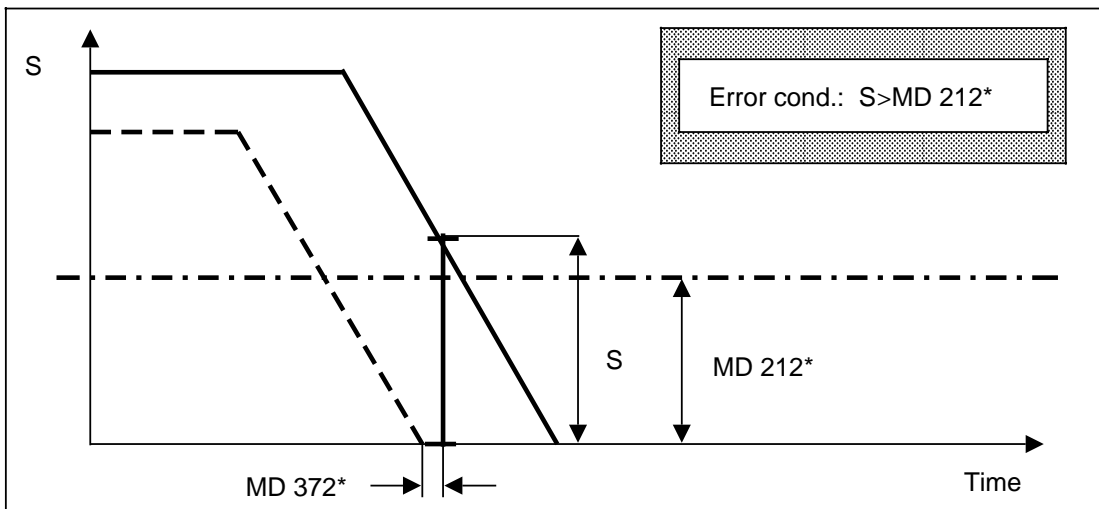
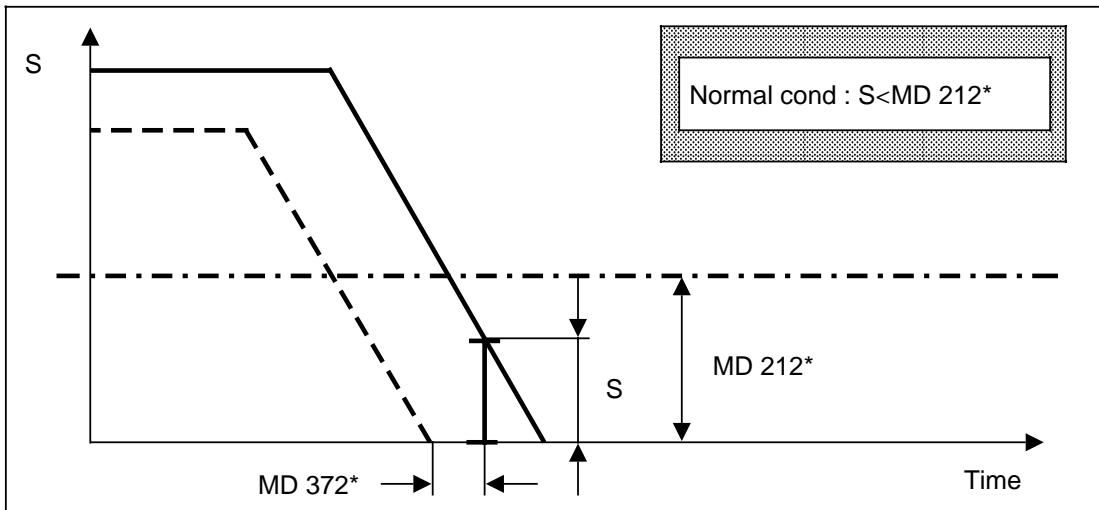

S....following error

**Caution:**

If integrated drive control is used (IAR SV 5), this MD has the following meaning:

<b>384*</b>	<b>Assignment setpoint output (from Software Version 4)</b>			<b>384*</b>
Standard value	Lower input limit	Upper input limit	Units	
<b>see: possible values</b>	<b>0</b>	<b>10030000</b>	<b>-</b>	

**Active: After POWER ON**

In the integrated drive control, axis setpoints are output via the ACC module. The ACC modules can output the setpoints for 3 axes. The setpoints and actual values are permanently assigned to the axes on the ACC module (see next page for connector pin assignment).

The setpoint output of an integrated drive control axis is defined in NC MD 384\* by an 8-digit number. The 4 low-order digits have no significance and are set to zero. The two most significant digits contain the number of the ACC module in the servo local bus (see example). The next digits (places 01 to 03) contain the setpoint output on the ACC module.

MD 384\* also has a significance if SPC measuring circuits are used (from Software Version 4). With free setpoint assignment (e.g. encoder input 1 setpoint output 3), care should be taken that the whole SPC measuring circuit module 6FX 1121-4 is processed by the same servo CPU.

NC MD 384\* format:

ACC module no. (2 digits, 01 ... 10)	Setpoint output on ACC (2 digits 01 ... 03)	Reserved (4 digits 0000)
---	--	-----------------------------

**Example:**

1st module in servo local bus:           measuring circuit  
2nd module in servo local bus:           measuring circuit  
3rd module in servo local bus:           1st ACC module

The ACC module no. here is 3. The first setpoint output on the first ACC module is therefore defined in MD 384\* as follows:

MD 384\* = 03 01 00 00           (in the example 1st ACC module, 1st setpoint output)

<b>Further examples:</b>	
00 00 00 00	Axis on the machine not available (only permissible with NC MD 564* bit 7 = 0).
02 03 00 00	ACC    2nd module, 3rd ACC setpoint output
10 01 00 00	ACC    10th module, 1st ACC setpoint output

**Connector pin assignment on ACC module**

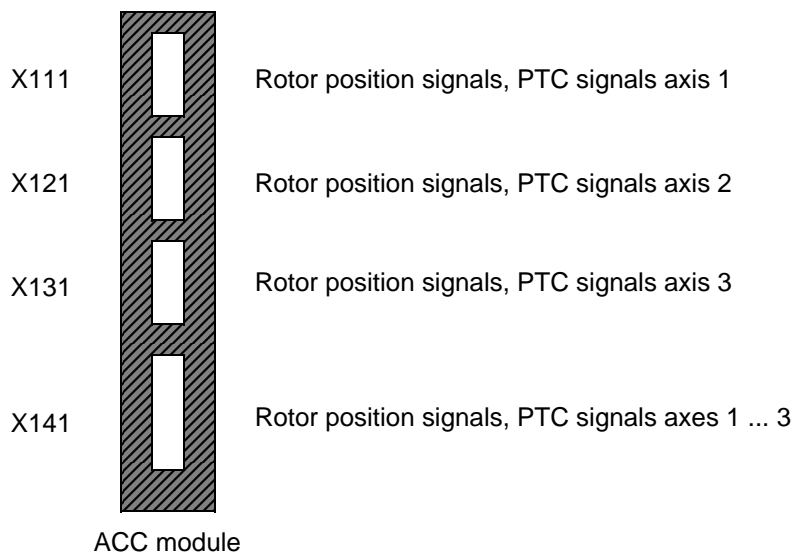

The offset between the encoder absolute value and the machine absolute value is entered in NC MD 396\*.

<b>388*</b>	<b>Weighting factor (from Software Version 03)</b>		<b>388*</b>
Standard value	Lower input limit	Upper input limit	Units
<b>0</b>	<b>0</b>	<b>99 999 999</b>	<b>-</b>

**Active: After POWER ON**

For the manufacture of dynamically balanced parts by deformation hammer and needling machines are used. With these machines it can occur that a path X is programmed but a path X' must be traversed.

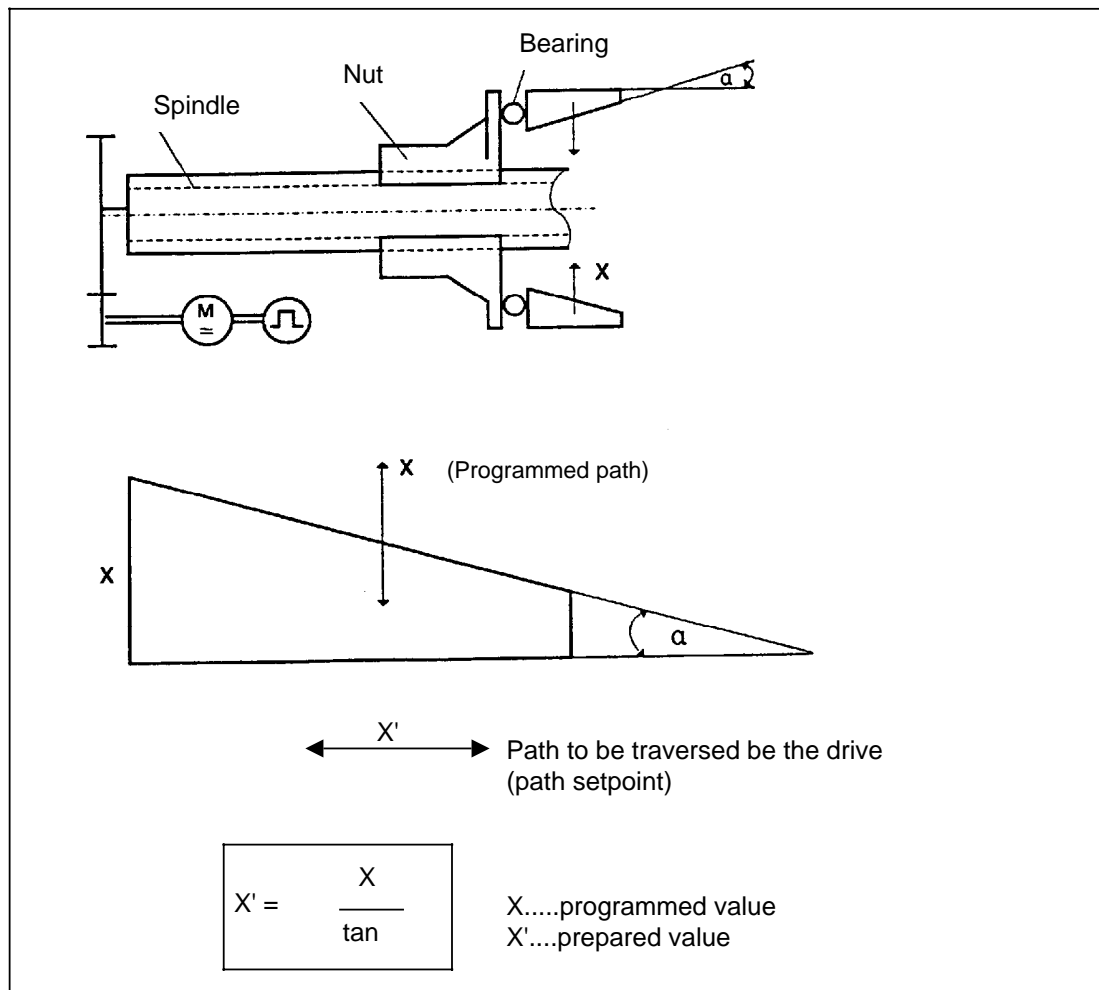

The tan (not the angle ) is entered as the weighting factor in NC MD 388\*, for which the value range +0.00001 to +99.999999 is permissible.

The weighting in NC MD 388\* is as follows:

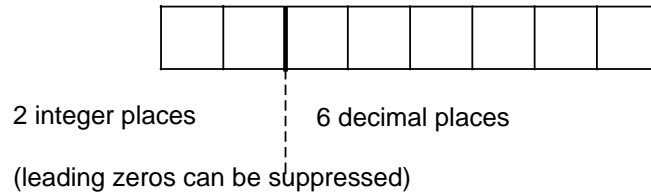

The value zero is interpreted as weighting factor 1, and the programmed path will be the same as the path to be traversed.

Conditions:

- a) All further NC MD (in units [IS]) must be input in the program system (X).
- b) All further NC MD (in units [MS]) must be input in the prepared system (X').
- c) The actual value display (not in the service displays), zero offsets, the tool offset, the PRESET offset, refer to the programmed system.
- d) The programmed F value refers to the program system.
- e) If the programmed or predefined speed exceeds the permissible axis speed in the prepared system for the internal computing format alarm 2031 "eval. factor too high/low" is set and the processing and NC start inhibited.
- f) The weighing factor is active in **all** modes.

<b>392*</b>	<b>Time constant for feedforward control (from Software Version 5)</b>			<b>392*</b>
Standard value	Lower input limit	Upper input limit	Units	
<b>0</b>	<b>0</b>	<b>1000</b>	<b>0.1 ms</b>	

In order to avoid overshoots on the axes when feedforward control is applied, the part set value is applied with delay to the speed controller. This delay is set with this MD.

Input value:

- = 0      Static feedforward control (e.g. for AC drives with rise time < servo sampling time)
- 0      Dynamic feedforward control for axes with rise time > servo sampling time)

<b>396*</b>	<b>Correction absolute encoder</b>			<b>396*</b>
Standard value	Lower input limit	Upper input limit	Units	
<b>0</b>	<b>0</b>	<b>±99999999</b>	<b>units (IS)</b>	

**Active: After POWER ON**

The offset value is determined automatically with reference point approach or can be entered by hand when synchronizing without reference point approach (see Section 2.3.3.2).

In addition, the NC machine data bits 1808\* bits 0 to 3 have to be taken into account.



1100*	Prelimit switch (from Software Version 3)		1100*
Standard value	Lower input limit	Upper input limit	Units
<b>20 000</b>	<b>- 99 999 999</b>	<b>99 999 999</b>	<b>units (MS)</b>

**Active: Immediately**

The prelimit switch must be entered in NC MD 0 up to Software Version 2.

Defines the distance at which the braking operation is to be prematurely begun if the current speed exceeds the speed in NC MD 1, thus ensuring that the position of the software limit switch will be overrun only to a negligible degree during circular interpolation.

Overshooting of the prelimit switch triggers alarm 2034 except in the case of rapid traverse.

**Recommendation**

The value entered should be slightly higher than the value which would correspond to the braking distance from rapid traverse to NC MD 1.

In program mode, travel movements which would result in overshooting of the software limit switch position are simply not started (alarm 2065 is triggered).

**Exception!**

Circular interpolation, helical interpolation

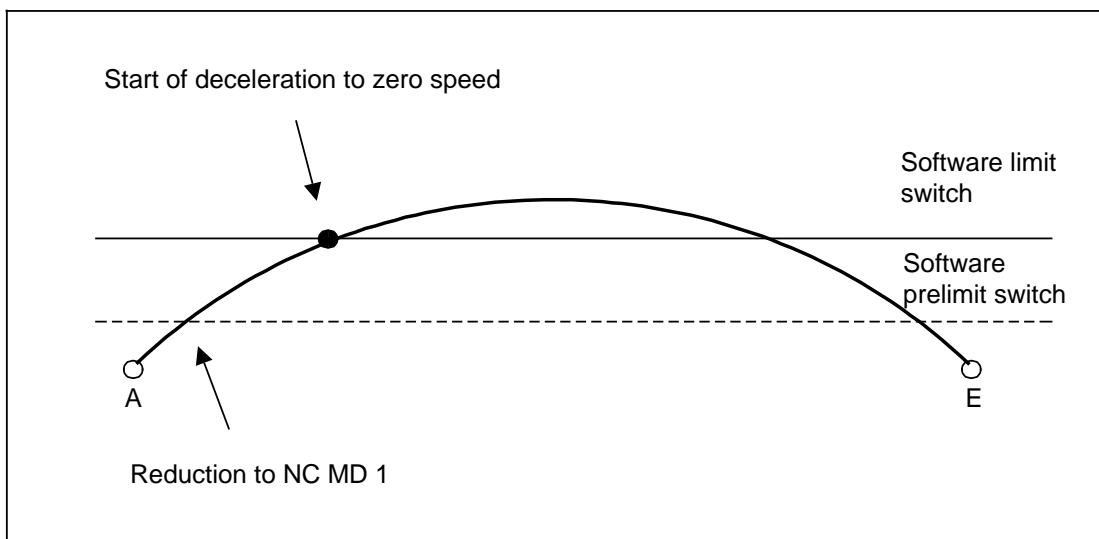

<b>1104*</b>	<b>Number of divisions (from Software Version 3)</b>			<b>1104*</b>
Standard value	Lower input limit	Upper input limit	Units	
<b>0</b>	<b>0</b>	<b>999</b>	<b>-</b>	

**Active: Immediately**

Input limits: Value 0 is **not** permitted for indexing axes (NC MD 564\* bit 4 = 0).  
 The division number defines the number of divisions of each division absolute dimension (NC MD 1108\*).  
 (Division dimension from PLC see also Section 11).

1108*		Division reference dimension (from Software Version 3)		1108*	
Standard value	Lower input limit	Upper input limit	Units		
0	0	99 999 999	units (MS)		

**Active: Immediately**

Input limits: Value 0 is **not** permitted for indexing axes (NC MD 564\* bit 4 = 0).

The division reference dimension defines the reference path to which the reference number (NC MD 1104\*) refers (division dimension from PLC see also Section 11).

If the indexing axis is a rotary axis, the division reference dimension is set to 360° in the control. The value entered in NC MD 1108\* has no meaning.

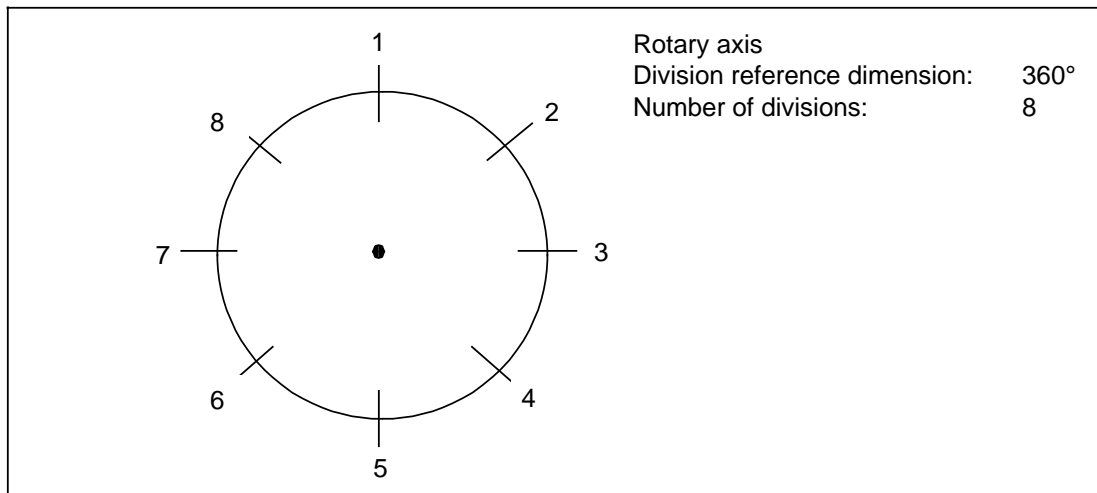
**Example:**

If the indexing axis is a linear axis, the division reference dimension must be input as a reference path in units (MS) in the NC MD.

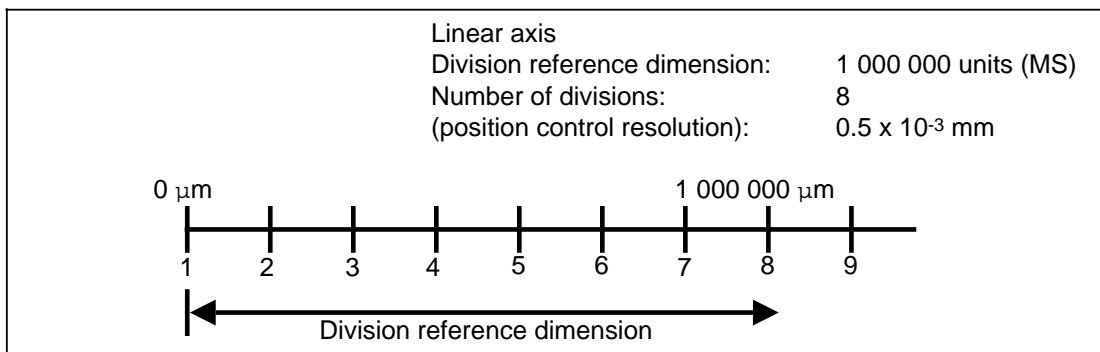
**Example:**

<b>1112*</b>		<b>Division offset (from Software Version 3)</b>		<b>1112*</b>	
Standard value		Lower input limit		Upper input limit	
<b>0</b>		<b>- 99 999 999</b>		<b>99 999 999</b>	
				Units	
				<b>units (MS)</b>	

**Active: Immediately**

For the purpose of the division calculation, the indexing position 1 is made equal to 0 in the control. As these values are not the same in many cases, the reference point can be offset. This is carried out with NC MD "Division offset", which defines the distance between the actual value 0 and the division dimension 1 in units (MS). (Division dimension from PLC see also Section 11).

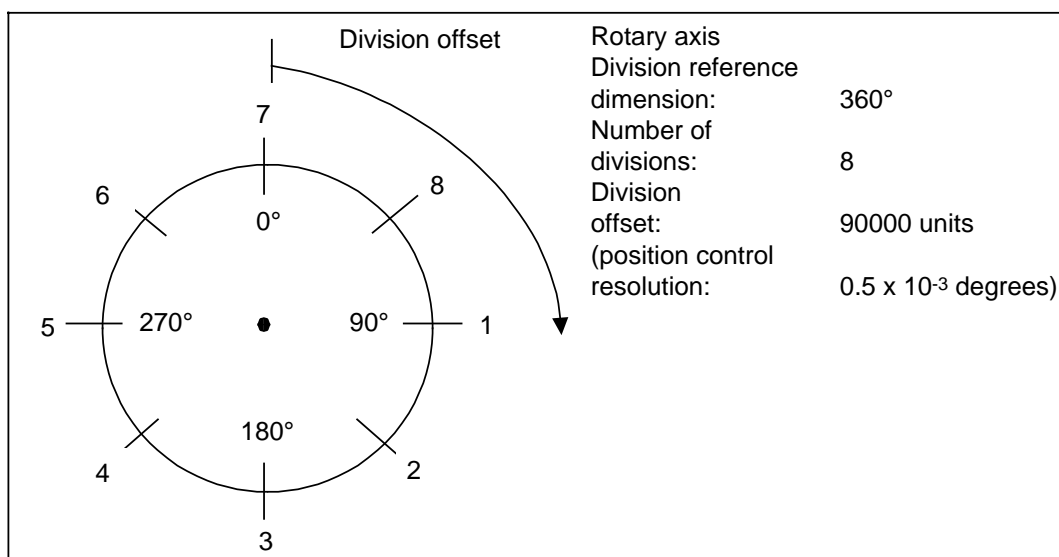

**Note:**

The division offset for rotary axes must be max. ± 360 degrees.

1116*		Pulse multiplication selection (from Software Version 4)		1116*	
Standard value	Lower input limit	Upper input limit	Units		
0	0	128 <sup>1)</sup>	-		

**Active: After RESET**

MD 1116\* is used to set the multiplication factor for the actual position pulses when using the 6FX 1145-6B ... HMS measuring-circuit module. On Power on, the NC software checks whether an HMS measuring-circuit module has been inserted; only when this is the case does MD 1116\* take effect. (See also Section 12).

Measuring system resolution : measuring system x 4 x MD 1116\*

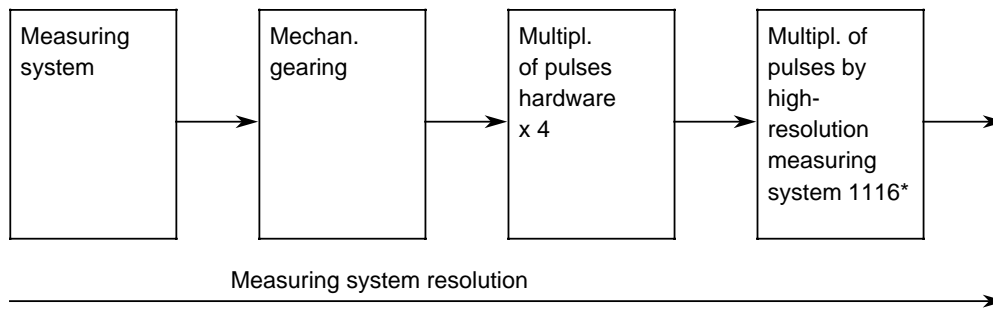

If the indexing axis is a linear axis, the division reference dimension must be input in the NC MD as a reference path in units (MS).

<sup>1)</sup> Input values: 1, 2, 4, 8, 16, 32, 64 and 128

**Caution:**

The following values apply if integrated drive control (IAR) is used:

<b>1116*</b>		<b>Pulse multiplication indirect measuring system</b>		<b>1116*</b>	
Standard value	Lower input limit	Upper input limit	Units		
<b>1</b>	<b>0</b>	<b>32</b>	<b>-</b>		

**Active: After RESET**

The measuring system resolution can be adapted to any application with the HMS measuring-circuit module. The maximum pulse multiplication of 128 is broken down as follows:

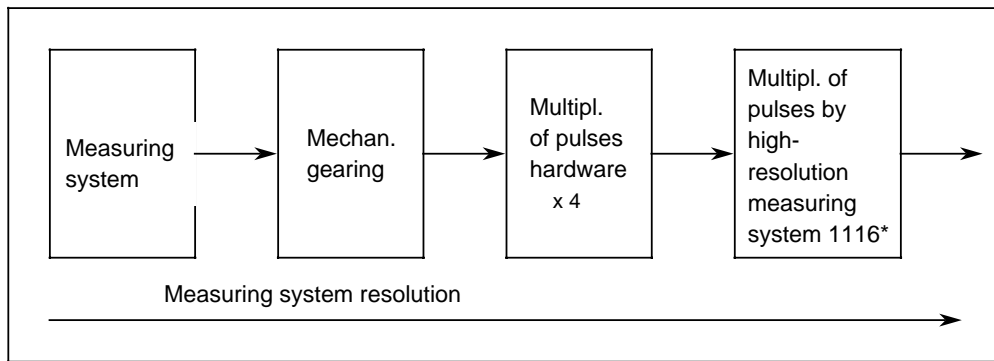

Multiplication factors 1, 2, 4, 8, 16 and 32 can be set with NC MD 1116\*. The set multiplication must be taken into account for the variable incremental weighting for the indirect measuring system NC MD 364\*, 368\*.

**Example:** see variable incremental weighting

1128*		Basic value of tacho compensation (from Software Version 5)		1128*	
Standard value	Lower input limit	Upper input limit	Units		
-		±400	0.01 %		

**Active: When the function has been reprogrammed**

The tacho can be finely adjusted with this MD. First, drift compensation must be performed.

MD 1804\* bit 1 must be set to activate the tacho compensation. Adaptation (bit 2) must not be activated until the basic value has been set.

Setting the basic value:

Travel at constant velocity and determination of the deviation using the following error, e.g.:

Velocity v:                                    5 m/min  
Gain factor  $K_v$  :                                1  
Position control resolution:                 $0.5 \cdot 10^{-3}$  mm

Expected following error:                10000                                     $(s = \frac{v}{K_v})$

1. Real value:                                10043  
Error:                                        +0.43 %  
Input in MD 1128\*:                        43
2. Real value:                                9938  
Error:                                        -0.62 %  
Input in MD 1128\*:                        -62

**Note:**

When applying tacho compensation with adaptation (MD 1804\*, bit 2), the determined adaptation value must be deleted each time the basic value is altered (MD 1128\*).

<b>400*</b>	<b>Spindle assignment, actual-value input and servo CPU</b>		<b>400*</b>
Standard value	Lower input limit	Upper input limit	Units
<b>0</b>	<b>0</b>	<b>10 030 400</b>	<b>-</b>

**Active: After POWER ON**

Assignment of the machine's spindles to the servo CPUs and measuring-circuit modules in the system's configuration is very flexible. It is effected separately according to actual-value inputs (MD 400\*) and setpoint outputs (MD 460\*).

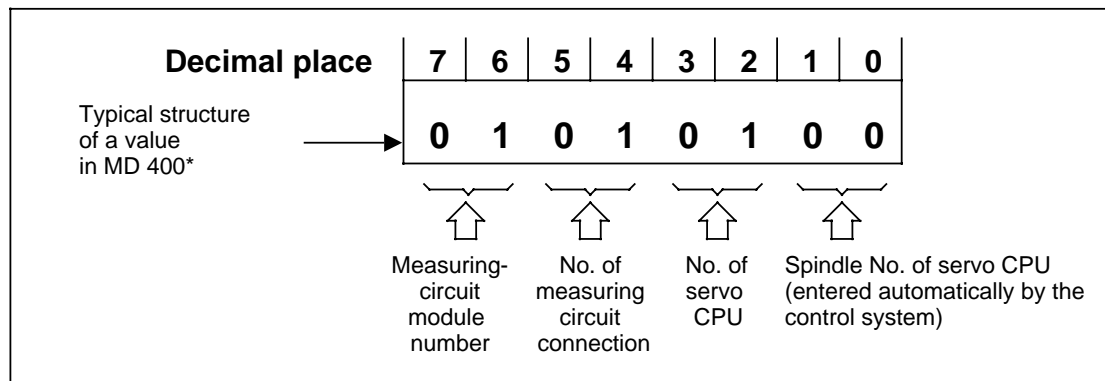

Fig. 9.1 Structure of MD 400\*

**Meanings of terms**

- The **measuring-circuit module number** is the number of the module on the servo local bus. The modules are numbered in ascending order from left to right. The module at the far left is No. 1. If there is no spindle encoder, "00" must be entered here.

Permitted values: 00 to 10

- The **number of the measuring-circuit connection** refers to the number of the input on the selected HMS or SPC module. The numbering of the inputs and outputs is shown in Figs. 4.2 and 4.3. If there is no spindle encoder, "00" must be entered here.

Permitted values: 00 to 03

- The **number of the servo CPU** identifies the servo CPU that will be performing the open-loop and closed-loop control of the spindle. The servo CPUs are also numbered in ascending order from left to right. The module at the far left is No. 1.

Permitted values: 00 to 04



**Notes**

- The value "00 00 00 00" for MD 400\* is only permitted if the spindle is not available for control (MD 521\*, bit 7 = 0).
- Both SPC and HMS measuring-circuit modules are permitted for actual value acquisition.
- The extended spindle functions are only available on 32-bit servo CPUs. With a mixed complement of 16-bit and 32-bit servo CPUs, the first one in the rack (left) must be a 32-bit CPU.

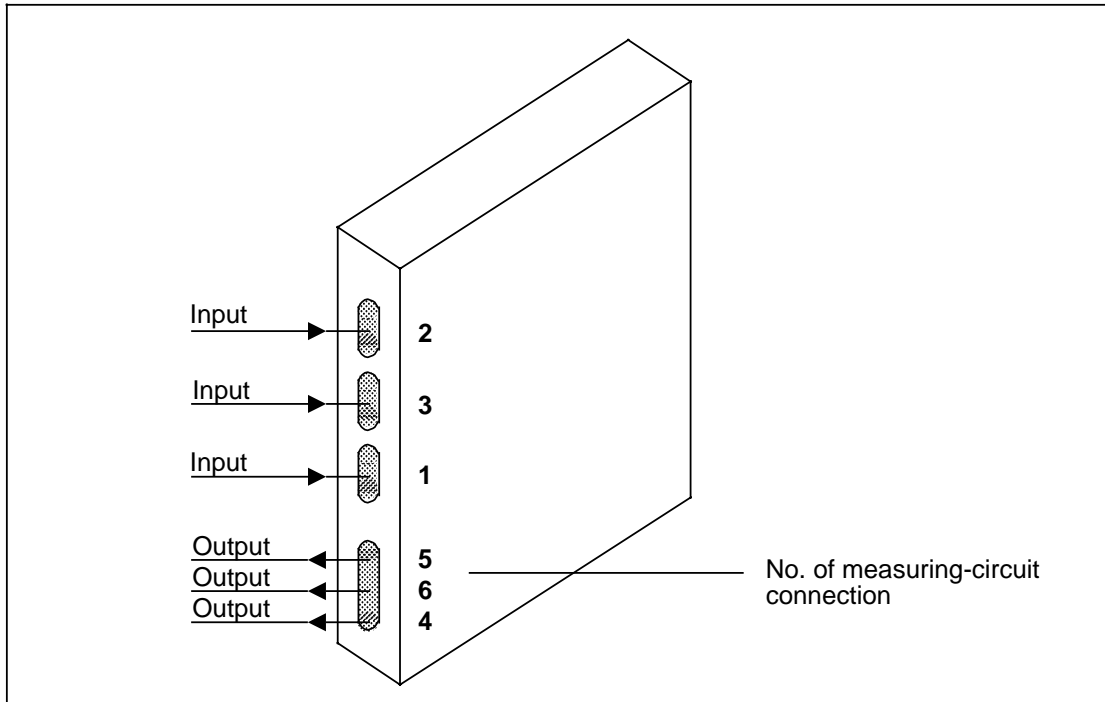

Fig. 9.2 Assignment of inputs/outputs on SPC measuring-circuit modules

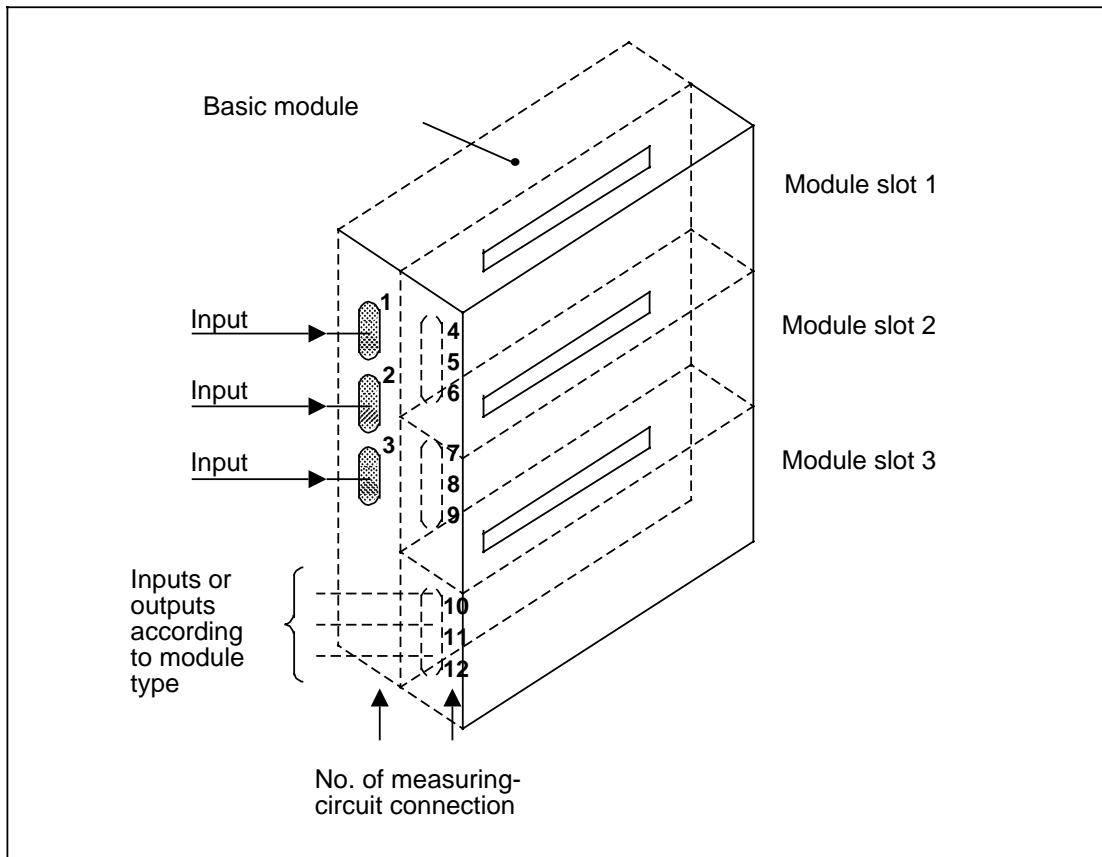

Fig. 9.3 Assignment of inputs/outputs on HMS measuring-circuit modules (with setpoint submodules)

<b>401*</b>	<b>Drift compensation for spindle</b>		<b>401*</b>
Standard value	Lower input limit	Upper input limit	Units
<b>0</b>	<b>- 500</b>	<b>500</b>	<b>VELO</b>

The value of this machine data must be altered until, with the same reference speed in both directions, the spindle runs at the same value of actual speed. The adjustments must be carried out at low speed.

The check can be made from the basic display, from the diagnostic display for the spindles or with a tachometer (for spindles without an encoder).

<b>403*-410*</b>		<b>Maximum speed for 8 gear ratios</b>		<b>403*-410*</b>	
Standard value	Lower input limit	Upper input limit	Units		
<b>see Table</b>	<b>0</b>	<b>16 000 up to SV 5 99 999 from SV 6</b>	<b>rev/min or 0.1 rev/min</b>		

**Assignment**

Gear ratio	1	2	3	4	5	6	7	8
NC MD	403*	404*	405*	406*	407*	408*	409*	410*

The machine data establishes the maximum spindle speeds which can be attained in the individual gear ratios with maximum setpoint voltage.

In the case of gearboxes with less than 8 ratios, the value 0 must be entered for the missing ratios.

**Standard values**

Gear ratio	1:	500
Gear ratio	2:	1000
Gear ratio	3:	4000
	:	
	:	
Gear ratio	8:	4000

**Units**

The units of the values entered depend on MD 520\*, bit 3:

Bit 3 = 0:	Unit rev/min
Bit 3 = 1:	Unit 0.1 rev/min

<b>411*-418*</b>		<b>Minimum speed for 8 gears</b>		<b>411*-418*</b>	
Standard value	Lower input limit	Upper input limit	Units		
<b>see table</b>	<b>0</b>	<b>16 000 up to SV 5 99 999 from SV 6</b>	<b>1/min or 0.1 rev/min</b>		

**Assignment**

Gear ratio	1	2	3	4	5	6	7	8
NC MD	411*	412*	413*	414*	415*	416*	417*	418*

The minimum and maximum speeds (MD 403\* and 410\*) establish the speed ranges for the individual gear ratios. From the programmed value of spindle speed, therefore, it is possible to ascertain the necessary gear ratio and signal it to the PLC. If the speed ranges overlap, the new gear ratio must be chosen so that there are as few changes as possible.

**Standard values**

- Gear ratio 1: 50
- Gear ratio 2: 500
- Gear ratio 3: 1000
- Gear ratio 4: 2000
- ⋮
- ⋮
- Gear ratio 8: 2000

**Units**

The units of the values entered depend on MD 520\*, bit 3:

- bit 3 = 0: Unit rev/min
- bit 3 = 1: Unit 0.1 rev/min (from Software Version 6)

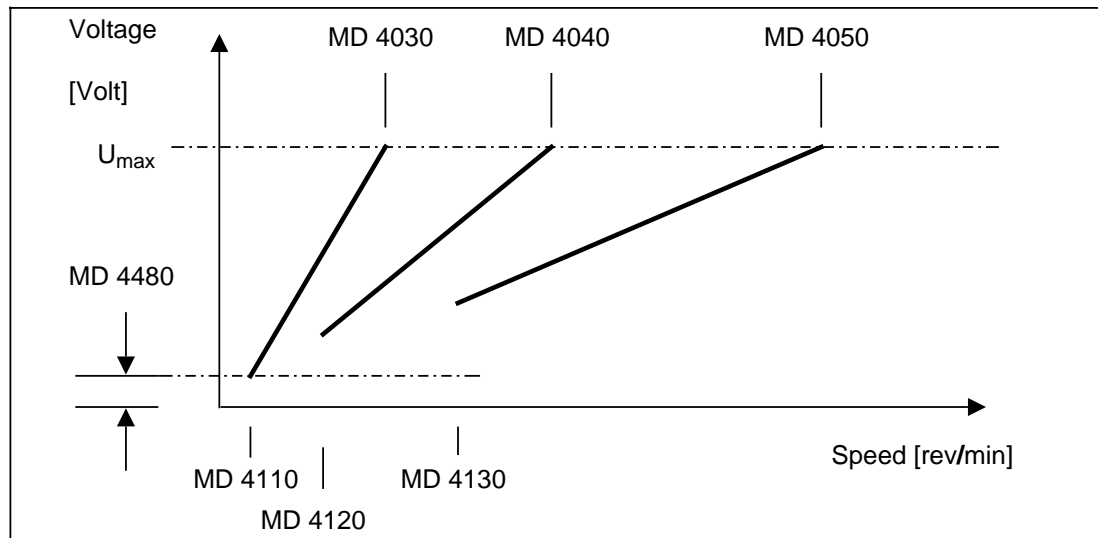

Fig. 9.4 Speed ranges of the gear ratios

U<sub>max</sub>: max. speed setpoint voltage (see MD 468\*)

<b>419*-426*</b>		<b>Acceleration time constant without position controller for 8 gear ratios</b>		<b>419*-426*</b>	
Standard value	Lower input limit	Upper input limit	Units		
<b>200</b>	<b>0</b>	<b>16 000 up to SV 5 99 999 up to SV 6</b>	<b>4 ms</b>		

**Active: When all channels of the mode group are in STOP state**

#### Assignment

Gear ratio	1	2	3	4	5	6	7	8
NC MD	419*	420*	421*	422*	423*	424*	425*	426*

The control system issues the ramp-form setpoint (ramp-function generator) for acceleration and deceleration functions. The slope of the ramp is determined by the acceleration time constant.

#### Notes

- There are two acceleration time constants for each gear ratio:
  - Acceleration time constant without position controller (MD 419\* to 426\*)
  - Acceleration time constant with position controller (MD 478\* to 485\*)

Time constants without position controller are used for the open-loop control mode and time constants with position controller for the positioning mode and synchronous mode.
- MD 419\* to 426\* can be set so that the motor accelerates at maximum current for a limited time. On the other hand, there must always be a certain amount of control reserve with MD 478\* to 485\*. The current limit must never be reached even in the motor's weak-field range.
- If there is already a ramp-function generator in the drive actuator, MD 419\* to 426\* can be set to with zero. There will then be a step-change in setpoint output for acceleration and deceleration functions.
- The acceleration value must be such that the speed is altered by more than half a revolution within one interpolator pulse (MD 155). Otherwise alarm 2291 (service no. 529) is triggered.

<b>427*-434*</b>		<b>Creep speed for M19 for 8 gear ratios</b>		<b>427*-434*</b>	
Standardwert	untere Eingabegrenze	obere Eingabegrenze	Einheiten		
<b>100</b>	<b>0</b>	<b>1 500 up to SV 5 6 16 000 from SV 6</b>	<b>rev/min or 0.1 rev/min</b>		

**Active: When all channels of the mode group are in STOP state**

**Assignment**

Gear ratio	1	2	3	4	5	6	7	8
NC MD	427*	428*	429*	430*	431*	432*	433*	434*

Spindle positioning is a different procedure on 32-bit servo CPUs than on 16-bit servo CPUs.

In the case of the 32-bit CPUs, the creep speed serves as the limit which must not be exceeded during acceleration:

- When positioning from zero speed, maximum acceleration is to the creep speed.
- When the spindle is running, the position controller is activated immediately at the beginning of positioning. Then, for the speed:
  - If the actual speed is less than the creep speed, the spindle maximum accelerates to the creep speed at the most.
  - If the actual speed is greater than the creep speed, the actual speed is retained until it is possible to decelerate directly to the required position at maximum deceleration rate.

**Units**

The units of the values entered depend on MD 520\*, bit 3:

bit 3 = 0: Unit rev/min

bit 3 = 1: Unit 0.1 rev/min (from Software Version 6)

<b>435*-442*</b>		<b>Gain factor for 8 gear ratios</b>		<b>435*-442*</b>	
Standard value	Lower input limit	Upper input limit	Units		
<b>200</b>	<b>0</b>	<b>10 000</b>	<b>rev/min/360°</b>		

**Active: When all channels of the mode group are in STOP state**

#### Assignment

Gear ratio	1	2	3	4	5	6	7	8
NC MD	435*	436*	437*	438*	439*	440*	441*	442*

In the case of spindles on 32-bit servo CPUs, the gain factor is used for the synchronous mode as well as for M19 (positioning mode).

Therefore, it is the same as a gain factor in a position control circuit.

#### Notes

- The "actual" gain factor of a gear ratio used by a machine depends on several factors:
  - the gain factor setting for the gear ratio
  - the maximum speed of the gear ratio
  - the multgain factor (MD 468\*)
  - the setting of speed controller and drive

<b>443*</b>	<b>Position tolerance for M19 (up to Software Version 5)</b>			<b>443*</b>
Standard value	Lower input limit	Upper input limit	Units	
<b>22</b>	<b>0</b>	<b>4 096</b>	<b>ca. 1/11°</b>	

**Active: When all channels of mode group in STOP state**

In the case of oriented spindle stop (M19) the message "SPINDLE POSITION REACHED" is output to the PLC via the interface (DB31 DL K bit 4) as soon as the positional variation lies within this tolerance. The positional tolerance is indicated in pulse generator increments. 1 increment corresponds to 360°/4096°.

The MD has no influence on positioning accuracy since the control attempts to approach the specified position as accurately as possible irrespective of the "Spindle position reached" signal.

The spindle closed-loop position control remains active until "Acknowledge M19" (DB31 DR K+2) or until "Spindle servo enable" is cancelled. On cancelling the position control see also NC MD 520\* bit 5 and bit 6. Setting the "Spindle stop" signal does not cancel position control (see also Section 11.2).

<b>443*</b>	<b>Position tolerance with M 19 (from Software Version 6)</b>			<b>443*</b>
Standard value	Lower input limit	Upper input limit	Units	
<b>22</b>	<b>0</b>	<b>360 000</b>	<b>MS Accuracy</b>	

**Active: When all channels of the mode group in STOP state**

In the positioning mode, IS: SPINDLE POSITION REACHED is output to the PLC as soon as the deviation from the set position is less than this tolerance. The position tolerance is given in the measuring system resolution.

This machine data has no direct effect on the accuracy of the positioning because the control system still attempts to reach the position as accurately as possible. It only ends when the positioning mode is aborted.

**Notes**

- The standard value is applicable to spindles on a 16-bit servo CPU. The value must be changed for spindles on 32-bit servo CPUs.
- If the spindle is assigned a C axis with its own encoder in MD 461\*, the value must be entered in **measuring system resolution of the C axis encoder**.



<b>444*</b>		<b>Tolerance of spindle speed</b>		<b>444*</b>	
Standard value	Lower input limit	Upper input limit	Units		
<b>10</b>	<b>0</b>	<b>100</b>	<b>%</b>		

**Active: When all channels of the mode group in STOP state**

The actual speed of the spindle is compared with the setpoint value. If the discrepancy is greater than the tolerance given here, IS: SPINDLE IN SET RANGE will be cancelled.

**Notes**

- The setpoint speed is determined by the programmed value of speed, and the speed override and the limits by the speed limit values.
- An encoder must be mounted on the spindle for acquiring the actual value of speed. If there is no encoder, speed monitoring will not be possible.
- The value of tolerance entered is in the form of a percentage of the programmed value of setpoint speed.
- The permitted range is as follows:  
(setpoint speed - tolerance) actual speed (setpoint speed + tolerance)
- There is no monitoring if 100% is entered.

<b>445*</b>	<b>Tolerance of maximum spindle speed</b>			<b>445*</b>
Standard value	Lower input limit	Upper input limit	Units	
<b>10</b>	<b>0</b>	<b>100</b>	<b>%</b>	

**Active: When all channels of the mode group in STOP state**

If the speed limit for the spindle is exceeded by more than this tolerance, IS: SPEED LIMIT EXCEEDED is set and an alarm is triggered. All axes and spindles of the relevant mode group are stopped.

**Notes**

- An encoder must be mounted on the spindle for acquiring the actual speed. If not, it will be impossible to monitor the speed.
- The value of tolerance entered is in the form of a percentage of the current relevant speed limit.
- The current speed limit is determined by the smallest value of the following:
  - MD 403\* to 410\* "Max. speed per gear ratio"
  - MD 451\* "Max. chuck speed"
  - SD 401\* "Programmable spindle speed limit for G96";  
programmed with G92
  - SD 403\* "Programmable spindle speed limit";  
programmed with G26
- There is no monitoring if 100% is entered.

<b>446*</b>	<b>Tolerance of zero speed</b>			<b>446*</b>
Standard value	Lower input limit	Upper input limit	Units	
<b>10</b>	<b>0</b>	<b>10 000</b>	<b>0.01 %</b>	

**Active: When all channels of the mode group are in STOP state**

If the actual speed of the spindle is less than this tolerance, IS: SPINDLE STOPPED will be set.

**Notes**

- An encoder must be mounted on the spindle in order to acquire the actual value of speed. If not, it will be impossible to monitor the speed.
- The value of tolerance entered is in the form of a percentage (unit 0.01%) of the maximum speed of the current gear ratio.
- There is no monitoring if 10 000 (100%) is entered.

<b>447*</b>	<b>Delay for servo disable</b>			<b>447*</b>
Standard value	Lower input limit	Upper input limit	Units	
<b>1 000</b>	<b>0</b>	<b>16 000</b>	<b>ms</b>	

**Active: When all channels of the mode group are in STOP state**

The following events will cause the enabling of the speed controller to be cancelled:

- Cancelling of IS: SERVO ENABLE
- EMERGENCY STOP
- Triggering of the measuring circuit monitoring
- Cancelling of IS: MODE GROUP READY

However, the speed controller enable is only cancelled when the time given here has elapsed.

<b>448*</b>	<b>Minimum motor speed setpoint</b>			<b>448*</b>
Standard value	Lower input limit	Upper input limit	Units	
<b>50</b>	<b>0</b>	<b>8 192</b>	<b>VELO</b>	

**Active: When all channels of the mode group are in STOP state**

The machine data establishes the minimum motor speed below which smooth running of the motor cannot be guaranteed.

The actual speed of the motor is never taken below this minimum even if, for a constant cutting rate (G96) and increasing turning diameter, it would be necessary, strictly speaking, to employ a lower speed. The end result, of course, is that the cutting rate is no longer constant.

<b>449*</b>	<b>Basic speed</b>			<b>449*</b>
Standard value	Lower input limit	Upper input limit	Units	
<b>50</b>	<b>0</b>	<b>9 999 up to SV 5 99 999 from SV 6</b>	<b>rev/min or 0.1 rev/min</b>	

**Active: When all channels of the mode group are in STOP state**

When the PLC sets IS:PLC SPINDLE CONTROL and BASIC SPEED, the speed value entered here is output as the speed setpoint for the spindle. The current actual gear ratio is taken into account.

**Units**

The units of the value entered depend on MD 520\*, bit 3:

- Bit 3 = 0:           Unit   rev/min
- Bit 3 = 1:           Unit   0.1 rev/min (from Software Version 6)

<b>450*</b>	<b>Oscillation speed setpoint</b>			<b>450*</b>
Standard value	Lower input limit	Upper input limit	Unit	
<b>50</b>	<b>0</b>	<b>8 192</b>	<b>VELO</b>	

**Active: When all channels of the mode group are in STOP state**

When the PLC sets IS: PLC SPINDLE CONTROL and OSCILLATION SPEED, the value entered here is output as the speed setpoint for the motor.

<b>451*</b>	<b>Maximum chuck speed</b>			<b>451*</b>
Standard value	Lower input limit	Upper input limit	Units	
<b>4 000</b>	<b>0</b>	<b>16 000 up to SV 5 6 99 999 from SV 6</b>	<b>1 rev/min or 0.1 rev/min</b>	

**Active: When all channels of the mode group are in STOP state**

This machine data establishes the maximum speed for the spindle regardless of the gear ratio.

If the speed is exceeded by more than the permitted tolerance (MD 445\*), IS: SPEED LIMIT EXCEEDED is set and an alarm triggered.

#### Units

The units of the values entered depend on MD 520\*, bit 3:

Bit 3 = 0:           Unit   1 rev/min  
Bit 3 = 1:           Unit   0.1 rev/min (from Software Version 6)

<b>452*</b>	<b>Spindle position for external M19</b>			<b>452*</b>
Standard value	Lower input limit	Upper input limit	Units	
<b>0</b>	<b>0</b>	<b>3 599 up to SV 5 35 999 from SV 6</b>	<b>0.1° 0.01°</b>	

**Active: After POWER ON**

When the PLC sets IS: PLC SPINDLE CONTROL and POSITION SPINDLE, the spindle is driven to the angle entered here.

**Units**

The units of the values entered depend on MD 520\*, bit 3:

- Bit 3 = 0:           Unit   0.1°
- Bit 3 = 1:           Unit   0.01° (from Software Version 6)

<b>453*</b>	<b>Spindle mode group</b>			<b>453*</b>
Standard value	Lower input limit	Upper input limit	Units	
<b>1</b>	<b>1</b>	<b>8</b>	<b>—</b>	

**Active: After POWER ON**

This machine data establishes to which mode group the spindle is assigned. The PLC can assign a spindle to a different mode group with the aid of the "warm restart" function.

<b>455*</b>	<b>Pulses, variable incremental weighting</b>			<b>455*</b>
Standard value	Lower input limit	Upper input limit	Units	
<b>32</b>	<b>0</b>	<b>65 000</b>	—	

<b>456*</b>	<b>Distance traversed, variable incremental weighting</b>			<b>456*</b>
Standard value	Lower input limit	Upper input limit	Units	
<b>5625</b>	<b>0</b>	<b>65 000</b>	—	

**Active: After RESET**

The internal calculations for the spindle are performed with the value of resolution provided by the measuring system (i.e. the measuring system resolution). The measuring system resolution must be entered in order to perform the internal conversions with it. However, like the axes, the entry is not made by means of the increments of the encoder and the pulse multiplication, but by means of the variable incremental weighting. This allows spindle encoders of any pulse rate and also encoder gearboxes to be used.

The parameters for determining MD 455\* and 456\* are listed in the table below.

Parameter	Symbol	Meaning
Position control resolution	b	Absolute unit of distance traversed; constant $0.5 \times 10^{-3}$ degrees
Pulses per revolution	p	No. of encoder pulses per revolution
Pulse multiplication	f	Pulse multiplication for HMS measuring circuit module; MD 458*
Encoder gearbox	r1/r2	Gear ratio between spindle and encoder

MD 455\* =  $4 \cdot p \cdot f \cdot r2$  No. of measuring system pulses per encoder revolution including hardware multiplication; multiplied by r2

MD 456\* =  $\frac{360 \cdot r1}{b}$  No. of internally-calculated increments per encoder revolution; multiplied by r1

If the calculated values exceed the entry limits, common factors **must** be abbreviated.

**Notes**

- The position control resolution for the spindle has been set at  $0.5 \times 10^{-3}$  degrees.
- If a C axis is assigned to the spindle (MD 461\*), the C axis resolution is used for calculation (MD 1800\*, 364\*, 368\*).
- The standard values are applicable to the use of an SPC measuring-circuit module and an encoder with 1024 pulses per revolution (see Example).

**Examples**

- Encoder mounted directly on the first spindle; square-wave encoder and SPC measuring-circuit module  
 $b = 0.5 \times 10^{-3}$  degrees  
 $p = 1024$  pulses per revolution  
 $f = 1$  no pulse multiplication  
 $r1 = 1$  no encoder gearbox  
 $r2 = 1$

The encoder delivers  $4 \times 1024 = 4096$  pulses when the spindle performs one complete revolution.

When these factors are substituted in the formulae:

MD 4550 = 4 096  
 MD 4560 = 720 000

Abbreviating by means of the common factor 128 gives:

MD 4550 = 32  
 MD 4560 = 5625

- Encoder mounted on the second spindle through an encoder gearbox; SIPOS signal generator and HMS measuring-circuit module  
 $b = 0.5 \times 10^{-3}$  degrees  
 $p = 2500$  pulses per revolution  
 $f = 8$  pulse multiplication by HMS  
 $r1 = 2$  2 spindle revolutions correspond to  
 $r2 = 3$  3 encoder revolutions

When these factors are substituted in the formulae:

MD 4550 = 240 000  
 MD 4560 = 1 444 000

Abbreviating by means of the common factor 240 000 gives:

MD 4550 = 1  
 MD 4560 = 6



<b>457*</b>		<b>Spindle encoder increments</b>		<b>457*</b>	
Standard values	Lower input limit	Upper input limit	Units		
<b>1 024</b>	<b>0</b>	<b>65 000 up SV 5 65 000 000 from SV 6</b>	<b>Increments/ rev</b>		

The number of increments of the spindle encoder must be entered here.

MD 457\* is evaluated by the 16-bit servo CPU **only**, when electronic gearbox is used.

In the case of spindles on the 32-bit servo CPU, pulse weighting is performed with the aid of MD 455\* and 456\*.

<b>458*</b>		<b>Pulse multiplication by HMS</b>		<b>458*</b>	
Standard values	Lower input limit	Upper input limit	Units		
<b>1</b>	<b>0</b>	<b>128</b>	<b>–</b>		

#### Active: After POWER ON

With the HMS measuring-circuit module it is possible to adapt the resolution of the measuring system for every type of application. The pulses coming from the encoder are multiplied in two stages:

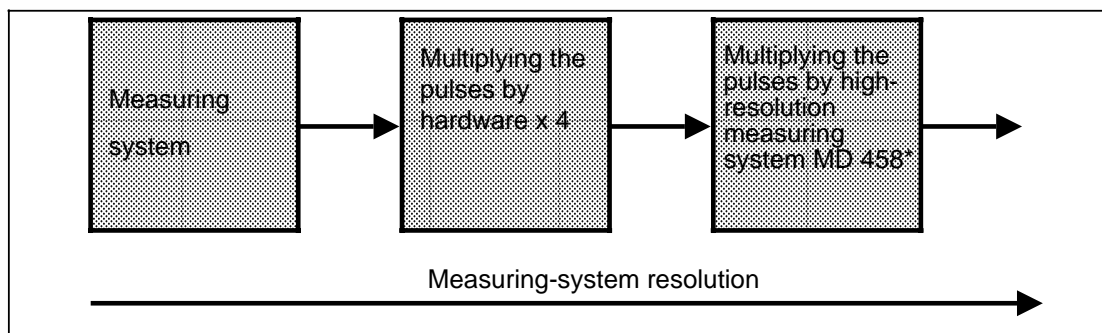

Fig. 9.5 Pulse multiplication by HMS

The following values are permitted for MD 458\* when an HMS measuring-circuit module is used:

1, 2, 4, 8, 16, 32, 64 und 128

Overall, therefore, pulse multiplication by the factor 512 can be obtained.

#### Notes

- The machine data is only taken into account when an HMS measuring-circuit module is used.
- It is essential for the multiplication factor to be taken into account with variable incremental weighting (MD 455\*, 456\*).

<b>459*</b>	<b>Shift of the zero mark</b>		<b>459*</b>
Standard value	Lower input limit	Upper input limit	Units
<b>0</b>	<b>-18 000</b> <b>-36 000</b>	<b>18 000 up to SV 5</b> <b>36 000 from SV 6</b>	<b>0.01°</b>

**Active: After POWER ON**

The relocatable zero mark enables the angle zero of the spindle (e.g. to M19 S0) to differ from the zero mark of the encoder. It allows the spindle zero to be set anywhere.

The reference system of the spindle control is shifted in relation to the reference system of the encoder.

**Notes**

- Any change in this machine data only becomes operative when the spindle has been resynchronized with the encoder.
- When a positive value is issued to MD 459\*, the angular position of the spindle is shifted in the direction corresponding to clockwise rotation (M03).
- If a C axis is assigned to the spindle, the shift of the (spindle) zero mark is taken into account during reference point approach by the C axis (see 2.2.4.3 "Synchronizing and Referencing").

**Example**

MD 4590 = 9 000

Shift of zero mark by 90°

M19 S270 L<sub>F</sub>

Since this system has been shifted by 90° compared with the zero mark of the encoder, the spindle will stop at the zero mark of the encoder

(see MD 463\* for more examples)

460*		Spindle assignment, setpoint output (from Software Version 6)		460*	
Standard value	Lower input limit	Upper input limit	Units		
0	0	see Permitted values	—		

**Active: After POWER ON**

MD 460\* establishes the assignment of the analog speed setpoint to a particular measuring-circuit module and output.

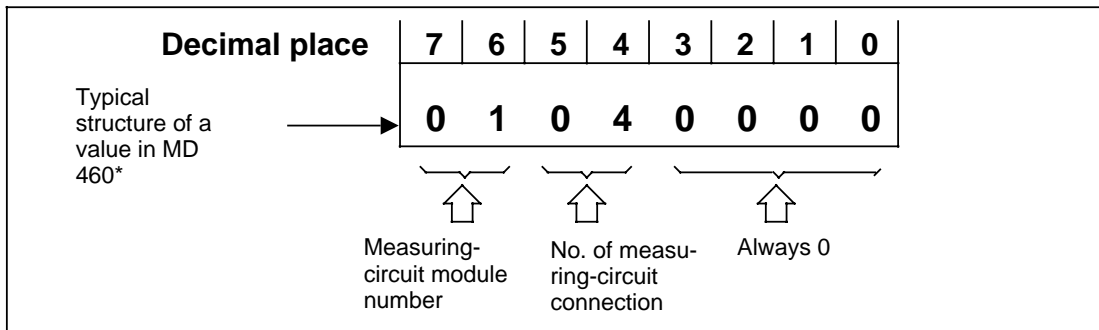

Fig. 9.6 Structure of MD 460\*

from Software Version 6: HMS modules can be used

**Meanings of terms**

- The **number of the measuring-circuit connection** refers to the number of the output on the selected HMS or SPC module. The numbering of the inputs and outputs is shown in Figs. 4.2 and 4.3.

Permitted values:      04 to 06      for SPC modules  
                                 04 to 12      for HMS modules

**Notes**

- The value "00 00 00 00" for MD 460\* is only permitted if the spindle is not available for control (MD 521\*, bit 7 = 0).
- Variable assignment of actual value inputs and setpoint outputs is only possible when HMS measuring-circuit modules are used.
- With SPC measuring-circuit modules the inputs and outputs of a spindle must be on the same module with the following assignments:

Input 1	to	Output 4
Input 2	to	Output 5
Input 3	to	Output 6

<b>461*</b>	<b>Global axis No. of assigned C axis (from Software Version 6)</b>		<b>461*</b>
Standard value	Lower input limit	Upper input limit	Units
<b>0</b>	<b>0</b>	<b>24</b>	<b>—</b>

**Active: After POWER ON**

This machine data establishes the global axis number under which a spindle will be operated when it is working as a C axis. It determines, for example, which axis-specific machine data record will be used.

The machine data is also used when assigning a following spindle to its leading spindle (see MD 9x0, x = 4, 6, 8 for FS 1, 2, 3).

If the value 0 is entered in MD 461\*, the spindle can be used neither as C axis nor as following spindle.

**Notes**

- The C axis must be defined on the same servo CPU as the spindle (MD 200\* and 400\*).
- Any changes to this machine data only become operative after power-on.
- If a C axis is assigned to a spindle (MD 461\* not 0), the internal calculations for the spindle are also performed using the measuring-system resolution for the C axis. Therefore, the variable incremental weighting of the axis must also be entered (MD 364\*, 368\*, 1800\*).
- If a global C-axis number is assigned to spindle with machine data MD 461\*, this C axis can only be traversed when it is selected as a C axis. Selection/deselection is via M functions from MD 260/MD 261.

**Example:**

MD 260=70, MD 261=71, MD 4610=2 (C axis)

C axis cannot be traversed until it is been selected with M70.

C axis operation is deselected with M71.

<b>Cutoff frequency of spindle encoder (from Software Version 6)</b>			
<b>462*</b>			<b>462*</b>
Standard value	Lower input limit	Upper input limit	Units
<b>500</b>	<b>0</b>	<b>16 000</b>	<b>kHz</b>

**Active: After POWER ON**

The cutoff frequency of the actual-value encoder of the spindle is entered in the machine data. The value can be taken from the manufacturer's documentation.

It is possible for pulses from the encoder to be lost if the cutoff frequency is exceeded. It means that the actual-value acquisition will be incorrect and IS: SPINDLE SYNCHRONIZED will be cancelled.

When the value falls below the critical frequency again, the spindle is automatically re-synchronized with the encoder (hysteresis characteristic).

**Note**

If there is no separate encoder for the C axis mode, the cutoff frequency of the spindle encoder will be used for monitoring this mode too.

<b>463*</b>	<b>Synchronous position shift (from Software Version 6)</b>		<b>463*</b>
Standard value	Lower input limit	Upper input limit	Unit
<b>0</b>	<b>-17 999</b>	<b>18 000</b>	<b>0.01°</b>

**Active: When all channels of the mode group are in STOP state**

A specific value of angular offset between leading spindle and following spindle can be programmed when the synchronous mode is selected.

For example, if an angular offset of 0 degrees is programmed with a speed ratio of 1:1 (G201 S1 = A0 L<sub>F</sub>) it means that the following spindle will always reach its zero mark when the leading spindle reaches its. The respective values of zero mark shift (MD 459\*) are taken into account.

With MD 463\* it is possible to assign parameters for an angular offset between leading spindle and following spindle which will be allowed for as standard when the synchronous mode with a defined angular offset is selected. If an angle of 0 degrees is then programmed with G201, the value of angular offset entered in MD 463\* will be taken.

**Notes**

- Synchronous position shift must be entered for the following spindle. The machine data of the leading spindle is not taken into account.
- When issuing a positive value to MD 459\*, the synchronous position of the following spindle is shifted in the direction corresponding to clockwise rotation (M03).

**Examples**

Spindle 1:                    Leading spindle  
 Spindle 2:                    Following spindle for Spindle 1 (speed ratio 1:1)  
 Direction:                    Both spindles rotate clockwise with M03  
 M19 position:                SD 4020 = 0  
                                       SD 4021 = 0

- MD 4590 = 0  
MD 4591 = 0  
MD 4631 = 0

i.e. no shift of zero marks and synchronous position

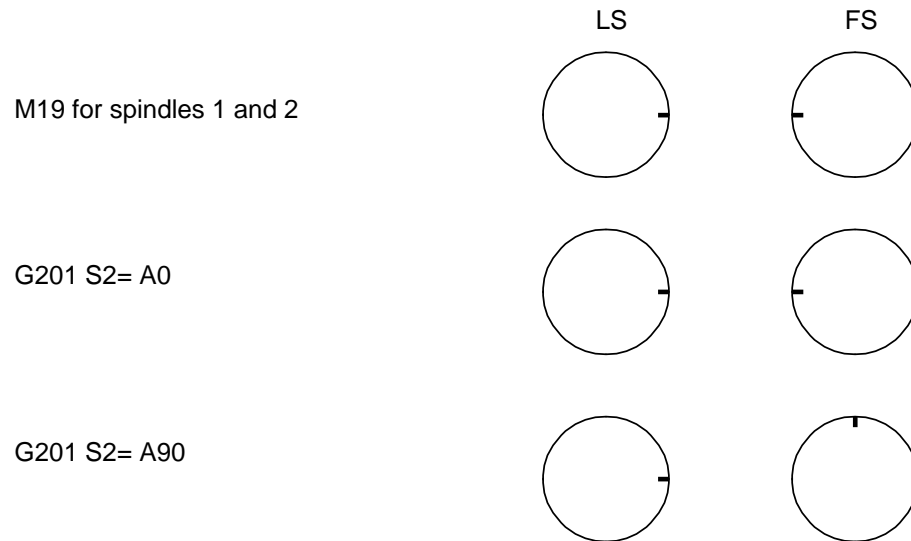

- MD 4590 = 9 000  
MD 4591 = 0  
MD 4631 = 0

i.e. positive shift of zero mark of LS; no shift of zero mark of FS and synchronous position

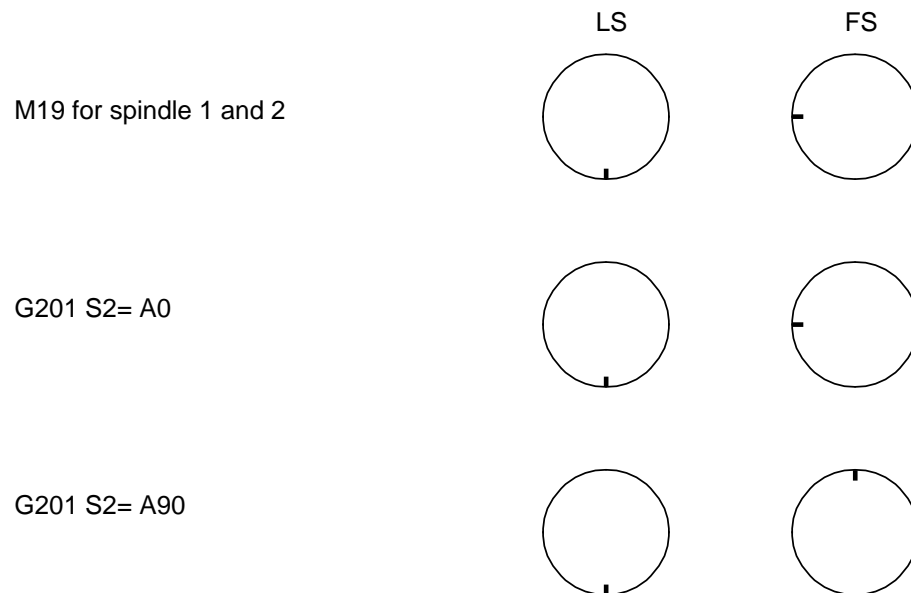

- MD 4590 = 0  
MD 4591 = - 9 000  
MD 4631 = 0

i.e. negative shift of zero mark of FS; no shift of zero mark of LS and synchronous position

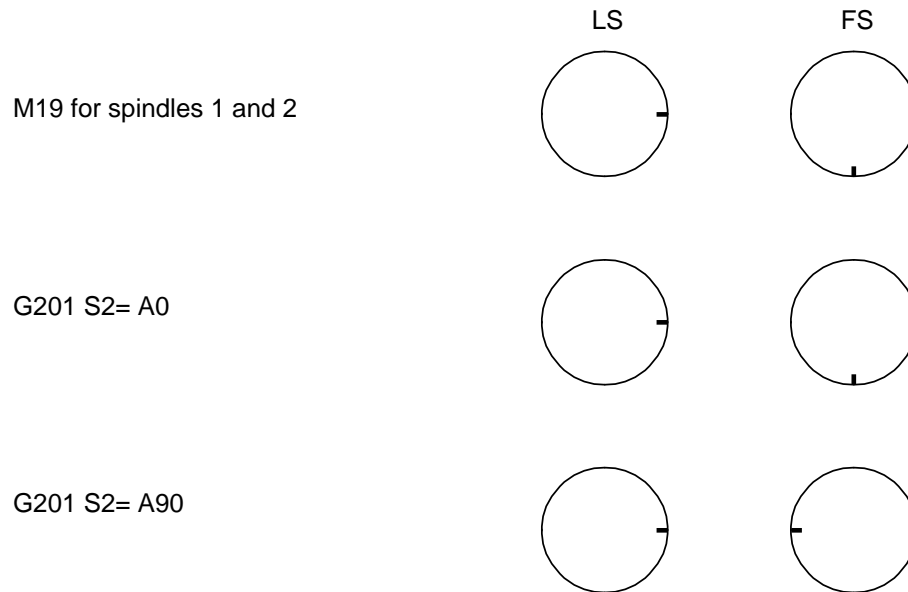



- MD 4590 = 0  
MD 4591 = 0  
MD 4631 = 9 000

i.e. no shift of zero marks; positive shift of synchronous position

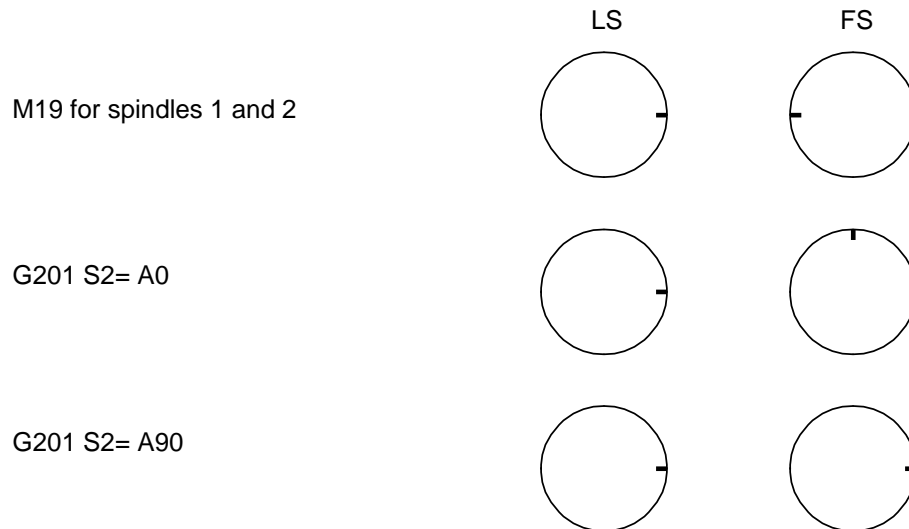

- MD 4590 = 9 000  
MD 4591 = 0  
MD 4631 = 9 000

i.e. positive shift of zero mark of LS and synchronous position; no shift of zero mark of FS

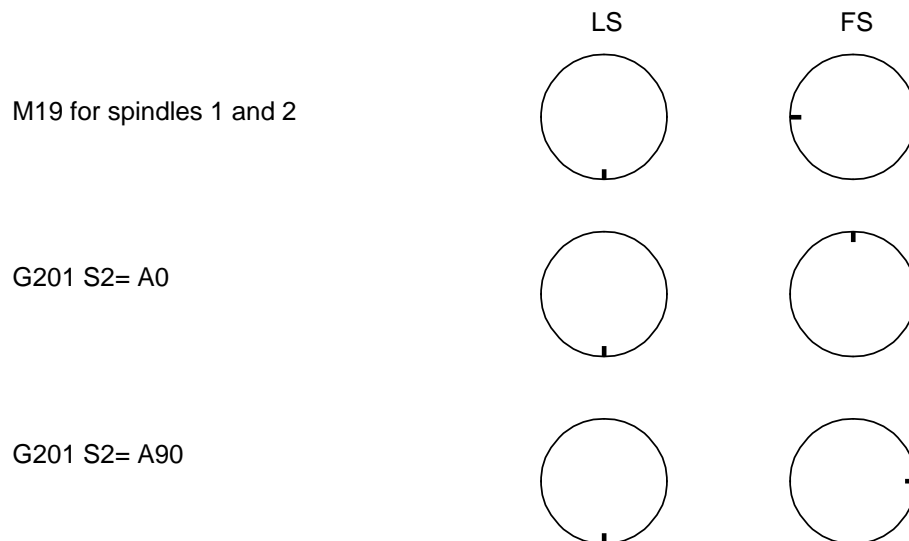

### Application

Through MD 463\* it is possible to compensate for any offset of the zero marks of the leading spindle and following spindle without having to shift the zero marks of the individual spindles.

<b>465*</b>	<b>Feedforward control factor (from Software Version 6)</b>			<b>465*</b>
Standard value	Lower input limit	Upper input limit	Unit	
<b>0</b>	<b>0</b>	<b>1 000</b>	<b>0.1 %</b>	

Static feedforward control is activated by entering a value other than zero in MD 465\*. With position-controlled spindles (positioning mode, C axis mode, synchronous mode) it allows the following error to be reduced and the dynamic response to be improved.

Entering the value 1000 produces driving at constant speed with no following error. With this setting, however, some overshoot of the preset position or travel contour must be anticipated during acceleration and deceleration functions.

Entering a value other than zero in MD 467\* too (time constant for feedforward control), activates dynamic feedforward control, which improves the dynamic behaviour of the spindle.

Dynamic feedforward control should be activated in order to obtain precise synchronism in the synchronous mode. The feedforward control settings must be the same for both spindles.

**Recommended range of values**

Machine tests have shown that the best results are obtained with values in the range from 500 to 800.

<b>466*</b>	<b>Position controller clock pulse for spindles (from Software Version 6)</b>			<b>466*</b>
Standard value	Lower input limit	Upper input limit	Unit	
<b>2</b>	<b>0</b>	<b>16</b>	<b>—</b>	

**Active: After POWER ON**

The number of axes and spindles on the servo CPU can be increased by increasing the sampling interval of the position control. However, it must be remembered that it also impairs the control-action result.

For a specific spindle the position controller sampling interval can be calculated from:

$$T_{LS} = 1 \text{ ms} \cdot 2^{MD 466*}$$

**Notes**

- The sampling interval of the position control must be in an integer ratio to the chosen value of interpolation clock pulse (MD 155).
- If a C axis is assigned to the spindle in MD 461\*, the position controller clock pulses for spindle and C axis must be identical. The position controller clock pulse for the C axis is set in MD 155, MD 160...163 and IAR MD 108\*.

<b>467*</b>		<b>Time constant for feedforward control (from Software Version 6)</b>		<b>467*</b>	
Standard value	Lower input limit	Upper input limit	Units		
<b>0</b>	<b>0</b>	<b>16</b>	<b>0.1 ms</b>		

The leading spindle and following spindle must have identical dynamic response for command behaviour.

- Matching the dynamic response with identical servo gain ( $K_V$ ) factors.  
The values of position controller gain for the leading spindle and following spindle should be identical if possible and should also be as high as possible in order to obtain good disturbance characteristics.
- If the leading spindle and following spindle cannot be matched for the same dynamic response, the faster spindle can be slowed down by means of a delay element in the setpoint branch for command behaviour.

### Setting instructions

- Set the individual spindles for good disturbance characteristics and command behaviour.
- Calculate the equivalent time constants for the individual spindles from the formula:

$$T_{\text{equiv}} = \frac{1}{K_V} \quad K_V: \text{ Servo gain factor}$$

- It is a precondition that the measured values of following error be correct (set maximum speed and multigain accordingly).
- Set the spindle-specific delay element (MD 467\*) for the faster spindle by entering the difference between the equivalent time constants of the two spindles as the time constant.
- Fine-balance by selecting the synchronous mode (without compensatory controller) and altering the delay time constant at constant speed until the two values of following error are the same.

**Example:**

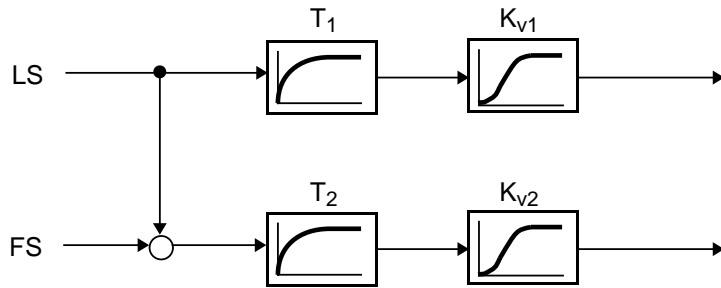

$$K_{v1} = 1000 \frac{1/\text{Min}}{360^\circ} = \frac{1000}{60} \text{ S}^{-1} \quad T_{\text{equiv1}} = 60 \text{ ms}$$

$$K_{v2} = 2000 \frac{1/\text{Min}}{360^\circ} = \frac{2000}{60} \text{ S}^{-1} \quad T_{\text{equiv2}} = 30 \text{ ms}$$

$$T_1 = 60 \text{ ms} - 60 \text{ ms} = 0 \text{ ms}$$

$$T_2 = 60 \text{ ms} - 30 \text{ ms} = 30 \text{ ms}$$

- In order to save computing time, one delay element should always have a time constant of zero.

<b>468*</b>		<b>Multgain factor (from Software Version 6)</b>		<b>468*</b>	
Standard value	Lower input limit	Upper input limit	Units		
<b>9 000</b>	<b>0</b>	<b>32 000</b>	<b>0.01 %</b>		

**Active: When all channels of the mode group are in STOP state**

Like the axis-specific multgain factor (MD 260\*), the spindle-specific value is used for digital tachogenerator matching. For spindles, however, the value to be entered must be calculated differently.

With spindles it is possible to assign parameters for different maximum speeds for eight gear ratios (MD 403\* to 410\*). The same multgain factor is used for all gear ratios, however, so it is necessary to determine the factor independently of these maximum speeds.

Assuming that  $U_{\max}$  is the speed setpoint voltage at maximum motor speed, then:

$$\text{Multgain} = \frac{U_{\max} \text{ [V]}}{10 \text{ [V]}} \cdot 10\,000$$

The factor 10 000 is only for increasing the accuracy of input.

**Example**

$$\begin{aligned} U_{\max} &= 8.345 \text{ V} \\ \text{Multgain} &= 8\,345 \end{aligned}$$

<b>469*</b>	<b>Factor for gain change (from Software Version 6)</b>		<b>469*</b>
Standard value	Lower input limit	Upper input limit	Units
<b>0</b>	<b>1</b>	<b>16 000</b>	<b>%</b>

In the positioning mode, the spindle must be held in the target position under position control. In order to ensure a steady stationary position for the spindle even when there is drift, very small speed setpoints with a very high resolution must be fed to the drive actuator through the analog interface.

Therefore, with some drive actuators it is possible, by applying a configurable terminal signal, to select different normalization for the speed setpoints.

This changing of the normalization in the drive actuator must be taken into account in the control system so that, overall, the effective gain factor remains the same. The gain factor (dependent on gear ratio, MD 435\* to 442\*) must be matched to the new normalization .

The factor for gain changing is then:

$$MD\ 469^* = \frac{1}{N} \quad \text{Where } N = \text{normalization factor in the drive actuator}$$

**Notes**

- Changing the gain factor is initiated by setting IS: CHANGE GAIN FACTOR. This signal must always be set simultaneously with the terminal signal.
- Entering the value 0 in MD 469\* (the standard value) is the same as entering the value 100. In both cases the gain factor given in MD 435\* to 442\* is not changed.
- For more information on changing the gain factor see "Gain change".

<b>478*-485*</b>		<b>Acceleration time constant with position controller for 8 gear ratios (from Software Version 6)</b>		<b>478*-485*</b>	
Standard value	Lower input limit	Upper input limit	Units		
<b>1000</b>	<b>0</b>	<b>50 000</b>	<b>4 ms</b>		

**Active: After POWER ON**

### Assignment

Gear ratio	1	2	3	4	5	6	7	8
NC MD	478*	479*	480*	481*	482*	483*	484*	485*

For acceleration and deceleration, the control system issues ramp-form setpoints (ramp-function generator). The slope of the ramp is determined by the acceleration time constant.

### Notes

- There are two acceleration time constants for each gear ratio:
  - Acceleration time constant without position controller (MD 419\* to 426\*)
  - Acceleration time constant with position controller (MD 478\* to 485\*)

In the open-loop control mode, time constants without position controller are used; in the positioning mode and synchronous mode, time constants with position controller.
- MD 478\* to 485\* must be set so that the motor can follow the setpoint at all times without impinging on the current limit. This is particularly important in the field-weakening range of the motor.
- The acceleration value must be such that the speed is altered by more than half a revolution within one interpolator pulse (MD 155). Otherwise alarm 2291 (service no.: 529) is triggered.

### 9.3.5.4 Machine data bits

#### Allocation

NC MD	Meaning
<b>5000</b> : <b>5199</b>	<b>General bits</b>
<b>520*</b> : <b>522*</b>	<b>Spindle-specific bits (up to 6 spindles)</b>
<b>540*</b> : <b>558*</b>	<b>Channel-specific bits (up to 16 channels)</b>
<b>560*</b> : <b>596*</b>	<b>Axis-specific bits (max. 24 axes)</b>
<b>6000</b> : <b>6999</b>	<b>Leadscrew error compensation bits</b>
<b>1800*</b> : <b>1804*</b>	<b>Axis-specific bits (max. 24 axes)</b>

The symbol "\*" in the case of channel, axis and spindle-specific bits stands for the channel/axis/spindle designation.

The following applies:

0	1st axis or 1st channel or 1st spindle
1	2nd axis or 2nd channel or 2nd spindle
2	3rd axis or 3rd channel or 3rd spindle
3	4th axis or 4th channel or 4th spindle
.	.
.	.
.	.
7	8th axis or 8th channel
.	.
.	.
.	.
11	12th axis
.	.
.	.
.	.
23	24th axis

The axis names (X, Y, Z, ...) are assigned using axis-specific NC MD bit 568\*.

**Note:**

The significance of the individual NC MD bits always refers to the **set** bit.  
 If a bit is **not set**, the declaration (name) is to be negated.

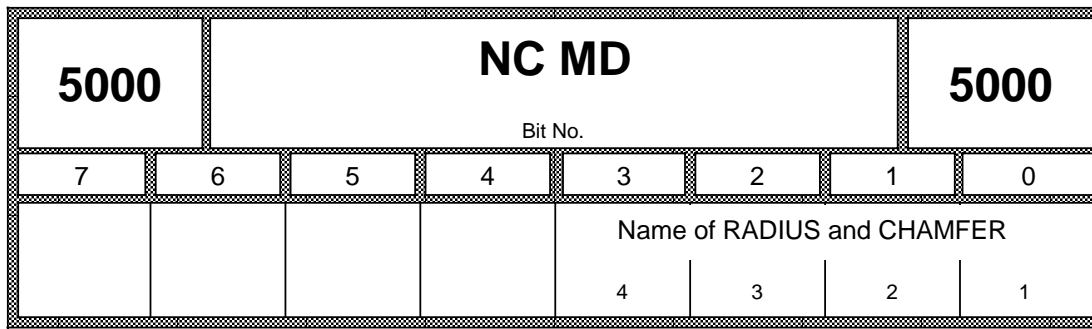

**Active: In next block**Name of **radius** and **chamfer** for:

- Contour definition
- Circular-path programming
- Polar coordinates

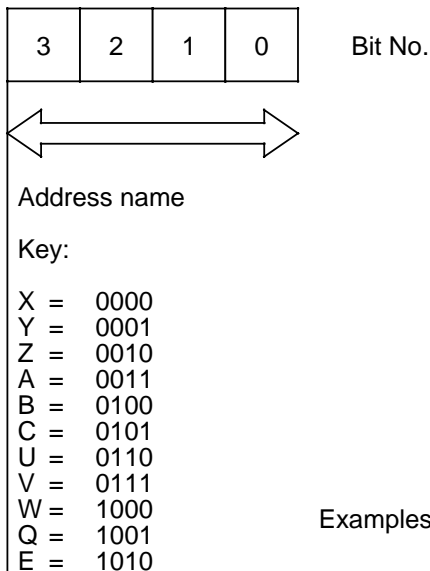

The names in MD 5000, MD 5001 and 568\* must not coincide. The same axis name with a different extended address is regarded as coinciding.

**Permissible names for axes, angles, chamfer and radius**

<b>A</b> Unassigned address	<b>N</b> Subblock
<b>B</b> Unassigned address	<b>O</b> Danger of confusion with 0 (Zero)
<b>C</b> Unassigned address	<b>P</b> Subroutine - Number of passes
<b>D</b> Tool offset number	<b>Q</b> Unassigned address
<b>E</b> Unassigned address	<b>R</b> Calculation parameter
<b>F</b> Feed	<b>S</b> Spindle speed, S function
<b>G</b> G function	<b>T</b> Tool
<b>H</b> H function	<b>U</b> Unassigned address
<b>I</b> Interpolation parameter	<b>V</b> Unassigned address
<b>J</b> Interpolation parameter	<b>W</b> Unassigned address
<b>K</b> Interpolation parameter	<b>X</b> Unassigned address
<b>L</b> Subroutine	<b>Y</b> Unassigned address
<b>M</b> M function	<b>Z</b> Unassigned address

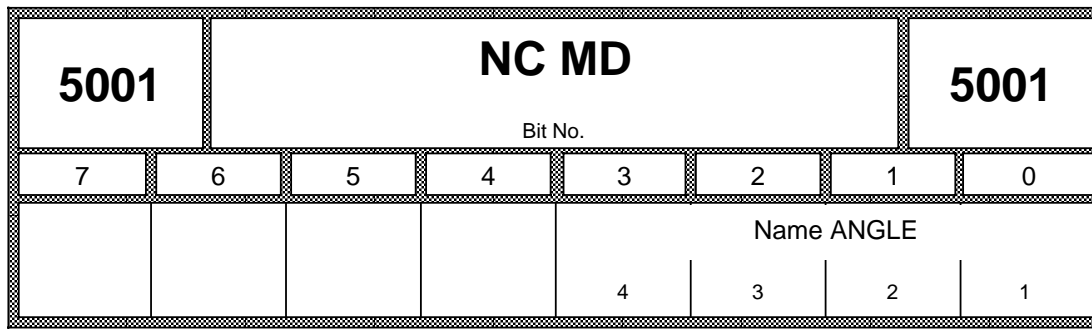

**Active: In next block**

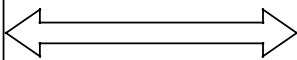
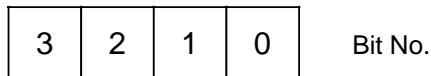

Address name

Key:

- X = 0000
- Y = 0001
- Z = 0010
- A = 0011
- B = 0100
- C = 0101
- U = 0110
- V = 0111
- W = 1000
- Q = 1001
- E = 1010

Examples: 0011 = A

The names in MD 5000, MD 5001 and 568\* must not coincide. The same axis name with a different extended address is regarded as coinciding.

**Permissible names for axes, angles, chamfer and radius**

- |                                  |  |
|----------------------------------|--|
| <b>A</b> Unassigned address      | <b>N</b> Subblock                          |
| <b>B</b> Unassigned address      | <b>O</b> Danger of confusion with 0 (Zero) |
| <b>C</b> Unassigned address      | <b>P</b> Subroutine - Number of passes     |
| <b>D</b> Tool offset number      | <b>Q</b> Unassigned address                |
| <b>E</b> Unassigned address      | <b>R</b> Calculation parameter             |
| <b>F</b> Feed                    | <b>S</b> Spindle speed, S function         |
| <b>G</b> G function              | <b>T</b> Tool                              |
| <b>H</b> H function              | <b>U</b> Unassigned address                |
| <b>I</b> Interpolation parameter | <b>V</b> Unassigned address                |
| <b>J</b> Interpolation parameter | <b>W</b> Unassigned address                |
| <b>K</b> Interpolation parameter | <b>X</b> Unassigned address                |
| <b>L</b> Subroutine              | <b>Y</b> Unassigned address                |
| <b>M</b> M function              | <b>Z</b> Unassigned address                |

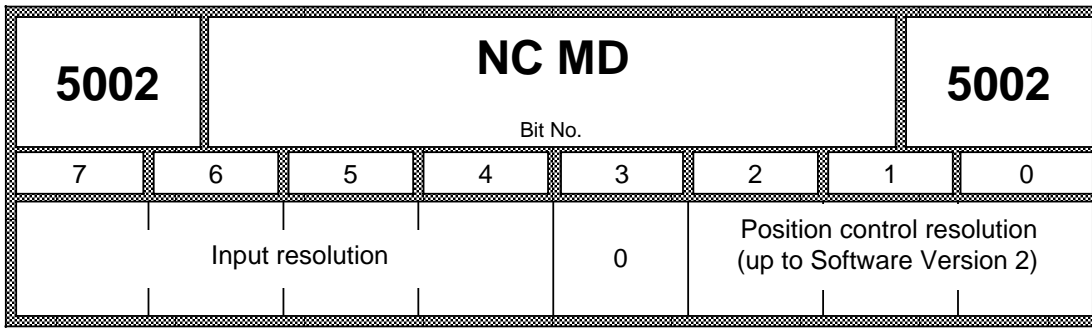

**Active: After POWER ON**

**Software Version 2:**

Up to Software Version 2 all linear axes of the control were defined with an input resolution and a position control resolution. This did not take into account the fact that a system may have axes with different speeds and different precisions (machining axes, transport axes, ...). Rotary axes are also always weighted with a position control resolution of  $0.5 \times 10^{-3}$  degrees and an input resolution of  $10^{-3}$  degrees.

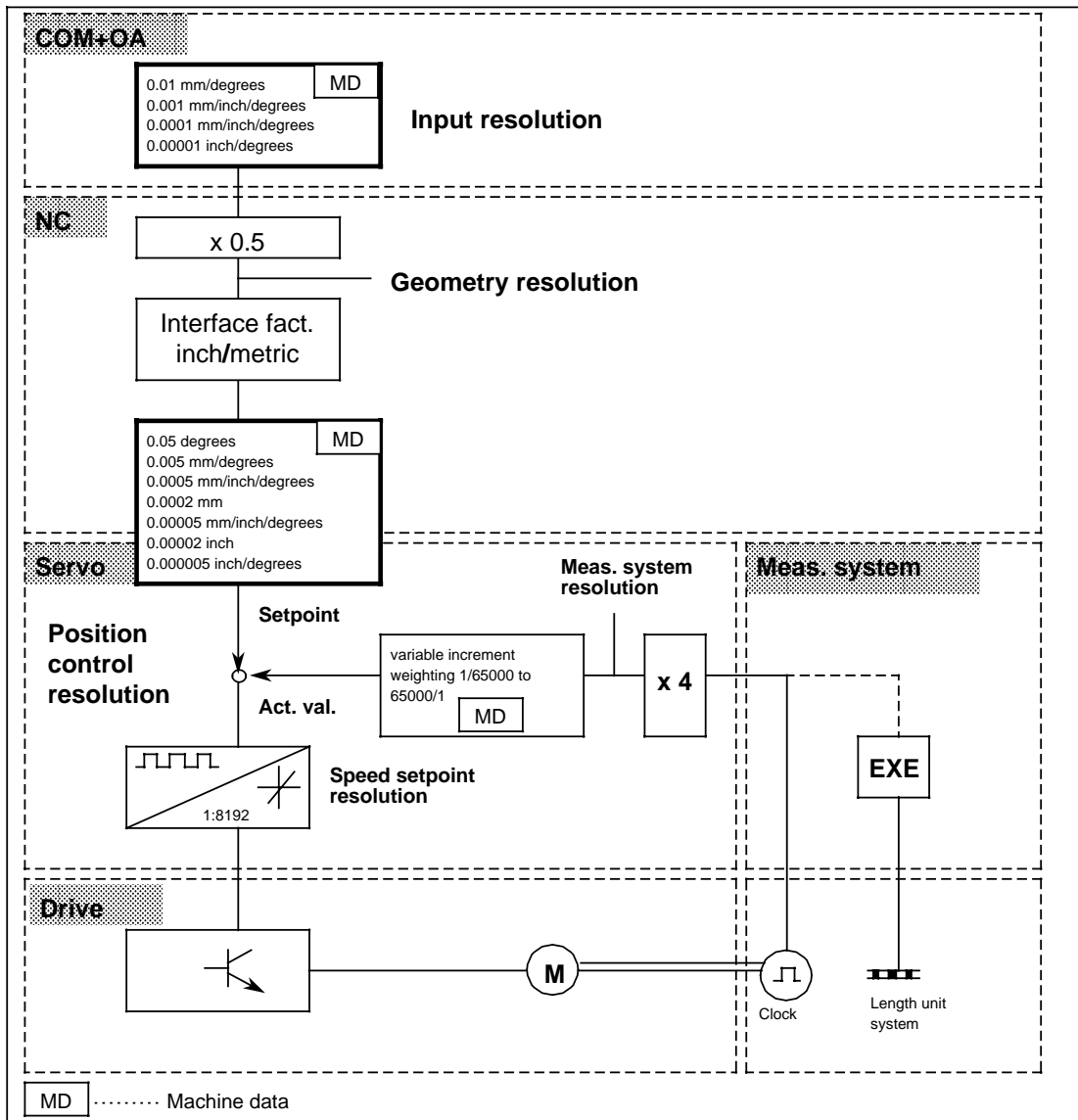

Position control resolution NC MD 5002 bit 0 to 2

Input resolution NC MD bit 4 to 6

The **input resolution** (IS) specifies the increment weighting for dimensional inputs and displays. At the same time the reset position G70 (inch) or G71 (mm) is defined.  
 The **position control resolution** (MS) determines the assignment of an actual part position increment to a specific traverse path.

**Position control resolution for linear axes (up to Software Version 2)**

Bit 2	Bit 1	Bit 0	Significance
0	0	0	1/2 x 10 <sup>-2</sup> mm
0	0	1	1/2 x 10 <sup>-3</sup> inch
0	1	0	1/2 x 10 <sup>-3</sup> mm
0	1	1	1/2 x 10 <sup>-4</sup> inch
1	0	0	1/2 x 10 <sup>-4</sup> mm
1	0	1	1/2 x 10 <sup>-5</sup> inch
1	1	0	2 x 10 <sup>-4</sup> mm
1	1	1	2 x 10 <sup>-5</sup> inch

**Input resolution for linear axes (up to Software Version 2)**

Bit 6	Bit 5	Bit 4	Significance
0	0	0	10 <sup>-2</sup> mm
0	0	1	10 <sup>-3</sup> inch
0	1	0	10 <sup>-3</sup> mm
0	1	1	10 <sup>-4</sup> inch
1	0	0	10 <sup>-4</sup> mm
1	0	1	10 <sup>-5</sup> inch

**For the coding of the input resolution (from Software Version 3) see NC MD 1800\*.**

**Position control resolution and input resolution for rotary axes (fixed up to Software Version 2)**

Position control resolution always 1/2 · 10<sup>-3</sup> degrees (720000 pulses per revolution)  
 Input resolution always 10<sup>-3</sup> degrees

### Possible combinations of input and position control resolution (up to Software Version 2)

Position control resolution	Input resolution					
	10 <sup>-2</sup> mm	10 <sup>-3</sup> mm	10 <sup>-4</sup> mm	10 <sup>-3</sup> inch	10 <sup>-4</sup> inch	10 <sup>-5</sup> inch
0.5 *10 <sup>-2</sup> mm	***	***		***	***	
0.5 *10 <sup>-3</sup> mm	***	***	***		***	***
0.5 *10 <sup>-4</sup> mm		***	***			***
2 *10 <sup>-4</sup> mm		***	***		***	***
0.5 *10 <sup>-3</sup> inch	***			***	***	
0.5 *10 <sup>-4</sup> inch	***	***		***	***	***
0.5 *10 <sup>-5</sup> inch		***	***		***	***
2 *10 <sup>-5</sup> inch		***	***		***	***

All combinations marked "\*\*\*\*" are allowed.

When illegal combinations are selected, a conversion factor of 1/1 is assumed and Alarm 4 (Incorrect unit system) is displayed on the screen.

### Software Version 3:

For an exact description see Section 11.7. From Software Version 3 all linear axes and rotary axes of the control are predefined with an axis-specific position control and display resolution. The input resolution and the geometry resolution resulting from it (responsible for programming, TO, ZO, interpolation, ...) is still defined once for the whole control.

With these so-called axis-specific resolutions (for a more exact description see Section 11.7) it is possible to make optimum adaptations to the machine as regards.

- max. speed
- different position
- max. traversing range.

Input resolution NC MD 5002 bit 4 to 7

Axis-specific display resolution NC MD 1800\* bit 4 to 7

Axis-specific position control resolution NC MD 1800\* bit 0 to 3

The general position control resolution in NC MD 5002 bit 0 to 2 is meaningless.

**General bits**

5003		NC MD						5003	
Bit No.									
7	6	5	4	3	2	1	0		
No deceleration at limit switch	JOG working area limitation active	Interpol. paramet. dep. on G91/G90 (from Software Version 3)	Angle for polar coord. dep. on G91/G90 (from Software Version 3)	Do not clear PRESET OFFSET with Power On	Auxiliary function output before travel	Simulation with G59 (up to Software Version 2)	Simulation with G58 (up to Software Version 2)		

**Bit 7:** No deceleration on reaching the limit switch.  
 With the bit set, braking is not performed over the acceleration/deceleration characteristic, only the following error is suppressed. The limit switch is not overshoot as far (see also NC MD 0).

**Active: Immediately**

**Note:**

In the case of interpolating axes, all axes are shut down when the range limit of an axis has been reached. However, stopping without contour violation is only guaranteed when NC MD No. 5003 bit 7 (no deceleration at limit switch) has not been set, i.e. during braking via the acceleration ramp.

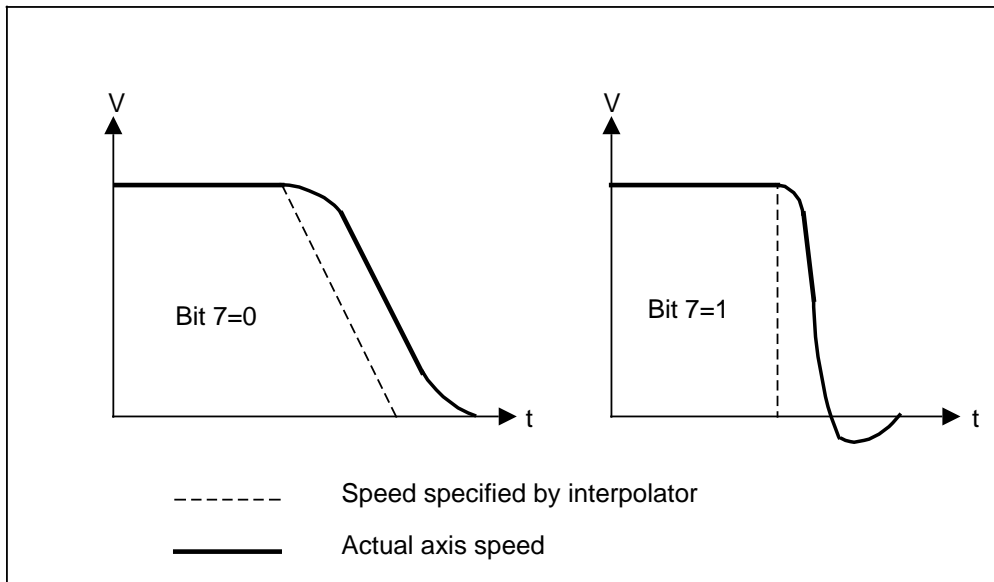

**Bit 6:** Working area limitation is also active in manual modes JOG, INC, REPOS. In addition to the software limit switches, the working area may now also be limited in JOG mode, thus ensuring that the machine is better safeguarded against unintentional traversing. However, since working area limitation is also a software limitation, proper operation cannot be ensured until after reference point approach.

**Active: Immediately**

**Bit 5:** From Software Version 3, if bit 5 is set, the interpolation parameters (I, J, K) can be programmed in the block either absolute (G90) or incremental (G91) (see also NC MD 5007 bit 5). The interpolation parameters for contour definitions (blueprint programming sprint 1) must always be defined incrementally (G91) independently of bit 5.

**Active: In next block**

**Example:**

N10 G0	G90 X80 Y55	F500	LF	Approach in rapid traverse
N20 G02	X50 Y85	I50 J55	LF	Arc
N30 G01	X50 Y75	LF		Linear movement
N40 G03	X50 Y35	I50 J55	LF	Arc
N50 M30	LF			

If the interpolation parameters are specified absolutely, the centre refers to the workpiece centre and not to the circle initial point.

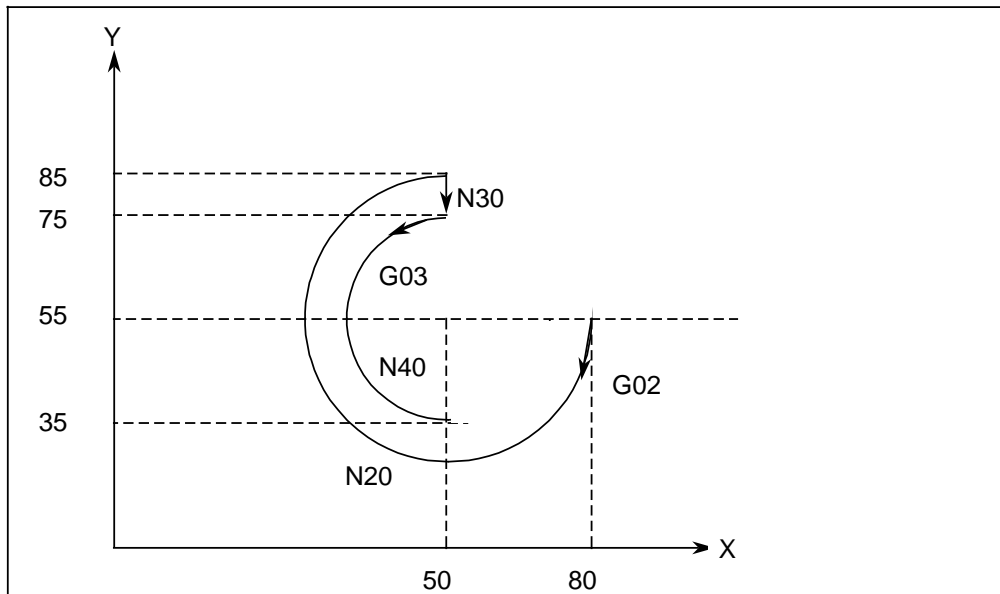

If an interpolation parameter is not programmed because it is "0", the G function which is located before the programmed interpolation parameter also refers to the unprogrammed interpolation parameter.

**Bit 4:** From Software Version 3, if bit 4 is set, angles in polar coordinate programming (G10, G11, G12, G13, G110, G111) can be programmed in block either absolute (G90) or incremental (G91) (see also NC MD 5007 bit 5).

**Active: In next block**

**Example:**

```
N10 G0 G90 X0 Y0 LF
N20 G11 X0 Y0 A30 B40 F500 LF
N30 G91 G110 A60 LF
N40 G90 G110 A30 B30 LF
N50 M30 LF
```

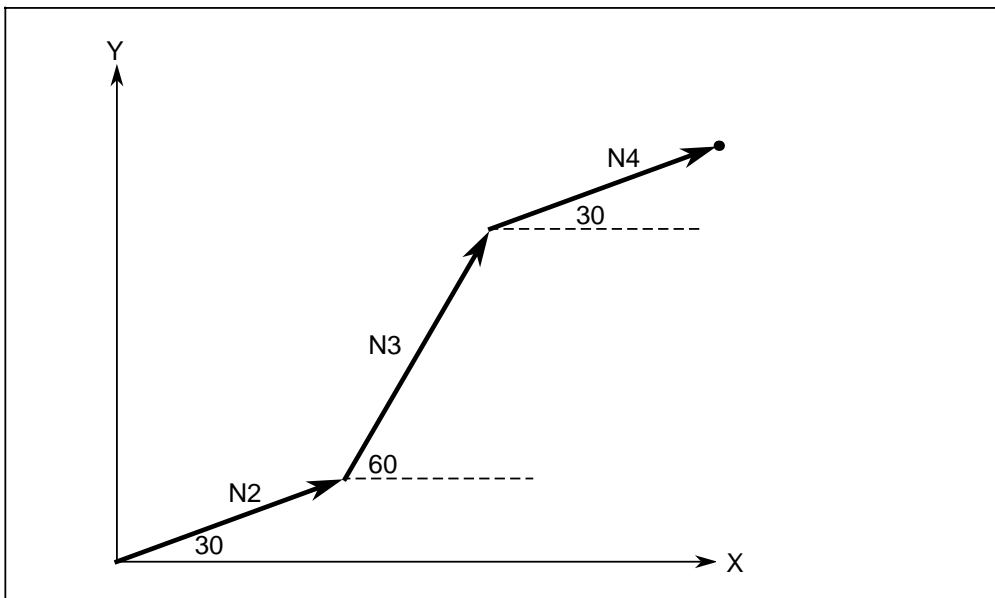

**Bit 3:** Bit 3 = 1: The old "PRESET OFFSET" is assumed automatically once more after approach to the reference point.

**Active: Immediately**



**Bit 2: Active: Immediately**

Bit 2 = 0, auxiliary function output during travel

Bit 2 = 1, auxiliary function output before travel

If an auxiliary function (M, S, T, H, D) is also programmed in a traverse block, the following two states may occur with the aid of **bit 2**:

**Example:** N 10

N 15 M6 X100 LF

N 20

With MD 5003, bit 2, functions G62/G64 can no longer be processed!

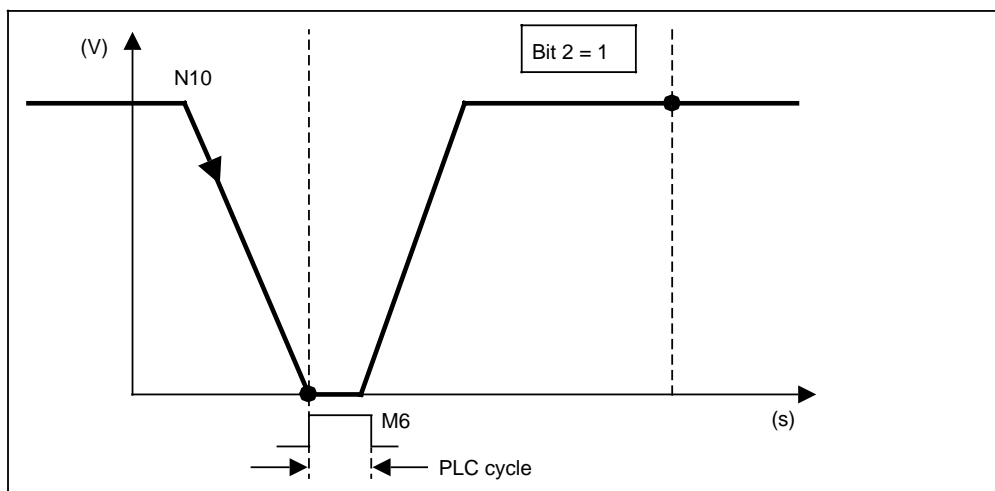
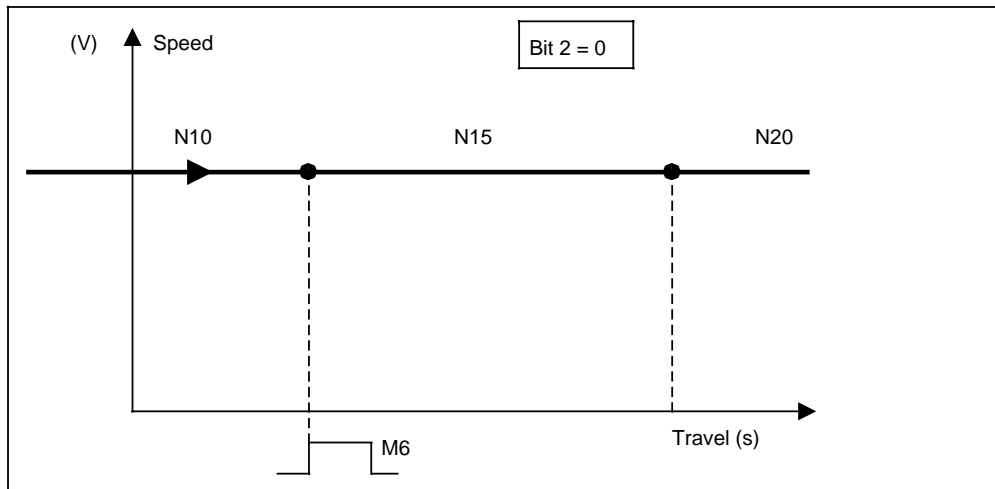

**Bit 1, 0: Active: After simulation start**

Up to Software Version 2, with these bits you can define whether the programmed zero offsets G58 and/or G59 should be included in the calculations for the graphic simulation or not.

From Software Version 3 the setting is made in NC MD 5045 to 5048.

The settable ZOs (zero offset) are generally not included in the calculation for simulation.

**Bit 1:** From Software Version 6

Bit 1 = 1 If the function overstore is triggered in a channel in which "Read-in disable" or "NC Stop" is active, the auxiliary functions can be corrected or deleted at any time and overstore can be triggered in other channels.

Bit 1 = 0 Overstore as usual.  
If the function overstore is triggered in a channel in which "Read-in disable" or "NC Stop" is active, the auxiliary functions can no longer be corrected or deleted and overstore is not possible in other channels. The message "Overstore still active" is displayed.

<b>5004</b>		<b>NC MD</b>						<b>5004</b>	
Bit No.									
7	6	5	4	3	2	1	0		
	Mode group- specific single block type B	Mode group- specific single block type A	Own rapid traverse override	NC-Start without ref. point	3.	2.	1.		
Handwheel available									

**All bits active: Immediately**

- Bit 6:** The first channel to have processed a block brings the other channels in the same mode group to a stop. When next started, the stopped axes continue to operate at the stop point. The channel triggering the stop starts with the next block. Single block type B.
- Bit 5:** The next NC start is only active if all channels in the same mode group have processed their block and if the axes are stationary. Single block type A.
- Bit 4:** The rapid traverse override switch usually featuring 4 positions (MD 147 to150) is transmitted automatically by the PLC to the interface, where it is then sampled by the NC with bit 6 = 1. It is only active with G00.
- Bit 3:** The "NC START" PLC signal (DB10-17 DR2 bit 0) initiates program start even if the reference points have not been approached, i.e. the feed axes are not synchronized with the machine position. In this case MD 560\* bit 4 has no significance. In order to ensure correct workpiece machining, synchronization must be performed otherwise, e.g. using the scratch method.
- Bit 2,1,0:** The number of available handwheels is specified, e.g.

Bit 2	Bit 1	Bit 0	Meaning
0	0	1	1 handwheel
0	1	1	2 handwheels
1	1	1	3 handwheels

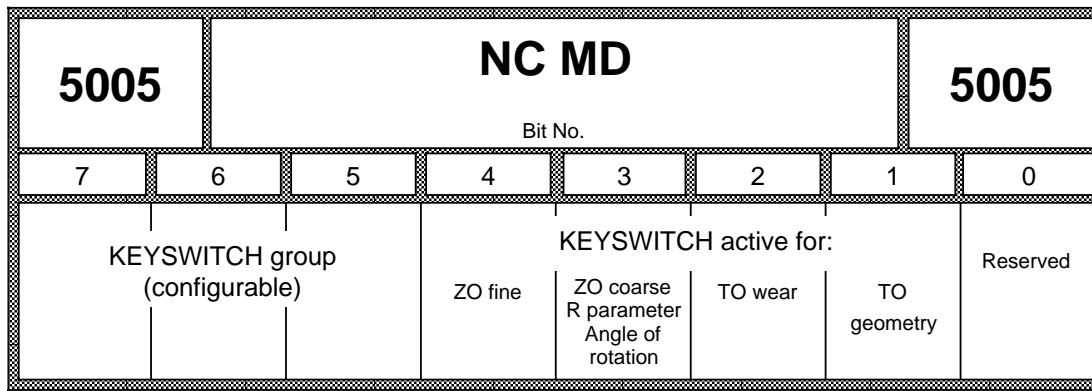

**Active: Immediately**

**Bit 7-5:** Used to inhibit configurable data records via keyswitch (also see WS 800 Description).

**Bit 4-0:** If the corresponding NC MD bits are set input and modification via the NC operator Panel can be locked with the keyswitch:

Bit 4: Zero offset (G54-57) , fine

Bit 3: R parameter turning angle ZO (G54 to G57), coarse

Bit 2: TO wear (parameter P5 to P7)

Bit 1: TO geometry

Bits 2 and 1 are only active if the standard display for tool offsets (P0÷P9) is not altered. When configuring tool offsets, the keyswitch group (bits 5 to 7) for the data fields (P0 to P<sub>xy</sub>) must also be configured with the programming workstation (WS 800).

Bit 0: Reserved (always 0)

5006		NC MD						5006	
Bit No.									
7	6	5	4	3	2	1	0		
KEYSWITCH active for:									
	Axis converter	Selection Initial reset mode from SV 6	TEACH IN PLAY- BACK	PP manual input and PP handling	Dry Run	DRF	OVER- STORE		

**Active: Immediately**

**Bit 7-0:** It is the corresponding NC MD bits are set input and modification via the NC operator Panel can be locked with the keyswitch:

- Bit 6: Modification of axis addresses for axis converter
- Bit 5: It is no longer possible to select initial reset mode when NC MD 5006, bit 5 (keyswitch active with initial reset) is set and keyswitch is in "Off" position.
- Bit 4: TEACH-IN, PLAYBACK function (see also Operator's Guide)
- Bit 3: For input of part programs via operator panel (EDIT, INPUT, CANCEL) and for PP-handling (COPY, RENAME, DELETE)
- Bit 2: For selecting dry run feedrate
- Bit 1: For traversing via handwheel in automatic mode (DRF function)
- Bit 0: For transferring (overstoring) H, S, M, T, D functions in OVERSTORE mode

<b>5007</b>		<b>NC MD</b>						<b>5007</b>	
Bit No.									
7	6	5	4	3	2	1	0		
TO over diameter	TO wear not active	mixed program- ming G90/91 in Block (from SW3)	Simultan- eous SIMULA- TION (from SW2)	Basic tool dimension active	No output of M17	G53 as for @706	Length compens. also with non-prog axes		

**Active: In next block**

**Bit 7:** **Bit 7 = 0** Cutter (tool parameter P1 = 20) is defined as length (P2) and **radius** (P4).

Note also NC MD 5008 bit 4.

**Bit 7 = 1** Cutter is defined as length and **diameter**.

Cutter radius for a turning tool is always a radius.

Bit 7 affects P4 and P7 for 20...39.

**Bit 6:** All tool wear data can be declared invalid. The tool wear data (P5 to P7) can then be used for any user-specific purpose.

A value can then be added to or subtracted from the tool geometry data using the "EDIT" key.

**Bit 5:** In a part program you always define for a whole block (up to LF) if the programmed values are to be interpreted as absolute (G90) or incremental (G91). There are numerous exceptions to this rule, for example scaling a circle centre, which must always be specified as incremental (G91) referring to the circle's initial point.

From Software Version 3, if bit 5 = 1, you can define in front of every program value (axis, interpolation parameter, angle) whether the value is to be interpreted as absolute (G90) or incremental (G91). (For interpolation parameters and angles see also NC MD 5003 bit 4 and bit 5).

	Axes	Interpol.Par.	Angles
Machine data 5003 Bit4, 5=0 G90	ABS	ABS	ABS
Machine data 5003 Bit4, 5=0 G91	INK	INK	INK
Machine data 5003 Bit4=1 G90	ABS	INK	ABS
Machine data 5003 Bit4=1 G91	INK	INK	ABS
Machine data 5003 Bit5=1 G90	ABS	INK	ABS
Machine data 5003 Bit5=1 G91	INK	INK	ABS
INK = Incremental ABS = Absolute			

**Example:**  
N1 G01 X50 Y60 F500 LF  
N2 G91 X50 Y40 LF  
N3 G90 X60 G91 Y30 LF  
N4 M30 LF

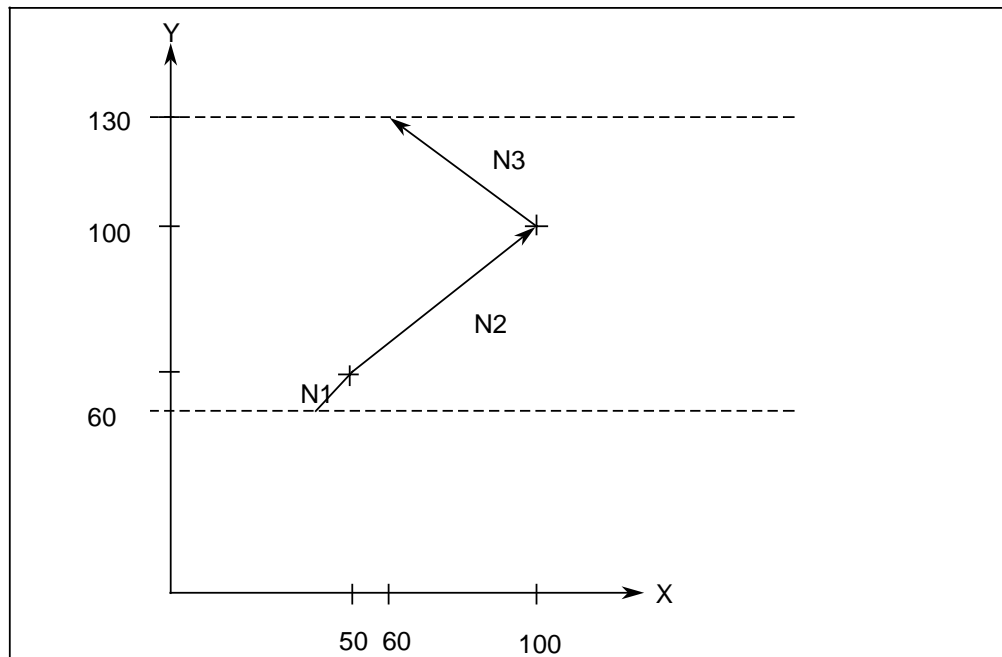

- Bit 4:** With enabling of simultaneous simulation (simulation during machining), there is the danger of the machine not performing properly since machining and simulation are not completely separate in the CNC. When this bit is set, the customer must be made aware of the particular dangers.
  
- Bit 3:** TO can be expanded by an additional two parameters (P8, P9) (see also Programming Guide).
  
- Bit 2:** **Bit 2 = 0** Subroutine end (M17) is issued to the PLC as an M function.  
**Bit 2 = 1** Subroutine end active only internally in NC (fast execution with subroutine return).
  
- Bit 1:** **Bit 1 = 0** With G53 all zero offsets (G54-G59 + ext. ZO) are cancelled.  
**Bit 1 = 1** With G53 and @706 all zero offsets (G54-G59 + ext. ZO), DRF and PRESET are cancelled. Tool offset (TO) is not cancelled.

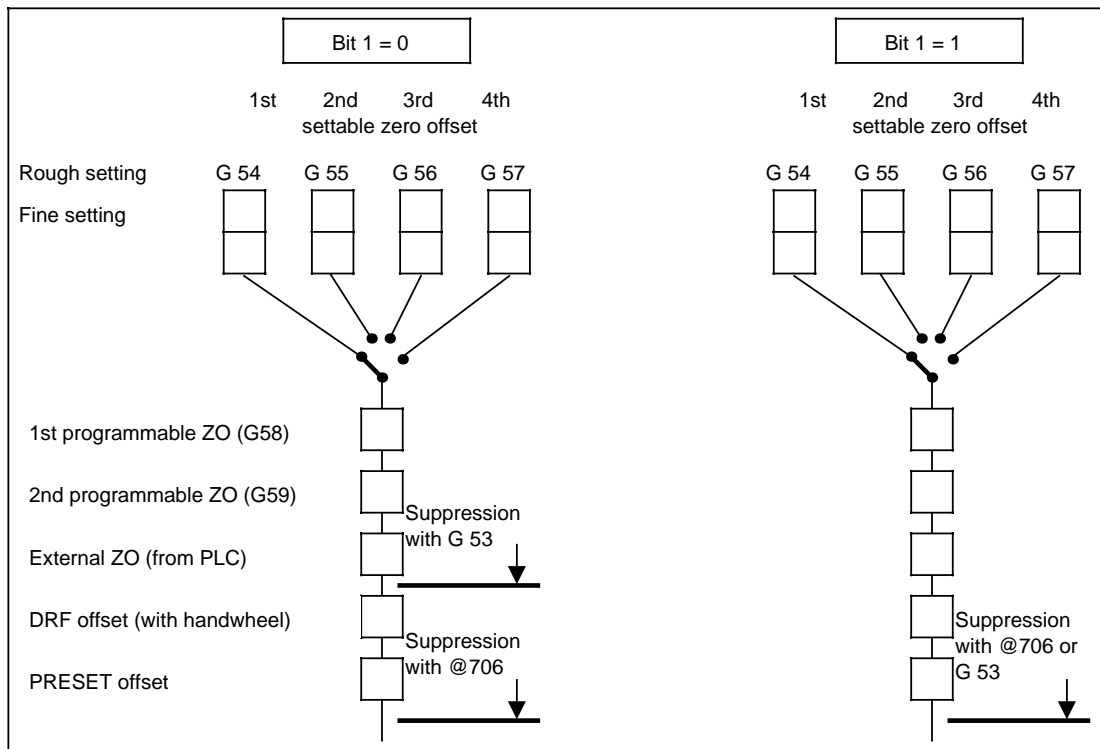



**Bit 0:** Scan tool length compensation and zero offset even if axes are not programmed (only SINUMERIK 880T):

If the change in tool length compensation (e.g. cancelled by means of D0) yields a traversing path in one of the first two axes an axis which is not programmed in this block, traversing is nevertheless performed. If the bit is not set, traversing is only performed when the axis has been programmed. The bit is only active if an axis apart from the first two axes is programmed.

**Example of programming for 880T:**

```

:
:
N5 G18 G0 X0 Z0 LF
N10 G01 F200 D3 X10 LF           D3 ...Type 3 (turning tool)
N20 Z30 LF                     Length 1  30
:                               Length 2  20
:
:

```

With the bit set, the length compensation (Z axis during milling) is already moved in block N10 to position Z20.

If the bit is not set, the Z axis is first moved in block N20 to position Z50 (Z30 + length compensation).

<b>5008</b>		<b>NC MD</b>						<b>5008</b>	
Bit No.									
7	6	5	4	3	2	1	0		
Path dim. from PLC w/out NC STOP (from SV 3)	REPOS in JOG mode	INC and REF in JOG mode	Tool type 0 as for type 20	Tool offset value monitoring from SV 6					

**Active: Immediately**

- Bit 7:**    **Bit 7 = 0**    Path dimension from PLC (via command channel) is only started in the modes AUTOM./MDA, if the preselected NC channel is in the NC STOP state. If the NC channel is only stopped with a read in disable at the end of block, the path dimension is **not** started. For safety reasons we recommend you not to set bit 7.
- Bit 7 = 1**    Path dimension from PLC (via command channel) is started in modes AUTOM./MDA on NC STOP or with read in disable at end of block. It might happen that path dimension selected from the PLC sets the read in disable and the running part program block was prematurely aborted by NC STOP (tool brake, "NC STOP" key, ...). Now the function path dimension would be started from the PLC immediately and not at the end of the block. For this reason we recommend that you do **not** set bit 7.
- Bit 6:**    **Bit 6 = 0**    In REPOS mode the path back to the contour is started by pressing the appropriate direction key for a short time. The axis movement can now be stopped with feed hold or feed override 0%.
- Bit 6 = 1**    You can only reapproach the contour as long as you are holding the appropriate direction key pressed.
- Bit 5:**    As for bit 6 but for modes INC1 ... 10 000 and reference point.
- Bit 4:**    This bit can be used to determine whether as
- Bit 4 = 1**    If the value 0 or 20 is in tool parameter P1, this is defined as the milling cutter.
- Bit 3:**    **Bit 3= 0**    Monitoring of tool offset values
- Values entered in tool wear memories P5, P6 and P7 are checked by the input key and EDIT key for their maximum values. If the maximum value is exceeded, this is displayed in the input line. The maximum values are set in machine data MD 208/MD 209. The maximum values are:  
 +/-99999999    +/-999.99999.
- Tool offset parameters P0 and P1 are also monitored.
- Bit 3= 1**    No tool offset values are monitored.

5009		NC MD						5009	
Bit No.									
7	6	5	4	3	2	1	0		
Double slide user interface (from Software Version 3)	Graphic tool editor (from Software Version 3)	Erase graphics (from Software Version 3)	Data enable simulation (from Software Version 3)	Blank optimization (from Software Version 2)					

**Bit 7:** From Software Version 3 the user interface in graphic simulation can be selected for a double slide machine (single spindle) (precondition: option "graphic simulation").

SINUMERIK 880 T:	0	.....	Single slide
	1	.....	Double slide single spindle
SINUMERIK 880 M:	0	.....	Milling simulation
	1	.....	not permissible

**Caution!**

A modification of this NC MD only becomes active after POWER ON.

**Bit 6:** From Software Version 3 the graphic tool editor can be selected with the softkey "tool" in the menu tree for graphic simulation (precondition: option "graphic simulation").

Without the tool editor the tool data can only be entered via lists or the serial interface.

**Bit 5:** From Software Version 3 you can enable broken line graphics and erase graphics (for turning graphics and milling graphics) (precondition: option "graphic simulation").

**Bit 4:** NC MD 5007 bit 4 is no longer required from Software Version 3 and has been replaced by this bit. Simultaneous simulation (simulation simultaneous to processing) is now always enabled.

You can define whether right accesses to data to which the NC channels also have access are permitted.

Same data for simulation and NC channels can be:

- R parameters R900 to R999
- MIB parameters
- Settable zero offsets G54 to G57
- Scale centre
- Scale factor
- NC setting data bits 5000 to 5999
- NC machine data
- PLC machine data
- Tool offsets

If access is enabled the operator has to make sure that the simulation does not override any data of the NC channels (NC and simulation channels must not access the same data).

**Bit 3:** The construction of the picture and the cyclic updating of the picture is accelerated noticeably if special routines are activated for blanks. This bit is set as a standard.

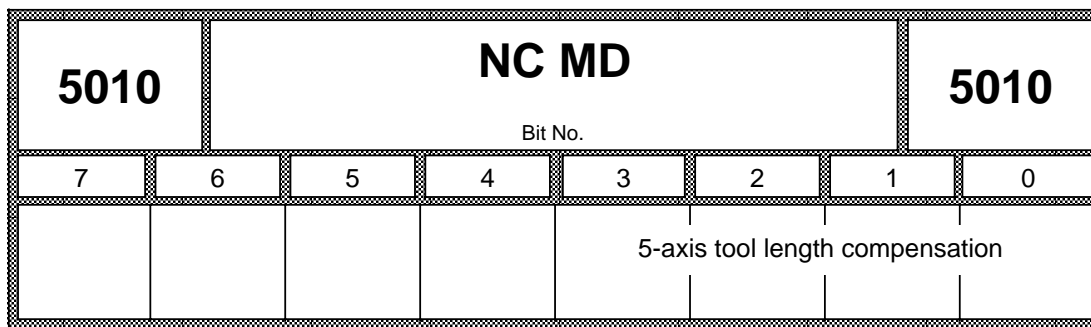

**Active: In next block**

	Bit 3	Bit 2	Bit 1	Bit 0	
Gimbal head	0	0	0	1	(from Software Version 3)
Twist & nod head	0	0	1	0	(from Software Version 3)
Nutating head	0	1	0	0	(from Software Version 2)
Inclinable head (parallel Y)	0	1	0	1	(from Software Version 3)
Inclinable head (parallel Z)	0	1	1	0	(from Software Version 3)

### 5-axis tool length compensation

5-axis tool length compensation is an option.

5-axis tool length compensation corrects the programmed block end points for short linear blocks (4 mm max.) as a function of the milling head type. In the event of tool failure, the milling machine may continue to operate at the failure point if a tool with the programmed radius but a different length is loaded. The differential length (50 mm max.) is entered as the tool compensation as for tool type 40.

This assumes that the programs have been generated at the computer to incorporate the tool length and radius.

5-axis tool length compensation is called using MD 5010 and tool type selection 40. In the case of milling machines with a nutating head, the fixed nutating angle must also be written in NC MD 20.

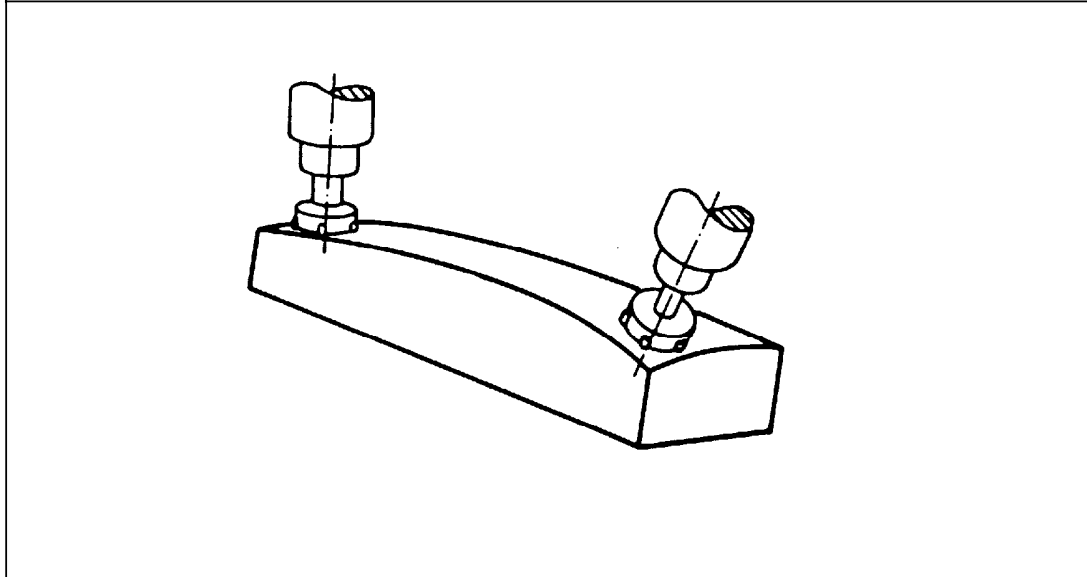

Principle of 5-axis tool length compensation (positioning of cutter in 5 axes)

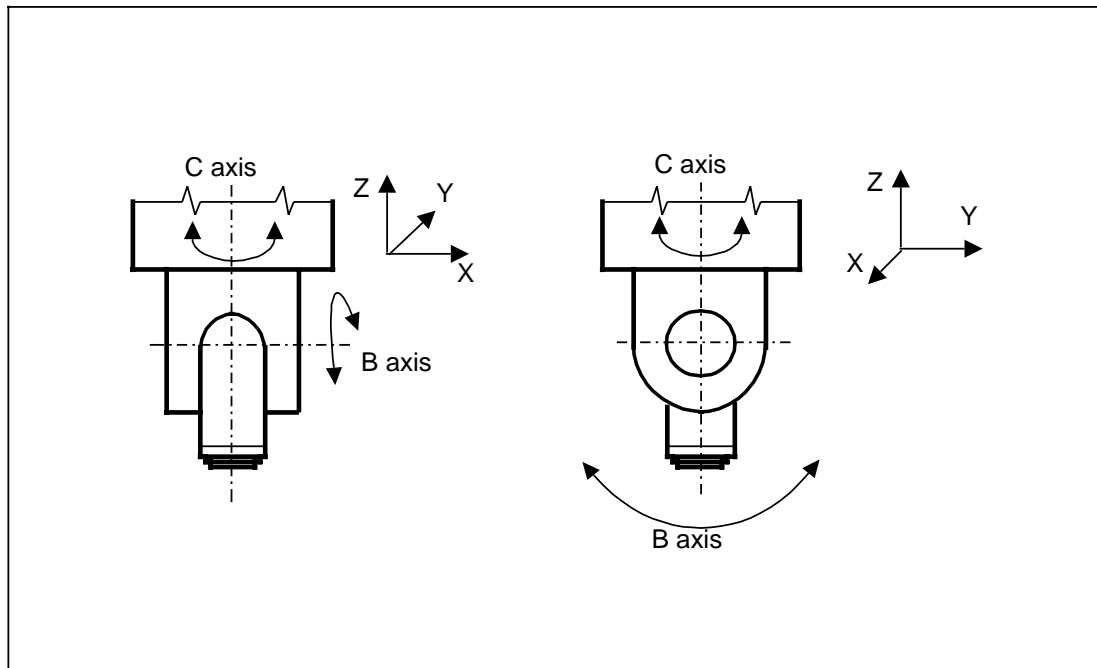

Gimbal head

The B axis is along the Y axis for  $C = 0$ .  
The tool is parallel to the Z axis if  $B = 0$ .

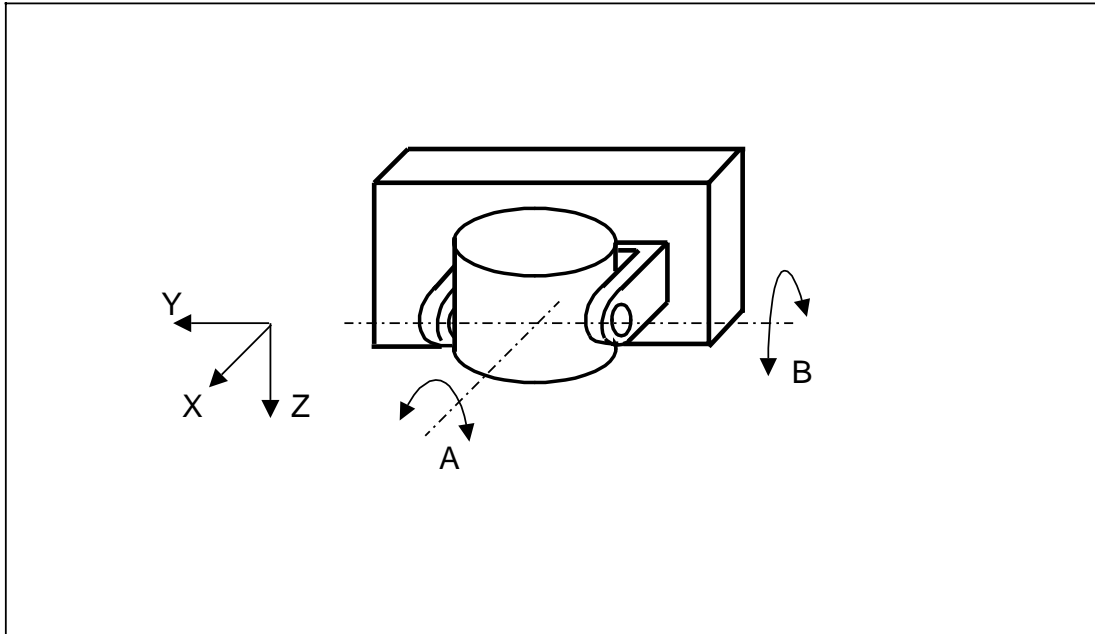

*Twist and nod head*

The tool is parallel to the Z axis if  $A = B = 0$ .  
 The A axis is always about the X axis.  
 The B axis is about the Y axis for  $A = 0$ .

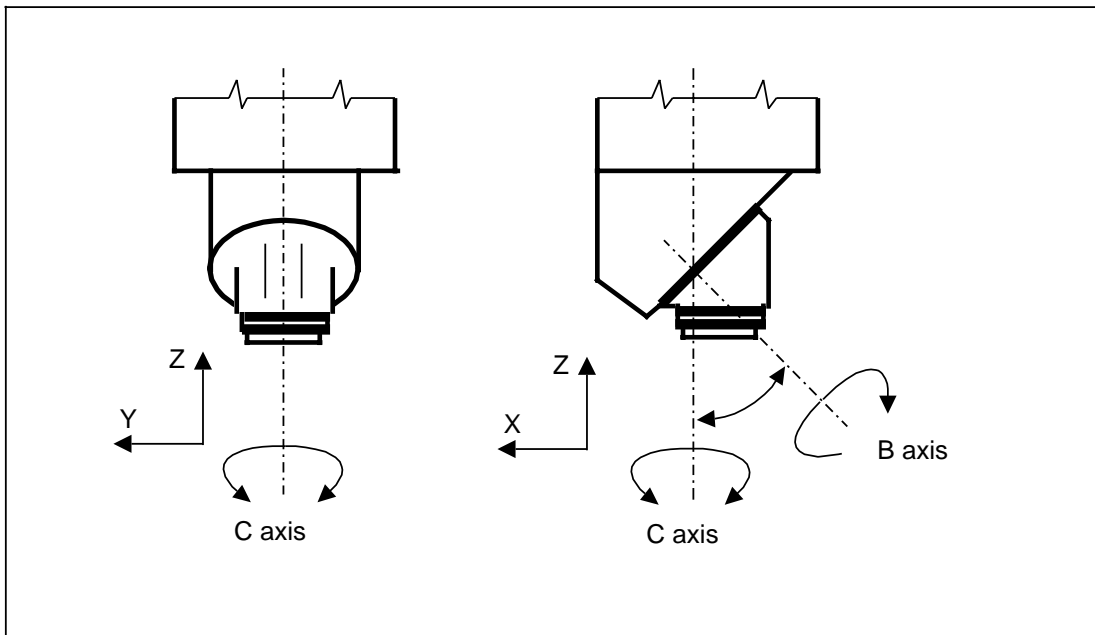

*Nutating head*

The tool is parallel to the Z axis for  $B = C = 0$ .  
 The B axis is in the X-Y plane for  $C = 0$ .

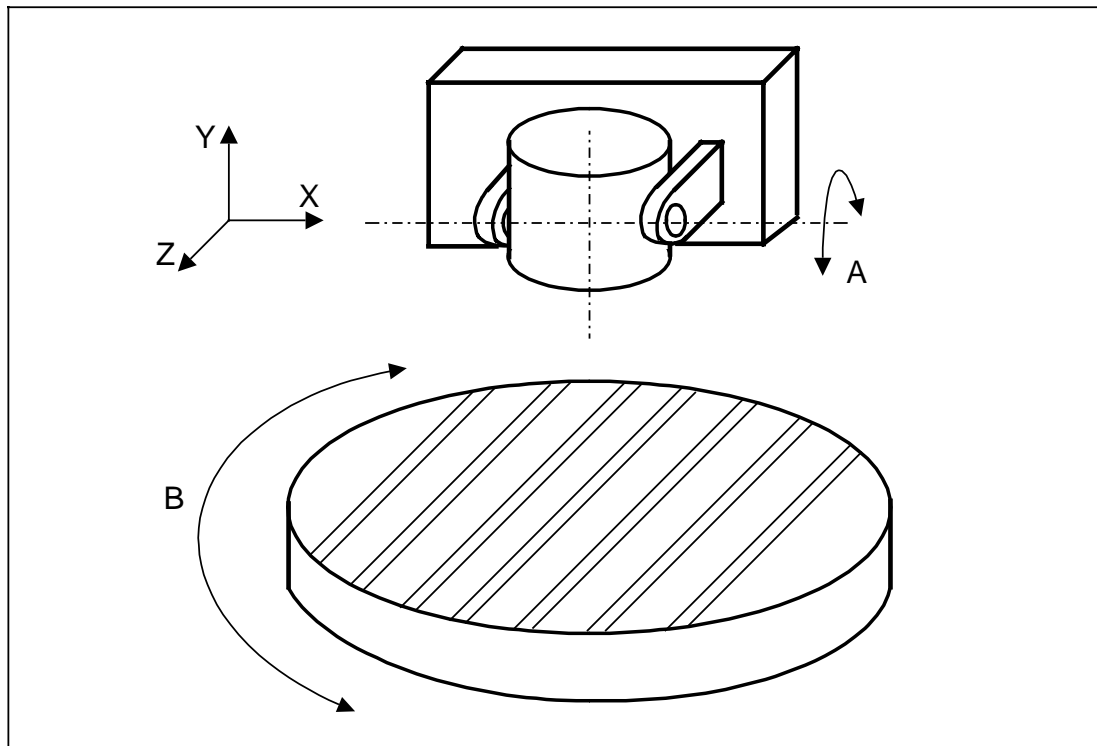

*Inclinable head (cutter parallel to Y axis)*

The rotary table (axis C) turns around the Z axis.  
The swivel head (axis B) turns around the Y axis.  
The swivel area around B is usually  $-45^\circ$  to  $+45^\circ$ .  
With  $A = 0$  degrees the cutter is parallel to the Y axis.



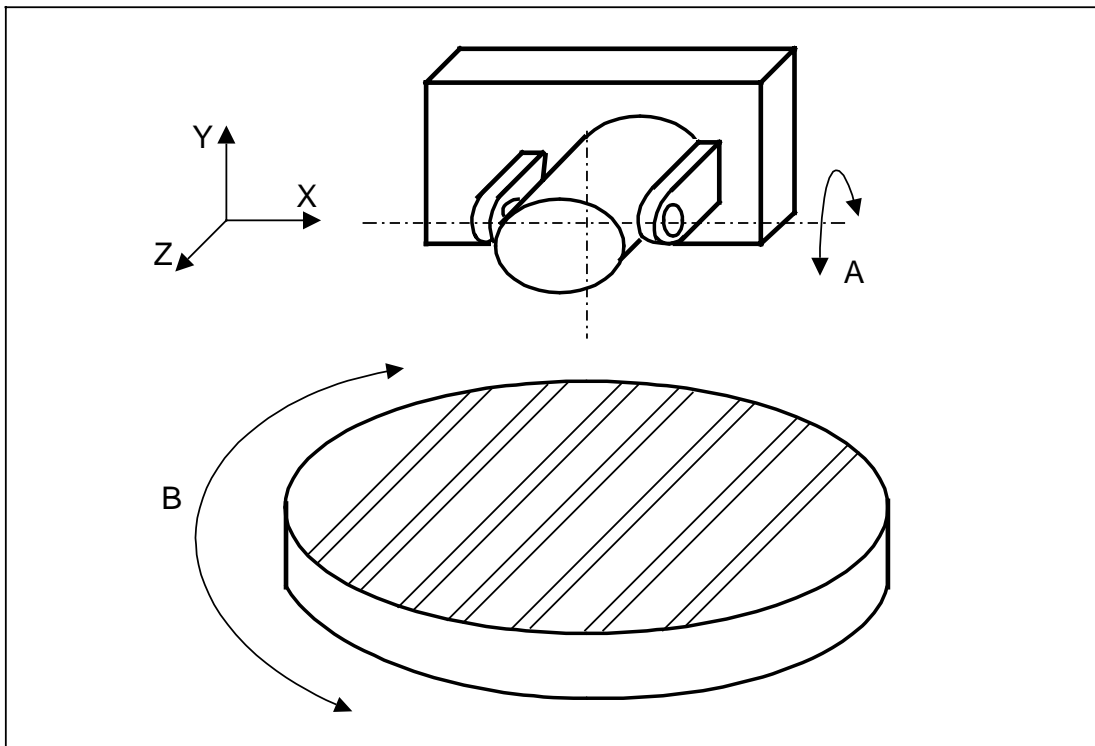

*Inclinable head (cutter parallel to Z axis)*

The rotary table (axis C) turns around the Z axis.  
 The swivel head (axis B) turns around the Y axis.  
 The swivel area around B is normally  $-45^\circ$  to  $+45^\circ$ .  
 If  $A = 0$  degrees the cutter is parallel to the Z axis.

<b>5011</b>		<b>NC MD</b>						<b>5011</b>	
Bit No.									
7	6	5	4	3	2	1	0		
Read and write @ over diameter	Actual value display over diameter	Diameter prog. G91	Diameter prog. with G90 TO over diameter	Tool length for tool types 1-9 over diameter	Inc. hand-wheel DRF over diameter	Adj. ZO prog. ZO over diameter			

**Active: In next block**

All the bits in NC MD 5011 act on the axes defined as facing axes by NC MD 572\* bit 1. If no facing axis was defined (NC MD 572\* bit 1 = 0) all bits in NC MD 5011 must be set to zero.

- Bit 7:** All axis-specific @ for axes defined as a facing axis must be entered over the diameter and are written over the diameter. (CL 800)
- Bit 6:** The actual value and workpiece-related actual value are displayed over the diameter (see also NC SD 5001 bit).  
The actual values in the axis-specific service displays are still shown as radii.
- Bit 5:** For G91 programming is performed over the diameter.
- Bit 4:** For G90 programming is performed over the diameter. Tool offset wear (P5) for tool types 1-9 is entered and displayed over the diameter.
- Bit 3:** The tool length (P2) for tool types 1-9 is entered and displayed over the diameter.
- Bit 2:** With INC handwheel and DRF handwheel, the input resolution is active over the diameter. DRF offset is displayed over the diameter.
- Bit 1:** Adjustable ZO and programmable ZO are entered, programmed and displayed over the diameter.  
External ZO, PRESET offset, distance to go and REPOS are displayed over the diameter.

5012		NC MD						5012	
Bit No.									
7	6	5	4	3	2	1	0		
			Softkeys green inverse (from Software Version 3)	Cursor text status (only Software Version 3)	MD modi- fication with @4.. disabled (from Soft- ware Version 3)				

**Bit 4:** Up to Software Version 2 the softkeys are displayed green.  
From Software Version 3 and the modes are always displayed INVERSE.

**Active: After POWER ON**

Bit 4 = 0 ... white inverse  
Bit 4 = 1 ... green inverse

**Bit 3:** From Software Version 3 the cursor text colour can be influenced.

**Active: After POWER ON**

Bit 3 = 0 ... Cursor text colour yellow  
Bit 3 = 1 ... Cursor text status is shown in the picture description.

Dialog texts are always displayed light blue to distinguish them.

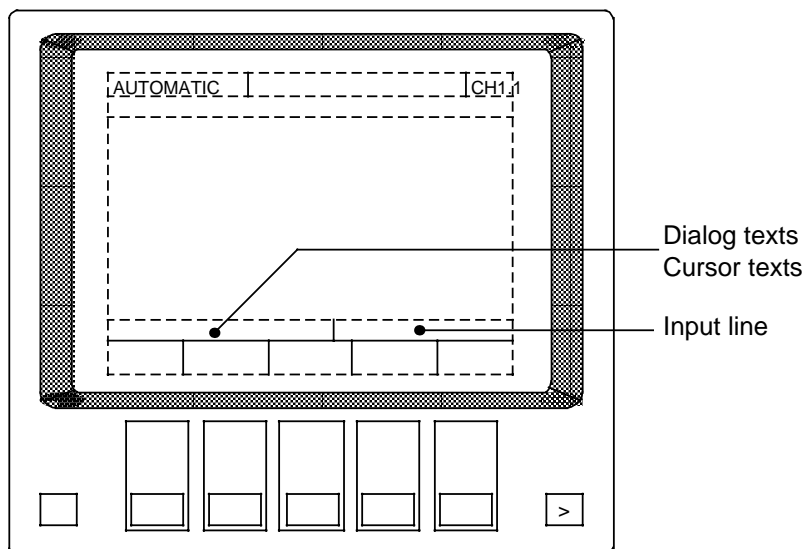

**Bit 2:** From Software Version 3, writing from NC MD, PLC MD and cycle MD with @ commands @ 4... (CL 800 commands) can be disabled with bit 2.

**Active: In next block**

<b>5013</b>		<b>NC MD</b>						<b>5013</b>	
Bit No.									
7	6	5	4	3	2	1	0		
Circle radius prog.			Feed not referred to contour		M and S address extension for spindle to PLC	Tapping without encoder (G63)	G63 without decel.		

**Active: In next block**

**Bit 7:** With the bit set, a circle can be programmed by specifying the radius and/or angle.

**Bit 4:** The programmed feedrate refers to the cutter centre path (tool nose radius centre path).

**Example for 880 M:**

**Bit 4 = 0** (feedrate at contour constant)

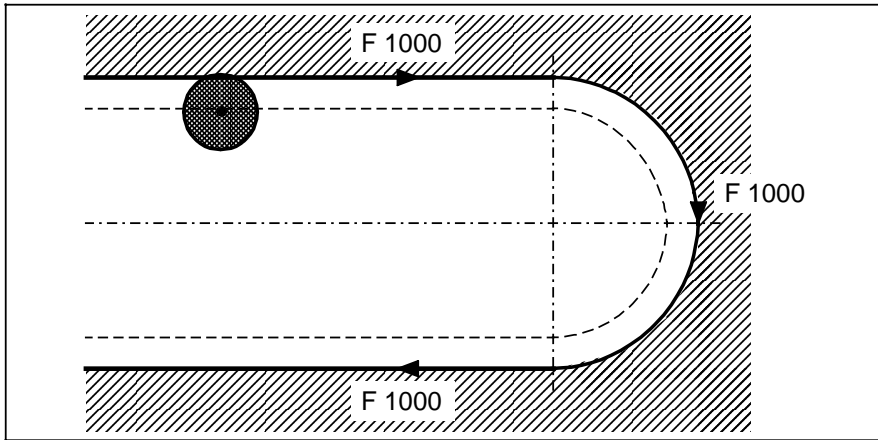

**Bit 4 = 1** (feedrate of cutter constant)

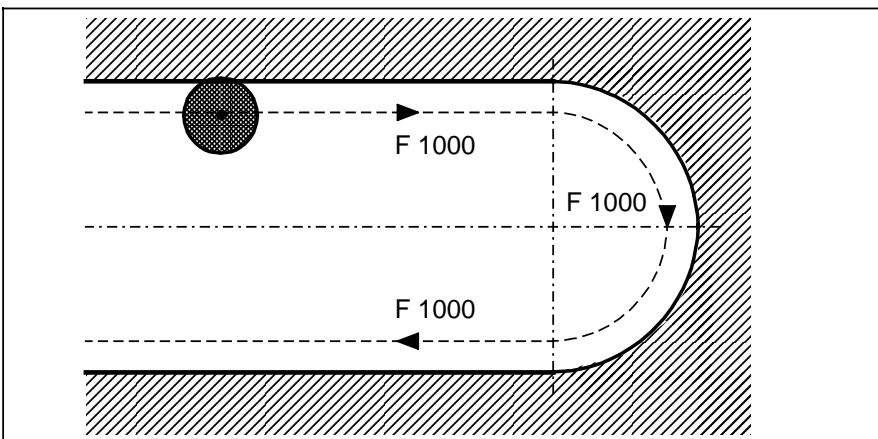

- Bit 2:** This bit is used to select where the programmed M and S address extension or the extension automatically generated by the controller is to be transferred to the interface to the PLC (this extension is always active in the control).  
This bit must be set if there is more than one spindle in the control.  
From Software Version 5: the leadscrew is automatically extended in the channel without MD 5013.2 being set.
- Bit 1:** For tapping with the Siemens L84 cycle (G84) using the SINUMERIK 880 M, it is necessary to specify whether a ROD encoder is available at the spindle.
- Bit 1 = 0** The spindle has an encoder (512 or 1024 pulses). Therefore G33 (lead in mm/rev) is used in tapping cycle L84.
- Bit 1 = 1** The spindle does not have an encoder. Therefore G63 (F in mm/min) is used in tapping cycle L84. The programmer has to specify the feedrate and spindle speed in such a way that the correct thread lead is obtained. Minor errors are eliminated by the floating tap holder.
- Bit 0:** At the block limits in G63 programming (tapping without encoder), it is possible to determine if the new spindle speed setpoint value (reversal) is output to the drive and a block change initiated.
- Bit 0 = 0** The block change and the output of a new spindle speed setpoint value occurs after exact positioning fine (drilling axis) and the acknowledgement of the M function (spindle reversal) via the PLC.
- Bit 0 = 1** The block change and the output of a new spindle speed setpoint value occurs when the interpolator (not the position controller with exact positioning fine) has reached the programmed drilling depth (i.e. sooner than the position controller with exact positioning fine). The acknowledgement of the M function (spindle reversal) via the PLC does not occur in this case.

<b>5014</b>		<b>NC MD</b>						<b>5014</b>	
Bit No.									
7	6	5	4	3	2	1	0		
TNRC/ CRC		Cycles (ref. prep.)	Nibbling, laser machining 1st chan. (880N only)						

**Active: In next block**

**Bit 7:** TNRC/CRC T : Activating of tool nose radius compensation  
 M : Activating of cutter radius compensation

**Bit 5:** Cycles: This bit activates reference preparation (software submodule) which is essential for cycle processing with stock removal cycle L95.

**Bit 4:** Nibbling, laser machining in the 1st channel: This bit must be set for all nibbling and laser functions.

<b>5015</b>		<b>NC MD</b>						<b>5015</b>	
Bit No.									
7	6	5	4	3	2	1	0		
	UMS available			Speed optimized text output (from SW 3)	Graphics	External data input			

**Bit 6:** The UMS (user memory submodule) with 128 K RAM (6FX1126-6BA), 128 K EPROM (6FX1123-6AE) and 256 K EPROM (6FX1128-4BA) configurations is inserted in the 6FX1128-1BA memory module in the COM area on the 3rd slide-in unit at the bottom position. In the case of the RAM configuration, UMS data transfer is only possible in commissioning mode. The NC interface is to be set to line-driven data transfer, 2 stop bits without parity and 9600 baud. NC UMS output is initiated via WS 800. The Universal Interface Configuring Instructions contain information on cable connections.

**Active: After POWER ON**

**General remarks on UMS EPROM programming**

The file created at WS 800 **must** be transmitted with the **REC** program.

Definition of the FAMILY PINOUT CODE depends on the module configuration:

Input after function: FAMILY 93-32-32 corresponds to a semi-complement module. The full configuration is automatically preset by the program with 93-32-34.

Module configuration options:

Semi-complement: D1 + D3 **or** D2 + D4  
Full complement: D1 + D2 + D3 + D4

Jumpers on 7FX1126-0B EPROM submodule:

Open: B2-B4-B7-B9-B11  
Closed: B1-B3-B5-B6-B8-B10

BLANKCHECK is used to perform a module empty test. The module data are determined and displayed using RESPOND.

### **Note**

When PG 685 is used, programs REC, R, SMOPRO etc. must be transferred to its hard disk and called from this point.

Data transfer WS 800 PG 675 with **REC**  
Link PC16-11 (SS2) PG 675 (printer)  
Cable 6XV1083-3AN10

### **PG 675**

- CP/M-86 operating system in drive A
- Formatted data floppy in drive B
- After A> has been displayed, remove floppy from drive A
- Insert program floppy PG 675, V 1.3 in drive A (**without write protect tab**)
- Press CTRL C
- A> REC
- File name: B. filename (UMS link list)
- Option: B or others

Display: PG empfangsbereit! (PU ready to receive!)

### **WS 800**

- Link objects, f7
- UMS list, f2
- Input: file name/option
- Transfer: f2
- PU output, f7

Transmission commences!

Programming of UMS EPROM submodule.  
EPROMs must be empty.

**Operating sequence at PG 675:**

- CP/M-86 operating system in drive A
- File data floppy in drive B
- After A> has been displayed, remove floppy from drive A
- Insert program floppy PG 675, V 1.3 in drive A (**without write protect tab**)
- Press CTRLC
- A>R MODPRO (or SMOPRO with MEP adapter)

Function:

**Only at this point in time** should the EPROM submodule be inserted!

Input after function:

PROGRAM B:     Filename option or  
                  filename.extension

The program sequence is empty test, read program, start program and verify.

Verify checks whether the contents of the submodule tally with the contents of the user memory. Enter END to quit the program.

**Bit 4:** From Software Version 6 with the "Execution from external" function, large part programs can be read from an external bulk storage device via the serial interface or computer link into the control and simultaneously processed (see also MD 30, MD 130\*, MD 5148-5152)

**Active: After POWER ON**

**Bit 3:** From Software Version 2 picture construction can be accelerated for graphic images if text is entered directly into text fields without first deleting the complete text field.

However unforeseen mixed colours can arise if the background colour of the text field (even of parts of the text field) is not black.

**Active: When new display is selected**

**Bit 2:** This bit the static graphics can be activated (not graphic simulation). This bit must be set in the Siemens Standard UMS is to be used in its full functional scope.

**Active: When new display is selected**

**Bit 1:** If data is to be read from or written into the NC by the PLC using FB61 or FB62 this bit must be set. This bit must be set if tool management (PLC package 1) and computer link are to be used.

**Active: After POWER ON**



5016		NC MD (from Software Version 4) Bit No.						5016	
7	6	5	4	3	2	1	0		
4th axis is technology axis		Decoupling of technology and non-technology axes on a Servo CPU							

**Bit 7:** 4th axis is a technology axis. Only active with 5016 bit 5 = 1 (from Software Version 4 using NC + Servo with 386'CPU)

1 signal: 1st, 2nd and 4th axis are technology axes.

0 signal: 1st, 2nd and 4th axes are technology axes.

This bit must be set for machines with the "Parallel axis for rotatable tool".

**Bit 5:** Decoupling of technology and non-technology axes on a Servo CPU (from Software Version 4 using NC + servo with 386'CPU).

From Software Version 4, MD 5016, bit 5, can be used to select decoupling of 3rd and 4th technology axes for nibbling (X, Y, tangential axes, possibly parallel axis to tangential axis) and non-nibble axes (loading axes and unloading etc.). This only possible with one servo CPU. Whether the 3rd or 4th technology axis is selected is determined with bit 7.

Rapid start is generated for the technology axes after stroke enable. Punch initiation follows exact stop of these axes.

The non-technology axes cannot then be used in the first channel of the NC CPU. Only then do the axes traverse independently of punch initiation. Exact stop of these axes is therefore not necessary for punch initiation.

<b>5021-5023</b>		<b>NC MD</b> <b>(from Software version 5)</b>				<b>5021-5023</b>	
		Bit No.					
7	6	5	4	3	2	1	0
			FA overlay division-re- lated	Suppression of accelera- tion limita- tion	Block change with fine synchronism	Sensitivity attenua- tion compen- satory controller	Following error compen- sation ON

**Caution:**

These MDs have a different meaning with the synchronous mode function (see Function Manual "Extended spindle functions").

**Active: Immediately**

**Bit 0:** "Following error compensation ON"

1 signal: Traversing for following error compensation is active.  
 Following error compensation is effective only with LINK ACTIVE. It can be activated in parallel with the feedforward control. The feedforward control must however first have been set.

0 signal: Traversing for following error compensation is not active.

**Comment:**

- Before activation of the following error compensation function, the effective  $K_V$  factor (MD 951, 971, 991) and the time constant of the parallel model (MD 950, 970, 990) for the following axis must have been determined exactly.
- Traversing for following error compensation is used for actual value linked leading axes and also when changing over the following axes to "Automatically controlled correction".

**Bit 1:** "Sensitivity attenuation compensatory controller"

1 signal: The sensitivity for the compensatory controller response is attenuated. The P and D components of the compensatory controller respond only when speed deviations greater than 10 increments occur. This allows a smoother setting of the running characteristic for the following axis.

0 signal: The compensatory controller responds even to the smallest speed deviations and attempts to compensate for these by means of an additive set speed for the following axis.

**Note:**

When loading the standard machine data, the machine data bit is preset with "1" signal.

**Bit 2:** If this bit is set, by G201 with no angle, a block change in the NC is initiated when the following spindle reaches "Fine synchronism" after runup.

If the bit is not set, the block change is initiated after a fixed delay (the settling time) when synchronous speed is reached. In the case of overlaid following axes a block change is initiated if:

- All partial setpoints of the block are output
- A delay of  $4 \times MD950$  has elapsed
- Fine synchronism has been selected.

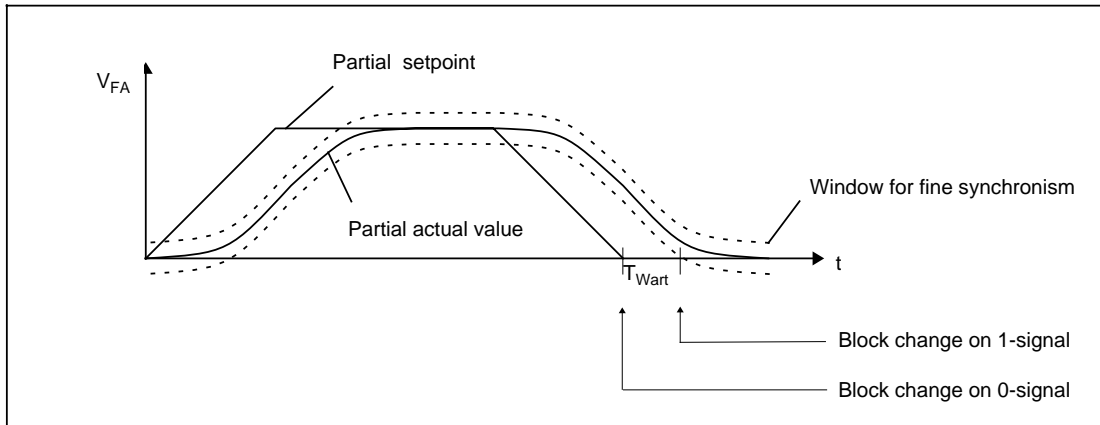

**Bit 3:** "Suppression of acceleration limitation"

1 signal: "Acceleration limitation is not active"

With LINK ACTIVE, the acceleration of the following axis is not limited by the control but output directly, as determined by the leading axes. If the value of MD 276\* is exceeded, no alarm message is output.

0 signal: "Acceleration limitation active"

With LINK ACTIVE, the acceleration of the following axis is limited to the acceleration value set by machine data (MD 276\*).

**Bit 4:** "FA overlay division-related"

1 signal: The overlaying movement of the following axis takes place in the indexing grid. On the other hand, the movements of the following axis caused by the leading axis are not used to determine the set indexing position. Linking and synchronization operate unchanged. The following axis must be defined as an indexing axis. The indexing grid is defined with MD 1104\* and MD 1108\*.

0 signal: The indexing grid is not taken in account for overlaying movements of the following axis.

<b>5024</b>		<b>NC MD</b>						<b>5024</b>	
Bit No.									
7	6	5	4	3	2	1	0		
							Abort if contour violated  Alarm 3021		

**Bit 0:** If, during machining with active tool nose/cutter radius compensation (G41/42), a movement occurs in the opposite direction to the programmed direction of travel, alarm 3021 set.

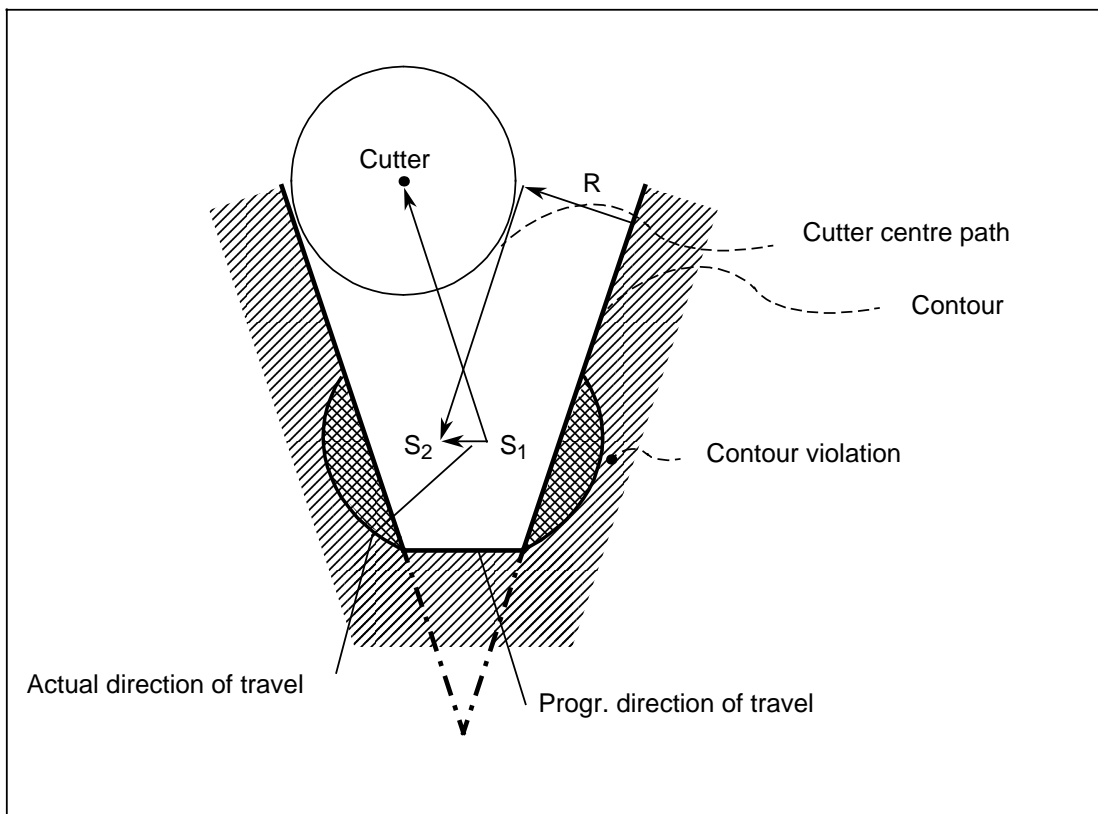

From the example it is clear that the contour will be damaged.

**Bit 0 = 0** With contour monitoring by the tool nose/cutter radius compensation (TNRC/CRC) machining is aborted. Alarm 3021 is given and can be cleared with the acknowledgement key.

**Bit 0 = 1** With contour monitoring by the tool nose/cutter radius compensation (TNRC/CRC) machining is aborted. Alarm 3021 is given and can only be cleared with the reset key.

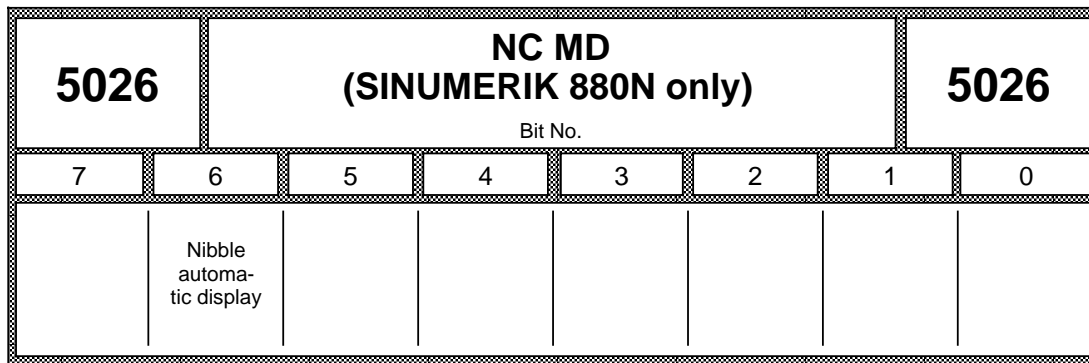

Bit 6      Nibble Automatic display

<b>5027</b>		<b>NC MD (SINUMERIK 880N only)</b>				<b>5027</b>	
Bit No.							
7	6	5	4	3	2	1	0
Laser minimum voltage not equal to zero	Laser current after reset = 0, for analog output on mixed I/O board	X1, Y1 and Y2 as an auxiliary function		Switch off modal function of the tangential axis with Mx21	Modal function of the tangential axis		Output of Mx22/Mx24 on servo interface

- Bit 7**      Laser minimum voltage not equal to zero  
 The laser minimum voltage does not drop to the voltage value zero when the laser power control is inactive (e.g. path speed equal to zero) but to the 1st laser voltage (U1) defined as key data for the laser power control.
  
- Bit 6**      Laser voltage after reset = 0, for analog output on mixed I/O board  
 The analog output voltages, their display and the current S functions are cleared (bit 6 = 1).
  
- Bit 5**      X1, Y1 and Y2 as an auxiliary function  
 The translations X (X1) and Y (Y1) for minipatterns, and the programmable tool change position in Y (Y2) are used as auxiliary functions. Because they are selected as auxiliary functions they can no longer be used as axis designations.
  
- Bit 3**      Switch off modal function of the tangential axis  
 The modality of the tangential control is cancelled not with Mx20 but with Mx21.
  
- Bit 2**      Modal function of the tangential axis  
 The tangential axis is programmed once in the part program with Mx22/Mx25 and E/H and activates the tangential control until it is deselected with Mx20.
  
- Bit 0**      Output of Mx22/Mx24 on the servo interface  
 For machines with eccentric punches the functions Mx22 and Mx24 are output on the output module in the servo area. This means that the eccentric can quickly switch between two different speeds for nibbling.

5028		NC MD (SINUMERIK 880N only)					5028	
Bit No.								
7	6	5	4	3	2	1	0	
M*00-M*37/M*47 group selection for fast and initial M functions for laser power control		Fast M functions M*00 to M*37/ M*47	Clamps on operator's side	Selection clamp protection procedure		Number of clamps present		

**Bit 6 Bit 7** M\*00 - M\*37 / M\*47 group assignment

The 100th decade for the fast M functions M\*00-M\*19 and the remaining M functions M\*30-M\*37/M\*47 of the laser power control can be freely configured.

Bit 1	Bit 0	x	M
0	0	1	M100-M119, M130-M137/M147
0	1	2	M200-M219, M230-M237/M247
1	0	3	M300-M319, M330-M337/M347
1	1	4	M400-M419, M430-M437/M447

**Bit 5** Fast M functions, see also bits 6 and 7

The fast M functions are output directly on the I/O module available as a standard in the SINUMERIK 880N without an acknowledgement flag with the PLC. This occurs on block change without a delay.

Mx ..	Bit on I/O
00	Bit 0 on
01	Bit 1 on
02	Bit 2 on
03	Bit 3 on
04	Bit 4 on
05	Bit 5 on
06	Bit 6 on
07	Bit 7 on
08	Bit 0 1 2 3 on
09	Bit 4 5 6 7 on

Mx ..	Bit on I/O
10	Bit 0 on
11	Bit 1 on
12	Bit 2 on
13	Bit 3 on
14	Bit 4 on
15	Bit 5 on
16	Bit 6 on
17	Bit 7 on
18	Bit 0 1 2 3 on
19	Bit 4 5 6 7 on

**Bit 4: Clamps on the operators's side**

The clamps are located on the side of the machine facing the operator.

**Bit 2 Bit 3: Selection protection procedure**

Bit 2	Bit 3	Function
0	0	<b>Avoid clamps:</b> The clamps defined via R parameters are avoided with the programmed speed. Up to two extra blocks can be generated in this way.
0	1	<b>Reduced speed:</b> Within a clamp protection area defined via R parameters a reduced speed is used to traverse. The traverse paths from an into the clamp protection area are divided into two parts, one with the programmed and the other with the reduced speed.
1	1	<b>Deselectable clamp avoidance:</b> Clamp avoidance is deselected via a freely configurable M function (MD 243) (see above). The clamp protection areas then act as working area limitations. After programming an M function from the Mx20 group the clamps are avoided with the programmed speed. If this clamp avoidance has been selected the clamps are monitored in JOG and INC modes too.

**Bit 0 Bit 1: Number of clamps present**

Bit 1	Bit 0	Function
0	0	2 nclamps present
0	1	3 clamps present
1	1	4 clamps present



5029		NC MD (SINUMERIK 880N only)						5029	
Bit No.									
7	6	5	4	3	2	1	0		
Tangential angle output related to direction of movement		T programming generate is @714	Output of auxiliary functions at clamp protection limit	Selection of tangential control via tangential axis programming	No punch initiation on Mx26/Mx27	Updating the damp prot. area types with T prog. (revolver)	E value monitoring		

- Bit 7:** Tangential angle output related to direction of movement at G02/G03  
Bit=0 angle data refer to center point  
Bit=1 angle data refer to direction of movement  
The option "analog tangential angle output" is necessary.
- Bit 5:** T programming generates @714  
When T is programmed the buffer for decoding is automatically deleted (simulation of @714). In this way it is possible that changes in the **EXTERNAL** zero offsets which were initiated by another channel (on T modification) can be allowed for in the calculations. In this block it is only possible to program T.
- Bit 4:** Output of auxiliary functions at clamp protection limit (from Software Version 4)  
Bit = 0 auxiliary function output at clamp protection limit with insertion blocks.  
Bit = 1 no output of auxiliary functions (Mx20) at clamp protection limit with NC-internal insertion blocks.
- Bit 3:** Selection of tangential control via tangential axis programming (from Software Version 4)  
Tangential control selection is independent of an E/H segmentation with stroke activation. Only programming the tangential axis name activates the tangential control.  
It is still possible to influence the maximum angle of rotation via the G function.
- Bit 2:** No punch initiation on Mx26/Mx27  
Punch initiation is suppressed on programmed Mx26/Mx27. The M functions are output and can be processed externally.  
(e.g. delayed initiation of the punch).
- Bit 1:** Updating the clamp protection area types with T programming (tool revolver)  
The clamp protection area is updated with the T number programming in conjunction with the tool revolver.
- Bit 0:** E value monitoring  
A value stored in R parameters for Mx22 or Mx24 is accepted as the maximum possible nibble increment. Large programmed E values are limited to these values in the nibble modes. application on excentric punch presses.

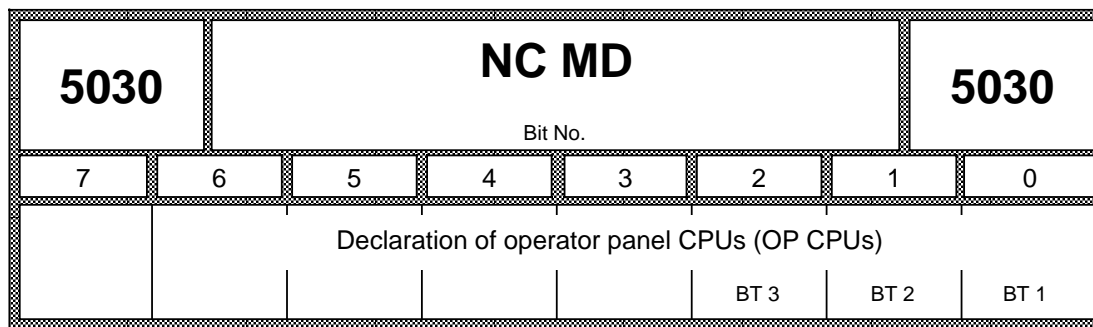

**Active: After POWER ON**

**Bit 0:**    **Bit = 1**    Number of operator panels (CPUs) is specified.

**Bit = 0**    Corresponding OP CPU is not available.

**Caution:**

Only declared CPUs are monitored in case of failure.

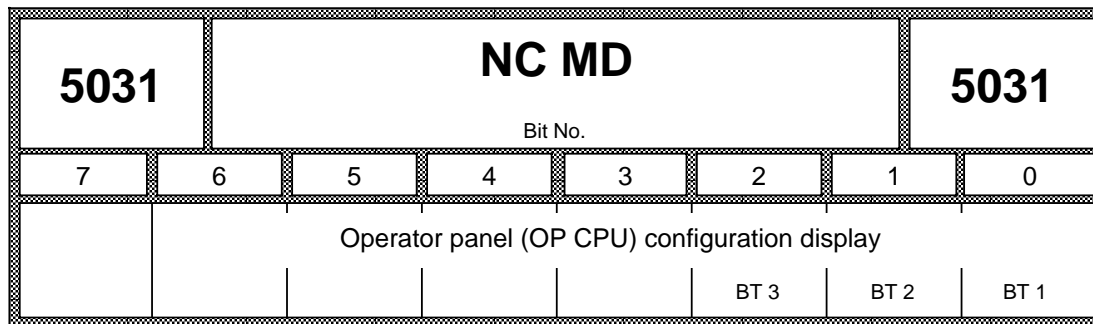

With these bits, the control indicates how many operator panels are connected or how many operator panels it recognizes irrespective of NC MD 5030.

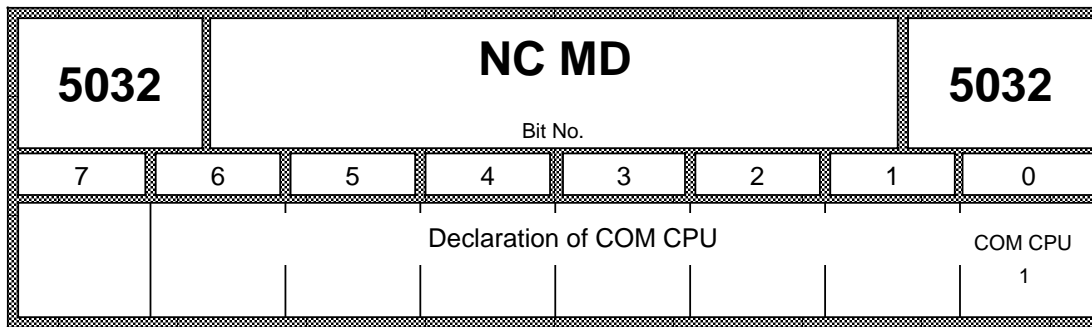
**Active: After POWER ON**

With this data, the person installing specifies the number of COM CPUs (6FX1120-4BA) available in the control.

Mandatory input on SINUMERIK 880: 0000 0001

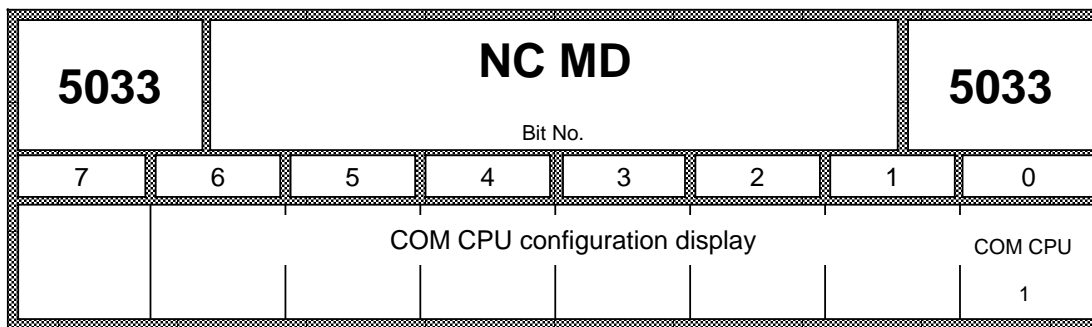

With this data, the control indicates how many COM CPUs it recognizes.

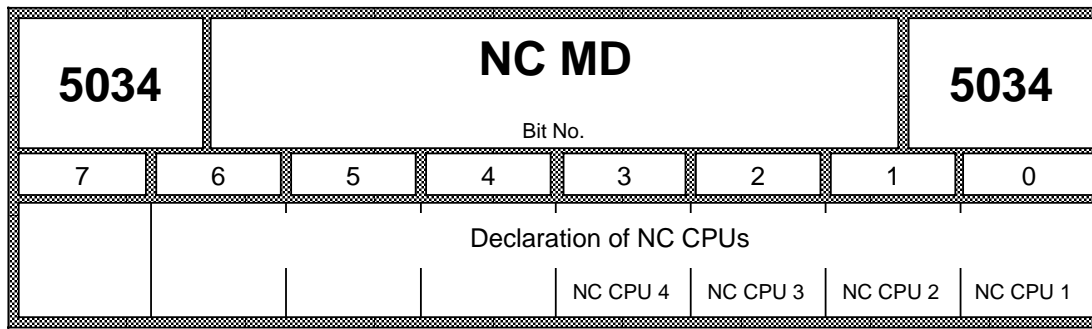

**Active: After POWER ON**

With this data, the person installing specifies the number of NC CPUs.  
 For SINUMERIK 880 max. four NC CPUs.

**Caution:**

Only declared CPUs are monitored in case of failure.

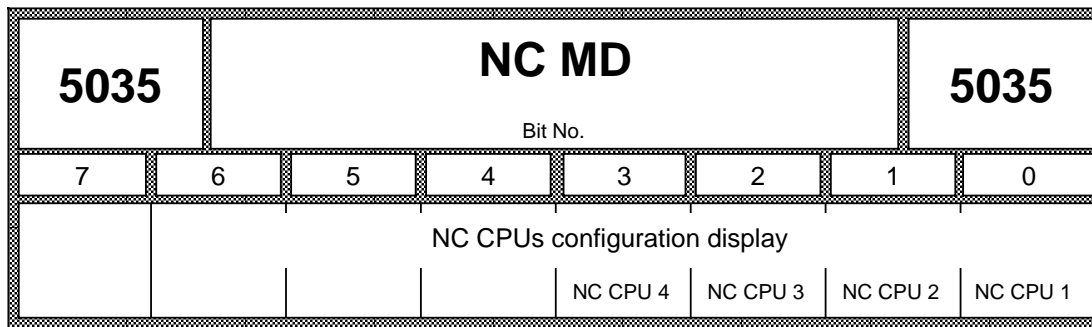

With this data, the control indicates how many NC CPUs it recognizes.

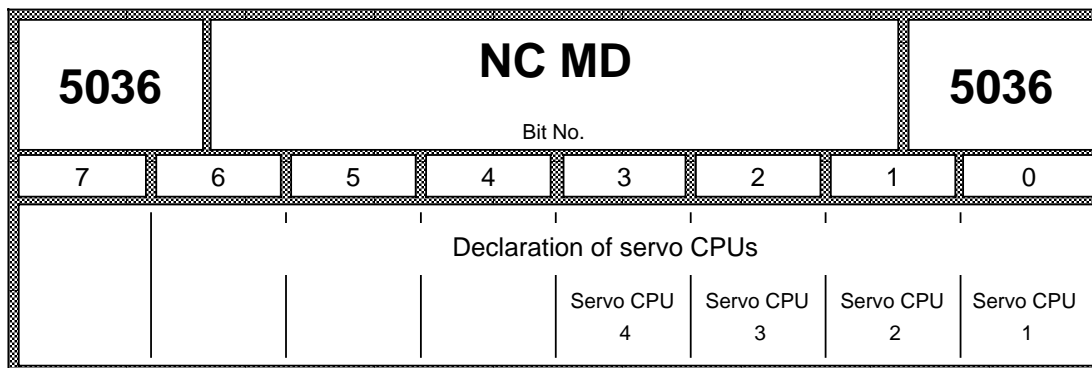

**Active: After POWER ON**

With this data, the person installing specifies the number of servo CPUs.  
 For SINUMERIK 880 max. four servo CPUs.

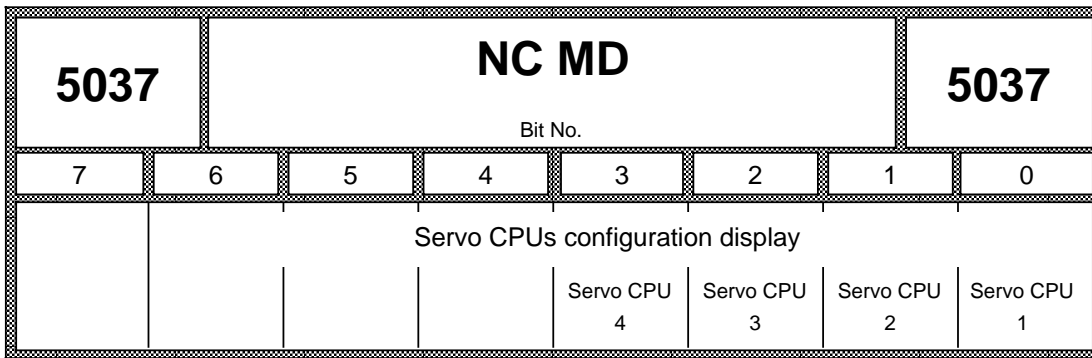

With this data, the control indicates how many servo CPUs it recognizes. The servo CPU houses only the axis position control / spindle control (also see NC MD 155, 160 to 163).

**Caution:**

Only declared CPUs are monitored in case of failure

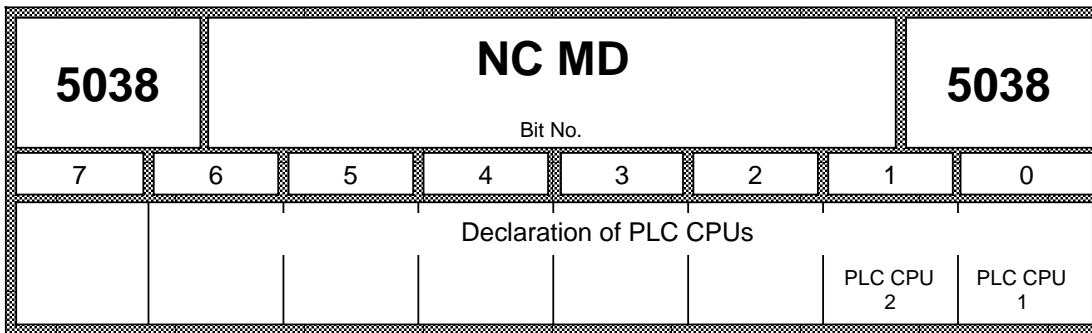

**Active: After POWER ON**

With this data, the person installing specifies the number of PLC CPUs.

**Caution!**

With bit 1 = 0 (no PLC CPU 2) the relevant PLC MD must be set to 0.

**Note:**

From Software Version 4 up to two PLC CPUs (2x 135 WB) are possible.

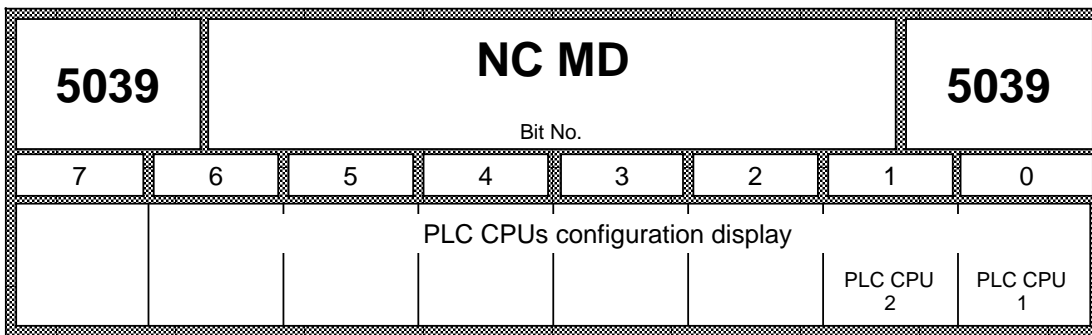

With this data, the control indicates how many PLC CPUs it recognizes.

**Note:**

From Software Version 4 up to two PLC CPUs (2x 135 WB) are possible

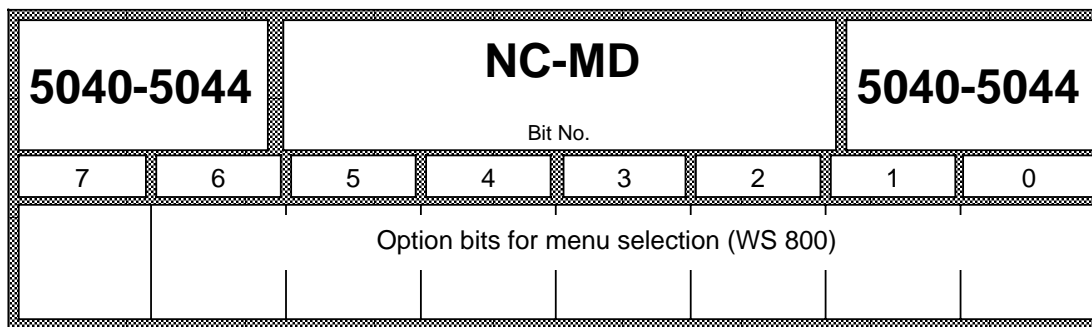

**Active: After simulation start**

See WS 800 Description.

NC MD	Bit No.							
	7	6	5	4	3	2	1	0
<b>5045</b>	Simultaneous tool paths (broken line graphics)							
			Settable ZO	Progr. ZO	Length correction	TNRC/ CRC		
<b>5046</b>	Simulation actual value display (broken line graphics)							
			Settable ZO	Progr. ZO	Length correction	TNRC/ CRC		
<b>5047</b>	Simulation tool paths (animated graphics)							
			Settable ZO	Progr. ZO	Length correction	TNRC/ CRC		
<b>5048</b>	Simulation actual value display (animated graphics)							
			Settable ZO	Progr. ZO	Length correction	TNRC/ CRC		

NC MD	Bit No.							
	7	6	5	4	3	2	1	0
<b>5045</b>				0	1	0	0	0
<b>5046</b>				0	1	0	0	0
<b>5047</b>				0	1	1	1	0
<b>5048</b>				0	1	0	0	0

**Active: After simulation start**

From Software Version 3, by setting these bits you can determine whether on graphics simulation the actual value display and the display of the tool or the display of the tools is to be executed with or without calculation of the offsets (CRC, TNRC, tool length correction, programmable ZO, settable ZO). You must set separately for broken line graphics (NC MD 5045, 5046) and animated graphics (NC MD 5047, 5048).

- Bit 4:** The settable zero offsets G54 and G57 are calculated if the corresponding enable is given in the simulation data image as well (see also Operator's Guide).  
The settable coordinate system rotation is simulated independently of NC MD bits.  
The external zero offset, the PRESET offset and the DRF offset are generally **not** calculated.
- Bit 3:** As bit 4 but for programmable zero offsets.  
The programmable coordinate system rotation is always simulated independently of the NC MD bit.
- Bit 2:** The tool length corrections (tool parameters P2 and P3) of the current D No. are included in the calculation. The tool wear (tool parameters P5 to P7) and the tool basic dimension (tool parameters P8 and P9) are generally **not** included in the calculation.
- Bit 1:** With cutters (tool type 20) the programmed cutter radius compensation (CRC) G41 or G42 is taken into account. If the bit is **not** set, G41 or G42 are displayed like G40.  
with NC MD 5045 this bit does not exist.  
The tool nose radius compensation (TNRC) is generally **not** taken into account (also see Operator's Guide).

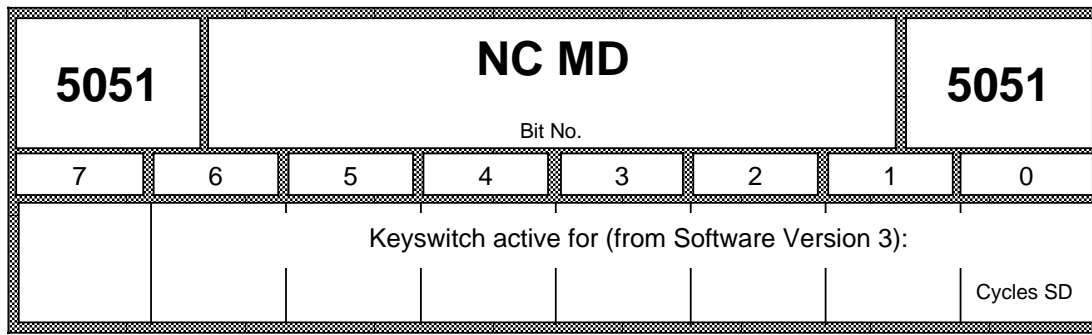

From Software Version 3, with the following data by setting the corresponding NC MD bits input or modification via the NC operator panel can be disabled with the keyswitch.

**Bit 0:** Cycle setting data



5056		NC MD (SINUMERIK 880N only)				5056	
Bit No.							
7	6	5	4	3	2	1	0
Laser power control on 2nd spindle	Exact stop coarse/fine depending on the following error	No S function output to VDI interface when laser active		Mx20 Group assignment		Update No. of strokes	Tool wear

- Bit 7** Laser power control on 2nd spindle  
In addition to the laser power control on the 1st spindle an output voltage can be output on the 2nd spindle which varies according to the characteristic. The laser characteristic can be specified differently for the 2nd spindle than for the 1st spindle. The selection of the switching functions for the laser power control is done via 4 decade S functions for both spindle outputs simultaneously.
- Bit 6** Exact stop coarse/fine depending on the following error  
The exact stop signals are switched independently of the travel signals but depending on the following error. In this way a power reduction or shut down is possible during plasma machining depending on the travel speed.
- Bit 5** No output of S functions to VDI interface when laser is active.  
The transfer of laser-specific S functions through the VDI interface to the PLC is suppressed. This means that program processing is faster in short NC blocks, i.e. preventing "burning in" of laser beam at block transition (in connection with NC MD 5003.2 auxiliary function output before traversing).
- Bit 2, 3** Mx20  
The 100 decade of the nibble-specific M functions can be freely programmed.

Bit 1	Bit 0	X	M
0	0	0	M20 - M27
0	1	1	M120 - M127
1	0	2	M220 - M227
1	1	3	M330 - M327

- Bit 1** Update number of strokes  
Bit 1 = 0 No. of strokes is added  
Bit 2 = 1 No. of strokes is subtracted  
see also NC PLC special interface Section 3.1
- Bit 0** Tool wear (available soon)

5057		NC MD (SINUMERIK 880N only)						5057	
Bit No.									
7	6	5	4	3	2	1	0		
Pure laser machine			Laser voltage output on mixed I/O module	Rapid stop without alarm triggering	Punch initiation with exact stop coarse/fine	Accelerated start with punching	Decoupling of technology and non-technology axes		

- Bit 7**      Laser machine  
 The machine tool is used for pure laser/plasma machining. No nibbling functions are performed in the servo (e.g. Rapid start).
  
- Bit 4**      Mixed I/O module  
 Bit = 0          The analog voltage of the laser power control is output on the spindle setpoint output of the measuring circuit module  
 Bit = 1          Output is via the analog outputs of the mixed I/O module
  
- Bit 3**      Rapid stop without alarm triggering  
 If both inputs 0.1 and 0.2 of the input module on the servo bus are not high, a rapid stop of the axes is executed.  
 Bit = 0          Acknowledgement of the alarms (1120, 2061 and 3180) only with power on reset  
 Bit = 0          No punch initiation
  
- Bit 2**      Punch initiation with exact stop coarse/fine  
 0 = > Punch is initiated upon reaching exact stop coarse and I-Kill with the set position = 0 (low)  
 1 = > Punch is initiated upon reaching exact stop fine and I-Kill upon reaching exact stop coarse (low)
  
- Bit 1**      Accelerated start after punching  
 The fine interpolator provides a reduced start acceleration for the set speed. To be able to reach a high punch rate in punch mode, it is necessary to start with a high acceleration after feed enable. To obtain a higher starting acceleration the first two partial setpoints are added together.  
 Only active in program blocks with active punch initiation!
  
- Bit 0**      Machine data 5057 bit 0 can be used from this software version to select decoupling of technology axes for nibbling (X, Y, tangential axis, parallel axis to tangential axis, tool revolver axis) and non-nibble axes (loading and unloading axes etc.) (selected with MD 50507 bit 0 = 1). A second SERVO CPU is required for decoupling. All technology axes are assigned to the first SERVO CPU via MD 200\*. Rapid start is generated for all axes after stroke enable. Punching initiation follows exact stop of the defined axes. The non-technology axes are assigned to the second SERVO CPU via machine data 200\*. These axes must then not be used in the first channel of the NC CPU. Only then do the axes traverse independently of punching initiation. Exact stop of the axes is then not required for punch initiation. A voltage drop at fast inputs I0.0-I0.2 does not lead to rapid stop of the axes.

5059		NC MD (SINUMERIK 880N only)					5059	
Bit No.								
7	6	5	4	3	2	1	0	
Deselection of E/H segmentation		Accelerated block change after stroke initiation		0	0	Sampling interval ratio		

- Bit 7:** Deselection of E/H segmentation (from Software Version 4)  
E/H segmentation is suppressed, which means that more than 3 axes can be interpolated. This function is especially used in laser machining.
- Bit 5:** Accelerated block change after stroke initiation  
The block change is no longer dependent on the input signal I0.0 ("Punch in sheet"). After punch initiation a change to the next block is made immediately. This obviates the start delay after the enable by the input signal I0.0.
- Bit 3:** Must be assigned with 0.
- Bit 2:** Must be assigned with 0.
- Bit 1, 0:** Sampling interval ratio COM/NC/servo (from Software Version 4 where NC + servo with 386 CPUs is used).  
With this MD, the sampling intervals from the NC and/or servo CPU are reduced according to the following table:

MD 155 (COM)	MD 160	MD 5059		NC	SERVO	Correction of MD 5059
		Bit 1	Bit 0			
20	4	0	0 (1)	10	2.5	C
20	4	0	1	10	2.5	-
20	4	1	0	5	1.25	-
16	4	0	0 (1)	8	2	C
16	4	0	1	8	2	-
16	4	1	0	4	1	-
12	4	0	0	12	3	-
12	4	0	1	6	1.5	-
12	4	1	0	3	0.75	-
10	4	0	0	10	2.5	-
10	4	0	1	5	1.25	-
10	4	1 (0)	0 (1)	5	1.25	C
8	4	0	0	8	2	-
8	4	0	1	4	1	-
8	4	1	0	2	0.5	-

Combinations not permitted are automatically corrected by the control in the lines marked with a 'C' (correction).

NC MD	Bit No.								
	7	6	5	4	3	2	1	0	
<b>5060</b>									Channel number of the transformation
<b>5061</b>									G function for transformation selection
<b>5062</b>									Axis name 1st fictitious axis
<b>5063</b>									Axis name 2nd fictitious axis
<b>5064</b>									Axis name 3rd fictitious axis
<b>5065</b>									Axis name 1st real axis
<b>5066</b>									Axis name 2nd real axis
<b>5067</b>									Axis name 3rd real axis
<b>5068</b>									Axis name 4th real axis
<b>5069</b>									Axis name 5th real axis

**Active: After POWER ON**

NC MD 5060 to 5139 valid from software version 3

NC MD 5060 to 5069 . . . . . 1st Transformation data block  
 NC MD 5070 to 5079 . . . . . 2nd Transformation data block  
 . . . . .  
 . . . . .  
 . . . . .  
 . . . . .  
 . . . . .  
 . . . . .  
 . . . . .  
 NC MD 5130 to 5139 . . . . . 8th Transformation data block

For an exact description of the coordinate transformation TRANSMIT see Section 11.

Standard MD for a transformation record:

NC MD 5060	0000 0000
NC MD 5061	0000 0000
NC MD 5062	1111 1111
NC MD 5063	1111 1111
NC MD 5064	1111 1111
NC MD 5065	1111 1111
NC MD 5066	1111 1111
NC MD 5067	1111 1111
NC MD 5068	1111 1111
NC MD 5069	1111 1111

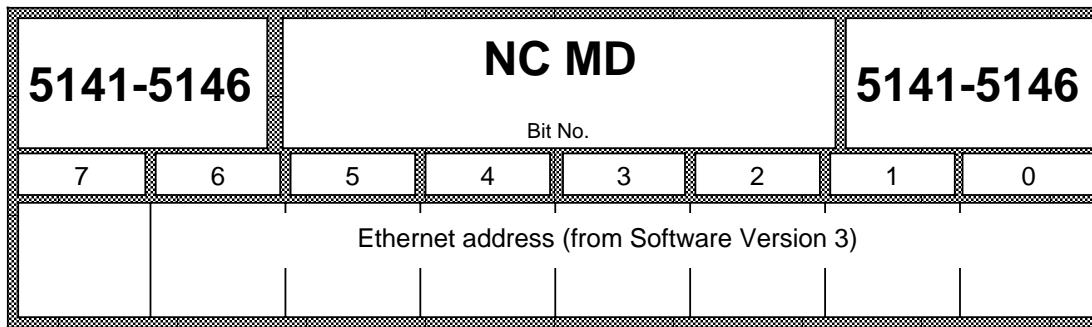
**Active: After POWER ON**

The Ethernet address is the bus interface address through which it can be addressed.

**Caution!**

The Ethernet address in the MD is only valid when no computer link is used.

NC MD	Ethernet address		
	(Dual)	Byte	Dez
5141	0 0 0 0    1 0 0 0	Byte 1	08
5142	0 0 0 0    0 0 0 0	Byte 2	00
5143	0 0 0 0    0 1 1 0	Byte 3	06
5144	0 0 0 0    0 0 0 1	Byte 4	01
5145	selectable	Byte 5	selectable
5146	selectable	Byte 6	selectable

The last four places of the Ethernet address indicate the bus interface.

<b>5147</b>		<b>NC MD</b>						<b>5147</b>	
Bit No.									
7	6	5	4	3	2	1	0		
				Changes when subroutines are read-in via file transfer (from Software Version 6)	Do not erase erase-protected programs (from SW 4)	Acknowledge message immediately (from SW 4)	Positive acknowledgement to end message (from SW 4)		

**Active: After POWER ON**

- Bit 2:** Programs being processed are not erased when an erase command arrives via transfer file. If the MD is **not** set the programs are not erased until they have not been enabled for erasing (at end of processing or on reset). No further messages are processed for file transfer.
  
- Bit 1:** On receipt of a message from the external partner (RNaaa\_\_) a request for transmission of further data is already sent to the external partner (TNaaa\_\_) before the data is entered in the memory. In this way the external partner can already be sending further data to the NC while the NC is still entering data into memory. If an error occurs while the data is being entered into memory, the message with the error is acknowledged as previously. The next message, which has already been requested and might be waiting in the dual-port RAM, is acknowledged with the error message "Function cannot be processed".
  
- Bit 0:** On receipt of an error-free end message from the external partner a positive acknowledgement (RNaaa\_E\_) is sent partner (REaaa\_\_) to the external partner. The NC also expects a positive acknowledgement (REaaa\_\_) from the external partner, if the NC has sent an end telegram to the external partner. Changes occur when subroutines are read in via RS232C/file transfer.
  
- Bit 3=1:** The program which is to be read in is not read in meaning that the EPROM cycle is still free for processing. Cancel alarm 3240 "SPF not read-in" is output. The program number in question is output in the block number of the alarm. Subroutines continue to be read in via RS232C/file transfer.
  
- Bit 3=0** The program to be read in is read in and is ready for processing. Cancel alarm 3239, "Cycle overwritten by SPF" is output. The program number in question is output in the block number of the alarm.



Logical partner receiver

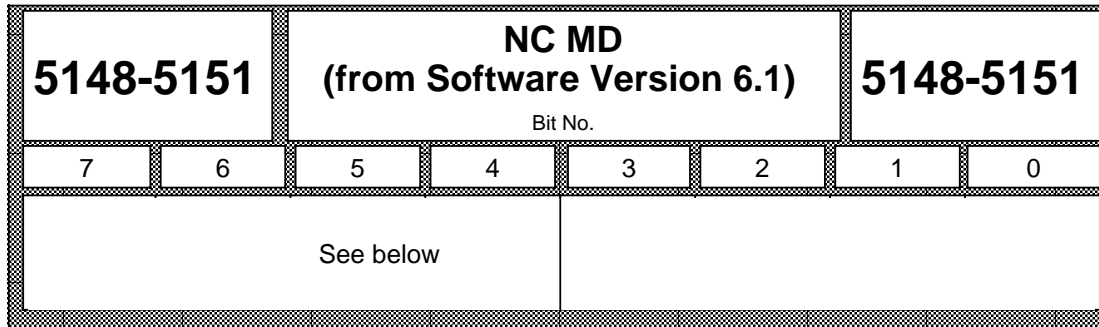

MD No.:	7	6	5	4	3	2	1	0		ASCII
5148	0	1	0	0	0	1	1	0	⇒	F
5149	0	1	0	0	1	1	0	0	⇒	L
5150	0	1	0	1	0	0	1	0	⇒	R
5151	0	0	1	0	0	0	0	0	⇒	blank

These machine data are only valid for "Execution from external" via the computer link interface.

The "logical partner receiver" is entered in the 4 bytes to which the request message is sent when the "Execution from external" function is started. The values are entered as ASCII values (see above). The standard setting is "FLU<sub>U</sub>" (see above).

Location receiver

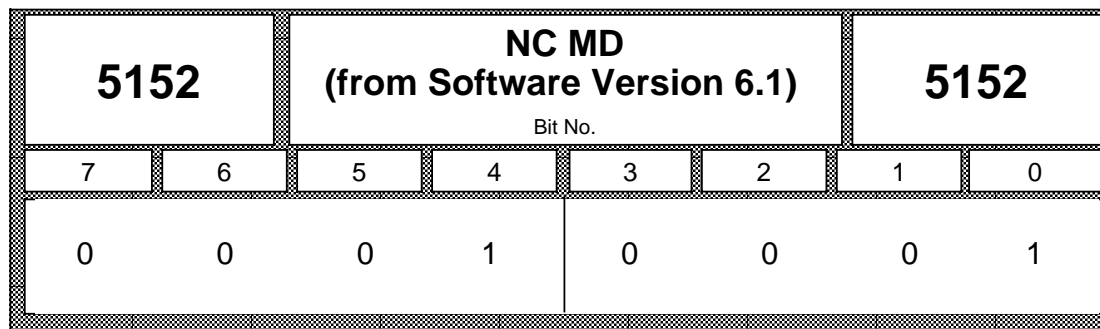

This machine data is only valid for "Execution from external" via the computer link interface.

The "location receiver" is entered in this byte which indicates the interface module via which the "logical partner receiver" can be reached.

The following applies:

11 H (0001 0001)	1st interface module
12 H (0001 0010)	2nd interface module

The standard setting is: 11 H (0001 0001) see above.

Additional machine data: (MD 30, MD 130\*, MD 5148-5151, MD 5015.4)

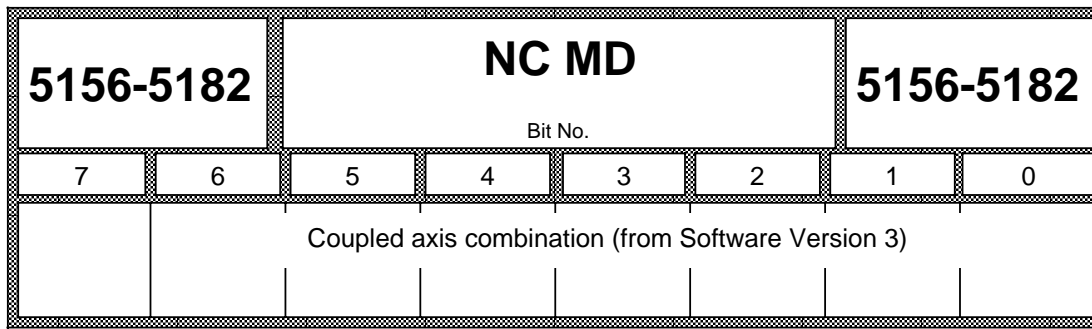
**Active: After RESET**

With the definition of this coupled axis combination define which coupled axis pairings form a coupled axis combination and how the coupled motion is performed (coupled motion in the same direction or opposite directions).

The 9 possible coupled axis combinations are programmed with G151 to G159. Each coupled axis combination is defined with 3 NC MDs corresponding to the 12 coupled axis pairings (12 times 2 bits).

	Programming	NC MD
1st Coupled axis combination	G151	5156 to 5158
2nd Coupled axis combination	G152	5159 to 5161
3rd Coupled axis combination	G153	5162 to 5164
4th Coupled axis combination	G154	5165 to 5167
5th Coupled axis combination	G155	5168 to 5170
6th Coupled axis combination	G156	5171 to 5173
7th Coupled axis combination	G157	5174 to 5176
8th Coupled axis combination	G158	5177 to 5179
9th Coupled axis combination	G159	5180 to 5182

Two bits are assigned to every coupled axis pairing in every coupled axis combination.

Leading axis	898	896	894	892	890	888	886	884	882	880	878	876	<b>NC MD</b>																									
Coupl. mot. axis	899	897	895	893	891	889	887	885	883	881	879	877	<b>NC MD</b>																									
Definition of the coupled axis pairing	<table border="1"> <thead> <tr> <th colspan="4">Bit</th> <th colspan="4">Bit</th> <th colspan="4">Bit</th> </tr> </thead> <tbody> <tr> <td>7 u. 6</td> <td>5 u. 4</td> <td>3 u. 2</td> <td>1 u. 0</td> <td>7 u. 6</td> <td>5 u. 4</td> <td>3 u. 2</td> <td>1 u. 0</td> <td>7 u. 6</td> <td>5 u. 4</td> <td>3 u. 2</td> <td>1 u. 0</td> <td></td> <td></td> </tr> </tbody> </table>												Bit				Bit				Bit				7 u. 6	5 u. 4	3 u. 2	1 u. 0	7 u. 6	5 u. 4	3 u. 2	1 u. 0	7 u. 6	5 u. 4	3 u. 2	1 u. 0		
Bit				Bit				Bit																														
7 u. 6	5 u. 4	3 u. 2	1 u. 0	7 u. 6	5 u. 4	3 u. 2	1 u. 0	7 u. 6	5 u. 4	3 u. 2	1 u. 0																											
Programming function																																						
G	151		5158			5157					5156																											
G	152		5161			5160					5159																											
G	153		5164			5163					5162																											
G	154		5167			5166					5165		<b>NC MD</b>																									
G	155		5170			5169					5168																											
G	156		5173			5172					5171																											
G	157		5176			5175					5174																											
G	158		5179			5178					5177																											
G	159		5182			5181					5180																											

With these 2 bits you determine how coupled motion is to be performed.

00 ... no coupled motion

10 ... coupled motion in opposite directions  $\longleftrightarrow$

11 ... coupled motion in the same direction  $\longrightarrow$

01 ... not defined (Alarm 85)

The definition of the coupled motion combination can be changed on a warm restart without POWER ON (for warm restart see also Section 11.6).

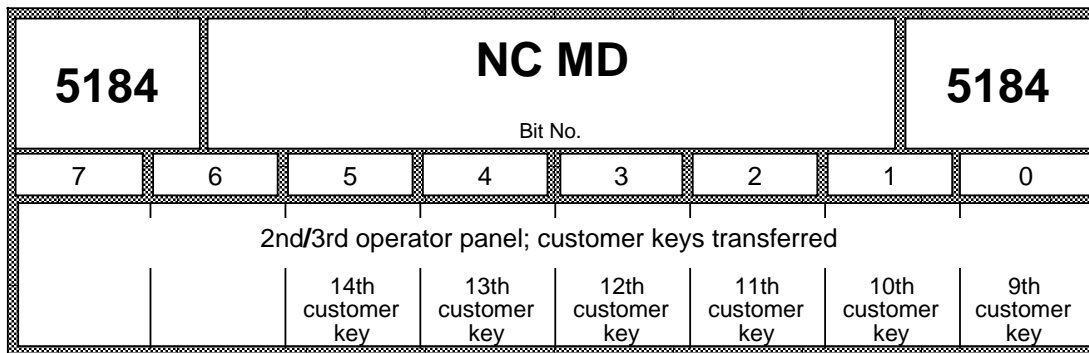
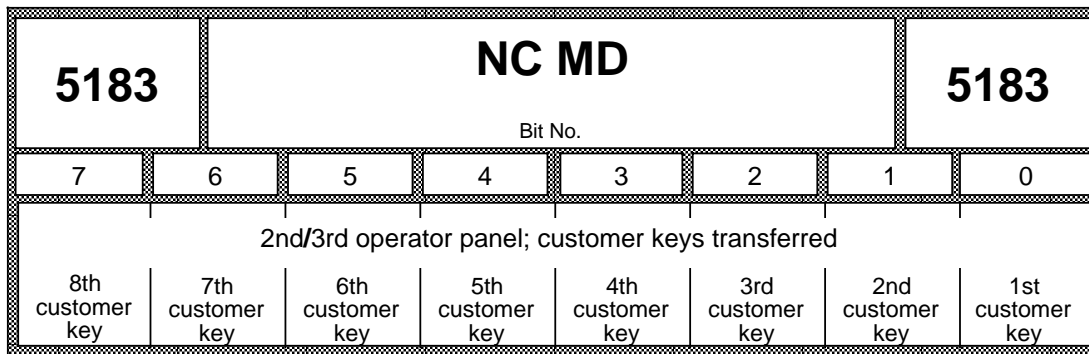

If these MD bits are set, the customer key functions of the 1st operator panel are automatically transferred by the PLC operator system to the customer keys of the 2nd/3rd operator panel when switching to the 2nd/3rd operator panel.

5185		NC MD						5185	
Bit No.									
7	6	5	4	3	2	1	0		
								Change of G64 after G00 (from SW 4)	

**Active: In next block**

**Bit 0=1:** If a path is traversed in one NC block with G64 and in the next NC block with G00, the NC automatically generates a speed reduction with exact stop coarse at the end of the first block.

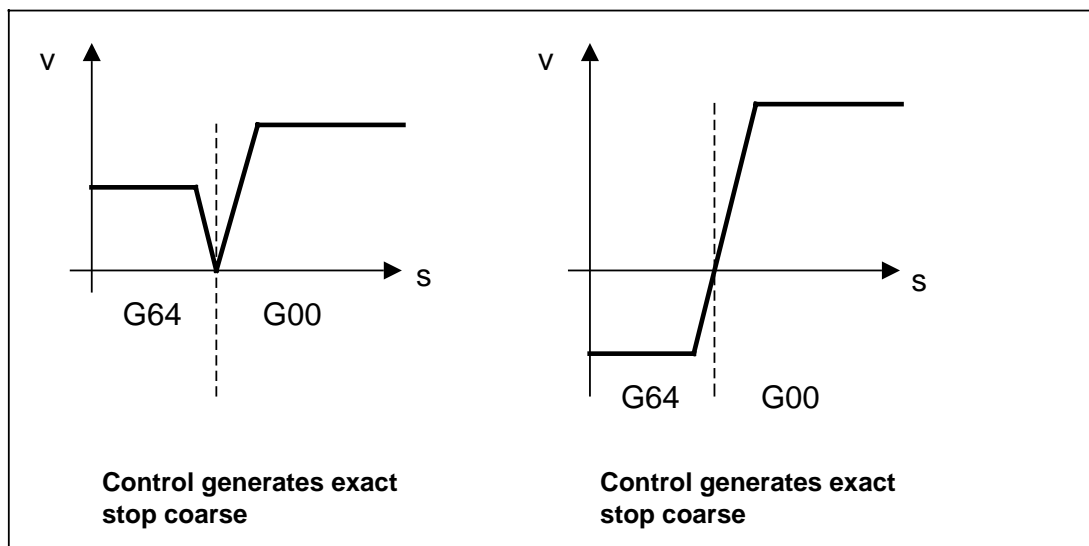

**Bit 0 = 0:**

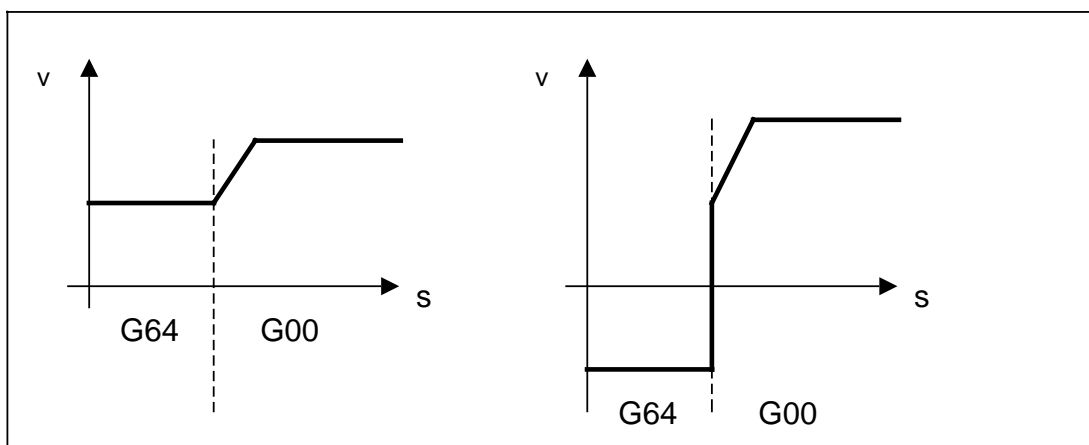

<b>520*</b>		<b>NC MD</b>						<b>520*</b>	
Bit No.									
7	6	5	4	3	2	1	0		
Spindle override active with thread cutting	No M19 abort on RESET	M19 with axis movement		Speed in 0.1 rev/min.	Encoder available	Actual value sign change	Actual value x 2		

**Bit 7:** If this bit is **set**, speed override is also active for thread-cutting (G33, G34, G35).

The change in spindle speed will cause a change in the following error which could lead to a fault in the thread.

**Bit 6:** If this bit is **set**, the positioning mode is not aborted by reset and M02/M30. The position is retained until IS: ACKNOWLEDGE M19 is set.

**Bit 5:** If this bit is not **set**, the next block in the part program will not be executed until the positioning mode has been aborted (with IS:ACKNOWLEDGE M19).

If this bit is **set**, the next block (with axis motion, if applicable) will also come up for execution even when the spindle is still being positioned. If there is an M03/M04 in one of the next blocks, it will abort the positioning mode.

This bit is generally used when deselecting the positioning mode. More details are given in "Special changeover conditions".

Changes to this bit only become operative at power-on.

**Bit 3:** If this bit is not **set**, all speed data (for inputs, in machine data, etc.) is evaluated in the units rev/min.

If this bit is **set**, all speed data is evaluated in the units 0.1 rev/min.

**Bit 2:** The following spindle functions assume that a pulse encoder is mounted on the spindle:

- Thread-cutting G33/G34/G35
- Revolutional feedrate G95
- Constant cutting rate G96
- Accept spindle speed G97
- Synchronous mode G201
- Positioning mode M19

This bit must be set if there is a pulse encoder mounted on the spindle.

**Bit 1:** If the value of this bit is changed, the sign will be inverted when evaluating the pulses coming from the measuring system. However, with spindles on 32-bit servo CPUs the change only becomes operative after power-on.

**Bit 0:** If this bit is **set**, the pulses coming from the measuring system will be doubled. However, the bit is **only** evaluated for spindles on the 16-bit servo CPU.

<b>521*</b>		<b>NC-MD</b> Bit No..						<b>521*</b>	
7	6	5	4	3	2	1	0		
Spindle available	No spindle speed change on reset	New S value after PLC acknowledgement		No measuring-circuit monitoring only 32-bit servo		Sign inversion, setpoint			

**Bit 7:** With SINUMERIK 880 there can be up to six spindles. The spindles must be defined in a continuous ascending sequence.

Any changes to this bit only become operative after a hardware reset.

**Bit 6:** If this bit is **set**, any running spindle functions are not aborted by key reset, mode change or M02/M30.

The spindle functions can then be aborted with IS:SPINDLE RESET provided, however, that the channel to which the spindle is assigned is in reset state.

For the positioning mode, MD 520\*, bit 6 must also be taken into account.

All alarms which cause IS:MODE GROUP READY to be cancelled will stop the spindle in this case.

**Bit 5:** If this bit is **set**, a newly-programmed spindle speed which requires a change of gear ratio will only be accepted when the gear ratio change has been acknowledged by the PLC. This enables any unwanted increase in speed in the old gear ratio to be avoided.

**Bit 3:** If this bit is **set**, no measuring-circuit monitoring is performed.

Examples of such monitoring are:

- checking for open-circuit in encoder circuits
- checking for contamination, if the encoder possesses a signal for contamination, or if the amplitude can be monitored (e.g. signal generators).

With spindles on 32-bit servo CPUs, any changes to this bit only become operative after power-on.

**Bit 1:** If this bit is **not set**, a positive setpoint voltage will be output with M03 and a negative value with M04.

If this bit is **set**, a negative setpoint voltage will be output with M03 and a negative value with M04.

This allows the direction of spindle rotation to be matched to the programmed direction. With IS:INVERT M03/M04 the direction of rotation can be reversed by the PLC.

With spindles on 32-bit servo CPUs any changes to this bit only become operative after power-on.



524*		NC MD (from Software Version 5)				524*	
Bit No.							
7	6	5	4	3	2	1	0
				Measuring system resolution for spindle as leading axis (ELG)			

**Active: Immediately**

Bits 0 to 3: Measuring system resolution for spindle as leading axis (ELG)

The measuring system resolution set with MD 524\* for the spindles is valid only for weighting of an increment of the part actual value of the spindle for calculating the set position of the following axis.

The spindle must have been defined as leading axis.

Matching of the selected measuring system resolution to the rotary encoder is effected the help of NC machine data 455\* and 456\*.

The coding of the possible measuring system resolutions can be found in the table for position control resolution of round axes (see MD 1800\* bits 0 to 3).

**Note:**

The measuring system resolution of the spindle for M19, G33, G95 etc. is as before

$$\frac{360}{4 \cdot 1024} \text{ degrees}$$

<b>540*</b>		<b>NC MD</b>						<b>540*</b>	
Bit No.									
7	6	5	4	3	2	1	0		
No transformation deselection on RESET (from Software Version 3)	F value in m/min	0*)	0*)			G functions to PLC	Aux. functions to PLC		

**Bit 7:** On a key reset, mode change and M2/M30 the transformation (TRANSMIT) is not deselected.

**Active: After RESET**

**Note:**

In reference point approach mode the transformation is always deselected.

**Bit 6:** Initiates input of F value in m/min.  
 This machine data is active in all metric input systems. The maximum axial speeds stated in the machine data remain unaffected by the machine data, e.g.:

**Active: In next block**

Input F10 speed 10 m/min.

Display of the feedrate value depends on the machine data. The feedrate value of F external and dry run feed is not converted to m/min. This MD has no effect with "inch" input resolution; i.e. the feedrate is always stated in inch/min.

**Bit 1:** **Bit 1=0** Inhibits output of G functions to PLC

**Active: Immediately**

**Bit 0:** **Bit 0=0** Inhibits output of auxiliary functions to PLC  
 Auxiliary functions are: M, S, T, H, D.  
 This is useful with calculation channels.

**Active: Immediately**

See NC MD 544\* bit 0 for the output of the programmed F value to the PLC.

\*) This data has to be defined into value "0".

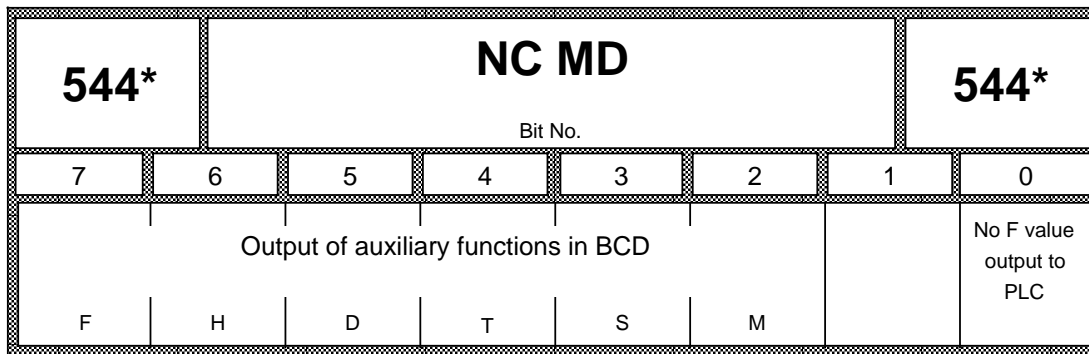
**Active: In next block**

**Bit 3-7:** **Bit 3-7 = 1** The auxiliary function is output to the PLC in BCD code.

**Bit 3-7 = 0** The auxiliary function is output to the PLC as a fixed point number.

**Bit 2:** M function must be set to "0".  
(internal M decoding)

**Bit 1:** Set to "0".

**Bit 0:** F value output to the PLC is cancelled via the machine data. Consequently, the block change times can be improved in the case of travel blocks with an F value since acknowledgement by the PLC does not have to be awaited (e.g. for SD machining).

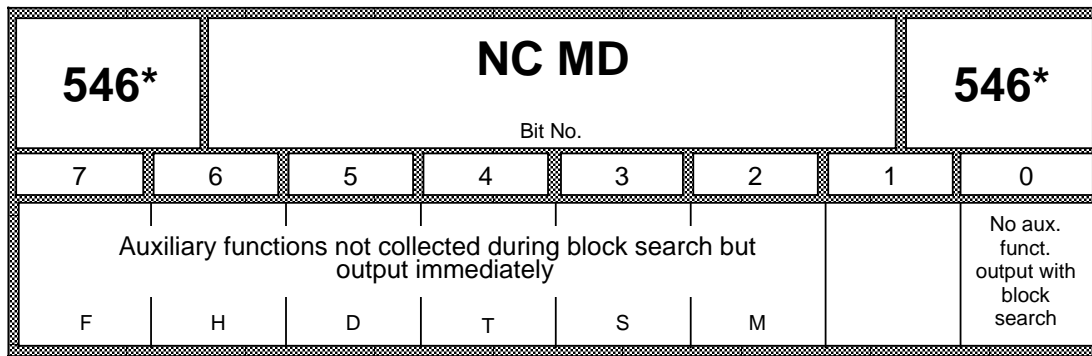

**Active: Immediately**

**Bit 7, 6, 5, 4, 3, 2:**

The type of auxiliary functions specified is **not** skipped with block search but is output immediately (may result in several switching functions being triggered in rapid succession via the PLC).

**Bit 0:** With the bit set, all auxiliary functions (M, S, T, D, H and F) are skipped and forgotten with block search (no output to the PLC and no internal response).

**Example:**

	Bit pattern for bits ...							Significance
	7	6	5	4	3	2	0	
<b>Example a</b>			irrelevant				1	No auxiliary function output
<b>Example b</b>	0	0	0	0	0	0	0	Skip all auxiliary functions and output last function after NC-Start
<b>Example c</b>	1	1	1	1	1	1	0	Output all auxiliary functions during block search
<b>Example d</b>	0	0	0	0	0	1	0	Output M functions during block search; collect H, D, T, S and F functions and output last auxiliary function after NC start.

All the collected auxiliary functions are activated at the end of block search with NC START and output to the PLC. Collecting ensures that only the last H, D, T, S and M functions and the last F value are active.

NC MD	Bit No.								
	7	6	5	4	3	2	1	0	
<b>548*</b>									Name of horizontal axis (abscissa) (same code as for axis definition)
<b>550*</b>									Name of perpendicular axis (ordinate) (same code as for axis definition)
<b>552*</b>									Name of vertical axis (applicate) (same code as for axis definition)

**Active: In next block**

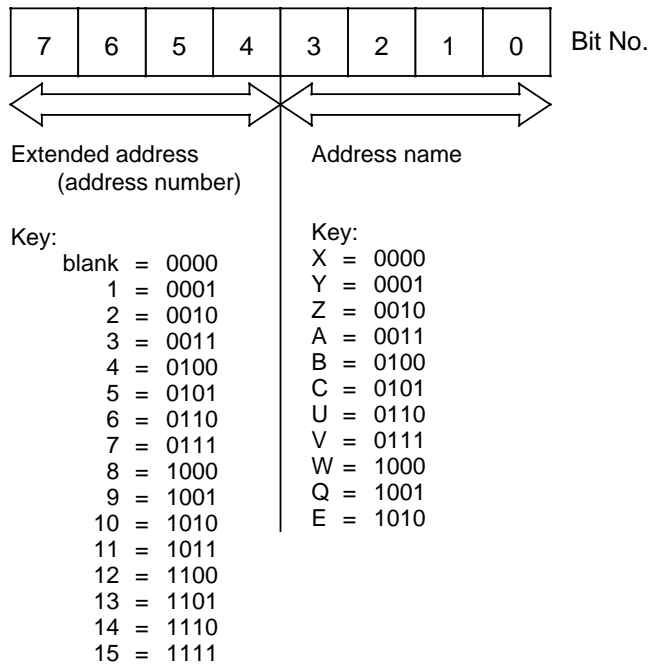

Permissible names for axes, angles, chamfers and radius	
<b>A</b> Unassigned address	<b>N</b> Subblock
<b>B</b> Unassigned address	<b>O</b> angle of confusion with 0 (Zero)
<b>C</b> Unassigned address	<b>P</b> Subroutine number of passes
<b>D</b> Tool offset number	<b>Q</b> Unassigned address
<b>E</b> Unassigned address	<b>R</b> Calculation parameter
<b>F</b> Feed	<b>S</b> Spindle speed, S function
<b>G</b> G function	<b>T</b> Tool
<b>H</b> H function	<b>U</b> Unassigned address
<b>I</b> Interpolation parameter	<b>V</b> Unassigned address
<b>J</b> Interpolation parameter	<b>W</b> Unassigned address
<b>K</b> Interpolation parameter	<b>X</b> Unassigned address
<b>L</b> Subroutine	<b>Y</b> Unassigned address
<b>M</b> M function	<b>Z</b> Unassigned address

The reset plane in the SINUMERIK 880 can be defined in NC MD 110\* (from Software Version 3). After powering up the NC, the axes in which radius compensation or length compensation is to be calculated are specified as a function of NC MD 548\*, 550\* and 552\*. NC MD 548\* and 550\* define the axes to be affected by radius compensation in the reset position. NC MD 552\* defines the axis in which length compensation 1 (tool parameter P2) is to be active (cutters only). Calculation of a second length compensation (tool parameter P3) depends on the sequence of the programmed axes and type of tool.

**Example:** NC MD 548\* = 0000 0000 X axis  
NC MD 550\* = 0000 0001 Y axis  
NC MD 552\* = 0000 0010 Z axis

- Program  
N10 G0 G41 D1 X0 Y0 Z0 (D1 = tool type 20 cutter)

Radius is calculated in X-Y  
L1 is calculated in Z  
L2 is not calculated

- Program  
N10 G16 X Y Y Z (plane selection)  
N20 G0 G41 D1 X ... Y ... Z ... (D1 = tool type 30 angle head cutter)

Radius is calculated in X-Y  
L1 is calculated in Y  
L2 is calculated in Z

- Program  
N10 G16 Z X Z (plane selection)  
N20 G0 D1 Z ..... (D1 = tool type 10 drill)

Radius is not calculated  
L1 is calculated in Z

In a turning machine with X and Z axes, Z-X (G18) is to be selected as the reset plane after powering up. The NC MD should be set as follows:

NC MD 548\* = 0000 0000  
NC MD 550\* = 0000 0010  
NC MD 552\* = 0000 0010

NC MD 548\* and 550\* specify plane Z-X. NC MD 550\* specifies the axis in which L1 geometry is to be active, if a cutter or drill is used.

With tool type 1 to 9 the following applies:

Length 1 (tool parameter P2) always refers to the 2nd axis name behind G16 <

Length 2 (tool parameter P3) always refers to the 1st axis name behind G16

Length 1 (tool parameter P2) permanently refers to the facing axis.

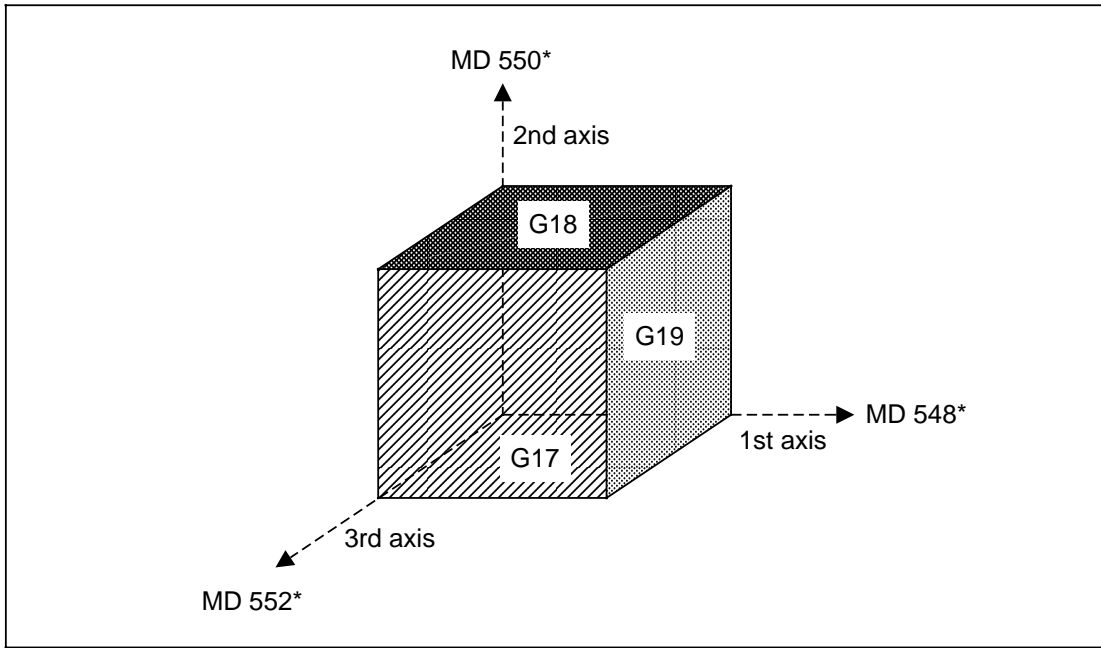

PLANE	G17	G18	G19
Axis no.	1	3	2
	2	1	3
	3	2	1

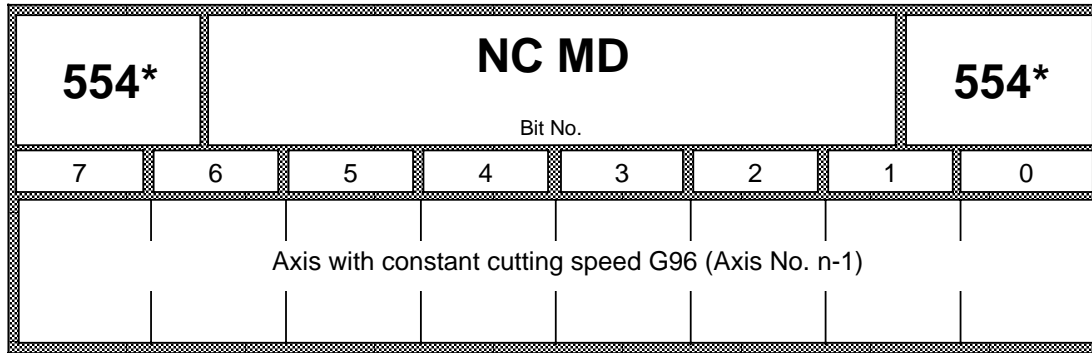

**Active: In next block**

The **number** of the axis with which the constant cutting speed (G96) is to be reached must be specified (normally the plane axis).

The axis number must be specified as follows:

- 1st axis ... 0000 0000
- 2nd axis ... 0000 0001
- 3rd axis ... 0000 0010
- 4th axis ... 0000 0011
- ⋮
- ⋮
- ⋮
- 10th axis ... 0000 1001

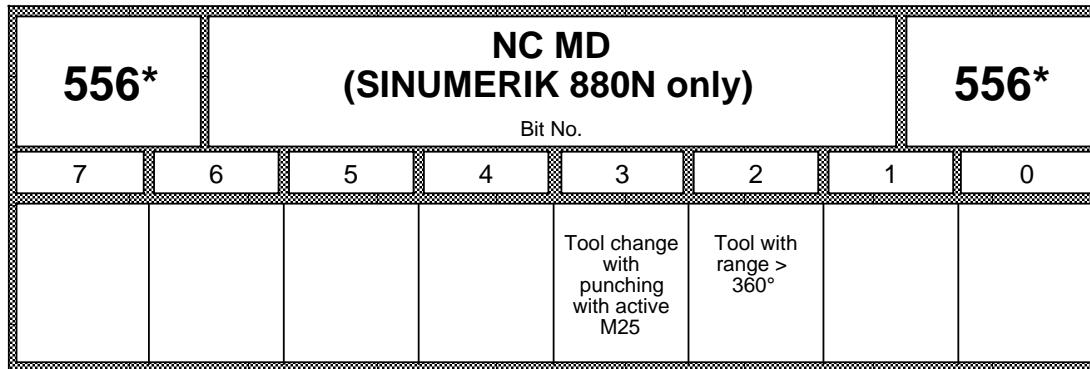

**Bit 3:** Tool change with punching with active M25  
 If Mx25 is active punch repetition is possible after the tool turret has been revolved.

**Bit 2:** Tool with rotational range > 360°  
 the tool axis is not mechanically limited to the rotational range of +/- 360°.



<b>558*</b>		<b>NC MD</b>						<b>558*</b>	
Bit No.									
7	6	5	4	3	2	1	0		
							Supple- ment axes after block search		

**Active: In next block**

**Bit 0:** **Bit 0 = 0** After block search only those axes programmed in the search block are traversed. It is possible to modify TO and ZO prior to NC START.

**Bit 0 = 1** "3D interpolation" option must be available. After block search, not only those axes programmed in the search block are traversed; up to 5 axes may be traversed if previously entered in the program. If more than 5 axes have been entered in the program, all axes up to the number 5 must be traversed in REPOS mode. The TO, the current D No. or the or ZO may not be modified prior to NC START.

<b>560*</b>		<b>NC MD</b>						<b>560*</b>	
Bit No.									
7	6	5	4	3	2	1	0		
Display act. value modulo 360°	Automatic ref. point approach	Software limit switch active	No start inhibit for ref. point	Rounding for rotary axes	Rounding to whole/half degrees			No measuring circuit monitoring	

**Active:** When all channels of the mode group are in STOP state (except bit 5, see next page)

**Bit 7:** For rotary axes only! (NC MD 564\* Bit 5-1!)  
 The actual-value display jumps from 359.999 to 0 degrees after one revolution of the rotary axis.  
 For rotary axes see also Section 11.5.

**Bit 6:** **Bit 6 = 0** If the axis is between the reference point cam and hardware limit switch after the controller has been switched on, the axis moves to hardware limit switch during approach to the reference point since the controller cannot detect from the "\*\*Deceleration" interface signal whether the axis is ahead of or behind the reference point cam (see also Section 11).

**Bit 6 = 1** The controller can detect precisely the direction of the reference point cam from the "\*\*Deceleration" interface signal since the reference point cam extends as far as the traversing limit (see also Section 11).

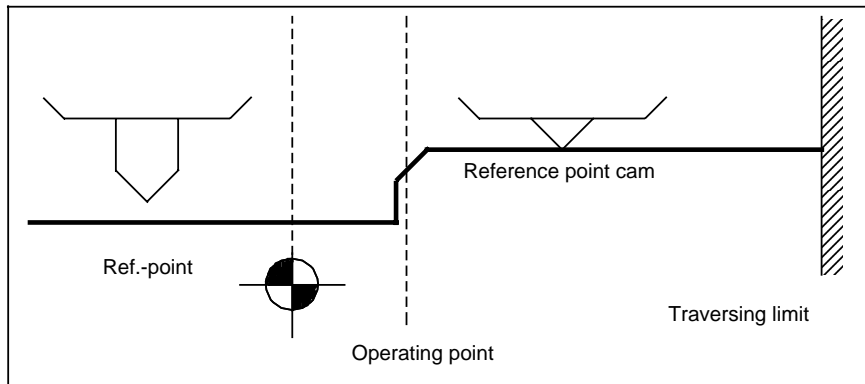

**Bit 5:** **Bit 5 = 0** The software limit switches in MD 224\* to 236\* are overrun without any response.

**Active: After RESET**

**Bit 4:** The program can be started without approach to the reference point for **this** axis with NC START.

With NC MD 5004 bit 3 it is possible to define for all axes together whether a reference point approach is necessary before program start.

**Bit 3, 2:** Active for rotary axes only! In jog mode, rounding to whole or half degrees is performed (positioning) as a function of bit 2.  
Bit 2 = 1 means rounding to whole degrees.

Alarm 2064 is displayed in the AUTOMATIC/MDA modes for programmed positions with no movement to half or whole degrees (rotary axis programming error). With all axis-/spindle-specific alarms that effect interruption of position control (cancellation of mode group ready) and with emergency off, the control is no longer able to position the rotary axis at positions described by half or whole degrees. In such cases, the rotary axis must not be lowered into the Hirth tooth system.

**Bit 0:** Alarm 132\* is disabled. The cables to the encoder are no longer monitored for breaks. Failure of the encoder or a wire-break is then not signalled immediately but after a delay as alarm 104\*, 112\* or 116\* (if it is possible at all).

<b>564*</b>		<b>NC MD</b>						<b>564*</b>	
Bit No.									
7	6	5	4	3	2	1	0		
Axis exists	Fictitious axis (from software version 3)	Position control for rotary axis	Indexing axis (from software version 3)	Actual values division related (from software version 3)	Actual value sign change	Setpoint sign change	Ref. point in negative direction		

**Active: After POWER ON**

**Bit 7:** The set bit causes the axis to appear on the screen and the position controller and measuring-circuit monitor to be activated. For this the corresponding PLC MD 6016 to 6018, PLC MD 6116 to 6118, PLC MD 6216 to 6218, PLC MD 6316 to 6318 must be set.

**Caution!**

The bit only makes the axis active after the "Power ON" routine, although the axis address is displayed immediately on the screen.

**Note:**

The axes up to Software Version 2 must be **fully** defined in ascending order. A maximum of 24 axes can be activated with SINUMERIK 880 and a maximum of 15 axes (12 real and 3 fictitious) can be activated with SINUMERIK 850.

**Bit 6:** Fictitious axes (from Software Version 3) are required for the coordinate transformation (see NC MD 5060 to 5139).

Fictitious axes have no position control (NC MD 200\* irrelevant) and need no measuring circuit. The NC MDs which still have to be set for fictitious axes see NC MD 5060 to 5139.

Fictitious axes can be programmed on active coordinate transformation and traversed in jog modes (JOG, INC ... 10000).

**Note:**

Fictitious axes must be linear axes!

**Bit 5:** The axis in question is declared a rotary axis. Position control is recorded in degrees and G70/71 for rotary axis positions is disabled. For rotary axes see also Section 11.5.

**Bit 4:** With bit 4 "indexing axis" (from Software Version 3) a linear or rotary axis is declared to be an indexing axis and at the MDs 1104\*, 1108\*, 1112\* and 564\* Bit 3 are activated.  
 (for the division increment from PLC see also Section 11).

**Bit 3:** The actual value (the actual position display) is converted into indexing positions. An indexing position of less than 1 is not possible (applies to rotary and linear axes). The actual value display in the service data is not converted into division positions.

If bit 3 is not set for indexing axis the assignment of positions to indexing positions still occurs (via command channel) but the actual value display is in mm or inches.

- Bit 2:** The signs of the measuring-system pulses may be reversed by resetting the bit (necessary when the axis traverses unchecked on account of an incorrect position feedback polarity).
- Bit 1:** Resetting of the bit produces a change in the polarity of the speed controller setpoint voltage (necessary when the axis moves in the mechanically incorrect direction)
- Bit 0:** **Bit 0 = 0** Start of approach to reference point with "+" direction key.  
**Bit 0 = 1** Start of approach to reference point with "-" direction key.

**Caution:**

Bits 2 and 1 have the following meaning if integrated drive control (IAR) is used:

- Bit 2** The sign of the measuring device pulses can be changed by inverting the bit. This is necessary when the axis runs out of control on account of incorrect position feedback polarity / speed controller feedback polarity.

This machine data bit is always valid for the speed controller, but also for the position controller when using an **indirect** (motor) position measuring system.

A change is not effective until POWER ON.

- Bit 1** Inversion of the bit causes the polarity of the setpoint speed to be changed. This is necessary when the machine traverses in the mechanically wrong direction.

**Example:**

1. Indirect position measuring system (motor system)

Change of travel direction by inverting the NC MD 564\* bit 1 and bit 2

2. Direct position measuring system (linear scale or encoder at ball screw)

Change of travel direction by inverting the NC MD 564\* bit 1 and bit 2, but in addition **inversion of IAR MD 504\* bit 4.**

IAR MD 504\* bit 4 inverts the position controller actual position difference and NC MD 564\* bit 2 the speed controller actual position difference.

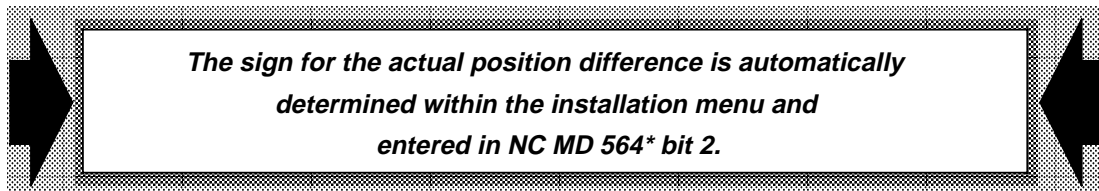

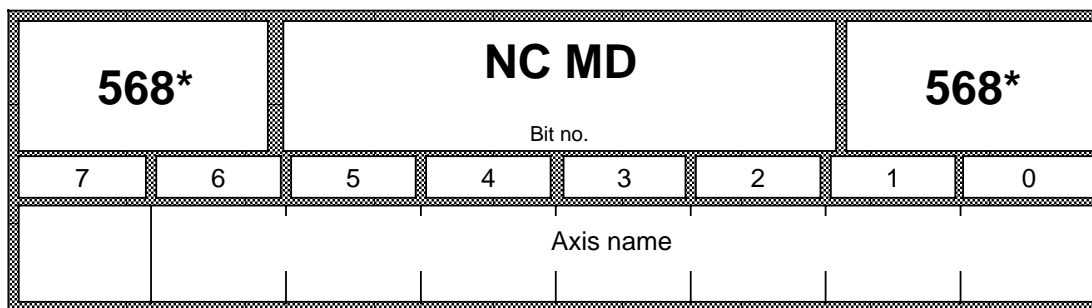

**Active: Immediately**

The axis name is to be specified with reference to the table.

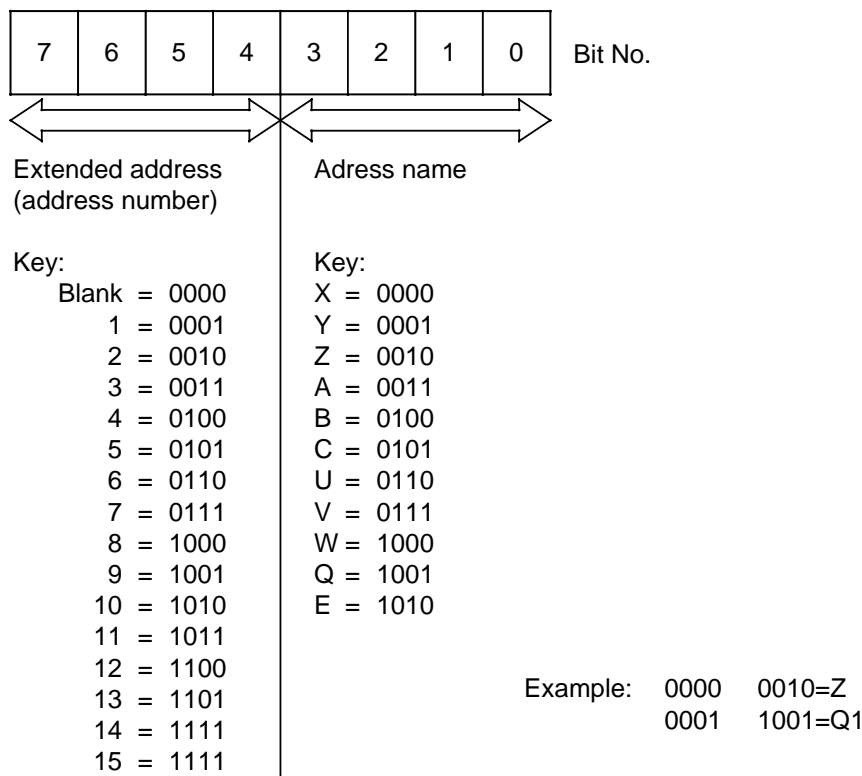

The names in MD 5000, MD 5001 and MD 568\* must not coincide. The same address name with a differently extended address is not considered to be coinciding.

Permissible names for axes, angles, chamfers and radius	
<b>A</b> Unassigned address	<b>N</b> Subblock
<b>B</b> Unassigned address	<b>O</b> Danger of confusion with 0 (Zero)
<b>C</b> Unassigned address	<b>P</b> Subroutine number of passes
<b>D</b> Tool offset number	<b>Q</b> Unassigned address
<b>E</b> Unassigned address	<b>R</b> Calculation parameter
<b>F</b> Feed	<b>S</b> Spindle speed, S function
<b>G</b> G function	<b>T</b> Tool
<b>H</b> H function	<b>U</b> Unassigned address
<b>I</b> Interpolation parameter	<b>V</b> Unassigned address
<b>J</b> Interpolation parameter	<b>W</b> Unassigned address
<b>K</b> Interpolation parameter	<b>X</b> Unassigned address
<b>L</b> Subroutine	<b>Y</b> Unassigned address
<b>M</b> M function	<b>Z</b> Unassigned address

572*		NC MD						572*	
Bit No.									
7	6	5	4	3	2	1	0		
			Trav. the rot. axis mod. 360° (from SV 3)	Mirroring of TO with facing axis	Rotary axis prog. modulo 360°	Plane axis	Auxiliary axis		

**Active: Immediately**

**Bit 4:** **Bit 4 = 0** With rotary axes on programming G90 or G68 > 360° or > 180° can arise and the determined direction of travel can change if zero offsets, tool offsets etc. are included in the calculation for the first time or if zero offsets, tool offsets etc. are modified within the program.

**Example:**

```

N1 G90 C0 LF      (C ... Rotary axis)
N2 C90 LF
N3 G58 C-180 LF
N4 G90 C+135 LF

```

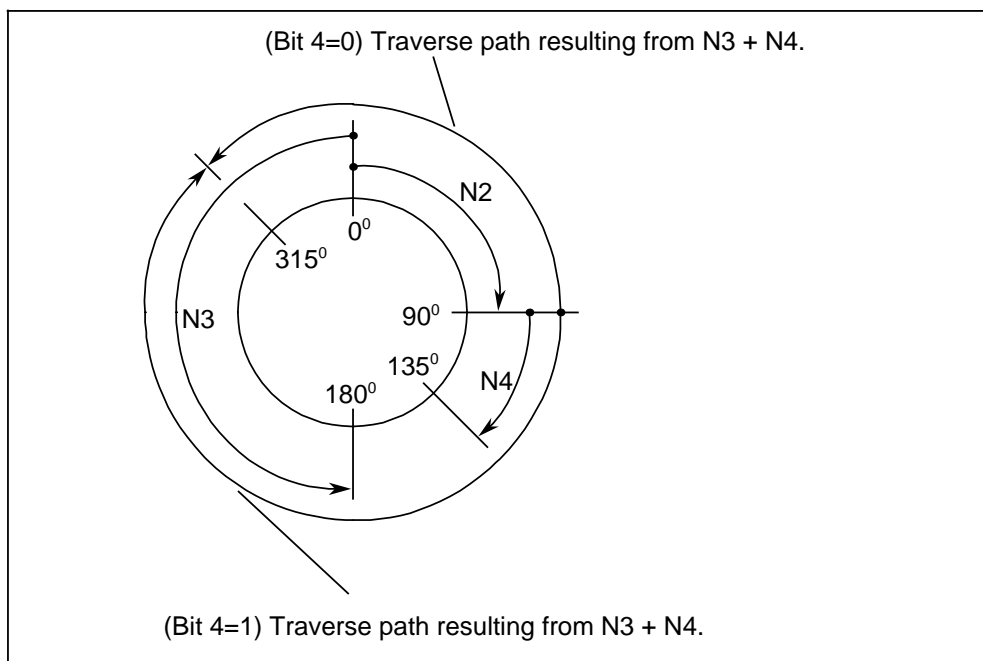

**Bit 4 = 1:** In this way on G90 programming a traverse path and a direction of travel are set which correspond to the programming. Depending on the programmed G function the control behaves as follows:

G91: No modulo 360° calculation takes place. The current ZO and TO are added to the programmed position (> 360° also possible) to give the new position and new direction of travel.

G90: The current ZO and TO are added to the programmed position ( $\pm 359.999$  degrees), a modulo 360° calculation is performed and the traverse path determined in this way is traversed with the programmed direction of travel (+ ... clockwise, - ... counterclockwise) (see above example).

G68 The current ZO and TO are added to the programmed position (0 to 359.999 degrees), a modulo 360° calculation and a protection on  $\pm 180^\circ$  performed. Only in this way is the shortest direction of travel determined by the control.

**Bit 3:** In case of error the Alarm 3014 "Axis blocked in the channel" is issued. This disable is only active in modes AUTOMATIC and MDI AUTOMATIC (also via command channel on path increment/division increment from the PLC).

**Bit 2:** **Bit 2 = 1** The rotary axis can be programmed in absolute dimensions (G90) up to 360° max. The programmed sign indicates the direction of travel. When the program is started after block search and with G68, travel is performed to the programmed position over the shortest path. (Also see Section 11.5).

A rotary axis can be programmed with G68 and positioning is performed over the shortest path (max.  $\pm 180$  degrees).

If a rotary axis is programmed in the part program for the first time, the control selects G68 independently of the programmed G function (G68, G90, G91). The automatic selection of G68 can only be selected with G91 CO (C ... rotary axis). The automatic selection of G68 is performed after block search or automatic block search as well and can then only be deselected by traversing the axis in REPOS.

If mixed programming of G90/G91 is selected in the block (NC MD 5007 bit 5) the G90/G91 function programmed last is always active for the programmed rotary axis position.

For rotary axes also see Section 11.5.

**Bit 2 = 0** Travel programming and rotary axis traversing are performed as for linear axes.

**Bit 1:** The bits set in NC-MD 5011 act on the corresponding axis.

**Bit 0:** If an axis has been defined as an auxiliary axis, no TOs are added to it.



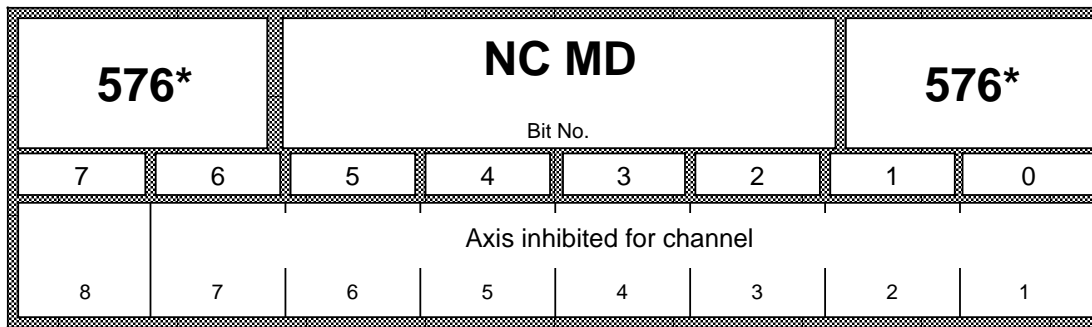

**Active: In next block**

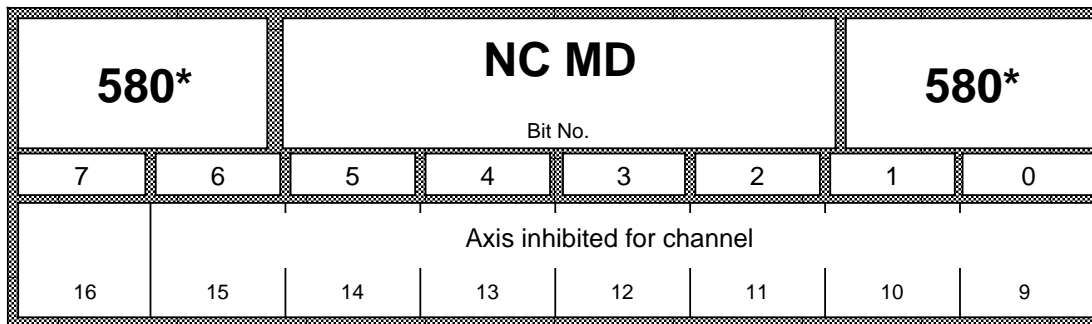

**Active: In next block**

**Bit 7, 6, 5, 4, 3, 2, 1, 0:**

The axis cannot be processed by the corresponding channel if the bit is set. In case of error alarm 3014 "Axis blocked in the channe". This disable is only active in AUTOMATIC and MDI-AUTOMATIC modes (also via command channel with path dimension/division increment from PLC).

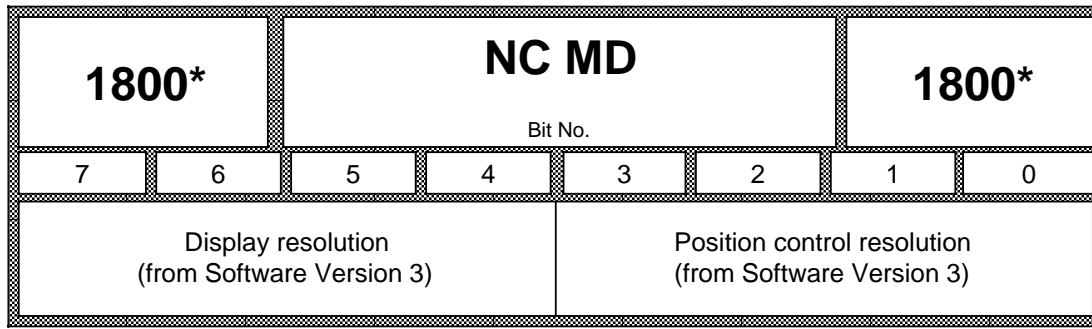

**Active: After POWER ON**

For an exact description and conditions (axis-specific revolutions) see Section 11. Coding of the axis-specific resolutions (input resolution, display resolution, position control resolution):

Bit 7	Bit 6	Bit 5	Bit 4	Input resolution			NC MD 5002	
Bit 7	Bit 6	Bit 5	Bit 4		Display		NC MD 1800*	
Bit 3	Bit 2	Bit 1	Bit 0			Position control	NC MD 1800*	
0	0	0	0	————	10 <sup>-1</sup> [mm] [deg.]	2 <sup>-1</sup> ·10 <sup>-2</sup> [deg.]	metric (degrees)	
1	0	0	0	10 <sup>-2</sup> [mm] [deg.]	10 <sup>-2</sup> [mm] [deg.]	2 <sup>-1</sup> ·10 <sup>-2</sup> [deg.]		
0	1	0	0	10 <sup>-3</sup> [mm] [deg.]	10 <sup>-3</sup> [mm] [deg.]	2 <sup>-1</sup> ·10 <sup>-2</sup> [deg.]		
1	1	0	0	————	————	2·10 <sup>-2</sup> [deg.]		
0	0	1	0	10 <sup>-4</sup> [mm] [deg.]	10 <sup>-4</sup> [mm] [deg.]	2 <sup>-1</sup> ·10 <sup>-2</sup> [deg.]		
1	0	1	0	10 <sup>-5</sup> [mm] [deg.]	10 <sup>-5</sup> [mm] [deg.]	2 <sup>-1</sup> ·10 <sup>-2</sup> [deg.]		
0	1	1	0	————	————	————		
1	1	1	0	————	————	————		
0	0	0	1	————	10 <sup>-1</sup> [deg.]	2 <sup>-1</sup> ·10 <sup>-2</sup> [deg.]		inches (degrees)
1	0	0	1	————	10 <sup>-2</sup> [deg.]	2 <sup>-1</sup> ·10 <sup>-2</sup> [deg.]		
0	1	0	1	10 <sup>-3</sup> [mm] [deg.]	10 <sup>-3</sup> [inch] [deg.]	2 <sup>-1</sup> ·10 <sup>-2</sup> [deg.] [deg.]		
1	1	0	1	10 <sup>-4</sup> [mm] [deg.]	10 <sup>-4</sup> [inch] [deg.]	2 <sup>-1</sup> ·10 <sup>-2</sup> [inch] [deg.]		
0	0	1	1	————	————	2·10 <sup>-2</sup> [inch]		
0	0	1	1	10 <sup>-5</sup> [mm] [deg.]	10 <sup>-5</sup> [inch] [deg.]	2 <sup>-1</sup> ·10 <sup>-2</sup> [inch] [deg.]		
0	1	1	1	10 <sup>-6</sup> [mm] [deg.]	————	————		
1	1	1	1	————	————	————		

n ... not on export version

<b>1804*</b>		<b>NC MD (from Software Version 5)</b>						<b>1804*</b>	
Bit No.									
7	6	5	4	3	2	1	0		
					Tacho compen- sation with adaptation	Tacho compen- sation ON			

**Active: Immediately**

**Bit 1:** "Tacho compensation ON"

**0 signal:** Tacho compensation is not active for the axis concerned.

**1 signal:** Tacho compensation is active for the axis concerned.

The tacho compensation value (basic value) is entered in machine data 1128\* .

With machine data 1804\*, bit 2, an adaptation of the tacho compensation can be activated additionally should thermal changes modify the transmission characteristic of the tacho.

**Bit 2:** "Tacho compensation with adaptation"

**0 signal:** Adaptation of the tacho compensation value to the thermal changes is switched off.

**1 signal:** The tacho compensation is made up of the sum of the basic value (MD 1128\*) and the adaptation value determined within the control. As long as this machine bit is set, the adaptation value is determined if the MD bit is reset, the last adaptation value remains valid.

Since thermal drift changes are to be compensated with the help of the adaptation function, the adaptation value is formed relatively slowly (approx. 10 seconds) and only when travelling at constant velocity.

When switching on the control (Power On), the adaptation value is automatically reset so that immediately afterwards only the basic value for tacho compensation is considered (machine is "cold"). Also, the adaptation value is reset when machine data 1128\* (basic value) is modified.

**Note:**

Before activation of the adaptation function, the basic value must be determined and entered.

<b>1808*</b>		<b>NC MD (from Software Version 5)</b>				<b>1808*</b>	
Bit No.							
7	6	5	4	3	2	1	0
On-the-fly synchroni- zation of C axis (from SV 6)				Absolute offset valid	Abs. enc. feedback polarity opposite to machine system	Absolute encoder as direct measuring system	SIPOS absolute encoder available

- Bit 0=1**      The NC axis is equipped with a SIPOS absolute encoder.
- Bit 1=1**      The SIPOS absolute encoder is not attached to the motor but, for example, directly to the ball screw. The encoder in this case acts as a direct position measuring system replacing a linear scale.
- Bit 1=0**      The SIPOS absolute encoder is attached to the motor and is used as position and speed measuring system.  
  
If, despite this, an additional direct measuring system is declared via IAR MDs 500\* and 504\* this means that the NC when switched on transfers the SIPOS absolute value as machine absolute value but then uses the pulses of the linear scale for position information.
- Bit 2=1**      For calculating the relevant machine absolute value after NC Reset it must be known whether the value of the SIPOS absolute encoder increases or decreases with the machine absolute value. Bit 2=1 means that the value of the SIPOS absolute encoder increases with decreasing machine absolute value or decreases with greater machine absolute value.
- Bit 2=0**      Machine system and SIPOS absolute system have the same feedback polarity.
- Bit 3=1**      The value for absolute value offset contained in NC MD 396\* is valid. In the case of a valid value (bit 3=1) "Reference point reached" is immediately set for this axis.
- Bit 7**        On-the-fly synchronization of C axis  
  
When this bit is set, a function is triggered on the servo CPU. With this function, the rotary axis actual value system is reinitialized when switching back (cancellation of follow-up mode) from spindle mode to axis mode (corresponds to reference point approach).  
  
Standard setting = 0.

The following NC machine data must be considered if the SIPOS absolute encoder is used:

Axial machine data:

- MD 240\*      reference point ordinates
- MD 396\*      absolute offset

### Procedure for reference point approach

When MD 1808\* bit 0 "Axis with SIPOS absolute encoder" is set, a distinction is made between two different conditions.

Condition 1: MD 1808\* bit 3=0

When the bit "absolute offset valid" is not set, reference point approach is executed as for an axis without an absolute encoder. On "reference point reached" the calculated absolute offset is transferred to the axial MD 396\* and 1808\* bit 3, "absolute offset valid" is set for the relevant axis.

The absolute offset is calculated according to the equation:

machine system = SIPOS system + absolute offset

or

absolute offset = machine system - SIPOS system

where the following applies:

machine system = desired absolute position = reference point ordinate

and

SIPOS system = displayed absolute position (actual position)

**Note:**

If a value other than 0 has been entered in MD 396\*, this value must be considered because it is contained in the SIPOS system (= displayed actual value).

Condition 2: MD 1808\* bit 3=1

If the "absolute offset valid" bit is set, reference point approach is suppressed. This is valid until the user resets the bit.

**Note:**

If function G74, "Reference point approach from part program" is programmed, referencing is not executed for the second condition and the program continues from the subsequent block.

Behaviour after warm restart (POWER ON)

If MD 1808\* bit 0, "Axis with absolute encoder", is set, MD 1808\* bit 3, "Absolute offset valid" is checked for the axis in question. If this bit has also been set, the axial interface signal "Reference point reached" is set on warm restart.

Special case - "Parking axis"

The axis interface signal, "Parking axis" also deletes the interface signal "Reference point reached" for an axis with SIPOS absolute encoder. If MD 1808\* bit 3 is set, a renewed reference point approach is suppressed. The absolute value is not adopted until POWER ON.

**Note:**

Reference point approach can be executed again when MD 1808\* bit 3 has been deleted.

## 9.4 PLC machine data

### 9.4.1 General

The PLC machine data are only active after "POWER ON Reset". Inputting of the PLC machine data via the serial interface is possible in the "OVERALL RESET" installation mode. Manual input of PLC-MD or editing of PLC-MD is only possible in "NORMAL" installation mode.

PLC MD for PLC1	PLC MD for PLC2	
0 to 199	200 to 399	PLC MD for operating system
2000 to 2249	2250 to 2499	PLC MD for function blocks
4000 to 4099	4100 to 4199	PLC MD for user
6000 to 6099	6100 to 6199	PLC MD bits for operating system
6400 to 6699	6400 to 6699	General bits for both PLCs
7000 to 7249	7250 to 7499	PLC MD bits for function blocks
8000 to 8049	8050 to 8099	PLC MD bits for user

#### Menu following selection with "DIAGNOSTICS" softkey

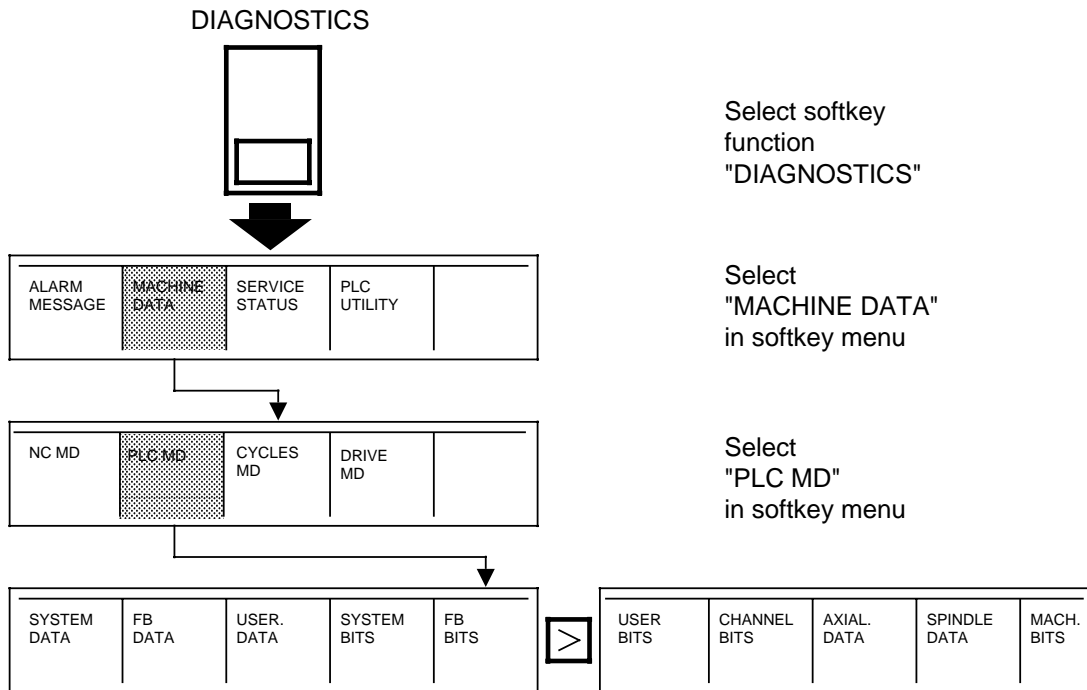

Select softkey function "DIAGNOSTICS"

Select "MACHINE DATA" in softkey menu

Select "PLC MD" in softkey menu

From Software Version 06 the menu tree is as follows:

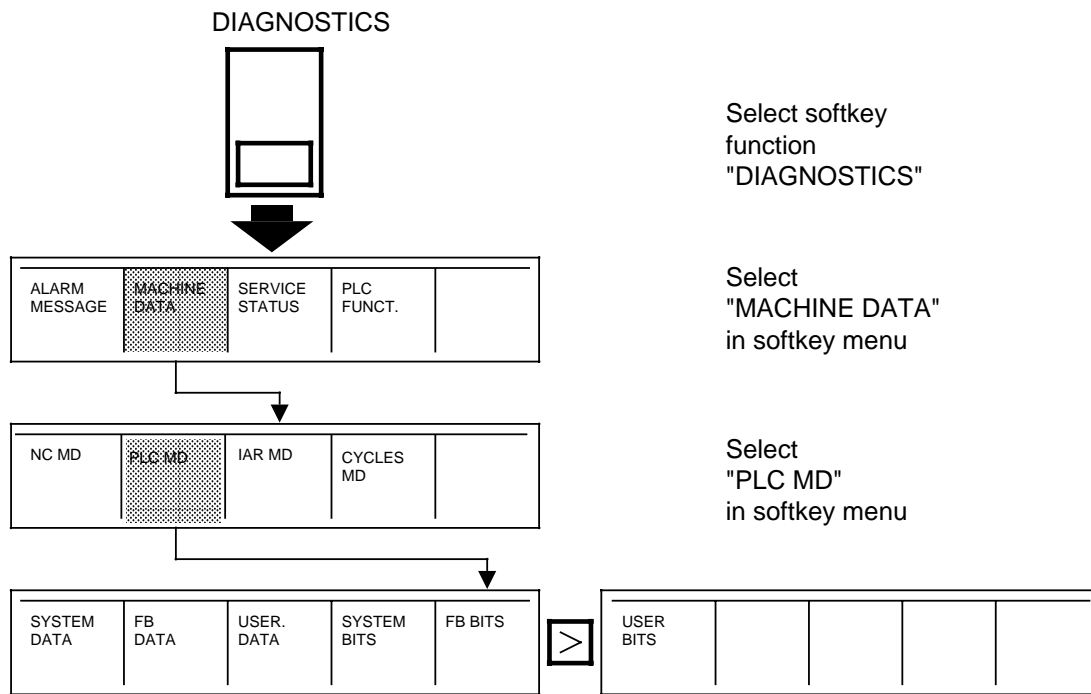

## 9.4.2 PLC MD description

### 9.4.2.1 PLC machine data for the operating system

<b>0</b>	<b>Number of alarm bytes (to Software Version 3)</b>			<b>0</b>
Standard value	Lower input limit	Upper input limit	Units	
<b>0</b>	<b>0</b>	<b>4</b>	<b>-</b>	

Here the user defines up to 4 contiguous process alarm bytes within the inputs available to him (also see PLC MD 1).

<b>1</b>	<b>Number of the first alarm byte (to Software Version 3)</b>			<b>1</b>
Standard value	Lower input limit	Upper input limit	Units	
<b>0</b>	<b>0</b>	<b>127</b>	<b>-</b>	

Here the user specifies the number of the first alarm byte (see also PLC MD 0).

<b>2</b>	<b>Time call reference of OB 5</b>			<b>2</b>
Standard value	Lower input limit	Upper input limit	Units	
<b>1</b>	<b>1</b>	<b>3</b>	<b>2.5 ms</b>	

Here the user defines the time call reference  $n \cdot 2.5 \text{ ms}$  by inputting the factor  $n=1, 2, 3$ .



<b>3</b>	<b>Time call reference of OB 6</b>			<b>3</b>
Standard value	Lower input limit	Upper input limit	Units	
<b>1</b>	<b>1</b>	<b>9</b>	<b>10 ms</b>	

The user defines the time call reference  $m \cdot 10$  ms by inputting the factor  $m = 1, \dots, 9$ .

<b>4</b>	<b>Time call reference of OB 7</b>			<b>4</b>
Standard value	Lower input limit	Upper input limit	Units	
<b>1</b>	<b>1</b>	<b>255</b>	<b>100 ms</b>	

The user defines the time call reference  $m \cdot 10$  ms by entering the factor  $p = 1, \dots, 255$ .

<b>5</b>	<b>Last STEP 5 timer</b>			<b>5</b>
Standard value	Lower input limit	Upper input limit	Units	
<b>64</b>	<b>-1</b>	<b>+256</b>	<b>-</b>	

The processing of individual timers places a certain load on the PLC operating system. If in the user program, for example, only the timers 1 to 20 are required, input the number 20 and the system program will only process these timers. This saves processing time and a better PLC cycle time can be achieved.

The input of "-1" means that **all** times are disabled.

<b>6</b>	<b>1st input byte for operator panel inputs</b>			<b>6</b>
Standard value	Lower input limit	Upper input limit	Units	
<b>64</b>	<b>0</b>	<b>96</b>	<b>-</b>	

The user defines from which input byte the operator panel inputs are located (minimum value = IB 64, maximum value = 96).

<b>7</b>	<b>1st output byte for operator panel outputs</b>			<b>7</b>
Standard value	Lower input limit	Upper input limit	Units	
<b>64</b>	<b>0</b>	<b>112</b>	<b>-</b>	

The user defines from which output byte the operator panel outputs are located (minimum value = QB 64, maximum value = 112).

<b>8</b>	<b>Last active channel</b>			<b>8</b>
Standard value	Lower input limit	Upper input limit	Units	
<b>16</b>	<b>1</b>	<b>16</b>	<b>-</b>	

Here the last activated channel (channel number) is communicated to the PLC system program.

<b>9</b>	<b>Last active spindle</b>			<b>9</b>
Standard value	Lower input limit	Upper input limit	Units	
<b>6</b>	<b>1</b>	<b>6</b>	-	

Here the last spindle to be activated (spindle number) is communicated to the PLC system program.

<b>10</b>	<b>Last active axis</b>			<b>10</b>
Standard value	Lower input limit	Upper input limit	Units	
<b>24</b>	<b>1</b>	<b>24</b>	-	

Here the last axis to be activated (axis number) is communicated to the PLC system program.

<b>11</b>	<b>Erase limit input image</b>			<b>11</b>
Standard value	Lower input limit	Upper input limit	Units	
<b>127</b>	<b>63</b>	<b>127</b>	-	

The user can define up to which input byte the input image will be erased on warm restart. This means that the input bytes which are not reserved by process I/Os or I/O modules can be used as additional flag bytes.

**Example:** Erase limit PLC MD 11 = 72

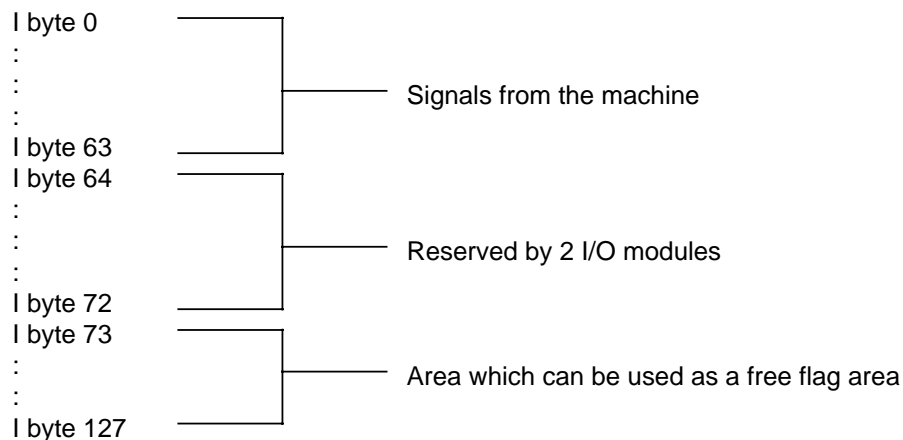

<b>12</b>	<b>Erase limit output image</b>			<b>12</b>
Standard value	Lower input limit	Upper input limit	Units	
<b>127</b>	<b>63</b>	<b>127</b>	-	

The user can define up to which output byte the input image will be erased on warm restart. This means that the output bytes which are not reserved by process I/Os or I/O modules can be used as additional flag bytes.

<b>13</b>	<b>Number of expansion units connected to EU interface 1</b>			<b>13</b>
Standard value	Lower input limit	Upper input limit	Units	
<b>0</b>	<b>0</b>	<b>4</b>	-	

<b>14</b>	<b>Number of expansion units connected to EU interface 2</b>			<b>14</b>
Standard value	Lower input limit	Upper input limit	Units	
<b>0</b>	<b>0</b>	<b>4</b>	-	

<b>15</b>	<b>Number of expansion units connected to EU interface 3</b>			<b>15</b>
Standard value	Lower input limit	Upper input limit	Units	
<b>0</b>	<b>0</b>	<b>4</b>	<b>-</b>	

Here the number of expansion units which are connected to the interface module is communicated to the PLC system program.

<b>17</b>	<b>Number of weighting cycles for an assigned user interface</b>			<b>17</b>
Standard value	Lower input limit	Upper input limit	Units	
<b>1</b>	<b>1</b>	<b>10</b>	<b>-</b>	

The parameterized delay is specified as the number of PLC cycles to wait for the user interface to be enabled and is valid for all user interfaces of a PLC. After the delay has elapsed a message frame for the user interface is acknowledged negatively.

Standard value : 1 i.e. after one PLC cycle the user interface must be free again.  
max. input value : 10 i.e. after 10 PLC cycle the user interface must be free again.

<b>18</b>	<b>Number of the user interface which is processed on synchronization</b>			<b>18</b>
Standard value	Lower input limit	Upper input limit	Units	
<b>0</b>	<b>0</b>	<b>31</b>	<b>-</b>	

Message output to the whole computer during synchronization is only possible for the user interface specified here.

Standard value : 0, i.e. the first user interface which is processed during synchronization  
 max. input value : 31

<b>19</b>	<b>No. of the function numbers for kernel sequence initiation from UI</b>			<b>19</b>
Standard value	Lower input limit	Upper input limit	Units	
<b>3</b>	<b>0</b>	<b>10</b>	<b>-</b>	

No. of function numbers for a kernel sequence initiation from user interface.

Input values:     0                 = Kernel sequence initiation from user interface not permitted in this PLC  
                   1...10 (max.) = Kernel sequence initiation from user interface permissible. The number of function numbers starting with the machine data DB 60, DW 20 is specified for which a kernel sequence initiation from user interface occurs.  
                   3                 = Standard value

<b>20-29</b>	<b>Function no. for kernel sequence initiation from user interface</b>		<b>20-29</b>
Standard value	Lower input limit	Upper input limit	Units
<b>see below</b>	<b>0</b>	<b>255</b>	<b>-</b>

Function numbers which initiate a kernel sequence via user interface.  
The area must be assigned continuously from DB 61, DW 20.

Standard value	MD 20 : Fct. No. 25 (Message R_TS__)
Standard value	MD 21 : Fct. No. 26 (Message R_WB__)
Standard value	MD 22 : Fct. No. 30 (Message R_WE__)
Standard value	MD 23 : Fct. No. 0
:	:
:	:
:	:
Standard value	MD 29 : Fct. No. 0
Max. input value	... : Fct. No. 255

<b>30</b>	<b>No. of interrupt bytes of the EU interface 1</b>			<b>30</b>
Standard value	Lower input limit	Upper input limit	Units	
<b>-1</b>	<b>-1</b>	<b>127</b>	<b>-</b>	

<b>31</b>	<b>No. of interrupt bytes of EU interface 2</b>			<b>31</b>
Standard value	Lower input limit	Upper input limit	Units	
<b>-1</b>	<b>-1</b>	<b>127</b>	<b>-</b>	

<b>32</b>	<b>No. of interrupt bytes of EU interface 3</b>			<b>32</b>
Standard value	Lower input limit	Upper input limit	Units	
<b>-1</b>	<b>-1</b>	<b>127</b>	<b>-</b>	

The number of the interrupt byte which is to be processed in the interface module is communicated to the PLC system program.

<b>33</b>	<b>No. of user interfaces for command channel</b>			<b>33</b>
Standard value	Lower input limit	Upper input limit	Units	
<b>0</b>	<b>0</b>	<b>8</b>	<b>-</b>	

Here the number of user interfaces is communicated to the PLC system program in DB 41.



<b>34</b>	<b>Initial address 1st DMP submodule 1st DMP interface 1st line (from Software Version 4)</b>			<b>34</b>
Standard value	Lower input limit	Upper input limit	Units	
<b>-1</b>	<b>0</b>	<b>158</b>	<b>-</b>	

.

.

.

.

.

<b>48</b>	<b>Initial address 15th DMP submodule 1st DMP interface 1st line (from Software Version 4)</b>			<b>48</b>
Standard value	Lower input limit	Upper input limit	Units	
<b>-1</b>	<b>0</b>	<b>158</b>	<b>-</b>	

PLC MD, DB60 DW	DMP IM	MPC	DMP sub- module	PLC MD default value	DMP rotary switch position
34	1	1	1	-1	E
35	1	1	2	-1	D
36	1	1	3	-1	C
37	1	1	4	-1	B
38	1	1	5	-1	A
39	1	1	6	-1	9
40	1	1	7	-1	8
41	1	1	8	-1	7
42	1	1	9	-1	6
43	1	1	10	-1	5
44	1	1	11	-1	4
45	1	1	12	-1	3
46	1	1	13	-1	2
47	1	1	14	-1	1
48	1	1	15	-1	0
49	1	2	1	-1	E
50	1	2	2	-1	D
51	1	2	3	-1	C
52	1	2	4	-1	B
53	1	2	5	-1	A
54	1	2	6	-1	9
55	1	2	7	-1	8
56	1	2	8	-1	7
57	1	2	9	-1	6
58	1	2	10	-1	5
59	1	2	11	-1	4
60	1	2	12	-1	3
61	1	2	13	-1	2
62	1	2	14	-1	1
63	1	2	15	-1	0
64	2	1	1	-1	E
65	2	1	2	-1	D
66	2	1	3	-1	C
67	2	1	4	-1	B
68	2	1	5	-1	A
69	2	1	6	-1	9
70	2	1	7	-1	8
71	2	1	8	-1	7
72	2	1	9	-1	6
73	2	1	10	-1	5
74	2	1	11	-1	4
75	2	1	12	-1	3
76	2	1	13	-1	2
77	2	1	14	-1	1
78	2	1	15	-1	0

PLC MD, DB60 DW	DMP IM	Cable	DMP submodule	PLC MD default value	DMP rotary switch position
79	2	2	1	-1	E
80	2	2	2	-1	D
81	2	2	3	-1	C
82	2	2	4	-1	B
83	2	2	5	-1	A
84	2	2	6	-1	9
85	2	2	7	-1	8
86	2	2	8	-1	7
87	2	2	9	-1	6
88	2	2	10	-1	5
89	2	2	11	-1	4
90	2	2	12	-1	3
91	2	2	13	-1	2
92	2	2	14	-1	1
93	2	2	15	-1	0
94	3	1	1	-1	E
95	3	1	2	-1	D
96	3	1	3	-1	C
97	3	1	4	-1	B
98	3	1	5	-1	A
99	3	1	6	-1	9
100	3	1	7	-1	8
101	3	1	8	-1	7
102	3	1	9	-1	6
103	3	1	10	-1	5
104	3	1	11	-1	4
105	3	1	12	-1	3
106	3	1	13	-1	2
107	3	1	14	-1	1
108	3	1	15	-1	0
109	3	2	1	-1	E
110	3	2	2	-1	D
111	3	2	3	-1	C
112	3	2	4	-1	B
113	3	2	5	-1	A
114	3	2	6	-1	9
115	3	2	7	-1	8
116	3	2	8	-1	7
117	3	2	9	-1	6
118	3	2	10	-1	5
119	3	2	11	-1	4
120	3	2	12	-1	3
121	3	2	13	-1	2
122	3	2	14	-1	1
123	3	2	15	-1	0

<b>128</b>	<b>RESERVED</b>			<b>128</b>
Standard value	Lower input limit	Upper input limit	Units	

<b>129</b>	<b>RESERVED</b>			<b>129</b>
Standard value	Lower input limit	Upper input limit	Units	

<b>130</b>	<b>No. of interrupt byte of 1st DMP interface, 1st line</b>			<b>130</b>
Standard value	Lower input limit	Upper input limit	Units	
<b>-1</b>	<b>-1</b>	<b>158</b>	<b>-</b>	

<b>131</b>	<b>No. of interrupt byte of 1st DMP interface, 2nd line</b>			<b>131</b>
Standard value	Lower input limit	Upper input limit	Units	
<b>-1</b>	<b>-1</b>	<b>158</b>	<b>-</b>	

<b>132</b>	<b>No. of interrupt byte of 2nd DMP interface, 1st line</b>			<b>132</b>
Standard value	Lower input limit	Upper input limit	Units	
<b>-1</b>	<b>-1</b>	<b>158</b>	<b>-</b>	

<b>133</b>	<b>No. of interrupt byte of 2nd DMP interface, 2nd line</b>			<b>133</b>
Standard value	Lower input limit	Upper input limit	Units	
<b>-1</b>	<b>-1</b>	<b>158</b>	<b>-</b>	

<b>134</b>	<b>No. of interrupt byte of 3rd DMP interface, 1st line</b>			<b>134</b>
Standard value	Lower input limit	Upper input limit	Units	
<b>-1</b>	<b>-1</b>	<b>158</b>	<b>-</b>	

<b>135</b>	<b>No. of interrupt byte of 3rd DMP interface, 2nd line</b>			<b>135</b>
Standard value	Lower input limit	Upper input limit	Units	
<b>-1</b>	<b>-1</b>	<b>158</b>	<b>-</b>	

**9.4.2.2 PLC MD for function blocks**

**PLC MD 2000 to 2249 for PLC 1**  
**PLC MD 2250 to 2499 for PLC 2**

<b>2000-2249</b>	<b>PLC 1</b>		<b>2000-2249</b>
<b>2250-2499</b>	<b>PLC 2</b>		<b>2250-2499</b>
Standard value	Lower input limit	Upper input limit	Units

Here a range of 249 PLC MD words has been reserved for the adaptation of future PLC packages and function blocks. You will find the description with the PLC packages and function blocks in question.

**9.4.2.3 PLC MD for user**

**PLC MD 4000 to 4099 for PLC 1**  
**PLC MD 4100 to 4199 for PLC 2**

<b>4000-4099</b>	<b>PLC 1</b>		<b>4000-4099</b>
<b>4100-4199</b>	<b>PLC 2</b>		<b>4100-4199</b>
Standard value	Lower input limit	Upper input limit	Units

Here a range of 50 PLC MD words is available for the user's use. These can be used to attach the user machine program to the corresponding machine configuration (see also PLC MD 8000 to 8049).

### 9.4.3 PLC MD bits

PLC machine data for the basic program are required for two functions:

- a) Adaptation of the basic program to the actual NC structure

**Example of application:**

The following functions must be activated:

<b>NC functions</b>	<b>PLC MD</b>
NC channel 1	6000.0
NC channel 2	6000.1
Spindle 1	6012.0
Axis 1	6016.0
Axis 2	6016.1
Axis 3	6016.2
Axis 4	6016.3
V.24 input/output by the PLC	6026.7
Input module 1	6027.0
Output module 1	6027.4

b) Definition of the bytes for PLC error and operational messages

DB 10	Message No.			PLC MD (PLC 1)
DL 6	6000 ⋮ 6007	Error messages	Feed disable overall	6032.0
DR 6	6008 ⋮ 6015			
DL 7	6016 ⋮ 6023	Operational messages	Feed disable overall <b>and</b> read in disable	6040.2
DR 7	6024 ⋮ 6031			
DL 8	6032 ⋮ 6039			6032.4
DR 8	6056 ⋮ 6063	Error messages		
DL 9	6080 ⋮ 6087		Read in disable	
DR 9	6080 ⋮ 6087	Operational messages		6040.7
DL 10	6080 ⋮ 6087			
DR 10	6080 ⋮ 6087	Error messages		6033.1
DL 11	6080 ⋮ 6087	Error messages	Disable NC start	6033.2
DR 11	6088 ⋮ 6095			



**Table of error numbers**

Channel 1	6000 - 6095	DB 10, DW 6 - DW 11
Channel 2	6100 - 6195	DB 11, DW 6 - DW 11
Channel 3	6200 - 6295	DB 12, DW 6 - DW 11
Channel 4	6300 - 6395	DB 13, DW 6 - DW 11
Channel 5	6400 - 6495	DB 14, DW 6 - DW 11
Channel 6	6500 - 6595	DB 15, DW 6 - DW 11
Channel 7	6600 - 6695	DB 16, DW 6 - DW 11
Channel 8	6700 - 6795	DB 17, DW 6 - DW 11
Channel 9	6800 - 6895	DB 18, DW 6 - DW 11
.	.	.
.	.	.
.	.	.
Channel 16	7500 - 7595	DB 25, DW 6 - DW 11
Spindle 1	8000 - 8015	DB 31, DW 3
Spindle 2	8020 - 8035	DB 31, DW 7
Spindle 3	8040 - 8055	DB 31, DW 11
Spindle 4	8060 - 8075	DB 31, DW 15
Spindle 5	8080 - 8095	
Spindle 6	8100 - 8115	
Axis 1	8200 - 8215	DB 32, DW 3
Axis 2	8220 - 8235	DB 32, DW 7
Axis 3	8240 - 8255	DB 32, DW 11
Axis 4	8260 - 8275	DB 32, DW 15
Axis 5	8280 - 8295	DB 32, DW 19
Axis 6	8300 - 8315	DB 32, DW 23
Axis 7	8320 - 8335	DB 32, DW 27
Axis 8	8340 - 8355	DB 32, DW 31
Axis 9	8360 - 8375	DB 32, DW 35
Axis 10	8380 - 8395	DB 32, DW 39
Axis 11	8400 - 8415	DB 32, DW 43
Axis 12	8420 - 8435	DB 32, DW 47
Axis 13	8440 - 8455	DB 32, DW 51
Axis 14	8460 - 8475	DB 32, DW 55
Axis 15	8480 - 8495	DB 32, DW 59
Axis 16	8500 - 8515	DB 32
.	.	.
.	.	.
.	.	.
Axis 24	8660 - 8675	DB 32,
PLC 1	9000 - 9247	DB 58, DW 1 - DL 16
PLC 2	9250 - 9497	DB 58, DW 1 - DL 16

**9.4.3.1 PLC MD bits for operating system (DB 63)**  
**NC MD 6000 to 6099 for PLC 1**  
**NC MD 6100 to 6199 for PLC 2**

PLC MD DW No.	Bit No.							
	7	6	5	4	3	2	1	0
<b>6000</b>	Signals from/to NC channel							
<b>DL 0</b>	8	7	6	5	4	3	2	1
<b>6001</b>	Signals from/to NC channel							
<b>DR 0</b>	16	15	14	13	12	11	10	9

- Bit = 0** The signals from and to the NC channel are not transferred to the channel.
- Bit 1** The signals from and to the NC channel are transferred to the channel (including MD coding M00 - M99 and output of the auxiliary functions and block information).

**Note:**

The bit may only be set for one PLC as the signals to the NC channel can only be output by one PLC.

If the bits for PLC I and PLC II are set the system branches into the stop loop (for error list see Interface Description Part 1).

PLC MD DW No.	Bit No.							
	7	6	5	4	3	2	1	0
<b>6003</b>	Signals from the NC channel							
<b>DR 1</b>	8	7	6	5	4	3	2	1
<b>6004</b>	Signals from the NC channel							
<b>DL 2</b>	16	15	14	13	12	11	10	9

**Bit = 0** The signals from and to the NC channel are not transferred to the PLC.

**Bit = 1** The signals from the NC channel are transferred to the PLC (including MD coding M00 - M99 and output of the auxiliary functions and block information).

**Notes:**

- The bit can be set for the PLC.
- The bit is used if for example PLC II must monitor the signals of an NC channel; they are processed by PLC 1.

**Application examples:**

Signals from/to the NC channel 1 to PLC I:    PLC MD 6000.0 = 1

Signals from/to the NC channel 1 to PLC II:    PLC MD 6103.0 = 1

PLC MD DW No.	Bit No.							
	7	6	5	4	3	2	1	0
<b>6006</b>	Feed disable and read in disable on the NC channel							
<b>DL 3</b>	8	7	6	5	4	3	2	1
<b>6007</b>	Feed disable and read in disable on the NC channel							
<b>DR 3</b>	16	15	14	13	12	11	10	9

**Bit = 1** Read in disable and feed disable are active.  
**Bit = 0** Read in disable and feed disable are inactive.

**Notes:**

- The bit is only active if the bit SIGNALS from the NC CHANNEL is set.
- In the PLC for which this bit is set the interface bit set for read in disable and feed disable are ignored on scanning the error and operational messages.
- The bit is only active in the modes AUTOMATIC and MDA.
- The mode selection switch must be transferred in the channel concerned.

**Application examples:**

PLC I normally processes NC channel 1.  
 PLC II must initiate a read in disable **quickly** in special cases.

PLC MD DW No.	Bit No.							
	7	6	5	4	3	2	1	0
<b>6009</b>	M decoding with extended address for NC channel							
<b>DR 4</b>	8	7	6	5	4	3	2	1
<b>6010</b>	M decoding with extended address for NC channel							
<b>DL 5</b>	16	15	14	13	12	11	10	9

### M DECODING WITH EXTENDED ADDRESS FOR NC CHANNEL (1 TO 16)

**Bit = 0** M decoding with extended address is not performed.

**Bit = 1** M decoding with extended address is performed.

#### Notes:

- To perform M decoding with extended address the corresponding data block (DB 80 - DB 95) must be loaded. If the bit is set and the DB is not available the PLC branches into the stop loop (for error list see Interface Description Part 1).
- The bit can be set for every PLC.
- The bit SIGNALS FROM/TO THE NC CHANNEL OR SIGNALS FROM THE NC CHANNEL must be set.

PLC MD DW No.	Bit No.							
	7	6	5	4	3	2	1	0
<b>6012</b>	Signals from/to spindle							
<b>DL 6</b>			6	5	4	3	2	1

**Bit = 0** Signals from/to spindle are not transferred to the signal.

**Bit = 1** Signals from/to spindle are transferred to the signal.

#### Note:

The bit can only be set for one PLC as the signals to the spindle can only be output from one PLC. If the bits are set for example for PLC I and PLC II the PLC branches into the stop loop (for error list see Interface Description Part 1).

PLC MD DW No.	Bit No.							
	7	6	5	4	3	2	1	0
<b>6014</b>	Signals from spindle							
<b>DL 7</b>			6	5	4	3	2	1

**Bit = 0** Signals from the spindle are not transferred to the interface.

**Bit = 1** Signals from the spindle are transferred to the interface.

**Notes:**

- The bit must be set for every PLC.
- The bit CHANGE GEAR is not transferred.

**Application example:**

Signals from/to spindle 2 are transferred to PLC II:

PLC MD 6114 bit 1=1

Signals from spindle 2 are transferred to PLC I:

PLC MD 6012 bit 1=1

PLC MD DW No.	Bit No.							
	7	6	5	4	3	2	1	0
<b>6016</b>	Signals from/to axis							
<b>DL 8</b>	8	7	6	5	4	3	2	1
<b>6017</b>	Signals from/to axis							
<b>DR 8</b>	16	15	14	13	12	11	10	9
<b>6018</b>	Signals from/to axis							
<b>DL 9</b>	24	23	22	21	20	19	18	17

**Bit = 0** Signals from/to axis are not transferred to the axis.

**Bit = 1** Signals from/to axis are transferred to the axis by the PLC.

**Note:**

The bit can only be set for one PLC as the signals to the axis can only be output by one PLC.

If the bits for PLC I and PLC II are set the PLC branches into the stop loop (for error list see Interface Description Part 1).

PLC MD DW No.	Bit No.							
	7	6	5	4	3	2	1	0
<b>6021</b>	Signals to axis							
<b>DR 10</b>	8	7	6	5	4	3	2	1
<b>6022</b>	Signals to axis							
<b>DL 11</b>	16	15	14	13	12	11	10	9
<b>6023</b>	Signals to axis							
<b>DR 11</b>	24	23	22	21	20	19	18	17

**Bit = 0** Signals from the axis are not transferred to the interface.

**Bit = 1** Signals from the axis are transferred to the interface.

**Note:**

The bit can be set for every PLC.

**Application example:**

Signals from/to axis 10 are transferred to PLC II:

PLC MD 6122.1=1

Signals from axis 10 are transferred to PLC I:

PLC MD 6022.1=1



PLC MD DW No.	Bit No.							
	7	6	5	4	3	2	1	0
<b>6026</b> <b>DL 13</b>	Serial interface		Deselec- tion auto- matic NC START disable	Operator panel switchover active	Save FY 200- FY 223	Acces by @ commands disabled	Command channel active	

**Bit 7:** Serial interface active

**Note:**

The bit can only be set for one PLC. If the bit is set for PLC I and PLC II the PLC branches into the stop loop (for error list see Interface Description part 1).

- Bit 5:** **Bit 5=0** The channel-specific signal NC start disable (DB 10-25) (D 11.15) causes DISABLE NC START.  
**Bit 5=1** DISABLE NC START is not automatically initiated. It must be programmed by the user.
- Bit 4:** **Bit 4=0** Operator panel switchover is disabled.  
**Bit 4=1** Operator panel switchover is enabled.
- Bit 3:** Save FY 200- FY 223  
Only active together with PLC 155U.
- Bit 2:** **Bit 2=0** The writing of PLC data is enabled by @ commands.  
**Bit 2=1** Writing is disabled.
- Bit 1:** **Bit 1=1** The function COMMAND CHANNEL is active.  
**Bit 1=0** The function COMMAND CHANNEL is not active.

PLC MD DW No.	Bit No.							
	7	6	5	4	3	2	1	0
<b>6027</b>								
<b>DR 13</b>						Inputs from input module		
					4	3	2	1

**Bit = 0** No transfer of input module signals into the process image of the inputs.

**Bit = 1** Transfer of the input module signals into the process image of the inputs.

**Assignment example:**

Module (=rotary switch)	Input area
0	64 - 71
1	72 - 79
2	80 - 87
3	88 - 95

**Notes:**

- The bit can be set for every PLC.
- Up to 4 I/O modules can be connected to the NC operator panels. The input signals of the modules can be routed to the process image of PLC I to PLC II via the PLC machine data ACCESS TO I/O MODULE 1 TO 4.
- Maximum value: 96.  
The 1st input byte for operator panel inputs can be set via PLC MD 6.

PLC MD DW No.	Bit No.							
	7	6	5	4	3	2	1	0
<b>6028</b>						Outputs to output module		
<b>DL 14</b>					4	3	2	1

**Bit = 0** No transfer to the output module from the process image of the outputs.

**Bit = 1** Transfer to the output module from the process image of the outputs.

**Assignment example:**

Module (=rotary switch)	Output area
0	64 - 67
1	68 - 71
2	72 - 75
3	76 - 79

**Notes:**

- The bit can be set for one PLC as the output from the outputs can only come from one PLC. If the bits for PLC I and PLC II are set the PLCs branch into the stop loop (for error list see Interface Description Part 1).
- Up to 4 I/O modules can be connected to the operator panel. The output signals of the modules can be routed to the PLC via PLC machine data ACCESS TO I/O MODULE 1 TO 4.
- Maximum value=112.  
The 1st output byte for operator panel outputs can be set via PLC MD 7.

PLC MD DW No.	Bit No.							
	7	6	5	4	3	2	1	0
<b>6029</b> <b>DL 6</b>					ELG signals to NC			T/H word jumpering

**Bit 0 = 1** The T/H words are transferred to the expanded interface.  
**= 0** No transfer to the expanded interface.

PLC MD DW No.	Bit No.							
	7	6	5	4	3	2	1	0
<b>6030</b>	Error - operational messages for not activated channels							
<b>6031</b>								
	8	7	6	5	4	3	2	1
	16	15	14	13	12	11	10	9

0 signal: Corresponding **inactive** channel DB is not used for the activation of error and operational messages.

1 signal: The inactive channel DB is used for the activation of error and operational messages.

**Example:**

0 0 0 0 0 1 1 1	PLC MD 6000
-----------------	-------------

Only the error bits of the active channel DBs are evaluated for channel 1 to 3.

0 0 0 1 1 0 0 0	PLC MD 6030
-----------------	-------------

The error bits of the inactive channel DBs of channels 4 and 5 are evaluated.

**Note:**

If an error bit is set in an inactive channel DB which is used for the extended display of error and operational messages, then the corresponding errors do **not** appear for the display of message groups.

The simultaneous assignment of channels to the PLC (MD 6\*00 and 6\*01) and the activation of the display of error and operational messages of **not** used channels (MD 6\*30 and 6\*31) to different PLCs is not permissible because it causes incorrect displays.

**Example:** MD 6000.0 = 1 and  
 MD 6030.0 = 1

PLC MD DW No.	Bit No.							
	7	6	5	4	3	2	1	0
<b>6032</b>	Error messages signals to NC channel							
<b>DL 16</b>	DR 9	DL 9	DR 8	DL 8	DR 7	DL 7	DR 6	DL 6
<b>6033</b>	Error messages signals to NC channel							
<b>DR 16</b>					DR 11	DL 11	DR 10	DL 10

**Bit = 0** The bits of the corresponding interface byte are not evaluated for error messages by the PLC operating system.

**Bit = 1** The bits of the corresponding interface byte are evaluated for error messages by the PLC operating system.

**Notes:**

- The bit can be set for PLC I and PLC II
- The bit applies to all channels.
- If for the same PLC the **same** bit is also set for operational messages, the PLC branches into the stop loop in the start-up routine.

**Application example:**

Error messages for 1 signal of a bit in DR 8: PLC MD

DR 8.5 in channel 2 (DB 11) causes error message No. 6145 (see Section 19 of the Interface Description).

### Activating error and operational messages via unused channel DBs.

0 signal: Corresponding **inactive** channel DB is not used for the activation of error and operational messages.

1 signal: The inactive channel DB is used for the activation of error and operational messages.

#### Note:

If an error bit is set in an unused channel DB which is used for the extended display of error and operational messages, the corresponding errors do not appear when message groups are displayed.

#### Example:

0	0	0	0	0	1	1	1
---	---	---	---	---	---	---	---

 PLC MD 6000

Only the error bits of the active channel DBs are evaluated for channel 1 to 3.

0	0	0	1	1	0	0	0
---	---	---	---	---	---	---	---

 PLC MD 6030

The error bits of the inactive channel DBs of channels 4 and 5 are evaluated.

**Table of message numbers**

Channel 1	6000 - 6095	DB 10, DW 6 - DW 11
Channel 2	6100 - 6195	DB 11, DW 6 - DW 11
Channel 3	6200 - 6295	DB 12, DW 6 - DW 11
Channel 4	6300 - 6395	DB 13, DW 6 - DW 11
Channel 5	6400 - 6495	DB 14, DW 6 - DW 11
Channel 6	6500 - 6595	DB 15, DW 6 - DW 11
Channel 7	6600 - 6695	DB 16, DW 6 - DW 11
Channel 8	6700 - 6795	DB 17, DW 6 - DW 11
Channel 9	6800 - 6895	DB 18, DW 6 - DW 11
Channel 10	6900 - 6995	DB 19, DW 6 - DW 11
Channel 11	7000 - 7095	DB 20, DW 6 - DW 11
Channel 12	7100 - 7115	DB 21, DW 6 - DW 11
Channel 13	7200 - 7295	DB 22, DW 6 - DW 11
Channel 14	7300 - 7395	DB 23, DW 6 - DW 11
Channel 15	7400 - 7495	DB 24, DW 6 - DW 11
Channel 16	7500 - 7595	DB 25, DW 6 - DW 11
Spindle 1	8000 - 8015	DB 31, DW 3
Spindle 2	8020 - 8035	DB 31, DW 7
Spindle 3	8040 - 8055	DB 31, DW 11
Spindle 4	8060 - 8075	DB 31, DW 15
Spindle 5	8080 - 8095	DB 31, DW 19
Spindle 6	8100 - 8115	DB 31, DW 23
Axis 1	8200 - 8215	DB 32, DW 3
Axis 2	8220 - 8235	DB 32, DW 7
Axis 3	8240 - 8255	DB 32, DW 11
Axis 4	8260 - 8275	DB 32, DW 15
Axis 5	8280 - 8295	DB 32, DW 19
Axis 6	8300 - 8315	DB 32, DW 23
Axis 7	8320 - 8335	DB 32, DW 27
Axis 8	8340 - 8355	DB 32, DW 31
Axis 9	8360 - 8375	DB 32, DW 35
Axis 10	8380 - 8395	DB 32, DW 39
Axis 11	8400 - 8415	DB 32, DW 43
Axis 12	8420 - 8435	DB 32, DW 47
Axis 13	8440 - 8455	DB 32, DW 51
Axis 14	8460 - 8475	DB 32, DW 55
Axis 15	8480 - 8495	DB 32, DW 59
Axis 16	8500 - 8515	DB 32, DW 63
Axis 17	8520 - 8535	DB 32, DW 67
Axis 18	8540 - 8555	DB 32, DW 71
Axis 19	8560 - 8575	DB 32, DW 75
Axis 20	8580 - 8595	DB 32, DW 79
Axis 21	8600 - 8615	DB 32, DW 83
Axis 22	8620 - 8635	DB 32, DW 87
Axis 23	8640 - 8655	DB 32, DW 91
Axis 24	8660 - 8675	DB 32, DW 95
PLC 1	9000 - 9997	DB 58, DW 1 - DL 32
PLC 2		DB 58, DW 1 - DL 32

PLC MD DW No.	Bit No.							
	7	6	5	4	3	2	1	0
<b>6034</b>	Error messages signals to spindle							
<b>DL 17</b>							DR <sub>k+3</sub>	DL <sub>k+3</sub>

**Bit = 0** The bits of the corresponding interface byte are not evaluated for error messages by the PLC operating system.

**Bit = 1** The bits of the corresponding interface byte are evaluated for error messages by the PLC operating system.

**Notes:**

- The bit can be different in PLC I and PLC II.
- The bit applies to **all** spindles.
- If for the same PLC the **same** bit is also set for operational messages, the PLC branches into the stop loop in the start-up routine (for error list see Interface Description Part 1).

**Application example:**

DB 31 D 7.9      1 signal error message 8021;  
 PLC MD 6034.0= 1 (see Section 12 of the Interface Description)

PLC MD DW No.	Bit No.							
	7	6	5	4	3	2	1	0
<b>6035</b>	Error messages signals to axis							
<b>DR 17</b>							DR <sub>k+3</sub>	DL <sub>k+3</sub>

**Bit = 0** The bits of the corresponding interface byte are not evaluated for error messages by the PLC operating system.

**Bit = 1** The bits of the corresponding interface byte are evaluated for error messages by the PLC operating system.

**Notes:**

- The bit can be different in PLC I and PLC II.
- The bit applies to **all** axes.
- If for the **same** PLC the same bit is also set for operational messages, the PLC branches into the stop loop (for error list see Interface Description Part 1).

**Application example:**

DB 32 D 3.3      1 signal error message 8211;  
 PLC MD 6035 Bit 1= 1 (see Section 19 of the Interface Description)



PLC MD DW No.	Bit No.							
	7	6	5	4	3	2	1	0
<b>6036</b>	Error messages DB 58 messages							
<b>DL 18</b>	DR 4	DL 4	DR 3	DL 3	DR 2	DL 2	DR 1	DL 1
<b>6037</b>	Error messages DB 58 messages							
<b>DR 18</b>	DR 8	DL 8	DR 7	DL 7	DR 6	DL 6	DR 5	DL 5
<b>6038</b>	Error messages DB 58 messages							
<b>DL 19</b>	DR 12	DL 12	DR 11	DL 11	DR 10	DL 10	DR 9	DL 9
<b>6039</b>	Error messages DB 58 messages							
<b>DR 19</b>		DL 16	DR 15	DL 15	DR 14	DL 14	DR 13	DL 13

**Bit = 0** The bits of the corresponding interface byte are not evaluated for error messages by the PLC operating system.

**Bit = 1** The bits of the corresponding interface byte are evaluated for error messages by the PLC operating system.

**Notes:**

- The bit can be different in PLC I and PLC II.
- If for the **same** PLC the same bit is also set for operational messages, the PLC branches into the stop loop (for error list see Interface Description Part 1).

**Application example:**

DB 58 (PLC II) D 3.10 1 signal error message 9285 ;  
PLC MD 6136.4 = 1 (see Section 19 of the Interface Description)

PLC MD DW No.	Bit No.							
	7	6	5	4	3	2	1	0
<b>6040</b>	Operational messages signals to NC channel							
<b>DL 20</b>	DR 9	DL 9	DR 8	DL 8	DR7	DL 7	DR 6	DL 6
<b>6041</b>	Operational messages signals to NC channel							
<b>DR 20</b>					DR 11	DL 11	DR 10	DL 10

**Bit = 0** The bits of the corresponding interface byte are not evaluated for operational messages by the PLC operating system.

**Bit = 1** The bits of the corresponding interface byte are evaluated for operational messages by the PLC operating system.

**Notes:**

- The bit can be different in PLC I and PLC II.
- The bit applies to **all** NC channels.
- If for the **same** PLC the same bit is also set for error messages, the PLC branches into the stop loop (for error list see Interface Description Part 1).

**Application example:**

DB 10 D 0.6      1 signal operational message 6000;  
 PLC MD 6040.0= 1 (see Section 19 of the Interface Description)

PLC MD DW No.	Bit No.							
	7	6	5	4	3	2	1	0
<b>6042</b>	Operational messages signal to spindle							
<b>DL 21</b>							DR <sub>k+3</sub>	DL <sub>k+3</sub>

**Bit = 0** The bits of the corresponding interface byte are not evaluated for operational messages by the PLC operating system.

**Bit = 1** The bits of the corresponding interface byte are evaluated for error messages by the PLC operating system.

**Notes:**

- The bit can be different in PLC I and PLC II.
- The bit applies to **all** spindles.
- If for the **same** PLC the same bit is also set for error messages, the PLC branches into the stop loop (for error list see Interface Description Part 1).

**Application example:**

DB 31 D 7.1      1 signal operational message 8029;  
PLC MD 6042.1= 1 (see Section 19 of the Interface Description)

PLC MD DW No.	Bit No.							
	7	6	5	4	3	2	1	0
<b>6043</b>	Operational messages signals to axis							
<b>DR 21</b>							DR <sub>k+3</sub>	DL <sub>k+3</sub>

**Bit = 0** The bits of the corresponding interface byte are not evaluated for error messages by the PLC operating system.

**Bit = 1** The bits of the corresponding interface byte are evaluated for operational messages by the PLC operating system.

**Notes:**

- The bit can be different in PLC I and PLC II.
- The bit applies to **all** axes.
- If for the **same** PLC the same bit is also set for error messages, the PLC branches into the stop loop (for error list see Interface Description Part 1).

**Application example:**

DB 32 D 3.15    1 signal operational message 8207;  
PLC MD 6043.0= 1 (see Section 19 of the Interface Description)

PLC MD DW No.	Bit No.							
	7	6	5	4	3	2	1	0
<b>6044</b>	Operational message DB 58 messages							
<b>DL 22</b>	DR 4	DL 4	DR 3	DL 3	DR 2	DL 2	DR 1	DL 1
<b>6045</b>	Operational message DB 58 messages							
<b>DR 22</b>	DR 8	DL 8	DR 7	DL 7	DR 6	DL 6	DR 5	DL 5
<b>6046</b>	Operational message DB 58 messages							
<b>DL 23</b>	DR 12	DL 12	DR 11	DL 11	DR 10	DL 10	DR 9	DL 9
<b>6047</b>	Operational message DB 58 messages							
<b>DR 23</b>		DL 16	DR 15	DL 15	DR 14	DL 14	DR 13	DL 13

**Bit = 0** The bits of the corresponding interface byte are not evaluated for operational messages by the PLC operating system.

**Bit = 1** The bits of the corresponding interface byte are evaluated for operational messages by the PLC operating system.

**Notes:**

- The bit can be different in PLC I and PLC II.
- If for the **same** PLC the same bit is also set for error messages, the PLC branches into the stop loop (for error list see interface description part 1).

**Application example:**

DB 58 (PLC I) D 5.1 1 signal operational message 9073;  
 PLC-MD 6045.1 = 1 (see Section 19 of the Interface Description)

PLC MD DW No.	Bit No.							
	7	6	5	4	3	2	1	0
<b>6048</b> <b>DL 24</b>	Processing delay of							
	OB 7	OB 6	OB 5	OB 4	OB 3	OB 2		

**Bit = 0** A processing delay in the corresponding OB does not cause a STOP in the PLC.

**Bit = 1** A processing delay in the corresponding OB does cause a STOP in the PLC.

**Note:**

If a stop in the PLC is not required for a processing delay in the OB, a bit in flag byte 6 is set when the processing delay occurs. By scanning this bit the user can take any action he wishes.

PLC MD DW No.	Bit No.							
	7	6	5	4	3	2	1	0
<b>6049</b> <b>DL 6</b>								Access to PLC I/Os

**Bit 0 = 1:** Fast acknowledgement (no exact timeout analysis on error)

**Bit 0 = 0:** Slow acknowledgement (exact timeout analysis on error)

**Note:**

Set bit 0=0 on startup or test.

Set bit 0=1 during operation.

PLC MD DW No.	Bit No.							
	7	6	5	4	3	2	1	0
<b>6050</b> <b>DL 25</b>	Disable from							
	OB 7	OB 6	OB 5	OB 4	OB 3	OB 2		

**Bit = 0** The corresponding OB is enabled for processing.

**Bit = 1** The OB is disabled for processing and is not called by the system program.

PLC MD DW No.	Bit No.							
	7	6	5	4	3	2	1	0
<b>6051</b> <b>DR 25</b>							PG mode	PLC mode

**Bit 1= 0 :** The PLC 135 WB signals itself to be a 155U to the programmer.  
 S5-DOS version (155 U) restricted functionality.

**Bit 1= 1:** S5-DOS version + and additional software (PLC 135 WB)  
 With this setting and additional software +the PLC 135 WB signals itself with its  
 own identifiers (ISTACK etc.) to the programmer.

**Bit 0= 1:** A change of processing level (e.g. OB 5 interrupts OB 6) is only possible at block  
 boundaries (behaviour like PLC 113 WB normal mode).

**Bit 0= 0:** A change of processing level is possible after every STEP 5 command (special  
 mode).

**Note:**

The bit PLC mode must = 0, when the OB 2 and OB 5 are called. If this bit is set and the  
 OBs are loaded in the PLC they are still not processed.

PLC MD DW No.	Bit No.							
	7	6	5	4	3	2	1	0
<b>6052</b> <b>DL26</b>	Enable interrupt inputs of the 1st EU interface							
	7	6	5	4	3	2	1	0
<b>6053</b> <b>DR26</b>	Enable interrupt inputs of the 2nd EU interface							
	7	6	5	4	3	2	1	0
<b>6054</b> <b>DL27</b>	Enable interrupt inputs of the 3rd EU interface							
	7	6	5	4	3	2	1	0

Every interrupt input can be masked (0) or enabled (1) individually.

PLC MD DW No.	Bit No.							
	7	6	5	4	3	2	1	0
<b>6055</b>	Edge selection interrupt byte of the 1st EU interface							
<b>DR27</b>	7	6	5	4	3	2	1	0
<b>6056</b>	Edge selection interrupt byte of the 2nd EU interface							
<b>DL28</b>	7	6	5	4	3	2	1	0
<b>6057</b>	Edge selection interrupt byte of the 3rd EU interface							
<b>DR28</b>	7	6	5	4	3	2	1	0

The interrupt is triggered if a signal change occurs at the interrupt input. Whether the positive or the negative edge triggers the interrupt can be set via operating system machine data bits for every individual interrupt input.

Input values:      0: Positive edge triggers interrupt  
                      1: Negative edge triggers interrupt

Standard value:    0: At all interrupt inputs which are enabled the positive edge triggers an interrupt.

The machine data for the I/Os forming the interrupt are checked for validity by the system program on a cold restart. If the machine data are impermissible the PLC branches into the stop state with an error message (see list of detailed error codes).

PLC MD DW No.	Bit No.							
	7	6	5	4	3	2	1	0
<b>6060</b>					Servo CPU 4	Servo CPU 3	Servo CPU 2	Servo CPU 1
<b>6061</b>					NC-CPU 4	NC-CPU 3	NC-CPU 2	NC-CPU 1

**Bit 3-1 = 0 :**    If the CPU in question fails the PLC branches into the stop loop.

**Bit 3-1 = 1:**    No stop

### 9.4.3.2 General PLC MD bits

Overall allocation:

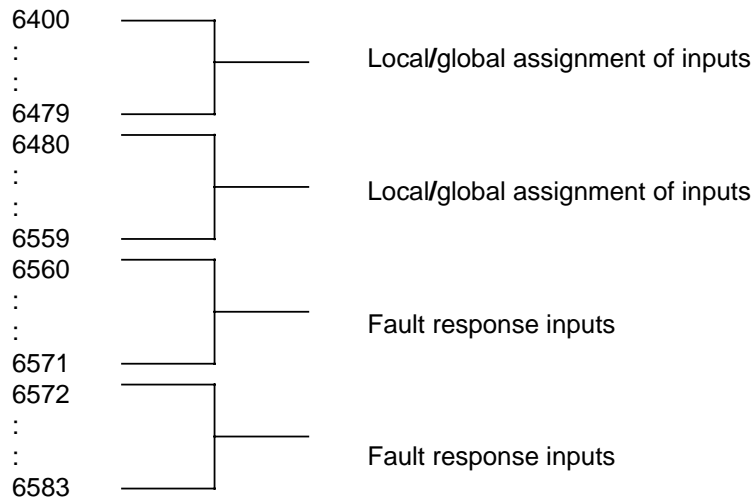



**Digital inputs, I/O groups 0-19:**

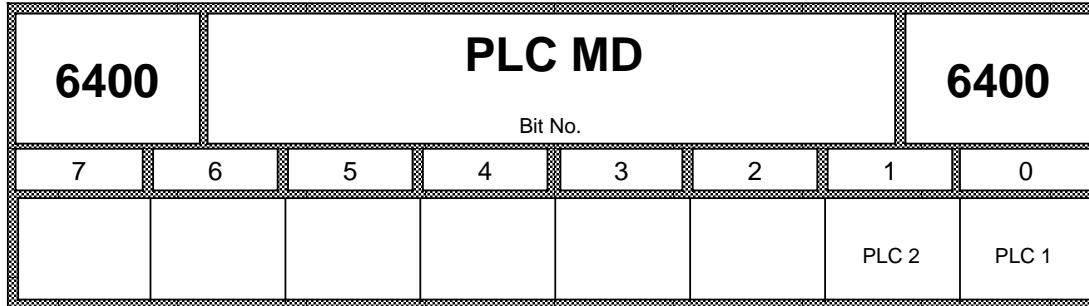

⋮

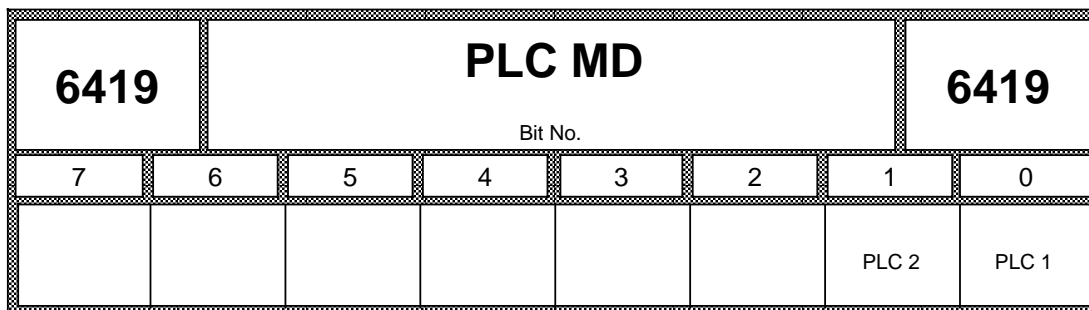

PLC 1	PLC 2
PLC MD No. 6400 to 6419	PLC MD No. 6420 to 6439

With this MD the individual I/O groups are assigned to the PLC CPUs. The bits for PLC 1 to PLC 4 specify:

- whether the I/O group can be processed by the corresponding PLC CPU
- which PLC CPU the individual I/O groups are assigned to in the hardware, i.e. the PLC is specified on whose bus the I/O module is plugged in or connected via an EU interface.

All the addressable I/Os are assigned to every PLC locally in the basic state. Double addressing (e.g. inputs were assigned to several PLCs in the hardware) is not permissible, the PLC CPU goes into the stop state with the appropriate error message which is entered in the error detailed coding (output address "F000").

It is possible for any PLC CPU to scan the individual inputs.

- 0 = I/O group is not processed.
- 1 = I/O group is processed by the PLC CPU in question.

**Digital outputs, I/O groups 0-19:**

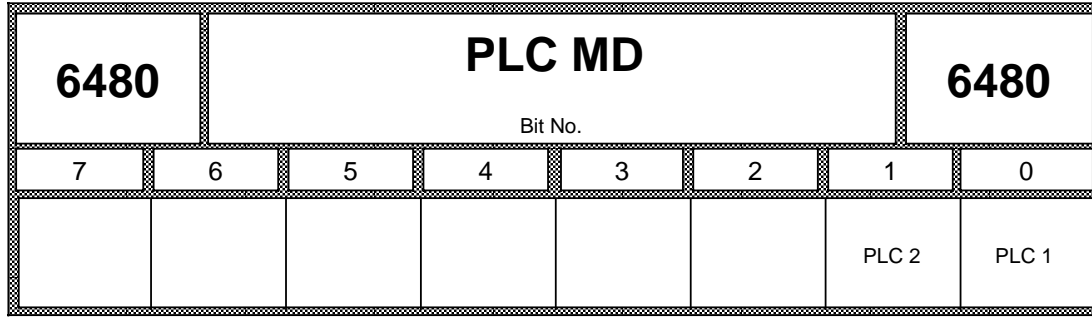

⋮

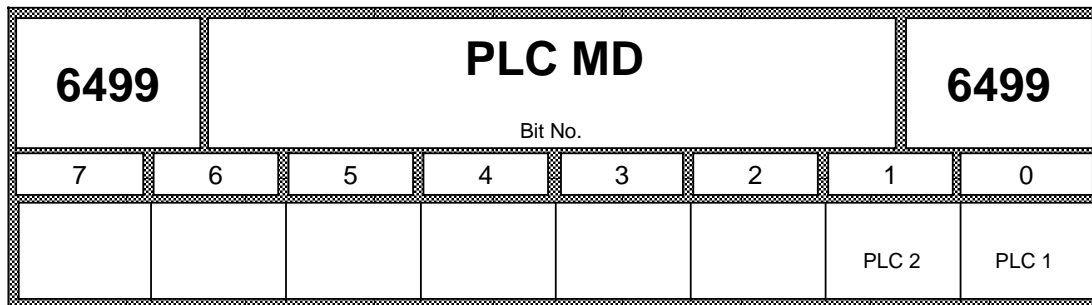

PLC 1	PLC 2
PLC MD No. 6480 to 6499	PLC MD No. 6500 to 6519

With this MD the individual I/O groups are assigned to the individual PLC CPU.

The bits for PLC 1 PLC 4 specify:

- whether the I/O group can be processed by the corresponding PLC CPU
- to which PLC CPU the individual I/O groups are assigned in the hardware, i.e. the PLC is specified on whose bus the I/O module is plugged in or connected via an EU interface.

All the addressable I/Os are assigned to every PLC locally in the basic state.

Each output I/O group can only be processed by **one** PLC CPU.

**Stop on failure of the I/O group inputs**

PLC MD DW No.	Bit No.							
	7	6	5	4	3	2	1	0
<b>6560</b>	Group 7	Group 6	Group 5	Group 4	Group 3	Group 2	Group 1	Group 0
<b>6561</b>	Group 15	Group 14	Group 13	Group 12	Group 11	Group 10	Group 9	Group 8
<b>6562</b>					Group 19	Group 18	Group 17	Group 16

PLC 1	PLC 2
PLC MD No. 6560 to 6562	PLC MD No. 6563 to 6565

- 1 = If the I/O module fails PLC branches into the stop loop.  
0 = If the I/O group fails the PLC does **not** branch into the stop loop.

Standard setting 1 stop state on failure

Using machine data it is possible to divide the I/Os into "important" and "unimportant" groups and in this way permit different responses to faults. On a fault either the cyclic operation of the PLC can be maintained and only a message initiated for the user or the PLC branches into the stop state. The messages for the user are placed in DB1. One bit is provided for every I/O group. In the basic signal flag area (F 6.0) the user is told whether a message is entered in DB 1. An entry is only made for the groups which are assigned to the PLC via machine data. If a PLC does not use a certain I/O group according to the routine list a fault and the response declared by the machine with regard to this group is irrelevant for the PLC in question.

**Stop on failure of the I/O group outputs**

PLC MD DW No.	Bit No.							
	7	6	5	4	3	2	1	0
<b>6572</b>	Group 7	Group 6	Group 5	Group 4	Group 3	Group 2	Group 1	Group 0
<b>6573</b>	Group 15	Group 14	Group 13	Group 12	Group 11	Group 10	Group 9	Group 8
<b>6574</b>					Group 19	Group 18	Group 17	Group 16

PLC 1	PLC 2
PLC MD No. 6572 to 6574	PLC MD No. 6575 to 6577

- 1 = If the I/O group fails the PLC branches into the stop state.
- 0 = If the I/O group fails the PLC does **not** branch into the stop state.

Standard setting 1 stop state on failure

## **Response to faults in the I/O devices**

### **General notes on fault response**

The division of the I/O devices into groups permits a differentiated response to faults in I/O devices (e.g. failure of a module). Using machine data it is possible to divide the I/Os into "important" and "unimportant" groups and to respond differently to each in case of fault. If a fault occurs either the cyclic operation of the PLC can be maintained and only a message initiated for the user or the PLC is stopped. The messages for the user are stored in DB 1. A bit is provided for every I/O module. In the basic signal flag area (F 6.0) the user is told whether a message was entered in DB 1. An entry is only made for those groups which are assigned to the PLC via machine data. If, according to the routing list, a PLC is not to operate a particular I/O group, a fault and the response declared in the machine data is irrelevant for this PLC.

### **Faults in central distributed I/O devices**

If the I/O group is assigned to this PLC, the PLC responds as set in the MD. If no STOP is requested, the module concerned is no longer operated during transfer. If the I/O group is assigned to another PLC, a message is given transfer between the I/O device and the global image is no longer performed. For inputs the corresponding process image is neutralized in both cases, i.e. it is set to 0.

### **Distributed power failure**

If, according to the machine data, a STOP is required, the PLC branches into the STOP state. However, after a reset a warm restart is performed.

### 9.4.3.3 PLC MD bits for function blocks (DB 64)

The PLC MDs 7000 to 7199 are described in the descriptions of the PLC packages in question as well.

NC MD 7000 to 7249 for PLC 1

NC MD 7250 to 7499 for PLC 2

PLC MD DW No.	Bit No.							
	7	6	5	4	3	2	1	0
<b>7000</b> <b>DL 0</b>	Tool scan process	Tool load/unload process		NC image file transfer process	File transfer process	Configure message process	Messages process	Global function process

**Bit 7:** Tool scan (FB104)

Bit 7=1: The function tool scan (FB 104) is processed.

**Bit 6:** Process tool load/unload (FB 105)

Bit 6=1: The function tool load/unload (FB 105) is processed.

**Bit 4:** Process NC image file transfer (FB 102)

Bit 4=1: The function selection of transfer of NC programs/data via NC image (FB 102) is processed.

**Bit 3:** Process file transfer (FB 102)

Bit 3=1: The function transfer of NC programs/data (FB 102) to the host computer is processed.

**Bit 2:** Process configurable message frame

Bit 2=1: The function user telegrams input/output is processed.

**Bit 1:** Process messages (FB 101)

Bit 1=1: The function message (FB 101) is processed. Messages are PLC and NC alarms, operational messages and user interrupts.

**Bit 0:** Process global functions (FB 100)

Bit 0=1: Global functions (FB 100) are processed.  
 Global functions are mode switchover, end of shift dialog and synchronizations.

PLC MD DW No.	Bit No.							
	7	6	5	4	3	2	1	0
<b>7001</b> <b>DR 0</b>	Tool ID code ASCII/Bit		Process user interrupt	Process operational message		Process mode switchover	Process end of shift dialog	Process synchroni- zation

PLC 1	PLC 2
PLC MD No. 6000 to 6079 7000 to 7049	PLC MD No. 6100 to 6179 7050 to 7099

**Bit 7:** Tool identification ASCII/bit pattern

**Bit 7=1:** Tool identifications in the message frame are code transparent (bit patterns). Are routed by the user.

**Bit 7=0:** Tool identification codes in the message frame are in ASCII.

**Bit 5:** Process user interrupts

**Bit 5=1:** The function user interrupts is processed, if the bit "process messages" is also set.

**Bit 4:** Process operational messages

**Bit 4=1:** The function operational messages is processed, if at the same time the bit "process messages" is set.

**Bit 2:** Process mode switchover

**Bit 3=1:** The function mode switchover is processed, if at the same time the bit "global functions" is set.

**Bit 1:** Process end of shift dialog

**Bit 2=1:** The function end of shift dialog is processed if at the same time the bit "global function" is set.

**Bit 0:** Process synchronization

**Bit 0=1:** The function is processed if at the same time the bit "global functions" is set.

PLC MD DW No.	Bit No.							
	7	6	5	4	3	2	1	0
<b>7002</b> <b>DL 1</b>	Package 5 activated	Scan and/or load/unload						

**Bit 7:** The MD bit must be set for the general activation of package 5 (computer link, transfer tool data). When a tool message frame arrives package 5 checks whether the MD bit is set. If the MD bit is set, package 5 is called by package 4. If the MD bit is not set the request message frame is acknowledged negatively.

**Bit 7=1:** Package 5 is activated

**Bit 6:** Scan and/or load/unload

**Bit 6=1:** Either scan or load/unload dialog.

If the bit is set then on a function initiation by the function block in question a check is made to see whether the other dialog type is already running (display in DB 101 DW 8).

If the other dialog type is already running, the initiation for the function is acknowledged negatively.

If the other dialog type is not running the function initiation is processed and the other dialog type is disabled until processing is completed or the requests are acknowledged negatively.

The user can check the dialog type currently running via DB 101 and DW 8 (mask for checking).

**Bit 6=0:** Scan and load/unload dialogs in parallel

Both types of dialog are permissible. However, it is necessary to note that in this case an overall or individual magazine scan can only ever give a momentary picture of magazine assignment.



PLC MD DW No.	Bit No.							
	7	6	5	4	3	2	1	0
<b>7005</b> <b>DR 2</b>							Tool record with P10	Signal tool all edges

PLC 1	PLC 2
PLC MD No. 6000 to 6079 7000 to 7049	PLC MD No. 6100 to 6179 7050 to 7099

**Bit 1:** With this MD you define whether P10 is contained in the record to/from the computer or external partner.

Bit 1=1: Tool record with P10

Bit 1=0: Tool record with P10

**Bit 0:** The function "signal tool" is performed depending on MD bit as a single message frame or dialog.

Bit 0=1: All edges of a tool are signalled. (dialog)

Bit 0=0: Only the 1st edge of a tool is signalled. (single message)

### 9.4.3.4 PLC MD bits for user (DB65)

PLC MD DW No.	Bit No.							
	7	6	5	4	3	2	1	0
<b>8000 to 8049</b>			6	5	4	3	2	1
<b>8050 to 8099</b>								

PLC 1	PLC 2
PLC MD No. 8000 to 8049	PLC MD No. 8050 to 8099

In addition to the PLC MD words, the PLC MD bits are also available to the user. This bit area covers 25 words (400 bits).

The machine manufacturer can process program blocks, function blocks or parts of his program depending on the bits set and assign machine-specific option bits with the PLC machine data. The user can also assign machine-specific values using these values.

#### Application example:

A user constructs machines with different turrets. But the user would like to supply the same program for all machines. The turrets differ in the number of tool locations, e.g. turret 1 has 6 tool locations, turret 2 has 8 locations.

The program for every type of turret (here program block) is called via the corresponding PLC machine data bit. The number of locations is predefined in the program via the PLC MD words.

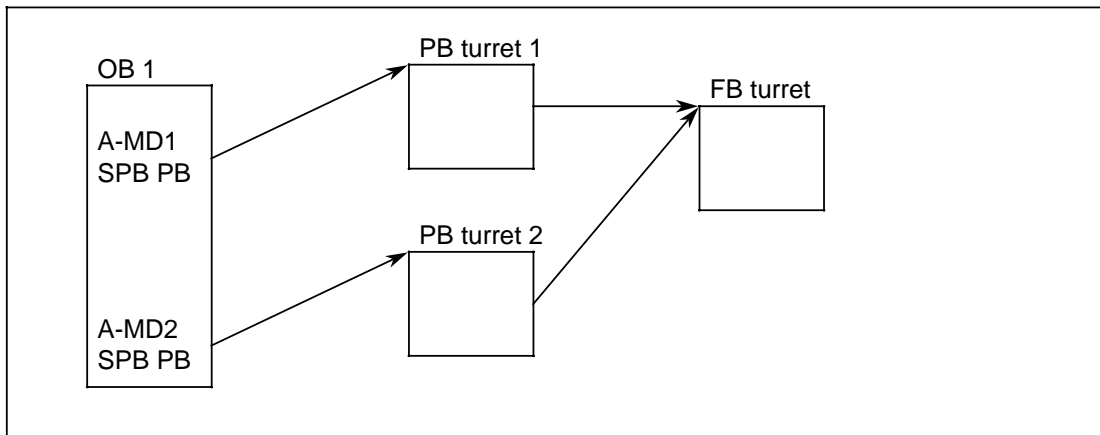

## 9.5 NC machine data and IAR machine data when using integrated drive control

Select IAR MD

**Menu after "DIAGNOSTICS" softkey has been selected**

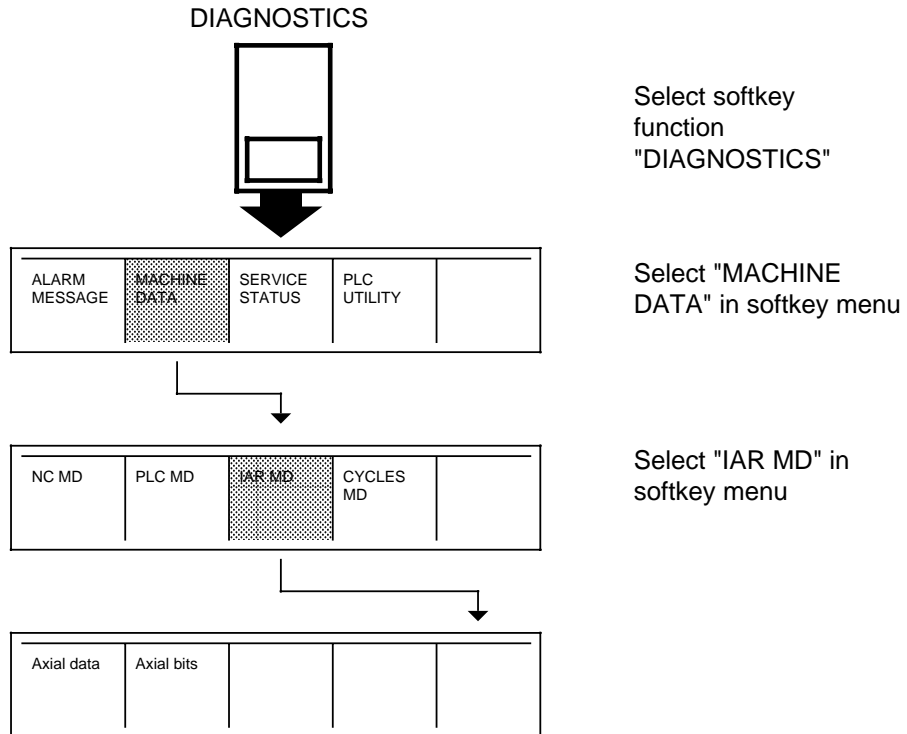

### 9.5.1 New or modified NC machine data (from Software Version 5 using IAR)

NC MD	Designation	Standard value	Maximum input value	Reference system	Input unit
160 - 163	Sampling ratio interpolation to speed control	See explanation	16000	-	1000 units/min
168	Sampling time system clock	0	16	-	-
200*	Axis assignment indirect measuring system	See poss. values	10030400	-	-
264*	Threshold for drive errors	12 000	500000	IS	1000 units/min
268*	Maximum setpoint speed	10 000	500000	IS	1000 units/min
280*	Maximum velocity	10 000	500000	IS	1000 units/min
364*	Pulses variable incremental weighting indirect measuring system	1	16000	-	-
368*	Traversing path variable incremental weighting indirect measuring system	1	16000	-	-
384*	Assignment setpoint output	0	10030000	-	-
396*	Absolute offset	0	± 99999999	IS	units
1116*	Pulse multiplication indirect measuring system	0	32	-	-

### 9.5.2 New or modified NC machine data bits (from Software Version 5 using IAR)

New NC machine data bits								
MD No.	Bit No.							
	7	6	5	4	3	2	1	0
<b>564*</b>						Change of sign indirect measuring system	Change of sign setpoint	
<b>1808*</b>					Absolute offset valid	Absolute encoder opposed to machine system	Absolute encoder as direct measuring system	SIPOS absolute encoder available

### 9.5.3 New IAR machine data (from Software Version 5 using IAR)

IAR MD	Designation	Standard value	Maximum input value	Reference system	Input unit
100*	Axis assignment direct measuring system	See poss. values	10030000	-	-
108*	Sampling ratio position to speed control	2	3	-	-
116*	Pulse multiplication direct measuring system	32	32	-	-
120*	Current amount for friction feedforward control	0	500	-	1/10 %
124*	Number of encoder grid lines of actual speed value measuring system	250	16000	-	Number of grid lines x 10
128*	Pulses variable incremental weighting direct measuring system	1	16000	-	-
132*	Traversing path incremental weighting direct measuring system	1	16000	-	-
136*	Rated motor speed	0	16000	-	rev/min
140*	Current controller gain	0	16	-	-
144*	Winding inductance	0	50000	-	uH
148*	Maximum permissible motor current (peak current)	0	16000	-	0.1 A
152*	Monitoring time speed controller at stop	200	1000	-	ms

IAR MD	Designation	Standard value	Maximum input value	Reference system	Input unit
156*	Cutout delay controller enable	200	1000	-	ms
176*	Current limit	100	100	-	%
196*	Traversing range with self-installation	0	99999999	MS	units
204*	Maximum current for identification	50	100	-	%
208*	Maximaldrehzahl für Identification	100	100	-	%
208*	Maximum speed for identification	100	100	-	%
212*	Weight compensation (load moment compensation)	0	100	-	%
216*	Time constant actual speed value filter	0	10000	-	$\mu$ s
220*	Startpoint of adaptation	0	200	-	1/10 ‰ of rated speed
224*	Endpoint of adaptation	0	200	-	1/10 ‰ of rated speed
228*	Adaptation action P gain	100	200	-	% of rated value
232*	Adaptation action integral-action time	100	200	-	% of rated value
236*	Controller dynamic response	100	200	-	%
240*	Observer dynamic response	10	100	-	-
244*	Adaptation of speed controller gain	0	100	-	%
248*	Adaptation of speed controller integral-action time	100	100	-	%
252*	Weighting feedback factor differential speed $K_{DN}$	0	16000	-	-
256*	Weighting feedback factor spring moment $K_{FM}$	0	16000	-	-
260*	Time constant smoothing of setpoint signal	0	10000	-	10 $\mu$ s
264*	Ramp-up time $T_M$ (motor+load)	100	16000	-	ms
268*	Actuator time constant $T_{Sigma}$	120	16000	-	10 $\mu$ s

### 9.5.4 New IAR machine data bits (from Software Version 5 using IAR)

New IAR machine data bits								
MD No.	Bit No.							
	7	6	5	4	3	2	1	0
500*			Direct/in-direct act. pos. value measurem.					Smoothing of setpoint signal
504*	Assignm. leadscrew err. comp./backlash compens.			Change of sign direct measuring system			Direct measuring system available	Friction feedforward control
508*	Position controller optimization						PI Speed controller	Controller enable/follow-up operation
512*							Installation data (Service)	ACC Monitoring
516*		Scale factor KO function	Scale factor KO function	Axis in PLC 5	Axis in PLC 4	Axis in PLC 3	Axis in PLC 2	Axis in PLC 1



## 9.6 Cycle machine data (Cycle MD)

When working with subroutines and cycles, not only are variable values (R parameters) required for calculations but also fixed values or values which are stored in safe memories. For this purpose, from Software Version 3, cycle MD and cycle SD were introduced (see Section 9.7).

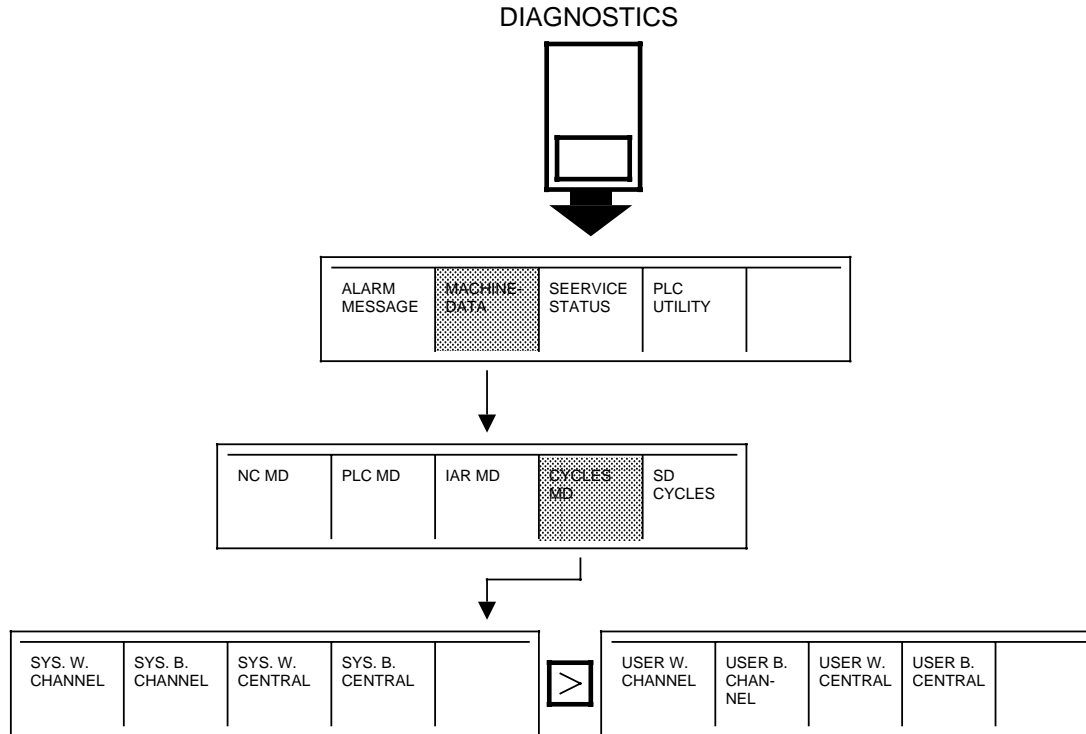

SYS.-W.	System words
SYS. B.	System bits
User W.	User words
User B.	User bits
Channel	Channel-specific
Central	Central (for all channels together)

The cycle MD are divided into two areas as follows (systems areas Siemens and user area).

Channel-specific cycle MD:

0 49	Words system (Siemens)
400 449	Words user
800 849	Bits system (Siemens)
900 949	Bits user

Central cycle MD:

1000 1149	Words system (Siemens)
4000 4149	Words user
7000 7049	Bits system (Siemens)
8000 8049	Bits user

The channel-specific cycle MDs are deleted in installation mode with the softkey "clear cycle MD". A standard setting for cycle MD does not exist. Before input of cycle MDs on the NC operator panel the password .... must be entered.

The system cycle MD (words and bits) are reserved exclusively by Siemens (Siemens Nuremberg). A description of the assignment can be found with the appropriate subroutines or cycles, with which the cycle MDs are used (e.g. measuring cycles version 20).

The user cycle MDs (words and bits) are for the manufacturer (or for the final user) and are therefore not assigned by Siemens (only for manufacturer-specific applications on the request of the manufacturer).

The cycle MD can only be read and written with the following CL800 commands (see also programming guide):

- @ 303 Read cycle MD Word
- @ 304 \_\_\_\_\_ " \_\_\_\_\_ Byte
- @ 305 \_\_\_\_\_ " \_\_\_\_\_ Bit
- @ 403 Write cycle MD Word
- @ 404 \_\_\_\_\_ " \_\_\_\_\_ Byte
- @ 405 \_\_\_\_\_ " \_\_\_\_\_ Bit

The cycle MD can be read by the PLC with FB 61 and written by the PLC with FB 62.

## 9.7 NC setting data (SD)

### 9.7.1 General

All setting data (SD) are active immediately (without "POWER ON"). If program execution is taking place, they are active in the next block if they were modified with G functions. The general SD bits and the SD bits for the serial interfaces can also be modified in the "OVERALL RESET" installation mode:

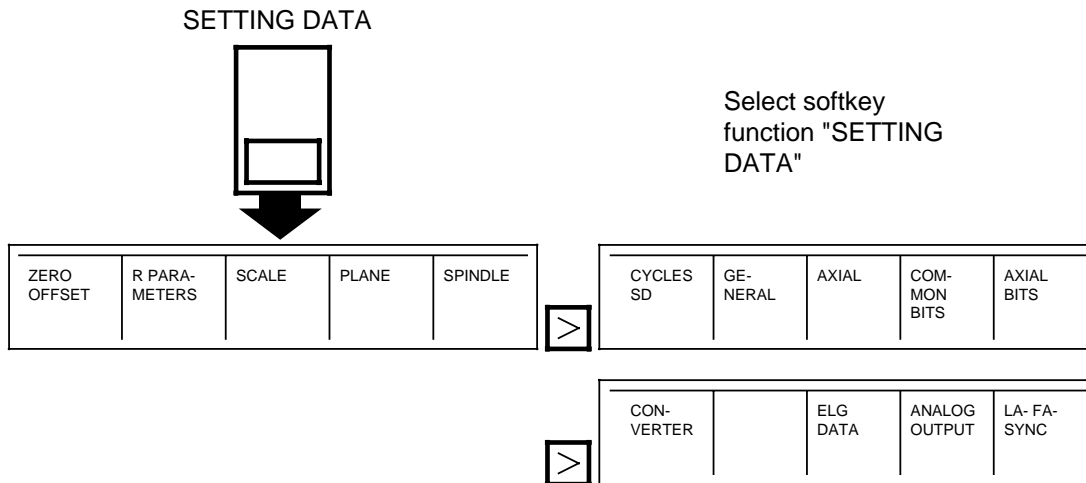

### 9.7.2 Zero offsets (ZO)

G54	1st additive zero offset	(coarse + fine)
G55	2nd additive zero offset	(coarse + fine)
G56	3rd additive zero offset	(coarse + fine)
G57	4th additive zero offset	(coarse + fine)

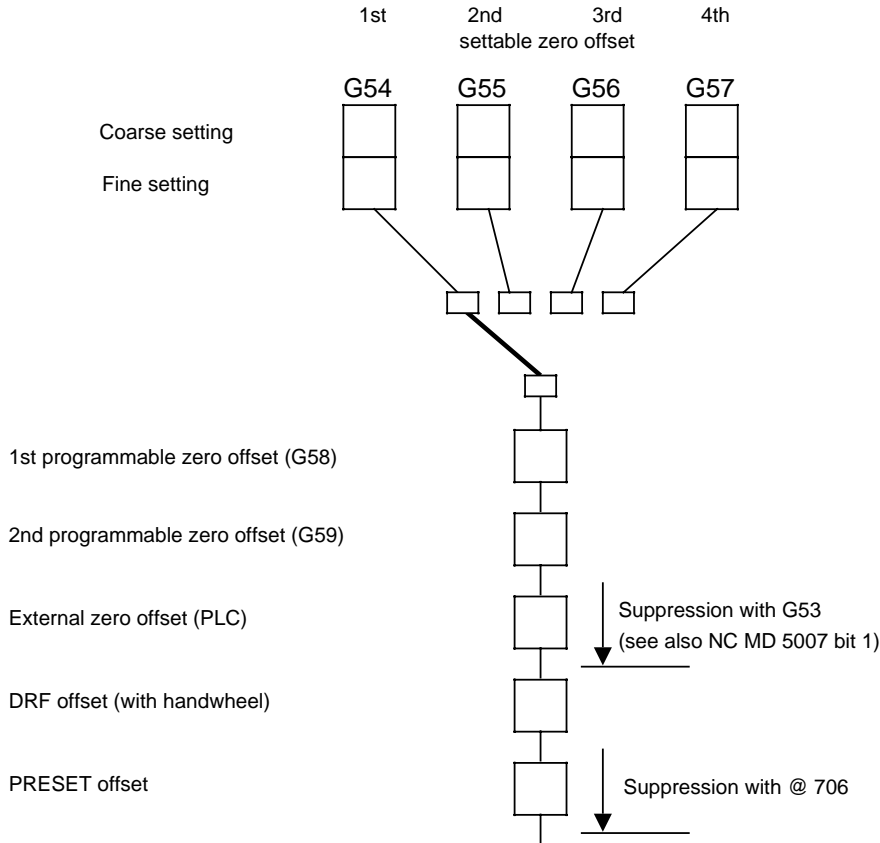

The **initial setting** for programming is **G54 !**

G58	1st programmable ZO
G59	2nd programmable ZO
External ZO	External ZO from PLC

The values are transmitted from the PLC via external data input. They may only be deleted with the PLC or using the "USER MEMORY FORMAT" softkey.

### 9.7.3 R parameters

The overall system has (according to the catalog) 200 parameters per channel and 100 central parameters:  
Parameters R0 to R499 are channel-specific,  
Parameters R900 to R999 are valid for all channels.

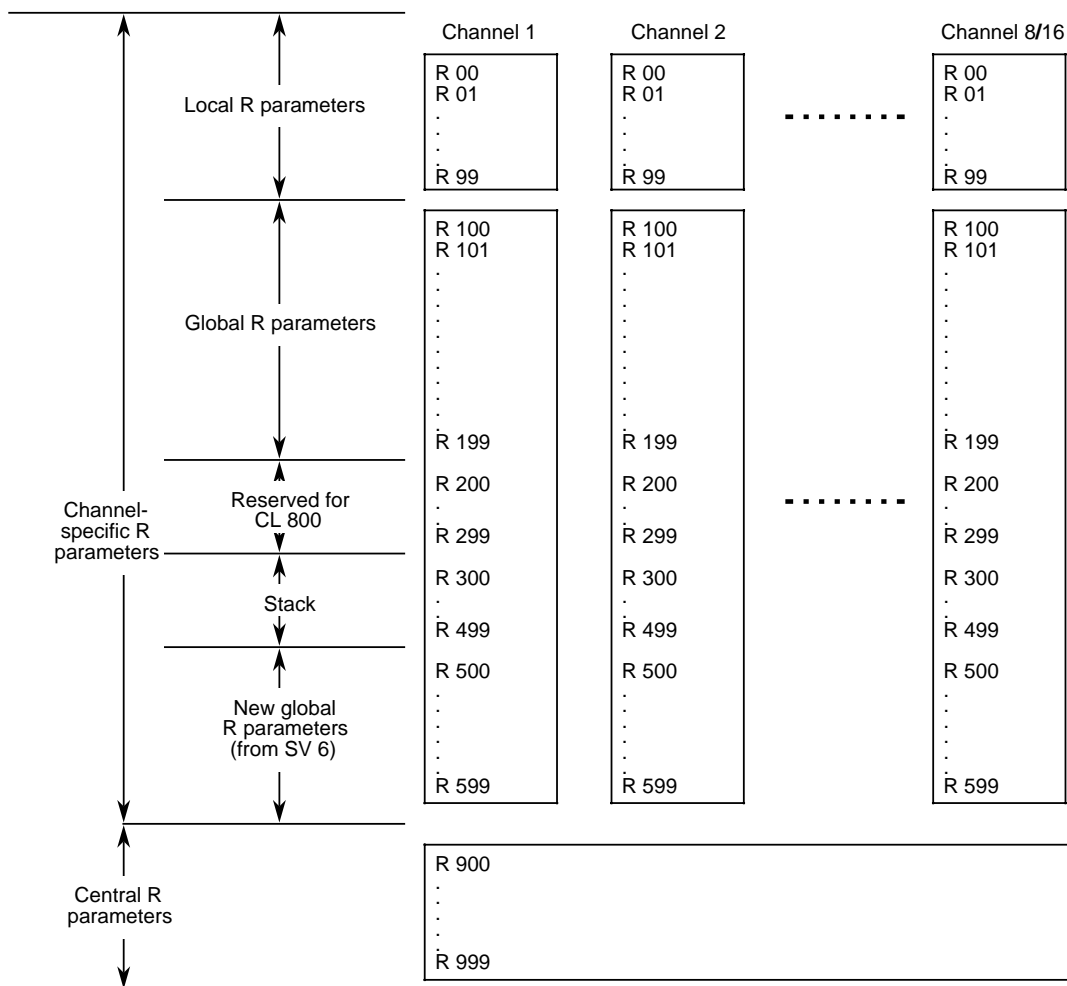

#### R parameters assignment

R0 – R49: **Typical application per channel:**

Input of cycles and subroutines.

R50 – R99: **Typical application per channel:**

For calculations within cycles and subroutines. The same local parameters may be used for nested subroutines. When cycles or subroutines are called with @ 040 ... 043, an R parameter stack saves the data used so far and stores them after return to the calling program.

- R100 – R199: **Typical application per channel:**  
Memory for data which must be accessible for the main programs and subroutines. R100 - R109 are assigned if Siemens tool management is used. From Software Version 3 R110-R199 are free for the user. Up to Software Version 2. R110 - R199 were assigned when Siemens measuring cycles are used.
- R200 – R219: Siemens assignment (cycle converter)  
R220 – R239: WS800 compiler (Siemens assignment)  
R240 – R299: Still unassigned; assigned internally by Siemens as required !  
R300: Stack pointer for @ 040, @ 041, @ 042, @ 043 (set to 301 with each M2, M30 RESET)  
R301 – R499: Stack area for @ 040, @ 041, @ 042, @ 043  
R500 – R599: (from Software Version 6) 100 new global R parameters per channel  
Use: as for R100 - R199
- R900 – R999: **Typical application:**  
Higher-level memory for all NC channels, e.g. for buffering target positions used by another channel.

## 9.7.4 Spindle setting data

- **Programmed spindle speed limitation (G92)**

Using programmed spindle speed limitation, in addition to fixed spindle speed limitation, the spindle speed can be reduced in the program with G function G92. Programmed spindle speed limitation is only active at constant cutting speed (G96).

**Example:**

```
%7  
N10 ... LF  
N20 G92 S3000 LF  
N25 G96 S100 LF  
N30 M30 LF
```

Positioning to this angle (in degrees) is performed with M19 programmed.

- **Oriented spindle stop (M19)**

Auf diesen Winkel (in Grad) wird bei programmiertem M19 positioniert.

**Example:**

- With M19 S270 LF the spindle is positioned at 270° and the angle entered.
- With M19 LF the spindle is positioned at the angle entered in the SD.

- **Spindle speed limitation**

With spindle speed limitation, the spindle is limited to the entered speed. Spindle speed limitation can be modified in the program by means of G26 S ...

### 9.7.5 Setting data for the synchronous mode

<b>14/ 24/34</b>	<b>Speed ratio for following spindles 1/2/3 numerator</b>			<b>14/ 24/34</b>
Standard value	Lower input limit	Upper input limit	Units	
<b>0</b>	<b>see Input format</b>	<b>see Input format</b>	<b>—</b>	

<b>15/ 25/35</b>	<b>Speed ratio for following spindles 1/2/3 denominator</b>			<b>15/ 25/35</b>
Standard value	Lower input limit	Upper input limit	Units	
<b>1</b>	<b>see Input format</b>	<b>see Input format</b>	<b>—</b>	

The linear relationship between leading spindle and following spindle is determined by the speed ratio ( $K_{ij}$ ) which is issued in the form of two ratio parameters, a numerator and denominator. The quotient is then calculated internally to 14 decimal places.

Since the speed ratios are arranged as setting data, they can be input in three different ways:

- Manual input via the NC operator panel
- Input in CL 800 code in the part program
- Input via the PLC user program

#### Input format for the speed ratio parameters

Numerator and denominator are entered in the floating-point format with mathematical sign and up to 8 figures. Of the 8 figures, up to 7 may be after the decimal point.

When making an entry, remember that the input format is not checked. The denominator must not be zero. If calculation of the speed ratio produces a figure in excess of 1000, IS: NEW KÜ ERROR will be set and an alarm triggered.

#### Note

Entering these values does not yet change the speed ratio.

First it is necessary to calculate the ratio from the numerator and denominator, which is done by setting IS: CALCULATE NEW KÜ or the relevant setting data bit.

If the calculation of the speed ratio is successful, IS: NEW KÜ CALCULATED is set and the ratio can then be activated by setting IS: ACTIVATE NEW KÜ or the relevant setting data bit.

If an error arises during the calculation, IS: NEW KÜ ERROR will be set and an alarm triggered. The ratio cannot then be activated.

### Examples

- SD 14 = 1  
SD 15 = -1  
K<sub>ü</sub> = -1

The first pair of synchronous spindles will run in opposite directions.

- SD 24 = 3.1234567  
SD 25 = 100.12345  
K<sub>ü</sub> = 0.03119605546952



## 9.7.6 General NC setting data

- **Dry run feedrate (NC SD 0)**

If "dry run feedrate" is selected on the control, the tool path feedrate selected is the dry run feedrate (mm/min (G94)) as opposed to the programmed feedrate.

- **Smoothing constant for thread cutting (NC SD 1)**

## 9.7.7 Channel-specific NC setting data

- **Scale factor (NC SD 200\*)**

(permissible value range: 0.00001 to 99.99999)

If the scale factor is selected with G51 all axis values programmed subsequently are modified with the scale factor (for exact description see programming guide).  
The programming of the scale factor is done together with G51 in the block.

## 9.7.8 Axial NC setting data

- **Minimum / maximum working area limitation (NC-SD 300\*, 304\*)**

Working area limitation makes it possible to limit the traversing ranges in automatic and/or JOG mode (additional to software limit switches). Axis display is mode group-specific. Working area limitation can be modified in the program using G25/G26.

- **DRF offset**

DRF **D**ifferential **R**esolver **F**unction

In DRF offset the paths traversed in automatic mode with the handwheel are displayed.

- **Scale centre NC (NC SD 312\*)**

(permissible value range  $\pm$  99999.999 mm depending on input resolution)

With the scale centre you define where the reference point for the modification of the programmed axis positions by the scale factor is located (for exact description see programming guide).

Programming the scale centre is done together with G51 in the block.

- **Scale centre simulation (NC SD 316\*)**

(permissible value range  $\pm$  99999.999 mm depending on input resolution)

To make the graphic simulation possible parallel to processing (from software version 3), the program scale centre for simulation is entered in another NC SD (no coincidence with the processing NC).

### 9.7.9 Spindle-specific setting data

<b>401*</b>	<b>Programmable spindle speed limit for G96</b>		<b>401*</b>
Standard value	Lower input limit	Upper input limit	Units
<b>0</b>	<b>0</b>	<b>99 999</b>	<b>rev/min or 0.1 rev/min</b>

The programmed limit for spindle speed limits the speed of the spindle at constant cutting rate (G96). The setting data can be altered in the program by means of command G92.

#### Units

The units of the value entered depend on MD 520\*, bit 3:

Bit 3 = 0:	Unit	rev/min
Bit 3 = 1:	Unit	0.1 rev/min

#### Note

The maximum value of spindle speed is determined by the minima of the following values:

- MD 403\* to 410\* "Max. speed per gear ratio"
- MD 451\* "Max. chuck speed"
- SD 401\* Programmable spindle speed limit for G96"; programmed with G26
- SD 403\* "Programmable spindle speed limit"; programmed with G26

<b>402*</b>		<b>Spindle position for M19</b>		<b>402*</b>	
Standard value	Lower input limit	Upper input limit	Units		
<b>0</b>	<b>0</b>	<b>35 999</b>	<b>0.01°</b>		

This setting data establishes the angle to which the spindle is positioned when M19 without an S value is programmed in the part program (or MDA, overstore).

If an S value is programmed with M19 it will be accepted into the setting data.

#### Examples

- M19 S270 L<sub>F</sub> positions the spindle to 270 degrees. The angle is entered in the setting data.
- M19 L<sub>F</sub> positions the spindle to whatever angle has been entered in the setting data.

<b>403*</b>		<b>Programmable spindle speed limit</b>		<b>403*</b>	
Standard value	Lower input limit	Upper input limit	Units		
<b>100</b>	<b>0</b>	<b>99 999</b>	<b>1/min o. 0.1/min</b>		

The maximum speed of the spindle is limited to this value. The setting data can be altered in the program by means of command G26.

#### Units

The units of the values entered depend on MD 520\*, bit 3:

Bit 3 = 0:      Unit      rev/min  
 Bit 3 = 1:      Unit      0.1 rev/min

#### Note

The maximum value of the spindle speed is determined by the minima of the following values:

- MD 403\* to 410\*      "Max. speed per gear ratio"
- MD 451\*      "Max. chuck speed"
- SD 401\*      "Programmable spindle speed limit for G96"; programmed with G92
- SD 403\*      "Programmable spindle speed limit"; programmed with G26

### 9.7.10 General NC setting data

<b>5000</b>		<b>SD No.</b>					<b>5000</b>	
Bit No.								
7	6	5	4	3	2	1	0	
					Funct. expansion of UMS03 usable L95/L93	Drilling patterns L903/L930	L81 - 89 and L98	

**Bit 2,1, 0:** Effective with user memory submodule (UMS) version 03  
**Bit 2, 1, 0 = 0** Compatible with UMS 02

<b>5001</b>		<b>SD No.</b>					<b>5001</b>	
Bit No.								
7	6	5	4	3	2	1	0	
Addition Channel 3 to Channel 4	Addition Channel 1 to Channel 2						Display workpiece- oriented actual	

**Bit 0:** The actual value display for axes (actual position) refers to the workpiece zero point and not to the machine zero point (reference point).

### 9.7.11 Setting data bits for the synchronous mode

SD No.	Bit No.							
	7	6	5	4	3	2	1	0
FS1: 5004 FS2: 5006 FS3: 5008	Calculate new speed ratio (K <sub>ü</sub> )	Acceleration limit, synchronous	Enable emergency retraction	Compensatory controller On		FS overlay On		FS in synchronous mode

**Bit 7:** If this bit is **set**, the speed ratio between leading spindle and following spindle is calculated again.

If the ratio has been calculated without error, IS: NEW KÜ CALCULATED will be set. The setting data bit is cancelled again automatically and the ratio can then be activated.

If an error has arisen in the calculation of the ratio, IS: NEW KÜ ERROR will be set and an alarm triggered. The ratio cannot then be activated.

The calculation can also be initiated by an interface signal of the same name.

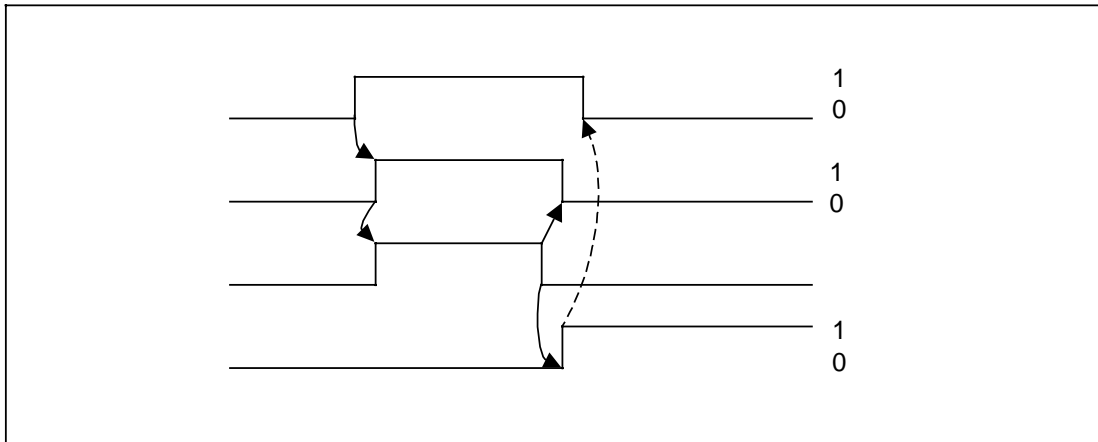

Fig. 9.7 Signal chart for calculating a new speed ratio

- 1: IS: CALCULATE NEW KÜ
- 2: SD bit "Calculate new speed ratio (K<sub>ü</sub>)"
- 3: Calculation of the new speed ratio
- 4: IS: NEW KÜ CALCULATED
- 5: Setting and resetting of the signal by the PLC user program

**Bit 6:** During the acceleration phases when starting and changing the linkage, the following spindle follows the motions of the leading spindle according to its maximum acceleration.

If this bit is **not set**, any increments which cannot be output during the acceleration phase due to the limiting will be lost.

This means that, at the end of the acceleration phase, the two spindles will no longer be in positional synchronism and the synchronism error between leading spindle and following spindle will therefore increase. In normal operation the setpoints are limited so that the maximum acceleration of the following spindle is not exceeded.

this bit is **set**, the lost increments will be performed by the following spindle at the end of the acceleration phase.

This means that the two spindles will be in positional synchronism again at the end of the acceleration phase.

**Note**

The bit should always be set.

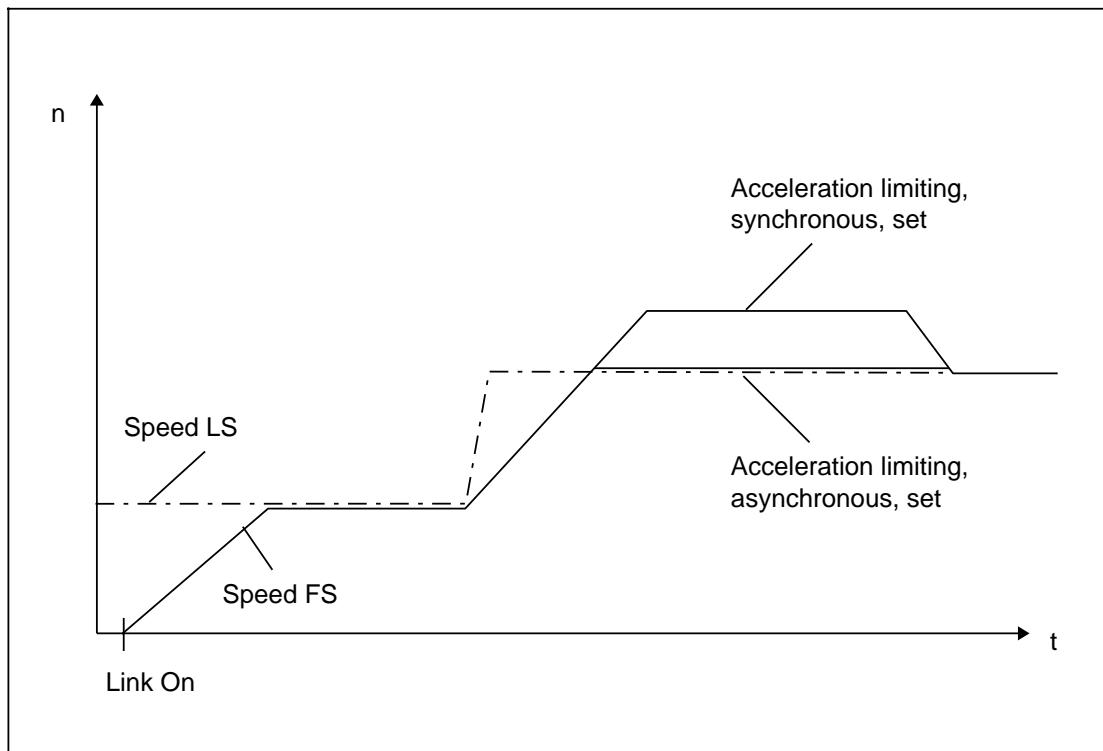

Example

**Bit 5:** If this bit is **not set**, there will be no emergency retraction monitoring.

If this bit is **set**, the position difference between leading spindle and following spindle in the synchronous mode will be continuously compared with the value "Emergency retraction threshold" (MD 954/974/994). If the threshold is exceeded, IS: EMERGENCY RETRACTION ACTIVE and the hardware signal "Emergency retraction" are set and an alarm triggered. The hardware signal is only available when the mixed input/output module is being used in the servo area.

The PLC user program can then initiate measures for aborting the linkage.

**Bit 4:** If this bit is **set**, the compensatory controller is activated in the synchronous mode.

The compensatory controller allows the synchronism to be improved (also under disturbance conditions).

The following spindle must be stationary when the compensatory controller is activated.

**Bit 2:** If this bit is **set**, the following spindle can be issued with traversing motions of its own in addition to the motions of the leading spindle. This is required for the synchronous mode with a defined value of angular offset.

**Bit 0:** If this bit is **set**, the relevant following spindle will be in the synchronous mode (linkage active).

If the bit is **not set**, the following spindle can be operated as a normal spindle.

The bit is for display only; changing it has no effect.

SD No.	Bit No.							
	7	6	5	4	3	2	1	0
FS1: 5005 FS2: 5007 FS3: 5009	Activate new $K_{ij}$							

**Bit 7:** If this bit is **set**, the newly calculated value of speed ratio between leading spindle and following spindle will be active, i.e. it will be taken into account when calculating the setpoints for the following spindle.

The bit is reset automatically after the speed ratio has been activated.

The speed ratio can only be activated if it has been calculated beforehand without error.

The speed ratio can also be activated by an interface signal of the same name.

### 9.7.12 NC setting data bits for serial interfaces

(See Planning Guide Universal Interface 800 for a detailed description)

SD No.	Bit No.							
	7	6	5	4	3	2	1	0
<b>5010</b> <b>5030</b>	Device identifier for "read-in" in 1st/3rd V.24 (RS232C)							
<b>5011</b> <b>5031</b>	Number of stop bits		Odd parity	With parity			Baud rate	
<b>5012</b> <b>5032</b>	Device identifier for "read-out" in 1st/3rd V.24 (RS232C)							
<b>5013</b> <b>5033</b>	Number of stop bits		Odd parity	With parity			Baud rate	
<b>5014</b> <b>5034</b>	X <sub>ON</sub> start character 1st/ 3rd V.24 (RS232C) (value e.g. 11 <sub>H</sub> )							
<b>5015</b> <b>5035</b>	X <sub>OFF</sub> start character 1st/3rd V.24 (RS232C) (value e.g. 13 <sub>H</sub> )							
<b>5016</b> <b>5036</b>	Start without X <sub>ON</sub>	Program start with LF	Block end with CR LF	Output in EIA code	Stop with end of transfer character	Analyse readiness	No leader and trailer	Read-in program from System 3/8
<b>5017</b> <b>5037</b>	Special bits 1st/3rd V 24 (RS232C)					From SV6 output of MDS not equal to zero	Cancel program with REORG	Time watchdog OFF
<b>5018</b> <b>5033</b>	Device identifier for "read-in" in 2nd/4th V.24 (RS232C)							
<b>5019</b> <b>5039</b>	Number of stop bits		Odd parity	With parity			Baud rate	



SD No.	Bit No.								
	7	6	5	4	3	2	1	0	
<b>5020</b> <b>5040</b>									Device identifier for "read-in" in 2nd/4th V.24 (RS232C)
<b>5021</b> <b>5041</b>	Number of stop bits		Odd parity	With parity				Baud rate	Transfer format for "read-out" from 2nd/4th V.24 (RS232C)
<b>5022</b> <b>5042</b>									X <sub>ON</sub> start character 2nd/ 4th V 24 (RS232C) (value e.g. 11 <sub>H</sub> )
<b>5023</b> <b>5043</b>									X <sub>OFF</sub> start character 2nd/4th V 24 (RS232C) (value e.g. 13 <sub>H</sub> )
<b>5024</b> <b>5044</b>	Start with-out X <sub>ON</sub>	Program start with LF	Block end with CR LF	Output in EIA code	Stop with end of transfer character	Analyse readiness	No leader and trailer	Read-in progr. from System 3/8	Special bits 2nd/4th V 24 (RS232C)
<b>5025</b> <b>5045</b>						From SV6 output of MDs not equal to zero	Cancel program without REORG	Time watchdog OFF	Special bits 2nd/4th V 24 (RS232C)
<b>5026</b> <b>5046</b>									EIA code for "@" (value e.g. 6D <sub>H</sub> )
<b>5027</b> <b>5047</b>									EIA code for ":" (value e.g. 46D <sub>H</sub> )
<b>5028</b> <b>5048</b>									End of transfer character (value e.g. 03 <sub>H</sub> )
<b>5029</b> <b>5049</b>									EIA code for "." (value e.g. 7D <sub>H</sub> )

SD No.	Bit No.								
	7	6	5	4	3	2	1	0	
<b>5050</b>									EIA code for "[ " 1st/2nd V24 (from Software Version 4)
<b>5051</b>									EIA code for "]" 1st/2nd V24 (from Software Version 4)
<b>5052</b>									EIA code for "," 1st/2nd V24 (from Software Version 4)
<b>5060</b>									EIA code for "[ " 3rd./4th V24 (from Software Version 4)
<b>5061</b>									EIA code for "]" 3rd./4th V24 (from Software Version 4)
<b>5062</b>									EIA code for "," 3rd./4th V24 (from Software Version 4)

Setting data 1./3. V24 Setting data 2./4. V24	5010/30 5018/38	5011/31 5019/39	5012/32 5020/40	5013/33 5021/41	5014/34 5022/24	5015/35 5023/43	5016/36 5024/44
Device	Relevant bit pattern						
PG675 m. CP/M86 1200 Baud	0000 0000	1100 0100	0000 0000	1100 0100	xxxx xxxx	xxxx xxxx	xx1x 1xxx
GNT reader (Opt. B02/B03)	0000 0000	1100 0111	xxxx xxxx	xxxx xxxx	xxxx xxxx	xxxx xxxx	0000 0000
Fanuc hand-held reader	0000 0001	1100 0110	xxxx xxxx	xxxx xxxx	0001 0001	1001 0011	0000 0000
PT80 300 Baud	0000 0000	1100 0010	0000 0000	1100 0010	xxxx xxxx	xxxx xxxx	0000 0000
PT88 9600 Baud V.24	xxxx xxxx	xxxx xxxx	0000 0000	1100 0111	xxxx xxxx	xxxx xxxx	0000 0000
WS 800	0000 0000	1100 0111	0000 0000	1100 0111	xxxx xxxx	xxxx xxxx	xx1x 1xxx
RG 675/685 with Step 5 and 9600 Baud (only 3rd interface)	0000 0100	xxxx x111	xxxx xxxx	xxxx xxxx	xxxx xxxx	xxxx xxxx	xxxx xxxx

x ..... irrelevant

Baud rate setting	
Bit pattern Bits 3 to 0	Baud rate
0000	110 Baud
0001	150 Baud
0010	300 Baud
0011	600 Baud
0100	1200 Baud
0101	2400 Baud
0110	4800 Baud
0111	9600 Baud

Device identifiers	
Bit pattern	Device type
0000 0000 . .	Line controlled devices (RTS line)
0000 0001 . .	X <sub>ON</sub> /X <sub>OFF</sub> controlled devices
0000 0010 . .	
0000 0011 . .	SIEMENS programming workstation PD...PG
0000 0100 . .	PG 675/685 with STEP 5

In the case of the SINUMERIK 880, four interfaces are available, allowing data transfer with external devices.

#### Interfaces:

Interface 1	OP CPU	6FX1 120-4	X121 (Standard)
Interface 2	OP CPU	6FX1 120-4	X131 (Option)
Interface 3	COM CPU	6FX1 120-4	X121 (Standard)
Interface 4	COM CPU	6FX1 120-4	X131 (Option)

The four interfaces are combined in three groups. In each case two interfaces from different groups may be operated simultaneously. The interfaces in any one group are mutually exclusive.

**Groups:**

- Group 1      Interfaces 1 + 2
- Group 2      Interfaces 3 + 4

The simultaneous inputting of different data types does not have any interference effect. The following applies when the same data types are input simultaneously:

In the case of part programs, all of the first program to have been started is stored in the memory. The other interfaces wait with their programs and are continued in succession. In the process, an interface may possibly be stopped for longer than the internal timer (1 min). Consequently, the timer can be switched off by means of the setting data.

If the other data types (e.g. machine data, TO, ZO etc.) are input simultaneously, the last value to have been entered is held in the memory.

**9.7.13 Channel-specific NC setting bits**

<b>540*</b>		<b>SD No.</b>						<b>540*</b>	
								Bit No.	
7	6	5	4	3	2	1	0		
						Spindle converter (from Software Version 4)	Axis converter activated (from Soft- ware Version 4)		

**Bit 1:**    Can only be activated via PLC.

**Bit 0:**    The axis converter is used to convert the names of axes during processing without having to make other changes in the part program. Thus the axes X and Z may be programmed in the part program but axes X1 and Z1 processed.  
 The axis converter does **not** work for:

- Radius and chamfer
- Angle
- Spindle

## 9.7.14 Axial NC setting data bits

560*		SD No.						560*	
Bit No.									
7	6	5	4	3	2	1	0		
				Scale factor active in simulation (from Software Version 3)	Scale factor active in machining (from Software Version 3)	Rapid traverse override not active	Feedrate override not active		

- Bit 3** The scale factor (G51) is active in the simulation  
**Bit 2** The scale factor (G51) is active for machining (channels 1 to 16)  
**Bit 1** Override switch no longer effective on rapid traverse in the relevant axis  
**Bit 0** Override switch no longer effective on feedrate in the relevant axis

## 9.8 Cycle setting (cycle SD)

Cycle SDs are used, as are cycle MDs (see Section 9.5), to store values in a safe memory.

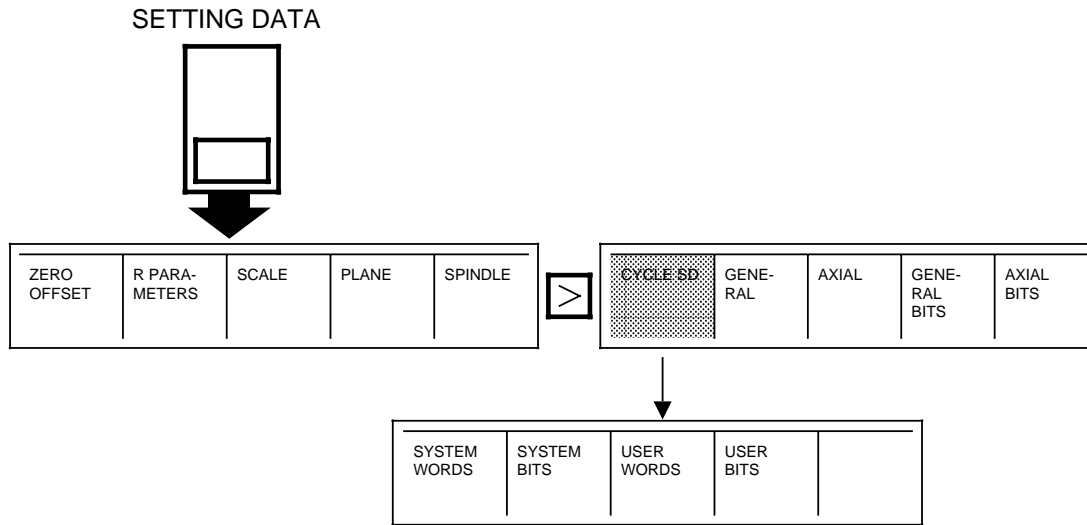

Cycle SDs are available separately for every channel (channel-specific). The cycle SDs are divided into two areas as follows (system are Siemens and user area).

Channel specific cycle MD:

0 ⋮ 99	Words Siemens
400 ⋮ 499	Words user
800 ⋮ 849	Bits Siemens
900 ⋮ 949	Bits user

The cycle SDs are deleted in installation mode with the softkey "FORMAT USER M". The input or modification of cycle SDs on the NC operator panel can be disabled with the key switch (NC MD 5051 Bit 0).

The cycle SDs reserved for Siemens are assigned exclusively by Siemens Nuremberg (Moorenbrunn).

The cycle SDs can be read and written with the following CL800 comands (see also programming guide):

@ 313	Read cycle SDs	Word
@ 314	_____ " _____	Byte
@ 315	_____ " _____	Bit
@ 413	Write cycle SDs	Word
@ 414	_____ " _____	Byte
@ 415	_____ " _____	Bit

The cycle SDs can be read by the PLC with FB61 and written by the PLC with FB 62.

# 10 Machine Operation/Service Data

## 10.1 Jog mode

### **Preconditions:**

- All axis setpoint cables plugged in
- Correct control direction
- Position control loops closed
- Correct gains

The alarms below may prevent the axes from being traversed:

Alarm No.	Explanation
<b>2000</b>	"EMERGENCY STOP"
<b>148*</b> <b>152*</b> <b>188*</b> <b>192*</b>	Hardware or software limit switch approached  Hardware: <ul style="list-style-type: none"> <li>• Test using interface test</li> <li>• Software limit switches reached (only after reference point approach). Limits via NC MD machine data 224*, 228*, 232*, 236*</li> </ul>
<b>168*</b>	Servo enable for a moving axis cancelled by interface unit
<b>156*</b>	Set speed too high. Activated via NC MD machine data 264*
<b>112*</b>	Clamping error Axis not in position. Activated via NC MD machine data 212*
<b>116*</b>	Contour monitoring (initiation via NC MD 332*, 336*)
<b>132*</b> <b>136*</b> <b>140*</b> <b>144*</b>	Hardware measuring-circuit monitoring Measuring-circuit signal monitor has responded for axes or spindle (can only be cleared via hardware reset)

In addition, the following signals are required for jog mode:  
(no alarms activated)

- Feed enable X, Y, Z, 4 - 24
  - Feed enable, overall
  - No axis inhibit X, Y, Z, 4 - 24
  - Servo enable X, Y, Z, 4 - 24
  - No follow-up mode X, Y, Z, 4 - 24
- } Interface test

\* = Axis 1-24



Should there be no feed and servo enable signals, the "Feed Hold" LED lights up after the direction key has been actuated. The following signals must not be present if traversing is to be performed at the input speed influenced by the feedrate or rapid traverse override switch:

- F external (feedrate from PLC)
- Feedrate reduction ratio 1:100
- Testing of all jog functions:
  - Limit switches
  - External deceleration (rapid traverse reduction)
  - Feedrate reduction ratio
  - Incremental feed
  - Reference point approach

## 10.2 Programmed operation

In this case only the principal function is to be tested so that programs can be used as an aid to optimization.

The following interface signals are additionally required:

- Read-in enable (DL 7 to DR 10)
- NC START=1 / NC STOP=0 (DR 2)
- Disable of NC START (DW 11)
- NC MD 106\*
- Reference point not approached or NC MD 5004 Bit 3
- NC MD 548\*, 550\*, 552\*
- NC START inactive (DL 16)

Check whether the axes can traverse via the program memory.

## 10.3 Functional test with NC test tape

For testing the following functions:

- Block display
- Zero offset
- Interpolation
- Transfer (overstore)
- Tool offsets
- All auxiliary functions (M, S, T, D, H)
- Thread cutting
- Single block, deletable blocks, program stop
- Program end
- Subroutines and R parameters
- Program patching
- Program memory operation
- Blanking of programs
- Simultaneous reading-in of programs during processing.

The program and tape are to be provided by the machine manufacturer.

## 10.4 Axis and spindle service data

For drive optimization and fault diagnosis, it must be possible to view the data transmitted from the NC to the axes or spindles and from the axes or spindles to the NC.

### 10.4.1 Axis service data

The following service data for axes are displayed:

- Following error in units (MS)  
Difference between setpoint and absolute actual position.
- Absolute actual position in units (MS)  
Actual position of axes at machine.
- Setpoint (command value) in units (MS)  
Specified value determined by the controller on the basis of the program or set position entered manually. The setpoint and absolute actual position are usually identical (at rest the difference can be offset by the drift compensation).
- Set speed in VELO  
Digital value determined by the controller (for maximum value see NC MD 268\*). It is converted at the measuring-circuit module to an analog value (0 V to 10 V) and output as a setpoint (command value) to the drive.
- Actual part position in units (MS)  
Pulses from measuring system per scanning cycle (standard 2.5/5/10 ms).
- Set part position in units (MS)  
Set part position values output by the interpolator to the position control per IPO cycle (standard 20 ms).
- Contour control in units (MS)  
This value is used to indicate the current contour deviation (fluctuations in the following error due to compensating operations at the speed controller as a result of load changes).

#### **Caution!**

Service values are displayed at twice the value, i.e. in units (MS) of position control resolution (e.g. a following error display of 2000 with position control resolution of 0.5  $\mu\text{m}$  is equivalent to an actual following error of 1 mm).

**Selection of axis service data**

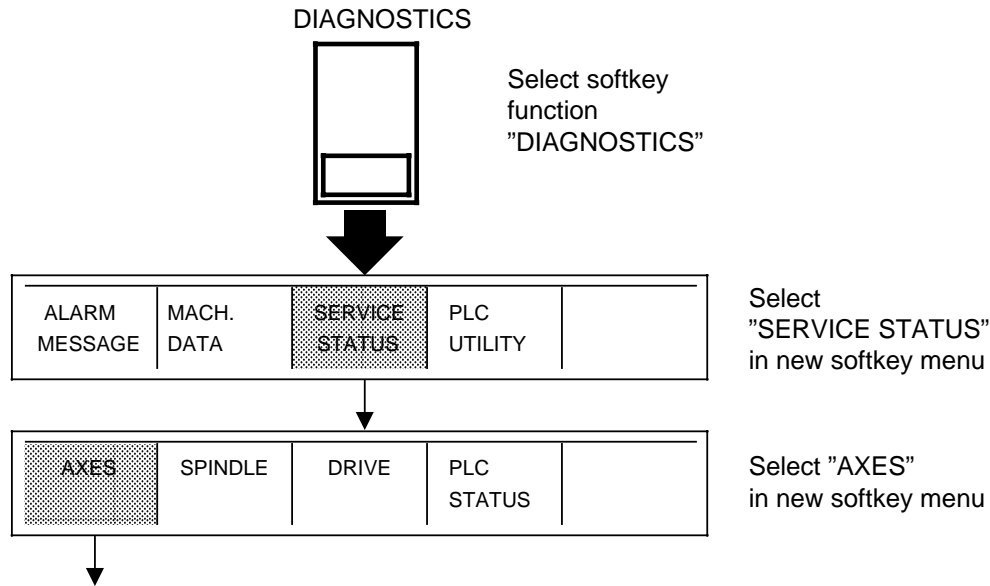

When the softkey is depressed, the above-mentioned axis-specific values are displayed:

Display: Axis 1            1st axis  
 Display: Axis 2            2nd axis  
 .  
 .  
 .  
 Display: Axis 24          24th axis

- The "Page forwards" key makes it possible to page to the next axes.
- Entering "8" and actuating the search key makes it possible, for example, to select axis 8 directly.
- The "Page backwards" key makes it possible to page back to the next axes if necessary.

**10.4.2 Spindle service data**

For optimization and fault diagnostics purposes, it is possible to view the current spindle values.

- Set speed (VELO):  
 Digital value determined by the NC on the basis of the programming.
- Set speed (rev/min):  
 Value input by the user;  
 e.g.: Input S = 1000      Display: set speed 1000 (rev/min)
- Actual speed (rev/min):  
 The pulses from the spindle encoder are evaluated by the NC and indicated as the speed in rev/min.

- **Set position:**  
The spindle position specified by the user in degrees is converted by the NC to the appropriate number of pulses;  
e. g.:  $0^\circ = 0$   
 $180^\circ = 2048$   
 $359^\circ = 4095$
- **Actual position:**  
The pulses from the spindle encoder are evaluated by the NC and displayed;  
e.g.: spindle position=  $90^\circ$  for 1024 pulses.
- **Following error:**  
Difference between the set position and the actual position. At rest the following error is a measure of the positional deviation, when M19 is active.
- **Override:**  
The position of the spindle override switch is indicated.
- **Gear:**  
The current gear is indicated. (DB 31 DR  $K_{+1}$  Bit 0 to 2).

#### **Selection of spindle service data:**

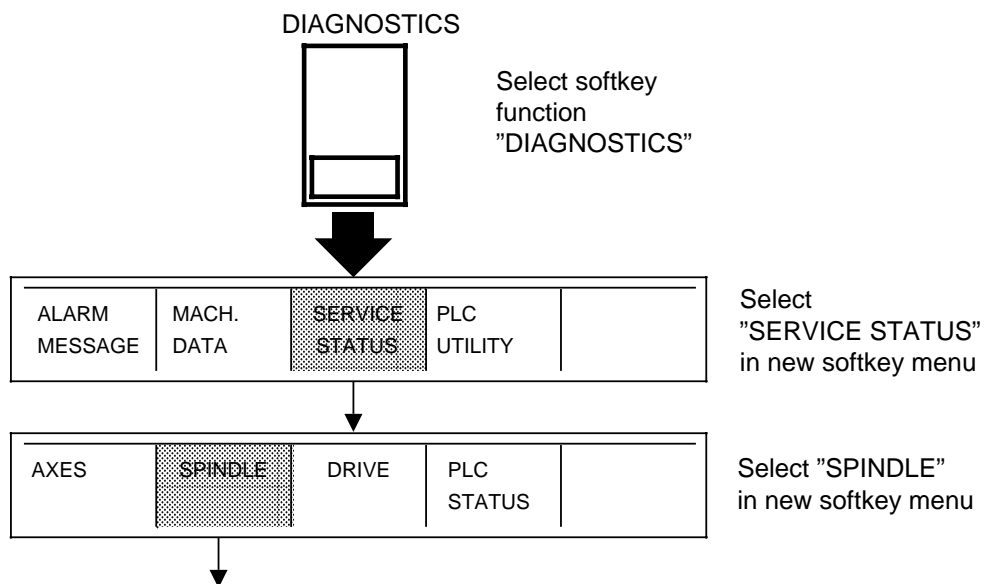

"Page forwards/backwards" or direct selection of a specific spindle (up to 6 spindles in the case of the SINUMERIK 880) as described in Section 10.4.2.

- 

The "Page forwards" key makes it possible to page to the next spindle.
- 4



Entering "4" and actuating the search key makes it possible, for example, to select spindle 4 directly.
- 

The "Page backwards" key makes it possible to page back to the next spindle if necessary.

# 11 Function Description

## 11.1 Axis movements (available soon)

## 11.2 Spindle control

### 11.2.1 Corresponding data

- MD 131 - 146 (Spindle override)
- MD 4000 - 4520 (Spindle data)
- "Analog spindle speed" option
- MD 5200 bits 0 - 7
- MD 5210 bit 1 and bit 7

### 11.2.2 S analog (M3, M4, M5)

Spindle commissioning is explained in Section 6.1.6 and is not therefore set out once more at this point.

In the case of the SINUMERIK 880, output of the analog spindle speed is fully implemented in the NC, so the PLC can only be influenced by means of special signals (see Section 11.2.4). Spindle data for up to 8 gears and additional monitoring functions are stored in the controller.

The function "Automatic gear selection" is also implemented in the NC. The "Change gear" interface signal is output by the NC as a function of the programmed S value and the "specified gear" defined on the basis of the machine data is applied to the interface. "Spindle disable" is then output to the PLC. The spindle motor decelerates to zero speed. The "PLC spindle control" and "Reciprocation speed" signals must be output by the PLC and the "Spindle disable" signal reset. The direction of rotation is switched by the PLC to facilitate engaging of the gear. Once the gear has been engaged, the PLC must report the interface signals "Change gear", "PLC spindle control", "Reset oscillation speed", "Set spindle disable" and the new "actual gear" to the spindle. After the PLC has enabled the spindle (reset spindle disable), acceleration to the new speed is performed.

Interface signals: DB31 spindle-specific signals

**Note:**

Automatic gear selection is only possible with the S analog function.

The gears (8 max.) are precisely defined by means of the minimum and maximum speeds of each gear.

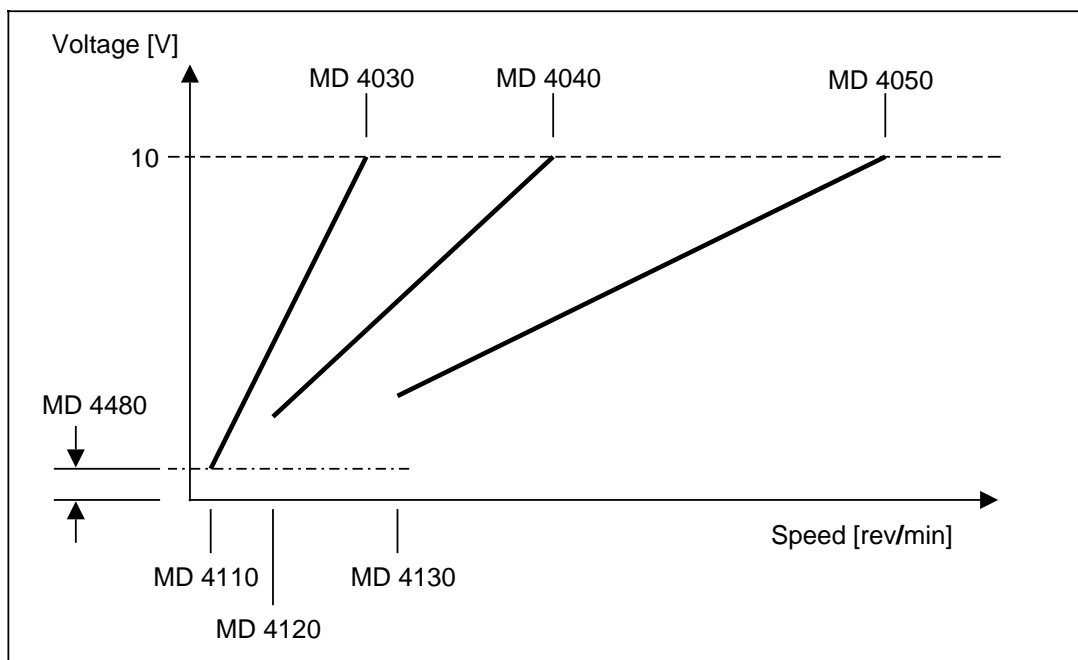

The gear is output on the basis of the lowest switching frequency, i.e. if the speeds of the individual gears overlap, a new gear is only output when the programmed S value is no longer possible in the selected gear.

In view of the fact that not all spindle drive units include a ramp-function generator, such a generator was integrated into the 880 (4 ms units). The following enable signals are required for spindle setpoint output:

DB 31 Spindle-specific signals

- $DL_{K+1}$  Bit 6 = 1 "Servo enable"
- $DL_{K+1}$  Bit 5 = 0 "Specify setpoint 0"
- $DW_{K+3}$  all bits = 0 "Spindle inhibit"
- Setting data "Spindle speed limitation"

### 11.2.3 M19 (oriented spindle stop)

The oriented spindle stop function (M19 S...LF) is intended to prevent additional external hardware requirements if the spindle is to be stopped in a specific position for a tool change or to engage gear.

A basic distinction is made with M19 between:

- NC-controlled spindle positioning
- PLC-controlled spindle positioning

The simultaneous use of both types of positioning is not possible and would give rise to controller malfunctions. In this case the ROD encoder (1024 or 512 pulses per revolution) is used not only for speed control purposes (G95) and for thread cutting (G33) but also as a position sensor, the zero mark serving as the position reference point (corresponding to 0°).

With S analog (M3, M4, M5) the spindle is controlled by the NC; only with M19 is the position control loop closed by the NC. The pulses from the ROD encoder act as actual position values. Since a ROD encoder with 1024 or 512 pulses per revolution is required as the actual-value system, a resolution of  $360^\circ/4096$  (approx. 1/11 degrees) can be achieved through four-fold hardware multiplication (only 2/11 degrees in the case of a ROD encoder with 512 pulses).

The oriented spindle stop function is activated in the part program with "M19". The target position is stored as a setting datum which can be set with manual input or "M19 S..." programming in degrees.

The positioning range is 0.1 to 359.9 degrees. Positioning is carried out in the specified direction of rotation (M3, M4) or from rest over the shortest travel.

The spindle may also be positioned using external devices if the "oriented spindle stop" option has not been set. In this case, M19 is output to the PLC as a normal auxiliary function (also a static or dynamic flag). MD 5200 bit 2 "pulse generator available" has no significance.

In the case of **NC-internal** approach, there are two sequences (**Sequence A** or **Sequence B**) on the basis of which oriented spindle stop is integrated into the block sequence of the NC program.

#### **Sequence A:**

With **sequence A** spindle stop is handled in a special part program block and a block change is not performed until the operation has terminated; axis movements at the same time as spindle positioning are not possible.

#### **Sequence B:**

With **sequence B** M19 is modal, even over a number of blocks. While the spindle is being positioned or held in position closed-loop control, the axes can be moved, the program further processed or a tool change may even be performed (NC MD 520\* bit 5).

#### **The following applies to both sequences (A and B):**

- M19 S... must be programmed in a special block without axis movements
- Orientation is performed in the specified direction of rotation (M03/M04)
- M19 is possible from rest (shortest travel)
- Oriented spindle stop is initiated at the start of the block
- M19 is aborted or terminated by means of
  - EMERGENCY STOP (Alarm 2000)
  - Reset (depending on machine data)
  - Program end (M02/M30) (depending on machine data)
  - Spindle inhibit (DB31 DW  $\kappa+3$ )
  - Measuring-circuit error in spindle or an axis
  - Errors resulting in shutdown of all axes
  - Cancelling of NC Ready 2
  - Acknowledge M19 + PLC spindle control (DB31 DW  $\kappa+2$ )
- M19 can be selected in "MDI-Auto", "Jog" or "Automatic" mode, as well as overstore (transfer)
- M19 is output as an auxiliary function at the PLC interface

#### **Special features of sequence A** (NC MD 520\* bit 5 = 0)

- A block change is only performed on completion of the M19 function (acknowledge M19)
- Simultaneous traversing of the axes is not possible.

**Special features of sequence B** (NC MD 520\* bit 5 = 1)

- M19 is modal, even over a number of blocks
- Block change is performed after the delay of one PLC cycle
- In subsequent blocks axes can be moved or a tool change performed at the same time as positioning or closed-loop position control
- With active positioning (M19) the direction of rotation (M03/M04) must not be reversed, otherwise positioning is performed from an undetermined direction
- During M19 the operating mode can be switched to jog, incremental or repositioning; the position control loop remains closed and the axes can be traversed
- If the PLC detects auxiliary function M19, it can prevent a block change by cancelling READ-IN ENABLE
- If M19 is re-selected before a previous M19 has been terminated by means of the "Acknowledge M19" signal, control is performed with respect to the new spindle position, and the NC approaches the new position over the shortest distance, irrespective of the specified direction of rotation; the spindle travel is less than 180°, irrespective of the control characteristic.

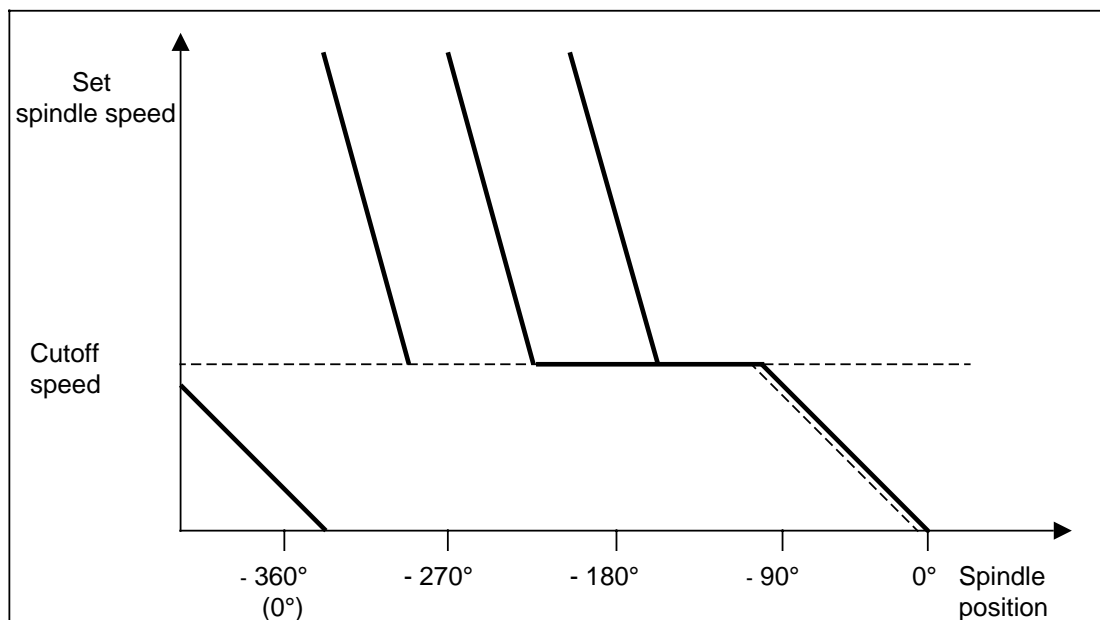

- a) Decelerating the spindle from the programmed speed to the cutoff speed over the ramp characteristic specified by means of the accelerating time constant .
- b) Continue in the same direction of rotation at cutoff speed .
- c) Point of intersection of gain characteristic with cutoff speed (3). At this point the spindle position controller is switched on together with approach to the programmed spindle position at the gain characteristic .
- d) Output of message "Spindle position reached" (DB31 DL<sub>K</sub> bit 4) to the PLC if the actual spindle position has fallen short of the tolerance limit in MD 4430. However, the controller continues to try to approach the programmed position with even greater accuracy, as is possible with drift and the slope of the gain characteristic.
- e) M19 is considered to have been terminated when the signal "Acknowledge M19" is issued by the PLC (DB31 DR<sub>K</sub>+2 bit 2). In this case the position controller is split but the spindle servo enable relay does not drop out (spindle can drift).



If the gain selected is so small that the point of intersection of the gain characteristic with the cutoff speed is more than  $180^\circ$  from the set position, approach to  $180^\circ$  ahead of the set position after the cutoff speed has been reached is performed at the same speed, followed by a jump to the approach curve (6).

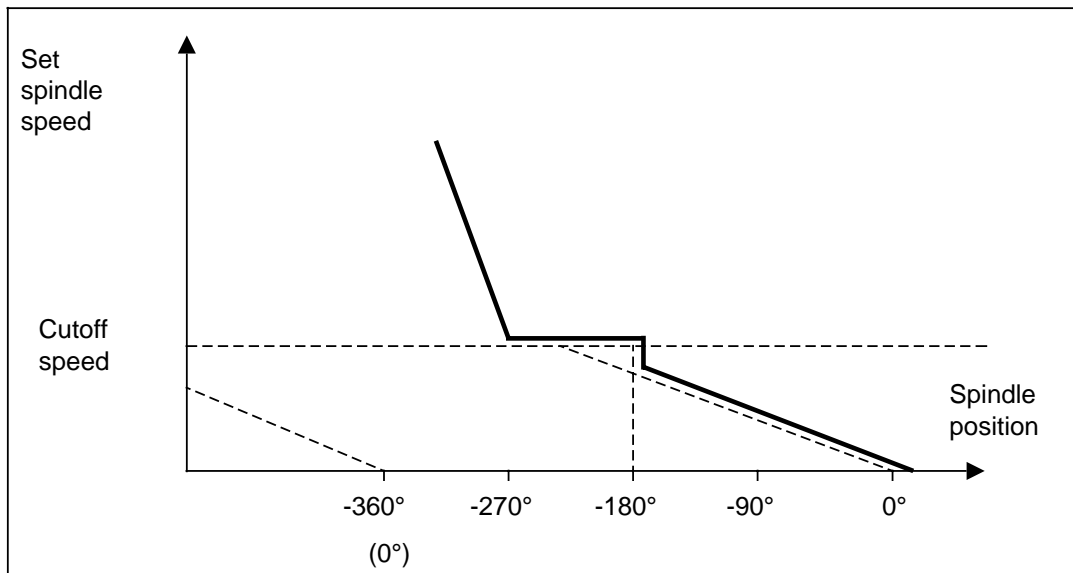

Signal sequence for M19 activated by part program (NC-internal)

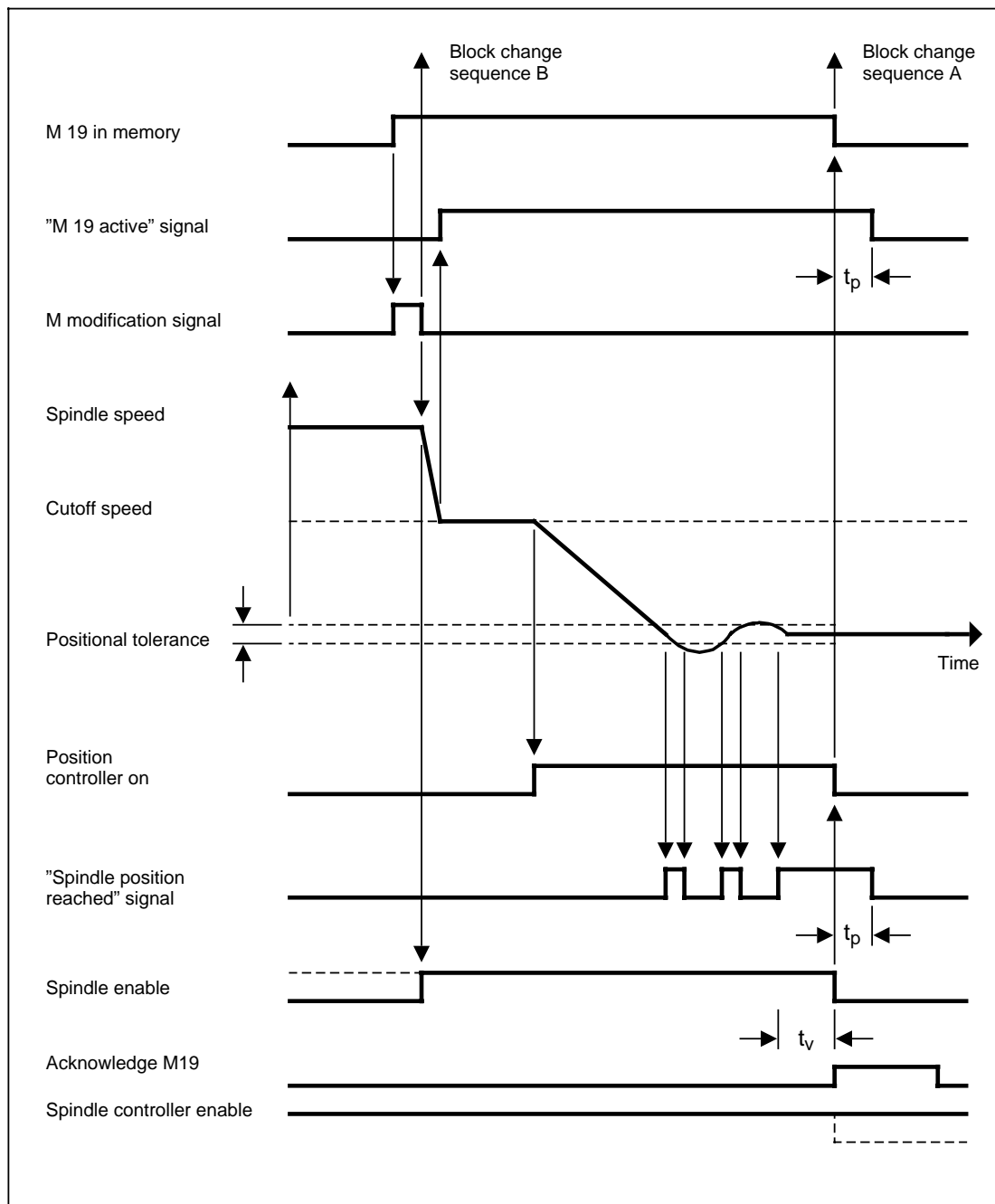

$t_v$ : ..... Delay so that positioning is not aborted on overshoot . The delay is to be implemented in the PLC program.

$t_p$ : ..... Time delay, 1 PLC cycle

In PLC-controlled positioning, the positioning process is triggered by the PLC by transmitting the "PLC spindle control" and "Spindle positioning" signals to the spindle. The set position is specified in NC MD 452\* "Spindle position with ext. M19".

Positioning is terminated if the PLC transmits the "Acknowledge M19" signal to the spindle with the "Position reached" signal. Positioning from rest is possible.

Otherwise, the sequence is identical to NC-internal spindle positioning.

**Note**

It is not possible to use both options (M19 via NC and M19 via PLC) simultaneously.

Signal sequence for M19 activated by PLC

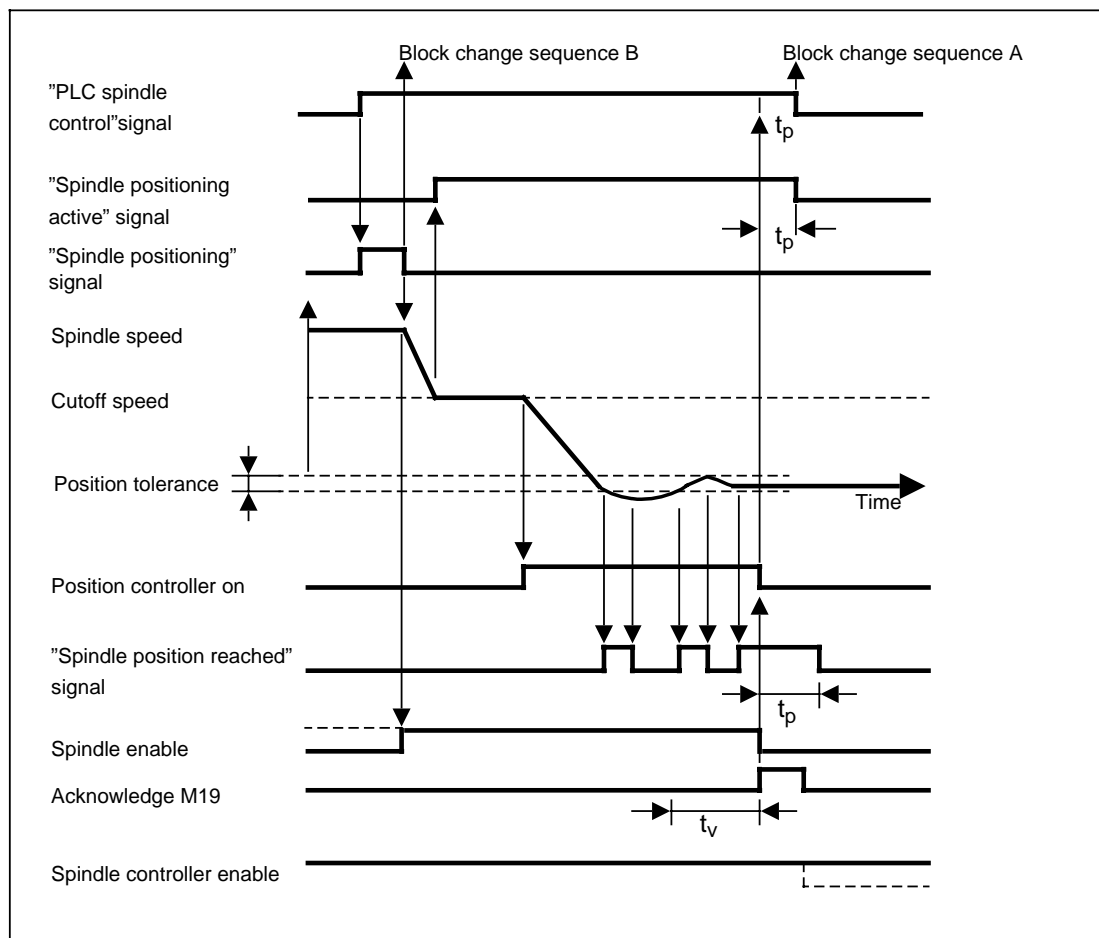

$t_v$ : ..... Delay so that positioning is not aborted on overshoot. The delay is to be implemented in the PLC program.

$t_p$ : ..... Time delay, 1 PLC cycle

**M19 from rest**

The spindle will always approach the programmed position from rest over the shortest path. The "Set direction of rotation clockwise" signal (DB31 DR<sub>K</sub>+2 bit 7) has no significance. The conditions for spindle enable must be maintained.

**Positioning accuracy**

The target position is programmed in 0.1 degrees with decimal point. The accuracy of this position depends on the gain, gear and drift. The maximum achievable accuracy is:

$$\text{Pulse generator with } 1024 \text{ pulses: } \frac{360}{1024 \times 4} = \text{approx. } 0.1 \text{ degrees}$$

$$\text{Pulse generator with } 512 \text{ pulses: } \frac{360}{512 \times 4} = \text{approx. } 0.2 \text{ degrees}$$

Example illustrating how positional accuracy is dependent on the gear and gain:

- Gear 1  
 Maximum speed 3000 rpm = setpoint= 10 V  
 Gain e.g. 200 rpm /360°

$$X = \frac{200}{3000} \times 10 \text{ V} = 0.666 \text{ V}/360^\circ$$

X = Computational setpoint output by the NC if the spindle is 360° alongside the position.

$$\text{Smallest voltage unit } 1 \text{ DAC} = \frac{10 \text{ V}}{8192} = 1.2 \text{ mV}$$

$$p = \frac{1.2 \text{ mV}}{666 \text{ mV}} \times 360^\circ = 0.64^\circ \text{ positioning accuracy}$$

- Gear 2  
 Maximum speed 10 000 rpm=setpoint= 10 V  
 Gain 200 rpm/360°

$$X = \frac{200}{10\,000} \times 10 \text{ V} = 0.2 \text{ V}/360^\circ$$

$$\text{Smallest voltage unit } 1 \text{ DAC} = 1.2 \text{ mV}$$

$$p = \frac{1.2 \text{ mV}}{200 \text{ mV}} \times 360^\circ = 2.16^\circ \text{ positioning accuracy}$$

Theoretically, the positioning accuracy could be improved by increasing the gain. However, it must be borne in mind that this would increase the spindle's tendency to oscillate.

### **M19 and RESET**

NC-MD 520\* bit 6 (no M19 abort on RESET) can be used to prevent function M19 from being aborted with program end (M30/M2) or RESET (key). In this case M19 is only aborted by means of the "Acknowledge M19" signal from the PLC or alarms cancelling NC Ready 2 or EMERGENCY STOP.

### **Acknowledge M19**

If the "Spindle position reached" signal is output during positioning by the NC, the PLC must cancel the "Acknowledge M19" signal if function M19 is to be terminated. However, the "Acknowledge M19" signal may only be issued when the spindle is in a transient condition. In the event of serious overshoot (very high gain), it is advisable to output the "Acknowledge M19" signal after a delay only when the "Spindle position reached" signal is definitely present for a machine-specific time  $t_v$ .

From Software Version 03 the signal "Acknowledge M19" not only aborts spindle positioning but the spindle is also stopped (like M05) and a new M03 or M04 must be programmed in the part program so that the spindle can run up the previous programmed S value.

The "Acknowledge M19" signal is only active in conjunction with "PLC spindle control". M functions M3 and M4 also terminate positioning, irrespective of whether or not the position has already been reached.

### **Spindle servo enable with M19**

Spindle servo enable (DB31 DL<sub>K</sub>+1 bit 6) cannot be used to control M19. In addition, it must be present prior to M19, i.e. the M modification signal can only be used to reset spindle inhibit; spindle controller enable must already be set.

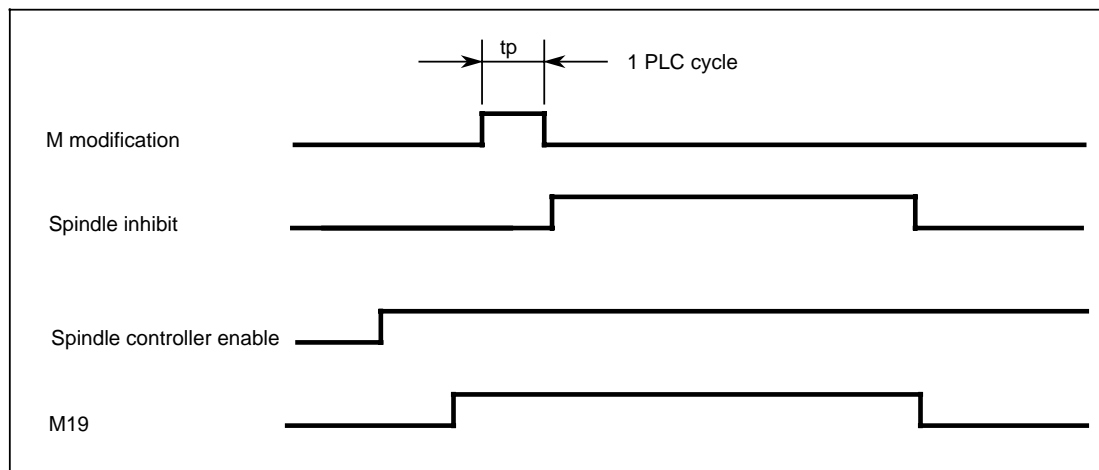

### ***Position control direction with M19***

If the spindle is to be switched with M19 from open-loop to closed-loop control, the pulses from the ROD encoder must have the correct directional rotation on reaching the controller. An incorrect position control direction is characterized by the fact that 180° ahead of the programmed position, the spindle exhibits severe reciprocation about this position. In this case NC MD 521\* bit 1 must be inverted.

## **11.2.4 Spindle influencing by PLC**

The function diagram below is intended to show the effect of the individual PLC interface signals on the spindle. The feedback pulses are not shown for reasons of clarity. The signals "Set direction of rotation clockwise", "Reciprocation speed", "Set speed", "Spindle positioning", "Spindle resynchronization" and "Acknowledge M19" are only active in conjunction with the "PLC spindle control" signal.

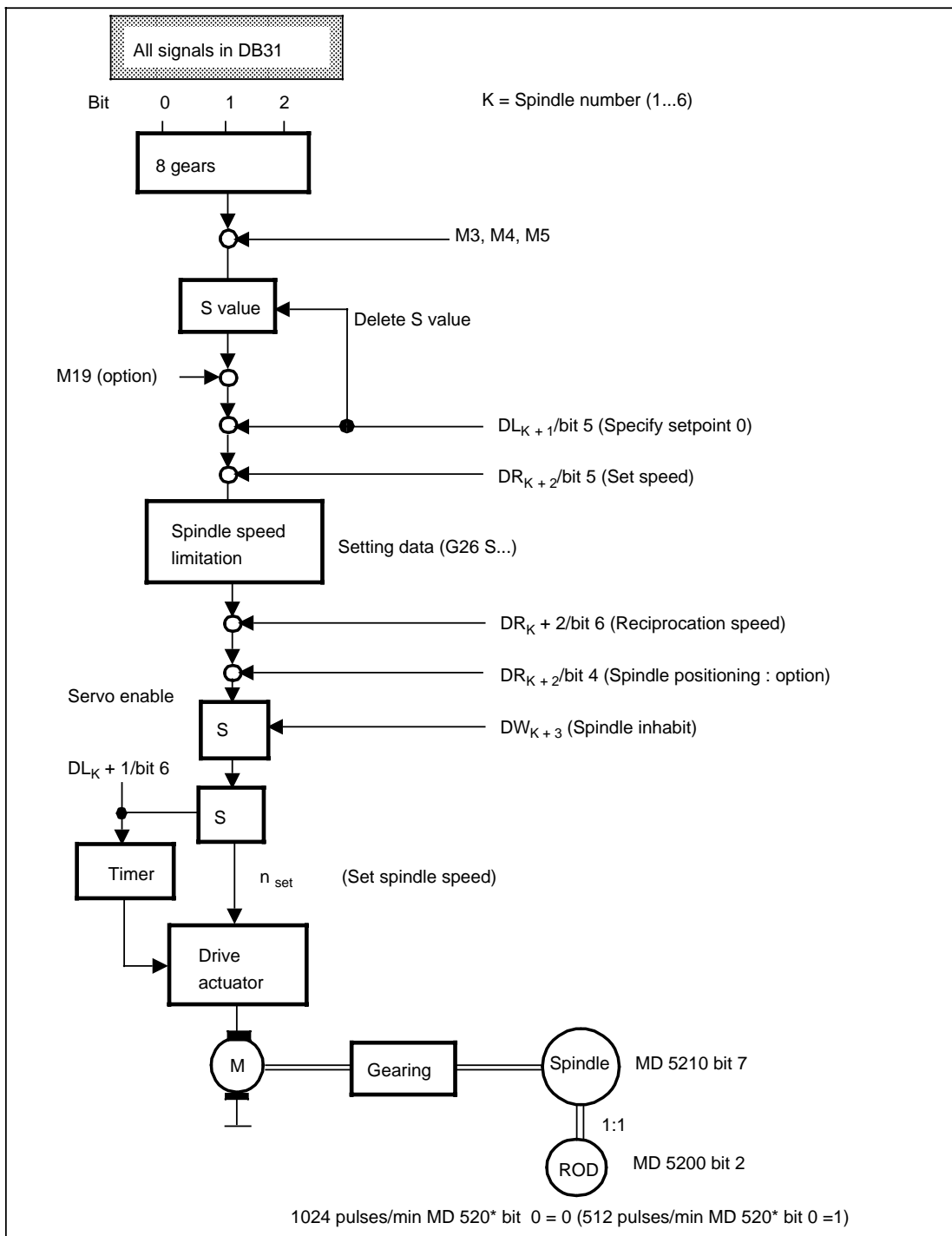

Ways of intervening in the PLC spindle control by PLC interface signals

## 11.3 Approach to reference point

### 11.3.1 Corresponding MD

- MD 240\* ..... (Reference point value)
- MD 244\* ..... (Reference point shift)
- MD 284\* ..... (Reference point creep velocity)
- MD 296\* ..... (Reference point approach velocity)
- MD 5008 bit 5 ..... (Setting up in JOG mode)
- MD 560\* bit 6 ..... (Approach to reference point with automatic identification of direction)
- MD 564\* bit 0 ..... (Direction of approach to reference point)
- Signal "Reference point reached" ..... (DB 32 DL<sub>K</sub> bit 4)
- Signal "Deceleration reference point approach" ..... (DB 32 DL<sub>K</sub> + 1 bit 4)

Directly related:

- MD 5004 bit 3 ..... (NC START without reference point)
- MD 560\* bit 4 ..... (No reference point start inhibit)

### 11.3.2 Automatic identification of direction with approach to reference point

The controller makes it possible to approach the reference point in two different ways, with or without automatic identification of direction. Selection is performed via MD 560\* bit 6.

#### 11.3.2.1 Approach to reference point without automatic identification of direction

##### *Preconditions*

- MD 560\* bit 6 = 0
- Axis-specific feed enable set
- Common feed enable set
- Reference point between reference point cam and limit switch.

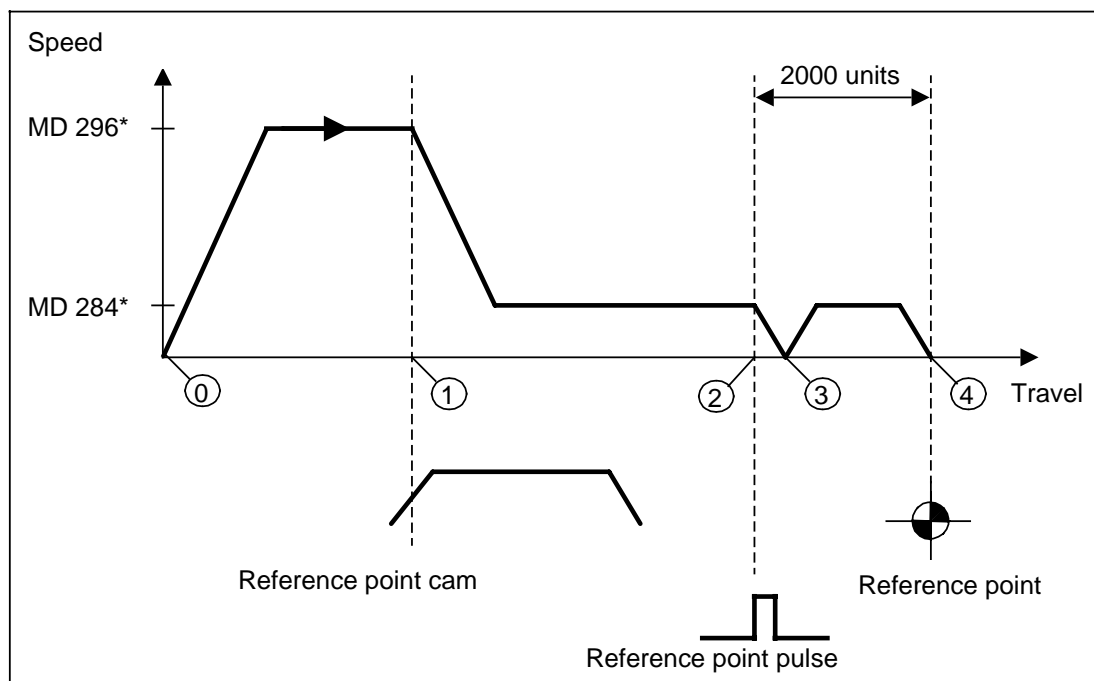

**Case 1:** Axis ahead of reference point cam

- ① When the correct direction key is actuated, approach to the reference point for the axis concerned is initiated in the specified direction (MD 564\* bit 0) at the speed in MD 296\*.
- ① When the reference point cam is reached, the axis speed is reduced to the value in MD 284\* via the "Deceleration" interface signal.
- ② After the reference point cam has been left, the next reference point pulse is evaluated and the axis braked.
- ③ In order to prevent machine backlash during approach to the reference point, a distance of 2000 units is covered from the reference point pulse to the actual reference point.  
In view of the fact that point ③ is at different locations for different speeds, the distance to go ( ) must be determined before approach to the actual reference point. To this end, the axis brakes to zero speed.
- ④ Reference point reached.

**Note:**

The distance travelled by the controller (3) (4) after reaching the zero mark is dependent on the position control resolution entered in NC MD 5002. Thus after reaching the zero mark, the NC will travel another 2 mm given a specified position control resolution of  $1/2 \times 10^{-3}$  mm but 20 mm when the position control resolution is  $1/2 \times 10^{-2}$  mm. This distance could be compensated by means of NC MD 244\* "Reference point shift".  
Example: Input NC MD 244\* = 2000 units of position control resolution  $1/2 \times 10^{-3}$  mm. During approach to the reference point, the axis would move as far as (3) and then back to (2).

**Case 2:** Axis on reference point cam

The axis accelerates immediately to the reference cutoff speed (MD 284\*) instead of the reference speed.

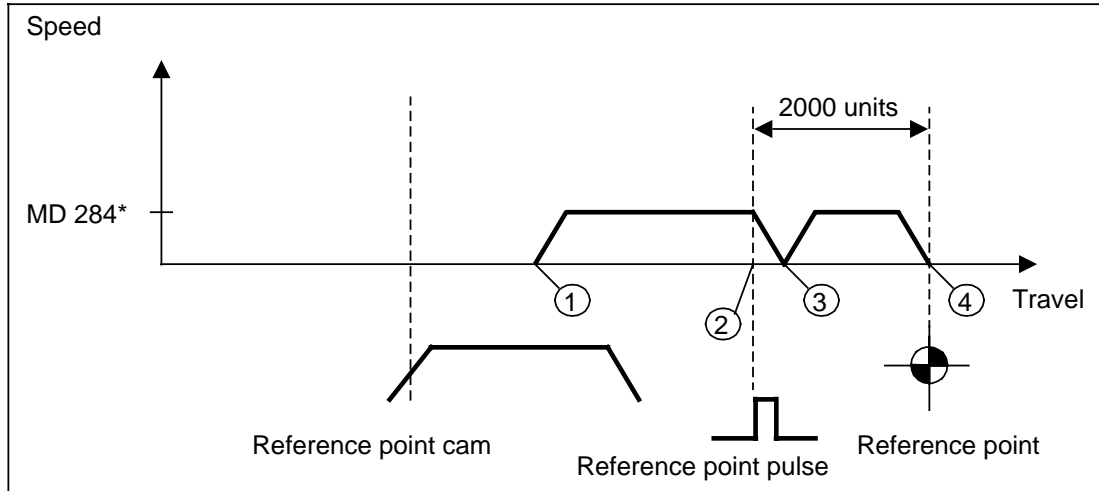

**Case 3:** Axis behind reference point cam

In view of the fact that the condition of the "Deceleration" signal behind the reference point is the same as for the signal in front of this point, the controller assumes that the axis is ahead of the reference point cam and accelerates to the reference point approach speed (MD 296\*), i.e. in Case 3 it moves at high speed to the limit switch (EMERGENCY STOP) since the software limit switches prior to or during approach to the reference point are not active.

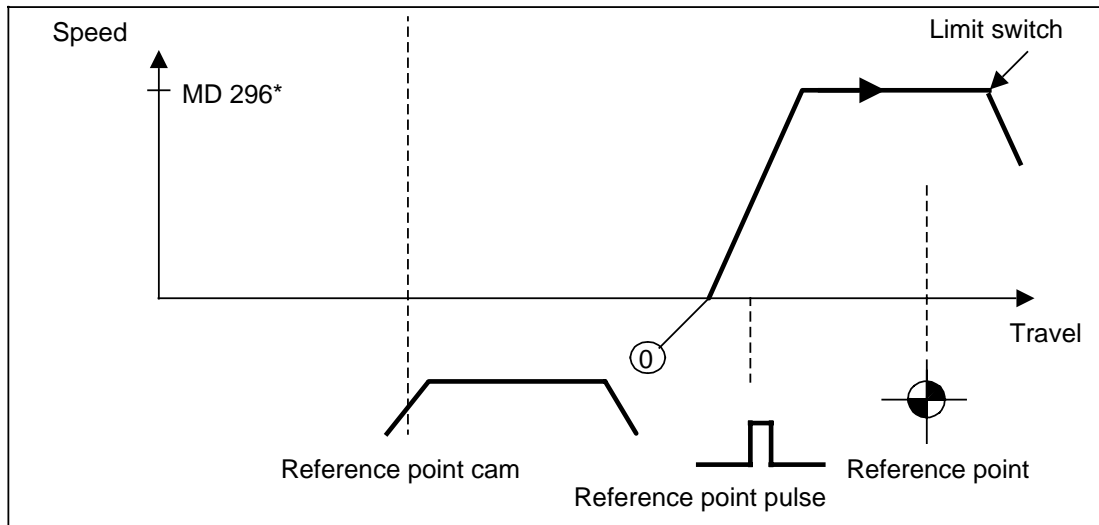

Complex travel interlocks had to be integrated into the PLC to obviate Case 3. It was thus decided in the case of the SINUMERIK System 800 to offer a facility which follows on from Case 3 with approach to the reference point without any additional PLC support. This function is called approach to reference point with automatic identification of direction.

### 11.3.2.2 Approach to reference point with automatic identification of direction of direction

#### Preconditions

- MD 560\* bit 6 = 1
- Feed enable signals set
- Reference point cam reaches as far as traversing limit
- Reference point in front of reference point cam

Automatic identification of direction is designed to prevent Case 3 during approach to the reference point without automatic identification of direction.

#### Case 1: Axis ahead of reference point cam

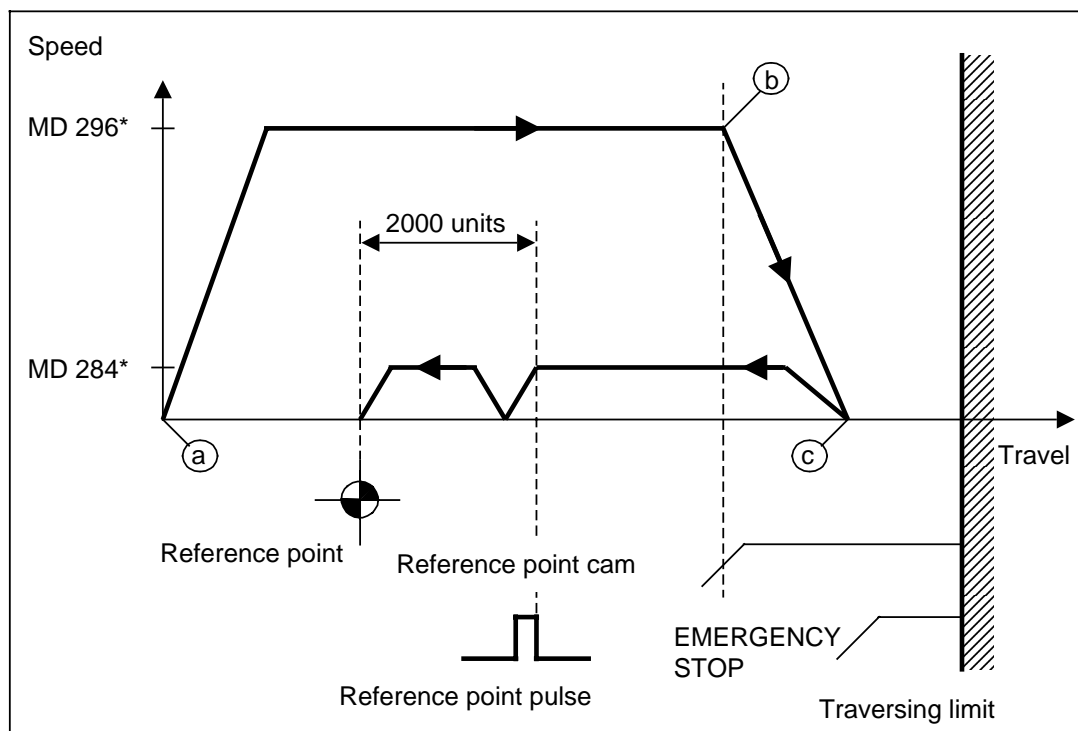

- (a) When the direction key is actuated, approach to the reference point for the axis is initiated in the specified direction (MD 564\* bit 0) at the speed in MD 296\*.
- (b) When the reference point cam is reached, the axis is braked to zero speed with the "Deceleration" signal.
- (c) Deceleration from the reference point cam is performed at reverse speed (MD 284\*) and the next reference pulse is evaluated (see Section 11.3.2.1 for a detailed description of the remainder of the sequence).

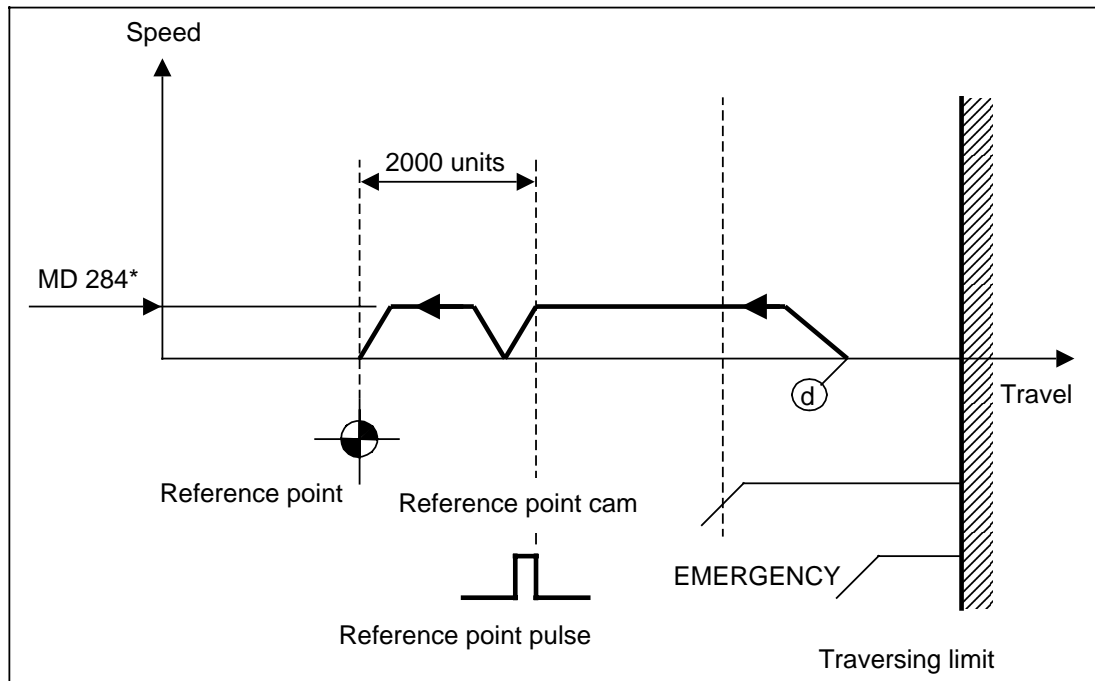
**Case 2:** Axis on reference point cam

- ⓓ When the direction key is actuated, the CNC can determine precisely from the "Deceleration" PLC signal that the axis is already on the reference point cam. The axis thus accelerates in the opposite direction (compared to MD 564\* bit 0) to the speed in MD 284\* (see Section 11.3.2.1 for a detailed description of the remainder of the sequence).

**Case 3:** Axis behind reference point cam

This case cannot occur.

### 11.3.3 Reference point approach via program

The reference point can be approached in the part program with the programming function G74. The sequence is similar to that shown in 11.3.2.1 or 11.3.2.2.

The defined direction (MD 564\* bit 0) is started with G74 in the part program instead of with the direction key.

**Example:** AUTOMATIC or MDI mode  
N10 G74 X LF

Comments:

- Only one axis per NC block can be programmed in the part program (e.g. G74 C LF)
- TRANSMIT function and coupled motion must not be selected.
- G74 is active block by block.
- With G74 the tool offset and the zero offset PRESET + DRF are suppressed internally and become active again automatically after reference point reached. This also applies to G functions, such as G01, G93, G94 etc.
- After the function "Reference point approach with synchronization via program" has been started the "current position" is still updated. The "distance to go" is displayed as zero because during reference point approach there are no sensible values for distance to go.

## 11.4 Leadscrew error compensation

### 11.4.1 Corresponding data

- NC MD 316\* (Pointer compensation +)
- NC MD 320\* (Pointer compensation -)
- NC MD 324\* (Distance between 2 leadscrew error compensation points)
- NC MD 328\* (Compensation value)
- NC MD 6000 to 6999 (Leadscrew error compensation points)
- Option H56

**Caution!**

Modification of all NC MD for leadscrew error compensation is not active until after POWER ON and reference point approach.

### 11.4.2 Function description

The principle of "indirect measurement" in NC-controlled machines assumes that the pitch of the ball screw is constant at any point within the traversing range so that the actual axis position may be derived from the position of the drive spindle. However, varying deviations result from manufacturing tolerances in the various spindle qualities. In addition, measuring system errors ( though comparatively insignificant) and any other possible machine-dependent errors must be taken into account. The sum check error may be determined by plotting an error curve over the entire traversing range of the axis. The reference measuring system used must be a high-precision instrument, e.g. a laser interferometer. The dimensional deviation at the workpiece can be significantly reduced as a result of appropriate compensating values which are input in the controller at the installation stage.

The errors in all axes can be compensated separately. To this end, a total of 1000 compensation positions per servo CPU are available for all axes. The compensation position spacing for each axis is selectable over a range of 1 to 16,000 units. A compensating value of 0 to 100 units which is equal for all positions per axis may be set.

The leadscrew error compensation points lie in the machine data areas:

- MD 6000 to 6249 for axes of the 1st servo CPU
- MD 6250 to 6499 for axes of the 2nd servo CPU
- MD 6500 to 6749 for axes of the 3rd servo CPU
- MD 6750 to 6999 for axes of the 4th servo CPU

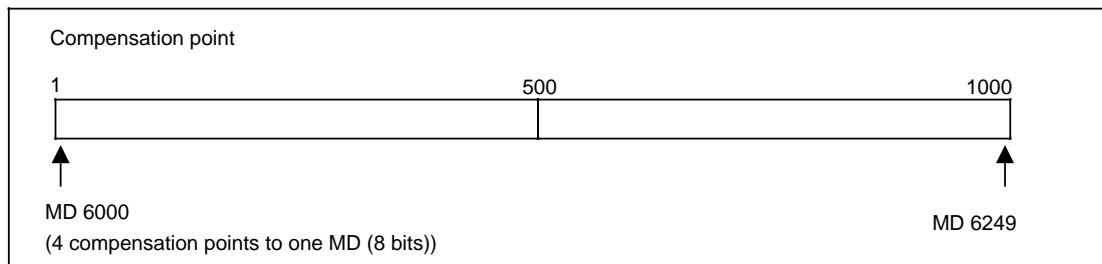
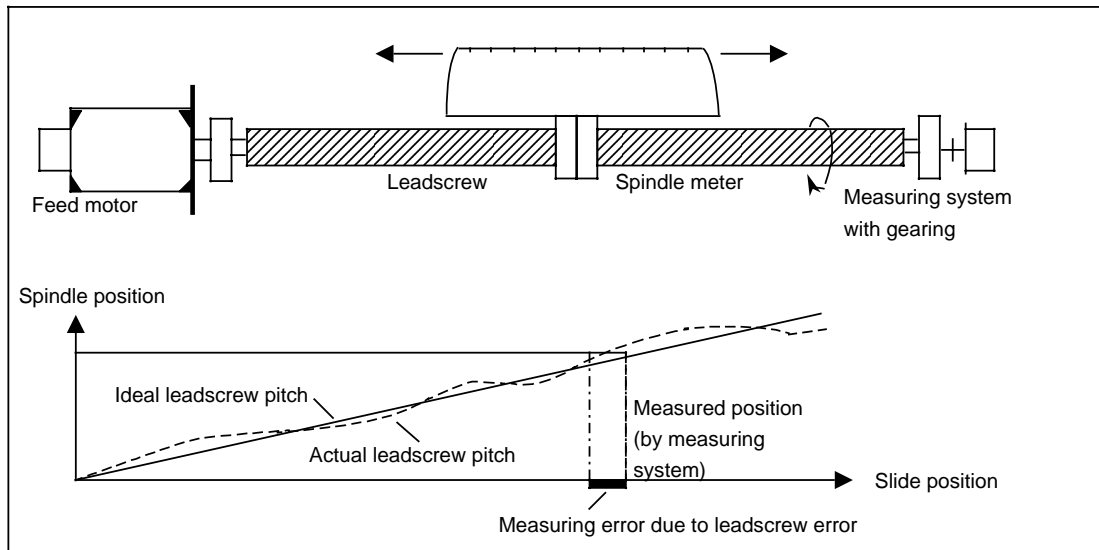

### Measurement of leadscrew error compensation

The reference point is first approached to synchronize the measuring system. This is then followed by travel to the negative range limit of the axis, commencing from this point to plot an error curve in the positive direction using an accurate instrument; the reference point must be identified.

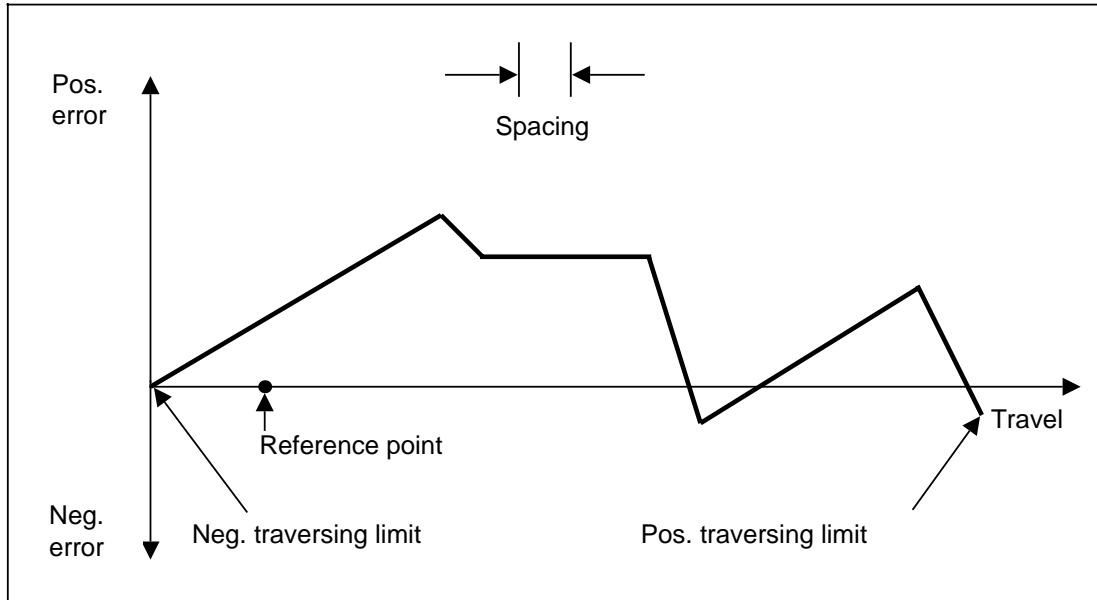

In view of the fact that compensation is not possible at the reference point, the error curve must be shifted so that the error is zero at the reference point.

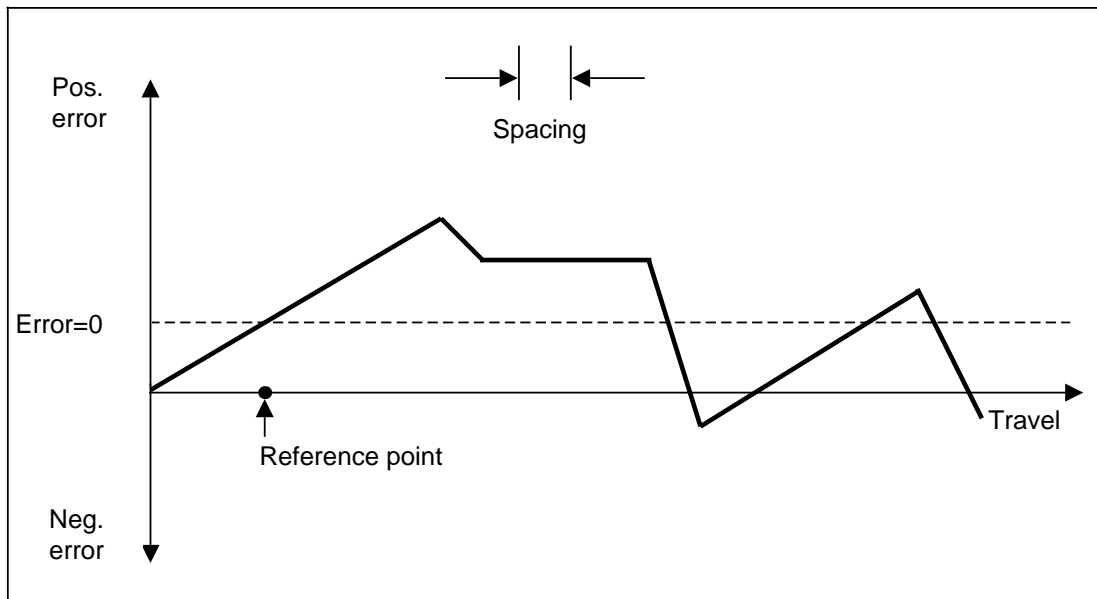

The spacing between 2 leadscrew error compensation points (MD 324\*) is then specified, being based on the permissible tolerance of the final (compensated) leadscrew error curve, the actual leadscrew pitch error and the number of possible compensating values.

The following method may be used to determine the spacing between 2 leadscrew error compensation points:

- S : Compensation amount, e.g. 1/2 tolerance band
- l : Spacing between 2 leadscrew error compensation points

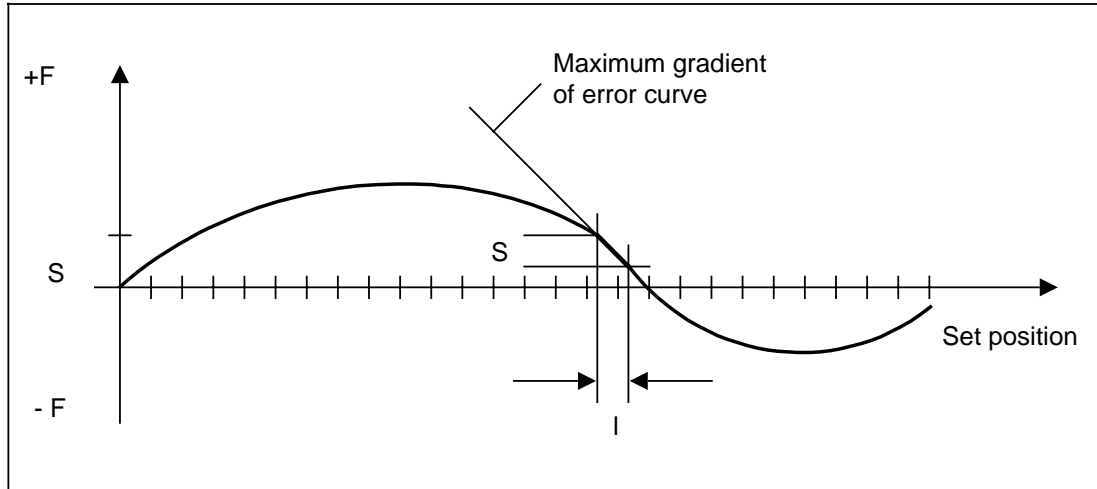

The point exhibiting the greatest error is determined together with the distance ( l ) covered by the specified compensation amount ( S ).

- S : Compensation amount = MD 328\*
- l : Spacing = MD 324\*

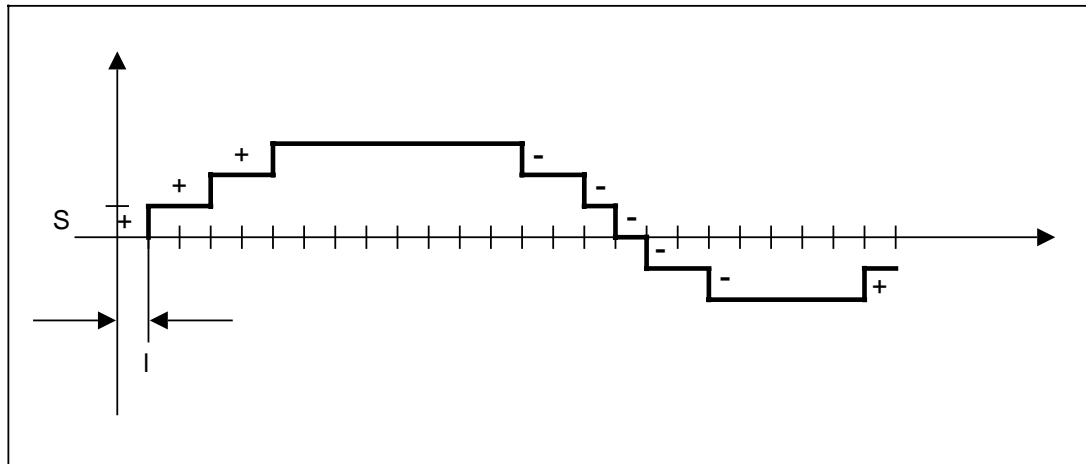

The relevant compensating value for the spacing is based on the permissible tolerance band and should be selected so that the compensated error curve approximates as closely as possible to the ideal condition. The compensating value (0 to 100 units) is transferred to NC MD 328\*.



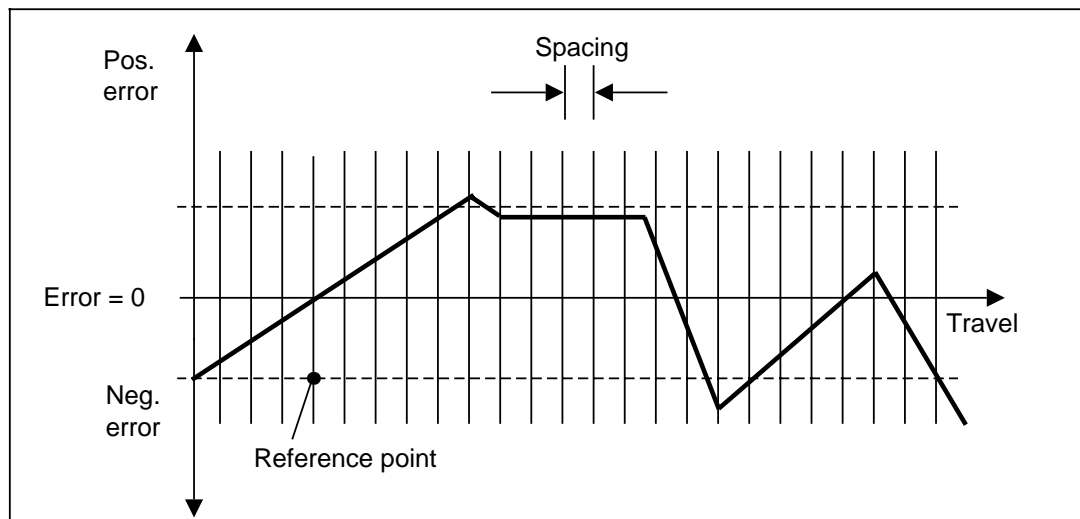

It is then specified how many compensating points must be supplied by way of the input spacing between 2 leadscrew error compensation points and the end stops at the machine. Since leadscrew error compensation is only active with synchronization of the axis - at the reference point - particular significance is attached to the compensation point coinciding with the reference point. This compensation point is entered in encoded form in MD 316\*. The compensating value at this point must be 0.

Comp. point	1	793	1000
NC MD	6000	6198	6249
MD 316 *	0	198	249

In view of the fact that the SINUMERIK 880 has a total of between 1000 and 4000 compensation points for all axes, the controller must be informed by means of MD 316\* as to which of the points corresponds to the axis reference point. The compensation point is not entered directly in MD 316\*, MD offset (MD 6125 = MD offset = 125) for NC CPU 1 being entered instead, so the reference point can only be located on compensation points 1, 5, 9, 13, 17, ...

MD No.	Bit No.							
	7	6	5	4	3	2	1	0
<b>6000</b>	Comp. point 4 Yes / No + / -		Comp. point 3 Yes / No + / -		Comp. point 2 Yes / No + / -		Comp. point 1 Yes / No + / -	
<b>6001</b>	Comp. point 8 Yes / No + / -		Comp. point 7 Yes / No + / -		Comp. point 6 Yes / No + / -		Comp. point 5 Yes / No + / -	
<b>6002</b>	Comp. point 12 Yes / No + / -		Comp. point 11 Yes / No + / -		Comp. point 10 Yes / No + / -		Comp. point 9 Yes / No + / -	
<b>6248</b>	Comp. point 996 Yes / No + / -		Comp. point 995 Yes / No + / -		Comp. point 994 Yes / No + / -		Comp. point 993 Yes / No + / -	
<b>6249</b>	Comp. point 1000 Yes / No + / -		Comp. point 999 Yes / No + / -		Comp. point 998 Yes / No + / -		Comp. point 997 Yes / No + / -	

- = 0  
 + = 1  
 No = 0  
 Yes = 1

Since 4 compensation points are available for each machine data, it is specified in the controller that only the point on the far right-hand side (bits 0, 1) can be defined as the reference point.

**Example:**

- Reference point to be at compensation point 793

$$\text{MD offset} = \frac{793 - 1}{4} = 198$$

- MD offset 198 = MD 6198

Value in MD 316\* ... 198

As stated above, the reference point determines which of the possible 1000 compensation points are used for the axis concerned. At this compensation point compensation is not possible.

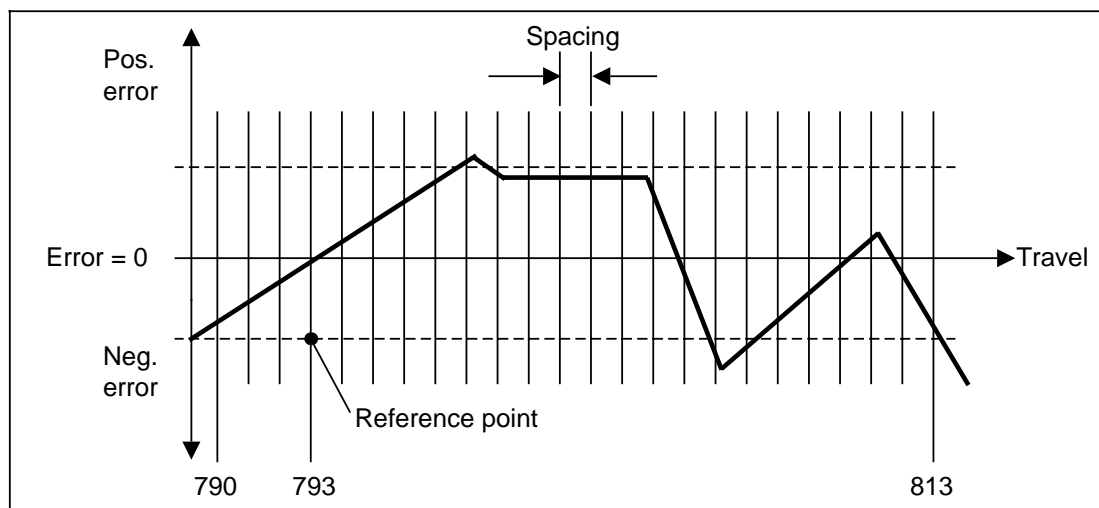
**Example:**

Axis 1 exhibits the following error curve; no compensation points have been used so far.

Reference point value 0

Max. travel in negative direction - 35.000 mm

Max. travel in positive direction 205.00 mm

Tolerance band (specified by machine manufacturer), e.g. specify 0.01 mm spacing between 2 leadscrew error compensation points, e.g. 10 mm:

235 mm travel max.-

**A-**

10 mm grid spacing

**3 compensating values**

205 mm travel max.+

**A+**

10 mm grid spacing

**20 compensating values**

Total number of compensating values:

$$C = (A-) + (A+) + (\text{Ref}) = 3 + 20 + 1$$

**24 compensating values**

Thus for NC MD 3161 = 1 (NC MD 6001), i.e. compensation point 5 is the point at which the reference point is located; compensation may not be performed at this point. When 10 mm travel is performed in the negative direction, compensation point 4 is used for compensation. Compensation point 6 is used for 10 mm travel in the positive direction.

- Tolerance band e. g. 10  $\mu\text{m}$

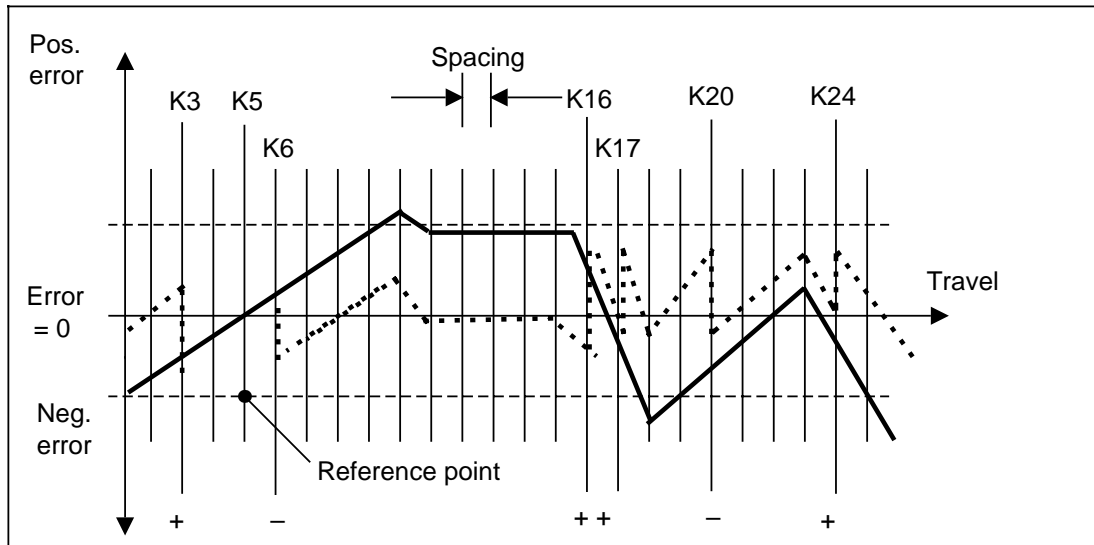

- - - - Compensating value, e.g. 5  $\mu\text{m}$   
 . . . . . Compensated curve

Starting from the reference point in the negative direction, the error curve extends as far as the traversing limit within the tolerance band. No compensation should be required. Better results are obtained if positive compensation is performed to C3.

In order to ensure that errors are maintained as near as possible to zero, compensation is required in the positive direction as follows: negative to C6, positive to C15 and C16, negative to C20 and positive once more to C24. The new error curve would then be as above.

The following machine data should be set:

- Leadscrew error compensation option
- NC MD 3161 = 1 (specifying reference point, C5)
- NC MD 3241 = 10000 (grid spacing 10 mm)
- NC MD 3281 = 5 (compensating value 6  $\mu\text{m}$ )
- NC MD 6000 = 00 11 00 00 (positive compensation, C3)
- NC MD 6001 = 00 00 10 00 (negative compensation, C6, bits 0 and 1 must be 0)
- NC MD 6002 = 0 No compensation
- NC MD 6003 = 0 No compensation
- NC MD 6004 = 00 00 11 11 (positive compensation, C15 and C16)
- NC MD 6005 = 00 00 10 00 (negative compensation, C20)
- NC MD 6006 = 00 00 11 00 (positive compensation, C24)

If the reference point is assigned to compensation point 793, breakdown of the 1000 compensation points is as follows:

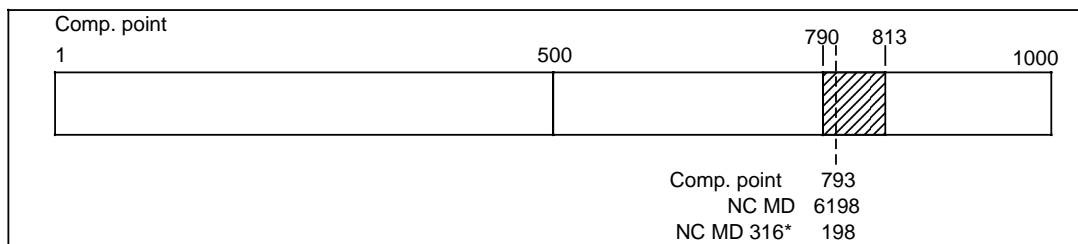

The reference point determines the location of the hatched area of the compensation points used. This area terminates at point 790 or 813 due to the spacing between the leadscrew error compensation points and the maximum traversing range of the axis.

If leadscrew error compensation is used for a number of axes, the commissioning engineer must ensure when inputting the MD that the compensation points do not overlap during traversing as no check is carried out in the controller. However, the gaps between the axes can be of any size, provided the overall range of 1000 compensation points is not exceeded. With direction-dependent leadscrew error compensation, there is - similar to leadscrew error compensation - a second compensation curve plotted from the positive to the negative direction.

In the case of ball screws, pre-stressing of the screw nut yields an identical error curve, irrespective of the plot direction during measurement. However, with worm drives, significant differences may arise between the positive and negative directions of travel. Consequently, an error curve must also be plotted in the negative direction and input as compensation.

The procedure is similar to that for entering the positive compensation values, ensuring that the compensation ranges do not overlap between the positive and negative traversing movements and between the axes. Since the reference point again determines with this compensation curve where the compensation points lie within the 1000 points, the reference point must be entered in NC MD 320\* in encoded form (MD offset).

**Example:**

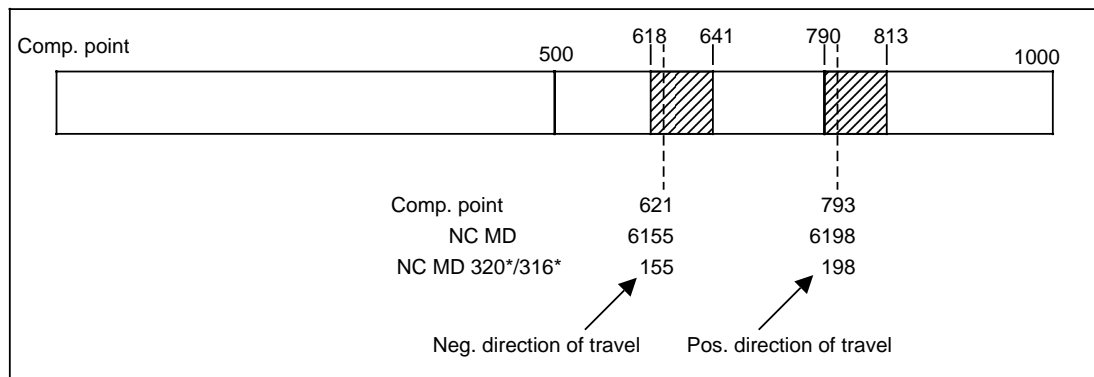

Both direction-dependent and direction-independent leadscrew error compensations are options and must therefore be ordered (H 56).

Any modification to the MD is only active after Power On and reference point approach.

Since the compensating value at the compensation point must be processed as quickly as possible, the input acceleration (NC MD 276\*) is not applicable in this case.

Consequently, the compensation value (NC MD 328\*) is limited to max. 100 units.

## 11.5 Rotary axis functions

### 11.5.1 Corresponding data

All data as with linear axes, but with the following additions/supplements:

- NC MD 344\* (Modulo value rotary axis for leadscrew error compensation)
- NC MD 560\* bit 7 (Actual value display modulo 360°)
- ND MD 560\* bit 3 (Rounding values with rotary axes)
- NC MD 560\* bit 2 (Rounding to whole/half degrees)
- NC MD 564\* bit 5 (Position control for rotary axis)
- NC MD 572\* bit 2 (Rotary axis modulo 360° programming)
- NC MD 5002 (Input resolution)
- NC MD 5002 (Position control resolution)
- Alarm 100\* (Spindle lead grid distance invalid)
- Alarm 2064 (Program error rounding axis)

### 11.5.2 Function description

A rotary axis has to meet different requirements, depending on the machine type. The rotary axis function is therefore subdivided into three part functions which are activated by means of the machine data or program.

Combining the part functions allows the controller to be matched to the various machine types. Graphic simulation of rotary axes is not possible.

#### ***"Rotary axis": NC MD 564\* bit 5***

This machine datum defines the axis as a rotary axis. The display is absolute (1 revolution 360°, 2 revolutions 720° etc.), as too are the @ functions. However, the axis is programmed like a linear axis. The axis-specific NC MD units are treated otherwise.

Unit  $10^{-3}$  degrees given a position control resolution of  $1/2 \times 10^{-3}$  units and an input resolution of  $10^{-3}$  units.

#### ***Actual-value display "Modulo 360°": NC MD 560\* bit 7***

"Modulo" display when the bit is set, i.e. after 359.999 degrees the actual-value display is reset to 0. The axis is programmed in the same way as a linear axis.

#### ***"Modulo programming": NC MD 572\* bit 2***

After powering up and after block search, the shortest path is always processed with the machine datum set. The G68 function allows the block end value always to be approached over the shortest path.

G68 is modal and belongs to the G90/91 group. G68 is treated in the same way as G90 if "modulo programming" is not activated.

If the rotary axis is not to cover the shorter path, it must be programmed with G90 and a sign.

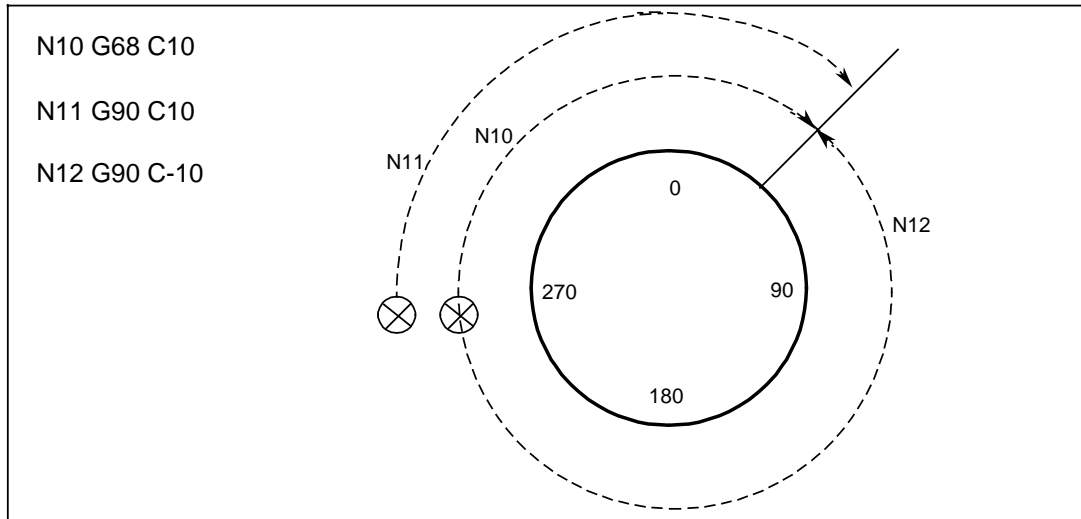
**Example:** Axis at 270°

Machine data "Modulo 360°" and "Modulo programming" are only allowed with the "Rotary axis" machine data.

**Combination of part functions:**

Rotary axis	Modulo program	Modulo 360°	Remarks
0	0	0	Linear axis
1	0	0	Application permitted
1	0	1	
1	1	1	
1	1	0	Application prohibited
0	0	1	
0	1	1	
0	1	0	

### ***Axis-specific machine data***

If an axis is defined as a rotary axis (NC MD 564\*bit 5), the following applies, depending on NC MD 5002 (input resolution and position control resolution):

## **11.6 Warm restart**

### **11.6.1 Corresponding data**

- NC MD 100\* (Mode group number)
- NC MD 360\* (Axis valid in mode group)
- NC MD 453\* (Spindle valid in mode group)
- Signal DB 48 DL 0 Bit 0 (Initiate warm restart)
- Signal DB 48 DR 1 Bit 0 (Warm restart ended)
- Alarm No. 70 to 80
- Alarm No. 3023
- Alarm No. 3014

### **11.6.2 Function description**

In some machines, arbitrary axes must be assigned to another mode group (BAG) without having to shut down the control since the reference point is then lost.

***Example:***

A machine has 2 working areas:

Working area I with axis B'

Working area II with axis B1'

The working areas are broken down into different operating groups to permit efficient working. The three main axes X, Y, Z are then assigned separately via the hot start function to working area I (mode group 1) or working area II (mode group 2). Each working area requires a special machine control panel to which main axes X, Y, Z are assigned.



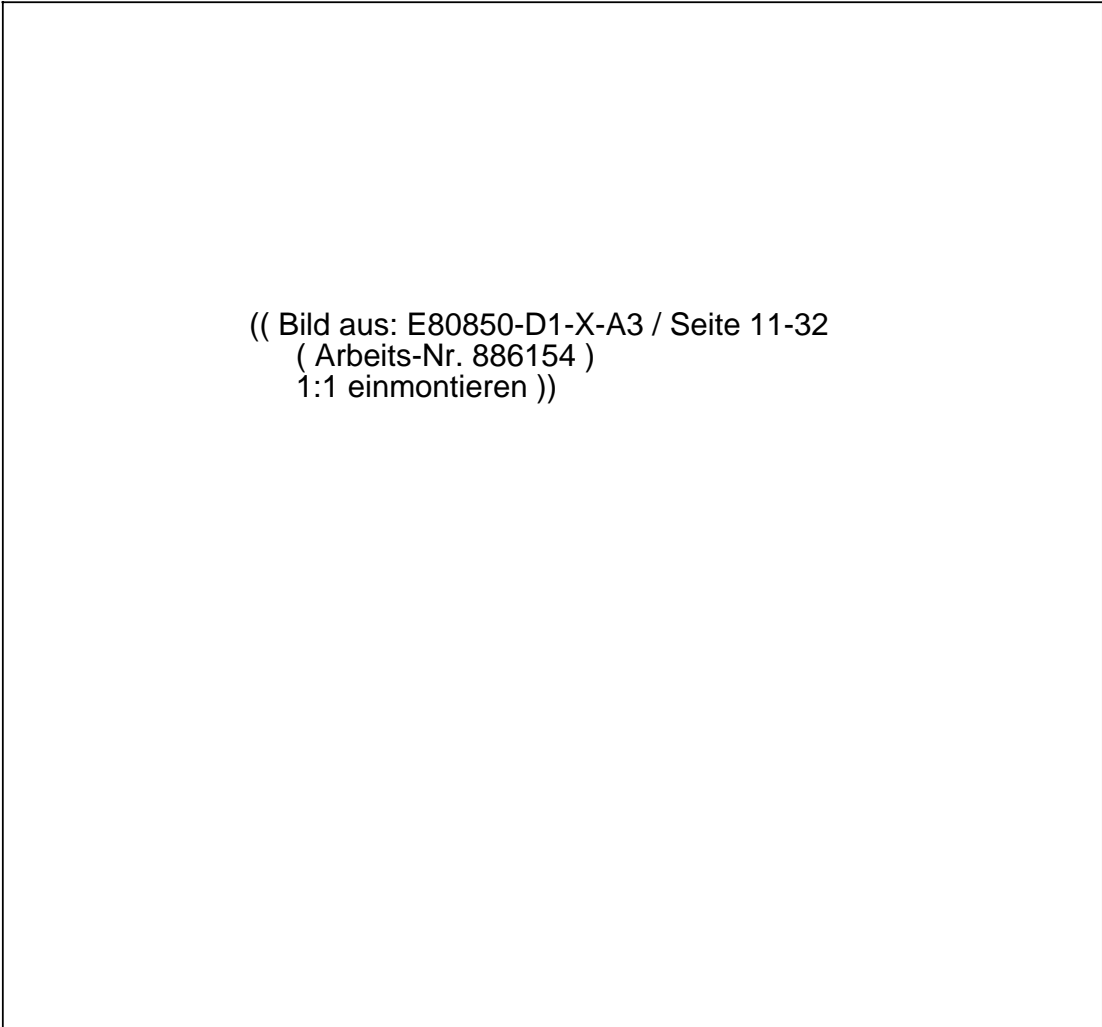

(( Bild aus: E80850-D1-X-A3 / Seite 11-32  
( Arbeits-Nr. 886154 )  
1:1 einmontieren ))

If work is performed in working area I, the three main axes X, Y, Z, axis B and the spindle are assigned to machine control panel 1 or mode group 1.

In working area II, axis B1' can be moved in jog mode to load and unload a workpiece.

If a workpiece is now to be machined in working area II with clamping and unclamping in working area I, the axis assignments must be modified, i.e. the mode groups must be switched. During this changeover, the axes are re-assigned to the machine control panels.

An auxiliary function is assigned to each working area for mode group switching purposes. When the respective auxiliary function is output, the PLC recognizes the necessary axis configuration and corrects it if necessary in the machine data. Once the machine data have been modified, the "warm restart" function must be activated at the interface by the PLC (DB48 DLO bit 0). This function reconfigures the controller without the reference points having to be approached once more.

The machine data may also be modified using @ functions by calling a cycle from the PLC in an unassigned channel.

Warm restart must be performed when the following machine data are modified:

- NC MD 100\* ..... Mode group number
- NC MD 316\* ..... Pointer for leadscrew error compensation
- NC MD 320\* ..... Pointer for leadscrew error compensation
- NC MD 360\* ..... Axis valid in mode group
- NC MD 453\* ..... Spindle valid in mode group
- NC MD 876 to 899 .... Coupled-axis grouping
- NC MD 5156 to 5183 .. Coupled-axis combination
- NC MD 5060 to 5139 .. Transformationsdatensätze

In the case of all other reconfigured machine data, hardware reset (POWER ON) must be performed following modification.

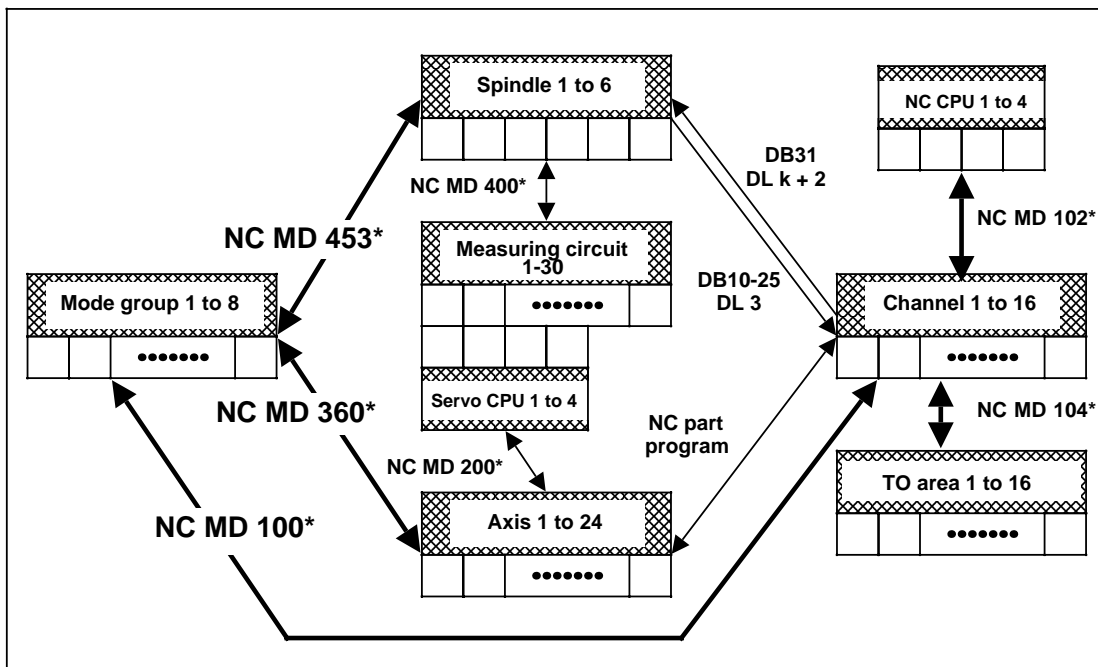

The following MD do not necessitate a warm restart when modified:

NC MD		Modification accepted
104*	TO range number	immediately
304*	IPO parameter name	after each NC block
548*	Axis name, horizontal axis	after each NC block
550*	Axis name, perpendicular axis	after each NC block
552*	Axis name, vertical axis	after each NC block
554*	Axis with constant cutting speed	after each NC block
576*	Axis not allowed in channel	after each NC block
580*	Axis not allowed in channel	after each NC block

Warm restart may only be performed with all channels in the reset state, i.e. all channels must be put into the reset state by the PLC, coupled motion and transformation must be deselected and all spindles stopped (with M19 active) before the warm restart is initiated.

During hot start, the reset status in all NC channels must not be cancelled.

The axial, spindle-specific interface as well as the "Emergency Stop" signal at the NC PLC and PLC NC interfaces is not processed during warm restart (controller in reset state).

#### Warm restart functional sequence

1. NC
  - NC MD 360\* is defined using CL800 instructions (also feasible via PLC)
  - Auxiliary function for warm restart request is output, e.g. H1234
2. PLC
  - Auxiliary function is interpreted
  - NC MD 360\* is defined by PLC (also feasible via NC)
  - Reset via PLC for complete controller 0
3. NC
  - All part programs are aborted (channels 1 to 16)

In steps 1, 2 or 3 all spindles must be stopped.

4. PLC
  - User sets at interface: "warm restart" 1 (DB48 DL0 bit 0)
5. NC
  - Sets interface signal: "warm restart terminated" 1 (DB48 DR2 bit 0)
6. PLC
  - User clears interface: "warm restart" 0
7. NC
  - Clears interface "warm restart terminated" 0
8. Warm restart function terminated, program operation can be resumed.

#### Fault response

If machine data errors are established during warm restart, the NC activates Alarms 70 to 80. In this case, the acknowledgement signal "warm restart terminated" is set. The alarm may only be cleared by means of Power On after correcting the appropriate machine data (see also Description of alarms, Section 12).

## 11.7 Axis-specific resolutions (from Software Version 3)

### 11.7.1 Corresponding data

MD 5002	bit 4 - 7	Input resolution
MD 564*	bit 5	Rotary axis
MD 1800*	bit 0 - 3	Axis-specific position control resolution
MD 1800*	bit 4 - 7	Axis-specific display resolution

Indirectly related:

MD 155	Interpolation time
MD 160 - 163	Ratio of interpolation to position control

### 11.7.2 General remarks on the axis-specific resolutions

The axes can be matched to the machine via NC MD.

It must be remembered that only specific combinations are permissible, and care must be taken that the boundaries, maximum axis speed and range limits are not exceeded.

The following types of resolution can be specified for axes:

- Input resolution: Set via MD for all axes
- Geometry resolution: Input resolution x 0.5
- Position control resolution: Set via MD for each axis
- Display resolution: Set via MD for each axis
- Measuring system resolution: Set by the measuring system for each axis

The measuring system resolution is adapted to the position control resolution using the variable increment weighting (NC MD 364\* and 368\*).

### 11.7.3 Input, display and position control resolution

#### ***Input resolution (Input System - IS)***

The input resolution for the entire control is defined in MD 5002, bits 4 to 7. The input resolution defines the geometry resolution for linear and rotary axes. Rotary axes have the same input resolution as linear axes. The geometry resolution determines the interpolation accuracy.

With the input resolution the maximum number of programmable decimal places for position values in the part program and the number of decimal places for TO, ZO, SD etc. are also defined (and therefore the maximum attainable accuracy).

The input resolution defines the units system (inch - metric - degrees).

The input resolution must be taken into account when entering machine data that must be stored in the input system. The default value for linear axes is  $10^{-3}$  and for rotary axes  $10^{-3}$  degrees.

#### ***Display resolution***

In addition to the input resolution, the user must also define the display resolution. In contrast to the input resolution, the display resolution is defined separately for each axis. NC MD 1800\*, bits 4-7, are provided for this purpose. The display resolution defines the number of decimal places of the actual position and distance to go that are to be displayed. The default value for all axes is  $10^{-3}$  mm or degrees.

The display resolution must have the same input system (inch - metric - degrees) as the input resolution. Alarm 4 (Power on Alarm) is issued to flag "Illegal input system" if this is not the case.

#### ***Position control resolution (Measuring System - MS)***

Like the display resolution, the position control resolution is defined on an axis-specific basis. This must be taken into account when entering machine data stored in the measuring system. MD 1800\*, bits 0-3, are used to define the position control resolution.

The unit system must be the same for each position control resolution.

The unit system (inch - metric - degrees) used for the position control resolution need not necessarily be identical to the one used for the input resolution.

#### ***Note:***

A position control resolution  $<10^{-3}$  degrees is only possible for rotary axes if option E50 is used.

### 11.7.4 Block diagram of the resolutions

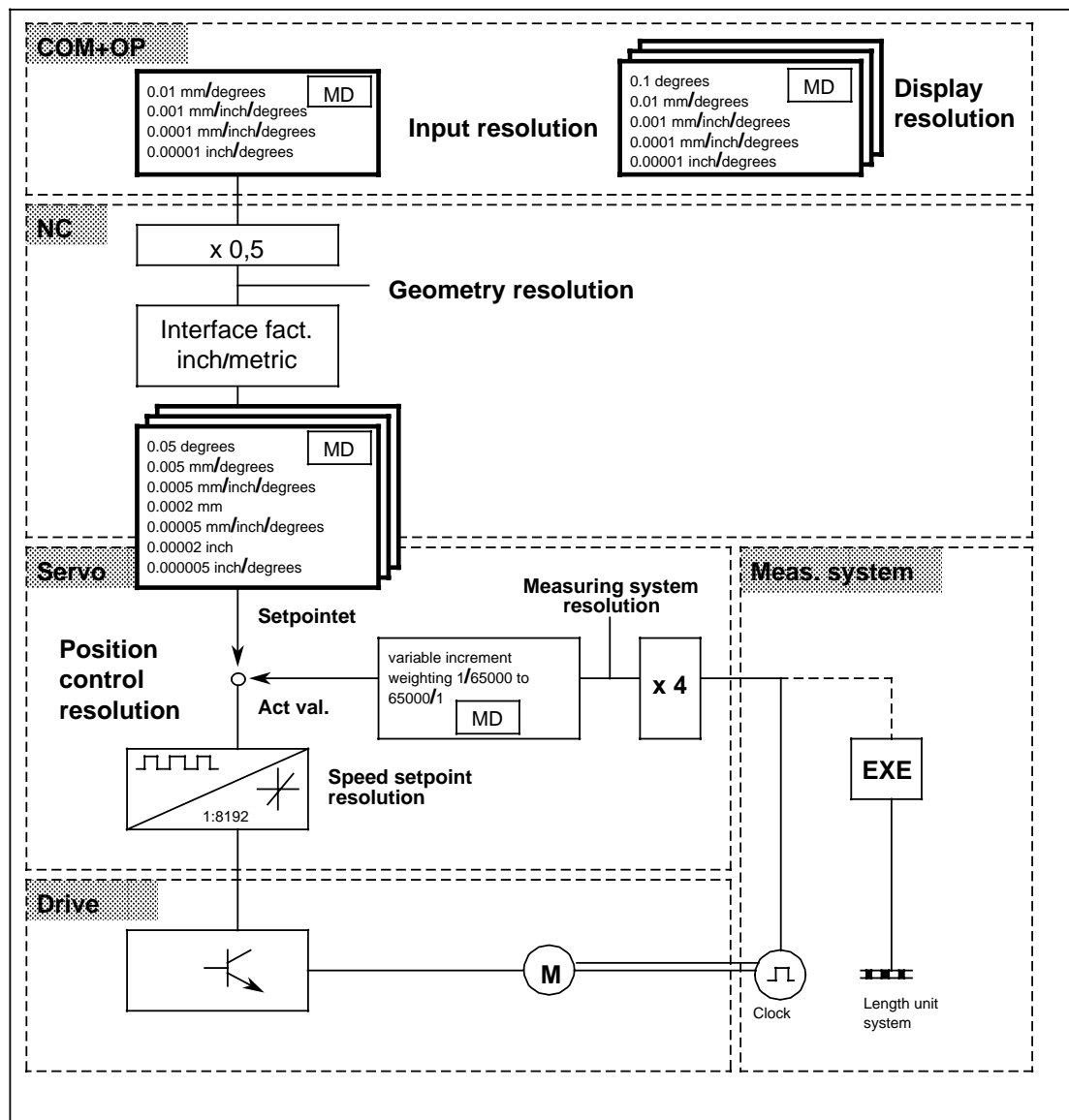

MD ..... Machine data

## 11.7.5 Resolution codes

Table shows the codes for the various types of resolution.

Alarm 4 ("Illegal input system") is issued when illegal values are entered as machine data. Bit 4 (MD 5002 bit 4) is used as unit system identifier. Metric input system G71 (bit 4 = 0) is the reset state.

**Table of resolution codes**

Bit 7	Bit 6	Bit 5	Bit 4	Input resolution			NC MD 5002	
Bit 7	Bit 6	Bit 5	Bit 4		Display resolution		NC MD 1800*	
Bit 3	Bit 2	Bit 1	Bit 0			Pos. contr. resol.	NC MD 1800*	
0	0	0	0	————	10 <sup>-1</sup> [mm] [degr.]	0.5 x 10 <sup>-1</sup> [degr.]	Metric (degrees)	
1	0	0	0	10 <sup>-2</sup> [mm] [degr.]	10 <sup>-2</sup> [mm] [degr.]	0.5 x 10 <sup>-2</sup> [degr.]		
0	1	0	0	10 <sup>-3</sup> [mm] [degr.]	10 <sup>-3</sup> [mm] [degr.]	0.5 x 10 <sup>-3</sup> [degr.]		
1	1	0	0	————	————	2 x 10 <sup>-4</sup> [degr.]		
0	0	1	0	10 <sup>-4</sup> [mm] [degr.]	10 <sup>-4</sup> [mm] [degr.]	0.5 x 10 <sup>-4</sup> [degr.]		
1	0	1	0	10 <sup>-5</sup> [mm] [degr.]	10 <sup>-5</sup> [mm] [degr.]	0.5 x 10 <sup>-5</sup> [degr.]		
0	1	1	0	————	————	————		
1	1	1	0	————	————	————		
0	0	0	1	————	10 <sup>-1</sup> [degr.]	0.5 x 10 <sup>-1</sup> [degr.]		Inch (degrees)
1	0	0	1	————	10 <sup>-2</sup> [degr.]	0.5 x 10 <sup>-2</sup> [degr.]		
0	1	0	1	10 <sup>-3</sup> [inch] [degr.]	10 <sup>-3</sup> [inch] [degr.]	0.5 x 10 <sup>-3</sup> [inch] [degr.]		
1	1	0	1	10 <sup>-4</sup> [inch] [degr.]	10 <sup>-4</sup> [inch] [degr.]	0.5 x 10 <sup>-4</sup> [inch] [degr.]		
0	0	1	1	————	————	2 x 10 <sup>-5</sup> [inch]		
1	0	1	1	10 <sup>-5</sup> [inch] [degr.]	10 <sup>-5</sup> [inch] [degr.]	0.5 x 10 <sup>-5</sup> [inch] [degr.]		
0	1	1	1	10 <sup>-6</sup> [inch] [degr.]	————	————		
1	1	1	1	————	————	————		

0 1 0 0 = standard machine data

### 11.7.6 Permissible combinations

Input resolution, display resolution and position control resolution can be freely defined within certain limits (see the following two tables). Note the between the input resolution and the position control resolution for all axes together a factor of up to 200 is possible.

**Example:** Input resolution 10<sup>-4</sup> mm or degrees  
 Position control resolution for rotary axis 0.5·10<sup>-4</sup> degrees  
 Position control resolution for machining axes 0.5·10<sup>-3</sup> mm  
 Position control resolution for loader axes 0.5·10<sup>-3</sup> mm

#### Valid combinations of position control resolution and input resolution

Unit system	Position control resolution	Input resolution							
		10 <sup>-2</sup> [mm] [degr.]	10 <sup>-3</sup> [mm] [degr.]	10 <sup>-4</sup> [mm] [degr.]	10 <sup>-5</sup> [mm] [degr.]	10 <sup>-3</sup> [inch] [degr.]	10 <sup>-4</sup> [inch] [degr.]	10 <sup>-5</sup> [inch] [degr.]	10 <sup>-6</sup> [inch] [degr.]
mm	0.5 x 10 <sup>-1</sup> [degr.]	y 1)	y 1)	-	-	-	-	-	-
mm	0.5 x 10 <sup>-2</sup> [mm][degr.]	xy	xy 1)	xy 1)	-	x	x	x	-
mm	0.5 x 10 <sup>-3</sup> [mm][degr.]	xy	xy 2)	xy 1)	-	x	x	x	-
mm	2 x 10 <sup>-4</sup> [mm]	x	x	x	x	-	-	x	x
mm	0.5 x 10 <sup>-4</sup> [mm][degr.]	xy	xy	xy	xy 1)	-	-	x	x
mm	0.5 x 10 <sup>-5</sup> [degr.]	y	y	y	y	-	-	-	-
inch	0.5 x 10 <sup>-1</sup> [degr.]	-	-	-	-	y 1)	-	-	-
inch	0.5 x 10 <sup>-2</sup> [degr.]	-	-	-	-	y 1)	y 1)	-	-
inch	0.5 x 10 <sup>-3</sup> [inch][degr.]	x	x	-	-	xy	xy 1)	x	-
inch	0.5 x 10 <sup>-4</sup> [inch][degr.]	x	x	-	-	xy	xy	xy 1)	-
inch	2 x 10 <sup>-5</sup> [inch]	x	x	x	x	x	x	x	x
inch	0.5 x 10 <sup>-5</sup> [inch][degr.]	x	x	x	x	xy	xy	xy	xy 1)

- x ... Linear axes only
- y ... Rotary axes only
- xy ... Linear and rotary axes
- ... Linear axes and rotary axes not permitted
- 1) ... Not for rotary axes (NC MD 572\* bit 2 = 0)
- 2) ... Standard machine data



**Permissible combinations of position control resolution and display resolution**

Unit system	Position control resolution	Display resolution									
		mm					inch				
		10 <sup>-1</sup>	10 <sup>-2</sup>	10 <sup>-3</sup>	10 <sup>-4</sup>	10 <sup>-5</sup>	10 <sup>-1</sup>	10 <sup>-2</sup>	10 <sup>-3</sup>	10 <sup>-4</sup>	10 <sup>-5</sup>
mm	0.5 x 10 <sup>-1</sup> [degr.]	xy	-	-	-	-	-	-	-	-	-
mm	0.5 x 10 <sup>-2</sup> [mm][degr.]	-	xy	-	-	-	-	-	x	-	-
mm	0.5 x 10 <sup>-3</sup> [mm][degr.]	-	-	xy	-	-	-	-	-	x	-
mm	2 x 10 <sup>-4</sup> [mm]	-	-	xy	xy	-	-	-	-	-	x
mm	0.5 x 10 <sup>-4</sup> [mm][degr.]	-	-	-	xy	-	-	-	-	-	x
mm	0.5 x 10 <sup>-5</sup> [degr.]	-	-	-	-	xy	-	-	-	-	-
inch	0.5 x 10 <sup>-1</sup> [degr.]	-	-	-	-	-	xy	-	-	-	-
inch	0.5 x 10 <sup>-2</sup> [degr.]	-	-	-	-	-	-	xy	-	-	-
inch	0.5 x 10 <sup>-3</sup> [inch][degr.]	-	x	-	-	-	-	-	xy	-	-
inch	0.5 x 10 <sup>-4</sup> [inch][degr.]	-	x	-	-	-	-	-	-	xy	-
inch	2 x 10 <sup>-5</sup> [inch]	-	-	x	-	-	-	-	-	xy	xy
inch	0.5 x 10 <sup>-5</sup> [inch][degr.]	-	-	x	-	-	-	-	-	-	xy

xy ... Permissible for both linear and rotary axes  
x ... Permissible for linear axes only  
- ... Illegal

**Caution:**

The display resolution must have the same system (inch-metric-degree) as the input resolution.

### 11.7.7 The influence of resolution on speed

The input resolution determines not only the path resolution, but also the lowest programmable speed. The lowest programmable speed is always 10 times coarser than the path resolution. For example, if the input resolution is  $10^{-4}$ , the lowest programmable speed is then  $10^{-3}$  mm/min. Depending on the unit system used, the feedrate is interpreted either in mm/min or in inches/min. If one of the interpolating axes is a rotary axis, the corresponding axial feedrate is interpreted as degrees/min.

When rotational feedrate G95 is used, the feedrate is interpreted in either mm/revolution, inches/revolution or degrees/revolution. When the feedrate is rotational, the lowest programmable speed is identical to the path resolution (for instance, for an input resolution of  $10^{-4}$ , the lowest programmable speed for G95 would be  $10^{-4}$  mm/revolution).

Input resolution	Min. programmed path speed
$10^{-2}$ mm, degr.	0.1 mm/min, degr./min
$10^{-3}$ mm, degr.	0.01 mm/min, degr./min
$10^{-4}$ mm, degr.	0.001 mm/min, degr./min
$10^{-5}$ mm, degr.	0.0001 mm/min, degr./min
$10^{-3}$ inch, degr.	0.01 inch/min, degr./min
$10^{-4}$ inch, degr.	0.001 inch/min, degr./min
$10^{-5}$ inch, degr.	0.0001 inch/min, degr./min
$10^{-6}$ inch, degr.	0.00001 inch/min, degr./min

The input resolution also defines the maximum path speed (**not** the axis speed).

Input resolution	Max. path speed
$10^{-2}$ mm, degr.	1000 m/min, 2700 1/min
$10^{-3}$ mm, degr.	1000 m/min, 27000 1/min
$10^{-4}$ mm, degr.	1000 m/min, 27000 1/min
$10^{-5}$ mm, degr.	100 m/min, 2700 1/min
$10^{-3}$ inch, degr.	10000 inch/min, 27000 1/min
$10^{-4}$ inch, degr.	10000 inch/min, 27000 1/min
$10^{-5}$ inch, degr.	1000 inch/min, 2700 1/min
$10^{-6}$ inch, degr.	100 inch/min, 270 1/min

The position control resolution together with the interpolation time defines the max. axis speed (**not** path speed).

<b>Max. axis speed for linear axes in m/min or inches/min</b> for a position control resolution of								
Inter- polation time in [ms]	$0.5 \cdot 10^{-2}$ mm	$0.5 \cdot 10^{-3}$ mm	$2 \cdot 10^{-4}$ mm	$0.5 \cdot 10^{-4}$ mm	$0.5 \cdot 10^{-3}$ inch	$0.5 \cdot 10^{-4}$ inch	$2 \cdot 10^{-5}$ inch	$0.5 \cdot 10^{-5}$ inch
10	980	98	39	9.8	98000	9800	3900	980
12	810	81	32	8.1	81000	8100	3200	810
14	700	70	28	7.0	70000	7000	2800	700
16	610	61	24	6.1	61000	6100	2400	610
18	540	54	21	5.4	54000	5400	2100	540
20	490	49	19	4.9	49000	4900	1900	490
22	440	44	17	4.4	44000	4400	1700	440
24	400	40	16	4.0	40000	4000	1600	400
26	370	37	15	3.7	37000	3700	1500	370
28	350	35	14	3.5	35000	3500	1400	350
30	320	32	13	3.2	32000	3200	1300	320

## 11.7.7 The influence of resolution on speed

<b>Max. axis speed for rotary axes in [degrees/min] or [rev/min] for a position control resolution of</b>					
Inter- polation time in [ms]	0.5 x 10 <sup>-1</sup> degr.	0.5 x 10 <sup>-2</sup> degr.	0.5 x 10 <sup>-3</sup> degr.	0.5 x 10 <sup>-4</sup> degr.	0.5 x 10 <sup>-5</sup> degr.
10	9800000 degr./min 27000 1/min	980000 degr./min 2700 1/min	98000 degr./min 270 1/min	9800 degr./min 27 1/min	980 degr./min 2.7 1/min
12	8100000 degr./min 22000 1/min	810000 degr./min 2200 1/min	81000 degr./min 220 1/min	8100 degr./min 22 1/min	810 degr./min 2.2 1/min
14	7000000 degr./min 19000 1/min	700000 degr./min 1900 1/min	70000 degr./min 190 1/min	7000 degr./min 19 1/min	700 degr./min 1.9 1/min
16	6100000 degr./min 17000 1/min	610000 degr./min 1700 1/min	61000 degr./min 170 1/min	6100 degr./min 17 1/min	610 degr./min 1.7 1/min
18	5400000 degr./min 15000 1/min	540000 degr./min 1500 1/min	54000 degr./min 150 1/min	5400 degr./min 15 1/min	540 degr./min 1.5 1/min
20	4900000 degr./min 13000 1/min	490000 degr./min 1300 1/min	49000 degr./min 130 1/min	4900 degr./min 13 1/min	490 degr./min 1.3 1/min
22	4400000 degr./min 12000 1/min	440000 degr./min 1200 1/min	44000 degr./min 120 1/min	4400 degr./min 12 1/min	440 degr./min 1.2 1/min
24	4000000 degr./min 11000 1/min	400000 degr./min 1100 1/min	40000 degr./min 110 1/min	4000 degr./min 11 1/min	400 degr./min 1.1 1/min
26	3700000 degr./min 10000 1/min	370000 degr./min 1000 1/min	37000 degr./min 100 1/min	37000 degr./min 10 1/min	370 degr./min 1 1/min
28	3500000 degr./min 9500 1/min	350000 degr./min 950 1/min	35000 degr./min 95 1/min	3500 degr./min 9.5 1/min	350 degr./min 0.95 1/min
30	3200000 degr./min 9000 1/min	320000 degr./min 900 1/min	32000 degr./min 90 1/min	3200 degr./min 9 1/min	320 degr./min 0.9 1/min

The maximum path speed (defined by the input resolution) and the maximum axis speed (defined by the axis-specific position control resolution) together define the maximum speeds.

The interpolator breaks the tool path down into the associated axis-specific speed components (axis speeds). These values are then converted into position control resolution. Conversion is possible, however, only when the relevant maximum speeds (Table) and their correlation to interpolation are observed during programming. Alarm 2038, i.e. "Tool path too high" (Reset alarm) is issued if the speed is not possible. The alarm inhibits processing and NC start.

In order to enable programming of high feedrate values in mm/min, a maximum of 999 999 mm/min can be programmed in the part program. Nine decades (including decimal places) are provided for this purpose.

Setting data item "Dry run feedrate" is still entered in 1000 IS units/min. As many as 5 digits can be displayed and entered via keyboard. (For example, input resolution  $10^{-4}$  mm -> dry run feedrate 9.999 m/min).

Alarm 3040 ("Field/variable cannot be displayed") is issued if more than 5 digits are programmed via the CL 800 command "SEN" or the @ 410 command.

### 11.7.8 Maximum speed for thread cutting

In the case of threading blocks G33, G34 and G35, the feedrate is computed from the spindle speed and the pitch rather than being based on the programmed (linear) feedrate. This feedrate determines the tool path feedrate for the threading block.

#### Constant-pitch thread cutting (G33)

For this type of threading, the tool path feedrate may not exceed the following limiting values.

Input resolution:	10 <sup>-2</sup> mm	:	<	1000	m/min
	10 <sup>-3</sup> mm	:	<	1000	m/min
	10 <sup>-4</sup> mm	:	<	1000	m/min
	10 <sup>-5</sup> mm	:	<	100	m/min

In addition to the maximum tool path feedrate, the maximum axis speed must also be taken into account when programming threading blocks (see tables in Section 11.7.7).

#### Variable-pitch thread cutting (G34/G35)

The valid limiting values must be observed for this type of thread. This applies to tool path feedrate, axis speed, pitch and spindle speed (see Programming Manual).

## 11.7.9 Maximum traverse range

The set combination of input resolution and axis specific position control resolution determines the max. traverse range (for every axis separately). This maximum traverse range applies to the max. path between the two axis movements and for the max. programmable value for axis positions, interpolation parameters, chamfer, radius, etc.

The values defined as working area limitation (setting data 300\*, 304\*) must lie within the area boundaries. Alarm 3084 ("Invalid working area limitation") is issued if one of these values is not in range. In addition, the control enters the highest or lowest permissible value in SD "working area limitation".

In addition to the working area limitation, the software limit switches (MD 224\*, 228\*, 232\*, 236\*) and the pre-limit switches (MD 1100\*) are also checked for validity. Alarm 87 ("Invalid software limit switch") is issued if impermissible values are detected. The validity check is carried out without regard to MD 556\* bit 5 ("Working area limitation, software limit switches in force").

In order to prevent the working area from being exceeded, the absolute position is compared with the limiting values. This comparison is necessary only when the software limit switches/working area limitation are not active, as exiting of the traversing range is otherwise impossible. This check is not carried out for rotary axes.

Alarm 1204\* ("Traversing limit") (Reset alarm) is issued when a limit violation is detected. The alarm is issued for limit violations in both directions of travel. The same reaction is initiated when the working field bounds are violated, i.e. withdrawal is possible in the reverse direction only. The alarm is not issued until the traversing limit is exceeded. The relevant axes are then abruptly braked (no deceleration ramp).

In the case of endless revolving rotary axes, the traversing range can be legally exceeded when a permissible combination of input resolution and position control resolution was defined. Impermissible combinations of input resolution and position control resolution will result in a malfunction (when the traversing limit is exceeded).

Unit system	Position control resolution	Input resolution			
		10 <sup>-2</sup> [mm] [degr.]	10 <sup>-3</sup> [mm] [degr.]	10 <sup>-4</sup> [mm] [degr.]	10 <sup>-5</sup> [mm] [degr.]
inch	0.5*10 <sup>-1</sup> [degr.]	-- -- --	-- -- --	-- -- --	-- -- --
inch	0.5*10 <sup>-2</sup> [degr.]	-- -- --	-- -- --	-- -- --	-- -- --
inch	0.5*10 <sup>-3</sup> [inch] [degr.]	±99999.99 mm ±3937.007 inch --	±99999.999 mm ±3937.0078 inch --	-- -- --	-- -- --
inch	0.5*10 <sup>-4</sup> [inch] [degr.]	±99999.99 mm ±393.007 inch --	±9999.999 mm ±393.0078 inch --	-- -- --	-- -- --
inch	2*10 <sup>-5</sup> [inch]	±25399.99 mm ±999.999 inch --	±25399.999 mm ±999.9999 inch --	±25399.999 mm ±999.9999 inch --	±9999.9999 mm ±421.99999 inch --
inch	0.5*10 <sup>-5</sup> [inch] [degr.]	±25399.99 mm ±999.999 inch --	±25399.999 mm ±999.9999 inch --	±25399.999 mm ±999.99999 inch --	±9999.9999 mm ±421.99999 inch --

Input system	Position control resolution	Input resolution			
		10 <sup>-3</sup> [inch] [degr.]	10 <sup>-4</sup> [inch] [degr.]	10 <sup>-5</sup> [inch] [degr.]	10 <sup>-6</sup> [inch] [degr.]
mm	0.5*10 <sup>-1</sup> [degr.]	-- -- ±99999.9 degr.	-- -- --	-- -- --	-- -- --
mm	0.5*10 <sup>-2</sup> [degr.]	-- -- ±999999.99 degr.	-- -- ±99999.99 degr.	-- -- --	-- -- --
mm	0.5*10 <sup>-3</sup> [inch] [degr.]	±253999.99 mm ±9999.999 inch ±99999.999 degr.	±253999.99 mm ±9999.999 inch ±99999.999 degr.	±107374.18 mm ±9999.999 inch --	-- -- --
mm	0.5*10 <sup>-4</sup> [inch] [degr.]	±253999.99 mm ±9999.999 inch ±9999.999 degr.	±253999.99 mm ±9999.9999 inch ±9999.9999 degr.	±107374.18 mm ±9999.999 inch ±9999.999 inch	-- -- --
mm	2*10 <sup>-5</sup> [inch]	±25399.99 mm ±999.999 inch --	±25399.99 mm ±999.9999 inch --	±25399.99 mm ±999.99999 inch --	±10737.418 mm ±999.99999 inch --
mm	0.5*10 <sup>-5</sup> [inch] [degr.]	±25399.99 mm ±999.999 inch ±999.999 degr.	±25399.999 mm ±999.9999 inch ±999.9999 degr.	±25399.999 mm ±999.99999 inch ±999.99999 degr.	±10737.418 mm ±999.99999 inch ±999.99999 degr.

± 99999.999 mm  
± 3837.0078 inch  
± 99999.999 degr.

Max. traverse range for linear axes in [mm]

Max. traverse range for linear axes in [inch]

Max. traverse range for rotary axes in [degrees] (with NC MD 572\* bit 2=0)

11.7.9 Maximum traverse range

Unit system	Position control resolution	Input resolution			
		10 <sup>-2</sup> [mm] [degr.]	10 <sup>-3</sup> [mm] [degr.]	10 <sup>-4</sup> [mm] [degr.]	10 <sup>-5</sup> [mm] [degr.]
mm	0.5·10 <sup>-1</sup> [degr.]	-- -- ±999999.9 degr.	-- -- ±999999.9 degr.	-- -- --	-- -- --
mm	0.5·10 <sup>-2</sup> [mm] [degr.]	±99999.99 mm ±3937.007 inch ±99999.99 degr.	±99999.99 mm ±3937.007 inch ±99999.99 degr.	±99999.99 mm ±3937.007 inch ±99999.99 degr.	-- -- --
mm	0.5·10 <sup>-3</sup> [mm] [degr.]	±99999.99 mm ±3937.007 inch ±99999.99 degr.	±99999.999 mm ±3937.0078 inch ±99999.999 degr.	±99999.999 mm ±3937.0078 inch ±99999.999 degr.	-- -- --
mm	2·10 <sup>-4</sup> [mm]	±9999.99 mm ±393.700 inch --	±9999.999 mm ±393.7007 inch --	±9999.9999 mm ±393.70078 inch --	±9999.9999 mm ±393.70078 inch --
mm	0.5·10 <sup>-4</sup> [mm] [degr.]	±9999.99 mm ±393.700 inch ±9999.99 degr.	±9999.999 mm ±393.7007 inch ±9999.999 degr.	±9999.9999 mm ±393.70078 inch ±9999.9999 degr.	±9999.9999 mm ±393.70078 inch ±9999.9999 degr.
mm	0.5·10 <sup>-5</sup> [degr.]	-- -- ±999.99 degr.	-- -- ±999.999 degr.	-- -- ±999.9999 degr.	-- -- ±999.99999 degr.

Unit system	Position control resolution	Input resolution			
		10 <sup>-3</sup> [inch] [degr.]	10 <sup>-4</sup> [inch] [degr.]	10 <sup>-5</sup> [inch] [degr.]	10 <sup>-6</sup> [inch] [degr.]
mm	0.5·10 <sup>-1</sup> [degr.]	-- -- --	-- -- --	-- -- --	-- -- --
mm	0.5·10 <sup>-2</sup> [mm] [degr.]	±99999.99 mm ±3937.007 inch --	±99999.99 mm ±3937.007 inch --	±99999.99 mm ±3937.007 inch --	-- -- --
mm	0.5·10 <sup>-3</sup> [mm] [degr.]	±99999.999 mm ±3937.0078 inch	±99999.999 mm ±3937.0078 inch	±99999.999 mm ±3937.0078 inch --	-- -- --
mm	2·10 <sup>-4</sup> [mm]	-- -- --	-- -- --	±9999.9999 mm ±393.70078 inch --	±9999.9999 mm ±393.70078 inch --
mm	0.5·10 <sup>-4</sup> [mm] [degr.]	-- -- --	-- -- --	±9999.9999 mm ±393.70078 inch --	±9999.9999 mm ±393.70078 inch --
mm	0.5·10 <sup>-5</sup> [degr.]	-- -- --	-- -- --	-- -- --	-- -- --

± 99999.999 mm	Max. traverse range for linear axes in [mm]
± 3937.0078 inch	Max. traverse range for linear axes in [inch]
± 99999.999 degr.	Max. traverse range for rotary axes in [degrees] (with NC MD 572* bit 2=0)



## 11.7.10 Influence on the display

### *Operator display*

The axis position is displayed with the relevant, axis-specific number of decimal places. No distinction is made between linear and rotary axes when defining the number of decimal places.

The values for zero offset, working area limitation and scale are displayed in the input resolution. If this is not possible, decimal places are truncated in order to enable the display of the entire integer portion of the value.

Rotary axis values can be displayed as absolute or modulo values (depending on NC MD 560\* bit 7).

### *Service display*

The service display shows the absolute position in units of position control resolution. When viewing this display, it must be noted that the significance of the last decade depends on the axis-specific position control resolution.

With an endlessly turning rotary axis (NC MD 572\* bit 2 = 0) when the 32 bit limit has been reached (1073741.824 degrees = 2982.61 resolutions with resolution  $10^{-3}$  degrees) an offset calculation is performed so that the service display jumps from the maximum positive value to the maximum negative value plus the offset.

## 11.7.11 Influence on the modes/function

### *"Increment" mode*

In "increment" mode, the machine travels at the specified incremental speed. The feedrate is specified via machine data. the increment is derived from the mode (NC) 1, 10, 100, 1000, 10000) and from the display resolution of the relevant axis.

The table below shows the traverse path in mm, inches or degrees in dependence on the display resolution and the mode.

Increment \ Display resolution	Millimeters / Degrees / Inches				
	10 <sup>-1</sup> [degr.]	10 <sup>-2</sup> [mm] [degr.]	10 <sup>-3</sup> [mm] [degr.] [inch]	10 <sup>-4</sup> [mm] [degr.] [inch]	10 <sup>-5</sup> [degr.] [inch]
INC 1	0.1	0.01	0.001	0.0001	0.00001
INC 10	1	0.1	0.01	0.001	0.0001
INC 100	10	1	0.1	0.01	0.001
INC 1000	100	10	1	0.1	0.01
INC 10000	1000	100	10	1	0.1

### **"DRF" function**

In "DRF" mode, the handwheel pulses are also weighted with the display resolution of the selected axis. If the input resolution is coarser than the position control resolution (e.g. input resolution  $10^{-2}$  mm, position control resolution  $0,5 \cdot 10^{-3}$ ) no DRF is possible.

### **"PRESET" function**

The "Preset" mode can be used to shift control zero to an arbitrary point in the machine coordinate system. The Preset offset may comprise no more than 8 decades (plus sign). An alarm is issued if more than 8 decades are entered.

The following value ranges must be observed when specifying a Preset value for rotary axes.

Input resolution	Value range
$10^{-2}$ grad	0 ... 359.99
$10^{-3}$ grad	0 ... 359.999
$10^{-4}$ grad	0 ... 359.9999
$10^{-5}$ grad	0 ... 359.99999
$10^{-6}$ grad	0 ... 359.999999

### **"PLAY BACK" function**

In this mode, position values approached in jog mode are taken over into the part program. The input resolution determines the number of decimal places with which the coordinate values are transferred to the part program. The number of decimal places is identical for all axes, and is independent of the display or position control resolution. As many as 8 decades can be transferred as position value to the part program. Where applicable, decimal places are not transferred to the part program.

## 11.8 Data Protection

### 11.8.1 Data areas

The following data areas are battery-backed:

- NC machine data
- IAR machine data
- Cycle machine data
- Cycle setting data
- PLC machine data
- Setting data
- Main programs
- Subroutines
- USM data (RAM)
- Tool offsets
- Zero offsets
- R parameters

PLC data (RAM on PLC CPU):

- Data blocks
- User program (which is normally in EPROM)

The following may result in a loss of data:

- Battery failure or replacing of the battery with the control switched off
- Connection between battery and CPUs open
- NC CPU defective or disconnected (NC data)
- PLC CPU defective or disconnected (PLC data)
- COM CPU removed

The data must be backed up as soon as all installation procedures have been completed (e.g. on floppy disk or punched tape). Particular care must be taken as regards the backup of machine data.

## 11.8.2 Data backup with the programmer

### 11.8.2.1 Introduction

Using the PG 675, PG 685 or PG 750 and the appropriate TRANS-PGIN/PCIN software, all data and programs of the SINUMERIK 880 can be input and output via the V.24 (RS 232 C) interface. Part programs can be developed and documented using the ED, WordStar or VEDIT editor.

This section describes the operating sequence on the SINUMERIK 880, data handling using the PG 675, PG 685 or PG 750 with the appropriate operating system and TRANS-PGIN/PCIN.

The assignment of operating systems to programmers and the order numbers of the appropriate TRANS-PGIN/PCIN software are shown in the following table:

Programmer	Operating system	Interface	Order No. of German Trans-PGIN/PCIN	Order No. of English Trans-PGIN/PCIN
PG 635	PCP/M	Printer	6FC3 981 - 7AM	6FC3 981 - 7BM
PG 675	CP/M	Printer	6FC3 981 - 7AJ	6FC3 981 - 7BJ
PG 685	PCP/M-86	Printer	6FC3 981 - 7AL	6FC3 981 - 7BL
PC 16-11	PCP/M-86	Printer	6FC3 981 - 7AK	6FC3 981 - 7BK
PG 685	MS-DOS 2.11	Printer	6FC3 981 - 7AP	6FC3 981 - 7BP
PC 16-20	MS-DOS 3.1	COM 1	6FC3 981 - 7AN	6FC3 981 - 7BN
PG 750	MS-DOS 3.2	COM 2	6FC3 981 - 7AN	6FC3 981 - 7BN
PC 32-05	MS-DOS 3.2	COM 3	6FC3 981 - 7AR	6FC3 981 - 7BR
PCIN version 2.0 with operator guidance				
PG 730	PCP/M	AUX0 / AUX1	6FC3 981 - 7CA 00*	
PG 750	PCP/M	AUX0 / AUX1	6FC3 981 - 7CA 00*	
PG 730	MS-DOS	COM1 - COM4**	6FC3 981 - 7CB 00*	
PG 750	MS-DOS	COM1 - COM4**	6FC3 981 - 7CB 00*	
PCs	MS-DOS	COM1 - COM4**	6FC3 981 - 7CB 00*	

\* In several languages (English, German, French, Italian, Spanish)

\*\* The number of COMs depends on the configuration of the programmer

### 11.8.2.2 Using diskettes

The operating system is loaded immediately after the programmer is switched on.

PG 675: CP/M-86: The operating system is loaded from the system diskette inserted in drive A:.

PG 685: PCP/M-86:

PG 750: MS-DOS 3.10: The operating system is loaded from the hard disk. However, if there is a diskette in drive A:, the programmer will try to load the operating system from it.



Prompt: Volume label  
(11 characters, ENTER for none)

After you have entered the volume label and/or pressed the RETURN key, a prompt asks whether you wish to format another diskette. Enter N for "no" and press return key to leave the formatting function.

### Copying diskettes

For safety reasons it is always advisable to make two diskettes (one working diskette and one backup copy).

#### PG 675: CP/M-86

You can copy diskettes with the program **COPYDISK**.

Call: A> **COPYDISK** Return key

Response: CP/M86 FULL DISK COPY Utility  
Version 2.0  
Enter Source Disk (A-D) ?

Input: A(B) (source drive)

Response: Destination Disk Drive (A-D) ?

Input: B(A) (destination drive)

Response: Copying Disk A(B): to Disk B(A):  
Is this what you want to do (Y/N)?

Input: Y or N (Yes/No )  
When Y has been entered the system starts the copying routine  
and A(B) is copied to B(A).

After the routine has finished a prompt asks whether you wish to copy another diskette. Enter N for "no" and press return key to leave the copying function.

#### PG 685: PCP/M-86

You can copy diskettes with the program **DSKMAINT**.

Call: B> **DSKMAINT** Return key

The main menu of this program appears on the screen. Press **f3** to select copying. Press **f1** twice to select both the source and the destination drives (there is only one drive).

Response: Copying from diskette in drive A:  
to diskette in drive A:  
This operation will erase all data on drive A:  
Is this what you want? (Yes/No)

Input: Y or N (Yes/No)

Response: Copying from diskette in drive A:  
to diskette in drive A:  
INSERT SOURCE DISKETTE AND PRESS ANY KEY

Insert the diskette to be copied and press any key.

Response: Copying from diskette in drive A:  
to diskette in drive A:  
INSERT DESTINATION DISKETTE AND PRESS ANY KEY

Insert an empty diskette and press any key.

The diskette is copied in several parts. The diskette to be copied (source) and the empty diskette (destination) must therefore be inserted one after the other several times. When copying is complete a prompt asks whether you wish to copy another diskette. Press **f8** to leave the copying function and return to the main menu.

### **PG 750: MS-DOS 3.10**

You can copy diskettes with the program **DISKCOPY**.

Call: C> **DISKCOPY A: B:** Return key

Response: Insert SOURCE diskette into drive A:  
Insert TARGET diskette into drive B:  
Press any key when ready.

Insert the diskette to be copied into the source drive A: and a formatted empty diskette into the target drive B:. When you press any key the program starts copying.

After the routine has finished, a prompt asks whether you wish to copy another diskette. Enter N for "no" and press return key to leave the copying function.

#### **Note:**

If you only have one drive it is both the source and the target drive while copying. In this case, the diskette is copied in several parts. The diskette to be copied (source) and the empty diskette (target) must therefore be inserted one after the other several times.

#### **Changing diskettes**

In the PG 675, every time a diskette is changed, the newly inserted diskette must be announced with CTRL C if you are going to write to it. If you do not do this, edited files cannot be stored because changing diskettes activates a write protection (message: Bdos Error R/O).

In the PG 685 and PG 750 you do not need to announce a newly inserted diskette with CTRL C after a diskette change in order to be able to write to it.

## Listing the directory

With the following functions the hard disk or diskette directory can be listed on the screen or printed out (hardcopy key) and the diskette status can be checked.

### PG 675: CP/ M-86

Call: A> **DIR** **Return key**  
or A> **DIR B:** **Return key**

The files on the diskette in drive A: or B: are listed without any indication of their size.

Call: A> **STAT \*.\*** **Return key**  
or A> **STAT B:.\*** **Return key**

The files are listed with an indication of the size of each as well as the total memory occupied and the free space on the diskette. The diskette status "RW" (READ/WRITE) or "RO" (READ ONLY) is also given. An empty diskette contains 340 Kbytes.

### PG 685: PCP/M-86

Call: B> **DIR** **Return key**  
or B> **DIRS** **Return key**  
or B> **DIR A:** **Return key**  
or B> **DIRS A:** **Return key**

The files stored on the hard disk or on the diskette in drive A: are listed without any indication of their size. With the DIR command the names of files with the DIR attribute are listed. Files with the SYS attribute are listed with the DIRS command.

Call: B> **DIR [SIZE]** **Return key**  
or B> **DIR A: [SIZE]** **Return key**

The files are listed with an indication of the size of each as well as the total memory occupied on the hard disk or the diskette in drive A:.

Call: B> **SHOW** **Return key**  
or B> **SHOW A:** **Return key**

Response: e.g. A: RW, free space 84K

You can display the free space on the hard disk or diskette with the command SHOW. The status "RW" (READ/WRITE) or "RO" (READ ONLY) is also shown. An empty diskette contains 694 Kbytes.



**PG 750: MS-DOS 3.10**

Call: B(C)> **DIR [/p] [/w]**                      **Return key**  
       or B(C)> **DIR A(B): [/p] [/w]**                **Return key**

The files stored in the current directory of the hard disk or on the diskette in drive A(B) are listed. For every file the size in bytes, the date and the time of last processing are specified. The free space and the number of files in the directory are also displayed.

An empty diskette for the PG 750 contains 1.2 MB or 360 KB.

The DIR command has two options:

The /p option activates page mode. Output of the directory is delayed after each screen page until any key is pressed.

The /w option activates the wide display in which the file designations are output without additional information. Five files are displayed per line.

**11.8.2.3 File handling**

Files are stored on diskette or hard disk. They are addressed via their file designations.

The full file designation consists of three parts:

1. Name of the drive
2. File name
3. Extension

Example: B> **VEDIT A:TESTPROG.SY8**

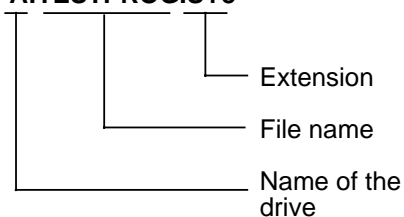

The file name consists of 1 to 8 characters. The file name is separated from the extension by a full stop. The extension consists of 1 to 3 characters. The file name and the extension can be freely selected. They can contain any characters except certain special characters (see the User's Guide to the operating system of your programmer).

The drive name is always placed in front of the file name when the file addressed is not on the current drive. If the file is on the current drive the name of the drive is not required.

## Listing files

The command file TYPE is used to display the contents of any file on the screen. The command makes it easier to verify the contents of a file because you do not need to run an editor.

**TYPE <drive>:<file designation>**                      **Return key**

Example: **TYPE A:PC.DOK**

If the file is large you can stop the screen and restart it.

PG 675: CP/M-86 stop with CTRL S, restart with CTRL Q

PG 685: PCP/M-86 stop with CTRL S, restart with CTRL W

On the PG 750 you can display the file page by page if you use the following call:

TYPE <drive> : <file designation> | More                      **Return key**

Example: TYPE A: PC.DOK | More

## Copying files

You can copy files with the command file PIP or Copy.

- Copy keeping the old name

PG 675: CP/M-86

A>PIP B:=A:TEST.880

copy from A: to B:

A>PIP A:=B:TEST.880

copy from B: to A:

PG 685: PCP/M-86

B>PIP B:=A:TEST.880

copy from A: to hard disk

B>PIP A:=B:TEST.880

copy from hard disk to A:

PG 750: MS-DOS 3.10

C>COPY TEST.880 A:

copy from hard disk C: to drive A:

- Copy and rename

PG 675: CP/M-86

A>PIP TEXT.NEU=TEXT.ALT

on diskette in drive A:

A>PIP B: TEST.1=B:TEST0

on diskette in drive B:

PG 685: PCP/M-86

B>PIP TEXT.NEU=TEXT.ALT

on hard disk

B>PIP A:TEST.1=A:TEST0

on diskette in drive A:

PG 750: MS-DOS 3.10

C>COPY TEXT.ALT = TEXT.NEU

on hard disk

C>COPY A:ALT.TXT = A:NEU.TXT

on diskette in drive A:

- Peripheral device as the destination (NC or printer)

PG 675: CP/M-86

A>PIP LST:=B:TESTPROG.880           file on diskette in drive B:

PG 685: PCP/M-86

B>PIP LST:=A:TESTPROG.880           file on diskette in drive A:

PG 750: MS-DOS 3.10

C>COPY TESTPROG COM1           file on hard disk

C>COPY A:TESTPROG COM1           file on diskette on drive A:

Cable name : SIMATIC PG 635/PG 675/PG 685 (TRANS-PG IN)  
 Order No. : 6FC9 344-1A

**SINUMERIK 880** **PG 635/PG 675/PG 685**  
**NC / V.24 (RS 232 C)** **Connector**  
**Printer (V.24/RS 232 C)**

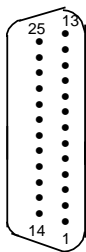
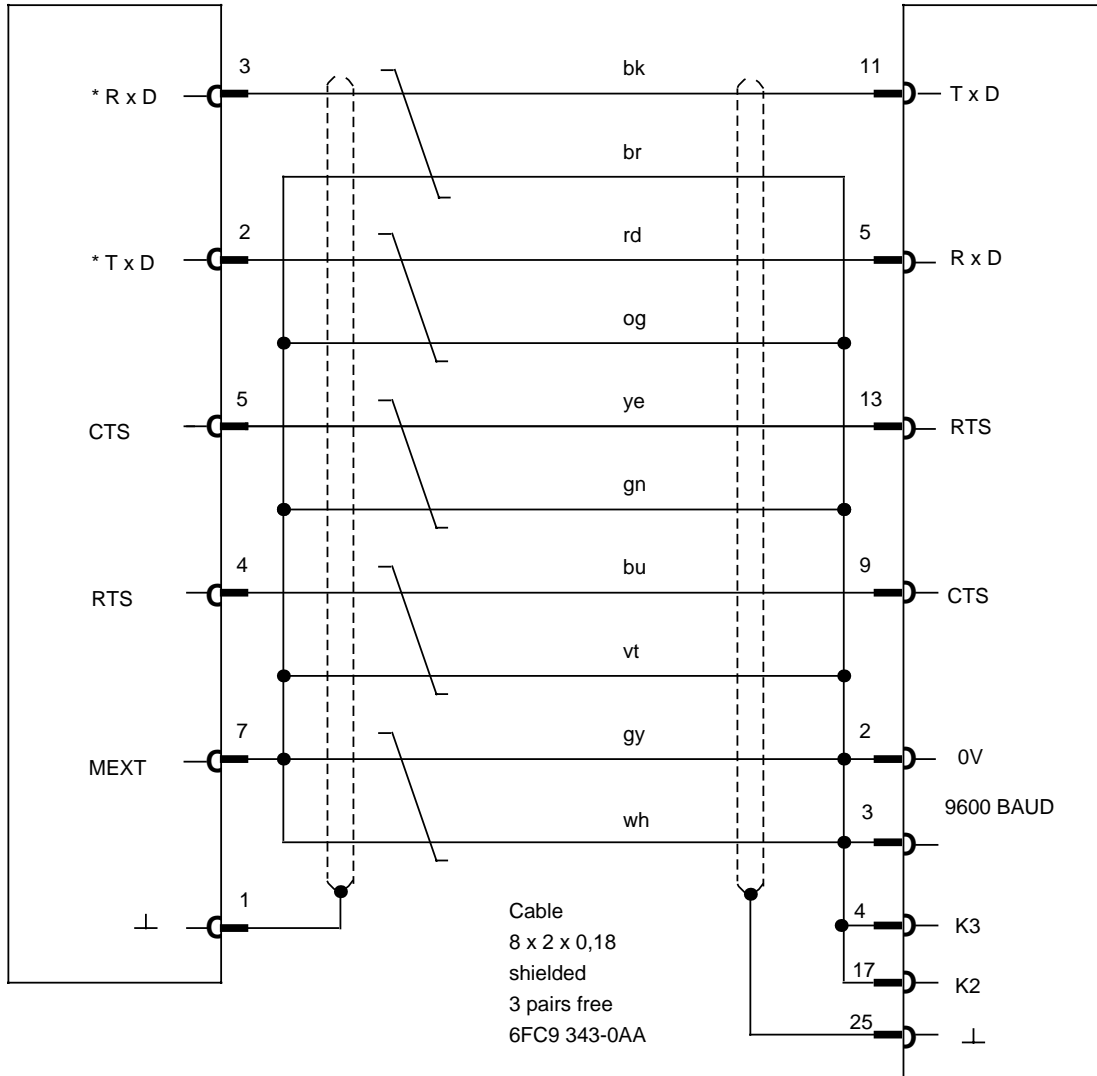

**Connector**  
 Position 1 below  
 Subminiature D  
 25-way, male  
 Connection side  
 Housing with slide  
 latch  
 6FC 9 341 - 2AA  
 Designation: NC

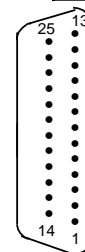

**Connector**  
 Position 1 below  
 Subminiature D  
 25-way, male  
 Connection side  
 Post Office housing  
 6FC 9 341 - 1ES  
 Designation: PG D

Cable name : SIMATIC PG 750 (TRANS PC IN and PLC programming)  
PC (AT compatible)  
Order No. : 6FC9 344-4R

**SINUMERIK 880** **PG 750**  
**NC / V.24 (RS 232 C)** **Connector**  
**COM 1**

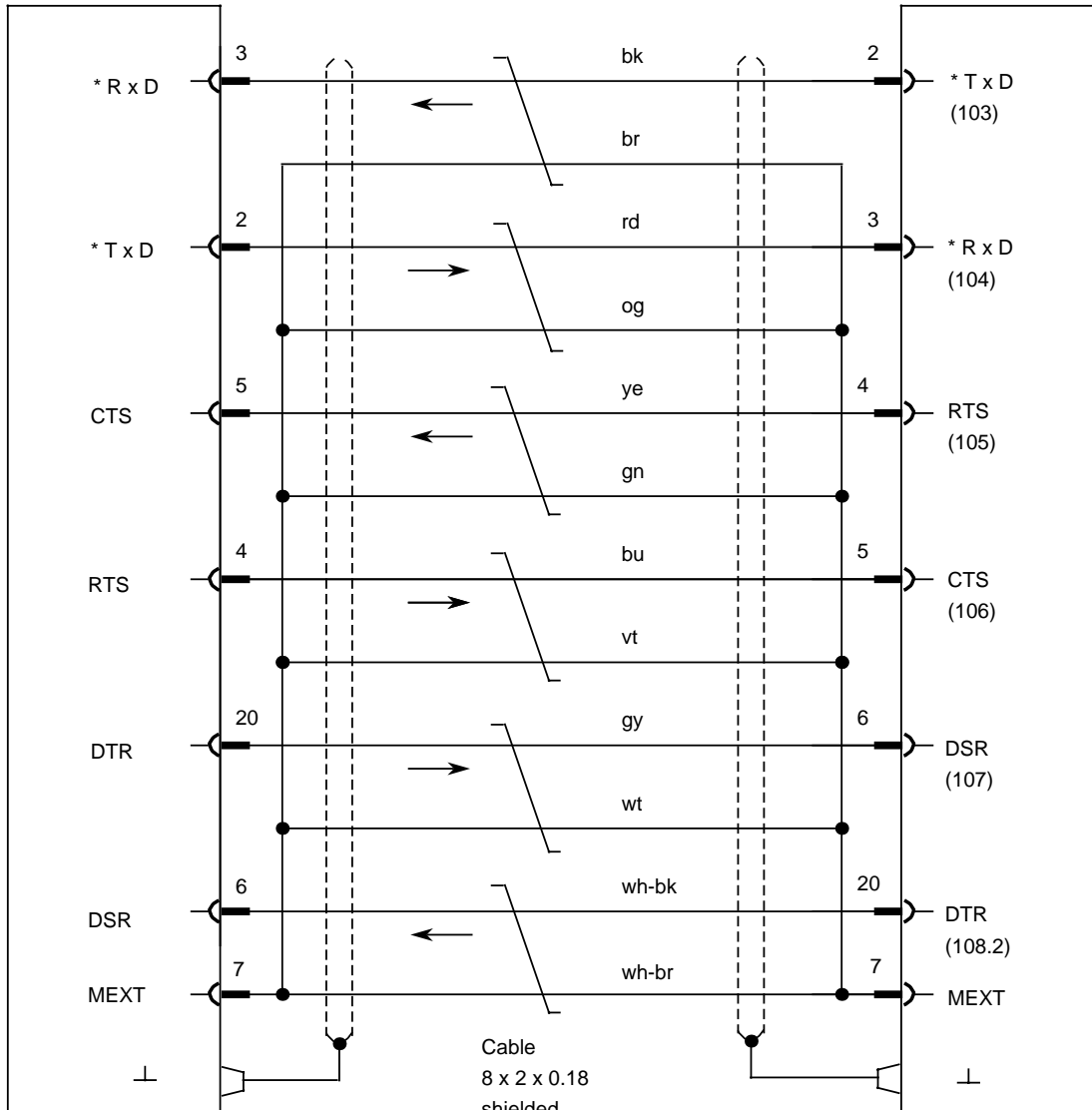

Cable  
8 x 2 x 0.18  
shielded  
2 pairs free  
6FC9 343-0AA

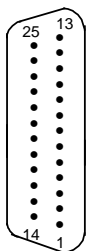

**Connector**  
Position 1 below  
Subminiature D  
25-way, male  
Connection side  
Housing with slide latch  
6FC9 341-2AA  
Designation: NC

**Connector code**

- Coding pin
- x Without coding pin

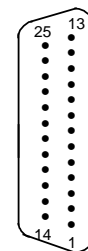

**Connector**  
Position 1 below  
Subminiature D  
25-way, male  
Connection side  
Post Office housing  
6FC9 341-1ES  
Designation: PC

**Connector code**

- Coding pin
- x Without coding pin

### 11.8.2.4 Interface settings

#### Interface parameters on the SINUMERIK 805, 810, 820, 840, 880

How to input and modify the interface parameters is described in the in the Operator's Guide of your CNC control.

#### Interface parameters on the programmer

On the PG 675 the printer interface does not need to be initialized.

Before the printer interface is called on the PG 685, data transfer to the NC must be initialized to 7 data bits and even parity in the following manner:

**DEVICE LPT0 [DAT=7]** (7 data bits) Return key  
**DEVICE LPT0 [PAR=EVEN]** (even parity) Return key

These inputs are not necessary if the **STARTUP.SUB** file supplied is copied onto the system diskette of the PG 635 or the hard disk of the PG 685. The two DEVICE commands are automatically executed by the **STARTUP.SUB** file whenever the operating system is loaded.

On the PG 750 the interface is initialized by calling the **MODE** command.

Examples: `MODE COM1:9600, e, 7, 2, p` (PG 750)

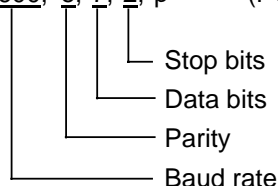

This call is not required if the command is written in the AUTOEXEC.BAT file. The interface is then initialized whenever the operating system is restarted.

#### Other baud rates (for PG 635, PG 675, PG 685 only)

When using the data cable as shown in 10.4.1 the baudrate must be set to 9600 baud. For other baud rates the connector to the printer interface must be changed as follows:

Pins (X pin connected to pin 2)

Baud rate	3	4	17
9600	X	X	X
4800	X	0	X
2400	0	X	X
1200	X	0	0
600	0	X	0
300	X	X	0
110	0	0	X

### Data start identifiers

When the NC outputs data it transmits initial identifiers to indicate the type of data. When reading in from the PG 675 or PG 685 these initial identifiers must be available in the file in the same form.

<b>% MPFxxx</b>	CR LF	Identifier for main programs
<b>% SPFxxx</b>	CR LF	Identifier for subroutines
<b>% T E A 1</b>	CR LF	Identifier for NC machine data
<b>% Z O A</b>	CR LF	Identifier for zero offsets
<b>% T E A 2</b>	CR LF	Identifier for PLC machine data
<b>% R P A</b>	CR LF	Identifier for R parameters
<b>% S E A 1-4</b>	CR LF	Identifier for setting data
<b>% PCF</b>	CR LF	Identifier for PLC alarm texts

### 11.8.2.5 How to transfer from the SINUMERIK 840 to the programmer

- a) Cable connection to PG 675/PG 685: V.24 (RS 232) interface PRINTER  
PG 750: V.24 (RS 232) interface COM1
- b) Cable connection to NC: V.24 (RS232) interface (SS1)  
V.24 (RS232) interface (SS2, option)
- c) Load operating system:
 

CP/M-86	PG 675
PCP/M-86	PG 685
MS-DOS	PG 750
- d) Initialise printer interface (see 11.2.4.2)
- e) Select DATA TRANSMISSION dialog and set parameters as described in section 11.2.4.1:
 

Device type:	RTS-LINE
Baud rate:	9600
Parity:	none
Stopbits:	2

Branch to the DATA OUTPUT dialog with the softkey Read Out.
- f) Select the data type to be transferred as described in the Operator's Guide.
- g) Program call for transfer:
 

PG 675:A>PGIN <drive>:<file designation>
PG 685:B>PGIN <drive>:<file designation>
PG 750:C>PCIN <drive>:<file designation>
- h) Start the PG by pressing the RETURN key
- i) Start the SINUMERIK 840 with softkey:
 

Start output
-----------------

Now the specified programs of the NC are stored on the specified drive in the programmer under the specified file designations.

During transmission the character received is output on the screen and checked for overflow and step errors (e.g. due to incorrect baud rate). If such an error occurs transmission is aborted and an error text displayed. The PGIN and PCIN data receive programs can store programs with a length of up to 256 Kbytes.

The reception of data is terminated if:

1. 40 times 00hex was transmitted (output from NC)
2. The "\*\*\*\*" was pressed on the PG 675 or 685 or the "ESC" key was pressed on the PG 750.
3. The number of received characters exceeds the 256 Kbyte limit.

If the first character (after 00hex) is a % or CR character the data start identifier is evaluated and the data type shown on the screen of the programmer after transmission.

After transmission of main programs or subroutines a directory of the transmitted program numbers and the length of each program is created (see example). The characters are counted in the same way as in the SINUMERIK.

After transmission of other data the data type is displayed but no directory created.

If the data start identifier does not correspond to a known string the following message is displayed after transmission:

"unknown data"

However, the characters received are still stored on hard disk or diskette.

#### Examples:

Program call	Storage		
	In drive	File name	Directory name
<b>PG 675</b> A>PGIN NAME A>PGIN B:NAME B>PGIN NAME B>PGIN A:NAME	A: B: B: A:	NAME NAME NAME NAME	NAME.DIR NAME.DIR NAME.DIR NAME.DIR
<b>PG 685</b> A>PGIN NAME A>PGIN B:NAME B>PGIN NAME B>PGIN A:NAME	A: B: B: A:	NAME NAME NAME NAME	NAME.DIR NAME.DIR NAME.DIR NAME.DIR
<b>PG 750</b> C>PCIN NAME C>PCIN A:NAME C>PCIN B:NAME	C: A: B:	NAME NAME NAME	NAME.DIR NAME.DIR NAME.DIR

If a file name is specified with an extension the extension DIR is not permissible because the directory is stored under that designation.



With the call type <drive>:<file designation>.DIR you can display the directory of the main programs and subroutines transmitted.

**Example:**

**B>TYPE A:TEST-L.DIR**

```
L 95 1609 CH L 97 1178 CH L 98 310 CH L 801 33 CH
L 803 42 CH L 804 42 CH L 805 58 CH L 806 90 CH
L 951 75 CH L 970 107 CH L 971 104 CH L 981 58 CH
L 990 54 CH L 999 12 CH
```

**Example:**

**B>TYPE A:TEST-%.DIR**

```
% 120 105 CH % 22 105 CH
```

### 11.8.2.6 How to transfer from the programmer to the SINUMERIK 880

- a) Cable connection to PG 675/PG 685: V.24 (RS 232) interface PRINTER  
PG 750: V.24 (RS 232) interface COM1
- b) Cable connection NC: V.24 (RS 232) interface (F1 to 4)  
V.24 (RS 232) interface (IF, option)
- c) Load operating system: CP/M-86 PG 675  
PCP/M-86 PG 685  
MS-DOS PG 750
- d) Initialise printer interface
- e) Select DATA TRANSMISSION dialog and set parameters:
  - Device type: RTS-LINE
  - Baud rate: 9600
  - Parity: none
  - Stop bits: 2

Branch to the DATA OUTPUT dialog with the softkey read out.
- f) Program call for transfer:
  - PG 675:A>PIP LST:=<drive>:<file designation>[E]
  - PG 685:B>PIP LST:=<drive>:<file designation>[E]
  - PG 750:C>COPY<drive>:<file designation>COM1

[E]: with display of the characters on the screen

- g) Start the SINUMERIK 880 with softkey:

Start input
-------------

h) Start the PG by pressing the RETURN key.

Now the specified file is loaded into the NC.

If several files must be transferred to the NC, the PIP program can be loaded to avoid repeated PIP system calls on the PG 675 and PG 685.

**Example:**

1st part	<b>B&gt;PIP</b>	<b>RETURN</b> key
2nd part	<b>*LST:=&lt;DRIVE&gt;:&lt;FILE DESIGNATION&gt;</b>	<b>RETURN</b> key

Only the second part of the call need be repeated with a new file name.

After termination of transmission you can leave the "PIP SYSTEM" by pressing the RETURN key.

## 11.9 Remote Programmer Function

### Activation of the remote programmer function:

- Requirements
  - Hardware
    - SINEC H1 industrial LAN
    - PG 750 with CP 141 or PG 685 with CP 536
    - CP 231 A
    - 135 WB with ACOP
  - Firmware
    - COM software version 6.3
    - PLC software version 6.3
    - CP firmware version 3A (Order number: 6FX1841-0BX02-3A)

- Machine data

On the SINUMERIK 880 the function remote programmer via SINEC H1 is only disabled in the option bit. This NC machine data bit must be set in order to establish a link between the remote programmer and the SINUMERIK 880.

The remote programmer function of the SINUMERIK is adapted to the remote programmer function of the SIMATIC. However, the following points must be observed.

If a user is to establish a link the valid Ethernet address of the CP 231 must be known to him.

If both the remote programmer functionality and the computer link are active, the Ethernet address can be seen from the data base produced with the NML configuration tool. The Ethernet address is stored in the "node and interface description" menu.

If a computer link functionality is not used the Ethernet address is stored in machine bits 5141 to 5146.

The password is stored in the general NC machine data 234 and 235. If a zero is stored in NC machine data 234 and 235, a password is not required (press CR at the password prompt). If NC machine data 234 contains the value 41424344 and NC machine data 235 the value 45464748, the password ABCDEFGH must be entered. Input into NC machine data 234 and 235 is protected by the password of the SINUMERIK 880. The value entered in these machine data is interpreted as ASCII.

- Establishing a link between the remote programmer and the SINUMERIK CP
  - Start the S5 DOS at the programmer.
  - Select the SINEC H1 interface with the "interface" menu.
  - Select "utility" menu
  - Select "bus selection" menu.
  - Select "edit path" menu.

Here the path CP 536 - CP 5365 - Corr/Mux - ENDP must be edited.

Now the valid Ethernet address of the CP 231 A must be input into the Ethernet address line. The the password is requested.

At "address" the number of the PLC with which the remote programmer is to communicate is requested.

Now transfer the data.

Select "active" menu.

"The function key "all" is now pressed to establish the link. The message "link established" appears.

Now return to the basic menu and select "package". From now on operation is the same as with the local programmer.

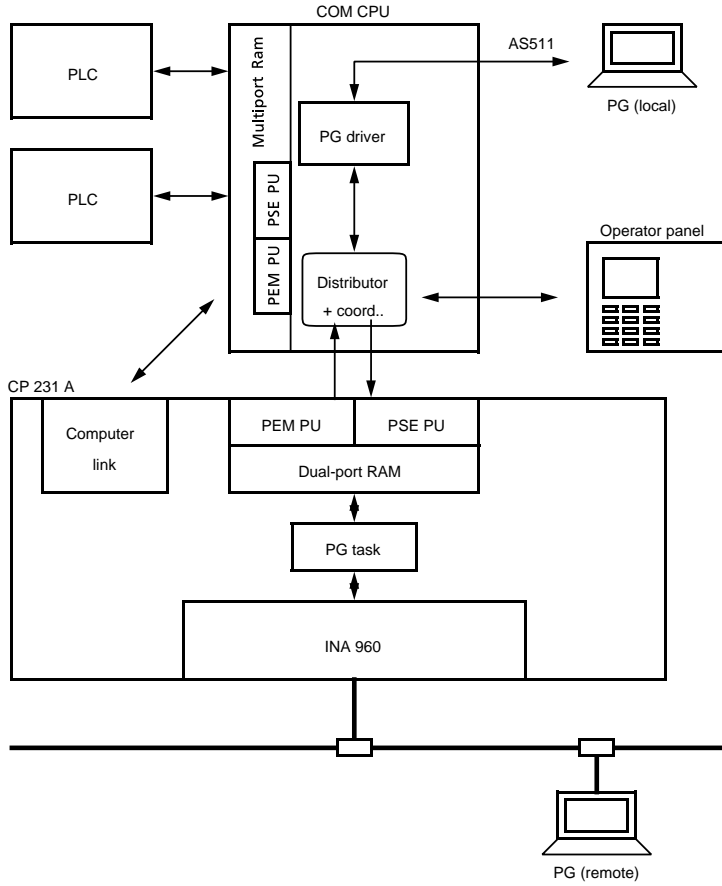

## 2. Abort of the remote programmer function by activation of the local programmer.

To activate the local programmer, press the following softkeys (the shaded softkeys are the ones to press).

Enter "00000100" into the setting data 5030 so that the 3rd interface is set to programmer mode.

AUTOMATIC mode

TOOL OFFSET	SETTING DATA	DATA IN-OUT	PART PROGRAM	ACTUAL BLOCK	>
----------------	-----------------	----------------	-----------------	-----------------	---

Enter a "three" in the input screen for the third interface.

INTERF. 1+2	INTERF. 3+4	FILE- TRANSF.		
----------------	----------------	------------------	--	--

INPUT START	DATA OUTPUT	REMOTE PG STOP	STOP	STOP ALL
----------------	----------------	-------------------	------	-------------

Then the prompt "**REMOTE PG RUNNING/STOP?**" appears.

Now the user must decide whether he wishes to break off the remote programmer connection. If he does not, he can leave this screen and the remote programmer connection will have been left intact.

If the local programmer must override the remote programmer, i.e. the remote programmer breaks off its connection to the PLC, press the following key:

INPUT START	DATA OUTPUT	REMOTE PG STOP	STOP	STOP ALL
----------------	----------------	-------------------	------	-------------

Now softkey function 143 is executed. If a remote programmer is active, the driver of this function on the COM CPU is made to break off the link between the remote PG and the PLC in the SINUMERIK via the CP231 and CPM CPU components. If this is successful, the message "**REMOTE PG IS INACTIVE**" is displayed.

If the link is not broken within a set delay the message "**CHECK REMOTE PG**" is output. In this case you should check the COM CPU and the CP231 and reinitialize them if necessary.

When the message "**REMOTE PG IS INACTIVE**" appears you can press the softkey again and the local programmer is deactivated. If you press the softkey yet again, the usual message "interface busy" appears.

INPUT START	DATA OUTPUT	REMOTE PG STOP	STOP	STOP ALL
----------------	----------------	-------------------	------	-------------

You have to enter 00000100 into SD 5030 to set the third interface to programmer mode.

To stop the remote programmer follow the following procedure (pressing the shaded softkeys).

Automatic mode

TOOL OFFSET	SETTING DATA	DATA IN-OUT	PART PROGRAM	ACTUAL BLOCK	>
----------------	-----------------	----------------	-----------------	-----------------	---

Enter a "three" in the input screen for the third interface.

INTERF. 1+2	INTERF. 3+4	FILE- TRANSF.		
----------------	----------------	------------------	--	--

Now press the following softkey:

INPUT START	DATA OUTPUT	REMOTE PG STOP	STOP	STOP ALL
----------------	----------------	-------------------	------	-------------

Then the prompt "**REMOTE PG RUNNING/STOP?**" appears, if a remote programmer is active.

Or the message "**REMOTE PG IS INACTIVE?**" if no remote programmer is running. In this case you can press the softkey INPUT START immediately to activate the third interface for local programmer mode.

If the prompt "**REMOTE PG RUNNING/STOP?**" appears the user must decide whether he wishes to break off the remote programmer connection. If he does not, he can leave this screen and the remote programmer connection will have been left intact.

If you do not intend the local programmer to override the remote programmer, i.e. the remote programmer is not supposed to break off the link to the PLC, you have to press the following softkey again.

INPUT START	DATA OUTPUT	REMOTE PG STOP	STOP	STOP ALL
----------------	----------------	-------------------	------	-------------

Then proceed as described above.

3. Input modifications in the "selected PLC" screen because of the function remote programmer.

There is a display for the PLC number which you can reach via the following softkeys:

BLOCK SEARCH	PROGRAM CONTROL	DIAG-NOSTICS	OVER-STORE:		>
--------------	-----------------	--------------	-------------	--	---

ALARM MESSAGE	MACHINE DATA	SERVICE STATUS	PLC UTILTIY		>
---------------	--------------	----------------	-------------	--	---

The screen looks like this:

AUTOMATIC					1.1
SELECTED PLC:					
<div style="border: 1px solid black; display: inline-block; padding: 2px 10px;">1</div>					

You can enter the PLC numbers into the input field shown here in the double box. Up to two PLCs are possible. The permissible inputs are therefore 1 and 2. If larger number is entered the message "GENERAL DATA ERROR" is displayed. The message "GENERAL DATA ERROR" also appears if you try to select the second PLC although a second PLC is not declared in NC machine data 5038.

The response of the control to input in this screen changes when a remote programmer is active. Then it is no longer possible to change the PLC number on this screen. If you try to enter the number in this screen the input is not accepted and the message "**REMOTE PG RUNNING/STOP?**" is displayed. The input is refused because otherwise the remote programmer would be connected with another PLC that was not specified by the operator of the remote programmer but by the operator of the control. If the remote programmer breaks off its link the PLC number is entered which was entered in this screen before activation of the remote programmer.

If the local programmer has been activated you can entered the PLC number as described previously.

4. Operation in initial clear mode or installation

Here new or modified operating sequences of the 880 control are described which have arisen because of the remote programmer function.

The remote programmer function can be activated during installation as well.

For this reason the same problems arise as in normal mode. Before starting the local programmer the remote programmer must first be deactivated. This is done in the same way as in normal mode. The only difference is in the softkey menus. The softkey menus of normal mode of shown with their equivalents in initial clear mode. Operation is as described above.

Now press the following softkey:

Initial clear mode

DATA IN-OUT	NC DATA	PLC UTILITY	MACHINE DATA	SET UP END PW	>
----------------	------------	----------------	-----------------	------------------	---

Normal mode in AUTOMATIC mode

TOOL OFFSET	SETTING DATA	DATA IN-OUT	PART PROGRAM	ACTUAL BLOCK	>
----------------	-----------------	----------------	-----------------	-----------------	---

Initial clear mode

INTERF. 1+2	INTERF. 3+4			
----------------	----------------	--	--	--

Normal mode in AUTOMATIC mode

INTERF. 1+2	INTERF. 3+4	FILE- TRANSF.		
----------------	----------------	------------------	--	--

Initial clear mode

DATA IN	DATA OUT			STOP ALL
------------	-------------	--	--	-------------



## Initial clear mode

		REMOTE PG STOP	START	STOP
--	--	-------------------	-------	------

## Normal mode in AUTOMATIC mode

INPUT START	DATA OUTPUT	REMOTE PG STOP	STOP	STOP ALL
----------------	----------------	-------------------	------	-------------

The only real difference between operation in normal mode and in initial clear mode is that you have to press the softkeys DATA INPUT and START in initial clear mode while just pressing the softkey INPUT START in normal mode has the same effect.

Changes were made in the function PLC initial clear as well.

This function is activated via the following softkeys.

## Installation mode

DATA IN-OUT	NC DATA	PLC FUNCT.	MACHINE DATA	SET UP END PW	>
----------------	------------	---------------	-----------------	------------------	---

PLC INITIAL				
----------------	--	--	--	--

PLC 1 INITIAL	PLC 2 INITIAL			
------------------	------------------	--	--	--

After this operating sequence the function PLC initial clear is executed and a checkmark appears to indicate that the function is running correctly. This is how it worked until now and it still does as long as a programmer (remote or local) is not active. For a local programmer active means that the third interface is set to programmer mode and has been activated by pressing the INPUT START softkey. The remote programmer is activated when the operator on the remote programmer sends an activation message frame to the SINUMERIK 880 and receives a positive acknowledgement.

If a programmer is active the message "**STOP PG**" is displayed. The cancel alarm 3151 "Interface occupied by PG" is also output. It is to be seen in the NC alarm display. To obtain this display from the PLC 1/2 initial clear display press the following keys:



NC ALARM					>
-------------	--	--	--	--	---

The screen looks like this:

					<u>1.1</u>
2000	ORD1	EMERGENCY stop			
NC ALARMS					
2000	ORD1	EMERGENCY stop			
3151	ORD2	Interface occupied by PG			
NC ALARM					>

5. Error message

If the COM CPU detects an error in the remote programmer on the CP231 the cancel alarm **3165 "Remote PG has failed"** is displayed. This alarm is output in 5 second cycles. The cause of this alarm is in the SINEC module. To remedy the fault you have to check the CP231. Check the software version of the CP231 and if necessary clear the dual-port RAM to the CP231. This is done in installation mode where the dual-port RAM to the CP231 is cleared automatically.

## 11.10 Coordinate transformation

The coordinate transformation TRANSMIT (from software version 3 onwards) is used in the face milling of turned parts (lathes). In order to implement this, a C axis and a powered milling cutter are required in addition to the X and Y axes.

The 2D/3D coordinate transformation (from software version 4 onwards) is required when surfaces are configured on a plane (2D coordinate transformation) or in space (3D coordinate transformation) in such a way that they can only be processed by the (real) axes by including rotations (the tool must generally be located on the processing plane).

### 11.10.1 Corresponding data

- NC MD 730 1st. transformation, parameter 1
- NC MD 731 1st. transformation, parameter 2
- NC MD 732 1st. transformation, parameter 3
- NC MD 733 1st. transformation, parameter 4
- NC MD 734 1st. transformation, parameter 5
- NC MD 735 1st. transformation, parameter 6
- NC MD 736 1st. transformation, parameter 7
- NC MD 737 1st. transformation, parameter 8
- NC MD 738 1st. transformation, parameter 9
- NC MD 739 1st. transformation, parameter 10
- NC MD 740 to 809 2nd. to 8th. transformation, parameter 1 to 10
- NC MD 5060 channel numbers of the transformation
- NC MD 5061 G function for transformation selection
- NC MD 5062 axis name 1st. fictitious axis
- NC MD 5063 axis name 2nd. fictitious axis
- NC MD 5064 axis name 3rd. fictitious axis
- NC MD 5065 axis name 1st. real axis
- NC MD 5066 axis name 2nd. real axis
- NC MD 5067 axis name 3rd. real axis
- NC MD 5068 axis name 4th. real axis
- NC MD 5069 axis name 5th. real axis
- NC MD 5070 to 5139 1st. to 8th. transformation data set
- MD 540\* Bit 7 no transformation cancellation
- MD 564\* Bit 6 fictitious axis
- OPTION transformation TRANSMIT/2D/3D coordinate transformation
- SIGNAL DB10-DB13 DR13 BIT 7 TRANSFORMATION ACTIVE
- Alarm 2043 Programming error during transformation
- Alarm 2189 Transformation undefined
- Alarm 2190 Transformation axes assigned
- Alarm 3086 Illegal transformation selection
- Alarm 3087 Error in transformation data

### 11.10.2 Function description of coordinate transformation

Whereas machine movements are executed in the real machine coordinate system, programming is carried out in the fictitious (Cartesian) coordinate system. Fictitious axes must be defined especially for the fictitious coordinate system. A fictitious axis can only be traversed when transformation is selected. Fictitious axes can be selected freely with respect to their axis name and their location. Up to eight transformations with varying axis groupings can be defined in any one control. The definition consists of a transformation data set and the associated parameters for each transformation.

The selection of the coordinate transformation is realized via G functions in the part program or via the command channel from the PLC.

G131, G231, G331 coordinate transformation TRANSMIT

G133, G233, G333 2D coordinate transformation

G135, G235, G335 3D coordinate transformation

Coordinate transformation can be cancelled via G130, G230 or G330 in the part program, or via the command channel from the PLC.

It can be specified via NC MD 540\* Bit 7 whether cancellation occurs automatically on RESET or after a change in the operating mode.

See Section 11.8.8.1 for applications of the coordination transformation TRANSMIT.

2D coordinate transformation - see Section 11.8.8.2

3D coordinate transformation - see Section 11.8.8.3

and in the Programming Guide to System 880.

### 11.10.3 The transformation data set

NC MD	Bit No.							
	7	6	5	4	3	2	1	0
<b>5060</b>	Channel number of transformation							
<b>5061</b>	G function for transformation selection							
<b>5062</b>	Axis name 1st fictitious axis							
<b>5063</b>	Axis name 2nd fictitious axis							
<b>5064</b>	Axis name 3rd fictitious axis							
<b>5065</b>	Axis name 1st real axis							
<b>5066</b>	Axis name 2nd real axis							
<b>5067</b>	Axis name 3rd real axis							
<b>5068</b>	Axis name 4th real axis							
<b>5069</b>	Axis name 5th real axis							

NC MD 5060 to 5069    1st transformation data set  
 NC MD 5070 to 5079    2nd transformation data set  
 ⋮  
 NC MD 5130 to 5139    8th transformation data set

Conditions for a transformation data set

- a) All axes and the channel must be assigned to the same operating mode group.
- b) The transformation option must be available.
- c) The transformation data are taken over internally by the control at restart (warm restart). Definition errors cause Alarm 3087 to be output. The incorrect machine data is coded in the block number in the alarm text.
- d) NC MD 564\* Bit 6 must be set for all fictitious axes.
- e) The axis names of the real and fictitious axes of a transformation data set should not be repeated. Using the same axis name with a different extended address is permitted.

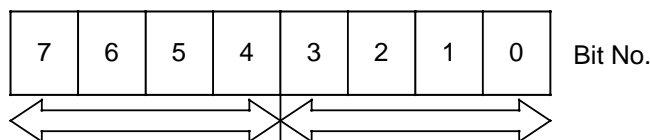

key:

- blank = 0000
- 1 = 0001
- 2 = 0010
- 3 = 0011
- 4 = 0100
- 5 = 0101
- 6 = 0110
- 7 = 0111
- 8 = 1000
- 9 = 1001
- 10 = 1010
- 11 = 1011
- 12 = 1100
- 13 = 1101
- 14 = 1110
- 15 = 1111

key:

- X = 0000
- Y = 0001
- Z = 0010
- A = 0011
- B = 0100
- C = 0101
- U = 0110
- V = 0111
- W = 1000
- Q = 1001
- E = 1010

Example: 0000 0010=Z  
0001 1001=Q1

Legal names for axes, angles, chamfer and radius

<b>A</b>	<i>unassigned address</i>	<b>N</b>	sub block
<b>B</b>	<i>unassigned address</i>	<b>O</b>	danger of confusion with 0 (zero)
<b>C</b>	<i>unassigned address</i>	<b>P</b>	subroutine - number of passes
<b>D</b>	tool offset number	<b>Q</b>	<i>unassigned address</i>
<b>E</b>	<i>unassigned address</i>	<b>R</b>	calculation parameter
<b>F</b>	feed	<b>S</b>	spindle speed, S function
<b>G</b>	G function	<b>T</b>	tool
<b>H</b>	H function	<b>U</b>	<i>unassigned address</i>
<b>I</b>	interpolation parameter	<b>V</b>	<i>unassigned address</i>
<b>J</b>	interpolation parameter	<b>W</b>	<i>unassigned address</i>
<b>K</b>	interpolation parameter	<b>X</b>	<i>unassigned address</i>
<b>L</b>	subroutine	<b>Y</b>	<i>unassigned address</i>
<b>M</b>	M function	<b>Z</b>	<i>unassigned address</i>

**11.10.4 Transformation parameters**

NC MD	Significance		
<b>730</b>	<b>1st transformation, parameter 1 (from software version 4 onwards)</b>		
<b>731</b>	<b>1st transformation, parameter 2 (from software version 4 onwards)</b>		
<b>732</b>	<b>1st transformation, parameter 3 (from software version 4 onwards)</b>		
<b>733</b>	<b>1st transformation, parameter 4 (from software version 4 onwards)</b>		
<b>734</b>	<b>1st transformation, parameter 5 (from software version 4 onwards)</b>		
<b>735</b>	<b>1st transformation, parameter 6 (from software version 4 onwards)</b>		
<b>736</b>	<b>1st transformation, parameter 7 (from software version 4 onwards)</b>		
<b>737</b>	<b>1st transformation, parameter 8 (from software version 4 onwards)</b>		
<b>738</b>	<b>1st transformation, parameter 9 (from software version 4 onwards)</b>		
<b>739</b>	<b>1st transformation, parameter 10 (from software version 4 onwards)</b>		
Sign	Input limits	Standard value	Units
+/-	99 999 999	0	units (IS)

NC MD 740 to 749	2nd. transformation, parameter 1 to 10
NC MD 750 to 759	3rd. transformation, parameter 1 to 10
NC MD 760 to 769	4th. transformation, parameter 1 to 10
NC MD 770 to 779	5th. transformation, parameter 1 to 10
NC MD 780 to 789	6th. transformation, parameter 1 to 10
NC MD 790 to 799	7th. transformation, parameter 1 to 10
NC MD 800 to 809	8th. transformation, parameter 1 to 10

The transformation parameters are needed for the 2D/3D coordinate transformation (and are of no consequence for the TRANSMIT coordinate transformation).

Transformation parameters for 2D coordinate transformation

Parameter 1:	X shift of the real system in direction X relative to the fictitious origin a1 [unit: units (IS)].
Parameter 2:	Y shift of the real system in direction Y relative to the fictitious origin a2 [unit: units (IS)].
Parameter 4:	Angle of rotation of the real system relative to the fictitious system [unit: 10 <sup>-5</sup> degrees].
Parameter 10:	Axis number which is used to calculate the G96 (constant cutting speed).

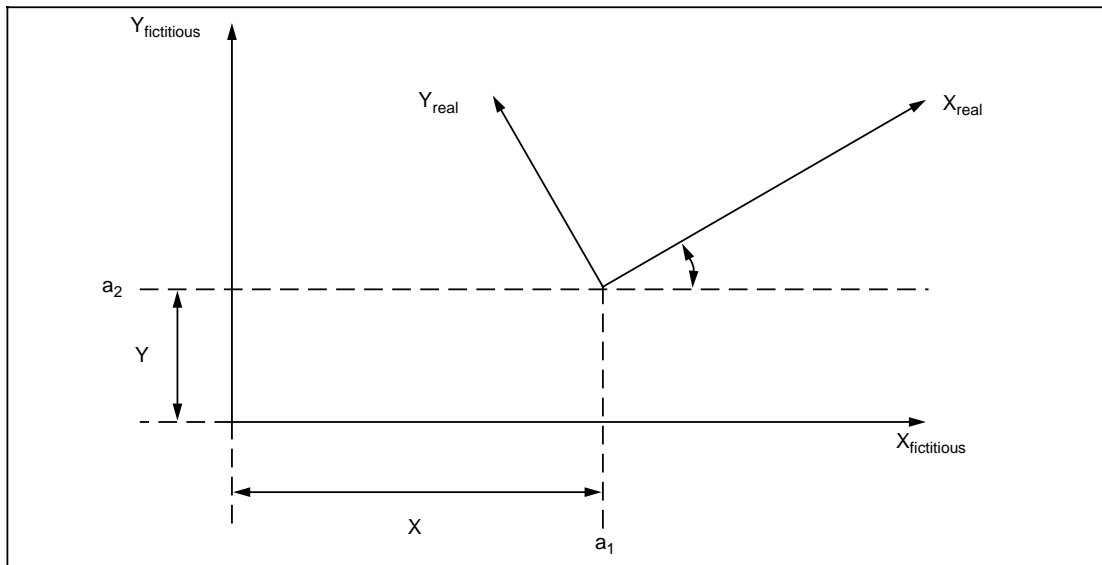

Transformation parameters for 3D coordinate transformation

- Parameter 1: X shift of the real system in direction X relative to the fictitious system [unit: units (IS)].
- Parameter 2: Y shift of the real system in direction Y relative to the fictitious system [unit: units (IS)].
- Parameter 3: Z shift of the real system in direction Z relative to the fictitious system [unit: units (IS)].
- Parameter 4: Angle of rotation  $\alpha$ , which occurs when the real coordinate system is rotated about the X axis (unit:  $10^{-5}$  degrees).
- Parameter 5: Angle of rotation  $\beta$ , which occurs when the real coordinate system is rotated about the Y axis (Einheit:  $10^{-5}$  degrees).
- Parameter 6: Angle of rotation  $\gamma$ , which occurs when the real coordinate system is rotated about the Z axis (unit:  $10^{-5}$  degrees).
- Parameter 10: Axis number for axis which is used to calculate G96 (constant cutting speed).

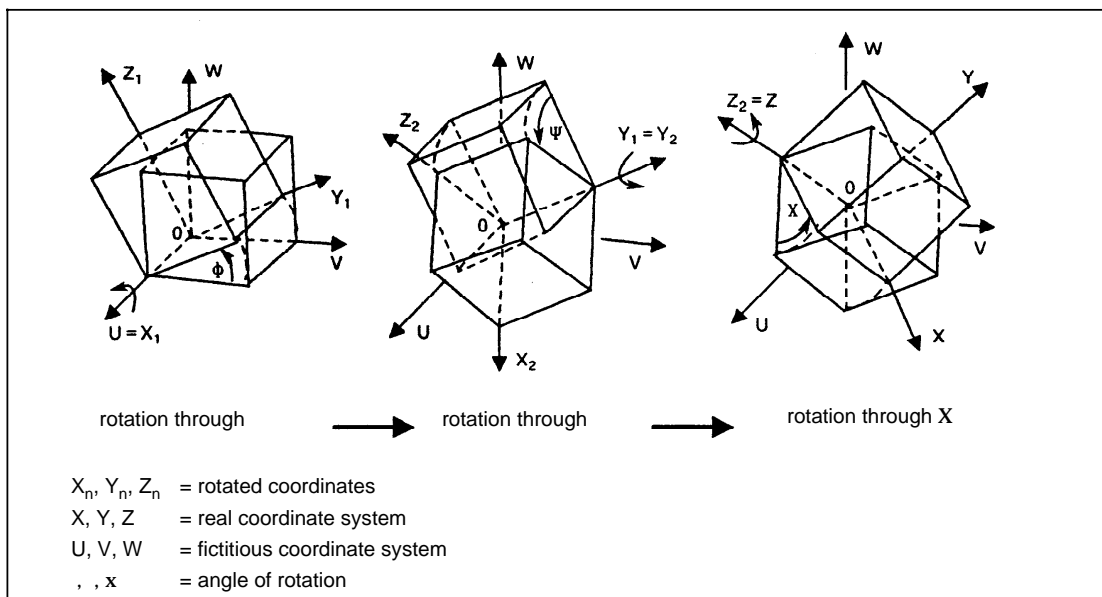



### 11.10.5 Machine data for fictitious axes

MD 224*		Software limit switch
MD 228*		Software limit switch
MD 232*		Software limit switch
MD 236*		Software limit switch The software limit switch need not be input if the fictitious working area is outside the real possible working area, as the control always restricts the fictitious software limit switch to the limit switch of the A <sub>1R</sub> axis (linear axis of transformation).
MD 276*		Acceleration The acceleration value must be calculated in such a way that the real axes of transformation are not overloaded (minimum acceleration value of A <sub>1R</sub> to A <sub>5R</sub> ).
MD 280*		Maximum speed
MD 288*		JOG speed
MD 292*		Rapid JOG The speeds can be freely selected, as they are monitored by the control.
MD 304*		IPO parameter
MD 360*		Operating mode group of the axis
MD 564*	Bit 6	Fictitious axes The axis is declared as a "fictitious axis". Fictitious axes have no position control. The MD 200* measuring circuit assignment is therefore meaningless.
MD 564*	Bit 7	Axis exists
MD 568*		Encoding of the axis name
MD 576*		Axis not permitted in channel

## 11.10.6 NC PLC interface signals

- In the case of fictitious axes, only the signals "JOG, rapid overlay and handwheel 1,2 and the input interface" are processed.  
The output interface is not accounted for. The signal "Reference point reached" is permanently set to 1.
- The program including the transformation is not stopped if the signal "Block axis" is set for a real axis in the transformation grouping. In this way an offset occurs between the transformation and the position control which can only be eliminated by selecting transformation.
- If a real axis in the transformation grouping is switched into control from the follow-up mode, an inverse transformation of the fictitious coordinates occurs automatically.
- If a real axis in the transformation grouping is occupied by "Feed stop", this applies to the entire grouping.
- When "Clear residual path" occurs, the fictitious residual paths are cleared.
- The signal "Transformation active" is set in the channel-specific interface NC PLC for every channel in which the transformation is active (see also Interface Description).
- Warm restart is possible when transformation is selected if the transformation grouping does not change operating mode groups.
- Command channel  
In order to traverse a fictitious axis in JOG mode, the relevant transformation must first be activated in the channel assigned via machine data. The activation, i.e. the selection/cancellation, of the transformation is a function mode of the command channel. The selection of coordinate transformation is described in the Interface Description, Part 1.

### 11.10.7 Explanation of the programming and operation of coordinate transformation

- Fictitious axes must not be programmed in the reset position (G130, G230, G330) Alarm 2043.
- A transformation may only be activated from a reset position, i.e. transition to a different transformation is only possible via a previous cancel block.
- The selection of coordinates occurs as follows:  
 G131 or G231 or G331 TRANSMIT  
 G133 or G233 or G333 2D coordinate transformation  
 G135 or G235 or G335 3D coordinate transformation

The selection block must not contain any traversing movements, auxiliary functions etc.

- When transformations are selected, none of the real axes of the transformation grouping must be programmed Alarm 2043.
- Each selection/cancellation of transformations is connected to the function "Clear buffer" (@714). The @714 need not be programmed as it is automatically initiated by the control.
- The offset of the cutter/tool tip radius must be cancelled before activating the transformation (dependent on @714).
- Only one transformation can ever be selected in any one channel.
- Transformations which are running parallel in different channels must not refer to the same axes Alarm 2190.
- The plane definitions which are laid down in channel-specific machine data are valid for the real system. When a transformation is selected a plane is adjusted for the **fictitious** system. The fictitious plane is defined in the transformation data by assigning the fictitious axes. Deviations from the basic planes can be explicitly programmed via G16. The basic plane position is defined as G17 (A<sub>1F</sub>-A<sub>2F</sub>).  
 G17 is automatically adjusted when a transformation is selected. The plane which was effective before selecting the transformation is automatically restored after the transformation is cancelled.

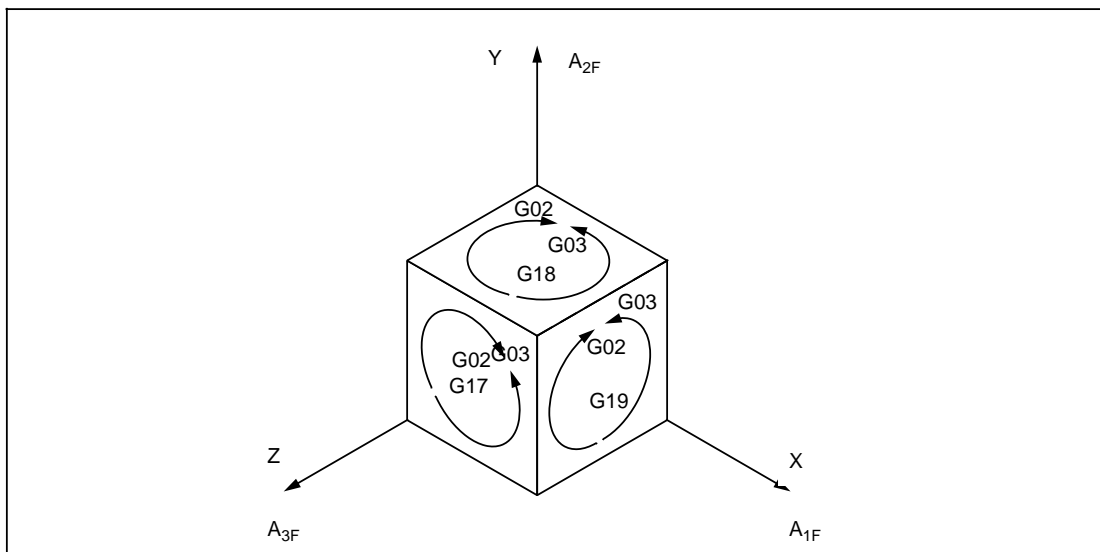

## 11.10.7 Explanation of the programming and operation of coordinate transformation

- A transformation must not be selected or cancelled within a contour block sequence.
- A block search to a part program where transformation is active is permitted.
- The automatic block search to a part program where transformation is active is **not** permitted.
- PRESET shifts of real axes are ignored in the case of transformation.
- Fictitious axes cannot be traversed with the handwheel. Real axes can only be traversed with the handwheel when transformation is not active.
- DRF is not possible in the case of fictitious axes.
- DRF is only possible in the case of real axes when a program block is active (not for NC STOP).
- The adjustable angle of rotation for coordinate system rotation (G54 to G57) must always be zero.
- The programmable angle of rotation for coordinate system rotation (G58, G59) must also be zero when transformation is being selected or cancelled.

## 11.10.8 Examples of coordinate transformation

### 11.10.8.1 Example of the coordinate transformation TRANSMIT

A transformation data set for the TRANSMIT transformation must be defined as follows:

NC MD 5060	Channel number of the transformation Example 00000010 (binary form) (channel 2)		
NC MD 5061	G function for transformation selection	G131	0001 0001
		G231	0010 0001
		G331	0011 0001
NC MD 5062	Axis name 1st. fictitious axis ( $A_{1F}$ )		
NC MD 5063	Axis name 2nd. fictitious axis ( $A_{2F}$ )		

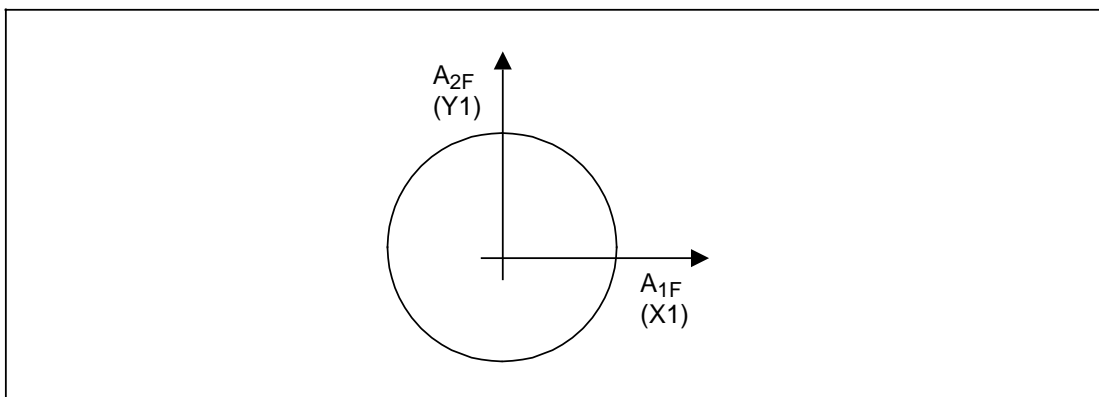

NC MD 5064	Axis name of the infeed axis (real axis)	Example: 0000 0010 (Z)
NC MD 5065	Axis name of the 1st. real axis ( $A_{1R}$ ) - linear axis	
NC MD 5066	Axis name of the 2nd real axis ( $A_{2R}$ ) - rotary axis	

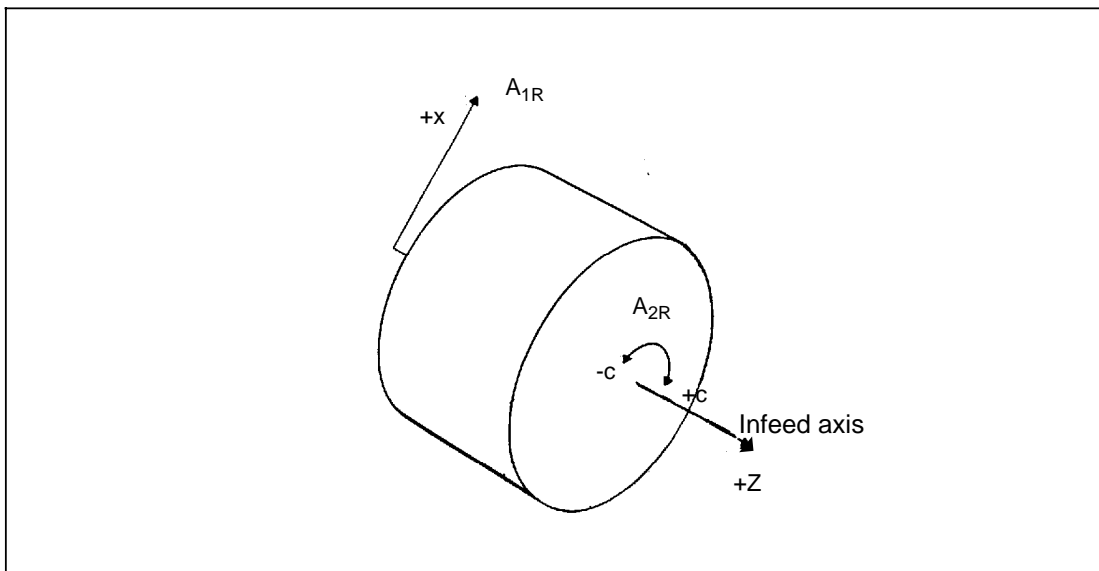

NC MD 5067 to 5069 unassigned (Input: 1111 1111)

See Programming Guide for programming example.

### 11.10.8.2 Example of 2D coordinate transformation

A transformation data set for 2D coordinate transformation must be defined as follows:

- NC MD 5060 Channel number of the transformation  
 Example: 0000 0010 (binary form) (channel 2)
  
- NC MD 5061 G Function for transformation selection  
 G133 0001 0011  
 G233 0010 0011  
 G333 0011 0011
  
- NC MD 5062 Axis name 1st.fictitious axis ( $A_{1F}$ ) -X1
- NC MD 5063 Axis name 1st.fictitious axis ( $A_{2F}$ ) -Y1

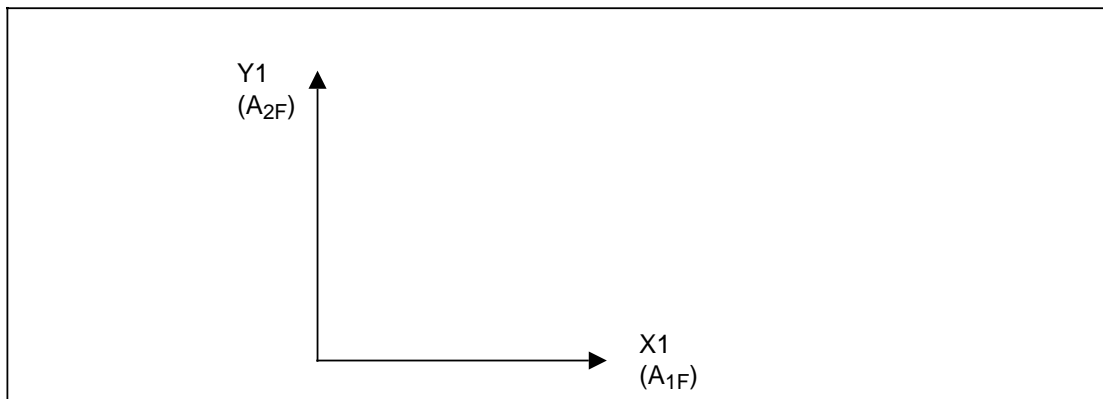

- NC MD 5064 Axis name of the infeed axis (real axis) Example: 0000 0010 (Z)
  
- NC MD 5065 Axis name of the 1st. real axis ( $A_{1R}$ ) - linear axis Example: 0000 0000 (X)
- NC MD 5066 Axis name of the 2nd. real axis ( $A_{2R}$ ) - rotary axis Example: 0000 0101 (C)

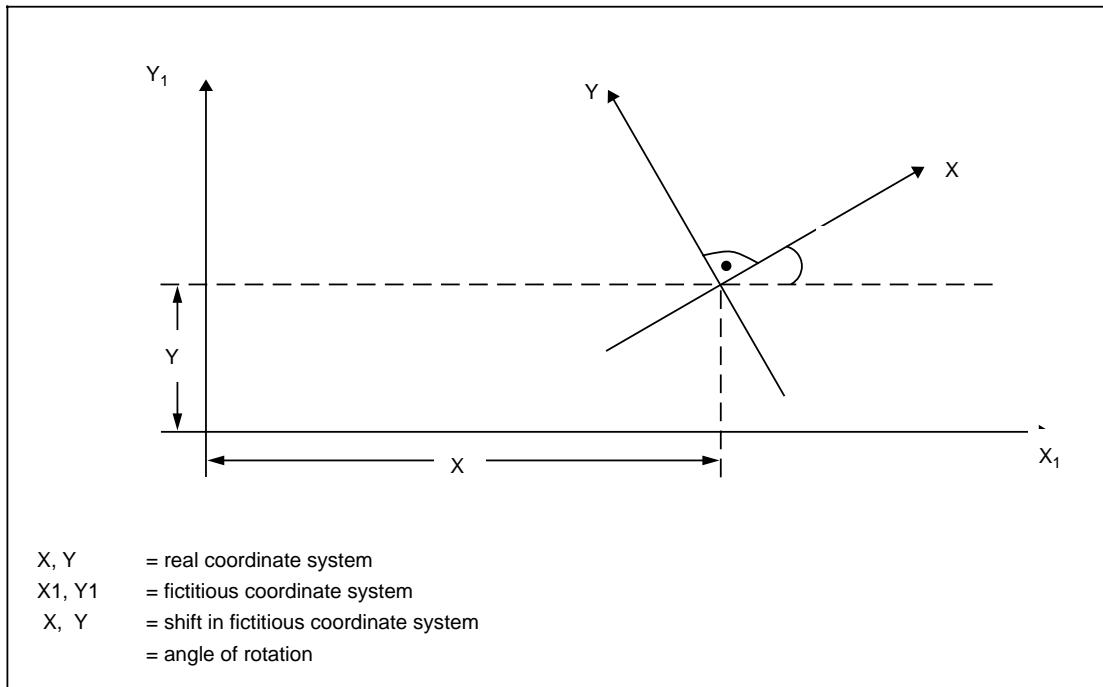

NC MD 5067 to 5069 unassigned (Input: 1111 1111)

See Programming Guide for programming example.

### 11.10.8.3 Example of 3D coordinate transformation

A transformation data set for 3D coordinate transformation must be defined as follows:

NC MD 5060	Channel number of the transformation Example : 0000 0010 (binary form) (channel 2)		
NC MD 5061	G Function for transformation selection	G135	0001 0101
		G235	0010 0101
		G335	0011 0101
NC MD 5062	Axis name 1st. fictitious axis ( $A_{1F}$ )	- X1	
NC MD 5063	Axis name 2nd. fictitious axis ( $A_{2F}$ )	- Y1	
NC MD 5064	Axis name 3rd. fictitious axis ( $A_{3F}$ )	- Z1	

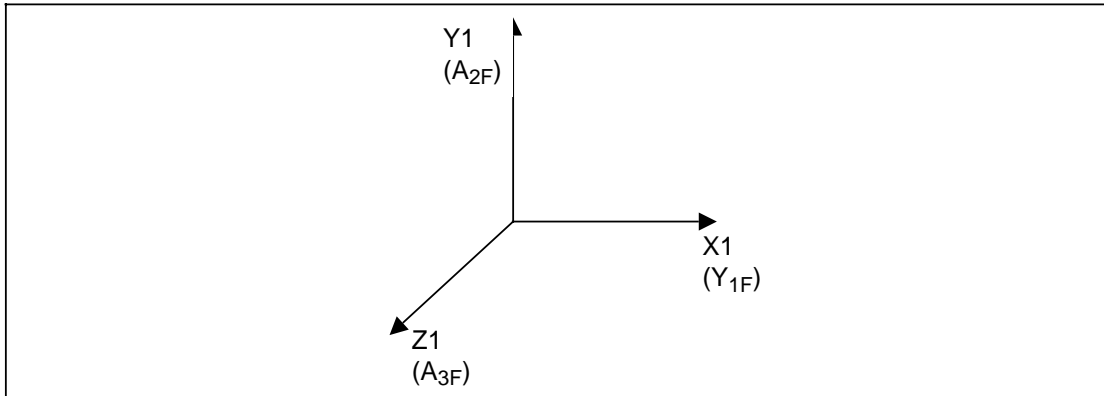

NC MD 5065	Axis name 1st. real axis ( $A_{1R}$ )	- X
NC MD 5066	Axis name 2nd. real axis ( $A_{2R}$ )	- Y
NC MD 5067	Axis name 3rd. real axis ( $A_{3R}$ )	- Z

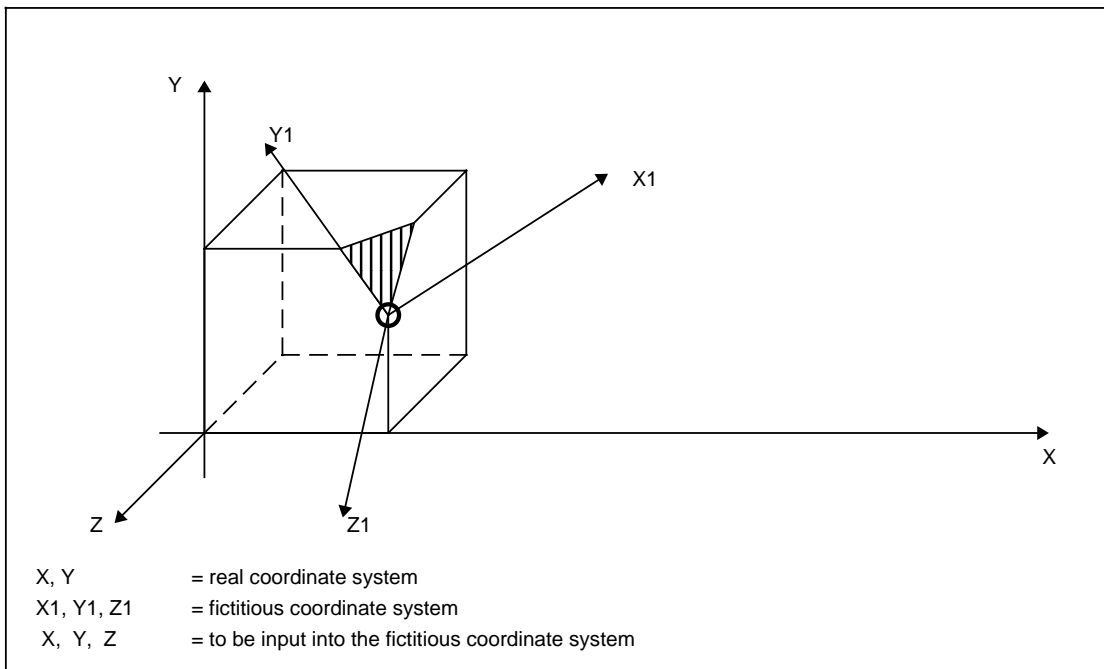

NC MD 5068 to 5069 unassigned (Input: 1111 1111)

See Programming Guide for programming example.

## 11.11 Description of 880N specific functions

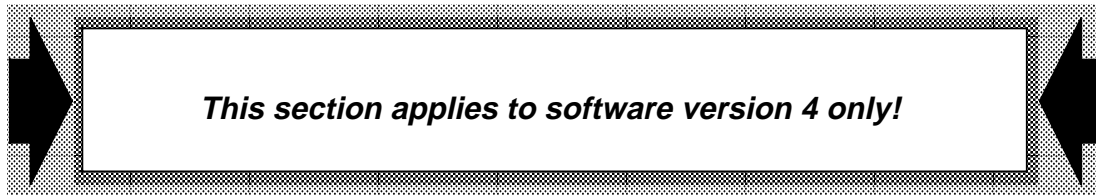

### General

The function descriptions are divided into three parts:

- **Technology nibbling/punching**  
This section contains descriptions of special nibbling and punching specific functions.
- **Technology laser and plasma machining**  
In this section special functions for laser and plasma machining are explained.
- **Technology-independent functions**  
This section contains descriptions of functions which can't be assigned to a particular technology.

### 11.11.1 Technology nibbling/punching

#### 11.11.1.1 Tangential axis (option)

For programming see "SINUMERIK 880N Programming Guide".

In many nibbling machines the punching tool and its die can be rotated.

In this way the tool can be used flexibly often obviating a tool change.

Contours with a good surface finish can be produced.

This movement is controlled by the NC if it is equipped with the "tangential control" option.

#### Tangential control

Tangential control automatically orients the punch tool vertically to the directional vector of the programmed path.

Before the first punching operation on the programmed path the tool places itself vertical to the path directional vector.

A programmed additional angle is added to every angle calculated.

The NC performs path optimization:

It approaches the desired position by the shortest path independently of the direction of rotation.

The tangential control is active during linear and circular interpolation, but only in **active E/H blocks!**

For programming see "SINUMERIK 880N Programming Guide".



**Requirements:**

1. Block decoding for nibbling must be activated:

**NC MD 5014 bit 4 = 1**

2. The control is equipped with the "tangential control" option.
3. **The configured axis name of the tangential axis must be stored in the NC machine data 240!** (Input format as entered in NC machine data 568\* as a decimal number).

**Example:**

Axis name C1 NC MD 568\* = 00010101 is equivalent to decimal 21

- **Parallel axis for rotatable tool**

The axis for the die can be driven through a gearbox or with the option "parallel axis for rotatable tool" through its own NC coupled axis.

This axis need not be programmed as it automatically moves synchronously to the tangential axis.

**The programmed axis name of the "parallel axis for rotatable tool" must be stored in NC machine data 244!** (Input format as entered in NC machine data 568\* as a decimal number)

**Example:**

Axis name C2 NC MD 568\* = 00100101 is equivalent to decimal 37

**Caution:**

If the parallel axis has a different position to the leading tangential axis incorrect positioning of the coupled axis could result.

This problem occurs:

- after the coupled axis of leading axis has been moved independently, e.g. in JOG mode
- or after reference point approach, if a program is activated while the reference point values are not equal, in which the tangential control and the X or Y axis are programmed at the same time.

If NC machine data 560\* "actual value display modulo 360 degrees" is set, the positions of the two axes could be different even if the same position is displayed (check in the service display for the axes).

**Remedy:**

At the beginning of **every program** the tangential axis is programmed on its own in a block without other traverse movements, e.g. C0. In this way both axes are moved to an identical position.

The following program can then be processed correctly.

**Note**

The tangential axis **and** the parallel axis can be moved together with a **single** direction key, if the traverse command is given for both axes in the PLC program (e.g. "traverse command JOG +" 3rd axis DB32 D9.7 and 4th axis D13.7 with the same logic-gating).

e.g.: (extract from PLC program)

```

:
:
A DB 32
U E 65.7   Direction key +Z
= D 9.7    JOG traverse command + 3rd axis
= D 13.7   JOG traverse command + 4th axis
:
:
    
```

- **Tangential control modal** **(MD 5027 bit 2)**

Activated if NC machine data 5027 bit 2 = 1

To facilitate programming the tangential control can also remain active outside the calling block. In this way the tangential axis need not be programmed in every block.

- **Deactivate the modal tangential control with M\*21** **(MD 5027 bit 3)**

Either M\*20 or M\*21 can be configured to deactivate the modal tangential control:

**MD 5027**    **bit 3 = 0** deactivate tangential control with M\*20  
                  **bit 3 = 1** deactivate tangential control with M\*21

### 11.11.1.2 Clamp protection (option)

The clamp protection option permits a software protection from collision of units in the working area with the clamps. Such a unit might be the punching head or a laser cutter.

- **Overview of machine data**

**Requirements for clamp protection:**

**Block decoding for nibbling must be activated machine data 5014 bit 4 = 1**

The following tables show the possible combinations. They only apply to controls with the clamp protection option:

**MD 5028**    **bit 0 bit 1**    Number of clamps present

Bit 1 Bit 0	Function
0 0	2 clamps
0 1	3 clamps
1 1	4 clamps

**MD 5028 Bit 2 bit 3** Clamp protection procedure

Bit 2 Bit 3	Function
0 0	<p><b>Avoid clamps:</b></p> <p>The clamps defined via R parameters are avoided with the programmed velocity. This can generate up to two additional blocks.</p>
0 1	<p><b>Reduction velocity:</b></p> <p>Within a clamp protection area defined in R parameters the velocity is reduced. The path into and out of the clamp protection area is divided into two parts, that with the programmed velocity and that with the reduced velocity.</p>
1 1	<p><b>Deselectable clamp avoidance:</b></p> <p>Clamp avoidance can be deselected via a configurable M function (machine data 243) (see above). The clamp protection areas then function as working area limitations. After an M function from the Mx20 group has been programmed the clamps are avoided with the programmed velocity.</p> <p>If this type of clamp protection is selected the clamps are protected in JOG and INC modes as well.</p>

**MD 5028 bit 4** Clamps on the operator side  
The clamps are on the side of the machine facing the operator.

**MD 5029 bit 1** Updating of clamp protection area types with T programming

**= 1** The clamp protection type is updated by programming the T number in the part program.

**= 0** (Only possible with the option "PLC additional interface"). Through the PLC additional interface the tool type is entered in DB33 DI7 by the PLC, e.g. tool type 100. From the corresponding tool offset memory, D100 in the example, the type of clamp protection entered is activated. If, for example, tool type three is entered in D100, it is then active for the clamp protection area.

Activation is initiated with the signal from the PLC to NC "acknowledgement M06 (D6.1)".

- MD 5029 bit 4** (from software version 4) output auxiliary functions at the clamp protection limit
- = 1** No output of auxiliary functions (Mx20) at the clamp protection limit by NC internal insertion blocks.
  - = 0** Auxiliary function output at the clamp protection limit by insertion blocks.

• **Input values**

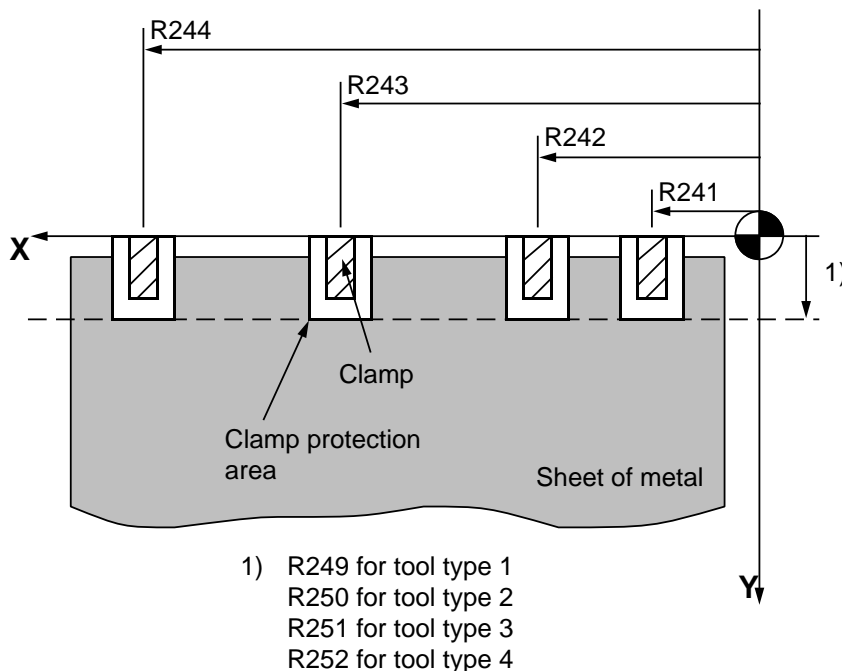

Input values for clamp protection of the SINUMERIK 880N are the positions of clamps 1 to 4 on the X axis and the X and Y dimensions of the clamps.

The individual values are stored in R parameters.

- R241 Position of the first clamps on the X rail
- R242 Position of the second clamps on the X rail
- R243 Position of the third clamps on the X rail
- R244 Position of the fourth clamps on the X rail  
 where  $R241 < R242 < R243 < R244$ !
- R245 Clamp dimension in X direction for tool type 1
- R246 Clamp dimension in X direction for tool type 2
- R247+R268 Clamp dimension in asymmetrical protection areas for tool type 3
- R248+R269 Clamp dimension in asymmetrical protection areas for tool type 4
- R249 Clamp dimension in Y direction for tool type 1
- R250 Clamp dimension in Y direction for tool type 2
- R251 Clamp dimension in Y direction for tool type 3
- R252 Clamp dimension in Y direction for tool type 4

All inputs are in the set input system.

The tool type 1 to 4 is selected via cell P7 of the tool offset memory, see Section 2.3.

The input values are updated on the first NC start or with M\*29.

- **Clamps on the user's side**

**(NC MD 5028 bit 4 = 1)**

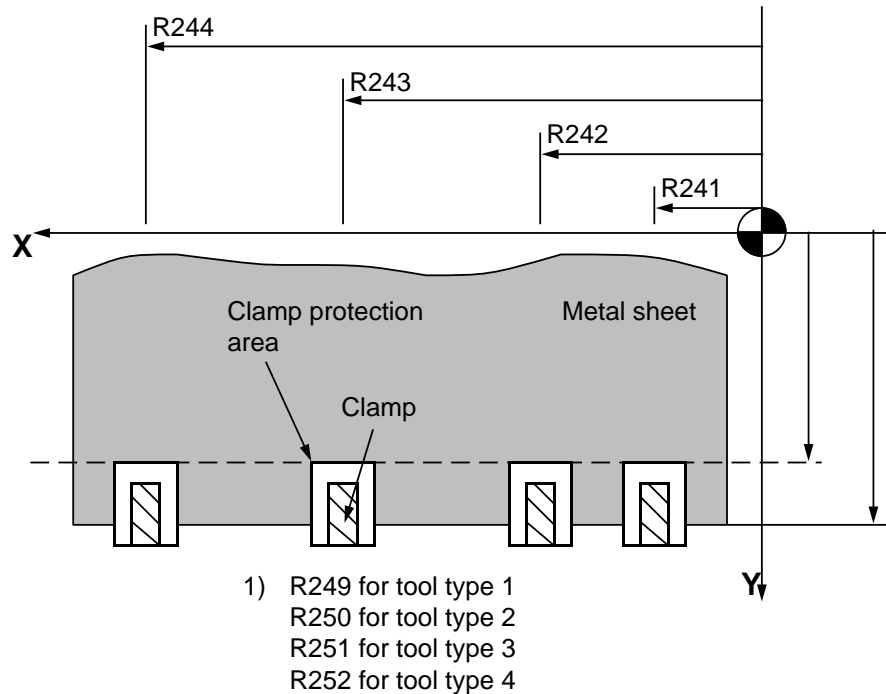

If the **clamps are on the user's side**, NC machine data **5028 bit 4 = 1** must be set.

The clamp protection area in the Y direction extends, for example, for tool type 1, from R249 to the positive software switch of the Y axis.

- **Selection of the tool type**

The diameter of the tool adapter can be different with every tool change. On the SINUMERIK 880N four different clamp protection areas are possible for four different tools.

The type is stored in the tool offset memory and taken referred to when the tool is selected.

**Important: T programming must be performed in channel 1!**

Two variants can be configured:

**MD 5029 bit 1 = 1:** The programmed T No. corresponds to the D no. of the tool offset memory.

**Example:**

`N5 T100` The clamp protection radius from tool offset memory D100 becomes active.

If, for example, the values 3 is entered in D100 in the cell for the clamp protection area (P7), the clamp protection area is active for tool type 3.

**MD 5029 bit 1 = 0:** The programmed T No. is assigned to a D No. by the PLC, see Description MD 5029 Section 2.1.

**Structure of the tool offset memory:**

For explanations of the tool offset memory see SINUMERIK 880N Programming Guide.

<b>D1 SIN 880 N</b> without nibble UMS		<b>SIN 880 N</b> with nibble UMS	
<b>0</b>	Tool number		
<b>1</b>	Tool type	<b>0</b>	Multiple tool radius
<b>2</b>	L1 geometry	<b>1</b>	Multiple tool initial angle
<b>3</b>	L2 geometry	<b>2</b>	Multiple station number
<b>4</b>	Diameter/radius		
<b>5</b>	L1 wear		
<b>6</b>	L2 wear		
<b>7</b>	Diameter/radius	<b>6</b>	Clamp prot. area type 1 to 4
<b>8</b>	L1 base		
<b>9</b>	L2 base		

- **Clamp protection**

- **Clamp avoidance**

Activation: the function can be activated via machine data 5028 bits 2 and 3 = 0.

The option clamp avoidance chooses between four routines to be processed. The selection criterion is the starting point of the last punch hole and the destination point of the next punch hole.

**Routine 1: Start and destination outside the clamp protection area**

No additional compensatory movements are generated.

**Routine 2: Start and destination outside the clamp protection area**

An additional movement is generated with M20 (movement 1) and the clamp protection limit in Y is reached. After this the programmed final position is approached (movement 2).

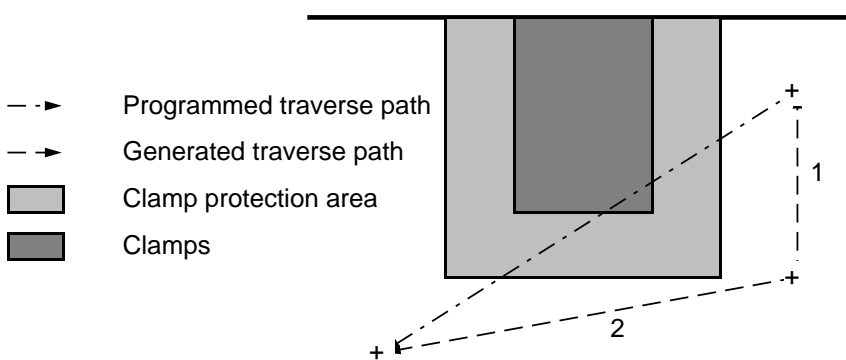

**Routine 3: Start outside, destination within the clamp protection area**

An additional movement is generated with M20 (movement 1). Then the programmed X position is approached. The second movement approaches the programmed final position.

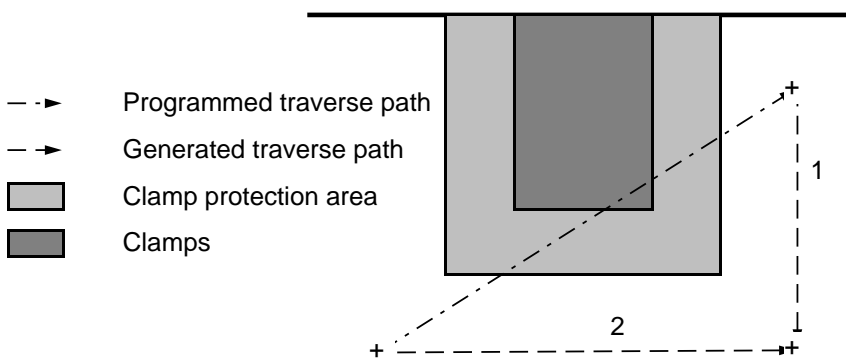

**Routine 4: Start and destination in the clamp protection area**

The first compensatory movement leaves the clamp protection area in Y moving to the end of the clamps with M20 (1st movement). The second compensatory movement approaches the programmed final position in X with M20 (2nd movement). Finally the programmed final position in the clamp protection area is approached (3rd movement).

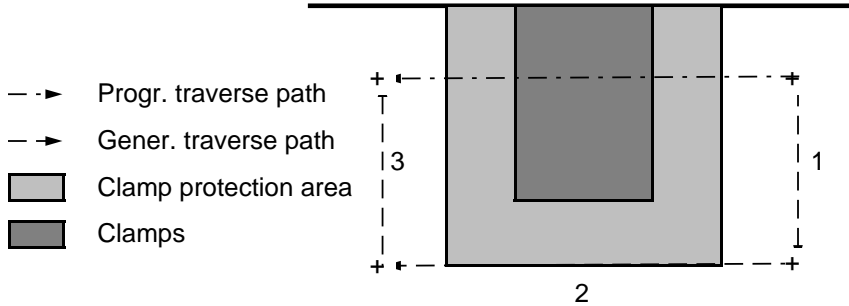

**Note:**

If the path to be traversed in the clamp protection area is smaller than the clamp dimension in X, no compensatory movements are generated.

- **Velocity reduction in the clamp protection area**

Activation: this function can be activated via machine data 5028 bit 2 = 0 bit 3 = 1.

The reduced velocity option in the clamp protection area chooses between four routines to be processed. The selection criterion is the start of the last punch hole and the destination of the next punched hole.

**Routine 1: Start and destination outside the clamp protection area**

No additional compensatory movements are generated.

**Routine 2: Start and destination outside the clamp protection area**

An additional movement is generated with M20 (movement 1) and the clamp protection limit in Y is reached. After this the programmed final position is approached at the programmed feedrate.

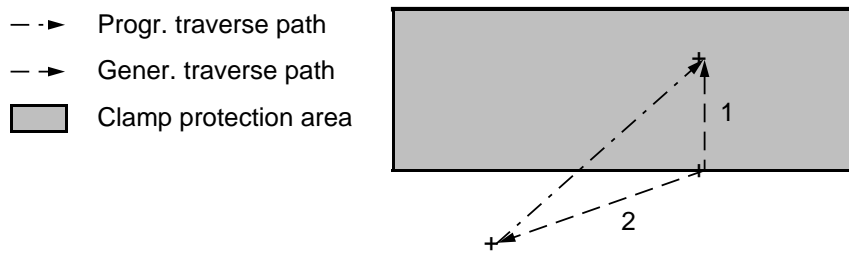



**Routine 3: Start outside, destination within the clamp protection area**

The limit of the clamp protection area is approached at programmed feedrate (movement 1 with Mx20). At this point the tangential axis has reached the programmed or calculated position. Then the programmed Y position is approached at feedrate (2nd movement).

- ▶ Programmed path
- ▶ Generated path
- Clamp protection area

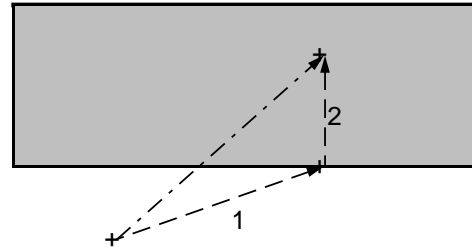
**Routine 4: Start and destination within the clamp protection area**

The programmed final position is approached at feedrate.

**Note:**

The reduced velocity must be specified in machine data 245.

- **Clamp protection for laser and plasma machining (deselectable clamp avoidance)**

Activation: this function can be activated via machine data 5028 bit 2 and 3 = 1.

The clamp protection procedure, reduction velocity in the clamp protection area and the avoidance of the clamps are specially tailored to nibbling and punching. They use linear interpolation as the decision criterion for start/destination monitoring because all movements on punching and nibbling machines use this type of interpolation.

These two procedures can only partially be used for laser and plasma machining because start/destination monitoring fails on circular interpolation or spline, see the following diagram.

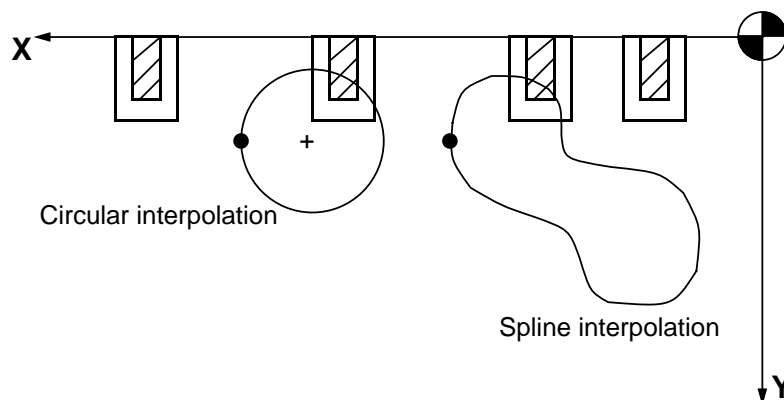

In this case, where any contours are machined, a sort of working area limitation is used. The clamps and their protection areas are software areas that cannot be entered while the laser or plasma is active in any type of interpolation. This protection area is monitored in interpolation cycles. If the protection area is reached within the next interpolation cycle the paths of all axes are interrupted or no further traverse commands are accepted. The current following error is reduced and the alarms "Working area limit X +", "Working area limit X -", "Working area limit Y -" and "Destination in the clamp protection area". The latter alarm is removed with CANCEL. After that it is possible to move only Y + in JOG or INC mode up to the edge of the protection area. The alarms can then be removed with RESET and the axes can be moved in all directions. This type of clamp protection is active in JOG and INC modes too. The user must make sure that the protection area limits are correctly input (especially when the position of the clamp centre is modified).

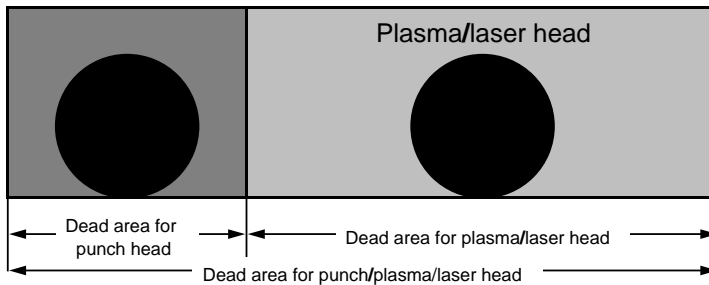

Specially for combined punch, laser or plasma machining centres (see above for possible configuration) asymmetrically divided clamp protection areas are also monitored. These are input via R parameters and selected by selecting the tool type. Tool types 1 and 2 still manage symmetrical clamp protection areas, tool types 3 and 4 can be use for the asymmetrical division of the clamp protection area.

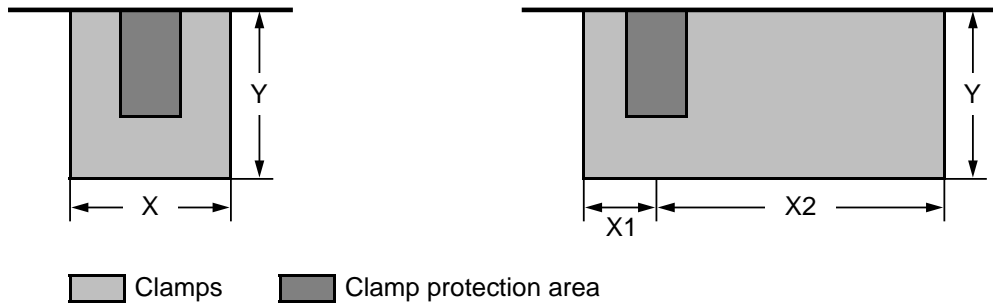

For example, tool type 1 could be the dead area of the punch head (symmetrical protection area), tool type 2 could be the dead area of the laser or plasma head (symmetrical protection area). Tool type 3 could be the monitoring of the asymmetrical protection area for an active laser or plasma head, if the punch head cannot be started up in a safe position.

When the option "deselectable clamp avoidance" is selected the clamp avoidance procedure is selected via the following M functions.

M functions	Mode	Clamp avoidance procedure
Mx20, Mx22, Mx25, Mx26, Mx27, Mx28*)	Punching, nibbling, laser machining, plasma operation	Clamp avoidance software limit switch criterion

\*) freely configurable via MD 243, x can be set via MD 5056 bit 2 and bit 3

The protection areas are selected via a T number and the appropriate tool type. The tool type is in the TOA table and can thus be influenced by the PLC.

**Note on programming:**

If this clamp protection is active, a **@714** block **must be** programmed **before M\*29** (update clamp position), otherwise the clamp protection works with incorrect values!

- **R parameter assignment**

Example of an input screen for the new clamp protection areas

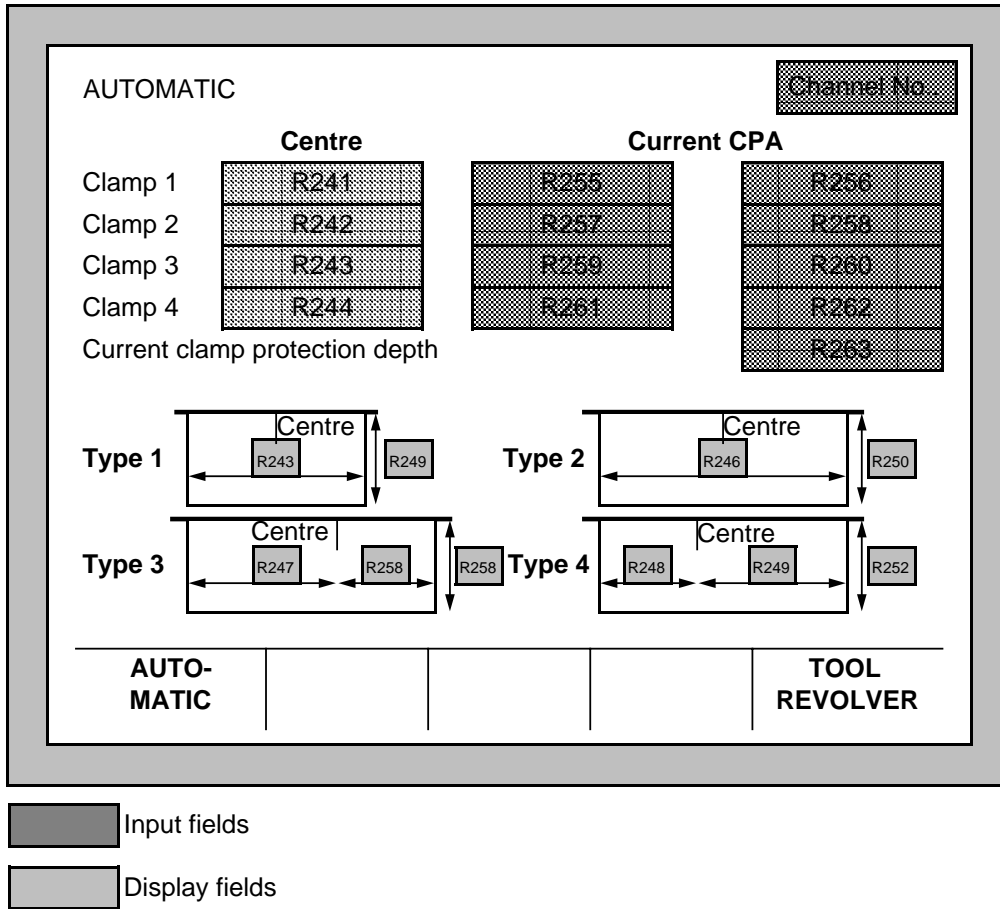

## R parameters for the clamp protection area

The following R parameters in channel 1 are used for clamp protection. They must be set as follows when clamp protection is active:

R241:	Clamp 1 centre position
R242:	Clamp 2 centre position
R243:	Clamp 3 centre position
R244:	Clamp 4 centre position
R245:	Clamp dimension in X for tool type 1
R246:	Clamp dimension in X for tool type 2
R247+R268:	Clamp dimension in X for tool type 3 asymmetrical clamps
R248+R269:	Clamp dimension in X for tool type 4 asymmetrical clamps
R249:	Clamp dimension in Y for tool type 1
R250:	Clamp dimension in Y for tool type 2
R251:	Clamp dimension in Y for tool type 3
R252:	Clamp dimension in Y for tool type 4
R268:	Clamp dimension in X for asymmetrical clamp protection area tool type 3
R269:	Clamp dimension in Y for asymmetrical clamp protection area tool type 4

Diagnostics R parameters:

R253:	X position on crash (clamp avoidance)
R254:	Y position on crash (clamp avoidance)
R255:	Start clamp protection area 1
R256:	End clamp protection area 1
R257:	Start clamp protection area 2
R258:	End clamp protection area 2
R259:	Start clamp protection area 3
R260:	End clamp protection area 3
R261:	Start clamp protection area 4
R262:	End clamp protection area 4
R263:	Depth of the current clamp protection area in Y (tool type dependent!)
R278:	Current clamp protection type

### - Update clamp protection with Mx29

The clamp positions can be programmed at the beginning of the program and are thus part of the part program. When the code M\*29 is called, the SINUMERIK takes the current contents of parameters R241 to R 244 as the clamp centre positions. The parameters must first have been assigned position values by the part program. Possibly in a subroutine. The current tool type is taken into account.

#### Note:

The centre positions of the clamps are assigned in ascending order.

#### Programming note:

If the clamp protection for laser and plasma machining is activated (deselectable clamp avoidance), a block with **@714 must** be programmed **before M\*29** (update clamp positions). Otherwise the clamp protection works with incorrect values.

## 11.11.2 Laser and Plasma Machining Technology

### 11.11.2.1 Laser power control (option)

The analog voltage for the laser power control is output at the first two analog outputs of the mixed I/O module in the servo area. Up to two lasers are possible.

#### Restriction:

Laser power control is only possible in channel 1!

#### Corresponding NC machine data:

MD 5003 bit 2 = 0	Auxiliary function output before traversing (not allowed)
MD 5013 bit 2 = 0	Address extension for S functions (not allowed)
MD 5027 bit 7	Laser minimum voltage not equal to zero
MD 5027 bit 6	Laser voltage after NC reset = 0
MD 5028 bit 5 = 1	Rapid M functions
MD 5028 bit 6, 7	Group selection hundred decade
MD 5056 bit 5	No output of laser S functions to the VDI interface
MD 5056 bit 7	Second laser available
MD 5057 bit 4 = 1	Output of laser voltage on mixed I/O module

The output voltage for the laser power control can be influenced by inputs 0.3 to 0.6 of the mixed I/O module in the servo area.

#### Function description:

The laser power control function permits you to influence the laser power as required for laser cutting or welding. You can have path velocity power control for cutting and ramp functions of time or distance for welding. The key data of the laser power control are programmable. The laser voltage is output at the analog spindle output.

The function is subdivided into three groups:

1. Preparatory definition of the key data
2. Selection and execution of the laser function
3. Rapid M functions for the laser control

- **Preparatory definition of the key data**

The key data for the laser power control are normally defined at the beginning of a part program, but can be changed while a program is being executed. To achieve this, the data for the voltage values E, the path velocity F and the times are defined with special M functions (M\*31 - M\*36). This assignment is made in up to six NC blocks, which must have the form shown in Table 1. They can be programmed in any order.

Programmed NC block					Assignment					
M*31	E	F	T	*	E	U1	F	V1	T	T1
M*32	E	F	T	*	E	U2	F	V2	T	T2
M*33	E	F	T	*	E	U3	F	V3	T	T3
M*34	T								T	T4
M*35	T								T	T5
M*36	T								T	T6

Table 1: Assignment of the limit data

\* In these blocks single functions can be programmed too.

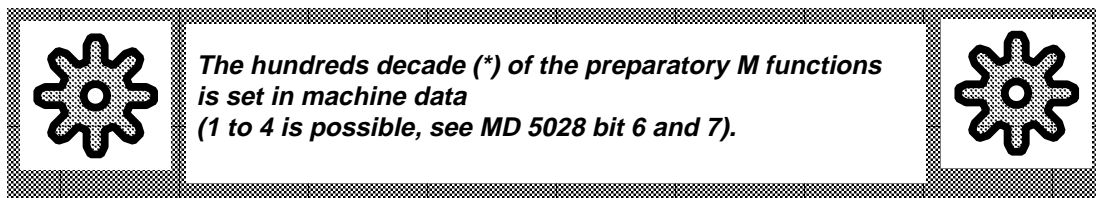

**Meaning:**

E Voltage values for the laser control  
Unit: volt (V)

F Path velocity  
Unit: mm/min or m/min

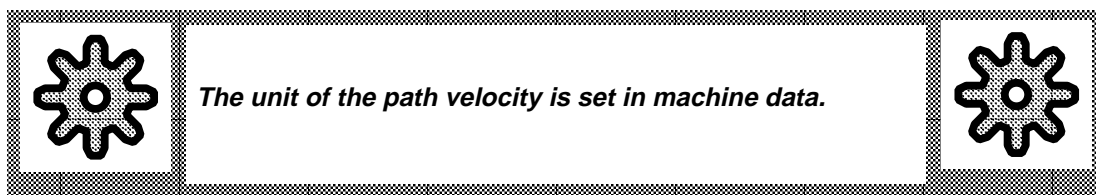

T Time  
Unit: ms

The addresses E/F/T only have this special function in conjunction with M\*31 ... M\*36. This makes it possible to create a laser characteristic specific to the machine or adapted to the material. Times T4 - T6 correspond to voltages U1 - U3.

**Program sample:**

```

N05 M231 E1.5 F3 T1000
N10 M232 E5.8 F8 T2000
N15 M234 T500

```

The NC block N05 defines the data for the lower limit value of the characteristic (minimum voltage  $U1 = 1.5V$ , minimum velocity  $V1 = 3 \text{ m/min}$  and time  $T1 = 1s$ ). Block N10 defines the upper limit (max. voltage  $U2 = 5.8 V$ , minimum velocity  $V2 = 8$  and time  $T2 = 2s$ ). Block N15 specifies a pulse time of  $T5 = 0.5s$ . This is automatically linked to voltage  $U2 = 5.8 V$ . In this example "\*" defaulted with value 2 for M group .

- **Selection and execution of the laser function**

The laser power is influenced by selection special S functions. This is done straight after definition of the key data for the laser power control. The programmed S function is active at the beginning of the block and remains valid until a new S function is selected. Only one S function is possible per block but any number of them can be used within a program. The table below (Table 2) lists the S functions that can be used and their effect on the laser power control.

S functions	Laser voltage
S 00 - S 05	Constant voltages
S 06 - S 09	Path velocity control
S 10 - S 12	Path control
S 13 - S 18	Time control

Table 2: S functions of the laser power control

**Program example:**

```

N05 M231 E1.5 F3 T1000
N10 M232 E5.8 F8 T2000
N15 M234 T500
...
N30 X200 Y150 S7
...
N50 X100 Y100 S0

```

For a description of NC blocks N05 to N15 see above. The laser voltage is controlled in block N30 using a path velocity control. In block N50 the laser voltage is switched off.



- **Rapid M functions for the laser power control**

In addition to the S functions, rapid M functions can also be programmed. Depending on how they are programmed, they set or clear output bits on the output module in the SERVO area on a block change before traversing the axes (see Table 3). They can be used, for example, to open or close the shutter.

Mx..	Byte/bit on the output module	Mx..	Byte/bit on the output module
00	1.0 on	10	1.0 off
01	1.1 on	11	1.1 off
02	1.2 on	12	1.2 off
03	1.3 on	13	1.3 off
04	1.4 on	14	1.4 off
05	1.5 on	15	1.5 off
06	1.6 on	16	1.6 off
07	1.7 on	17	1.7 off
08	1.0 ... 1.3 on	18	1.0 ... 1.3 off
09	1.4 ... 1.7 on	19	1.4 ... 1.7 off

Table 3: Rapid M functions

The hundreds decade of this rapid M function can be programmed via machine data 5028 bits 6+7 (1 to 4 possible).

In addition to the rapid M functions of the Mx00 - Mx19 group a further rapid m function (configurable) can be used for the laser control. This remains pending at the interface until another M function from the M\*20 group is selected (\*programmable from 0 through 3). Reset, M02 or M30 deletes all rapid M functions.

**Program sample:**

```

N05 M231 E1.5 F3 T1000
N10 M232 E5.8 F8 T2000
N15 M234 T500
...
N30 X200 Y150 S7 M201
...
N50 X100 Y100 S0 M211

```

For a description of the NC blocks N05 to N15 see above. In block N30 the laser voltage is controlled as a function of path velocity. At the same time, byte 1 bit 1 is set on the output module in the SERVO area. In block N50 the laser voltage is switched off and byte 1 bit 1 on the output module is cleared.

• **Description of the laser function**

This section describes the S functions of the laser power control.

**a) Output of constant voltages**

The laser voltage is output as a step function on a block change

- S00 Laser output voltage = 0 V
- S01 Laser output voltage = U1
- S02 Laser output voltage = U2
- S03 Laser output voltage = U3
- S04 Laser output voltage = 10 V
- S05 Hold laser output voltage at current value

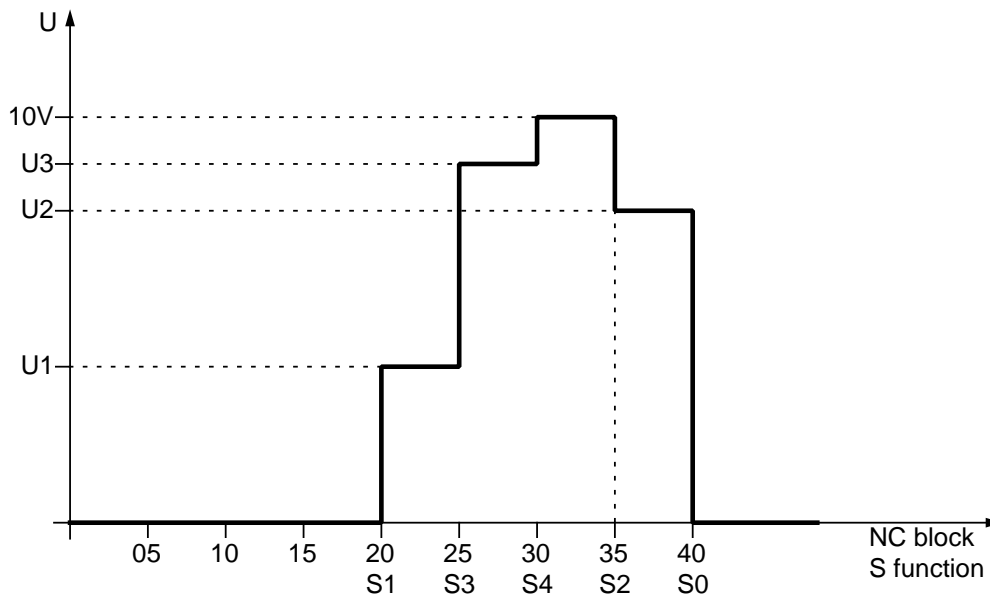

Fig. 1: Example of laser constant voltages

**Program sample:**

```

N05 M231 E4
N10 M232 E8
N15 M233 E9
N20 X100 S1 F10
N25 X200 Y150 S3
N30 X150 S4
N35 X100 Y100 S2
N40 X0 Y0 S0
    
```

In NC blocks N05 to N15, the limit values for the laser power control are defined. In NC blocks N20 to N35 the laser voltages  $U = 4V$ ,  $U = 9V$ ,  $U = 10V$  and  $U = 8V$  are output one after the other as a step functions after a block change when the appropriate S function is programmed. In block N40, the laser voltage is switched to zero by S0.

## b) Output of the laser voltage as a function of the contour velocity

The laser voltage is output as a function of the current path velocity. This applies as long as the S function for path velocity control is selected.

- S06 The laser voltage output proportional to the current path velocity between  $V1/U1$  and  $V2/U2$ .
- S07 The laser voltage output proportional to the current path velocity between  $V2/U2$  and  $V3/U3$ .
- S08 The laser voltage output proportional to the current path velocity between  $V1/U1$  and  $V3/U3$ .
- S09 The laser voltage output proportional to the current path velocity between  $V1/U1$  and  $V2/U2$  and between  $V2/U2$  and  $V3/U3$ .

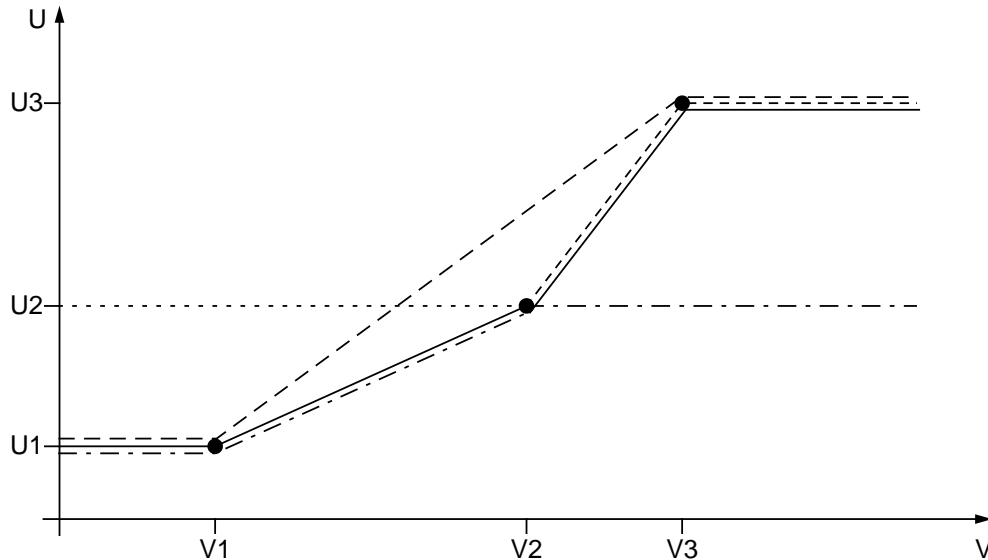

- - - Laser output voltage proportional to the path velocity between P1 and P2
- · - Laser output voltage proportional to the path velocity between P2 and P3
- · · Laser output voltage proportional to the path velocity between P1 and P3
- Laser output voltage proportional to the path velocity between P1 and P2 and P2 and P3 (linked characteristic)

If  $V = 0$  then  $U = 0$  or  $U = U1$ ,  
depending on machine data 5027.7

Fig. 2: Characteristic of path velocity control

### Program sample:

```

N05 M231 E4 F3
N10 M232 E8 F8
N15 M233 E9 F12
N20 X100 S1 F7
N25 X200 Y150 S6
N30 X150 S8 F10
N35 X100 Y100
N40 X0 Y0 S0

```

In NC blocks N05 to N15 the limit values for the laser power control are defined. In block N20 the laser voltage is switched to  $U = 4V$ . Block N25 contains the path velocity control of the laser voltage between the key data  $U = 4V/F = 3 m/min$  and  $U = 8V/F = 8 m/min$ , programmed velocity  $F = 7 m/min$ . Blocks N30 to N35 control the laser voltage on the characteristic with the key data between  $U = 4V/F = 3 m/min$  and  $U = 9V/F = 12 m/min$ , programmed velocity  $F = 10 m/min$ . In block N40 the laser voltage is switched to zero with S0.

**c) Output of the laser voltage as a function of the path**

The laser voltage is output under distance control. The current voltage of the previous block is changed to the voltage value deselected with the S function over the path programmed in the NC block. This can entail either ramping up or ramping down the voltage. An S function must be programmed in the next block.

- S10 Laser output voltage as function of the distance, output voltage U1
- S11 Laser output voltage as function of the distance, output voltage U2
- S12 Laser output voltage as function of the distance, output voltage U3

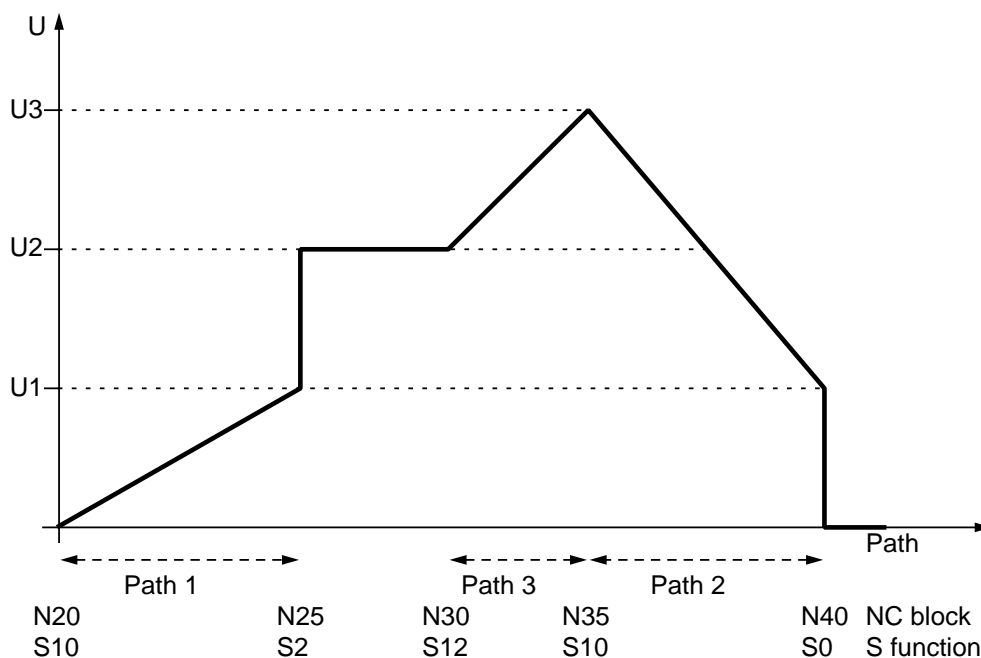

Fig. 3: Example of path control of the laser voltage

**Program example:**

```

N05 M231 E4
N10 M232 E8
N15 M233 E9
N20 X100 S10 F10
N25 X200 Y150 S2
N30 X150 Y200 S12
N35 X100 Y100 S10
N40 X0 Y0 S0
    
```

In NC blocks N05 to N15 the limit values for the laser power control are defined. In block N20 the laser voltage is ramped up from 0V to  $U = 4V$  over the distance  $X = 100$ . Block N25 contains a step function with  $U = 8V$ . In block N30 the laser voltage is ramped up from  $U = 8V$  to  $U = 9V$  over the contour path, in the following block the voltage is ramped down to  $U = 4V$ . In block N40 the laser voltage is switched to 0V with S0.

#### d) Output of the laser voltage as a function of time

The laser voltage is output under time control. This can be effected with ramp or pulse functions. The time parameters are entered in milliseconds.

S13	Laser output voltage as function of the time T1, output voltage U1 (ramp)
S14	Laser output voltage as function of the time T2, output voltage U2 (ramp)
S15	Laser output voltage as function of the time T3, output voltage U3 (ramp)
S16	Laser output voltage as function of the time T4, output voltage U1 (pulse)
S17	Laser output voltage as function of the time T5, output voltage U2 (pulse)
S18	Laser output voltage as function of the time T6, output voltage U3 (pulse)

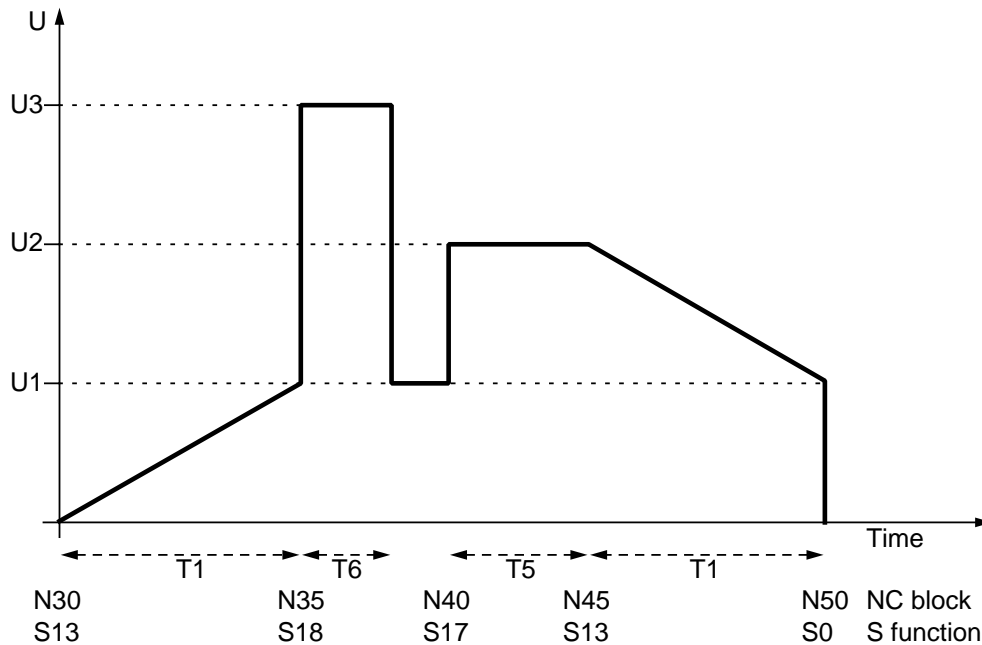

Fig. 4: Example of time control of the laser voltage

#### Program example:

```

N05 M231 E4 T100
N10 M232 E7
N15 M233 E9
N20 M235 T75
N25 M236 TT50
N30 X100 S13 F10
N35 X200 Y150 S18
N40 S17
N45 X100 Y100 S13
N50 X0 Y0 S0

```

In NC blocks N05 to N15, the limit values for the laser power control are defined. In block N30 the laser voltage is ramped up from the value  $U = 0V$  to the value  $U = 4V$  in the time  $T = 0.1s$ . The next block initiates a voltage pulse lasting 0.05s to the value  $U = 9V$  (If the traverse block takes longer than 0.05s the voltage drops after 0.05s to the value that was valid before the block). In block N40 a pulse of 0.07s with voltage  $U = 7V$  is programmed. In block N45 the laser voltage is ramped to  $U = 4V$  in 0.1s with S13. In block N50 the laser voltage is switched to zero.

#### e) Variable voltage and time values on the laser power control

The key data for the characteristic can be changed in a running part program with preparatory M functions. The new key data are programmed as in the header. They are active immediately (@ 714 required). This can cause bottlenecks in execution if frequent changes are necessary (e.g. in continuous-path control). To avoid these bottlenecks new ways of changing voltage and time values during a running part program were created. The new voltage and time values are given in the block directly and are only valid in the block. In this way all values within the definition range can be specified without restriction. The output voltage attained after this block remains until a new S function is programmed.

A configurable voltage value is specified via an E function, a configurable time value via a T function. The E and/or T function is programmed together with an S function in the block in question. The E and T functions have an address extension 1 to identify the first laser. It is not possible to work with variable voltages with the second laser.

If there is not an E or T function in the block the S10 and S18 functions access the key data programmed in the header as previously. Function S05 holds the current voltage if there is not an E1 function in the block. If variable E1 and/or T1 functions are used with every S function, you need not program the key data (only for S5 and S10 to S18 with the first laser).

#### Program sample:

```

N05 M231 E4 T200
N10 M232 EE8 T300
N15 M233 E10
N20 M234 T50
N25 X100 Y100 S1 F10
N30 X200 S11 E1 = 6
N35 Y200 S11
N40 X150 S13 E1 = 9 T1 = 300
N45 Y100 S15
N50 X100 S15 T1 = 75

```

In NC blocks N05 to N15 the key data for the laser power control are defined. Block N30 contains a path control with a new key voltage  $E1 = 6V$  (otherwise  $E = 8V$  from the preparatory M functions). The laser voltage ramps up to 6V by the end of the block. In block N35 the final position of the block with laser output voltage  $E = 8V$  is attained with the same path control function S11 but with the voltage value from the header. In block N40 the final position X150 is approached with time ramp function S13 and the changed key data  $E1 = 9V$  and  $T1 = 300$  ms. The pulse control in blocks N45 and N50 is traversed once with the pulse time from the preparatory functions  $T = 50$  ms and once with the variable pulse time  $T1 = 75$  ms.

In addition to the new function of variable definition of the voltage and time key data alarm 3195 was also introduced. This alarm is triggered if the E values exceed the value 10 or if the ratio of the path to the voltage stroke or of the time to the voltage step cannot be calculated.

- **Special function laser power control**

A second analog output can be used in addition to the laser power control. The special function can be used, say, to control a second laser or the oxygen supply to the first laser.

- **Requirements**

Software version 4 with a mixed I/O module in the servo area.

- **Preparatory definition of the key data**

The key data of the laser power control for the second laser must be defined at the beginning of an NC part program. They are freely selectable and not coupled to the key data of the first laser.

Programmed NC block	Assignment
M*41    E    F    T    *	E U1                    F V1                    T T1
M*42    E    F    T    *	E U2                    F V2                    T T2
M*43    E    F    T    *	E U3                    F V3                    T T3
M*44    T	T T4
M*45    T	T T5
M*46    T	T T6

*Assignment of the key data*

\* In these blocks individual functions can be programmed.

x = 1... 4 is set in machine data 5028/bit 6 + 7

- **Execution of the laser function**

The selection and execution of the laser function in the NC part program is performed by programming S functions.

The laser voltages for both lasers can be programmed to be output as:

- Constant voltages
- Voltage as a function of the path velocity
- Voltage as a function of the path
- Voltage as a function of the time

A different function can also be selected for each of the two lasers.

Both lasers can be addressed via a four-decade S function. The upper two decades are used for the second and the lower two decades for the first laser.

## S010

3

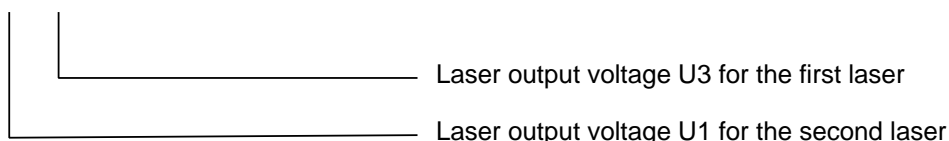

As soon as the option bit "Second laser present" is set, **all** laser specific S functions are interpreted as four-decade S functions.

- S0 is equivalent to S0000 (both laser voltages 0V).
- S3 is equivalent to S0003 (first laser U3, second laser 0V).
- S300 is equivalent to S0300 (first laser 0V, second laser U3).

- **Output of the laser voltage on the mixed I/O card in the SERVO area**

From software version 4, the analog voltages of the laser power control are output via the mixed I/O card in the SERVO area which is included in the scope of supply of the SINUMERIK 880N. The first two analog outputs are used. Pin A3 on switch S2 of this card must be closed. Voltage values are output in position control cycles and a change can only be made in interpolation cycles. The voltage range is 0V - 10V. See Section 5 for the wiring. Output via the mixed I/O card is activated via **machine data 5057 bit 4**.



### - Display parameters

R parameters can be used in the first channel to check the set and actual voltages values. The following functions are displayed.

R parameters	Function
R 281	Override laser voltage 1
R 282	Current S function laser 1
R 283	Current S function laser 2
R 284	Actual voltage laser 1
R 285	Actual voltage laser 2
R 286	Set voltage laser 1
R 287	Set voltage laser 2

The laser voltage is displayed in the new AUTOMATIC basic display or in the laser diagnostics display under the softkey "Current block".

### - Override for laser voltage 1

The laser voltage 1 output by the power control can be influenced via the inputs 0.3 to 0.6 of the mixed I/O card. Fixed override factors are assigned to individual bit combinations. These are shown in the following table:

Bit 6	Input byte 0 mixed I/O			Override factor in %
	Bit 5	Bit 4	Bit 3	
0	0	0	0	100
0	0	0	1	95
0	0	1	0	90
0	0	1	1	85
0	1	0	0	80
0	1	0	1	75
0	1	1	0	70
0	1	1	1	65

### - Switching the analog outputs on the mixed I/O card

The analog outputs in the SERVO area can be influenced not only with the laser power control but also with special switching functions. The value range of these switching functions is 0V to 10V. The values are entered in mV. These functions are:

H11 = Switching of first the analog output  
 H12 = Switching of second the analog output  
 H13 = Switching of third the analog output  
 H14 = Switching of fourth the analog output

#### Example:

H13 = 9345      9345 mV are output at analog output 3.

#### Note:

It is not possible to switch analog outputs H11 = to H14 = while S functions for the laser power control are active.

### - Conditions

The analog output voltage and the display of the laser functions can be influenced after RESET via machine data 5027 bit 6 in a similar way to the spindle block. The analog output voltages and the display thereof and the last current S functions remain (machine data 5027 bit 6 = 0), otherwise they are deleted. The override for laser 1 is still active after RESET.

After power-on all display parameters and analog outputs are reset to zero.

The machine data 5003 bit 2 (auxiliary output before traversing) and machine data 5013 bit 2 (automatic address extension for M and S functions) must be zero.

### - Programming rule

The preparatory M functions M\*31 - M\*36 or M\*41 - M\*46 must be written in the part program before the assigned voltage otherwise a general programming error message and nibble error message 3194 are output.

#### Example:

```
M231 E5 T100 F8 Programming correct
E5 M231 T100 F8 Programming incorrect.
"General programming error" and alarm 3194
```

### 11.11.3 Analog tangential angle output (option) from software version 4.2

#### Corresponding NC machine data:

MD 243	M function for laser machining for switching the angle value output
MD 5027	Bit 2 Modal function of the tangential list
MD 5029	Bit 7 Direct of motion related tangential angle output
MD 5056	Bit 2 and 3 Hundreds decade of the special M functions
MD 5057	Bit 4 Output of analog voltage on mixed I/O module

#### Function description:

The voltage corresponding to the tangential angle is output on the fourth analog output of the mixed I/O modules in SERVO local bus. The voltage is output on block change and must be activated with a special M function. The angle values 0° to 360° are converted into voltage values between 0 volts and 10 volts.

If this function is selected, the "tangential control" option must not have been selected and output of the analog voltage on the mixed I/O module must have been enabled in machine data 5057 bit 4. At the same time, the modal function of the tangential axis must have been selected in machine data 5027 bit 2. The M function for switching the analog value output is configurable and is assigned in machine data 243 (e. g. 28). The hundreds decade of this special M function is equivalent to those of the nibble M functions (machine data 5056 bits 2 and 3). The M function is output as a rapid M function on digital output Q0.4 of the mixed I/O module as well as to the VDI interface.

#### Basis of angle calculation

In linear interpolation (G00/G01), the calculated path direction vector is always relative to the positive X axis. The voltage-angle assignment is shown in Fig. 1. There are two ways of calculating in circular interpolation (G02/G03). These can be selected via machine data 5029 bit 7.

Setting the angle relative to the centre (MD 5029.7 = 0)

With this setting the angle is always relative to the centre of the programmed circle. The angle-voltage assignment is shown in fig. 2.

Setting the angle relative to the direction of motion (MD 5029.7 = 1)

In this mode the angle is calculated always relative to the direction of motion. Machine data 5029 bit 7 must be 1. The angle-voltage assignment is shown in Fig. 3. It is important to pay attention to the different directions of rotation.

#### Programming:

Output of the analog angle output must be initiated by a configurable fast M function. The M functions are stored in machine data 243 (e.g 28).

M\*28 switches the voltage on, M\*20 clears the modal voltage output. X can be configured via machine data 5056 bits 2 and 3.

#### Note:

Mx28 is not output to the PLC via the VDI interface. It can only be detected on digital output Q0.4 of the mixed I/O module in the SERVO area.

Angle calculation with linear and circular interpolation has to be activated by switching on the E/H segmentation. For linear interpolation an H segmentation is recommended (H = 1), for circular interpolation an E segmentation. E segmentation divides the circle into straight lines of length E. It is possible to achieve a constant path velocity by selecting continuous-path control. As the E/H segmentation divides the programmed paths (linear or circular) into many short linear sections, the E value must be chosen such that the block change time is never attained. Otherwise drops in velocity might result. The calculated angle output with the first chord of X and Y.

**Example:**

```
N5 G0 X Y F500
N10 X100 Y100 G64
N15 X Y H1 M28
N20 G02 X Y J20
N25 X Y J20 E2
N30 M20
```

No output because the basic setting Mx20 is active  
 Path is divided into **one** partial path, output of voltage 6.25 V  
 No velocity output because E/H is not active  
 Voltage output, M28 is still active  
 Switch off the velocity output

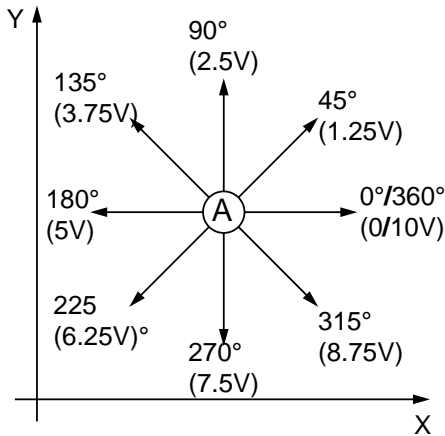

Fig. 1: Angle-voltage assignment linear interpolation

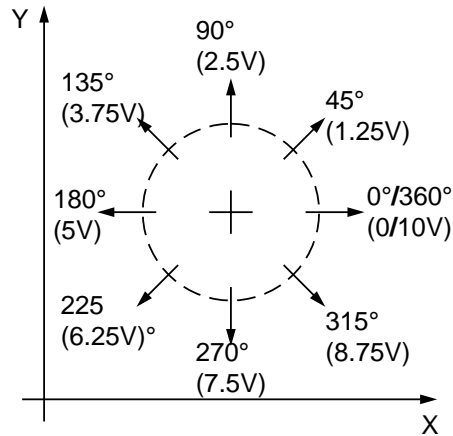

Fig. 2: Angle-voltage-circle interpolation relative to centre

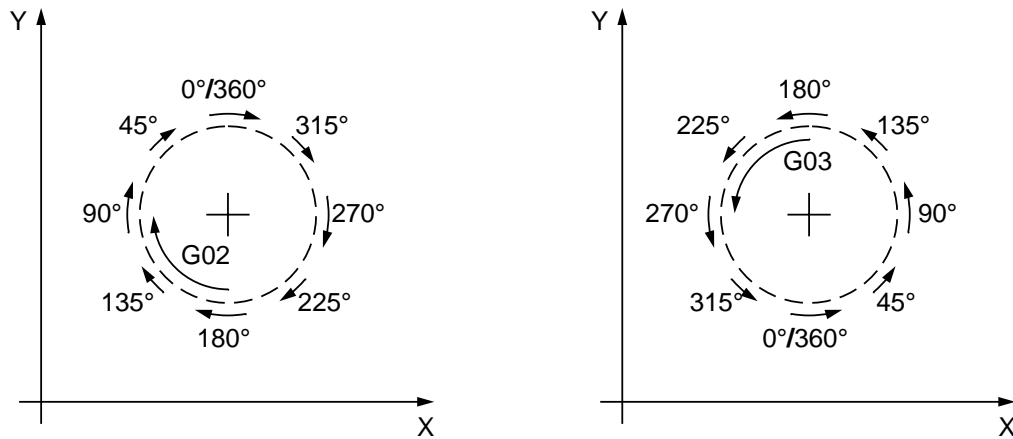

Fig. 3: Angle-voltage assignment circle interpolation, relative to direction of motion

**Note:**

If a full circle is programmed with voltage decreasing from 10V a definition-related step from 0V to 10V occurs at the end of the block. This can be avoided if the circle is programmed to be not quite a full circle. 1  $\mu\text{m}$  less than a full circle is enough.

### 11.11.4 Clamp protection for laser and plasma machining (deselectable clamp avoidance)

#### Requirement for clamp protection:

Block decoding for nibbling must be activated (MD 5014 bit 4 = 1) and the control must be equipped with the option for clamp protection.

The option "deselectable clamp protection" permits a software protection from collision with the clamps of the units within the working area especially for laser and plasma cutting. The units in question could be a laser or plasma cutters, for example.

The Function Description, Section 2.6, contains a detailed description of this clamp protection procedure.

### 11.11.5 Suppression of auxiliary function outputs to the VDI interface

All M/H/S/T auxiliary functions are transferred to the VDI interface (NC to PLC) (if MD 5400 bit 0 = 1).

Because of the PLC cycle time, drops in velocity can occur during short traverse paths in continuous-path control.

These drops are undesirable, for example, during laser cutting.

For this reason transfer of the **S functions for the laser power control (from software version 4.1)** can be switched off via machine data.

#### 11.11.5.1 Laser S functions not transferred to the VDI interface

##### Restriction:

This function can only be supplied from software version 4 of the SINUMERIK 880 N.

If the laser power control is active and this bit is set the function values S0 - S18 and S0000 - S1800 are not output to the PLC via the VDI interface.

<b>MD 5056</b>	<b>bit 5 = 0</b>	Lasers functions are transferred to the PLC
	<b>= 1</b>	No transfer to the PLC

### 11.11.6 Rapid M functions

By programming rapid M functions you can switch on or off certain outputs directly from the part program (without going through the PLC).

They are output before the axes are traversed. This permits time-critical functions such as control of the shutter for laser cutting.

#### Activation:

The rapid M functions are output with NC machine data 5028 bit 5 = 1.

#### Requirement:

"Block decoding for nibbling" **machine data 5014 bit 4 = 1** must be active.

#### Assignment of the rapid M functions to outputs

##### Functions for switching on:

<b>M*00</b>	Output bit	1.0	ON
<b>M*01</b>	Output bit	1.1	ON
<b>M*02</b>	Output bit	1.2	ON
<b>M*03</b>	Output bit	1.3	ON
<b>M*04</b>	Output bit	1.4	ON
<b>M*05</b>	Output bit	1.5	ON
<b>M*06</b>	Output bit	1.6	ON
<b>M*07</b>	Output bit	1.7	ON
<b>M*08</b>	Output bits	1.0 - 1.3	ON
<b>M*09</b>	Output bits	1.4 - 1.7	ON

##### Functions for switching off:

<b>M*10</b>	Output bit	1.0	OFF
<b>M*11</b>	Output bit	1.1	OFF
<b>M*12</b>	Output bit	1.2	OFF
<b>M*13</b>	Output bit	1.3	OFF
<b>M*14</b>	Output bit	1.4	OFF
<b>M*15</b>	Output bit	1.5	OFF
<b>M*16</b>	Output bit	1.6	OFF
<b>M*17</b>	Output bit	1.7	OFF
<b>M*18</b>	Output bits	1.0 - 1.3	OFF
<b>M*19</b>	Output bits	1.4 - 1.7	OFF

(\* = 1 ... 4 can be set in machine data 5028 bits 6 and 7)

The **assignment of the rapid NC input/output byte** is shown in the module overview section "Rapid I/O modules".

Requirements for the output of rapid M functions:

- **NC MD 5014 bit 4 = 1**
  - **NC MD 5028 bit 5 = 1**
  - Assignment NC MD 5028 bits 6 and 7
  - No external RESET must be pending  
**(I0.6 RESET rapid M functions to 0V)**  
 This external RESET acts on 1 signal like programming of M functions M\*18 and M\*19.
  - The external disable of all outputs must not be set  
**(I0.7 disables all rapid outputs to 0V)**  
 This disable acts only as long as a 1 signal is pending. If I0.7 changes back to 0V the previous state is restored.
- If one of these disables is pending the rapid M functions are not output.

**Note:**

The functions NC RESET, M02 and M30 clear all M functions.

**Effect of the rapid M functions:**

The output of the switch-on M function is switched on at the beginning of the block.

When a switch-off M function is programmed, its output is switched off at the beginning of the block.

**Example of rapid M functions:**

In the example the decade of the nibble functions are predefined as 1 (NC MD 5028 bit 6 and 7 = 1).

```

%100
N10 G0 X100 M102      Output bit Q1.2 ON
N210 X300 M112       Output bit Q1.2 OFF
N30 X500 M102        Output bit Q1.2 ON
:
    
```

**Effect of the rapid M functions:**

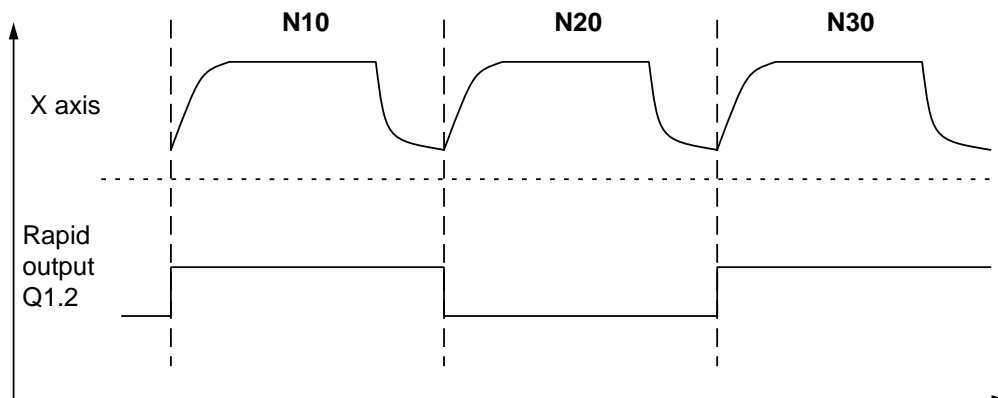



## 11.11.7 Repositioning

### MD 5057 bit 6

In AUTOMATIC mode, the movement in the axes of the measuring circuit CPU for which this option was selected is stopped (up to 5 axes) depending on external signal S3. After that a further signal, S4 can initiate a retraction on the linear contour. The maximum retraction is limited by the memory capacity of the CPU. The retraction is time-related. high velocity = large retraction, low velocity = small retraction. At a velocity of 500 mm/min the retraction path is at least 150 mm. Signal S5 initiates a return to the interruption point on the contour. The interruption point is passed without any drop in velocity. During the retraction movement (S4) and the approach movement (S5) the velocity can be varied between 6.25 % and 100 % by external signals S0 to S2. If the interruption point is overtravelled during the repositioning movement (S5) an automatic switch is made to the velocity at which the interruption was made. Braking activated of signal S3 reduces velocity with the deceleration defined in the machine data (as with "Machine stop"). The axes remain on the programmed contour. The retraction is started with the same ramp as was used for decelerating. All further starts and stops are performed without any acceleration ramps (reduce velocity). If the interruption point is overtravelled, the start is made in the deceleration ramp. Addition of the deceleration and acceleration ramps avoids a drop in velocity. If, in the meantime, the override switch has been switched to 0 or feed hold has been activated the machine stops at the interruption point with the deceleration ramp. During the RETRACE movement the actual-value display stops at the interruption point. This function is activated via machine data 5057 bit 6.

Signal name	Function
S0	RETRACE override value 1
S1	RETRACE override value 2
S2	RETRACE override value 4
S3	RETRACE function active
S4	Retraction on contour
S5	Travel to interruption point

**Description of the individual external signals**

**Velocity control during the RETRACE function (S4 and S5)**

S0	S1	S2	Value	Velocity	Ratio
0	0	0	0	100 %	1:1
1	0	0	1	50 %	1:2
0	1	0	2	25 %	1:4
1	1	0	3	12.5 %	1:8

Other bit combinations of S0 to S2 result in a ratio of 1:16.

**Function selection**

**S 3 = 1: RETRACE function active**

Interruption of all axes interpolating together. Deceleration on the normal deceleration ramp (as set in machine data). There is no deviation from the programmed contour. After that the function retract/approach of the interruption point is activated with S4 and S5.

**S3 = 0: No meaning**

The RETRACE function initiated must be terminated via S5 (approach of the interruption point). If a complete stop is intended without a return to the interruption point, the axes involved must be switched to follow-up mode and the program must be aborted with RESET.

**S4 = 1: Retraction**

Start of retraction with the velocity set using bits S0 to S2. The retraction remains active until the limit of the retraction path is reached (depends on the memory) or S4 = 0 is detected. Signal S4 can change from 1 to 0 several times. It is not possible to stop the movement with "Machine stop" or to influence the movement with a normal override. The actual value display is not active. The axis movements are made on the contour travelled in AUTOMATIC mode. On acceleration and deceleration the override stages below that defined are selected for a short time to generate a ramp.

**S5 = 1: Approaching the interruption point**

Start and move to the interruption point at the velocity set by bits S0 to S2. The movement can be stopped by S5 = 0. Signal S5 can change from 1 to 0 several times. It is not possible to stop the movement with "Machine stop" or to influence the movement with a normal override. The actual value display is not active. On reaching the interruption point, RETRACE mode is automatically deselected and the interrupted program is continued (no drop in velocity). Signal S3 has no effect and should go into state 0. A change of S3 from 0 to 1 would reactivate the RETRACE function. On acceleration and deceleration the override stages below are selected for a short time to generate a ramp.

### Changes in path velocity with RETRACE

The change of S3 from 1 to 0 causes the interrupted program to be continued at the interruption velocity in all situations. If the override switch was changed during the interruption phase, it takes effect only after the start in (5). Retraction on the contour is independent of the number of block changes within the retraction path. If RESET is activated during the interruption (S3 = 1), the RETRACE function is switched off and the program is aborted.

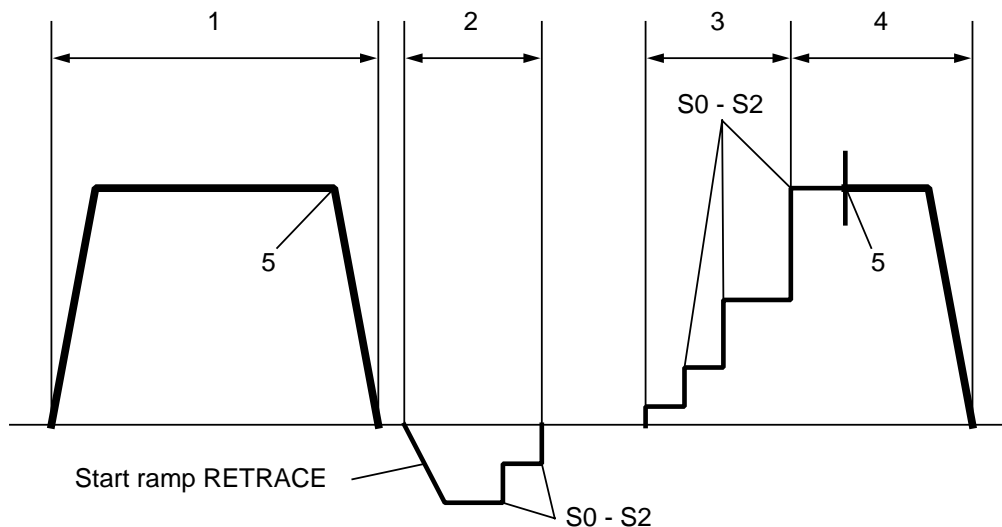

1. AUTOMATIC mode up to the interruption point with subsequent deceleration ramp. S3 = 1
2. Retraction on the contour. Activated by S4
3. Travel in the direction of the interruption point. Activated by S5
4. Continuation of the AUTOMATIC mode. S3 = 0
5. Interruption point

The velocity in 2 and 3 is set by S0, S1, S2.

The segments 1\* to 4\* are added to the segments 1 to 4 when the interruption point is overtravelled. This gives a constant velocity through the RETRACE start point.

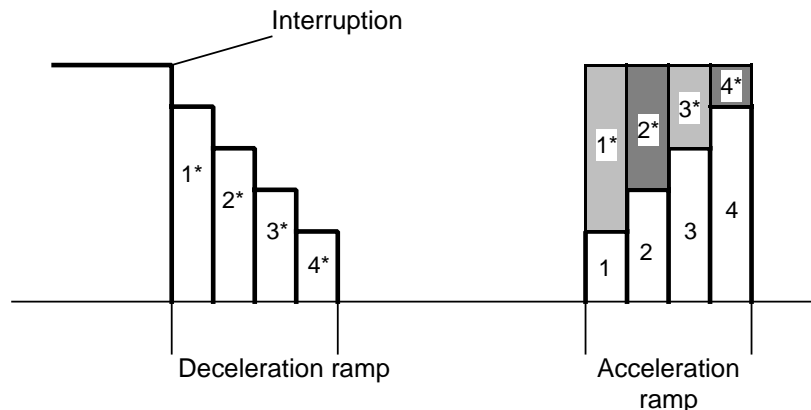

## 11.11.8 Tool change

The tool change on punching and nibbling machines is supported by the SINUMERIK 880N. The control generates several NC blocks from the T no. identifier with M06 depending on the history and tool type. For a tool change with a multiple tool, the tool management with a special interface is required. See special section on the special interface for an explanation. The following tables assume that you have this interface. The figures in the columns give the NC blocks output and their order. If the same numbers are entered in several columns, these functions are output simultaneously in one NC block. The following text explains the columns.

### Tool change Txx M06

#### From

Last tool selected

#### To

Next tool selected

#### T1, T2

Normal tools

#### T3 = 3, T4 = 1, T4 = 2

Multiple tools, tool number in front of the equivalence sign, station number behind the equivalence sign. This order can be reversed by the PLC (see the description of the special interface). For example: T3 = 2 means: tool at location 3 in the tool changer, station 2 of the multiple tool. Tool change from T4 = 1 to T4 = 2 means tool change within the multiple tool.

### Output of auxiliary functions and positions

The following blocks are the blocks the SINUMERIK 880N can generate from block Txx M06

#### M 9987 (tool change)

Indicates that the tool change position is to be approached in the next block. This is important, for example, with shaped plates to put the punch head into a safe position before the traverse movement.

#### Tool change position

Tool change position in Y. This is defined in machine data 246 (default value) or via Y2 = ... (programmable in the part program) and is approached automatically.

#### M06 and T No. output

The auxiliary functions M06 and the T number are output to the VDI interface.

#### M 9998 (clamp)

This auxiliary is used for clamping the locking bolt on multiple tools.

**Relative zero rotation, M06 and T No. output**

The change position of the multiple tool is approached. The SINUMERIK 880N selects station 1. At the same time the auxiliary functions M06 and the T number are output to the VDI interface.

**M 9997 (tool change)**

See above

**Approach station multiple tool**

After unclamping the programmed multiple tool station is approached. This is done by rotating the tangential axis.

**Tangential control angle zero rotation**

Before unclamping with M 9998 the tangential axis must be rotated to zero because the locking bolt can only be clamped in this position.

**xth block after tool change**

This is any block after a tool change in which the tangential control is activated.

**M 9999 (clamp)**

The tangential control can be activated in conjunction with a multiple tool with valid tool station after unclamping the locking bolt.

The following table describes the tool change of the SINUMERIK 880N with the special interface. Various histories and tools are described.

**Tool change with the special interface and normal or multiple tools**

Before and after the tool change without active tangential control.

Tool change Txx M06		Output of auxiliary functions and positions							
From (old tool)	To (new tool)	M 9987 (tool change)	Tool change position	M06 and T No. output	M 9998 (clamp)	Relative zero rotation	M 9997 (tool change 2nd channel)	M 9998 (clamp)	Ap- proach station multiple tool
T1	T2	1	2	2			3		
T1	T3=2	1	2	2			3	4	5
T3=2	T1	1	2	2	3	4	5		
T3=2	T4=4	1	2	2		3	4	5	6
T4=4	T4=4			2	1				2

**Tool change with the special interface and normal or multiple tools**

Before the tool change without active tangential control.

Tool change Txx M06		Output of auxiliary functions and positions								
From (old tool)	To (new tool)	M 9987 (tool change)	Tool change position	M06 and T No. output	Tan- gen- tial angle zero rotation	M 9998 (clamp)	Relative zero rotation	M 9997 (tool change 2nd channel)	M 9998 (clamp)	Ap- proach station multiple tool
T1	T2	1	2	2	2			3		
T1	T3=2	1	2	2	2			3	4	5
T3=2	T1	1	2	2	2	3	4	5		
T3=2	T4=4	1	2	2	2	3	4	5	6	7
T4=4	T4=4			2	1	2				3

**Tool change with the special interface and normal or multiple tools**

Before the tool change with and after the tool change without active tangential control.

Tool change Txx M06		Output of auxiliary functions and positions									xth block after tool change
From (old tool)	To (new tool)	M 9987 (tool change)	Tool change position	M06 and T No. output	M 9998 (clamp)	Relative zero rotation	M 9997 (tool change 2nd channel)	M 9998 (clamp)	Ap- proach station multiple tool	M 9999 (un- clamp)	
T1	T2	1	2	2			3				
T1	T3=2	1	2	2			3	4	5	6	
T3=2	T1	1	2	2		3	4				
T3=2	T4=4	1	2	2		3	4	5	6	7	
T4=4	T4=4			2	1				2	3	

**Tool change with the special interface and normal or multiple tools**

Before and after the tool change with active tangential control.

Tool change Txx M06		Output of auxiliary functions and positions									xth block after tool change
From (old tool)	To (new tool)	M 9987 (tool change)	Tool change position	M06 and T No. output	Tan- gen- tial angle zero rotation	M 9998 (clamp)	Relative zero rotation	M 9997 (tool change 2nd chan- nel)	M 9998 (clamp)	Ap- proach station multiple tool	M 9999 (un- clamp)
T1	T2	1	2	2	2			3			
T1	T3=2	1	2	2	2			3	4	5	6
T3=2	T1	1	2	2	2	3	4	5			
T3=2	T4=4	1	2	2	2	3	4	5	6	7	8
T4=4	T4=4			3	1	2				3	4

## **11.11.9 Defined areas**

### **11.11.9.1 General notes (difference description of interface)**

The use of the additional interface tool management DB33 is required when multiple tools and fast tool management are used. When DB33 is used function blocks are required in PLC 2 to create the data block and perform the DB - link RAM transfer. When the interface is used the SINUMERIK provides the possibility of operating the first two spindles. The number of spindles is increased to six if the additional interface is not used. For the spindles see the machine data and interface signals of the 880M.



## 11.11.9.2 Interface 880N tool management

Signals from NC DB33 (Section 2.1)								
Byte No.	15	14	13	12	11	10	9	8
	Bit No.							
	7	6	5	4	3	2	1	0
DL 0								
DR 0	Accompanying signals				Strobe			
	M02	Prog. start		Ident/loc. Code		Strokes upd.	M06	T change
DL 1								
DR 1	Extended T address							
	$10^1$				$10^0$			
DL 2	T number							
	$10^7$				$10^6$			
DR 2	$10^5$				$10^4$			
DL 3	$10^3$				$10^2$			
DR 3	$10^1$				$10^0$			
DL 4	Current number of strokes (digital)							
	$2^{31}$	...	...	...	...	...	...	$2^{24}$
DR 4	$2^{23}$			...				$2^{16}$
DL 5	$2^{15}$				...			$2^8$
DR 5	$2^7$	...	...	...	...	...	...	$2^0$

Signals to NC DB33 (Section 2.2)									
Byte No.	15	14	13	12	11	10	9	8	
	Bit No.								
	7	6	5	4	3	2	1	0	
DL 6									
DR 6	Strobe equal mult. tool	T search start	Acknowledgement						
							Strokes upd.	M06	T change
DL 7	Tool type								
DR 7	Multiple tool station								
DL 8									
DR 8						Stroke weighting factor (see table)			
DL 9	Current number of strokes (digital)								
	2 <sup>31</sup>	...	...	...	...	...	...	2 <sup>24</sup>	
DR 9	2 <sup>23</sup>			...				2 <sup>16</sup>	
DL 10	2 <sup>15</sup>				...			2 <sup>8</sup>	
DR 10	2 <sup>7</sup>	...	...	...	...	...	...	2 <sup>0</sup>	

Number of strokes weighting factor

Digital	Factor
000	0.25
001	0.50
010	0.75
011	1.00
100	1.25

The number of strokes weighting factor is read from the NC on the first tool change and applies to the whole program.

## 11.11.10 Communication between the NC and the PLC via the special interface

### 11.11.10.1 Signals from the NC

- **Accompanying signals**

#### **M02**

This accompanying signals output when the program ends with the signal "Update number of strokes" and can be used to read the number of strokes of the tool last used.

#### **Program start**

The accompanying signal "Program start" is output at the start of the program with the signal "Update number of strokes". It can be used to write the number of strokes of the tool, which was used before the program was started.

#### **Ident/location code**

0 signal	Location code
1 signal	Ident number code

Using an M function defined in the machine data, the signal "Ident/location code" is output. The location code is preset at the start of the program.

- **Strobe signals**

#### **Note:**

The strobe signals must be acknowledged by the user with the appropriate acknowledgement signals.

#### **Update number of strokes**

This signal is output at the start and end of the program and at every tool change. It requests the reading and writing of the number of tool strokes from the PLC.

#### **M06**

The M06 signal is output at this interface approx. four NC blocks before the channel-specific interface.

#### **T change**

The T change signal is output at this interface approx. three NC blocks before the T change signal of the channel-specific interface.

#### **Extended T address, T No.**

The extended T address and the T No. are output with the strobe signal T change.

## 11.11.10.2 Signals to the NC

### Strobe signal same multiple tool

If multiple tools are used this signal must be supplied by the user. If the multiple tool to be removed and that to be inserted on a tool change are one and the same, the signal "1" must be set. In this way the new part tool is activated and a tool change is suppressed.

### T search start (shadow run)

T search outputs at the interface all T numbers used in a program selected in AUTOMATIC mode. Processing does not take place. In the shadow run the strobe signal "T change" is also output.

Example: Check that the magazine assignment is complete.

## Acknowledgement signals

### Update number of strokes/M06/T change

The strobe signals "update number of strokes", "M06" and "T change" must be acknowledged by the user with the appropriate acknowledgement signals. After the strobe signals have been cancelled by the NC the acknowledgement signals must be reset by the user.

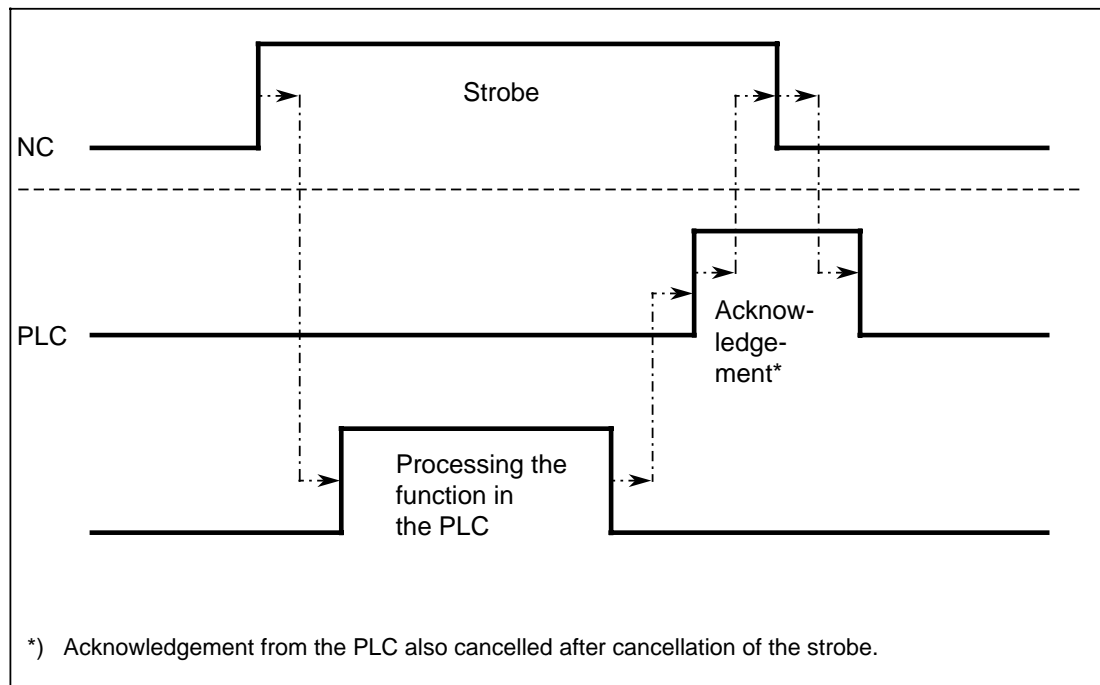

**Tool type**

The number of the tool offset memory in which the geometry data of the current tool is kept is entered in the tool type.

Allocation of the memory

Memory No.	1	-	199	Multiple tool
Memory No.	200	-	240	Simple tool

The tool type is updated with the M06 acknowledgement signal.

**Multiple tool station**

The part tool number is entered in the multiple tool station when multiple tools are used. "Multiple tool station" is transferred with acknowledgement signal "M06".

**Number of strokes weighting factor**

The number of strokes weighting factor is used to adapt tool wear to the material. With the acknowledgement signal "Update number of strokes" the number of strokes weighting factor is transferred on the first tool change of an NC program. It then applies to the whole program.

### 11.11.10.3 Signals from/to the NC

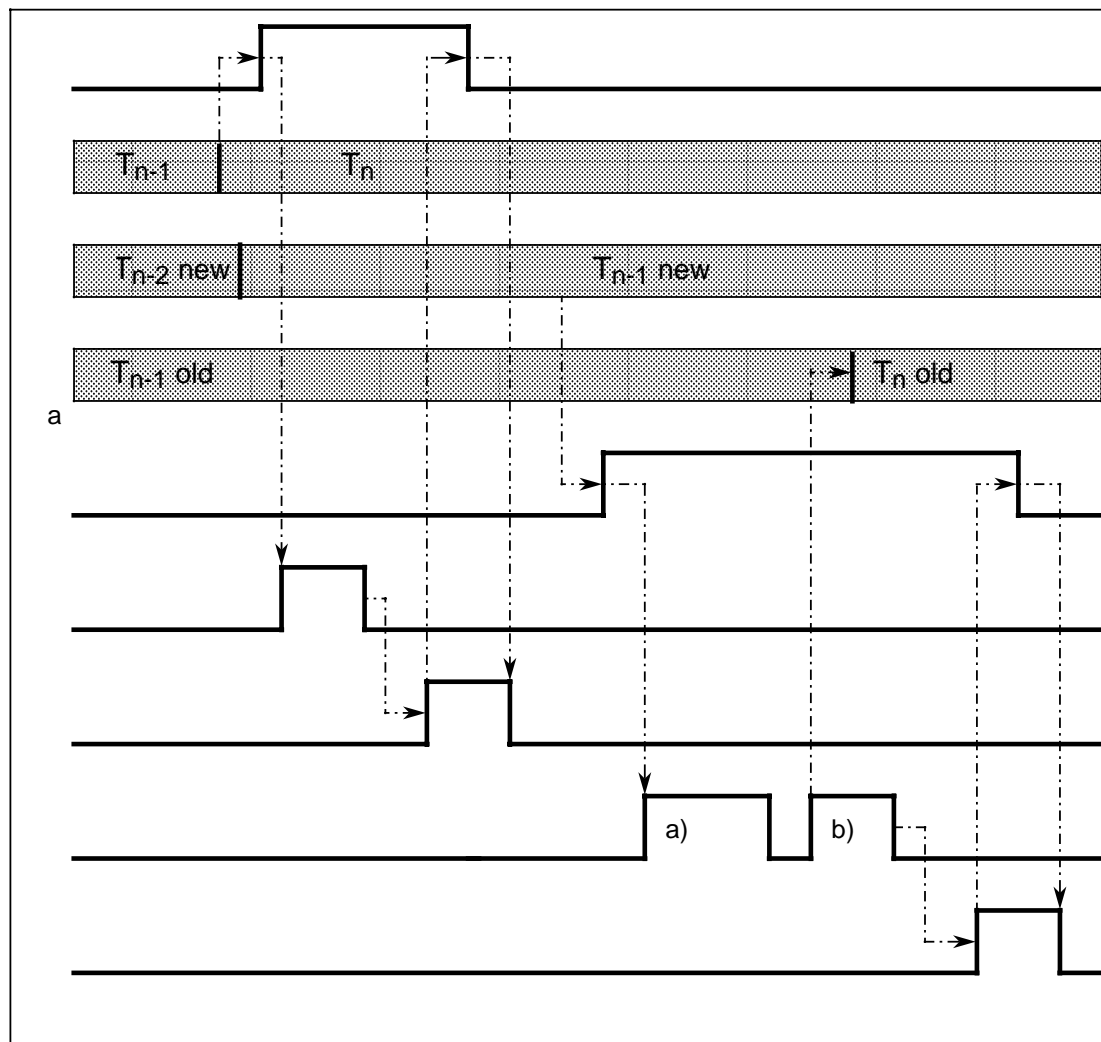

Strobe signal "T change"

Extended T address and T No.

Number of strokes in DW 4 + 5 of the DB33 (NC->PLC)

a) Number of strokes in DW 9 + 10 of the DB33 (PLC->NC)

Strobe signal "Update number of strokes"

Evaluation of the new T No. from the user

Acknowledgement signal "T change"

a) read the updated number of strokes

b) write the old number of strokes of the tool used next

Acknowledgement signal "Update number of strokes"

### Current number of strokes

For the purpose of detecting tool wear SINUMERIK 880N provides a way of updating the number of strokes of the tool. The strokes of the tool are summated in a memory. This sum is multiplied by the number of strokes weighting factor and is then added to the previously prepared number of strokes to form the current number of strokes.

The updated number of strokes of the tool last used is made readable to the user by the strobe signal "Update number of strokes". The number of strokes of the next tool is transferred with the acknowledgement "Update number of strokes". Using the accompanying signals "M02" and "Program start" the user can differentiate between reading, writing and reading/writing the number of strokes.

# 12 Alarms

## 12.1 List of alarms

For short description see Installation Guide, Lists.

## 12.2 Alarm numbers and groups / clearing of alarms

The alarms are divided into 8 alarm groups (5 NC, 2 PLC and 1 cycle alarm group).

### NC alarms

- POWER ON alarms
- V.24 (RS232) alarms
- RESET alarms/axis-specific
- RESET alarms/general
- RESET alarms/spindle-specific
- ERASE alarms

**Note:**

With POWER ON-RESET (switch on control) all NC alarms are cleared.

### Fig. alarms

- PLC error messages
- PLC operational messages

**Note:**

The PLC-MD must be used to determine whether alarms 6000 to 9999 are displayed as error or operational messages (or not at all).

### Cycles alarms (from Software Version 3)



## 12.2.1 Display of alarms on the CRT

Messages from the monitoring system are displayed in the alarm line of the CRT display.

The alarm line is the second display line from the top.

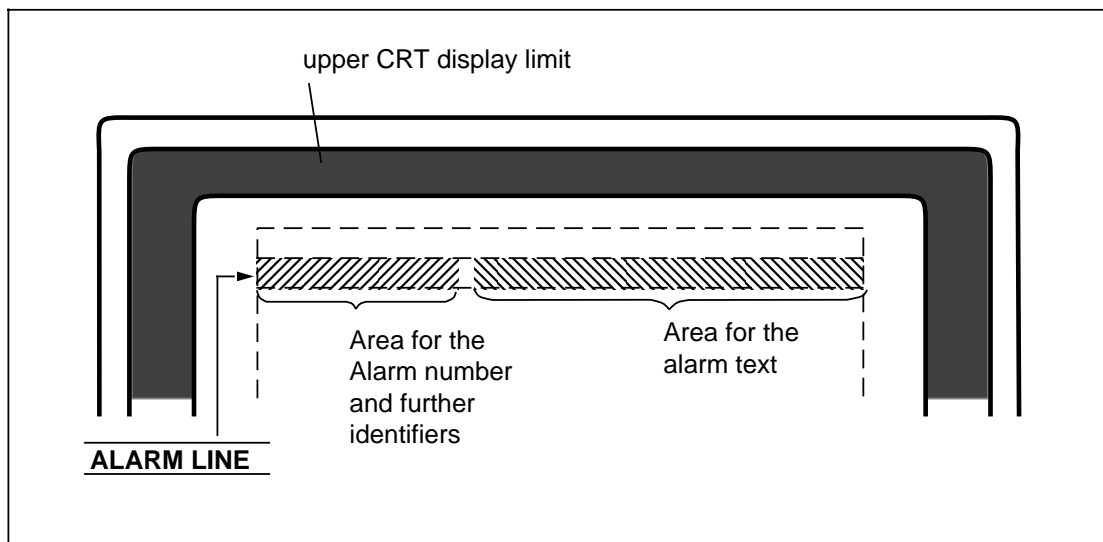

## 12.2.2 Display representation

There are 3 types of display representation for alarms:

### 1. Serial number-referred alarms

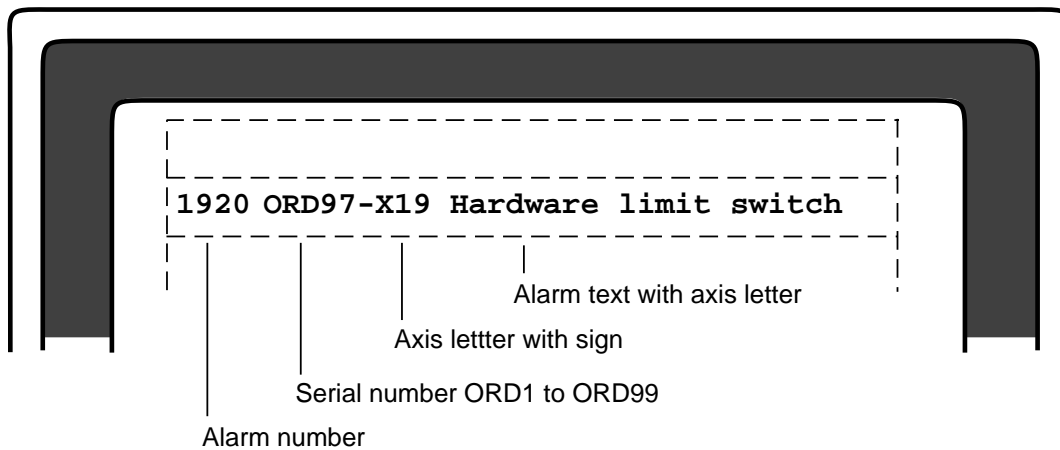
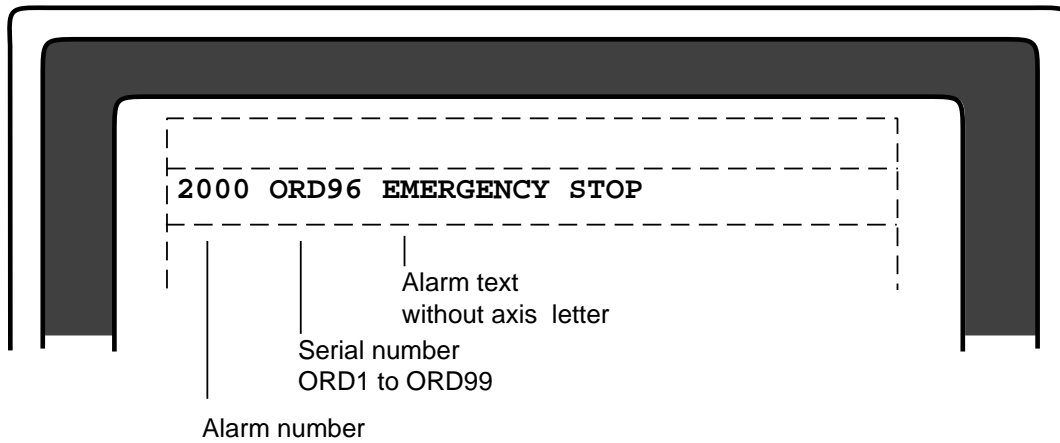

### 2. Block related alarms

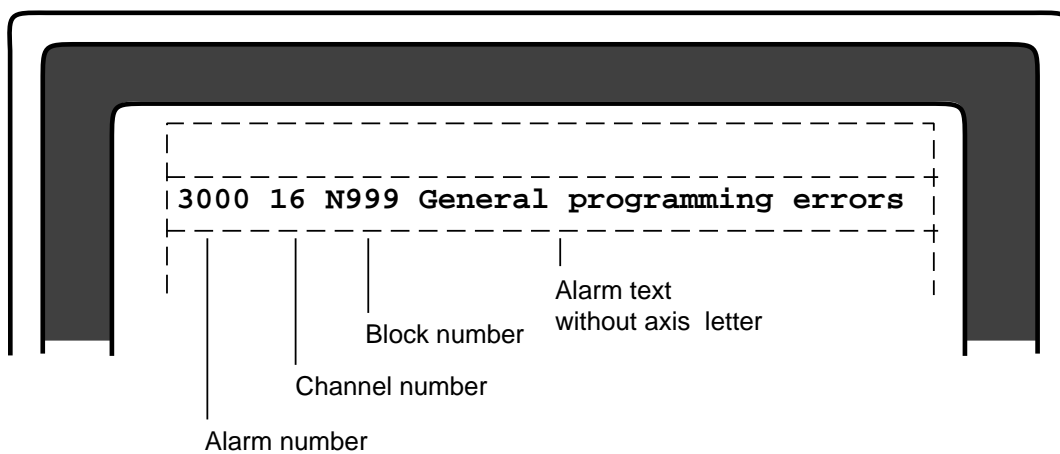

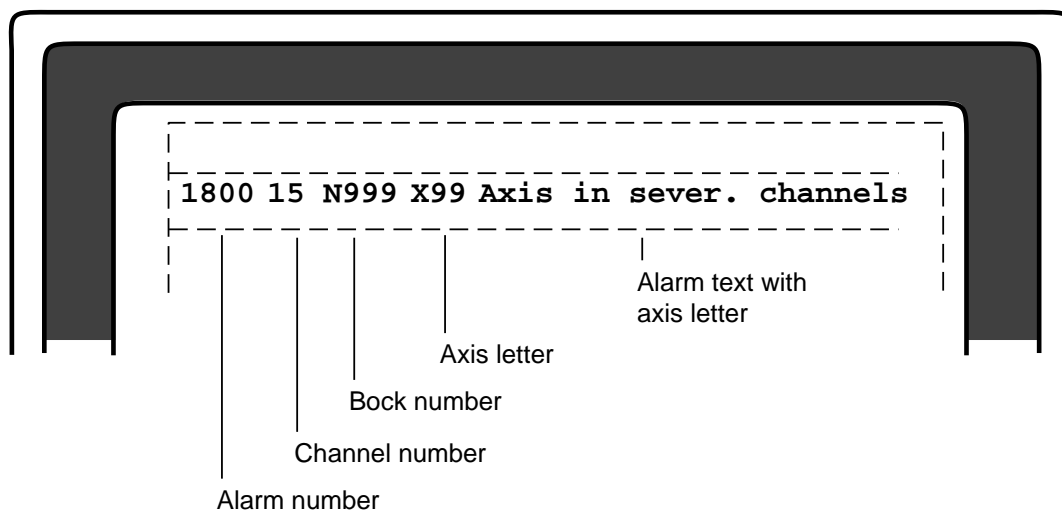

**Note:**

Axis- and spindle-specific alarms in this Operator's Guide are marked with an asterisk in the last decimal place. Example: Alarm number 156\*

The asterisk stands for the relevant axis or spindle. The following assignments apply:

**Spindles**

- 1 = 1st spindle
- 2 = 2nd spindle
- 3 = 3rd spindle
- 4 = 4th spindle
- 5 = 5th spindle
- 6 = 6th spindle

**Axes**

- 0 = 1st axis
- 1 = 2nd axis
- 2 = 3rd axis
- 3 = 4th axis
- 4 = 5th axis
- .
- .
- .
- 23 = 24th axis

**Examples for spindles: Alarm 225\* spindle speed too high**

- 2251 Alarm refers to the 1st spindle
- 2252 Alarm refers to the 2nd spindle
- 2256 Alarm refers to the 6th spindle

**Examples for axes: Alarm 156\* setpoint speed too high**

- 1560 Alarm refers to the 1st axis
- 1565 Alarm refers to the 6th axis
- 1570 Alarm refers to the 11th axis
- 1583 Alarm refers to the 24th axis

### 3. PLC and cycle alarms

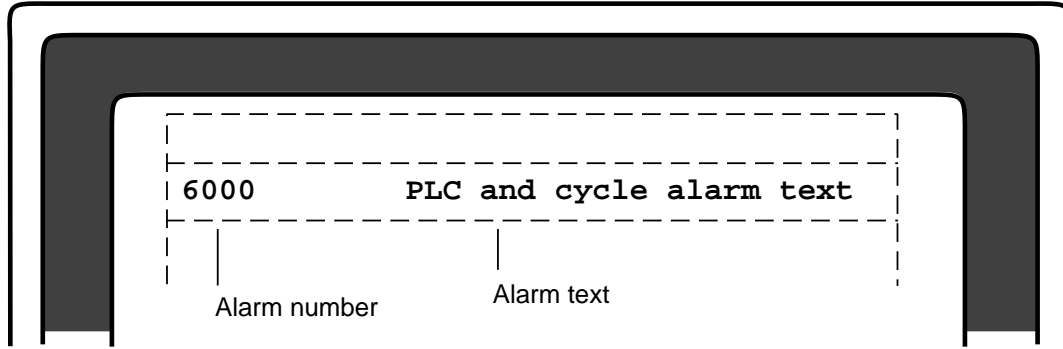









**Note:**

PLC and cycle alarms are determined by the machine tool manufacturer or the user himself. They are not included in the alarm description therefore.

### 12.2.3 Alarm numbers and groups/clearing alarms (SV 6)

The alarms are divided into different groups. The table below shows the relationship between alarm number, alarm group and alarm clearing function.

Alarm number	Alarm group	Alarm cleared by ...
2...6 8...15 40...89	POWER ON alarms	Restart the control 
16...35	RS232 (V.24) alarms	1. Call the softkey menu including the "DATA IN-OUT function" <sup>1)</sup>  2. Operate "DATA IN-OUT" softkey 3. Operate "STOP" softkey
100*... 120* 140*...196* 1004*...1008* 1024*...1036* 1204*...1216*	RESET alarms/ axis-specific	Operate RESET key 
225* 228*...231*	RESET alarms/ spindle-specific	Operate RESET key 
128*... 136* 226*... 227* 1000* 1012* 1040* 1200*	POWER ON alarms/ axis-specific/spindle-specific	Restart control 
2000 ... 2192 2410 ... 2427	RESET alarms/general	Operate RESET key 
1 u. 7 3000 ... 3240	Acknowledge alarms	Operate acknowledge key 
1044*	Acknowledge alarms axis-specific	Operate acknowledge key 
4000...4299 5000...5299	Cycle alarms	Operate acknowledge key <sup>3)</sup> 
6000...9999	PLC error message	Operate acknowledge key
6000...9999	PLC operational message	These messages are reset automatically by the PLC program.

Tabular overview with assignment of alarm no. and clear function

- 1) Explanatory note: The "DATA IN-OUT" function can be called in the following operating modes: AUTOMATIC/JOG/REFPOINT/INCFEED 1....10000/PRESET
- 2) The asterisk (\*) stands for an axis/spindle number.
- 3) The program is not aborted but merely stopped, processing of the program can continue when the error has been eliminated.

## 12.2.4 Diagnostics/selection of further alarms

When the diagnostics react, the reason could be **several different faults occurring at the same time**.

Only the alarm with the **lowest alarm number** is displayed in the alarm line.

If you need an overview of any other existing alarms/messages, proceed as follows:

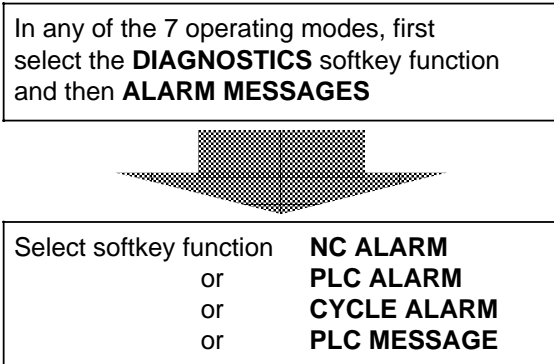

## 12.2.5 Effects of alarms

In the section "List of alarms/alarm description" the four types of effect are listed. The detailed meaning of the effects is explained below.

- **Interruption of processing**

The program is interrupted and can be resumed at the interrupt point after the fault has been remedied.

With channel-specific alarms, processing is interrupted only in the channel concerned.

- **NC START inhibit**

NC START is not enabled when an alarm is active.

The current processing is not stopped. However, if processing is interrupted (e. g. by NC STOP or Single block) it cannot be restarted until the cause of a fault has been remedied and the alarm cleared.

With channel-specific alarms, NC START is inhibited only for the channel concerned.

- **Cancellation of Mode Group Ready**



The MODE GROUP READY signal is cancelled for the master channel. As a result, maximum braking current is applied to the axes or spindles of the mode group for rapid deceleration (Rapid stop).

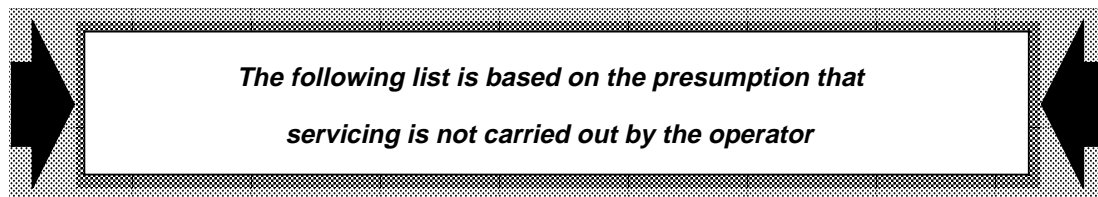

- **Opening the NC ready relays**

The output on the dual/multiport is disabled. The ready state of the control can only be reestablished via POWER ON.





## 12.2.6 Listing of alarms/alarm description (SV 6)





<b>1</b>	<b>Battery alarm-power supply</b>	
Scan:	<ul style="list-style-type: none"> <li>• On POWER ON</li> <li>• Cyclic</li> </ul>	
Effect:	<ul style="list-style-type: none"> <li>• None</li> </ul>	
Explanation:	The battery voltage has dropped so far that backup (of the program memory, for example) cannot be guaranteed if the control is switched off	
Remedy:	Replace the battery next to the power pack under power and acknowledge the alarm with the "Acknowledge key" after making spot checks in the part program memory for variable data	
<b>Caution:</b>	The control must not be switched off until the battery has been replaced, otherwise stored data will be lost	
<b>2</b>	<b>Overtemperature</b>	
Scan:	Cyclic	
Effect:	Output of temperature error at PLC user interface flag 24.2	
Explanation:	The fan exhaust temperature is higher than 55 °C (permissible range 0 °C to 55 °C)	
Remedy:	Check temperature in the cabinet	
<b>4</b>	<b>Incorrect unit system</b>	
Scan:	<ul style="list-style-type: none"> <li>• On POWER ON</li> <li>• After modification of NC MD</li> </ul>	
Effect:	<ul style="list-style-type: none"> <li>• Processing interruption</li> <li>• NC START disabled</li> <li>• Cancellation of Mode Group Ready</li> <li>• Opening of NC Ready Relay</li> </ul>	
Explanation:	In NC MD 5002 an illegal combination of position resolution and input resolution has been selected	
Remedy:	Correct NC MD 5002	

<b>5</b>	<b>Incorrect MIB parameter</b>	
Scan:	On formatting the user program memory; "UM FORMAT" softkey	
Effect:	Only the MIB parameters 0 to 199 are defined	
Explanation:	<ul style="list-style-type: none"> <li>• The R and MIB parameters take up so much space in the user memory that the user program memory has become smaller than 16Kbytes</li> <li>• MD 4 &lt; MD 5 overlapping of both MIB areas</li> <li>• MD 4 &lt; 200 standard MIB area exceeded</li> <li>• MD 5 &gt; 500 MIB buffer area exceeded</li> </ul>	
Remedy:	Correct NC MD 4 or NC MD 5 and reformat the user program memory	
<b>6</b>	<b>Battery alarm machine data</b>	
Scan:	<ul style="list-style-type: none"> <li>• On POWER ON</li> <li>• Cyclic</li> </ul>	
Effect:	None	
Explanation:	The battery voltage has dropped so far that backup of the NC MDs cannot be guaranteed	
Remedy:	Replace the NC MD card with a new one and re-enter the NC MDs and PLC MDs	
<b>Caution:</b>	The control must not be switched off before the replacement has been made, otherwise stored data will be lost	
<b>7</b>	<b>Battery alarm operator panel</b>	
Scan:	<ul style="list-style-type: none"> <li>• On POWER ON</li> <li>• Cyclic</li> </ul>	
Effect:	None	
Explanation:	The battery voltage has dropped so far that backup of the setup data for the Terminal Emulator cannot be guaranteed	
Remedy:	Replace battery in the operator panel under power and acknowledge the alarm with the CANCEL key after the setup data have been checked and corrected if necessary	
<b>Caution:</b>	The control must not be switched off until the battery has been replaced, otherwise stored data will be lost	





<b>8</b>	<b>Wrong axis/spindle assignment</b>	
Scan:	<ul style="list-style-type: none"> <li>• After modification of NC MD</li> <li>• On POWER ON</li> </ul>	
Effect:	<ul style="list-style-type: none"> <li>• Processing interruption</li> <li>• NC START disabled</li> <li>• Cancellation of Mode Group Ready</li> <li>• Opening of NC Ready Relay</li> </ul>	
Explanation:	An illegal assignment has been made in NC MD 200* or NC MD 400*	
Remedy:	See Installation Guide (Description of NC MDs)	
<b>9</b>	<b>Memory too small for UMS</b>	
Scan:	On POWER ON	
Effect:	Illegal UMS	
Explanation:	Excessive modification of the standard area, RAM area available insufficient	
Remedy:	Avoid excessive modification of the standard area	
<b>10</b>	<b>UMS error</b>	
Scan:	On POWER ON	
Effect:	NC START disabled	
Explanation:	<ul style="list-style-type: none"> <li>• UMS selected but no UMS inserted</li> <li>• UMS RAM not yet loaded</li> </ul>	
Remedy:	<ul style="list-style-type: none"> <li>• Insert correct UMS</li> <li>• Check NC MD 5015 bit 6</li> </ul>	
<b>11</b>	<b>Wrong UMS identifier</b>	
Scan:	On POWER ON	
Effect:	NC START disabled	
Explanation:	<ul style="list-style-type: none"> <li>• UMS RAM not yet loaded</li> <li>• Wrong EPROM inserted</li> <li>• Linking error (operating system)</li> </ul>	
Remedy:	<ul style="list-style-type: none"> <li>• Load UMS RAM</li> <li>• Insert correct EPROM</li> <li>• Relink UMS</li> </ul>	

<b>12</b>	<b>Part program memory wrongly formatted</b>	
Scan:	Cyclic	
Effect:	<ul style="list-style-type: none"> <li>• Processing interruption</li> <li>• NC START disabled</li> </ul>	
Explanation:	A fault has been ascertained on the memory module or a hardware repair has been made and the part program memory not yet reformatted	
Remedy:	Reformat memory ("CLEAR PART PROGRAM" softkey) or replace memory	
<b>16</b>	<b>Parity error RS232 C (V.24)</b>	
Scan:	On reading data into the RS232 C (V.24) interface	
Effect:	<ul style="list-style-type: none"> <li>• RS232 C (V.24) transmission interrupted</li> <li>• Last block declared invalid</li> </ul>	
Explanation:	<ul style="list-style-type: none"> <li>• Alarm is displayed with reference to the block.</li> <li>• The alarm can only arise if the setting data (SD) "with parity bit" applies. The character commenced (8 data and 1 parity bit) has the wrong parity. This alarm has nothing to do with character parity errors RS232 C (V.24) in ISO or EIA punched tapes (Alarm 23)</li> </ul>	
Remedy:	<ul style="list-style-type: none"> <li>• Check SDs 5011, 5013, 5018, 5020</li> <li>• Test external device</li> </ul>	
<b>17</b>	<b>Overflow error RS232 C (V.24)</b>	
Scan:	On reading data into the RS232 C (V.24) interface	
Effect:	<ul style="list-style-type: none"> <li>• RS232 C (V.24) transmission interrupted</li> <li>• Last block declared invalid</li> </ul>	
Explanation:	<ul style="list-style-type: none"> <li>• Alarm is displayed with reference to the block</li> <li>• The external device has sent a new character although the CNC has not yet processed the old one</li> </ul>	
Remedy:	<ul style="list-style-type: none"> <li>• Check SDs 5011, 5013, 5018, 5020</li> <li>• Test external device</li> </ul>	

<b>18</b>	<b>Frame error RS 232 C (V.24)</b>	<b>Soft-key</b>
Scan:	On reading data into the RS 232 C (V.24) interface	
Effect:	<ul style="list-style-type: none"> <li>• RS232 C (V.24) transmission interrupted</li> <li>• Last block declared invalid</li> </ul>	
Explanation:	<ul style="list-style-type: none"> <li>• Number of stop bits is incorrect</li> <li>• Baud rate is incorrect</li> </ul>	
Remedy:	<ul style="list-style-type: none"> <li>• Check SDs 5011, 5013, 5018, 5020</li> <li>• Test external device</li> </ul>	
<b>19</b>	<b>I/O device not ready RS 232 C (V.24)</b>	<b>Soft-key</b>
Scan:	On request of data from the NC via the RS 232 C (V.24) interface	
Effect:	No files are read in	
Explanation:	<ul style="list-style-type: none"> <li>• Alarm is displayed with reference to block</li> <li>• The DSR signal from the external device is Low</li> </ul>	
Remedy:	<ul style="list-style-type: none"> <li>• Start external device</li> <li>• Do not use DSR</li> </ul>	
<b>22</b>	<b>Time watch-dog RS 232 C (V.24)</b>	<b>Soft-key</b>
Scan:	Following an NC request to output or read in data; after a delay of 60 seconds	
Effect:	No data are received or output	
Explanation:	<ul style="list-style-type: none"> <li>• Alarm is displayed with reference to block</li> <li>• The NC cannot output a signal for 60 seconds <ul style="list-style-type: none"> <li>– External device blocks the "CTS" signal (clear to send) for longer than 60 seconds</li> <li>– External device does not send DC1 within 60 s when control signals (DC1 to DC4) are used</li> </ul> </li> <li>• The NC has not received a signal for 60 seconds</li> </ul>	
Remedy:	<ul style="list-style-type: none"> <li>• Check external device and switch on</li> <li>• Check cable and plug in</li> <li>• Switch off time watch-dog (SD bit)</li> </ul>	

<b>23</b>	<b>Character parity error RS 232 C (V.24)</b>	<b>Soft-key</b>
Scan:	On reading in data via the RS 232 C (V.24) interface of the NC	
Effect:	<ul style="list-style-type: none"> <li>• RS232 C (V.24) transfer interrupted</li> <li>• The last block declared invalid</li> </ul>	
Explanation:	<ul style="list-style-type: none"> <li>• Alarm is displayed with reference to block</li> <li>• Depending on the definition of the start of program "%" or "EOB", the NC automatically determines the ISO or EIA code on receipt of this character and thus the character parity</li> </ul> <p>On checking the following characters, it has been established that one character did not have the set parity</p>	
Remedy:	Check punched tape	
<b>24</b>	<b>Invalid EIA character RS 232 C (V.24)</b>	<b>Soft-key</b>
Scan:	On reading in data via the RS 232 C (V.24) interface of the NC	
Effect:	<ul style="list-style-type: none"> <li>• RS232 C (V.24) transfer interrupted</li> <li>• The last block declared invalid</li> </ul>	
Explanation:	<ul style="list-style-type: none"> <li>• Alarm is displayed with reference to block</li> <li>• An EIA character with the correct parity was read in, but the character was <b>not</b> defined in EIA code</li> </ul>	
Remedy:	<ul style="list-style-type: none"> <li>• Check punched tape</li> <li>• Check SD (EIA code for "@")</li> <li>• Check SD (EIA code for ":")</li> <li>• Check SD (EIA code for "=")</li> <li>• Check SD (EIA code for "]")</li> <li>• Check SD (EIA code for "[")</li> <li>• Check SD (EIA code for ",")</li> </ul>	
<b>26</b>	<b>Block &gt; 120 characters RS 232 C (V.24)</b>	<b>Soft-key</b>
Scan:	On reading in data via the RS 232 C (V.24) interface of the NC	
Effect:	<ul style="list-style-type: none"> <li>• RS232 C (V.24) transfer interrupted</li> <li>• The last block declared invalid</li> </ul>	
Explanation:	The part program block that has been read in contains more than 120 characters. Only the actually stored characters are counted (no spaces, no CR, ...)	
Remedy:	Divide block into 2 or more blocks	

<b>27</b>	<b>Data input disabled RS 232 C (V.24)</b>	
Scan:	On reading in data via the RS 232 C (V.24) interface of the NC	
Effect:	No data have been read in	
Explanation:	<ul style="list-style-type: none"> <li>• Alarm is displayed with reference to block</li> <li>• An attempt has been made to read in NC MDs in normal mode</li> <li>• An attempt has been made to transfer UMS data to the NC although the UMS has not been enabled or not inserted</li> <li>• An attempt has been made to read in a subroutine which already exists as a cycle in the EPROM</li> </ul>	
Remedy:	<ul style="list-style-type: none"> <li>• Read in NC MDs in installation mode or enter password</li> <li>• Insert UMS module and fit with UMS submodules or enable UMS via machine data</li> </ul>	
<b>28</b>	<b>Circ. buffer overflow RS 232 C (V.24)</b>	
Scan:	On reading in data into the NC via the RS 232 C (V.24) interface	
Effect:	<ul style="list-style-type: none"> <li>• RS232 C (V.24) transfer interrupted</li> <li>• The last blocks declared invalid</li> </ul>	
Explanation:	<ul style="list-style-type: none"> <li>• Alarm is displayed with reference to block</li> <li>• Data transfer speed so high that more characters are transferred than can be processed by the NC</li> <li>• RTS signal has no effect on the input device (RTS causes the input device to STOP)</li> <li>• Transmission speed (baud rate) too high</li> </ul>	
Remedy:	<ul style="list-style-type: none"> <li>• Use RS232 C (V.24) transmission instead of 20 mA</li> <li>• Use 3rd serial interface</li> </ul>	
<b>29</b>	<b>Block &gt; 254 charac. RS 232 C (V.24)</b>	
Scan:	On reading in tool data into the NC via the RS 232 C (V.24) interface	
Effect:	<ul style="list-style-type: none"> <li>• RS232 C (V.24) transfer interrupted</li> <li>• The last block declared invalid</li> </ul>	
Explanation:	<ul style="list-style-type: none"> <li>• Alarm is displayed with reference to block</li> <li>• The block that has been read in has more than 254 characters. All characters read in are counted (including blanks, CR, LF ...)</li> </ul>	
Remedy:	Divide block into 2 or more blocks	

<b>30</b>	<b>Part program memory overflow RS 232 C (V.24)</b>	<b>Soft- key</b>
Scan:	On reading in programs via the RS 232 C (V.24) interface of the NC	
Effect:	<ul style="list-style-type: none"> <li>• RS232 C (V.24) transfer interrupted</li> <li>• The last block declared invalid</li> </ul>	
Explanation:	<ul style="list-style-type: none"> <li>• Alarm is displayed with reference to block</li> <li>• The maximum part program memory space is full</li> </ul>	
Remedy:	Clear old programs to provide memory space for reading in new programs. The block number containing an error is displayed.	
<b>31</b>	<b>Program memory full RS 232 C (V.24)</b>	<b>Soft- key</b>
Scan:	On reading in programs via the RS 232 C (V.24) interface of the NC	
Effect:	No data have been read in	
Explanation:	<ul style="list-style-type: none"> <li>• Alarm is displayed with reference to block</li> <li>• The maximum number of part programs has been reached (NC MD 8)</li> </ul>	
Remedy:	<ul style="list-style-type: none"> <li>• Read out and clear old part programs that are not needed anymore to provide memory space for new part programs</li> <li>• Use larger part program memory if necessary</li> </ul>	
<b>32</b>	<b>Data format error RS 232 C (V.24)</b>	<b>Soft- key</b>
Scan:	On reading in data via the RS 232 C (V.24) interface of the NC	
Effect:	<ul style="list-style-type: none"> <li>• RS232 C (V.24) transfer interrupted</li> <li>• The last block declared invalid</li> </ul>	
Explanation:	<ul style="list-style-type: none"> <li>• Alarm is displayed with reference to block</li> <li>• The permissible number of decades after an address is not correct</li> <li>• The decimal point occurs in the wrong place</li> <li>• The part programs or subroutines are not defined or concluded correctly (check heading!)</li> </ul>	
Remedy:	Check the program to be read in (incorrect block number is displayed)	



<b>33</b>	<b>Different programs same number RS 232 C (V.24)</b>	<b>Soft-key</b>
Scan:	On reading in programs via the RS 232 C (V.24) interface of the NC	
Effect:	No data have been entered/stored	
Explanation:	<ul style="list-style-type: none"> <li>• Alarm is displayed with reference to block</li> <li>• If a new program is read in which has the same program number as the one already stored in the NC, both programs are compared and, because they are different, the NC outputs Alarm 33. The new program is <b>not stored</b>.</li> </ul>	
Remedy:	<ul style="list-style-type: none"> <li>• Delete old program (DELETE)</li> <li>• Rename old program (RENAME)</li> </ul>	



<b>34</b>	<b>Operator error RS 232 C (V.24)</b>	<b>Soft-key</b>
Scan:	On starting another RS 232 C (V.24) interface when the other one is already active	
Effect:	No data have been read in	
Explanation:	<ul style="list-style-type: none"> <li>• Alarm is displayed with reference to block</li> <li>• The RS 232 C (V.24) transmission is started in the NC and the PLC sends DATA START once more to the NC</li> </ul>	
Remedy:	Restart RS 232 C (V.24) transmission	



  



<b>35</b>	<b>Reader error RS 232 C (V.24)</b>	<b>Soft-key</b>
Scan:	Only if setting data are set for the Siemens reader	
Effect:	<ul style="list-style-type: none"> <li>• RS 232 C (V.24) transfer interrupted</li> <li>• The last block declared invalid</li> </ul>	
Explanation:	<ul style="list-style-type: none"> <li>• Alarm is displayed with reference to block</li> <li>• The Siemens reader has output a group error message</li> </ul>	
Remedy:	<ul style="list-style-type: none"> <li>• Restart RS 232 C (V.24) data transfer</li> <li>• If the error recurs: replace Siemens reader</li> </ul>	



<b>40</b>	<b>COM CPU fault</b>	
Scan:	Cyclic	
Effect:	<ul style="list-style-type: none"> <li>• Processing interruption</li> <li>• NC START disabled</li> <li>• Cancellation of Mode Group Ready</li> <li>• Opening of NC Ready Relay</li> </ul>	
Explanation:	<ul style="list-style-type: none"> <li>• Hardware or software fault in the COM CPU area</li> <li>• No PLC-CPU fault reported</li> </ul>	
Remedy:	Replace hardware and/or software	
<b>41</b>	<b>NC CPU fault</b>	
Scan:	Cyclic	
Effect:	<ul style="list-style-type: none"> <li>• Processing interruption</li> <li>• NC START disabled</li> <li>• Cancellation of Mode Group Ready</li> <li>• Opening of NC Ready Relay</li> </ul>	
Explanation:	<ul style="list-style-type: none"> <li>• Hardware or software fault in the range of the respective NC CPU</li> </ul>	
Remedy:	<ul style="list-style-type: none"> <li>• On installation: check jumper on the bus board</li> <li>• Replace hardware and/or software</li> </ul>	
<b>42</b>	<b>SERVO CPU fault</b>	
Scan:	Cyclic	
Effect:	<ul style="list-style-type: none"> <li>• Processing interruption</li> <li>• NC START disabled</li> <li>• Cancellation of Mode Group Ready</li> <li>• Opening of NC Ready Relay</li> </ul>	
Explanation:	<ul style="list-style-type: none"> <li>• Hardware or software fault in the range of the respective SERVO CPU</li> <li>• Processor overloaded</li> <li>• Measuring circuit module fault</li> </ul>	
Remedy:	<ul style="list-style-type: none"> <li>• Check NC MD 156 or 160 to 163</li> <li>• Reduce the number of axes/spindles on the SERVO CPU</li> <li>• Deselect tool nose radius compensation or assign axis to a different SERVO CPU</li> <li>• Replace hardware and/or software</li> </ul>	









<b>43</b>	<b>PLC-CPU fault</b>	
Scan:	Cyclic	
Effect:	<ul style="list-style-type: none"> <li>• Processing interruption</li> <li>• NC START disabled</li> <li>• Cancellation of Mode Group Ready</li> <li>• Opening of NC Ready Relay</li> </ul>	
Explanation:	<ul style="list-style-type: none"> <li>• Alarm is displayed with reference to block</li> <li>• Hardware or software error in the PLC or NC COM area</li> <li>• PLC in STOP status</li> <li>• NC does not assume Reset status and continues displaying the status of the instant of interruption</li> <li>• PLC machine data error</li> <li>• Error in the PLC user program</li> </ul>	
Remedy:	<ul style="list-style-type: none"> <li>• Read out I-STACK</li> <li>• Establish cause of error using the error list in the installation lists</li> <li>• Replace hardware and/or software</li> </ul>	
<b>44</b>	<b>Part program memory not available</b>	
Scan:	On POWER ON	
Effect:	<ul style="list-style-type: none"> <li>• Processing interruption</li> <li>• NC START disabled</li> <li>• Cancellation of Mode Group Ready</li> <li>• Opening of NC Ready Relay</li> </ul>	
Explanation:	Part program memory missing or not recognised or does not reach the minimum size	
Remedy:	<ul style="list-style-type: none"> <li>• Check specified memory size (machine data)</li> <li>• Clear memory and format</li> </ul>	
<b>46</b>	<b>Incorrect TO parameter display</b>	
Scan:	Cyclic	
Effect:	none	
Explanation:	NC MD 13 too large	
Remedy:	Modify NC MD	





<b>47</b>	<b>Illegal TO assignment</b>	
Scan:	Cyclic	
Effect:	None	
Explanation:	<ul style="list-style-type: none"> <li>• Value of NC MD 210 is greater than 16</li> <li>• TO starting numbers in NC MDs 211 to 226 have not been entered in ascending order</li> <li>• Input value in NC MDs 1040 to 1047 is greater than the number of TO ranges or 0 is defaulted in the TO range</li> </ul>	
Remedy:	Check NC MDs	
<b>63</b>	<b>Connection fault</b>	
Scan:	Cyclic	
Effect:	<ul style="list-style-type: none"> <li>• Processing interruption</li> <li>• NC START disabled</li> <li>• Cancellation of Mode Group Ready</li> <li>• Opening of NC Ready Relay</li> </ul>	
Explanation:	The transmission connection between the COM CPU and the operator panel is interrupted. Normal operation is no longer possible.	
Remedy:	<ul style="list-style-type: none"> <li>• Check the fiber-optic or copper cable between the operator panel and the central controller</li> <li>• Check COM or operator panel CPU</li> </ul>	
<b>64</b>	<b>Incorrect checksum</b>	
Scan:	On POWER-ON	
Effect:	<ul style="list-style-type: none"> <li>• Processing interruption</li> <li>• NC START disabled</li> <li>• Cancellation of Mode Group Ready</li> <li>• Opening of NC Ready Relay</li> </ul>	
Explanation:	<ul style="list-style-type: none"> <li>• Alarm is displayed with reference to block</li> <li>• An EPROM error has been found on switching on the control: <ul style="list-style-type: none"> <li>– Checksum of one card is wrong. The card number is displayed as block number.</li> <li>– Checksum of Restart EPROM wrong</li> </ul> </li> </ul>	
Remedy:	<ul style="list-style-type: none"> <li>• Check card slots and correct if necessary</li> <li>• Check EPROMS</li> </ul>	



<b>65</b>	<b>Wrong slot</b>	
Scan:	On POWER ON	
Effect:	<ul style="list-style-type: none"> <li>• Processing interruption</li> <li>• NC START disabled</li> <li>• Cancellation of Mode Group Ready</li> <li>• Opening of NC Ready Relay</li> </ul>	
Explanation:	<ul style="list-style-type: none"> <li>• Alarm is displayed with reference to block</li> <li>• On switching on the control it has been found that one module has been inserted in the wrong bus slot</li> </ul>	
Remedy:	Check module slots and replace modules if necessary	
<b>66</b>	<b>Wrong software system</b>	
Scan:	On POWER ON	
Effect:	<ul style="list-style-type: none"> <li>• Processing interruption</li> <li>• NC START disabled</li> <li>• Cancellation of Mode Group Ready</li> <li>• Opening of NC Ready Relay</li> </ul>	
Explanation:	<ul style="list-style-type: none"> <li>• Alarm is displayed with reference to block</li> <li>• On switching on the control it has been found that the wrong software system has been inserted in the control e. g. 810 software system instead of 880 software system</li> </ul>	
Remedy:	Insert correct software system	
<b>67</b>	<b>1st computer link not ready</b>	
Scan:	Cyclic or after POWER ON	
Effect:	Message frame interchange between the host computer and the NC is not possible.	
Explanation:	Host computer and NC are not synchronous caused by a wrong specification or a fault on the interface module. Message frame interchange is not possible.	
Remedy:	<ul style="list-style-type: none"> <li>• Check configuration of interface module</li> <li>• Check machine data specified for the computer link</li> <li>• Check whether host computer is ready or has been connected</li> </ul>	

<b>68</b>	<b>2nd computer link not ready</b>	
Scan:	Cyclic or after POWER ON	
Effect:	Message frame interchange between the host computer and the NC is not possible.	
Explanation:	Host computer and NC are not synchronous caused by a wrong specification or a fault on the interface module. Message frame interchange is not possible.	
Remedy:	<ul style="list-style-type: none"> <li>• Check configuration of interface module</li> <li>• Check machine data specified for the computer link</li> <li>• Check whether host computer is ready or has been connected</li> </ul>	
<b>69</b>	<b>Servo CPU not available</b>	
Scan:	On POWER ON	
Effect:	<ul style="list-style-type: none"> <li>• Processing interruption</li> <li>• NC START disabled</li> <li>• Cancellation of Mode Group Ready</li> <li>• Opening of NC Ready Relay</li> </ul>	
Explanation:	<ul style="list-style-type: none"> <li>• Alarm is displayed with reference to block</li> <li>• The servo circuit of an axis/spindle has been defined in MD 200* or MD 400* on a non-existing servo CPU.</li> </ul>	
Remedy:	Correct MD 200*or MD 400*	
<b>70</b>	<b>Fault in at least one channel</b>	
Scan:	On POWER ON	
Effect:	<ul style="list-style-type: none"> <li>• Processing interruption</li> <li>• NC START disabled</li> <li>• Cancellation of Mode Group Ready</li> <li>• Opening of NC Ready Relay</li> </ul>	
Explanation:	A wrong assignment in machine data has been chosen on installation. The NC is not operational without channel assignment. At least 1 channel must be assigned to each NC CPU.	
Remedy:	Check channel assignment machine data and correct (MD 100*)	



<b>71</b>	<b>NC CPU not available</b>	
Scan:	On POWER ON	
Effect:	<ul style="list-style-type: none"> <li>• Processing interruption</li> <li>• NC START disabled</li> <li>• Cancellation of Mode Group Ready</li> <li>• Opening of NC Ready Relay</li> <li>• Alarm is displayed with reference to block</li> </ul>	
Explanation:	<ul style="list-style-type: none"> <li>• A wrong assignment in machine data has been chosen on installation. One channel has been assigned to a non-existing NC CPU.</li> </ul>	
Remedy:	Check channel assignment machine data and correct (MD 102*)	
<b>72</b>	<b>One channel too many in mode group</b>	
Scan:	On POWER ON	
Effect:	<ul style="list-style-type: none"> <li>• Processing interruption</li> <li>• NC START disabled</li> <li>• Cancellation of Mode Group Ready</li> <li>• Opening of NC Ready Relay</li> </ul>	
Explanation:	<ul style="list-style-type: none"> <li>• Alarm is displayed with reference to block</li> <li>• A wrong assignment in machine data has been chosen on installation. Too many channels have been assigned to one mode group.</li> </ul>	
Remedy:	Check mode group assignment machine data and correct (MD 100*)	
<b>73</b>	<b>One axis too many in mode group</b>	
Scan:	On POWER ON	
Effect:	<ul style="list-style-type: none"> <li>• Processing interruption</li> <li>• NC START disabled</li> <li>• Cancellation of Mode Group Ready</li> <li>• Opening of NC Ready Relay</li> </ul>	
Explanation:	<ul style="list-style-type: none"> <li>• Alarm is displayed with reference to block</li> <li>• A wrong assignment in machine data has been chosen on installation. Too many axes have been assigned to one mode group.</li> </ul>	
Remedy:	Check mode group assignment machine data and correct	



<b>74</b>	<b>One channel too many in the NC CPU</b>	
Scan:	On POWER ON	
Effect:	<ul style="list-style-type: none"> <li>• Processing interruption</li> <li>• NC START disabled</li> <li>• Cancellation of Mode Group Ready</li> <li>• Opening of NC Ready Relay</li> </ul>	
Explanation:	<ul style="list-style-type: none"> <li>• Alarm is displayed with reference to block</li> <li>• A wrong assignment in machine data has been chosen on installation. Too many channels have been assigned to one NC CPU.</li> </ul>	
Remedy:	Check channel assignment machine data and correct (MD 102*)	
<b>75</b>	<b>Too many control circuits on the CPU</b>	
Scan:	On POWER ON	
Effect:	<ul style="list-style-type: none"> <li>• Processing interruption</li> <li>• NC START disabled</li> <li>• Cancellation of Mode Group Ready</li> <li>• Opening of NC Ready Relay</li> </ul>	
Explanation:	<ul style="list-style-type: none"> <li>• Alarm is displayed with reference to block</li> <li>• Too many real axes and spindles have been defined in the machine data.</li> </ul>	
Remedy:	Check machine data and correct	
<b>76</b>	<b>Wrong measuring circuit assignment</b>	
Scan:	On POWER ON	
Effect:	<ul style="list-style-type: none"> <li>• Processing interruption</li> <li>• NC START disabled</li> <li>• Cancellation of Mode Group Ready</li> <li>• Opening of NC Ready Relay</li> </ul>	
Explanation:	<ul style="list-style-type: none"> <li>• Alarm is displayed with reference to block</li> <li>• A wrong assignment in machine data has been chosen on installation. One axis/spindle has been assigned to a wrong measuring circuit or a wrong measuring circuit module.</li> </ul>	
Remedy:	Check machine data and correct	

<b>77</b>	<b>Illegal mode group no. of axis</b>	
Scan:	On POWER ON	
Effect:	<ul style="list-style-type: none"> <li>• Processing interruption</li> <li>• NC START disabled</li> <li>• Cancellation of Mode Group Ready</li> <li>• Opening of NC Ready Relay</li> </ul>	
Explanation:	<ul style="list-style-type: none"> <li>• Axis has been assigned to a wrong mode group</li> </ul>	
Remedy:	Check machine data 360* and correct	
<b>78</b>	<b>Illegal mode group no. of spindle</b>	
Scan:	On POWER ON	
Effect:	<ul style="list-style-type: none"> <li>• Processing interruption</li> <li>• NC START disabled</li> <li>• Cancellation of Mode Group Ready</li> <li>• Opening of NC Ready Relay</li> </ul>	
Explanation:	<ul style="list-style-type: none"> <li>• Spindle has been assigned to a wrong mode group</li> </ul>	
Remedy:	Check machine data 453* and correct	
<b>79</b>	<b>Illegal mode group no. of channel</b>	
Scan:	On POWER ON	
Effect:	<ul style="list-style-type: none"> <li>• Processing interruption</li> <li>• NC START disabled</li> <li>• Cancellation of Mode Group Ready</li> <li>• Opening of NC Ready Relay</li> </ul>	
Explanation:	<ul style="list-style-type: none"> <li>• Channel has been assigned to a wrong mode group</li> </ul>	
Remedy:	Check machine data 100* and correct	
<b>80</b>	<b>Illegal NC no. of channel</b>	
Scan:	On POWER ON	
Effect:	<ul style="list-style-type: none"> <li>• Processing interruption</li> <li>• NC START disabled</li> <li>• Cancellation of Mode Group Ready</li> <li>• Opening of NC Ready Relay</li> </ul>	
Explanation:	<ul style="list-style-type: none"> <li>• Channel has been assigned to a wrong NC CPU</li> </ul>	
Remedy:	Check machine data 102* and correct	

<b>81</b>	<b>More than two 2D interpolations</b>	
Scan:	On each block change	
Effect:	<ul style="list-style-type: none"> <li>• Processing interruption</li> <li>• NC START disabled</li> <li>• Cancellation of Mode Group Ready</li> <li>• Opening of NC Ready Relay</li> </ul>	
Explanation:	<ul style="list-style-type: none"> <li>• Alarm is displayed with reference to block</li> <li>• The NC is an export version. In the NC, 2 axes (2D interpolation) have been programmed in more than 2 channels in one program block.</li> </ul>	
Remedy:	<ul style="list-style-type: none"> <li>• Modify program</li> <li>• Do not run more than 2 programs simultaneously</li> </ul>	
<b>82</b>	<b>Wrong simulation channel selected</b>	
Scan:	On pressing the "UM FORMAT" softkey	
Effect:	None	
Erläuterung:	Graphics simulation is not possible because a wrong value has been specified in NC MD 173	
Remedy:	Correct NC MD 173 (input value 1 or 2)	
<b>83</b>	<b>Wrong no. of SWD parameters</b>	
Scan:	On pressing the "UM FORMAT" softkey	
Effect:	None	
Explanation:	Graphics simulation is not possible because a wrong value has been specified in NC MD 172	
Remedy:	Correct NC MD 172 (only input value 8 permissible)	





<b>84</b>	<b>Incorrect coupled axis grouping</b>	
Scan:	<ul style="list-style-type: none"> <li>• On POWER ON</li> <li>• On warm restart</li> </ul>	
Effect:	<ul style="list-style-type: none"> <li>• Processing interruption</li> <li>• NC START disabled</li> <li>• Cancellation of Mode Group Ready</li> <li>• Opening of NC Ready Relay</li> </ul>	
Explanation:	<p>An incorrect coupled motion grouping has been specified in NC MD 876 to 899 or 5156 to 5182, e. g.</p> <ul style="list-style-type: none"> <li>• Axes do not belong to the same mode group</li> <li>• Axes have different position control resolutions</li> <li>• Different axis type (linear axis/rotary axis)</li> <li>• Axes are not available (NC MD 564* bit 7=0)</li> <li>• Axes are fictitious axes</li> <li>• Leading axis=following axis</li> </ul>	
Remedy:	<ul style="list-style-type: none"> <li>• Correct NC MDs 876 to 899</li> <li>• Correct NC MDs 5156 to 5182</li> </ul>	
<b>85</b>	<b>Wrong coupled motion combination</b>	
Scan:	<ul style="list-style-type: none"> <li>• On POWER ON</li> <li>• On warm restart</li> </ul>	
Effect:	<ul style="list-style-type: none"> <li>• Processing interruption</li> <li>• NC START disabled</li> <li>• Cancellation of Mode Group Ready</li> <li>• Opening of NC Ready Relay</li> </ul>	
Explanation:	<p>The undefinable bit combination "01" has been entered in the NC MDs 5156 to 5182</p>	
Remedy:	<p>Correct NC MDs 5156 to 5182</p>	
<b>87</b>	<b>Illegal software limit switch</b>	
Scan:	<p>On modification of MD</p>	
Effect:	<ul style="list-style-type: none"> <li>• Processing interruption</li> <li>• NC START disabled</li> <li>• Cancellation of Mode Group Ready</li> <li>• Opening of NC Ready Relay</li> </ul>	
Explanation:	<ul style="list-style-type: none"> <li>• An excessive value has been entered in NC MDs 224* to 236*. The maximum traversing range of the individual axes is determined by the axis-specific position control resolution set and the input resolution. The control has automatically entered the maximum permissible value in the relevant NC MDs on activation of Alarm 87.</li> </ul>	
Remedy:	<p>Correct NC MD 224* to 236* if necessary</p>	

<b>88</b>	<b>Interpolation greater than 3D</b>	
Scan:	On processing part programs in AUTOMATIC or MDA mode	
Effect:	<ul style="list-style-type: none"> <li>• Processing interruption</li> <li>• NC START disabled</li> <li>• Cancellation of Mode Group Ready</li> <li>• Opening of NC Ready Relay</li> </ul>	
Explanation:	<ul style="list-style-type: none"> <li>• Alarm is displayed with reference to block</li> <li>• More than 3 axes are programmed in one block in the NC part program block or the 5D function is not provided</li> </ul>	
Remedy:	<ul style="list-style-type: none"> <li>• Check part program</li> <li>• Divide program block into two separate blocks</li> <li>• Have function option checked by a service expert and retrofit if necessary</li> </ul>	
<b>89</b>	<b>More than two 3D interpolations</b>	
Scan:	On processing part program blocks in AUTOMATIC or MDA mode	
Effect:	<ul style="list-style-type: none"> <li>• Processing interruption</li> <li>• NC START disabled</li> <li>• Cancellation of Mode Group Ready</li> <li>• Opening of NC Ready Relay</li> </ul>	
Explanation:	<ul style="list-style-type: none"> <li>• Alarm is displayed with reference to block</li> <li>• In the NC, more than 3 axes are programmed in one program block in more than 2 channels</li> </ul>	
Remedy:	<ul style="list-style-type: none"> <li>• Modify program</li> <li>• Process up to 2 programs simultaneously</li> </ul>	
<b>100*</b>	<b>Illegal leadscrew error compensation grid spacing</b>	
Scan:	Cyclic	
Effect:	NC START disabled	
Explanation:	<ul style="list-style-type: none"> <li>• The permissible range (1 to 1000 lead screw error compensation points) has been exceeded in axis traversing movements.</li> <li>• Lead screw error compensation for rotary axes. A wrong value for the relevant axis has been entered in NC machine data 324*.</li> </ul> <p>Formula: <math>360/\text{input value} = \text{number of grid spacings}</math> The number of grid points must be an interger!</p> <p>Examples: NC MD 324*=10      360/10=360000 grid points           NC MD 324*=12      360/12=300000 grid points           NC MD 324*=14      360/14=257143 grid points</p> <p>The value 14 is not permissible because the result must always be an interger</p>	
Remedy:	Modify NC MD 324*	

<b>104*</b>	<b>DAC limit</b>	
Scan:	Cyclic	
Effect:	<ul style="list-style-type: none"> <li>• NC START disabled</li> <li>• The drive will oscillate if too high a velocity is entered</li> <li>• Alarm 156* "Setpoint speed too high" is triggered if there is a fault in the drive</li> </ul>	
Explanation:	The DAC setpoint is higher than entered in NC MD 268* (maximum DAC setpoint). It is not possible to increase the DAC setpoint further.	
Remedy:	<ul style="list-style-type: none"> <li>• Traverse more slowly</li> <li>• Check actual value (encoder)</li> <li>• Check NC MD 268*</li> <li>• Check the drive actuator</li> </ul>	

<b>108*</b>	<b>Overflow with variable increment weighting</b>	
Scan:	On each axis movement	
Effect:	<ul style="list-style-type: none"> <li>• Processing interruption</li> <li>• NC START disabled</li> <li>• Cancellation of Mode Group Ready</li> <li>• The servo enable is cancelled after the time stored in NC MD 156 has elapsed (servo enable relay drops out)</li> <li>• Follow-up mode</li> </ul>	
Explanation:	If a value is entered in NC MDs 364*, 368* (pulse weighting) which is not 1:1, the actual part value must be multiplied by the control. With rapid traverse of the axis, the register will overflow in the case of a fault. The reference point is lost.	
Remedy:	<ul style="list-style-type: none"> <li>• Reduce maximum velocity (NC MD 280*); maximum velocity depends on NC MDs 364* and 368*</li> <li>• Check MDs 364* and 368*</li> <li>• Check actual values (encoder)</li> </ul>	

<b>112*</b>	<b>Zero speed control</b>	
<p>Scan:</p> <p>Effect:</p> <p>Explanation:</p> <p>Remedy:</p>	<ul style="list-style-type: none"> <li>• On standstill</li> <li>• On clamping</li> <li>• On deceleration</li> <li>• Processing interruption</li> <li>• NC START disabled</li> <li>• Cancellation of Mode Group Ready</li> <li>• Opening of NC Ready Relay</li> <li>• The servo enable is cancelled after the time stored in NC MD 156 has elapsed (servo enable relay drops out)</li> <li>• Follow-up mode</li> <li>• The following error could not be cleared faster than the time entered in NC MD 156</li> <li>• On clamping, the limit defined in NC MD 212* was exceeded</li> <li>• A mechanically clamped axis has been pushed out of position</li> <li>• Fault in the control device (actuator), at the tacho-generator, at the motor, in the NC measuring circuit hardware or at/on the encoder</li> <li>• Wrong position feedback polarity direction on installation</li> <li>• NC MD 212* (clamping tolerance) must be greater than NC MD 204* (exact stop limit)</li> <li>• NC MD 156 (servo enable cutoff delay) must be large enough to allow the following error to be cleared within this period (this only applies if NC MD 372* = 0)</li> <li>• NC MD 372* (zero-speed control delay) must be large enough to allow the following error of the axis to be cleared within the period entered</li> <li>• Check actual values (encoder) and position control polarity</li> <li>• Reduce acceleration (acceleration/delay so large that the circuit voltage in the drive will reach the permissible limit)</li> </ul>	



116*	Contour monitoring	
Scan:	When machining in AUTOMATIC/MDA, but <b>not</b> : <ul style="list-style-type: none"> <li>• When accelerating</li> <li>• When decelerating</li> <li>• At speeds lower than that in NC MD 336* (contour speed)</li> </ul>	
Effect:	<ul style="list-style-type: none"> <li>• Processing interruption</li> <li>• NC START disabled</li> <li>• Cancellation of Mode Group Ready</li> <li>• The servo enable is removed after the time stored in NC MD 156 has elapsed (servo enable relay drops out)</li> <li>• Follow-up mode</li> </ul>	
Explanation:	<ul style="list-style-type: none"> <li>• With a speed greater than that in NC MD 336* the tolerance band in NC MD 332* has been exceeded</li> <li>• When accelerating or decelerating the axis has not reached the new speed within the time defined by the servo gain factor</li> </ul>	
Remedy:	<ul style="list-style-type: none"> <li>• Increase the tolerance band in NC MD 332*</li> <li>• Check the servo gain factor</li> <li>• Check the optimization of the speed controller</li> <li>• Check the actual values (encoder)</li> <li>• Check the free movement of the axes</li> <li>• Reduce acceleration</li> </ul>	

<b>120*</b>	<b>Illegal axis specification</b>	
<p>Scan:</p> <p>Effect:</p> <p>Explanation:</p> <p>Remedy:</p>	<ul style="list-style-type: none"> <li>• On standstill</li> <li>• On clamping</li> <li>• When decelerating</li> <li>• Processing interruption</li> <li>• NC START disabled</li> <li>• Servo enable is cancelled after the time in NC MD 156 has elapsed (servo enable relay drops out)</li> <li>• Follow-up mode</li> <li>• Missing setting via MD200* or MD384* of the axis concerned Example: MD2000=01020101 and MD3840=00000000</li> <li>• The module number set in MD200* or MD 384* is larger than the number of measuring circuit modules available Example: MD2000=04010000 and only 3 measuring-circuit modules inserted</li> <li>• The connection number set in MD200* or MD384* is larger than the number of available connections on the module in question Example: MD3840=02070000, the 2nd measuring-circuit module is an SPC module and has only 6 terminals</li> <li>• Connection number for an input is assigned to an output and vice versa Example: MD3840=01030000, the 1st measuring-circuit module is an HMS module on which terminal no. 3 is an input terminal</li> <li>• Input and output assignment is not compatible with the insertion sub-module Example: MD2000=01040101, the 1st measuring-circuit module is an HMS module with output submodule servo command 6FX1132-5BAxx in its submodule slot 1</li> <li>• Check and correct MD 200* and 384* of the axis concerned. These machine data must both be specified or be zero. They must also agree with the hardware configuration.</li> </ul>	

<b>128*</b>	<b>Measuring circuit not available</b>	
<p>Scan:</p> <p>Effect:</p> <p>Explanation:</p> <p>Remedy:</p>	<p>On POWER ON</p> <ul style="list-style-type: none"> <li>• Processing interruption</li> <li>• NC START disabled</li> <li>• Cancellation of Mode Group Ready</li> <li>• In NC MD 200* or 400* measuring circuits have been assigned to axes or spindles which have been recognised by the NC as non-existent after POWER-ON RESET</li> <li>• Measuring circuit module removed or defective</li> <li>• Check machine data</li> <li>• Check measuring circuit module</li> </ul>	

<b>132*</b>	<b>Control loop hardware</b>	
Scan:	Cyclic	
Effect:	<ul style="list-style-type: none"> <li>• Processing interruption</li> <li>• NC START disabled</li> <li>• Cancellation of Mode Group Ready</li> <li>• The servo enable is removed after the time stored in NC MD 156 has elapsed (servo enable relay drops out)</li> <li>• Follow-up mode</li> </ul>	
Explanation:	<p>The measuring circuit differential signals</p> <ul style="list-style-type: none"> <li>• are not in phase</li> <li>• have a short-circuit to earth</li> <li>• are missing</li> </ul>	
Remedy:	<ul style="list-style-type: none"> <li>• Check that the measuring circuit connector is inserted</li> <li>• By plugging in the measuring circuit short-circuit connector it can be checked whether the measuring circuit module is in working order</li> <li>• Check the differential signals with an oscilloscope</li> <li>• Replace the measuring sensors</li> <li>• Check NC MD 200*, 384*</li> <li>• Check IAR MD 100*</li> </ul>	
<b>Caution:</b>	The alarm can only be deleted with POWER ON	

<b>136*</b>	<b>Measuring system dirty</b>	
Scan:	Cyclic	
Effect:	<ul style="list-style-type: none"> <li>• Processing interruption</li> <li>• NC START disabled</li> <li>• Cancellation of Mode Group Ready</li> </ul>	
Explanation:	In measuring systems with contamination signal (e.g. EXE), the measuring system signals a fault to the NC	
Remedy:	Check the measuring system following the manufacturer's instructions	
<b>Caution:</b>	The alarm can only be cancelled with POWER ON	



<b>140*</b>	<b>Encoder monitoring</b>	
Scan: Effect: Explanation: Remedy:	<p>On axis motions (setpoint not equal to 0) if the function has been activated via machine data bit</p> <ul style="list-style-type: none"> <li>• Processing interruption</li> <li>• NC START disabled</li> <li>• Cancellation of Mode Group Ready</li> </ul> <ul style="list-style-type: none"> <li>• Only check 32 bit servo CPUs</li> <li>• Too many directional changes have been recognized in the actual position value between position control timers. Possible causes are: <ul style="list-style-type: none"> <li>– One encoder track is broken or connected to a fixed potential (typical fault)</li> <li>– The encoder is precisely located on an edge and the hardware tends to oscillate (effect of contamination)</li> <li>– Fault in the electronics leads to clattering of one track (effect of contamination)</li> </ul> </li> </ul> <p>Check encoder track</p>	
<b>144*</b>	<b>Zero mark monitoring</b>	
Scan: Effect: Explanation: Remedy:	<p>Cyclic, depending on specification of tolerance band for differential pulses</p> <ul style="list-style-type: none"> <li>• Processing interruption</li> <li>• NC START disabled</li> </ul> <p>Pulses have been lost as a result of errors in transfer or other faults beyond the permissible tolerance band with reference to one encoder revolution. The tolerance band is checked by a reference meter.</p> <ul style="list-style-type: none"> <li>• Check encoder pulses and establish permissible deviation</li> <li>• Check transmission path</li> <li>• Switch off monitoring temporarily by specifying a value greater than 16 in the machine data (NC MD 216*)</li> </ul>	
<b>148*</b> <b>152*</b>	<b>+ Software overtravel (limit) switch</b> <b>– Software overtravel (limit) switch</b>	
Scan: Effect: Explanation: Remedy:	<p>At each axis movement</p> <ul style="list-style-type: none"> <li>• Processing interruption</li> <li>• NC START disabled</li> </ul> <ul style="list-style-type: none"> <li>• The software limit switches are only active after reference point approach</li> <li>• Depending on the PLC interface signal 2ND SOFTWARE LIMIT SWITCH ACTIVE, the 1st or 2nd software limit switch has been approached</li> <li>• Traverse away from the limit switch in opposite direction</li> </ul> <p>Check NC MDs 224*, 228*, 232*, 236*</p>	





<b>156*</b>	<b>Set speed too high</b>	
Scan:	Cyclic	
Effect:	<ul style="list-style-type: none"> <li>• Processing interruption</li> <li>• NC START disabled</li> <li>• Cancellation of Mode Group Ready</li> <li>• The servo enable is removed after the time stored in NC MD 156 has elapsed (servo enable relay drops out)</li> <li>• Follow-up mode</li> </ul>	
Explanation:	<ul style="list-style-type: none"> <li>• A higher set speed has been output in the control than that specified in NC MD 264*</li> <li>• The motor cannot follow the speed command value</li> <li>• On installation: wrong position control direction</li> </ul>	
Remedy:	<ul style="list-style-type: none"> <li>• Check whether the value in NC MD 264* is higher than the value in NC MD 268*</li> <li>• Check the drive</li> <li>• Check the position control direction</li> <li>• Check the set speed cable</li> <li>• Check the actual values (pulse encoder)</li> <li>• Check IAR MD 124* and 136*</li> </ul>	



<b>160*</b>	<b>Drift too high</b>	
Scan:	Only with semiautomatic drift compensation	
Effect:	<ul style="list-style-type: none"> <li>• NC START disabled</li> <li>• The green "Position not yet reached" LED lights up</li> <li>• No traverse movement possible</li> </ul>	
Explanation:	The drift to be compensated by the NC itself has risen to over approx. 500mV	
Remedy:	<ul style="list-style-type: none"> <li>• Execute drift compensation in NC MD 272* (see also Installation Guide) Operation: <ol style="list-style-type: none"> <li>1. Select NC MD 272*</li> <li>2. Press the "EDIT" key</li> </ol> </li> <li>• Check that the drift has been correctly adjusted on the drive unit</li> </ul>	

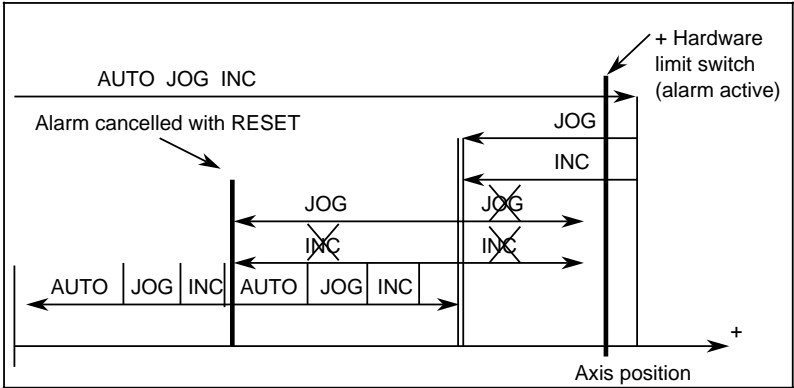

<b>164*</b>	<b>Synch. (coupled) axis programmed</b>	
Scan:	On processing in AUTOMATIC or MDA mode	
Effect:	<ul style="list-style-type: none"> <li>• Processing interruption</li> <li>• NC START disabled</li> <li>• Cancellation of Mode Group Ready</li> </ul>	
Explanation:	Despite the fact that coupled motion has been selected a following axis was programmed	
Remedy:	Program program axis	



<b>168*</b>	<b>Servo enable refused for traversing axis</b>	
Scan: Effect:  Explanation: Remedy:	<p>At each axis movement</p> <ul style="list-style-type: none"> <li>• Processing interruption</li> <li>• NC START disabled</li> <li>• Cancellation of Mode Group Ready</li> <li>• The servo enable is removed after the time stored in NC MD 156 has elapsed (servo enable relay drops out)</li> <li>• Follow-up mode</li> </ul> <p>The axis-specific servo enable signal was removed by the PLC during traversing</p> <p>Check the PLC program</p>	
<b>172*</b> <b>176*</b>	<p>+ Working area limitation</p> <p>- Working area limitation</p>	
Scan: Effect:  Explanation: Remedy:	<p>Cyclic after reference point approach</p> <ul style="list-style-type: none"> <li>• Processing interruption</li> <li>• NC START disabled</li> </ul> <p>The working area limitation in the setting data has been reached</p> <ul style="list-style-type: none"> <li>• Check the working area limitation in setting data (selection via the "SETTING DATA" and "AXIAL DATA" softkeys)</li> <li>• Check G25/G26 in the part program and modify if necessary</li> <li>• Move relevant axis clear of limitation</li> <li>• Cancel "Reference point reached" signal (e. g. define axis as "parking axis")</li> </ul>	
<b>180*</b>	<b>Axis activated in several channels</b>	
Scan: Effect:  Explanation: Remedy:	<p>On processing in AUTOMATIC or MDA mode</p> <ul style="list-style-type: none"> <li>• Processing interruption</li> <li>• NC START disabled</li> <li>• Cancellation of Mode Group Ready</li> </ul> <p>This alarm is displayed with reference to the channel and to the block</p> <ul style="list-style-type: none"> <li>• On simultaneous processing of two or more programs in different channels the same axis has been programmed in both programs (channels)</li> </ul> <ul style="list-style-type: none"> <li>• Check both programs</li> <li>• Insert L999 or @ 714</li> <li>• Stop one channel with NC STOP</li> </ul>	



<p><b>188*</b> <b>192*</b></p>	<p>+ Hardware overtravel (limit) switch                  - Hardware overtravel (limit) switch</p>	
<p>Scan:                  Effect:                  Explanation:                  Remedy:</p>	<p>Cyclic</p> <ul style="list-style-type: none"> <li>Processing interruption</li> <li>NC START disabled</li> <li>Direction key disabled in approach direction</li> </ul> <p>Limit switch reached</p> <ul style="list-style-type: none"> <li>Traverse in opposite direction (correct operating mode)</li> </ul> <div data-bbox="435 541 1224 926" style="border: 1px solid black; padding: 5px;">  </div> <ul style="list-style-type: none"> <li>Check PLC user program</li> <li>Check LIMITATION signals in DB 32</li> </ul>	



<p><b>196*</b></p>	<p>Synch. (coupled) axis assigned 2 x</p>	
<p>Scan:                  Effect:                  Explanation:                  Remedy:</p>	<p>On processing in AUTOMATIC or MDA mode</p> <ul style="list-style-type: none"> <li>NC START disabled</li> <li>Two leading axes have been programmed whose following axes are identical                         <ul style="list-style-type: none"> <li>Axis X axis Y</li> <li>Axis Z axis Y</li> </ul> </li> </ul> <p>Two leading axes have been programmed, one of these also being the following axis of the other leading axis</p> <ul style="list-style-type: none"> <li>Axis X axis Y</li> <li>Axis Y axis Z</li> </ul> <p>Correct program</p>	

<b>2000</b>	<b>Emergency Stop</b>	
Scan:	Cyclic	
Effect:	<ul style="list-style-type: none"> <li>• Processing interruption</li> <li>• NC START disabled</li> <li>• Follow-up mode</li> </ul>	
Explanation:	The EMERGENCY STOP signal is output from the PLC to the NC	
Remedy:	<ul style="list-style-type: none"> <li>• Check with PLC STATUS</li> <li>• Check whether the "EMERGENCY STOP" cam was traversed to, or whether the "EMERGENCY STOP" switch was operated</li> <li>• Check PLC user program</li> <li>• Delete the alarm by setting the signal ACKNOWLEDGE NC EMERGENCY STOP</li> </ul>	
<b>2031</b>	<b>Weighting factor too large/small</b>	
Scan:	Cyclic	
Effect:	<ul style="list-style-type: none"> <li>• Processing interruption</li> <li>• NC START disabled</li> </ul>	
Explanation:	On account of the weighting factor the actual axis speed is so high that the maximum permissible speed would be exceeded with the axis-specific position control resolution set	
Remedy:	<ul style="list-style-type: none"> <li>• Check NC MD 388*</li> <li>• Program lower speed</li> <li>• Reduce feedrate/rapid traverse override</li> </ul>	
<b>2035</b>	<b>Feedrate limitation</b>	
Scan:	On processing in AUTOMATIC or MDA mode	
Effect:	None	
Explanation:	<ul style="list-style-type: none"> <li>• The programmed speed is greater than the path speeds resulting from the maximum speeds of the axes</li> <li>• The programmed distance to go in the thread block is equal to zero</li> </ul>	
Remedy:	<ul style="list-style-type: none"> <li>• Do not program a spindle speed with G95/G33</li> <li>• Check NC MD 280*</li> <li>• Check part program</li> </ul>	

<b>2036</b>	<b>G35 thread lead decrease error</b>	
Scan:	On thread cutting	
Effect:	<ul style="list-style-type: none"> <li>• Processing interruption</li> <li>• NC START disabled</li> </ul>	
Explanation:	<ul style="list-style-type: none"> <li>• Alarm is displayed with reference to block</li> <li>• The pitch decrease in threading is so high that at the end of the thread, a diameter of 0 would arise</li> </ul>	
Remedy:	Program a lower pitch decrease or a shorter thread	
<b>2037</b>	<b>Prog. S value too high</b>	
Scan:	On processing part programs in AUTOMATIC or MDA mode	
Effect:	None	
Explanation:	<ul style="list-style-type: none"> <li>• The programmed spindle speed in AUTOMATIC is too high</li> <li>• An excessive feedrate has been calculated for thread cutting (G33/G34/G35) as a result of the programmed spindle speed</li> </ul>	
Remedy:	Program a lower spindle speed	
<b>2038</b>	<b>Path feed too high</b>	
Scan:	Cyclic	
Effect:	<ul style="list-style-type: none"> <li>• Processing interruption</li> <li>• NC START disabled</li> <li>• Cancellation of Mode Group Ready</li> </ul>	
Explanation:	<ul style="list-style-type: none"> <li>• Alarm is displayed with reference to block</li> <li>• The axis speed has caused the programmed path feed to increase so much that the maximum permissible axis speed would be exceeded with the position control resolution set</li> </ul>	
Remedy:	<ul style="list-style-type: none"> <li>• Program a lower path feed</li> <li>• Check interpolation condition in the part program block</li> </ul>	

<b>2039</b>	<b>Reference point not reached</b>	
Scan: Effect: Explanation: Remedy:	On starting a part program/program block in AUTOMATIC or MDA mode None The reference point has not been traversed to by at least one axis and "NC START" has been pressed in MDA or AUTOMATIC mode. <ul style="list-style-type: none"> <li>• Approach reference point</li> <li>• The alarm does not appear if NC MD 5004 "NC START without reference point" is set.</li> <li>• This alarm can be disabled axis-specifically in NC MD 560*</li> </ul>	
<b>2041</b>	<b>Program not in memory</b>	
Scan: Effect: Explanation: Remedy:	On specification of a program number and subsequent NC START <ul style="list-style-type: none"> <li>• Processing interruption</li> <li>• NC START disabled</li> </ul> Alarm is displayed channel-specific and with reference to block <ul style="list-style-type: none"> <li>• The pre-selected program is not in the memory</li> <li>• A non-existing subroutine is called in the main program</li> <li>• The contour for the stock removing cycle does not exist</li> </ul> <ul style="list-style-type: none"> <li>• Look in "DIRECTORY"</li> <li>• Check program</li> </ul>	
<b>2042</b>	<b>Parity error in memory</b>	
Scan: Effect: Explanation: Remedy:	On processing in AUTOMATIC or MDA mode <ul style="list-style-type: none"> <li>• Processing interruption</li> <li>• NC START disabled</li> </ul> Alarm is displayed channel-specific and with reference to block <ul style="list-style-type: none"> <li>• One or more characters in the memory have been corrupted and can no longer be identified. These characters are output in the "Correction block" or in the "EDITOR" as "?".</li> </ul> <ul style="list-style-type: none"> <li>• Correct the program in "EDITOR" or delete the complete block and re-enter it if necessary</li> </ul>	

<b>2043</b>	<b>Prog. error transformation</b>	
Scan: Effect: Explanation: Remedy:	<p>On processing in AUTOMATIC or MDA mode</p> <p>NC START disabled</p> <ul style="list-style-type: none"> <li>• Alarm is displayed channel-specific and with reference to block</li> <li>• Programming of real axis with transformation selected</li> <li>• Programming of fictitious axes with transformation deselected</li> <li>• Selection of transformation although transformation has already been deselected</li> <li>• Programming of traversing movements in the selection block of transformation</li> </ul> <p>Correct program</p>	
<b>2044</b>	<b>External processing error</b>	
Scan: Effect: Explanation: Remedy:	<p>On starting an external program</p> <ul style="list-style-type: none"> <li>• Processing interruption</li> <li>• NC START disabled</li> </ul> <p>Alarm is displayed channel-specific and with reference to block</p> <p>The alarm is displayed:</p> <ul style="list-style-type: none"> <li>– if an external program selected is already being processed in another channel</li> <li>– if an interface (V.24 or File transfer) is to be started in several channels, or if the interface is already busy</li> <li>– if the 2nd interface of an interface pair (1st and 2nd V.24, 3rd and 4th V.24) is to be started while the 1st interface is busy</li> </ul> <ul style="list-style-type: none"> <li>• Check NC machine data 130*</li> <li>• Check the active interfaces</li> </ul>	
<b>2045</b>	<b>Program already available</b>	
Scan: Effect: Explanation: Remedy:	<p>On NC START, if "Processing an external program" has been selected</p> <p>Processing not started</p> <p>A program having the same program number as the external program to be processed is already in the part program memory</p> <p>Rename the existing program or clear</p>	



<b>2046</b>	<b>Block &gt; 120 characters</b>	
Scan:	On processing in AUTOMATIC or MDA mode	
Effect:	<ul style="list-style-type: none"> <li>• Processing interruption</li> <li>• NC START disabled</li> </ul>	
Explanation:	<ul style="list-style-type: none"> <li>• Alarm is displayed channel-specific and with reference to block</li> <li>• An "Lf" in the memory has been corrupted so that a block containing more than 120 characters exists</li> </ul>	
Remedy:	Insert "Lf" without deleting the complete block	
<b>2047</b>	<b>Option not available</b>	
Scan:	On processing in AUTOMATIC or MDA mode	
Effect:	<ul style="list-style-type: none"> <li>• Processing interruption</li> <li>• NC START disabled</li> </ul>	
Explanation:	<ul style="list-style-type: none"> <li>• Alarm is displayed channel-specific and with reference to block</li> <li>• A function has been programmed that is not included in the function set of the control</li> </ul>	
Remedy:	<ul style="list-style-type: none"> <li>• Correct program</li> <li>• Check NC MD</li> <li>• Have option checked by Service and retrofit if necessary</li> </ul>	
<b>2048</b>	<b>Circle endpoint error</b>	
Scan:	On processing in AUTOMATIC or MDA mode	
Effect:	<ul style="list-style-type: none"> <li>• Processing interruption</li> <li>• NC START disabled</li> </ul>	
Explanation:	<ul style="list-style-type: none"> <li>• Alarm is displayed channel-specific and with reference to block</li> <li>• The programmed circle end point does not lie on the circle</li> <li>• The end point is out by more than the value entered in NC MD 7</li> </ul>	
Remedy:	Correct program	





<b>2056</b>	<b>Transf. centre travel</b>	
Scan:	On processing in AUTOMATIC (Block search) or MDA mode	
Effect:	<ul style="list-style-type: none"> <li>• Processing interruption</li> <li>• NC START disabled</li> <li>• Block search interrupted</li> </ul>	
Explanation:	<ul style="list-style-type: none"> <li>• Alarm is displayed channel-specific and with reference to block</li> <li>• A part program block has been programmed with selected transformation TRANSMIT that initiates a movement directly through the transformation centre</li> <li>• The path from the start to the end position of the block to be searched passes directly through the transformation centre</li> </ul>	
Remedy:	<ul style="list-style-type: none"> <li>• Correct program</li> <li>• On block search: modify start position in JOG</li> </ul>	

<b>2057</b>	<b>Thread/revolutional feedrate option</b>	
Scan:	On processing a part program block when this option is selected	
Effect:	<ul style="list-style-type: none"> <li>• Processing interruption</li> <li>• NC START disabled</li> </ul>	
Explanation:	<ul style="list-style-type: none"> <li>• Alarm is displayed channel-specific and with reference to block</li> <li>• A thread has been programmed using G33, G34, G35 although this option is not available in the control</li> <li>• Revolutional feedrate G95 has been programmed</li> <li>• In the 880 T the "Revolutional feedrate" NC MD bit has not been set</li> <li>• A function has been programmed that is not included in the function set of the control</li> </ul>	
Remedy:	<ul style="list-style-type: none"> <li>• Correct program</li> <li>• Check NC MD</li> <li>• Have option checked by Service and retrofit if necessary</li> </ul>	



<b>2058</b>	<b>3D interpolation option not available</b>	
Scan:	On processing program blocks in AUTOMATIC or MDA mode	
Effect:	<ul style="list-style-type: none"> <li>• Processing interruption</li> <li>• NC START disabled</li> </ul>	
Explanation:	<ul style="list-style-type: none"> <li>• Alarm is displayed channel-specific and with reference to block</li> <li>• Three or more axes have been programmed in one block</li> </ul>	
Remedy:	<ul style="list-style-type: none"> <li>• Correct program</li> <li>• Check NC MD</li> <li>• Have option checked by Service and retrofit if necessary</li> </ul>	



<b>2059</b>	<b>G92 program error</b>	
Scan:	On processing a relevant part program block	
Effect:	<ul style="list-style-type: none"> <li>• Processing interruption</li> <li>• NC START disabled</li> </ul>	
Explanation:	<ul style="list-style-type: none"> <li>• Alarm is displayed channel-specific and with reference to block</li> <li>• An illegal address character has been used</li> <li>• The unit and working diameter factor is zero</li> </ul>	
Remedy:	<ul style="list-style-type: none"> <li>• Check program block</li> <li>• Check machine data</li> </ul>	
<b>2060</b>	<b>T0, Z0 program error</b>	
Scan:	On processing program blocks in AUTOMATIC or MDA mode	
Effect:	<ul style="list-style-type: none"> <li>• Processing interruption</li> <li>• NC START disabled</li> </ul>	
Explanation:	<ul style="list-style-type: none"> <li>• Alarm is displayed channel-specific and with reference to block</li> <li>• Tool type is 0 (no tool)</li> <li>• A non-existent tool compensation number has been selected</li> <li>• The values in the selected zero offsets or tool compensations are too large</li> </ul>	
Remedy:	<ul style="list-style-type: none"> <li>• Check specifications in the program block</li> <li>• Check machine data specifications</li> <li>• Cancel alarm via the Reset key</li> </ul>	
<b>2061</b>	<b>General program error</b>	
Scan:	On processing a part program or program block in AUTOMATIC or MDA mode	
Effect:	<ul style="list-style-type: none"> <li>• Processing interruption</li> <li>• NC START disabled</li> </ul>	
Explanation:	<ul style="list-style-type: none"> <li>• Alarm is displayed channel-specific and with reference to block</li> <li>• The input resolution determines the range limitation for the positional data. If the programmed path length exceeds the permissible path distance to go, an alarm is activated.</li> </ul>	
Remedy:	<ul style="list-style-type: none"> <li>• Check the program section and correct the incorrect specification</li> <li>• Check the input resolution selected</li> </ul>	





<b>2062</b>	<b>Feed missing/not programmed</b>	
Scan:	On processing program blocks in AUTOMATIC or MDA mode	
Effect:	<ul style="list-style-type: none"> <li>• Processing interruption</li> <li>• NC START disabled</li> </ul>	
Explanation:	<ul style="list-style-type: none"> <li>• Alarm is displayed channel-specific and with reference to block</li> <li>• Revolutional feedrate G95 programmed greater than 50 mm/min</li> <li>• No revolutional feedrate programmed</li> <li>• No F value programmed</li> <li>• No feedrate for soft approach/exit</li> <li>• Zero is specified in MD 280* for the maximum speed of one axis</li> </ul>	
Remedy:	<ul style="list-style-type: none"> <li>• Check specifications in program block</li> <li>• Check machine data specifications</li> <li>• Cancel alarm via the Reset key</li> </ul>	



<b>2063</b>	<b>Thread lead (leadscrew) too high</b>	
Scan:	On thread cutting with G33	
Effect:	<ul style="list-style-type: none"> <li>• Processing interruption</li> <li>• NC START disabled</li> </ul>	
Explanation:	<ul style="list-style-type: none"> <li>• Alarm is displayed channel-specific and with reference to block</li> <li>• The thread lead can be specified in the program under I, J, K. The programmed value exceeds the permissible value depending on the specified display resolution.</li> </ul>	
Remedy:	<ul style="list-style-type: none"> <li>• Correct program block whose block number and channel number is shown in the alarm display</li> </ul>	

<b>2064</b>	<b>Rounding wrongly programmed for rotary axis</b>	
Scan:	On processing in AUTOMATIC or MDA mode	
Effect:	<ul style="list-style-type: none"> <li>• Processing interruption</li> <li>• NC START disabled</li> <li>• The programmed movement in the block is <b>not</b> executed</li> </ul>	
Explanation:	<ul style="list-style-type: none"> <li>• Alarm is displayed channel-specific and with reference to block</li> <li>• If you round to either half or full degrees on a rotary axis, the control will monitor whether the programmed positions correlate with the rounding</li> </ul>	
Remedy:	<ul style="list-style-type: none"> <li>• Program the correct rotary axis position</li> <li>• Check MD 560* bits 2 and 3</li> <li>• Check whether the interface signal CLEAR DISTANCE TO GO has been set (no automatic rounding!)</li> </ul>	
<b>Caution:</b>	<ul style="list-style-type: none"> <li>• In the JOG, INC modes, the control automatically rounds to valid values. In the AUTOMATIC or MDA modes, the control only monitors the programmed positions, without rounding itself.</li> <li>• The INC mode is not permissible</li> </ul>	

<b>2065</b>	<b>Programmed position behind software overtravel (limit) switch</b>	
Scan: Effect: Explanation: Remedy:	<p>On processing in AUTOMATIC or MDA mode</p> <ul style="list-style-type: none"> <li>• Processing interruption</li> <li>• NC START disabled</li> <li>• The programmed movement is <b>not</b> executed</li> </ul> <p>• Alarm is displayed channel-specific and with reference to block</p> <p>• The programmed block end point lies behind the software limit switch</p> <ul style="list-style-type: none"> <li>• Correct program</li> <li>• Check MD224*, 228*, 232*, 236* depending on the 2ND SOFTWARE LIMIT SWITCH VALID PLC interface signal</li> </ul>	
<b>2066</b>	<b>Thread lead increase or decrease too large</b>	
Scan: Effect: Explanation: Remedy:	<p>On processing in AUTOMATIC or MDA mode</p> <ul style="list-style-type: none"> <li>• Processing interruption</li> <li>• NC START disabled</li> </ul> <p>• Alarm is displayed channel-specific and with reference to block</p> <p>• A thread lead or pitch increase or decrease of more than 16 mm/rev (0.6 inch/rev) has been programmed</p> <p>Program a smaller thread lead increase/decrease</p>	
<b>2067</b>	<b>Max. axis speed = 0</b>	
Scan: Effect: Explanation: Remedy:	<p>On processing in AUTOMATIC or MDA mode</p> <ul style="list-style-type: none"> <li>• Processing interruption</li> <li>• NC START disabled</li> </ul> <p>• Alarm is displayed channel-specific and with reference to block</p> <p>• The resulting maximum speed of one axis is equal to 0</p> <p>Check NC MD 280*</p>	

<b>2069</b>	<b>5D TLC (tool length correction) not possible</b>	
Scan:	On processing in AUTOMATIC mode	
Effect:	<ul style="list-style-type: none"> <li>• Processing interruption</li> <li>• NC START disabled</li> </ul>	
Explanation:	<ul style="list-style-type: none"> <li>• Alarm is displayed channel-specific and with reference to block</li> <li>• Cutter radius selected</li> <li>• No linear interpolation selected</li> <li>• Option or NC MD not set or set incorrectly</li> <li>• "3D interpolation" option not set</li> <li>• Export version</li> </ul>	
Remedy:	<ul style="list-style-type: none"> <li>• Check program</li> <li>• Check machine data</li> </ul>	
<b>2072</b>	<b>Incorrect input value)</b>	
Scan:	On processing in AUTOMATIC or MDA mode	
Effect:	<ul style="list-style-type: none"> <li>• Processing interruption</li> <li>• NC START disabled</li> </ul>	
Explanation:	<ul style="list-style-type: none"> <li>• Alarm is displayed channel-specific and with reference to block</li> <li>• Programmed input for contour definition cannot be calculated</li> </ul>	
Remedy:	<ul style="list-style-type: none"> <li>• Check program</li> <li>• Check input values</li> </ul>	
<b>2073</b>	<b>No intersection point</b>	
Scan:	On processing in AUTOMATIC mode	
Effect:	<ul style="list-style-type: none"> <li>• Processing interruption</li> <li>• NC START disabled</li> </ul>	
Explanation:	<ul style="list-style-type: none"> <li>• Alarm is displayed channel-specific and with reference to block</li> <li>• Calculation of the contour definition gives no intersection point with the values programmed</li> </ul>	
Remedy:	Check programmed specifications	

<b>2074</b>	<b>Incorrect angle value</b>	
Scan:	On processing in AUTOMATIC or MDA mode	
Effect:	<ul style="list-style-type: none"> <li>• Processing interruption</li> <li>• NC START disabled</li> </ul>	
Explanation:	<ul style="list-style-type: none"> <li>• Alarm is displayed channel-specific and with reference to block</li> <li>• Angle 360° is programmed</li> <li>• The angle value has no meaning for the contour described</li> </ul>	
Remedy:	Check programmed values and correct	
<b>2075</b>	<b>Incorrect radius value</b>	
Scan:	On processing in AUTOMATIC or MDA mode	
Effect:	<ul style="list-style-type: none"> <li>• Processing interruption</li> <li>• NC START disabled</li> </ul>	
Explanation:	<ul style="list-style-type: none"> <li>• Alarm is displayed channel-specific and with reference to block</li> <li>• Radius value too large</li> <li>• Radius value not allowed for the contour described</li> </ul>	
Remedy:	Check programmed values	
<b>2076</b>	<b>Incorrect G2/G3</b>	
Scan:	On processing in AUTOMATIC or MDA mode	
Effect:	<ul style="list-style-type: none"> <li>• Processing interruption</li> <li>• NC START disabled</li> </ul>	
Explanation:	<ul style="list-style-type: none"> <li>• Alarm is displayed channel-specific and with reference to block</li> <li>• Direction of circle not possible for the described contour</li> </ul>	
Remedy:	Correct program	
<b>2077</b>	<b>Incorrect block sequence</b>	
Scan:	On processing part programs in AUTOMATIC mode	
Effect:	<ul style="list-style-type: none"> <li>• Processing interruption</li> <li>• NC START disabled</li> </ul>	
Explanation:	<ul style="list-style-type: none"> <li>• Alarm is displayed channel-specific and with reference to block</li> <li>• Several blocks are needed for calculation of contour definition <ul style="list-style-type: none"> <li>– Block sequence not correct</li> <li>– Insufficient information (underdefined)</li> </ul> </li> </ul>	
Remedy:	Check programmed values	

<b>2078</b>	<b>Incorrect: input parameter</b>	
Scan:	On processing part programs in AUTOMATIC or MDA mode	
Effect:	<ul style="list-style-type: none"> <li>• Processing interruption</li> <li>• NC START disabled</li> </ul>	
Explanation:	<ul style="list-style-type: none"> <li>• Alarm is displayed channel-specific and with reference to block</li> <li>• Programmed parameter sequence not allowed</li> <li>• Parameter sequence not complete for the described contour</li> </ul> <p>Example: N10... X60 B15 L<sub>F</sub> (Z axis missing) N20... X90 B10 L<sub>F</sub></p>	
Remedy:	Check program	
<b>2081</b>	<b>CRC/TNRC not allowed</b>	
Scan:	On processing in AUTOMATIC mode	
Effect:	<ul style="list-style-type: none"> <li>• Processing interruption</li> <li>• NC START disabled</li> </ul>	
Explanation:	<ul style="list-style-type: none"> <li>• Alarm is displayed channel-specific and with reference to block</li> <li>• The following functions cannot be programmed with cutter radius/tool nose radius compensation selected: G33, G34, G35, G58, G59, G92, G200, @714</li> </ul>	
Remedy:	<ul style="list-style-type: none"> <li>• Preprogram G40</li> <li>• Cancel with G41/G42 D00 (CRC/TNRC)</li> </ul>	
<b>2082</b>	<b>CRC plane not determinable</b>	
Scan:	On processing a part program in AUTOMATIC mode	
Effect:	<ul style="list-style-type: none"> <li>• Processing interruption</li> <li>• NC START disabled</li> </ul>	
Explanation:	<ul style="list-style-type: none"> <li>• Alarm is displayed channel-specific and with reference to block</li> <li>• The axes for the selected CRC plane do not exist</li> </ul>	
Remedy:	<ul style="list-style-type: none"> <li>• MD 548*</li> <li>• MD 550*</li> <li>• Check MD 552*</li> <li>• Select correct plane with G16</li> </ul>	

<b>2087</b>	<b>Coordinate rotation not allowed</b>	
Scan:	On processing in AUTOMATIC or MDA mode	
Effect:	<ul style="list-style-type: none"> <li>• Processing interruption</li> <li>• NC START disabled</li> </ul>	
Explanation:	<ul style="list-style-type: none"> <li>• Alarm is displayed channel-specific and with reference to block</li> <li>• On selection of coordinate rotation (G54 to G59) a circular movement (G02, G03) has been programmed in the next block</li> <li>• The settable zero offset (G54 to G57) has been changed after selection of coordinate rotation (angle 0 degrees)</li> <li>• The plane (G16, G17, G18, G19) has been changed after selection of coordinate rotation (angle 0 degrees)</li> </ul>	
Remedy:	<ul style="list-style-type: none"> <li>• Correct program</li> <li>• The plane can only be changed if the angles of rotation and zero offsets programmed under G58 and G59 are zero</li> <li>• The settable zero offset and coordinate rotation (G54 to G57) can only be changed if the angles of rotation and zero offsets programmed under G58 and G59 are zero (Deselect if necessary)</li> </ul>	

<b>2089</b>	<b>SERVO 1 computing time</b>	
Scan:	Cyclic	
Effect:	<ul style="list-style-type: none"> <li>• Processing interruption</li> <li>• NC START disabled</li> <li>• Cancellation of Mode Group Ready</li> </ul>	
Explanation:	The capacity of one servo CPU is not sufficient for the ratio of number of axes and sampling time set	
Remedy:	Check NC MD 155 and NC MDs 160 to 163 and use additional servo CPUs if necessary	

<b>2105</b>	<b>SERVO 2 computing time</b>	
Scan:	Cyclic	
Effect:	<ul style="list-style-type: none"> <li>• Processing interruption</li> <li>• NC START disabled</li> <li>• Cancellation of Mode Group Ready</li> </ul>	
Explanation:	The capacity of one servo CPU is not sufficient for the ratio of number of axes and sampling time set	
Remedy:	Check NC MD 155 and NC MDs 160 to 163 and use additional servo CPUs if necessary	





<b>2121</b>	<b>SERVO 3 computing time</b>	
Scan:	Cyclic	
Effect:	<ul style="list-style-type: none"> <li>• Processing interruption</li> <li>• NC START disabled</li> <li>• Cancellation of Mode Group Ready</li> </ul>	
Explanation:	The capacity of one servo CPU is not sufficient for the ratio of number of axes and sampling time set	
Remedy:	Check NC MD 155 and NC MDs 160 to 163 and use additional servo CPUs if necessary	



<b>2137</b>	<b>SERVO 4 computing time</b>	
Scan:	Cyclic	
Effect:	<ul style="list-style-type: none"> <li>• Processing interruption</li> <li>• NC START disabled</li> <li>• Cancellation of Mode Group Ready</li> </ul>	
Explanation:	The capacity of one servo CPU is not sufficient for the ratio of number of axes and sampling time set	
Remedy:	Check NC MD 155 and NC MDs 160 to 163 and use additional servo CPUs if necessary	



<b>2160</b>	<b>Scale factor not allowed</b>	
Scan:	On processing in AUTOMATIC or MDA mode	
Effect:	<ul style="list-style-type: none"> <li>• Processing interruption</li> <li>• NC START disabled</li> </ul>	
Explanation:	<ul style="list-style-type: none"> <li>• Alarm is displayed channel-specific and with reference to block</li> <li>• The scale factor has exceeded the valid value range: <ul style="list-style-type: none"> <li>+ P is negative</li> <li>+ P = 0</li> <li>+ P &gt; 99.99999</li> </ul> </li> </ul>	
Remedy:	Observe valid value range for scale factor: (P = 0.00001 to 99.99999)	



<b>2161</b>	<b>Scale change not allowed</b>	
Scan:	On processing in AUTOMATIC or MDA mode	
Effect:	<ul style="list-style-type: none"> <li>• Processing interruption</li> <li>• NC START disabled</li> </ul>	
Explanation:	<ul style="list-style-type: none"> <li>• Alarm is displayed channel-specific and with reference to block</li> <li>• With a scale factor &gt; 1 an axis position has been programmed which is so great that internal representation is no more possible</li> </ul>	
Remedy:	<ul style="list-style-type: none"> <li>• Check programmed axis position</li> <li>• Reduce scale factor</li> </ul>	



<b>2165</b>	<b>Computing time exceeded</b>	
Scan:	Cyclic	
Effect:	<ul style="list-style-type: none"> <li>• Processing interruption</li> <li>• NC START disabled</li> <li>• Cancellation of Mode Group Ready</li> <li>• Opening of NC Ready Relay</li> </ul>	
Explanation:	<p>The number of axes and spindles on the servo CPU is greater than the permissible maximum number.</p> <p>The alarm is also set if the control recognizes the timing error, i. e. processing is no more performed in the IPO clock cycle. The set speeds are set to zero in the event of overrun of position control loops. All mode groups with axes on the relevant servo CPU are instantaneously stopped.</p> <p>The "Computing time exceeded" alarm indicates that the servo CPU is overloaded.</p>	
Remedy:	Report to Service	

<b>2171</b>	<b>Approach not possible</b>	
Scan:	On processing in AUTOMATIC or MDA mode	
Effect:	Processing interruption	
Explanation:	<ul style="list-style-type: none"> <li>• Alarm is displayed channel-specific and with reference to block</li> <li>• No axis of the selected plane (G16, G17, G18, G19) has been programmed in the block following approach so that no vector can be calculated for tangential approach</li> <li>• @714 has been programmed in the selection block or in the subsequent block for soft approach</li> </ul>	
Remedy:	<ul style="list-style-type: none"> <li>• Correct program (G147, G247, G347) by programming at least <b>one</b> axis of the selected plane in the block following approach</li> </ul>	

<b>2172</b>	<b>Retraction not possible</b>	
Scan: Effect: Explanation: Remedy:	On processing in AUTOMATIC or MDA mode Processing interruption <ul style="list-style-type: none"> <li>• Alarm is displayed channel-specific and with reference to block</li> <li>• No axis of the selected plane (G16, G17, G18, G19) has been programmed in the block preceding retraction so that no vector for tangential retraction can be calculated</li> <li>• @714 has been programmed in the deselection block or in the block before</li> <li>• G48 programmed <b>without</b> preceding selection</li> </ul> <ul style="list-style-type: none"> <li>• Correct program (G148, G248, G348, G48) by programming at least <b>one</b> axis of the selected plane in the block preceding retraction</li> </ul>	
<b>2173</b>	<b>Wrong approach/retraction plane</b>	
Scan: Effect: Explanation: Remedy:	On processing in AUTOMATIC or MDA mode Processing interruption <ul style="list-style-type: none"> <li>• Alarm is displayed channel-specific and with reference to block</li> <li>• A change of plane is programmed in the block following selection (G16, G17, G18, G19)</li> <li>• A change of plane is programmed in the deselection block</li> </ul> <ul style="list-style-type: none"> <li>• Correct program (change of plane)</li> </ul>	
<b>2184</b>	<b>Illegal M function for C axis</b>	
Scan: Effect: Explanation: Remedy:	<ul style="list-style-type: none"> <li>• During ramp-up</li> <li>• On warm restart</li> <li>• On MD changes</li> </ul> The C axis drive for spindles on the 32 bit servo CPUs cannot be selected. The numbers of the M functions for selecting and deselecting C axis drive are determined via MD 260 and MD 261. These numbers must not coincide with the defaulted M functions Valid values must be entered in MD 260 and MD 261	





<b>2189</b>	<b>Transformation undefined</b>	
<p>Scan:</p> <p>Effect:</p> <p>Explanation:</p> <p>Remedy:</p>	<p>On selection of transformation</p> <ul style="list-style-type: none"> <li>• NC START disabled</li> <li>• Alarm is displayed with reference to block</li> <li>• Type of transformation not defined</li> <li>• Transformation axes are different mode groups</li> <li>• Option for selected transformation not available</li> <li>• Transformation selected in illegal channel</li> <li>• Transformation defined several times or wrongly defined</li> <li>• Transformation data block declared invalid by Alarm 3087 (error in transformation data)</li> </ul> <ul style="list-style-type: none"> <li>• Check transformation data block</li> <li>• Check program</li> <li>• Check channel number</li> <li>• Have option checked by Service and retrofit if necessary</li> </ul>	
<b>2190</b>	<b>Transformation axes assigned</b>	
<p>Scan:</p> <p>Effect:</p> <p>Explanation:</p> <p>Remedy:</p>	<p>On selection of transformation</p> <ul style="list-style-type: none"> <li>• Processing interruption</li> <li>• NC START disabled</li> <li>• Cancellation of Mode Group Ready</li> </ul> <ul style="list-style-type: none"> <li>• Alarm is displayed with reference to block</li> <li>• A transformation has been selected whose real axes are also used in parallel-running transformation in another channel</li> </ul> <ul style="list-style-type: none"> <li>• Wait for deselection of transformation in parallel-running channel</li> <li>• Check program</li> </ul>	
<b>2191</b>	<b>Transformation at zero</b>	
<p>Scan:</p> <p>Effect:</p> <p>Explanation:</p> <p>Remedy:</p>	<p>On selection of transformation in AUTOMATIC (Block search) or MDA mode</p> <ul style="list-style-type: none"> <li>• NC START disabled</li> <li>• Processing interruption</li> <li>• Block search is interrupted</li> </ul> <ul style="list-style-type: none"> <li>• Alarm is displayed with reference to block</li> <li>• Transformation has been selected at a moment when one or several of the axes involved in transformation were in the actual position ZERO.</li> <li>• On selection of TRANSMIT the X axis (transverse axis) must not have the actual position ZERO. This also applies to block search.</li> </ul> <p>Set the real axes of the transformation to be selected to permissible actual positions prior to selecting transformation (on TRANSMIT the X axis to X 0)</p>	

<b>2192</b>	<b>Axis is not a rotary axis</b>	
Scan:	In each G195 block	
Effect:	<ul style="list-style-type: none"> <li>• NC START disabled</li> <li>• Cancellation of Mode Group Ready</li> </ul>	
Explanation:	<ul style="list-style-type: none"> <li>• Alarm is displayed with reference to block</li> <li>• The axis name following G195 does not define a rotary axis</li> </ul>	
Remedy:	Program axis name of rotary axis together with G195	
<b>225*</b>	<b>Spindle speed too high</b>	
Scan:	Only with NC MD 520* bit 2 set (encoder available)	
Effect:	<ul style="list-style-type: none"> <li>• Processing interruption</li> <li>• NC START disabled</li> <li>• Cancellation of Mode Group Ready</li> </ul>	
Explanation:	The actual spindle speed is higher than that set in machine data or setting data	
Remedy:	<ul style="list-style-type: none"> <li>• Program a smaller S value</li> <li>• NC MDs 403* to 410* (max. spindle speed for 1st to 8th gear stage)</li> <li>• NC MD 445* (tolerance band of max. spindle speed)</li> <li>• NC MD 451* (max. spindle speed)</li> <li>• Check PLC gear stage</li> <li>• Check G92 S... at "v=constant"</li> <li>• Check spindle speed limitation setting data</li> <li>• Program G26 S ...</li> </ul>	
<b>226*</b>	<b>Control loop spindle - Hardware</b>	
Scan:	Cyclic	
Effect:	<ul style="list-style-type: none"> <li>• Processing interruption</li> <li>• NC START disabled</li> <li>• Cancellation of Mode Group Ready</li> <li>• Servo enable of spindle is removed after the time in MD 477* has elapsed (waiting time for servo enable)</li> </ul>	
Explanation:	<p>The measuring circle differential signals</p> <ul style="list-style-type: none"> <li>• are not in phase</li> <li>• have a short-circuit to earth</li> <li>• are entirely missing</li> </ul>	
Remedy:	<ul style="list-style-type: none"> <li>• Check whether measuring circuit connector has been plugged</li> <li>• You can check by inserting the measuring circuit short-circuiting plug whether the measuring-circuit module is in operating order</li> <li>• Check the differential signals using an oscilloscope</li> <li>• Replace sensor</li> </ul>	



<b>227*</b>	<b>Spindle measuring system dirty</b>	
Scan:	Cyclic	
Effect:	<ul style="list-style-type: none"> <li>• Processing interruption</li> <li>• NC START disabled</li> <li>• Cancellation of Mode Group Ready</li> </ul>	
Explanation:	On measuring systems with a contamination signal, the measuring system has signalled a fault to the NC	
Remedy:	Check the measuring system	
<b>228*</b>	<b>M 19 option not available</b>	
Scan:	On processing in AUTOMATIC or MDA mode or when processing an external program is specified	
Effect:	Function is not executed	
Explanation:	M19 has been programmed, although this function is not implemented in the control	
Remedy:	<ul style="list-style-type: none"> <li>• Check part program or PLC user program</li> <li>• Check NC MD</li> <li>• Have option checked by Service and retrofit if necessary</li> </ul>	



<b>229*</b>	<b>Parameter assignment error</b>	
Scan:	<ul style="list-style-type: none"> <li>• During ramp-up</li> <li>• On warm restart</li> <li>• On MD changes</li> </ul>	
Effect:		
Explanation:		
Remedy:		
	<p>Errors are ascertained on checking the spindle machine data or the associated C axis</p> <p>Check the following machine data and correct if necessary:</p> <ul style="list-style-type: none"> <li>• MD 155</li> <li>• MDs 160 to 163</li> <li>• MD 168</li> <li>• MD 200*, MD 384*</li> <li>• MD 364*, MD 368*</li> <li>• MD 400*, MD 460*</li> <li>• MDs 403* to 410*</li> <li>• MDs 419* to 426*</li> <li>• MDs 478* to 485*</li> <li>• MD 435*</li> <li>• MD 455*, MD 456*</li> <li>• MD 458*</li> <li>• MD 459*</li> <li>• MD 461*</li> <li>• MD 463*</li> <li>• MD 466*</li> <li>• MD 468*</li> <li>• MD 1800*</li> </ul> <p>A service number is shown in the diagnostics display of the spindle concerned. You can see the meaning of the service number from the "Extended Spindle Functions" Function Manual.</p>	



<b>230*</b>	<b>Function cannot be executed</b>	
Scan:	<ul style="list-style-type: none"> <li>• On programming the M function for selecting or deselecting C axis operation</li> <li>• On programming the G function for selecting or deselecting synchronous operation</li> </ul>	
Effect:		
Explanation:		
Remedy:		
	<p>C axis operation or synchronous operation has been selected or deselected for a spindle which is defined on a 16 bit servo CPU</p> <ul style="list-style-type: none"> <li>• Check assignment of spindle and axis to the servo CPU (MD 400*, 200*, 461*)</li> <li>• Check the part program</li> </ul>	



<b>231*</b>	<b>Illegal NC command</b>	
Scan:	On selecting M19	
Effect:	<ul style="list-style-type: none"> <li>• Processing interruption</li> <li>• NC START disabled</li> <li>• Cancellation of Mode Group Ready</li> </ul>	
Explanation:	M19 has been requested for a spindle which is in C axis or synchronous operation	
Remedy:	<ul style="list-style-type: none"> <li>• Check the part program</li> <li>• Check the PLC program (M19 of PLC)</li> </ul>	
<b>2410</b>	<b>FA1 in controlled coupling</b>	
<b>2411</b>	<b>FA2 in controlled coupling</b>	
<b>2412</b>	<b>FA3 in controlled coupling</b>	
Scan:	Cyclic, when the electronic gear (ELG) is active or when the "Synchro-spindle" function has been selected	
Effect:	<ul style="list-style-type: none"> <li>• Processing interruption</li> <li>• NC START disabled</li> <li>• Cancellation of Mode Group Ready</li> <li>• Only the actual values of the LA/LS are used for determining the set-points of the FA/FS.</li> <li>• The coupling between LA/LS and FA/FS is maintained at first</li> </ul>	
Explanation:	An error of the LA/LS or other axes or spindles of the same mode group has occurred. The coupling is maintained as long as the FA/FS itself is not faulted. This is only guaranteed for a certain time which is specified in MD 956/976/996.	
Remedy:	Clear fault with the LA/LS or the concerned axis or spindle within the mode group. The coupled axes/spindles should be separated.	







<b>2413</b>	<b>FA1 Emergency retraction</b>	
<b>2414</b>	<b>FA2 Emergency retraction</b>	
<b>2415</b>	<b>FA3 Emergency retraction</b>	
Scan:	Cyclic, when the electronic gear (ELG) is active or when the "Synchro-spindle" function has been selected and emergency retraction monitoring has been enabled	
Effect:	<ul style="list-style-type: none"> <li>• Processing interruption</li> <li>• NC START disabled</li> <li>• Cancellation of Mode Group Ready</li> <li>• The emergency signal EMERGENCY RETRACTION ACTIVE is set</li> <li>• When using the mixed I/O module, a respective hardware signal is set</li> </ul>	
Explanation:	The synchronism between LA/LS and FA/FS is continuously monitored. If the deviation exceeds the emergency retraction threshold (MD 954/974/994), the alarm is activated if emergency retraction monitoring has been enabled (emergency signal or SD bit).	
Remedy:	<ul style="list-style-type: none"> <li>• Is emergency retraction enable (emergency signal or SD bit) desired?</li> <li>• Check drive of FA/FS and LA/LS</li> <li>• Check limiting values for speed and acceleration</li> <li>• Check emergency retraction threshold</li> <li>• Check the transmission ratios</li> </ul>	

<b>2416</b>	<b>FA1 Speed limitation</b>	
<b>2417</b>	<b>FA2 Speed limitation</b>	
<b>2418</b>	<b>FA3 Speed limitation</b>	
Scan:	Cyclic, when the electronic gear (ELG) is active or when the "Synchro-spindle" function has been selected	
Effect:	<ul style="list-style-type: none"> <li>• Processing interruption</li> <li>• NC START disabled</li> <li>• The speed of the FA/FS is limited to its maximum value</li> <li>• The setpoint determined by the balancing controller is ignored during limitation</li> </ul>	
Explanation:	The setpoint calculated for the FA/FS has exceeded the maximum speed of the FA/FS. Synchronism between LA/LS and FA/FS is at risk.	
Remedy:	<ul style="list-style-type: none"> <li>• Reduce the speed of the LA/LS</li> <li>• Check limiting values for the speed of the FA/FS</li> <li>• Check the transmission ratios</li> </ul>	

<b>2419</b>	<b>FA1 Acceleration limitation</b>	
<b>2420</b>	<b>FA2 Acceleration limitation</b>	
<b>2421</b>	<b>FA3 Acceleration limitation</b>	
Scan:	Cyclic, when the electronic gear (ELG) is active or when the "Synchro-spindle" function has been selected and the MD bit "Suppression of acceleration limitation " is not set	
Effect:	<ul style="list-style-type: none"> <li>• Processing interruption</li> <li>• NC START disabled</li> <li>• If the "Acceleration limitation synchronous" signal (emergency signal, SD bit) is set, traversing is continued at maximum acceleration. Set part positions suppressed during the movement are subsequently traversed to.</li> <li>• The setpoint speed determined by the balancing controller is ignored during limitation to maximum acceleration</li> </ul>	
Explanation:	The acceleration calculated for the FA/FS has exceeded the maximum acceleration of the FA/FS. Synchronism between LA/LS and FA/FS is at risk.	
Remedy:	<ul style="list-style-type: none"> <li>• Reduce the speed or the acceleration of the LA/LS</li> <li>• Check the limiting value for acceleration of the FA/FS</li> <li>• Check the transmission ratio</li> <li>• Suppress acceleration limitation if necessary (MD bit)</li> </ul>	

<b>2422</b>	<b>FA1 Configuration error</b>	
<b>2423</b>	<b>FA2 Configuration error</b>	
<b>2424</b>	<b>FA3 Configuration error</b>	
Scan:	<ul style="list-style-type: none"> <li>• During ramp-up</li> <li>• On warm restart</li> <li>• On MD changes</li> </ul>	
Effect:	<ul style="list-style-type: none"> <li>• NC START disabled</li> <li>• The incorrectly configured LA/LS is ignored</li> </ul>	
Explanation:	<p>The following checks are made:</p> <ul style="list-style-type: none"> <li>• Are the real LA/LS assigned to a measuring circuit?</li> <li>• Is the FA/FS assigned to a measuring circuit?</li> <li>• Is one axis/spindle defined as FA/FS more than once?</li> <li>• Has the FA/FS itself as LA/LS?</li> <li>• Is there any concatenation of LA/LS and FA/FS?</li> </ul>	
Remedy:	<ul style="list-style-type: none"> <li>• Check the measuring circuit assignment</li> <li>• Configure LA as a fictitious LA or assign the LA to a measuring circuit</li> <li>• Check the configuration of LA/LS and FA/FS</li> </ul>	

<b>2425</b>	<b>FA1 Suppression inhibited</b>	
<b>2426</b>	<b>FA2 Suppression inhibited</b>	
<b>2427</b>	<b>FA3 Suppression inhibited</b>	
Scan:	Cyclic, when the electronic gear (ELG) is active or when the "Synchro-spindle" function has been selected and a suppressing travel command for the FA/FS is given	
Effect:	<ul style="list-style-type: none"> <li>• Processing interruption</li> <li>• NC START disabled</li> <li>• The suppressing traversing movement of the FA/FS is not performed</li> <li>• The coupling is maintained</li> </ul>	
Explanation:	<p>A suppressing traversing movement of the FA/FS is only possible if suppression has been enabled (Emergency signal or SD bit). Suppression must also be enabled for the functions:</p> <ul style="list-style-type: none"> <li>• "In-process synchronisation" (ELG)</li> <li>• "Semi-automatic centering" (ELG)</li> <li>• "Defined angle offset" (synchro-spindle)</li> </ul>	
Remedy:	<ul style="list-style-type: none"> <li>• Set emergency signal or SD bit "FA/FS suppression On" or</li> <li>• Avoid suppression</li> </ul>	



<b>3000</b>	<b>General programming error</b>	
Scan:	On processing a part program or program block in AUTOMATIC or MDA mode	
Effect:	Processing interruption	
Explanation:	<ul style="list-style-type: none"> <li>• Alarm is displayed channel-specific and with reference to block</li> <li>• In one block of the program a general, not precisely definable, programming error has been made</li> <li>• Division by 0</li> <li>• A non-existent G function has been programmed</li> <li>• Non-existent R parameters have been programmed</li> <li>• No +, -, /, * has been programmed with R parameter chaining</li> <li>• Value range exceeded with T parameter calculation</li> <li>• Number of decades exceeded (M, S, T, D, H, L, P, F)</li> <li>• Number of subroutine passwords P not programmed directly behind L</li> <li>• Main block":." programmed in the subroutine</li> <li>• 2 decimal points programmed</li> <li>• Decimal point programmed with M, S, T, D, H, L, P</li> <li>• More than 8 decades programmed</li> </ul>	
Remedy:	<ul style="list-style-type: none"> <li>• Check the faulty block in "Correction block" display</li> <li>• If possible, the cursor is positioned in front of the word containing the error</li> <li>• The number of the block containing the error is displayed in the alarm line after the alarm no.</li> </ul>	



<b>3001</b>	<b>Geometry parameters &gt; 5</b>	
Scan:	On processing part programs	
Effect:	<ul style="list-style-type: none"> <li>• Processing interruption</li> </ul>	
Explanation:	<ul style="list-style-type: none"> <li>• Alarm is displayed channel-specific and with reference to block</li> <li>• More than 2 radii or 2 angles have been programmed in the block</li> <li>• More than 5 geometry parameters, such as axes, interpolation parameters, radii, angles ... have been programmed in the block</li> </ul>	
Remedy:	<ul style="list-style-type: none"> <li>• Check the faulty block in "Correction block" display</li> <li>• If possible, the cursor is positioned in front of the word containing the error</li> <li>• The number of the block containing the error is displayed in the alarm line after the alarm no.</li> </ul>	

<b>3002</b>	<b>Polar/radius error</b>	
Scan:	On processing part programs	
Effect:	Processing interruption	
Explanation:	<ul style="list-style-type: none"> <li>• Alarm is displayed channel-specific and with reference to block</li> <li>• In the block with polar/radius programming, no programming for: <ul style="list-style-type: none"> <li>– Angle</li> <li>– Radius</li> </ul> </li> <li>• Full circle <ul style="list-style-type: none"> <li>– Coordinates for the centre point not specified as absolute values</li> </ul> </li> </ul>	
Remedy:	<ul style="list-style-type: none"> <li>• Check the faulty block in "Correction block" display</li> <li>• If possible, the cursor is positioned in front of the word containing the error</li> <li>• The number of the block containing the error is displayed in the alarm line after the alarm no.</li> </ul>	



<b>3003</b>	<b>Invalid address</b>	
Scan:	On processing in AUTOMATIC or MDA mode	
Effect:	Processing interruption	
Explanation:	<ul style="list-style-type: none"> <li>• Alarm is displayed channel-specific and with reference to block</li> <li>• A different address has been programmed from that defined in NC MD or the plane assignment (cube) and the axis definition in the channel do not agree</li> </ul> <p>Example:</p> <p>Incorrect: N20 G0 C100 L<sub>F</sub> (rapid traverse 4th axis) In NC MD the 4th axis has been defined with adress Q</p> <p>Correct: N20 G0 Q100 L<sub>F</sub></p> <ul style="list-style-type: none"> <li>• The programmed axes are not defined in the selected mode group (with G200)</li> </ul>	
Remedy:	<ul style="list-style-type: none"> <li>• Check the faulty block in "Correction block" display</li> <li>• Check the channel-specific MD 548*</li> <li>• If possible, the cursor is positioned in front of the word containing the error</li> <li>• The number of the block containing the error is displayed in the alarm line after the alarm no.</li> </ul>	





<b>3004</b>	<b>CL800 error</b>	
<p>Scan:</p> <p>Effect:</p> <p>Explanation:</p>	<p>Cyclic</p> <p>Processing interruption</p> <p>Alarm is displayed channel-specific and with reference to block</p> <p>Formal errors</p> <ul style="list-style-type: none"> <li>• wrong characters entered (0...9, a...f are permitted)</li> <li>• @-number greater than 3 decades</li> <li>• @-number or @-function not implemented in 880</li> <li>• @-number or @-function not programmable or defined in CL800</li> </ul> <p>Input error with address letters and numerical values</p> <ul style="list-style-type: none"> <li>• Incorrect address letters (K, R, P are permitted)</li> <li>• Number of decades too high (max. K 8 decades permitted)</li> <li>• Number of decades too high (max. R 4 decades permitted)</li> <li>• Number of decades too high (max. P 4 decades permitted)</li> <li>• R parameter number not defined or too high</li> <li>• Point programmed in R parameter number</li> <li>• Point programmed in P parameter number</li> <li>• Incorrect number of words</li> </ul> <p>Input error with specific @-functions:</p> <p>Program branching</p> <ul style="list-style-type: none"> <li>• Error in the block number (programmed point, block number greater than 4 decades)</li> </ul> <p>Data transfer system cell - R parameter</p> <ul style="list-style-type: none"> <li>• Constant or R parameter contents programmed too large for information such as: axis number, channel number, TO area, NC/PLC machine data, NC setting data, D number, P number, group for zero offsets, default "COARSE/FINE" alarm number</li> <li>• Bit number too large (0 to 7 are permitted)</li> <li>• System cell non-existent</li> <li>• Incorrect value input for system cell</li> </ul> <p>Mathematical and logical functions</p> <ul style="list-style-type: none"> <li>• Value selected too high for square root (+ 00 000 001...99 999 999 permitted)</li> <li>• Incorrect angle selected for sine (-360(0) +360 permitted)</li> <li>• Two constants used for: Angle from two vector components, OR, EXOR, AND, NAND</li> <li>• Incorrect sign input for logical functions (0, 1 permitted) (only bits and bytes) (max. 8 bits)</li> </ul> <p>NC-specific functions</p> <ul style="list-style-type: none"> <li>• Incorrect address letter used for number of axes</li> <li>• Number of axes selected too high (max. three axes permitted per block)</li> <li>• No axis name programmed (0)</li> </ul>	



<b>3005</b>	<b>Contour definition error</b>	
<p>Scan:</p> <p>Effect:</p> <p>Explanation:</p> <p>Remedy:</p>	<p>On processing in AUTOMATIC mode</p> <ul style="list-style-type: none"> <li>• Processing interruption</li> <li>• Alarm is displayed channel-specific and with reference to block</li> <li>• The coordinates in blueprint programming have been defined so that no intersection point is given</li> <li>• Too many geometry values have been programmed</li> <li>• Check the faulty block in "Correction block" display</li> <li>• If possible, the cursor is positioned in front of the word containing the error</li> <li>• The number of the block containing the error is displayed in the alarm line after the alarm no.</li> </ul>	
<b>3006</b>	<b>Wrong block structure</b>	
<p>Scan:</p> <p>Effect:</p> <p>Explanation:</p> <p>Remedy:</p>	<p>On processing part programs in AUTOMATIC or MDA mode</p> <p>Processing interruption</p> <ul style="list-style-type: none"> <li>• Alarm is displayed channel-specific and with reference to block</li> <li>• Approach to reference point in the program and specification of wrong G function or more than 1 axis or an illegal axis</li> <li>• Incorrect thread lead parameters with G33</li> <li>• More than 3 M functions in the block</li> <li>• More than 1 S function in the block</li> <li>• More than 1 T function in the block</li> <li>• More than 1 H function in the block</li> <li>• More than 4 auxiliary functions in the block</li> <li>• More than 6 axes+geometry parameters</li> <li>• More than 5 axes with G00/G01/G02/G03/G200</li> <li>• More than 2 axes with G10/G11</li> <li>• More than 2 axes with G02/G03 (circular parameter programming)</li> <li>• G04 programmed with addresses other than X, F or S</li> <li>• Not only G04 programmed in the block</li> <li>• M19 S programmed with other functions</li> <li>• Incorrect circular parameters with G02/G03 axes</li> <li>• Axis missing with circle radius programming</li> <li>• G10/G11 block must be programmed in front of the 1st G110 block in the program</li> <li>• G110 must not be programmed with axes</li> <li>• Incorrect programming in conjunction with G176 freezing function</li> <li>• G200 programmed with other functions</li> <li>• A traversing movement has been programmed with G91 immediately after a block with G74 (Reference point approach in program ) or with G130/G230/G330 (Transformation) or with @720 (Measuring). Only G90 is permissible.</li> <li>• Check the faulty block in "Correction block" display</li> <li>• If possible, the cursor is positioned in front of the word containing the error</li> <li>• The number of the block containing the error is displayed in the alarm line after the alarm no.</li> </ul>	





<b>3007</b>	<b>Wrong setting data program</b>	
Scan:	On processing program blocks in AUTOMATIC or MDA mode	
Effect:	Processing interruption	
Explanation:	<ul style="list-style-type: none"> <li>• Alarm is displayed channel-specific and with reference to block</li> <li>• M19 without S word</li> <li>• Spindle not available</li> <li>• Illegal setting data, e.g. G25, G26, G92 X. . . Y. . . , G92 D. . . , T. . . , A. . . , I. . . or J. . .</li> </ul>	
Remedy:	<ul style="list-style-type: none"> <li>• Check the faulty block in "Correction block" display</li> <li>• If possible, the cursor is positioned in front of the word containing the error</li> <li>• The number of the block containing the error is displayed in the alarm line after the alarm no.</li> </ul>	
<b>3008</b>	<b>Subroutine error</b>	
Scan:	On processing programs in AUTOMATIC or MDA mode	
Effect:	Processing interruption	
Explanation:	<ul style="list-style-type: none"> <li>• Alarm is displayed channel-specific and with reference to block</li> <li>• M17 not in subroutine</li> <li>• M02/M30 in subroutine</li> <li>• M17 in subroutine</li> <li>• More than 3 subroutine levels</li> </ul>	
Remedy:	<ul style="list-style-type: none"> <li>• Check the faulty block in "Correction block" display</li> <li>• If possible, the cursor is positioned in front of the word containing the error</li> <li>• The number of the block containing the error is displayed in the alarm line after the alarm no.</li> </ul>	
<b>3009</b>	<b>Program disabled</b>	
Scan:	<ul style="list-style-type: none"> <li>• On NC START</li> <li>• When editing a program during processing</li> </ul>	
Effect:	Function is not executed	
Explanation:	<ul style="list-style-type: none"> <li>• Alarm is displayed channel-specific and with reference to block</li> <li>• A program is called with NC START which has been disabled by "Opening", "Copy" or "Rename". A program being edited may not be called with NC START.</li> <li>• If a program is to be edited while another program is being processed it must be disabled</li> </ul>	
Remedy:	On completion of editing the disabled program must be enabled	





<b>3010</b>	<b>Intersection error</b>	
<p>Scan:</p> <p>Effect:</p> <p>Explanation:</p> <p>Remedy:</p>	<p>On processing part programs in AUTOMATIC mode</p> <p>Processing interruption</p> <ul style="list-style-type: none"> <li>• Alarm is displayed channel-specific and with reference to block</li> <li>• An error has been ascertained during reference preparation in conjunction with calculation of the intersection point caused by: <ul style="list-style-type: none"> <li>– Contour program without G00, G01, G03</li> <li>– Contour program with "Clear buffer memory" (@ 714)</li> <li>– Programmed axes different from selected plane</li> <li>– No intersection found</li> <li>– Circular cutting path</li> <li>– R parameter number non-existent</li> </ul> </li> </ul> <p>Check program containing the contour</p>	
<b>3011</b>	<b>Axis twice/axis number &gt; 5</b>	
<p>Scan:</p> <p>Effect:</p> <p>Explanation:</p> <p>Remedy:</p>	<p>On processing part program blocks in AUTOMATIC or MDA mode</p> <p>Processing interruption</p> <ul style="list-style-type: none"> <li>• Alarm is displayed channel-specific and with reference to block</li> <li>• An axis has been programmed twice in the same block</li> <li>• More than five axes have been programmed</li> </ul> <ul style="list-style-type: none"> <li>• Check the faulty block in "Correction block" display</li> <li>• If possible, the cursor is positioned in front of the word containing the error</li> <li>• The number of the block containing the error is displayed in the alarm line after the alarm no.</li> </ul>	
<b>3012</b>	<b>Block not in memory</b>	
<p>Scan:</p> <p>Effect:</p> <p>Explanation:</p> <p>Remedy:</p>	<p>On block search or jumps in the part program</p> <p>Processing interruption</p> <ul style="list-style-type: none"> <li>• Alarm is displayed channel-specific and with reference to block</li> <li>• The block number has not been found in the program in a block search</li> <li>• In a jump in the program the programmed block number could not be found</li> <li>• The program has not been terminated with M30, M17</li> </ul> <ul style="list-style-type: none"> <li>• Check the part program for correct block number destination or correct program termination with M30/M02 or M17</li> </ul>	

<b>3013</b>	<b>Simulation data not enabled</b>	
Scan:	While simulation is active	
Effect:	Simulation is stopped	
Explanation:	Data have been accessed in the simulated part program that are disabled for simulation	
Remedy:	<ul style="list-style-type: none"> <li>• Check program</li> <li>• Use R900 to R999 with @ commands instead of R900 to R999</li> <li>• Check NC MD 5009 bit 4</li> </ul>	
<b>3014</b>	<b>Axis blocked (disabled) in channel</b>	
Scan:	On processing program blocks in AUTOMATIC or MDA mode or when processing external programs is specified	
Effect:	Processing interruption	
Explanation:	The programmed axis has been disabled for this channel via NC MD 576*	
Remedy:	<ul style="list-style-type: none"> <li>• Pay attention to the machine tool manufacturer's Programming Instructions</li> <li>• Correct machine data if necessary</li> </ul>	
<b>3015</b>	<b>Main block not in memory</b>	
Scan:	On automatic block search	
Effect:	Machining is not started	
Explanation:	<ul style="list-style-type: none"> <li>• Alarm is displayed alarm-specific and with reference to block</li> <li>• No main block is found in front of the target block during automatic block search</li> </ul>	
Remedy:	<ul style="list-style-type: none"> <li>• Check block found</li> <li>• Use different block search</li> </ul>	
<b>3016</b>	<b>External data input error</b>	
Scan:	On data input from PLC to NC	
Effect:	Processing interruption	
Explanation:	For external data input from PLC and NC <ul style="list-style-type: none"> <li>• The code is incorrect</li> <li>• The value is too large</li> <li>• The dimension identifier is invalid</li> </ul>	
Remedy:	<ul style="list-style-type: none"> <li>• Check PLC program</li> </ul>	

<b>3017</b>	<b>Part program number occurs twice</b>	
Scan:	On POWER ON	
Effect:	Processing interruption	
Explanation:	There is a part program present on the UMS submodule which is also present in the part program memory of the NC (with the same identifier)	
Remedy:	<ul style="list-style-type: none"> <li>• Delete the program in the part program memory or rename</li> <li>• Use a different UMS</li> </ul>	
<b>3018</b>	<b>Distance to contour too large</b>	
Scan:	On AUTO interruption in contour block and departure from interruption point	
Effect:	<ul style="list-style-type: none"> <li>• Processing interruption</li> <li>• Supplementary alarm 2048</li> </ul>	
Explanation:	<ul style="list-style-type: none"> <li>• Alarm is displayed channel-specific and with reference to block</li> <li>• This alarm is triggered when automatic operation is interrupted while a contour block is being executed and when the axes are positioned in an area, e. g. for tool change, that is outside the permissible tolerance for repositioning (scratch) (MD9). In order to avoid wrong positioning, the supplementary alarm 2048 (circle point error) is set.</li> <li>• Repositioning is only possible after Reset</li> </ul>	
Remedy:	<ul style="list-style-type: none"> <li>• Cancel alarms and activate block search to the interruption point</li> <li>• Check whether MD9 value can possibly be increased</li> </ul>	
<b>3019</b>	<b>Option RS 232 not available</b>	
Scan:	On selection of interface	
Effect:	Function is not executed	
Explanation:	<ul style="list-style-type: none"> <li>• Alarm is displayed with reference to block</li> <li>• The 2nd RS 232 C (V.24) interface has been started either from the PLC or with the softkey, but the option is not fitted</li> </ul>	
Remedy:	<ul style="list-style-type: none"> <li>• Transfer data via the 1st RS 232 C (V.24) interface</li> <li>• Have option checked by Service and retrofit if necessary</li> </ul>	





<b>3020</b>	<b>Option not available</b>	
Scan:	On specifying a function that has not been implemented	
Effect:	The function is not executed	
Explanation:	<ul style="list-style-type: none"> <li>• Alarm is displayed with reference to block</li> <li>• A function has been programmed or selected that is not implemented in the control</li> </ul>	
Remedy:	Have option checked by Service and retrofit if necessary	
<b>3021</b>	<b>CRC/TNRC contour error</b>	
Scan:	With CRC/TNRC selected NOT:     – in selection block – in deselection block	
Effect:	MD 5024.0=0:     Machining is not interrupted, alarm can be acknowledged MD 5024.0=1:     Machining is not interrupted. The operator can either stop machining (NC RESET) or acknowledge the alarm and then continue machining with NC START	
Explanation:	<ul style="list-style-type: none"> <li>• Alarm is displayed channel-specific and with reference to block</li> <li>• The compensation calculation results in a traversing movement which is opposite to the one programmed</li> <li>• No intersection is obtained with linear-circular or circular-circular transitions in the angle range &gt; 180°</li> </ul>	
Remedy:	Check programming and tool radius	
<b>3022</b>	<b>More than one spindle programmed</b>	
Scan:	On processing part programs in AUTOMATIC or MDA mode	
Effect:	The function is not executed	
Explanation:	Only one spindle can be programmed in one part program block	
Remedy:	Split spindle programming into two or more blocks	
<b>3023</b>	<b>Mode group without axes</b>	
Scan:	On NC START	
Effect:	None	
Explanation:	No axis has been defined in at least one mode group (mode groups without axes are not permissible)	
Remedy:	<ul style="list-style-type: none"> <li>• Modify NC MD 360*</li> <li>• Change hardware configuration</li> </ul>	



<b>3024</b>	<b>Display description not available</b>	
Scan:	On display selection	
Effect:	The display selected does not appear	
Explanation:	An attempt has been made with a programmed softkey to select a display that does not exist in the UMS or system memory	
Remedy:	Check the configured display number and the configured softkey function using the programming workstation	

<b>3025</b>	<b>Display description error</b>	
Scan:	On display selection	
Effect:	The display selected does not appear	
Explanation:	<ul style="list-style-type: none"> <li>• A display has been programmed with graphic elements although the control has no "Graphics" option</li> <li>• The display selected has too many variables or fields</li> <li>• A type of display has been programmed which the control does not recognize</li> </ul>	
Remedy:	<ul style="list-style-type: none"> <li>• Check the display using the programming workstation</li> <li>• Have option checked by Service and retrofit if necessary</li> </ul>	

<b>3026</b>	<b>Graphics/text too voluminous</b>	
Scan:	On display selection via softkey	
Effect:	The display contents is not displayed completely	
Explanation:	<ul style="list-style-type: none"> <li>• Configuring error in the display selected</li> <li>• Sum of graphics and text elements too large</li> </ul>	
Remedy:	<ul style="list-style-type: none"> <li>• Check the display using the programming workstation</li> <li>• Split the contents over two displays if necessary</li> </ul>	

<b>3027</b>	<b>Graphics command too voluminous</b>	
Scan:	On display selection via softkey	
Effect:	No graphics display	
Explanation:	Sum of the graphics commands in display selected too large	
Remedy:	<ul style="list-style-type: none"> <li>• Check the display using the programming workstation</li> <li>• Split the contents over two displays if necessary</li> </ul>	
<b>Caution:</b>	This alarm causes alarm 3026 to be triggered	



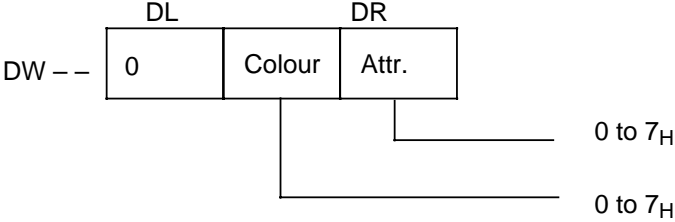

<b>3028</b>	<b>Too many fields/variables</b>	
Scan:	On display selection via softkey	
Effect:	The display selected does not appear	
Explanation:	Programming error in the display selected. The number of fields or variables is limited. A maximum number of fields/variables cannot be specified as the fields/variables may have differing formats and lengths	
Remedy:	<ul style="list-style-type: none"> <li>• Check the display using the programming workstation</li> <li>• Reduce the number of fields/variables</li> <li>• Split the contents over two displays if necessary</li> </ul>	
<b>3029</b>	<b>Graphics option not available</b>	
Scan:	On display selection via softkey	
Effect:	No graphics display	
Explanation:	A display has been programmed with graphic elements although the control has no "Graphics" option	
Remedy:	<ul style="list-style-type: none"> <li>• Program displays without graphic elements</li> <li>• Have option checked by Service and retrofit if necessary</li> </ul>	
<b>3030</b>	<b>Cursor memory not available</b>	
Scan:	On display selection via softkey	
Effect:	The display selected is treated as if no cursor were available	
Explanation:	The cursor memory programmed for the display selected is not correct (number not allowed or too large)	
Remedy:	Redefine the cursor memory using the programming workstation	
<b>Caution:</b>	The function of the cursor memory is to position the cursor where it was previously when the display is called again	
<b>3032</b>	<b>Too many fields/variables</b>	
Scan:	Cyclic	
Effect:	Not all variable values/texts are displayed	
Explanation:	The programmed variable display section of the display description is too voluminous	
Remedy:	<ul style="list-style-type: none"> <li>• Check the display using the programming workstation, reconfigure if necessary</li> <li>• Reduce variable display part</li> </ul>	





<b>3033</b>	<b>Display text not available</b>	
Scan: Effect: Explanation: Remedy:	Cyclic The display text does not appear The display text prepared at the programming workstation has not been transferred to the link list Check link list and re-link using the programming workstation. Watch out for linking errors.	
<b>3034</b>	<b>Text not available</b>	
Scan: Effect: Explanation: Remedy:	On display selection via softkey The special text is not displayed In the display selected the following texts were either linked incorrectly or not linked: <ul style="list-style-type: none"> <li>• Menu texts</li> <li>• Interactive dialog texts</li> <li>• Mode texts</li> <li>• Alarm texts</li> </ul> Check the display using the programming workstation and reconfigure if necessary	
<b>3035</b>	<b>Ind. addressing incorrect</b>	
Scan: Effect: Explanation: Remedy:	Cyclic Variable values/texts are not displayed <ul style="list-style-type: none"> <li>• The display description for indirect addressing is not correct. This refers to the specifications in the display heading for: <ul style="list-style-type: none"> <li>– Data group</li> <li>– Data type</li> <li>– Data number</li> <li>– Data block</li> </ul> </li> <li>• Specified number of indirect elements of list/display (EL) is not correct</li> <li>• Variable text (VT) selected, but status not deselected or offset not deselected</li> <li>• Variable value (VV) selected, but status not deselected</li> </ul> <ul style="list-style-type: none"> <li>• Check specifications for <ul style="list-style-type: none"> <li>– Range start pointer</li> <li>– Range length pointer</li> <li>– Cursor</li> </ul> and check their interrelationship</li> <li>• Check deselection of status or offsets</li> </ul>	

<b>3036</b>	<b>Variable status incorrect</b>	
<p>Scan:</p> <p>Effect:</p> <p>Explanation:</p> <p>Remedy:</p>	<p>Cyclic</p> <p>The status indicated in the display description is displayed</p> <ul style="list-style-type: none"> <li>An illegal status is read           <ul style="list-style-type: none"> <li>Illegal: Low Nibble (bits 0 to 3) &gt; 7<sub>H</sub></li> <li>High Nibble (bits 4 to 7) &gt; 7<sub>H</sub></li> </ul> </li> <li>An illegal display status is specified by the PLC</li> </ul> <p>The status specified by the PLC user program must be corrected</p> <div style="text-align: center;">  </div>	

<b>3040</b>	<b>Fields/variable not displayable</b>	
<p>Scan:</p> <p>Effect:</p> <p>Explanation:</p> <p>Remedy:</p>	<p>Cyclic</p> <p>Not all variable values/texts are displayed</p> <ul style="list-style-type: none"> <li>Field/variable incorrectly configured (data group not available)</li> <li>Field/variable configured with too few characters</li> <li>Field/variable overflow (value range exceeded)</li> <li>Format error, format cannot be changed</li> <li>Illegal pointer</li> <li>If the alarm occurs with standard displays, the value range has been exceeded</li> </ul> <p>Check field/variable using the programming workstation, delete and re-enter if necessary</p>	







<b>3041</b>	<b>Too many fields/variables</b>	
Scan:	Cyclic	
Effect:	Not all variable values/texts are displayed	
Explanation:	<ul style="list-style-type: none"> <li>• The display description has been made too voluminous, the internal buffer memory is not large enough to process the display</li> <li>• Too many variable values or texts have been programmed</li> <li>• A maximum number of fields/variables cannot be specified as the fields/variables have differing formats and lengths</li> </ul>	
Remedy:	The desired information must be reduced or split over several displays using the programming workstation	
<b>3042</b>	<b>Display description error</b>	
Scan:	On display selection via softkey	
Effect:	The display selected does not appear	
Explanation:	An error has been found in the display description which cannot be exactly defined, e. g. a non-existent field has been programmed (NC MD for 33rd axis with 880)	
Remedy:	Check the display using the programming workstation	
<b>3044</b>	<b>Graphics subroutine too large/missing</b>	
Scan:	Cyclic	
Effect:	No variable values/texts are displayed	
Explanation:	An error has occurred in the system program or graphics processor as regards the variable display design	
Remedy:	Replace system program	
<b>3045</b>	<b>Graphics subroutines used too large</b>	
Scan:	On display selection via softkey	
Effect:	No graphics display	
Explanation:	The total of the graphics subroutines used in the display is too high	
Remedy:	<ul style="list-style-type: none"> <li>• Simplify display description</li> <li>• Use arcs instead of polygon curves</li> </ul>	





<b>3046</b>	<b>Variable fault</b>	
Scan:	On display selection via softkey	
Effect:	Not all variable values/texts are displayed	
Explanation:	A variable text <b>without</b> end identifier has been programmed in display description caused by an error in the programming workstation software. A transfer format error is the result.	
Remedy:	Check programming workstation (error must be located at the interruption point of the following elements that are no longer displayed)	
<b>3050</b>	<b>Wrong input</b>	
Scan:	During the simulation function, when reading tool offsets	
Effect:	The function is not executed	
Explanation:	<ul style="list-style-type: none"> <li>• Number of tool probes too small/large</li> <li>• Tool type &gt; 39 or &lt; 0 (possible values: 0 to 39)</li> <li>• Empirical value number too large</li> <li>• Measuring parameter &gt; 2 or &lt; 0 (possible values: 0 to 2)</li> </ul>	
Remedy:	Check simulation data or tool offsets and correct values if necessary	
<b>3051</b>	<b>Programmed feed missing/wrong</b>	
Scan:	While simulation is active	
Effect:	Simulation is not stopped	
Explanation:	<ul style="list-style-type: none"> <li>• Alarm is displayed channel-specific and with reference to block</li> <li>• For graphic simulation a program is simulated which does not contain a feed value in front of the 1st traversing block</li> </ul>	
Remedy:	Correct program	
<b>3052</b>	<b>simulation error</b>	
Scan:	While simulation is active	
Effect:	Simulation is not stopped	
Explanation:	<ul style="list-style-type: none"> <li>• Alarm is displayed channel-specific and with reference to block</li> <li>• Internal simulation error</li> </ul>	
Remedy:	Have error removed by Service	



<b>3054</b>	<b>Warning simulation</b>	
Scan:	While simulation is active	
Effect:	None, simulation continues	
Explanation:	<ul style="list-style-type: none"> <li>• Alarm is displayed channel-specific and with reference to block</li> <li>• A function has been programmed that cannot be properly run in simulation <ul style="list-style-type: none"> <li>– Programmed plane G16 does not agree with a standard plane (G17/G18/G19)</li> <li>– Synchronisation has been lost with dual saddle simulation by means of G04</li> <li>– G06/G68/G74 cannot be simulated</li> <li>– Coupled motion cannot be simulated</li> <li>– Transformation cannot be simulated</li> </ul> </li> </ul>	
Remedy:	None	





<b>3058</b>	<b>VTE 340 cannot be aborted</b>	
Scan:	Each time terminal emulation is deselected	
Effect:	Terminal emulation cannot be terminated in this mode (return to NC operation not possible)	
Explanation:	<ul style="list-style-type: none"> <li>• The alarm is displayed with reference to block</li> <li>• Exit from emulation is not permitted while it is in setup mode , in graphics mode or in local edit mode</li> </ul>	
Remedy:	<ul style="list-style-type: none"> <li>• Exit from setup mode of the terminal emulator</li> <li>• Exit from graphics mode of the terminal emulator</li> <li>• Exit from local edit mode of the terminal emulator</li> </ul>	





<b>3059</b>	<b>Setup cannot be called</b>	
Scan:	Each time setup mode is selected	
Effect:	Setup mode cannot be selected within terminal emulation	
Explanation:	<ul style="list-style-type: none"> <li>• The alarm is displayed with reference to block</li> <li>• Setup mode must not be selected as long as the terminal emulation is in graphics mode</li> </ul>	
Remedy:	Exit from the graphics mode of the terminal emulation	

<b>3072</b>	<b>Message not available</b>	
Scan:	Cyclic	
Effect:	None	
Explanation:	<ul style="list-style-type: none"> <li>Alarms are provided in cycle preparation for which no text has been programmed</li> <li>NC alarms occur for which no text is provided in the system</li> <li>Study list of alarm displays and check for alarm numbers without text</li> </ul>	
Remedy:	<ul style="list-style-type: none"> <li>Program text for cycle alarms</li> <li>Send a message to the system management in the event of system alarms</li> </ul>	
<b>3081</b>	<b>CRC/TNRC not selected for approach</b>	
Scan:	On processing in AUTOMATIC or MDA mode	
Effect:	<ul style="list-style-type: none"> <li>NC START disabled</li> <li>The program is executed without approach element</li> </ul>	
Explanation:	<ul style="list-style-type: none"> <li>Alarm is displayed channel-specific and with reference to block</li> <li>CRC/TNRC (G41/G42) has not been selected in or in front of the approach block</li> <li>CRC/TNRC has not been deselected in or after the approach block</li> </ul>	
Remedy:	<ul style="list-style-type: none"> <li>Soft approach/retraction is only possible when CRC/TNRC has been selected since otherwise the programmed compensating movement cannot be precisely calculated</li> <li>Correct program (G41/G42)</li> <li>Program D0 with G41/G42 if necessary</li> </ul>	
<b>3084</b>	<b>Illegal working area limitation</b>	
Scan:	Cyclic	
Effect:	The control automatically enters the maximum value permitted by the traversing range in the working area limitation	
Explanation:	<ul style="list-style-type: none"> <li>Alarm is displayed with reference to block</li> <li>A value has been entered in the minimum or maximum axis-specific working area limitation that lies outside the permissible traversing range of the relevant axis</li> </ul>	
Remedy:	<ul style="list-style-type: none"> <li>Check input</li> <li>Check program (G25/G26, @...)</li> <li>Look up maximum traversing range in table (combination of axis-specific position control resolution and input resolution)</li> </ul>	





<b>3085</b>	<b>NC CPU time watch-dog</b>	
Scan:	Cyclic	
Effect:	None, brief irregular axis motions may occur	
Explanation:	<ul style="list-style-type: none"> <li>• Alarm is displayed with reference to block</li> <li>• Time overload in the NC CPU as a result of parallel program operation or due to selected functions such as <ul style="list-style-type: none"> <li>– Transformation (TRANSMIT, ...)</li> <li>– Coupled motion</li> </ul> </li> </ul>	
Remedy:	Stop program with NC STOP	
<b>3086</b>	<b>Illegal transformation selection</b>	
Scan:	On selection/deselection of transformation via the command channel from the PLC	
Effect:	NC START disabled	
Explanation:	The PLC has transferred an illegal value via the command channel. This is evaluated in the error byte in the PLC.	
Remedy:	Check PLC user program	
<b>3087</b>	<b>Error in transformation data</b>	
Scan:	<ul style="list-style-type: none"> <li>• On POWER ON</li> <li>• On warm restart</li> </ul>	
Effect:	The transformation data block selected is disabled	
Explanation:	<ul style="list-style-type: none"> <li>• Alarm is displayed with reference to block</li> <li>• An illegal value has been assigned to one NC MD in the transformation data block selected. The illegal NC MD number is entered in the block number of alarm 3087</li> </ul>	
Remedy:	Check NC MD for transformation data (block number of alarm 3087)	
<b>3089</b>	<b>KV factor for thread too small</b>	
Scan:	When thread is programmed	
Effect:	Calculation is terminated if the calculated $K_V$ factor exceeds the limit under consideration of the IPO time	
Explanation:	The input $K_V$ factor is too small	
Remedy:	Enter larger $K_V$ factor	



<b>3090</b>	<b>Following axis programmed</b>	
Scan: Effect: Explanation: Remedy:	Cyclic None Alarm 3090 is output if an axis which has been defined as a following axis is to be traversed in JOG mode on its own <ul style="list-style-type: none"> <li>• Other definition of the coupled axis grouping to prevent this axis from being a following axis</li> <li>• Deselect coupled motion function</li> </ul>	
<b>3091</b>	<b>Reduction at SW prelimit switch</b>	
Scan: Effect: Explanation: Remedy:	In AUTOMATIC or MDA mode when processing a part program block or when positioning the axes in JOG mode Reduce speed to the value set in the machine data The software prelimit switch has been overrun, the axis speed is decelerated to the reduced speed (MD 1) <ul style="list-style-type: none"> <li>• Check the traversing block</li> <li>• Check the value in NC MD 1100 (prelimit switch)</li> <li>• Position axis outside the prelimit switch range and cancel the alarm by acknowledging it</li> </ul>	
<b>3092</b>	<b>Programmed speed too high</b>	
Scan: Effect: Explanation: Remedy:	On processing programs in AUTOMATIC or MDA mode None <ul style="list-style-type: none"> <li>• Alarm is displayed with reference to block</li> <li>• The specified speed (either programmed or via override setting) is higher than the path speed resulting from the maximum axis speeds</li> </ul> <ul style="list-style-type: none"> <li>• Program slower path speed or check override</li> <li>• Check NC MD 280* (maximum speed)</li> <li>• Program lower spindle speed with G95</li> </ul>	





<b>3150</b>	<b>No reaction from PLC</b>	
Scan:	On function start via softkey	
Effect:	None	
Explanation:	Alarm 3150 appears after approx. 0.5 to 2 seconds if the PLC to be cancelled by overall reset is not fitted or if a selected PLC fails during the overall reset operation	
Remedy:	<ul style="list-style-type: none"> <li>• Overall reset of correct (existing) PLC</li> <li>• Replace PLC</li> </ul>	
<b>3151</b>	<b>Interface occupied by PG</b>	
Scan:	On function start via softkey	
Effect:	None	
Explanation:	Alarm 3150 appears if data are just being transferred between the programmer and one of the PLCs	
Remedy:	<ul style="list-style-type: none"> <li>• Abort programming function</li> <li>• Terminate programming function</li> </ul>	
<b>3152</b>	<b>Incorrect PLC mode</b>	
Scan:	On function start via softkey	
Effect:	None	
Explanation:	Wrong operation mode set at the PLC	
Remedy:	Set correct operating mode (cycle/stop)	
<b>3153</b>	<b>Funct. ident. unknown in PLC</b>	
Scan:	On function start via softkey	
Effect:	None	
Explanation:	The correct function identifier is unknown to the PLC	
Remedy:	Select correct function	
<b>3154</b>	<b>Error in PLC program memory</b>	
Scan:	On function start via softkey	
Effect:	None	
Explanation:	Error in the PLC program memory	
Remedy:	Report to Service	



<b>3155</b>	<b>PLC RAM not inserted</b>	
Scan:	On function start via softkey	
Effect:	None	
Explanation:	The PLC RAM is not inserted	
Remedy:	Insert PLC RAM	
<b>3156</b>	<b>Function disabled or active</b>	
Scan:	On function start via softkey	
Effect:	None	
Explanation:	The PLC function is disabled because another function is active	
Remedy:	Avoid simultaneous signal status display at the programmer	
<b>3157</b>	<b>Halt in thread</b>	
Scan:	On thread cutting	
Effect:	<ul style="list-style-type: none"> <li>• Processing interruption</li> <li>• NC START disabled</li> </ul>	
Explanation:	<ul style="list-style-type: none"> <li>• Alarm is displayed with reference to block</li> <li>• During thread cutting a halt has occurred in revolutional feed which has damaged the thread</li> </ul>	
Remedy:	Check axis-specific feed disable (DB 32)	
<b>3158</b>	<b>PLC not available</b>	
Scan:	On selection via softkey in a programmed display	
Effect:	None	
Explanation:	The programmed field refers to a non-existent PLC number specification	
Remedy:	Check assignments using the programming workstation and correct	











<b>3159</b>	<b>Data block not available</b>	
Scan:	On selection via softkey in a programmed display	
Effect:	None	
Explanation:	The programmed field refers to a non-existent data block	
Remedy:	Check assignment using the programming workstation and correct	
<b>3160</b>	<b>Tool simul. w/o dimensions</b>	
Scan:	While simulation is active	
Effect:	Simulation is stopped	
Explanation:	<ul style="list-style-type: none"> <li>• Alarm is displayed with reference to block</li> <li>• The programmed T number does not exist in the simulation tool data</li> </ul>	
Remedy:	Check the programmed T number in the simulation tool data and enter new values if necessary	
<b>3161</b>	<b>Tool form simulation not possible</b>	
Scan:	While simulation is active	
Effect:	The simulation is stopped	
Explanation:	An illegal tool form is defined in the simulation tool data under the programmed T number	
Remedy:	<ul style="list-style-type: none"> <li>• Define other tool form</li> <li>• Check program</li> </ul>	
<b>3162</b>	<b>Not all programs deleted</b>	
Scan:	On reading-in via the serial interface	
Effect:	None	
Explanation:	<ul style="list-style-type: none"> <li>• Alarm is displayed with reference to block</li> <li>• An entire program section is to be deleted with %CLF on reading-in via the serial interface. For this, a program number has been specified which is just being processed and thus cannot be deleted</li> </ul>	
Remedy:	Select "Clear program" with %CLF via the serial interface once again after the program concerned has been completed	







<b>3163</b>	<b>Softkey start not possible</b>	
Scan:	On starting a subroutine via softkey	
Effect:	The subroutine is not started	
Explanation:	The subroutine to be started in a defined channel cannot be started via softkey	
Remedy:	Check whether <ul style="list-style-type: none"> <li>• Channel is available</li> <li>• Subroutine with @00f in 1st block</li> <li>• Channel is already assigned (program running)</li> </ul>	
<b>3164</b>	<b>Axis converter error</b>	
Scan:	<ul style="list-style-type: none"> <li>• On processing in AUTOMATIC or MDA mode</li> <li>• On graphic simulation</li> </ul>	
Effect:	Processing interruption	
Explanation:	<ul style="list-style-type: none"> <li>• Alarm is displayed channel-specific and with reference to block</li> <li>• Incorrect input in the axis conversion list (SD)             <ul style="list-style-type: none"> <li>– Axis name not entered</li> <li>– Axis name does not exist</li> <li>– Axis fictitious (for transformation)</li> </ul> </li> </ul>	
Remedy:	Correct axis conversion list	
<b>3166</b>	<b>Program coordination wrong</b>	
Scan:	On processing in AUTOMATIC mode	
Effect:	Machining is stopped in the event of grave errors by the PLC (Read-in disable)	
Explanation:	<ul style="list-style-type: none"> <li>• Alarm is displayed channel-specific and with reference to block</li> <li>• The channel specified in the program coordination command WAIT or INIT does not exist</li> <li>• The channel specified in the program coordination command START does not exist or is disabled for processing</li> </ul>	
Remedy:	<ul style="list-style-type: none"> <li>• Check program coordination command in part program</li> <li>• Check all associated channels with a WAIT M command</li> </ul>	

<b>3167</b>	<b>Reassign T/H word</b>	
Scan:	Each time the T/H word is rearranged	
Effect:	<ul style="list-style-type: none"> <li>• Processing interruption</li> <li>• NC START disabled</li> </ul>	
Explanation:	<ul style="list-style-type: none"> <li>• The part program can be used to transfer T and H words from the NC channel in which they have been programmed (source channel) to another NC channel (target channel). Each reassignment must be acknowledged by the user in the target channel before the next reassignment is made</li> <li>• Possible errors: <ul style="list-style-type: none"> <li>– Target channel not enabled via machine data (signal from/to channel)</li> <li>– Reassignment in the target channel has not yet been acknowledged by the user</li> </ul> </li> </ul>	
Remedy:	<ul style="list-style-type: none"> <li>• Match part and user program</li> <li>• Enable target channel by machine data</li> </ul>	
<b>3168</b>	<b>Coord. not reproducible</b>	
Scan:	On processing in AUTOMATIC mode	
Effect:	None	
Explanation:	<ul style="list-style-type: none"> <li>• Alarm is displayed with reference to block</li> <li>• Programming error in T/H word reassignment</li> </ul>	
Remedy:	Match part and user program	
<b>3170</b>	<b>FA1 KUE wrong</b>	
<b>3171</b>	<b>FA2 KUE wrong</b>	
<b>3172</b>	<b>FA3 KUE wrong</b>	
Scan:	On calculating the transmission ratios for an ELG or a sychro-spindle pair	
Effect:	<ul style="list-style-type: none"> <li>• NC START disabled</li> <li>• Command "Activate Kü" disabled (emergency signal or SD bit)</li> <li>• The old transmission ratio is maintained</li> </ul>	
Explanation:	<p>An error has occurred in the calculation of the transmission ratio. Possible causes are:</p> <ul style="list-style-type: none"> <li>• Denominator= 0</li> <li>• Result too large (&gt; 1000)</li> <li>• Format overrun caused by unfavourable selection of increment</li> </ul>	
Remedy:	<ul style="list-style-type: none"> <li>• Check transmission parameters</li> <li>• Check increment weighting and axis-specific resolutions</li> </ul>	

<b>3173</b>	<b>FA1 Centering flank violated</b>	
<b>3174</b>	<b>FA2 Centering flank violated</b>	
<b>3175</b>	<b>FA3 Centering flank violated</b>	
Scan:	When the electronic gear (ELG) is active and when the emergency signal HAE IS ACTIVE is set	
Effect:	<ul style="list-style-type: none"> <li>• NC START disabled</li> <li>• A movement beyond the already recognized flanks is suppressed</li> </ul>	
Explanation:	<p>For semi-automatic centering, the two tooth flanks are approached manually. A movement beyond the already recognized flanks is suppressed to make centering easier for the operator.</p> <p>The alarm is also activated if the interface signals HAE ON and 1ST FLANK IS APPROACHED are set without the FA being traversed in between.</p>	
Remedy:	<ul style="list-style-type: none"> <li>• Withdraw FA from flank (opposite to approach direction)</li> <li>• Remove flank again if necessary (cancel interface signal 1ST FLANK IS APPROACHED)</li> <li>• Traverse at least one increment between the interface signals HAE ON and 1ST FLANK IS APPROACHED</li> </ul>	

<b>3176</b>	<b>FA1 Synch. parameter wrong</b>	
<b>3177</b>	<b>FA2 Synch. parameter wrong</b>	
<b>3178</b>	<b>FA3 Synch. parameter wrong</b>	
Scan:	On change of synchronisation parameters	
Effect:	<ul style="list-style-type: none"> <li>• NC START disabled</li> <li>• The last synchronisation parameters entered remain valid</li> </ul>	
Explanation:	<p>The synchronisation parameters have been incorrectly specified. The following checks are made:</p> <ul style="list-style-type: none"> <li>• Has a valid value been entered for the number of the LA? The position of the leading axis is ignored with LA number 0.</li> <li>• Are the values within the permissible no. range (limits <math>\pm 1070\ 000</math>)?</li> </ul>	
Remedy:	<ul style="list-style-type: none"> <li>• Enter permissible LA number (0, 1 to 5)</li> <li>• Enter permissible synchronisation positions</li> </ul>	

<b>3180</b>	<b>Illegal rapid stop</b>	
Cause:	Fast inputs in servo area I0.0 - I0.2 are not connected to 24 V	
Remedy:	See Manufacturer's Instruction Manual. The previous alarm must be acknowledged with RESET.	
<b>3181</b>	<b>No E value</b>	
Cause:	Mx22 programmed without E or H value	
Remedy:	Program E or H value. The previous alarm must be acknowledged with RESET.	
<b>3182</b>	<b>Parallel axis: too many axes</b>	
Cause:	Circular interpolation programmed with axes other than X and Y.	
Remedy:	Program circular interpolation with axes X and Y. The previous alarm must be acknowledged with RESET.	
<b>3183</b>	<b>Clamp protection: wrong ZO</b>	
Cause:	Internal eerror	
Remedy:	NC RESET and press NC start again.	
<b>3184</b>	<b>E increment too large</b>	
Cause:	E value too high	
Remedy:	Program lower E value. The previous alarm must be acknowledged with RESET.	
<b>3185</b>	<b>Wrong H value</b>	
Cause:	Programmed H value is greater than 65535	
Remedy:	Program lower H value. The previous alarm must be acknowledged with RESET.	





<b>3186</b>	<b>Too many nibble increments</b>	
Cause:	The selected E value is too low or the programmed path is too large	
Remedy:	Correct program The previous alarm must be acknowledged with RESET.	
<b>3187</b>	<b>Wrong nibble radius</b>	
Cause:	The programmed E value is greater than the programmed radius	
Remedy:	Program lower E value. The previous alarm must be acknowledged with RESET.	
<b>3188</b>	<b>Punching in clamp prot. area</b>	
Cause:	Punching in one position within clamp protection area	
Remedy:	Check programmed position or check the clamp positions and dimensions (R241 - R252). The previous alarm must be acknowledged with RESET.	
<b>3189</b>	<b>Target pos. in clamp area</b>	
Cause:	Positioning in clamp protection area	
Remedy:	Check programmed position or check the clamp positions and dimensions (R241 - R252). The previous alarm must be acknowledged with RESET.	
<b>3190</b>	<b>Clamp protection: wrong val</b>	
Cause:	Internal error	
Remedy:	NC RESET and then press NC start again	
<b>3191</b>	<b>Wrong tool station no.</b>	
Cause:	Number of tool stations for multiple tool = 0 or tool number from PLC = 0	
Remedy:	Check TOA memory input or PLC program. The previous alarm must be acknowledged with RESET.	

<b>3192</b>	<b>Reserved</b>	
Cause:		
Remedy:		





<b>3193</b>	<b>Reserved</b>	
Cause:		
Remedy:		



<b>3194</b>	<b>No text</b>	
Cause:	Preparatory M functions M*31 - M*36 and E value (laser voltage) programmed in the wrong order or impermissible G function of 7th G group programmed.	
Remedy:	Program E value <b>after</b> M*31 - M*36, e.g. M231 E5 T100 F8 or program G40, G42, G44, G45, G47 only. The previous alarm must be acknowledged with RESET.	

<b>3195</b>	<b>No text</b>	
Cause:	E1 = ... value greater than 10 V is programmed for the laser power control with variable voltage input or the ratio path length/voltage or time/voltage is too large	
Remedy:	Correct the program, permissible values 0.0 ... 10.0 V. The previous alarm must be acknowledged with RESET.	

<b>3200</b>	<b>Prog. coord. syntax wrong</b>	
Scan:	On processing in AUTOMATIC or MDA mode	
Effect:	Processing interruption	
Explanation:	<ul style="list-style-type: none"> <li>• Alarm is displayed channel-specific and with reference to block</li> <li>• Syntax error: invalid command mnemonic</li> <li>• Invalid modification parameter, impermissible characters, too many parameters, parameters or characters missing, range limit violation by parameter</li> </ul>	
Remedy:	Correct wrong command	
<b>3201</b>	<b>Prog. coord. too many parameters</b>	
Scan:	On processing in AUTOMATIC or MDA mode	
Effect:	Processing interruption	
Explanation:	<ul style="list-style-type: none"> <li>• Alarm is displayed channel-specific and with reference to block</li> <li>• More command parameters have been programmed than allowed in the command description</li> </ul>	
Remedy:	Correct wrong command	
<b>3202</b>	<b>Prog. coord. range limit violation</b>	
Scan:	On processing in AUTOMATIC or MDA mode	
Effect:	Processing interruption	
Explanation:	<ul style="list-style-type: none"> <li>• Alarm is displayed channel-specific and with reference to block</li> <li>• One of more range parameters violate the permissible values for the upper or lower limit</li> </ul>	
Remedy:	Correct wrong command	
<b>3203</b>	<b>Prog. coord. illegal character</b>	
Scan:	On processing in AUTOMATIC or MDA mode	
Effect:	Processing interruption	
Explanation:	<ul style="list-style-type: none"> <li>• Alarm is displayed channel-specific and with reference to block</li> <li>• Illegal characters occur in the coordination command</li> </ul>	
Remedy:	Correct wrong command	





<b>3204</b>	<b>Prog. coord. command incomplete</b>	
Scan:	On processing in AUTOMATIC or MDA mode	
Effect:	Processing interruption	
Explanation:	<ul style="list-style-type: none"> <li>• Alarm is displayed channel-specific and with reference to block</li> <li>• Parameter or right bracket missing in the programmed command</li> </ul>	
Remedy:	Correct wrong command	
<b>3205</b>	<b>Prog. coord. R parameter error</b>	
Scan:	On processing in AUTOMATIC or MDA mode	
Effect:	Processing interruption	
Explanation:	<ul style="list-style-type: none"> <li>• Alarm is displayed channel-specific and with reference to block</li> <li>• An error has occurred on activation of programmed R parameters</li> </ul>	
Remedy:	Correct wrong command	
<b>3206</b>	<b>Prog. coord. sym. para. not allowed</b>	
Scan:	On processing in AUTOMATIC or MDA mode	
Effect:	Processing interruption	
Explanation:	<ul style="list-style-type: none"> <li>• Alarm is displayed channel-specific and with reference to block</li> <li>• No symbolic parameters are permitted except R parameters</li> </ul>	
Remedy:	Correct wrong command	
<b>3220</b>	<b>Change G176 G175</b>	
Scan:	On processing in AUTOMATIC or MDA mode	
Effect:	The activated freezing function is aborted and a transition is made to the G function 175	
Explanation:	<ul style="list-style-type: none"> <li>• Alarm is displayed channel-specific and with reference to block</li> <li>• The zero offset group or the D number has been changed, an angle of rotation offset has been activated or G53 has been programmed while the freezing function for angle of rotation, zero offsets or length compensations were active. These functions cause the "Freezing" function to be terminated and the G175 function to be changed</li> </ul>	
Remedy:	Check program blocks and correct	

<b>3239</b>	<b>Cycle exceeded by SPF</b>	
<p>Scan:</p> <p>Effect:</p> <p>Explanation:</p> <p>Remedy:</p>	<p>On reading in subroutines via RS 232 C (V.24) or file transfer</p> <p>Eprom cycle is overwritten by subroutine</p> <p>A subroutine has been read in whose number already existed as Eprom cycle. The Eprom cycle is no more active.</p> <ul style="list-style-type: none"> <li>• The subroutine read in must be deleted if the Eprom cycle is to be maintained</li> <li>• If overwriting is to be prevented altogether, the setting data special bit 2, bit 3 of the relevant RS 232 C (V.24) interface or MD 5147, bit 3 in the case of file transfer must be set to 0</li> </ul>	
<b>3240</b>	<b>SPF not read in</b>	
<p>Scan:</p> <p>Effect:</p> <p>Explanation:</p> <p>Remedy:</p>	<p>On reading in subroutines via RS 232 C (V.24) or file transfer</p> <p>Subroutine has not been read in</p> <p>A subroutine to be read in already exists as Eprom cycle</p> <p>If the Eprom cycle is to be overwritten, the setting data special bit 2, bit 3 of the relevant RS 232 C (V.24) interface or MD 5147, bit 3 in the case of file transfer must be set to 1</p>	
<b>1000*</b>	<b>Connection assigned more than once</b>	
<p>Scan:</p> <p>Effect:</p> <p>Explanation:</p> <p>Remedy:</p>	<p>On POWER ON</p> <ul style="list-style-type: none"> <li>• Processing interruption</li> <li>• NC START disabled</li> <li>• Opening of NC Ready Relay</li> <li>• Servo enable is removed after the time in NC MD 156 has elapsed (servo enable relay drops out)</li> <li>• Follow-up mode</li> </ul> <p>A measuring circuit connection has been entered in NC MD 200* or 384* more than once</p> <ul style="list-style-type: none"> <li>• Check NC MD 200*</li> <li>• Check NC MD 384*</li> </ul>	

<b>1004*</b>	<b>Feedrate too high</b>	
Scan:	On each axis motion	
Effect:	<ul style="list-style-type: none"> <li>• Processing interruption</li> <li>• NC START disabled</li> <li>• Cancellation of Mode Group Ready</li> <li>• Servo enable removed</li> </ul>	
Explanation:	<ul style="list-style-type: none"> <li>• Excessive values have entered in MD 280* , i. e. the maximum value has been exceeded</li> <li>• The limiting frequency of the C axis encoder (MD 308*) has been exceeded with a spindle operated as rotary axis (C axis)</li> </ul>	
Remedy:	<ul style="list-style-type: none"> <li>• Check MD 280* and MD 155</li> <li>• Check MD 308*</li> <li>• Reduce feedrate or speed</li> </ul>	

<b>1008*</b>	<b>Speed controller limitation</b>	
Scan:	Cyclic	
Effect:	<ul style="list-style-type: none"> <li>• Processing interruption</li> <li>• NC START disabled</li> <li>• Cancellation of Mode Group Ready</li> <li>• Opening of NC Ready Relay</li> </ul>	
Explanation:	<ul style="list-style-type: none"> <li>• NC has switched to follow-up mode and disables rmp servo control and current control</li> <li>• The speed controller has been at its limitation for longer than the time set in IAR MD 52*</li> <li>• Error in parameter assignment to the ACC module</li> <li>• Load moments of inertia too high</li> <li>• SIMODRIVE fault</li> <li>• Rotor position encoder signals to the ACC module interrupted</li> </ul>	
Remedy:	<ul style="list-style-type: none"> <li>• Check parameter assignment to ACC module (IAR MD 136*; 140*; 144*; 148*)</li> <li>• Reduce load moments of inertia</li> <li>• Check SIMODRIVE</li> <li>• Check transmission of rotor position encoder signals to the ACC module</li> </ul>	

<b>1012*</b>	<b>Parameter assignment error</b>	
Scan:	<ul style="list-style-type: none"> <li>On warm restart</li> <li>After change of MD</li> </ul>	
Effect:	<ul style="list-style-type: none"> <li>Processing interruption</li> <li>NC START disabled</li> <li>Cancellation of Mode Group Ready</li> </ul>	
Explanation:	<ul style="list-style-type: none"> <li>NC switches to follow-up mode and disables rmp servo control and current control</li> <li>Parameter assignment error in NC or IAR machine data</li> </ul>	
Remedy:	<p>Check the following machine data for practical values:</p> <ul style="list-style-type: none"> <li>IAR MD 108*</li> <li>IAR MD 116*</li> <li>IAR MD 128*, 132*</li> <li>IAR MD 212*</li> <li>IAR MD 268*</li> <li>NC MD 160</li> <li>NC MD 264*, 268*</li> <li>NC MD 364*, 368*</li> <li>NC MD 1116*</li> </ul>	



<b>1024*</b>	<b>Illegal pulse multiplication</b>	
Scan:	<ul style="list-style-type: none"> <li>On POWER ON</li> <li>After change of MD</li> </ul>	
Effect:	<ul style="list-style-type: none"> <li>Processing interruption</li> <li>NC START disabled</li> <li>Cancellation of Mode Group Ready</li> <li>Opening of NC Ready Relay</li> <li>Servo enable is removed after the time in NC MD 156 has elapsed (servo enable relay drops out)</li> <li>Follow-up mode</li> </ul>	
Explanation:	A value other than 1, 2, 4, 8, 16, 32, 64 or 128 has been entered in NC MD 1116*	
Remedy:	Correct NC MD 1116*	



<b>1036*</b>	<b>Actuator not ready</b>	
Scan:	Cyclic	
Effect:	<ul style="list-style-type: none"> <li>Processing interruption</li> <li>NC START disabled</li> <li>Cancellation of Mode Group Ready</li> </ul>	
Explanation:	<ul style="list-style-type: none"> <li>NC switches to follow-up mode and disables rmp servo control and current control</li> <li>Actuator not ready</li> </ul>	
Remedy:	Check actuator (supply voltage)	

<b>1040*</b>	<b>Absolute encoder error</b>	
Scan:	On POWER ON	
Effect:	<ul style="list-style-type: none"> <li>• Processing interruption</li> <li>• NC START disabled</li> <li>• Cancellation of Mode Group Ready</li> <li>• Control does not start</li> </ul>	
Explanation:	An absolute encoder error is scanned with "Power On". The error cause appears in the service status display (see also Section "Absolute encoder errors").	
Remedy:	<ul style="list-style-type: none"> <li>• Check connection measuring circuit-absolute encoder</li> <li>• Remove cause of error</li> </ul>	
<b>Caution:</b>	The control must be restarted after the error has been remedied	

<b>1044*</b>	<b>Battery absolute submodule</b>	
Scan:	Approx. every 10 minutes	
Effect:	Risk of losing absolute position on "Power Off"	
Explanation:	The battery in the absolute submodule is empty	
Remedy:	Replace battery under power	
<b>Caution:</b>	<b>The control must not be switched off until the battery has been replaced</b>	

<b>1200*</b>	<b>Wrong division</b>	
Scan:	Cyclic	
Effect:	<ul style="list-style-type: none"> <li>• Processing interruption</li> <li>• NC START disabled</li> </ul>	
Explanation:	<p>The "Division increment from PLC" function is not possible:</p> <ul style="list-style-type: none"> <li>• NC MD 1104* (number of divisions) has invalid value</li> <li>• NC MD 1108* (division increment reference) has invalid value</li> <li>• NC MD 1112* (division increment offset) has invalid value</li> </ul>	
Remedy:	<ul style="list-style-type: none"> <li>• Graduated axis has been defined as a rotary axis (NC MD 560* bit 3=1) which is not allowed</li> <li>• Check NC MD 1104*, 1108*, 1112* and 560* bit 3</li> </ul>	

<b>1204*</b>	<b>Traversing range limit</b>	
Scan:	Cyclic (for linear axes only)	
Effect:	<ul style="list-style-type: none"> <li>• Processing interruption</li> <li>• NC START disabled</li> </ul>	
Explanation:	On principle, it is possible to exceed the maximum possible traversing range (defined by the combination of axis-specific position control resolution and input resolution) if no software limit switches and working area limitations are active (NC MD 560* bit 5=0). Considering , however that this would lead to traversing errors, the traversing range limit is monitored and alarm 1204* is set when the limit is exceeded	
Remedy:	Return to permissible traversing range in INC or JOG mode traversing in opposite direction	
<b>1208*</b>	<b>G200 Axis in more than one channel</b>	
Scan:	When an axis is to be synchronized with G200 in one channel	
Effect:	<ul style="list-style-type: none"> <li>• Processing interruption</li> <li>• NC START disabled</li> <li>• Cancellation of Mode Group Ready</li> </ul>	
Explanation:	One axis is active also in other channels with G200	
Remedy:	Write part programs such that no G200 is requested with active axes	
<b>1212*</b>	<b>Position behind software limit switch</b>	
Scan:	On processing in AUTOMATIC or MDA mode	
Effect:	<ul style="list-style-type: none"> <li>• Processing interruption</li> <li>• NC START disabled</li> <li>• Programmed path is <b>not</b> traversed</li> </ul>	
Explanation:	<ul style="list-style-type: none"> <li>• Alarm is displayed channel-specific and with reference to block</li> <li>• The programmed end point of the block is located behind the software limit switch</li> </ul>	
Remedy:	<ul style="list-style-type: none"> <li>• Correct program</li> <li>• Check MD 244*, 228*, 232*, 236*, dependent on the PLC interface signal 2ND SOFTWARE LIMIT SWITCH ACTIVE</li> </ul>	

<b>1216*</b>	<b>Position behind working area limitation</b>	
Scan: Effect: Explanation: Remedy:	On processing in AUTOMATIC mode <ul style="list-style-type: none"> <li>• Processing interruption</li> <li>• NC START disabled</li> <li>• Programmed path is <b>not</b> traversed</li> </ul> <ul style="list-style-type: none"> <li>• Alarm is displayed channel-specific and with reference to block</li> <li>• The programmed end point of the block is located <b>behind</b> the working area limit</li> </ul> <ul style="list-style-type: none"> <li>• Correct program</li> </ul>	
<b>10080*</b>	<b>"Speed controller limitation"</b>	
Effect: Explanation: Remedy:	The NC has changed over to follow-up operation and inhibits speed and current control. The speed controller has been at its limit for a longer period than set in IAR MD 152*. <ul style="list-style-type: none"> <li>• Error in parameterization of the ACC module (check IAR MD 136*, 140*, 144*, 148*)</li> <li>• Load moments of inertia too high</li> </ul> SIMODRIVE fault Rotor position encoder signals to the ACC module interrupted	
<b>10120*</b>	<b>"Parameterization error"</b>	
Effect: Explanation: Remedy:	The NC changes over to follow-up operation and inhibits speed and current control. Parameterization error in the NC or IAR machine data. Check if the following machine data contain reasonable values: <ul style="list-style-type: none"> <li>• IAR MD 108*</li> <li>• IAR MD 116*</li> <li>• IAR MD 128*, 132*</li> <li>• IAR MD 212*</li> <li>• IAR MD 268*</li> <li>• NC MD 160*</li> <li>• NC MD 264*, 268*</li> <li>• NC MD 364*, 368*</li> <li>• NC MD 1116*</li> </ul>	

# 13 Notes on Fault Procedure

## 13.1 General

The section below is intended to assist in locating and rectifying possible faults in the SINUMERIK 880.

The SINUMERIK 880 has a number of fault locating facilities:

- Alarm display on monitor  
(For full procedure see Description of alarms, Section 12 or alarm description issued by the machine manufacturer)
- Diagnosis, axis and spindle service data (see Section 10)
- PLC status  
(See Section 7 for use of PLC Status)
- EPROM CHECK
- Watchdog (red LED) on COM CPU
- Watchdog (red LED) on OP CPU
- Watchdog (red LED) on servo CPU
- Watchdog (red LED) on PLC CPU
- Green LED at NC power supply unit  
(5V test sockets at NC and operator panel power supply units)

Three states can be indicated by the watchdogs (red LEDs) on the individual CPU modules:

- LED off: CPU cycle operation
- LED on: CPU STOP
- LED flashing
  - + intermittently: POWER ON routines running (does not apply to PLC CPU)
  - + continuously: The EPROM check responded (does not apply to PLC CPU).

After replacing modules and software, the PLC must be switched to the Stop status until the installation routines have been completed in overall reset mode.



## 13.2 Faults in operator panel area

The watchdog (red LED) on the operator panel CPU indicates whether the CPU is engaged in proper cyclic operation.

If the red LED is off and the power supply connected but there is no display on the NC screen, perform the following procedure to determine whether the operator panel can be operated as a stand-alone unit.

### ***Procedure***

- Turn rotary switch on operator panel CPU to position "f"
- Perform POWER ON at the operator panel power supply unit or switch the system off and then on again
- A grid pattern appears on the screen which can also be used for contrast adjustment and focusing.  
If no display appears on the screen, one of the following faults has occurred:
  - Software + restarts for operator panel defective
  - Operator panel CPU defective
  - Memory module defective
  - Backpanel or interface module defective
- Turn rotary switch on operator panel CPU to position "0"
- Switch the system (also central controller) off and then on again

## 13.3 Table of faults

Status				Cause	Remedy
Alarm message on screen	LED on COM CPU	LED on OP CPU	4 LEDs on op. panel flash		
Yes, English	Unlit	Clocks 1 : 1	No	EPROM check in operator panel area cross check sum error	Order new system EPROM submodule
Yes, English	Unlit	Lit	No	EPROM check in operator panel area submodule incorrectly located	Insert submodule in correct location
No	Lit	Lit	Yes	Fault on MPC link after "POWER ON"	a) "POWER ON" b) Check opt.-fib. conductor c) Replace COM CPU d) Replace OP CPU
Yes/No	Unlit	Unlit	Yes	Fault on MPC link in active operation or COM CPU failure	a) "POWER ON" b) Check opt.-fib. conductor c) Check opt.-fib. conductor for permissible length d) Replace COM CPU e) Replace OP CPU
No, with display refresh	Unlit	Lit	No	OP CPU failure	a) Check bootstrapper b) Replace OP CPU
Yes	Unlit	Unlit	No	NC CPU failure	a) "POWER ON" b) Check bootstrapper c) Check NC MD d) Check jumperings on: - NC CPU - measuring circuits - memory module - bus PCB e) Replace NC CPU

Status				Cause	Remedy
Alarm message on screen	LED on COM CPU	LED on OP CPU	4 LEDs on op. panel flash		
No	Clocks 1 : 1	Lit	Yes	EPROM check on COM CPU	Check system modules
No	Unlit	Lit	Yes	Voltages in central controller not OK (LED on NC power supply unit not lit)	a) 230 V available? b) NC ON operative? c) Withdraw NC power supply unit and operate as a stand-alone unit d) Replace NC power supply unit
No	Lit	Unlit	No	Voltages in operator panel power supply unit not OK	a) 230 V available? b) NC ON operative? c) Replace op. panel power supply unit
No, no display	Unlit	Unlit	No	Data transfer to screen defective or system not switched on	System switched on? a) Check cable between video module and monitor b) Check monitor adapter (monochrome monitor) c) Check jumperings on video module d) Check brightness and contrast e) Replace video module f) Replace monitor
No, no display	Lit	Lit	Yes	<ul style="list-style-type: none"> <li>• Dual/Multiport RAM defective</li> <li>• MD card not slotted in or defective</li> </ul>	

## 13.4 Module exchange

After removing or exchanging modules you must perform the following actions.

### SINUMERIK 880

Module or location		6FX 11...	Clear/load NC/PLC MD	Soft-key user memory format	Soft-key clear part program memory	Complete installation	PLC general reset	PLC cold restart	Further comments
Multiport dual-tier	Version 4	368		X			X	X	X <sup>2)</sup>
	Version 5	368		X	X		X	X	X <sup>2)</sup>
	Version 6	368		X			X	X	X <sup>2)</sup>
1/2 Dualport single-tier	Version 1,2,3,7	240		X				X	X <sup>2)</sup>
Power supply central controller		GEW 1861-2A.							
Power supply operator panel		GEW 1861-3A.							
Exchange backup battery while	Control switched on	/							
	Control switched off	/	X	X	X	X	X	X	
COM - CPU		204			X				
Memory module for COM CPU		281							
Part program memory module		267			X				
128 k or 256 k RAM submodule of part program memory modules		206 353			X				
NC CPU		205		X					
Memory module for NC CPU		281							
Servo CPU		213							
Measuring circuit module		214							
PLC CPU		206							
UMS								X	X <sup>1)</sup>

Further remarks:

1. The UM submodule can only be exchanged in installation mode (rotary switch of COM CPU in position "1").
2. If an MD card is plugged into the multiport or dualport without the battery being soldered in (initial use since approx. 9/89) an NC/PLC MD clear and load must be performed.
3. Modules and submodules must only be removed or exchanged when not under a voltage. EEC protection regulations must be observed.

## 14 List of Abbreviations

Abbreviation	Meaning
BCD	Binary coded decimals
CLF	Clear file
CNC	Computerised Numerical Control
CPU	Central processing unit
CRC	Cutter radius compensation
DAC	Digital-to-analog converter
DIO	Data input/output
DRF	Differential resolver function
EIA code	Special paper tape code, number of holes per character always odd
EOB	Marks end of block for data in EIA code
EOR	Marks the program number (if EIA code is used)
EPROM	Program memory with permanently recorded program
HIFU	Auxiliary functions M, S, T, D, H, (F)
INC	Increment mode
ISO code	Special paper tape code, number of holes per character always even
K1 ... K8 (K16)	Channel (16 channels for SINUMERIK 880)
LED	Light emitting diode
LF	Marks end of block for data in ISO code
MD	Machine data
MDA	MDI-AUTOMATIC
MDI	Manual data input
MIB	Input buffer
MPF	Main program file
NC	Numerical control
PLC	Programmable controller
Pr. Halt	Display of a program interruption of the program run

<b>Abbreviation</b>	<b>Meaning</b>
RAM	Program memory which can be read and written
RPA	R parameter numbers with value assignment (R parameter active)
SD	Setting data
SEA	Addresses with value assignments (setting data active)
SPF	Subprogram file
TNRC	Tool nose radius compensation
TEA1	NC machine data (testing data active)
TEA2	PLC machine data (testing data active)
TOA	Tool offset active
UMS	User memory submodule
ZO	Zero offset
ZOA	Zero offset active

Siemens AG

AUT V250  
P. O Box 48 48  
W-8500 Nuremberg 1  
Federal Republic of Germany

**Suggestions**

**Corrections**

For Publication/Manual:  
SINUMERIK 880  
Software Version 1/2/3/4/5/6  
Installation Instructions -  
Installation Guide

**From:**

Name \_\_\_\_\_

Company/Dept. \_\_\_\_\_

Address: \_\_\_\_\_  
\_\_\_\_\_

Telephone: \_\_\_\_\_ / \_\_\_\_\_

Service Documentation

Order No.: 6ZB5 410-0CP02-0AA3

Edition: November 1991

Should you come across any printing errors when reading this publication, please notify us on this sheet. Suggestions for improvement are also welcome.

**Suggestions and/or corrections**

Siemens AG  
Automation Group  
Automation Systems  
for Machine Tools, Robots  
and Special-Purpose Machines  
P.O. Box 48 48, W-8500 Nuremberg 1  
Federal Republic of Germany

© Siemens AG 1989 All Rights Reserved  
Subject to change without prior notice

Siemens Aktiengesellschaft

Order No.: 6ZB5 410-0CP02-0AA3  
Printed in the Federal Republic of Germany  
251/222082 IA 05920.3

