



DELTA ELECTRONICS, INC.
www.delta.com.tw/industrialautomation

ASIA

Delta Electronics, Inc.
Taoyuan1
31-1, Xingbang Road, Guishan Industrial Zone,
Taoyuan County 33370, Taiwan, R.O.C.
TEL: 886-3-362-6301 / FAX: 886-3-362-7267

Delta Electronics (Jiang Su) Ltd.
Wujiang Plant3
1688 Jiangxing East Road,
Wujiang Economy Development Zone,
Wujiang City, Jiang Su Province,
People's Republic of China (Post code: 215200)
TEL: 86-512-6340-3008 / FAX: 86-769-6340-7290

Delta Electronics (Japan), Inc.
Tokyo Office
Delta Shibadaimon Building, 2-1-14 Shibadaimon,
Minato-Ku, Tokyo, 105-0012, Japan
TEL: 81-3-5733-1111 / FAX: 81-3-5733-1211

Delta Electronics (Korea), Inc.
Donghwa B/D 3F, 235-6, Nonhyun-dong,
Kangnam-gu, Seoul 135-010, Korea
TEL: 82-2-515-5303/5 / FAX: 82-2-515-5302

Delta Electronics (Singapore) Pte. Ltd.
8 Kaki Bukit Road 2, #04-18 Ruby Warehouse Complex,
Singapore 417841
TEL: 65-747-5155 / FAX: 65-744-9228

AMERICA

Delta Products Corporation (USA)
Raleigh Office
P.O. Box 12173, 5101 Davis Drive,
Research Triangle Park, NC 27709, U.S.A.
TEL: 1-919-767-3813 / FAX: 1-919-767-3939

EUROPE

Deltronics (The Netherlands) B.V.
Eindhoven Office
De Witbogt 15, 5652 AG Eindhoven, The Netherlands
TEL: 31-40-2592850 / FAX: 31-40-2592851

*We reserve the right to change the information in this manual without prior notice



DOP Series HMI User Manual



DOP Series HMI User Manual



www.delta.com.tw/industrialautomation

2006-05-30



5011632500-EH00

Table of Contents

Preface.....	i
Chapter 1 Introduction.....	1-1
1.1 DOP-A and DOP-AE Series Human Machine Interface.....	1-1
1.2 Features	1-1
1.3 Model number.....	1-3
1.4 Caution	1-4
Chapter 2 Creating and Editing Screens.....	2-1
2.1 ScrEdit (Screen Editor) Setup	2-1
2.2 How to Start ScrEdit	2-5
2.3 Menu Bar and Toolbar (File)	2-12
2.4 Menu Bar and Toolbar (Edit).....	2-29
2.5 Menu Bar and Toolbar (View)	2-49
2.6 Menu Bar and Toolbar (Element).....	2-63
2.7 Menu Bar and Toolbar (Screen).....	2-79
2.8 Menu Bar and Toolbar (Tools)	2-100
2.9 Menu Bar and Toolbar (Options).....	2-115
2.10 Menu Bar and Toolbar (Window)	2-154
2.11 Menu Bar and Toolbar (Help).....	2-164
Chapter 3 Element Function	3-1
3.1 How to Choose Element.....	3-1
3.2 Button Element.....	3-4
3.3 Meter Element	3-21
3.4 Bar Element.....	3-23

3.5	Pipe Element	3-27
3.6	Pie Element	3-30
3.7	Indicator	3-32
3.8	Data Display	3-35
3.9	Graph Display	3-41
3.10	Input Element	3-48
3.11	Curve Element	3-54
3.12	Sampling Element	3-59
3.13	Alarm Element	3-68
3.14	Graphic Element	3-73
3.15	Keypad Element	3-81
Chapter 4	Macro Function	4-1
4.1	Macro Type	4-2
4.2	Macro Editing	4-4
4.3	Macro Operation	4-9
4.4	Error Messages	4-37
Chapter 5	Control Block and Status Block	5-1
5.1	Control Block	5-2
5.2	Status Block	5-7
Chapter 6	Internal Memory	6-1
Appendix A	Specifications and Installation	A-1
A.1	Specifications	A-1
A.2	Dimensions	A-3
A.3	Profile	A-5
A.4	Cut Dimension	A-7

Table of Contents | ScrEdit Software User Manual

A.5 Installation	A-9
Appendix B Communication	B-1
B.1 Pin Definition of Serial Communication	B-1
B.2 Cable for Download	B-2
B.3 Communication Settings and Connections between HMI and Connectable Controllers	B-3

About this Manual...

User Information

Be sure to store this manual in a safe place.

Due to constantly growing product range, technical improvement and alteration or changed texts, figures and diagrams, we reserve the right of this manual contained information change without prior notice.

Coping or reproducing any part of this manual, without written consent of Delta Electronics Inc. is prohibited.

Technical Support and Service

Welcome to contact us or visit our web site (<http://www.delta.com.tw/industrialautomation/>) if you need any technical support, service and information, or, if you have any question in using the product. We are looking forward to serve you needs and willing to offer our best support and service to you. Reach us by the following ways.

ASIA

DELTA ELECTRONICS, INC.

TAOYUAN Plant/

31-1, SHIEN PAN ROAD, KUEI SAN
INDUSTRIAL ZONE TAOYUAN 333, TAIWAN

TEL: 886-3-362-6301

FAX: 886-3-362-7267

JAPAN

DELTA ELECTRONICS (JAPAN) INC.

Sales Office/

DELTA SHIBADAIMON BLDG.

2-1-14 SHIBADAIMON, MINATO-KU,

TOKYO, 105-0012, JAPAN

TEL: 81-3-5733-1111

FAX: 81-3-5733-1211

NORTH/SOUTH AMERICA

DELTA PRODUCTS CORPORATION

Sales Office/

P.O. BOX 12173

5101 DAVIS DRIVE,

RESEARCH TRIANGLE PARK, NC 27709, U.S.A.

TEL: 1-919-767-3813

FAX: 1-919-767-3969

EUROPE

DELTRONICS (NETHERLANDS) B.V.

Sales Office/

DE WITBOGT 15, 5652 AG EINDHOVEN,

THE NETHERLANDS

TEL: 31-40-259-2860

FAX: 31-40-259-2851

Thank you very much for purchasing DELTA's DOP-A Series and DOP-AE Series Human Machine Interface (hereinafter "HMI") products.

This manual will be helpful in the installation, wiring, and operation of Delta HMI product and HMI Screen Editor software program (hereinafter "ScrEdit"). Before using the product, please read this user manual to ensure correct use.

You should thoroughly understand all safety precautions (DANGERS, WARNINGS and STOPS) before proceeding with the installation, wiring and operation. If you do not understand please contact your local Delta sales representative. Place this user manual in a safe location for future reference.

Using This Manual

■ Contents of this manual

- This manual is a user guide that provides the information on how to install and operate Delta HMI products and ScrEdit.

■ Who should use this manual

This user manual is intended for the following users:

- Those who are responsible for designing.
- Those who are responsible for installing or wiring.
- Those who are responsible for operating or programming.

■ Important precautions

Before using the product, please read this user manual thoroughly to ensure correct use and store this manual in a safe and handy place for quick reference whenever necessary. Besides, please observe the following precautions:

- Install the product in a clean and dry location free from corrosive and inflammable gases or liquids.
- Ensure that HMI is correctly connected to a ground. The grounding method must comply with the electrical standard of the country.
- Do not modify or remove wiring when power is applied to HMI.
- Before starting the operation, make sure the emergency stop equipment can be energized and work at any time.
- Do not touch the power supply during operation. Otherwise, it may cause electric shock.

This page intentionally left blank.

Chapter 1 Introduction

1.1 DOP-A and DOP-AE Series Human Machine Interface

DOP-A and DOP-AE series HMI are manufactured by adopting high-speed hardware to provide you a powerful and programmable interface. ScrEdit software is a really user-friendly program editor of DOP-A and DOP-AE series HMI for Windows. Please refer to the following section for its features and function introduction. If there is any suggestion or comments on ScrEdit software, please do not hesitate to contact us. We are looking forward to serve your needs and willing to offer our best support and service to you.

1.2 Features

■ PLC serial drives support

DOP-A series HMIs support more than twenty brands of PLC, including Delta, Omron, Siemens, Mitsubishi, etc. All of the newly supported PLCs' communication protocol could be found on our website (<http://www.delta.com.tw/industrialautomation/>) for upgrade to meet your requirements. (All other trademarks in this manual are property of their respective companies.)

■ Windows® Fonts support for ScrEdit software

Except Simplified Chinese, traditional Chinese and English these three languages, ScrEdit software also provides those fonts that Windows® uses.

■ Quick execution and communication macro

It can handle complicated calculation by executing macro. Users can also write communication protocol with communication macro command to connect specific system via COM port.

■ Rapid USB upload/download

It will shorten upload/download time by using USB Ver1.1.

■ Recipes

It provides useful recipe editor that is similar to Microsoft excel for user to edit recipe easily and input multiple recipes simultaneously (size limit is 64K). When downloading multiple recipes at the same time, it can exchange by internal memory of HMI. If data has finished editing when downloading, you can download recipe individually.

■ Support multiple PLCs connections

Connect to multiple controllers in serial through COM2 of RS485 port.



1) The controller should provide RS485 interface.

■ **On-line Simulation**

HMI on-line simulation feature allows users to develop and debug software on the PC connected to DOP series HMI before downloading it to DOP series HMI.

■ **Off-line Simulation**

HMI off-line simulation feature allows users to develop and debug software on the PC alone before downloading it to DOP series HMI.

■ **Using SMC card to backup data**

SMC card can also be used to backup data or transfer data to another HMI. After data transmission, the data can be saved into the FLASH memory of HMI. History list and alarm message can be also saved in SMC card and users can read these files by card reader for collecting data and printing.

■ **Multiple security protection**

It provides passwords to protect designer's intellectual property rights and also for users to set users priority for important component. Only the users, whose priority is higher than the component, can use the component.

■ **USB host port (USB Host) equipped (DOP-AE series only)**

DOP-AE series HMI have a built-in USB Host interface for the connection to USB disk, card reader and printer with USB socket. The users can save data, copy program and print the screen immediately and increase the data storage space.

■ **Multiple security protection**

It provides passwords to protect designer's intellectual property rights and also for user to set user priority for important component.

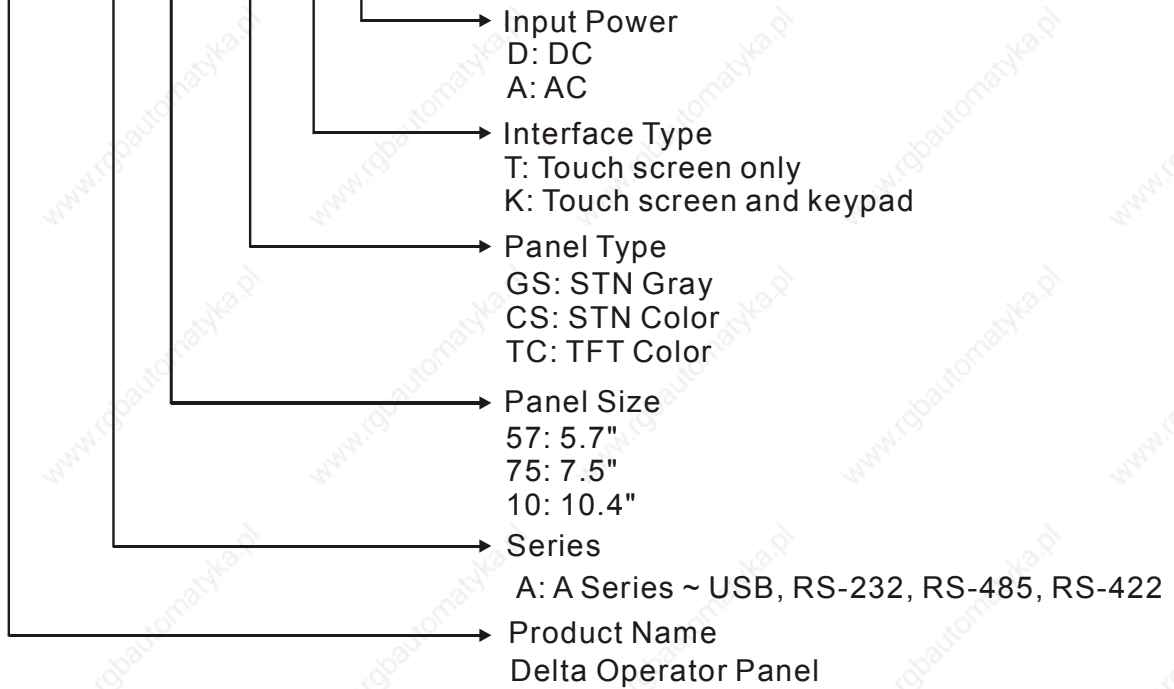
■ **Multi-language support**

Eight available languages can be selected and used without installing a multilingual operating system. It is easy for the users to switch the desired language via HMI or the external controller. Furthermore, Unicode editing is supported, and therefore it is convenient for the user to create and edit more quickly.

1.3 Model number

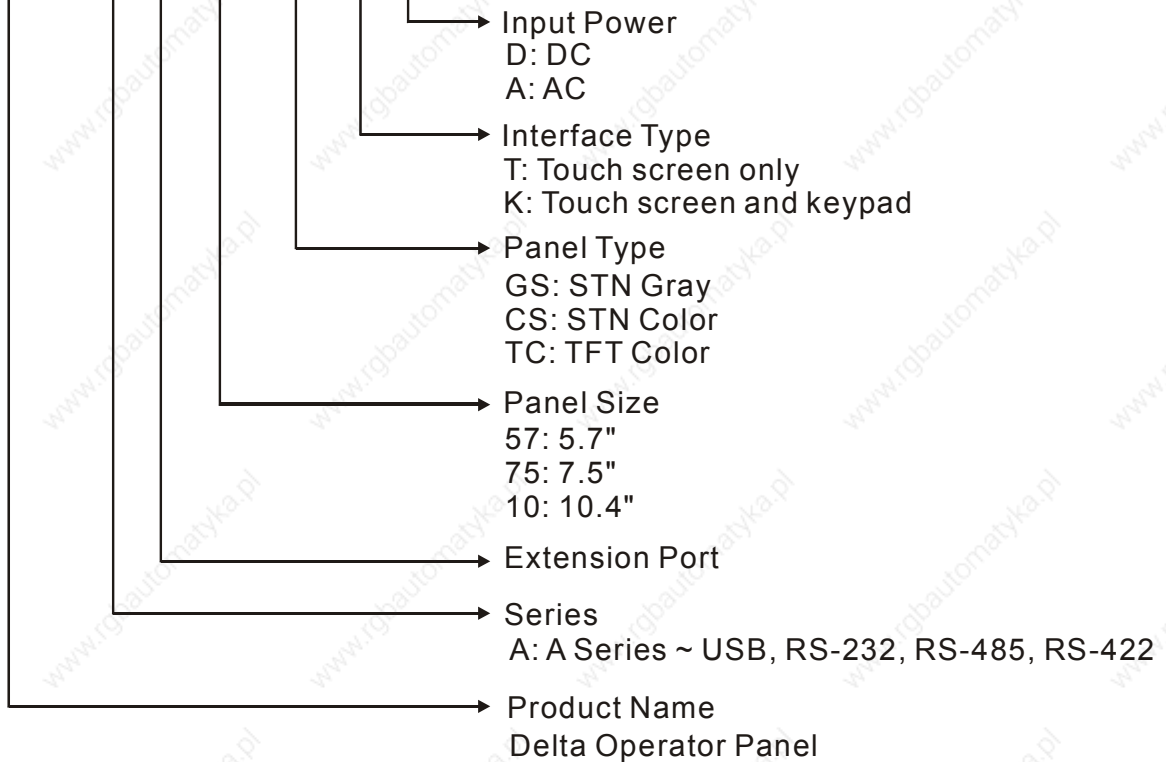
DOP-A Series

DOP - A 57 GS T D



DOP-AE Series

DOP - A E 57 GS T D



1.4 Caution

■ Operation Environment (temperature and humidity)

HMI should be operated in the following environment parameters to adjust screen brightness and contrast for getting the best image. If operating out of the range, LCD may be improperly displayed when using for long time.

Ambient Operating Temperature: 0 °C to 50 °C (32 °F to 122 °F)

Relative Humidity: 10% ~ 90%, no condensation allowed

■ SMC Card

SMC card can be used to save and transmit data. Only SMC card that formatted by HMI can be used on both HMI and Windows® OS system. (Even it can be read/written in some format, but faults may occur due to different format among Win95/98/2000/XP versions)

■ DO NOT plug/unplug the cable from COM port during operation

Please turn the power off before you plug or unplug the COM ports cable.

■ Recommend System Requirements

- Pentium III, 500MHz or greater
- 256MB RAM
- Windows® 2000 & Windows® XP

Chapter 2 Creating and Editing Screens

2.1 ScrEdit (Screen Editor) Setup

In this chapter, it will introduce general functions of Screen Editor with Windows. User can use it to design what he wants. Detail information for each function will be discussed in following chapters.

■ Minimum System Requirement

What follows is the system requirement to comply with the operation environment of ScrEdit:

Item	System Requirement
Operation System	Windows® 2000 & Windows® XP
CPU	Pentium III, 500MHz or greater is recommended
Memory	256MB and above is recommended
Hard Disk	Capacity: 100MB and above
Monitor	Resolution: 800×600. It is recommended to set display setting of Windows to 256 colors or above.
Mouse	General mouse or the device compatible with Windows
Printer	Printer with Windows driver

■ Software installation

To start the Delta HMI ScrEdit setup, please refer to the following steps:

1. Step 1: Please start-up your computer to Win2000/WinXP system. (Fig. 2.1.1)



Fig. 2.1.1 Open Microsoft Windows

2. Step 2: Execute **setup.exe** from Windows taskbar by clicking “**Start**” > “**Run**”. (Fig. 2.1.2)

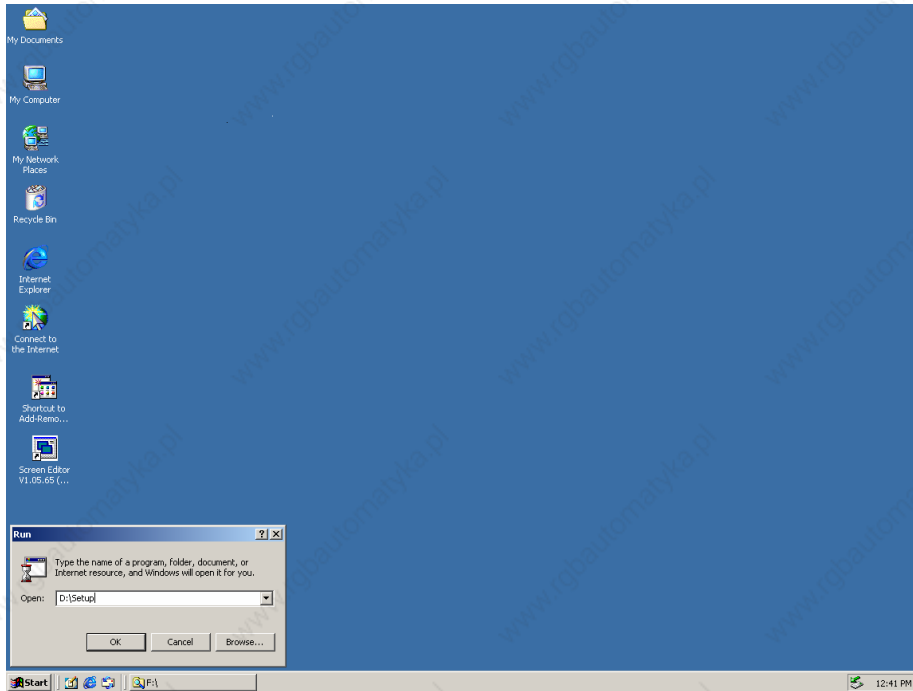


Fig. 2.1.2 Execute setup.exe under Windows system

3. Step 3: After pressing **OK**, system will setup automatically and you will get the following dialog box to choose destination location.

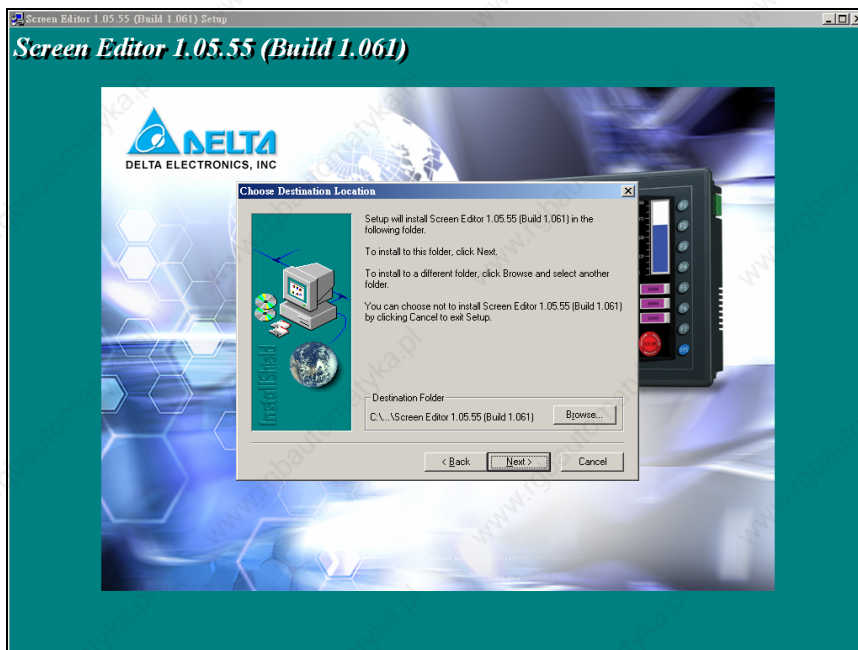


Fig. 2.1.3 Directory for installing ScrEdit

To select the default directory **C: \Program File\Delta\Screen Editor 1.05.55 (Build 1.061)**, click **Next>** for the next step. Setup will install in the directory indicated in the Destination Directory box at the bottom of the dialog box.

To select a directory other than the default directory, click **Browse**. A list of available directories appears. Highlight the desired directory for the Delta HMI ScrEdit and click **OK**, then **Next>** for the next step.

If necessary, click < **Back** button to take you back through Setup dialog boxes one by one.

- Step 4: In this dialog box, you can choose setup language: Traditional Chinese, Simplified Chinese or English. And then click **Next>** button to get following program folder selection dialog box.

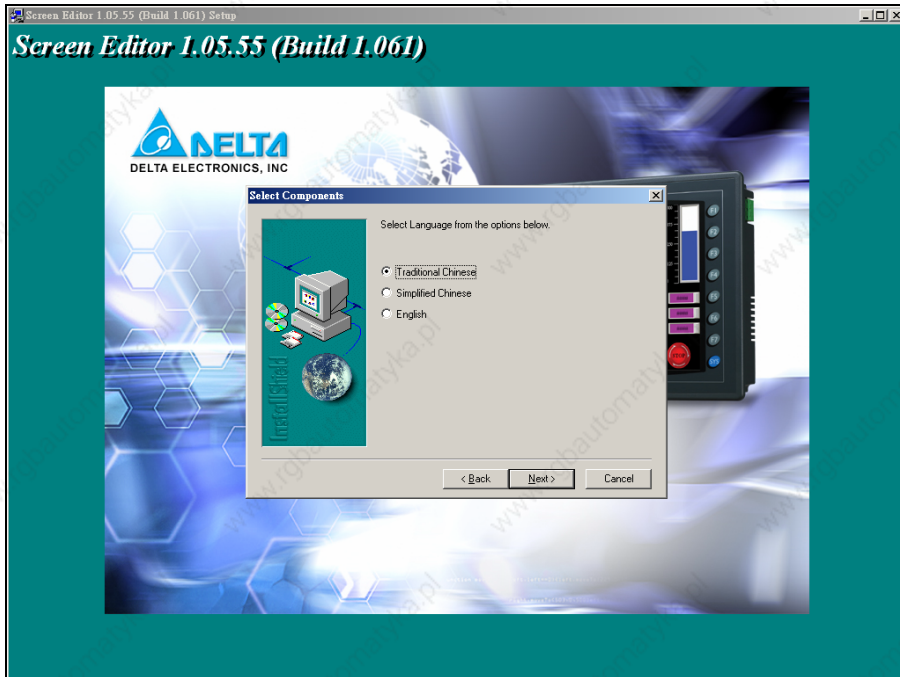


Fig. 2.1.4 Language installation

- Step 5: This dialog box displays the progress of copying files while the Setup program copies all necessary files into the designated directory. (Fig. 2.1.5, Fig. 2.1.6)



Fig. 2.1.5 Starting ScrEdit installation

6. Step 6: At this time, you have finished setup. Please click **Finish** to complete setup. (Fig. 2.1.7)

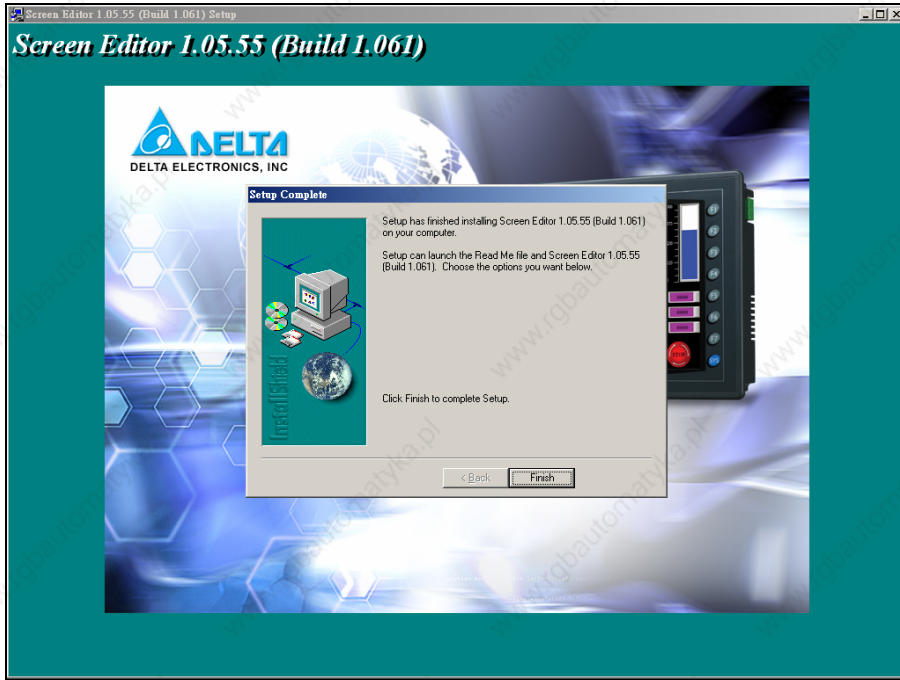


Fig. 2.1.6 Finish installing ScrEdit

7. Step 7: Click **OK** to allow Setup to restart your computer and finish setup. Otherwise, choose “No, I will restart my computer later.” option and click OK. You will have to restart your computer before you can use the Delta HMI ScrEdit.

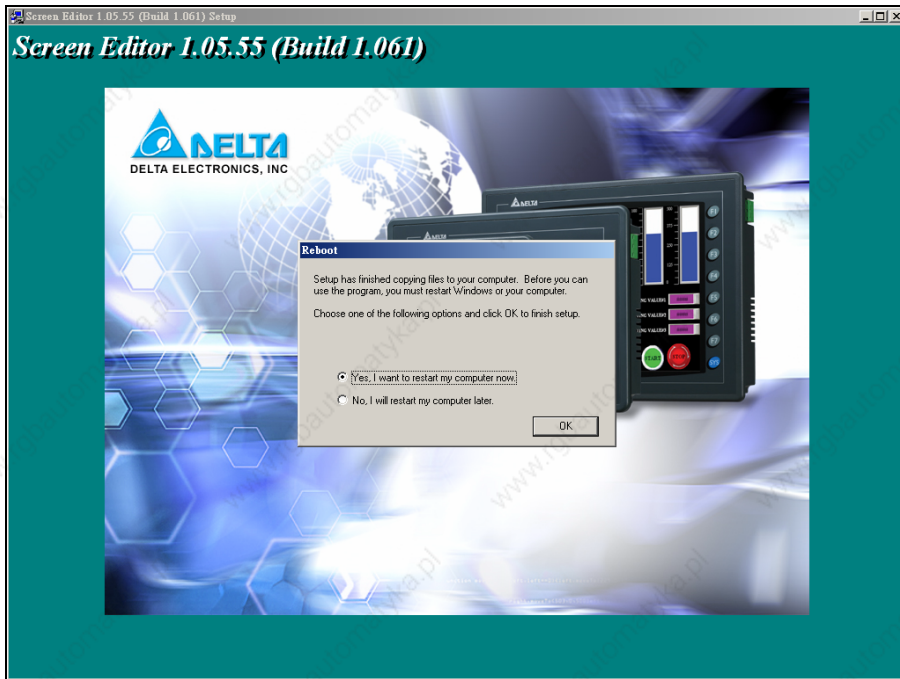


Fig. 2.1.7 Completing installation

2.2 How to Start ScrEdit

After setup, you can start ScrEdit from Windows taskbar, click **Start > Programs > Delta HMI > Screen Editor**. (Refer to Fig. 2.2.1)

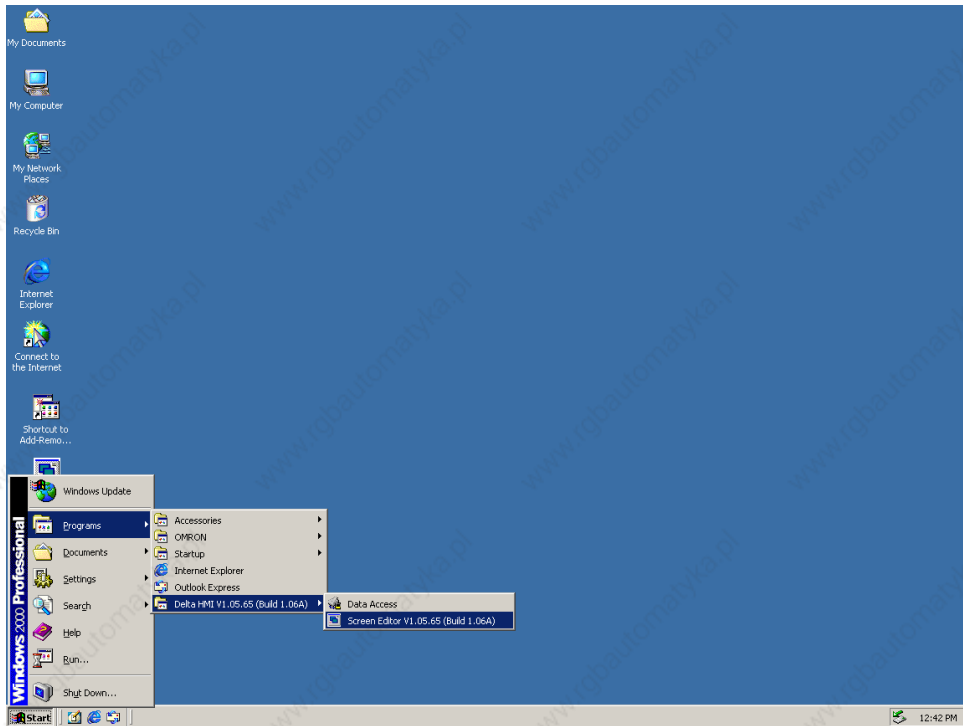


Fig. 2.2.1



Fig. 2.2.2 Start-up display

When you start ScrEdit at the first time, the ScrEdit will install USB drive program automatically. Therefore, the speed will be slower when initial setup. It is normal and please be patient and wait just a moment.

1. It will open last file automatically if you check “auto open last file automatically” in environment setting.
2. If you didn't check “auto open last file automatically” in environment setting or you didn't save last file, it will show basic function as Fig. 2.2.3.
3. There are only File (F), View(V), Option(O) and Help(H) on the toolbar when executing ScrEdit without editing new file.

When ScrEdit is activated at the first time, the first window to show up is as follows.

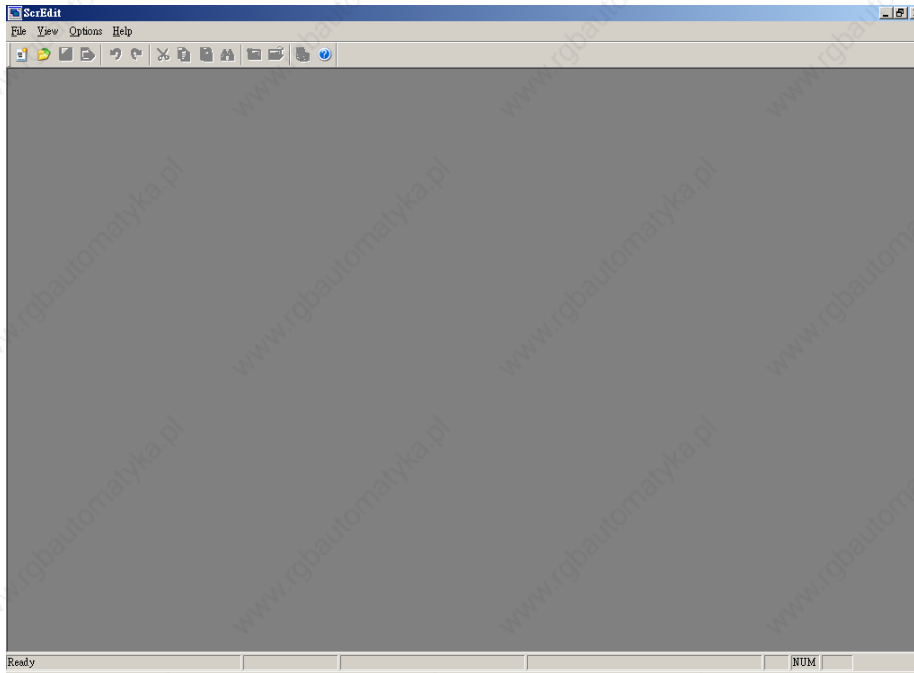



Fig. 2.2.3 Screen without editing file

After pressing  or click **File> New**, it can create a new application and you will get a dialog box as shown in the following. (Fig. 2.2.4)

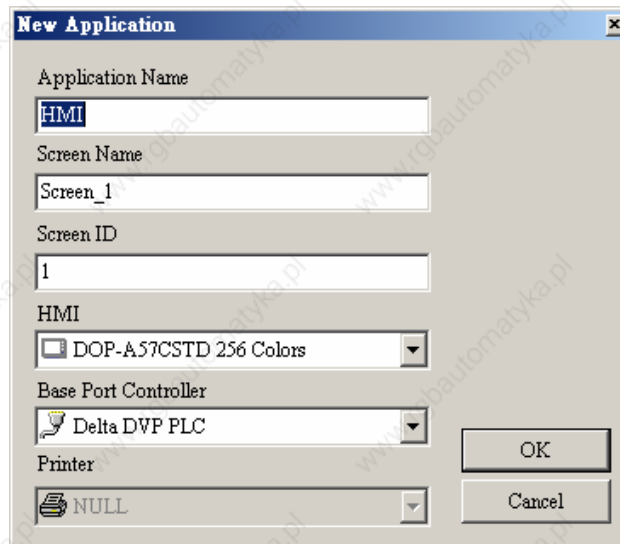


Fig. 2.2.4 Creating a New application

Enter the Application Name, Screen Name, Screen ID and select connected HMI, controller or printer. Then, click **OK**, it can create a new application in ScrEdit as shown in the following. (Fig. 2.2.5)

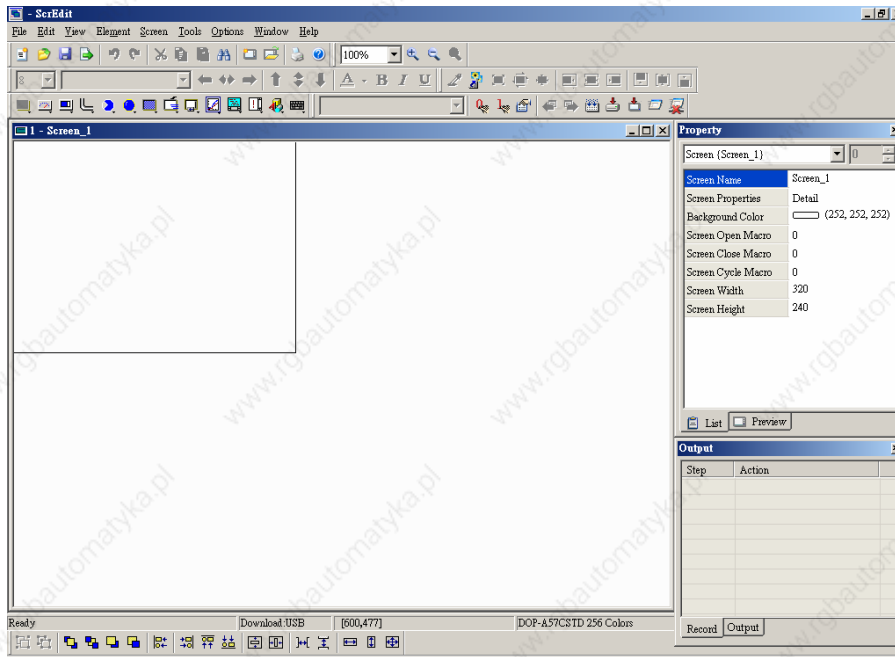
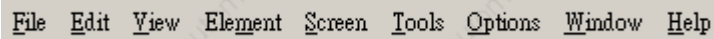


Fig. 2.2.5 New application screen of ScrEdit

There are five parts in the following for ScrEdit application window.

■ **Menu Bar**

There are nine functions for selection: File, Edit, View, Element, Screen, Tools, Options, Window, and Help.



■ **Toolbar**

Toolbar (Fig. 2.2.6) is like those toolbar in Windows® program. It is easy to use for editing and the users can arrange its position freely. For example, the users can move the Toolbar to the left side of the screen. Also, the users can arrange the toolbar position by their usage. The followings are the available toolbar on ScrEdit.

1. **Standard Toolbar**



2. **Zoom Toolbar**



3. **Text Format Toolbar**



4. Bitmap Toolbar



5. Element Toolbar



6. Build Toolbar



7. Layout Toolbar

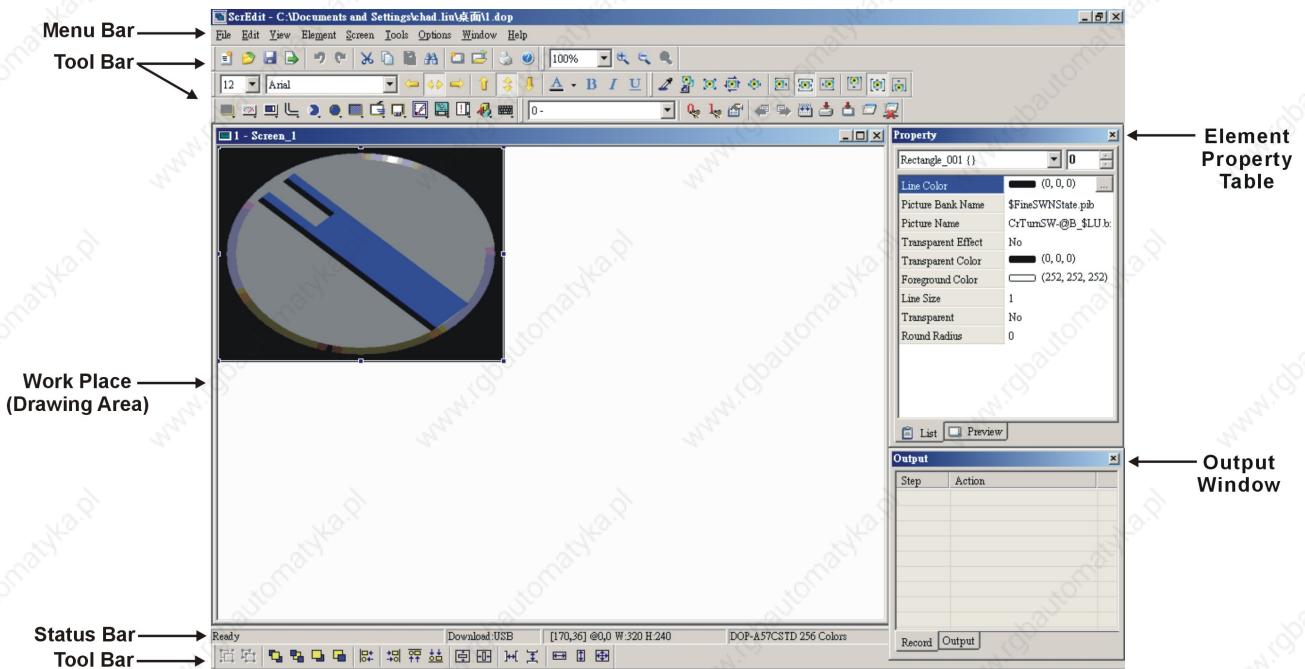


Fig. 2.2.6 ScrEdit Toolbar

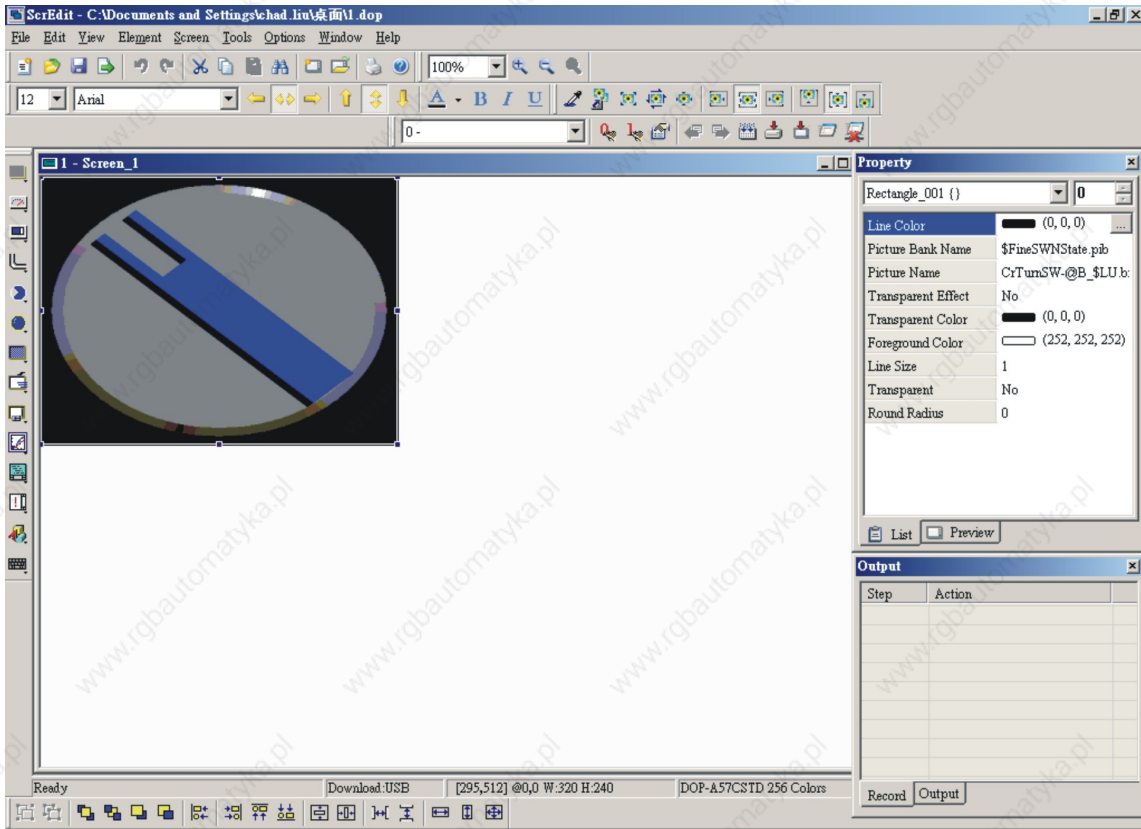


Fig. 2.2.7 Moves ScrEdit toolbar and property table

■ Property Table

It provides element property settings for each element. Please refer to Chapter 3 for detailed description.

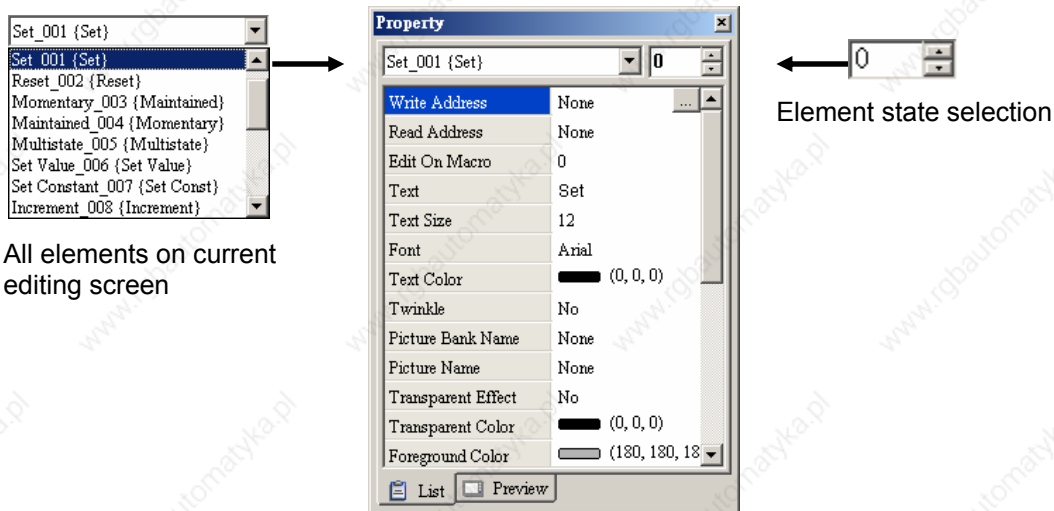


Fig. 2.2.8 Property table

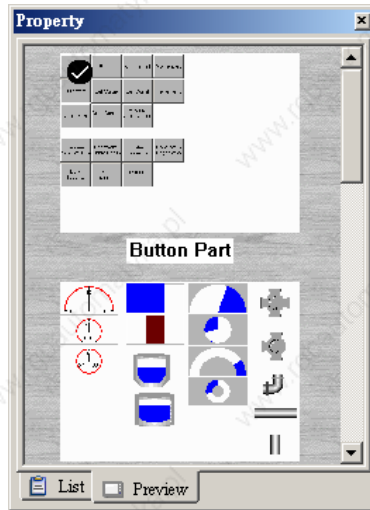


Fig. 2.2.9 Editing screen preview

■ **Output Window**

All editing actions and output message when compile function is enabled will be shown here. When compiling, ScrEdit will detect the error of user program automatically. Once error occurs, the correspondent message will display in output window. User clicks error message to get error element window.

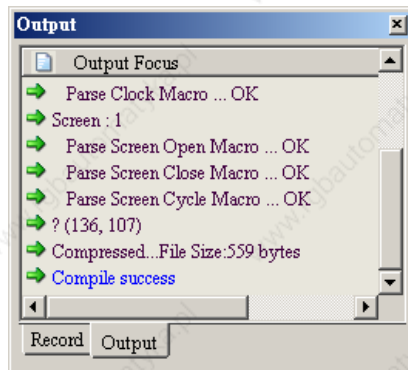


Fig. 2.2.10 Output window

■ Work Place

Getting suitable editing work place by different HMI type of DOP series. Following is an editing example display (Fig. 2.2.11).

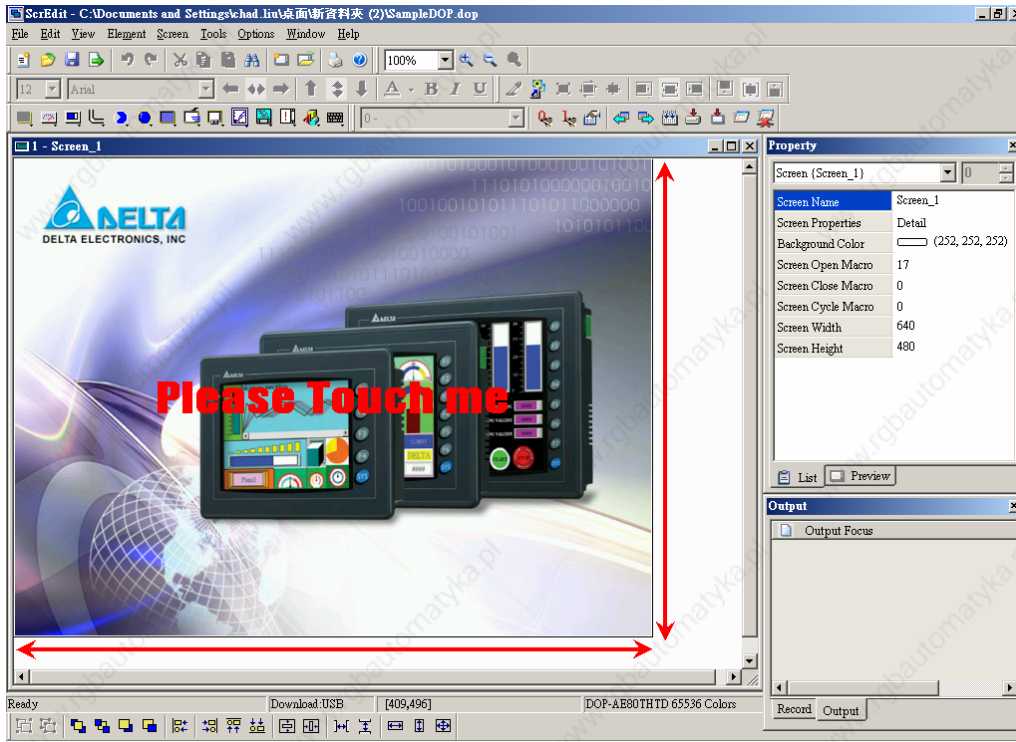
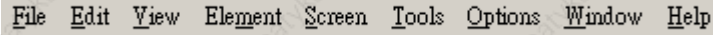


Fig. 2.2.11 ScrEdit Work Place

2.3 Menu Bar and Toolbar (File)

ScrEdit provides the convenient pull-down Menu and makes it easy for the users to create, edit and manage includes elements, pictures, graphs, macro program, recipes and displays in DOP series HMI. The pull-down menu options of Menu bar are described as follows:



■ File

The “File” menu performs many common functions.

1. Provide the users to create new application, open old application, close file, save current file and save current file to another file name, etc. options.
2. Make and Open SMC screen data.
3. Upload the editing display and data of DOP series HMI to PC and save in hard disk.
4. Update the firmware of DOP series HMI.
5. Password protect function.
6. Screen print, print preview and print setup functions.
7. By default, ScrEdit presents a list of the four most recent used files on the File menu for quick access. Just click the file name to open the file.
8. Exit command is to close all open editing files and offer to save those which have not been save yet and finally exit the ScrEdit.

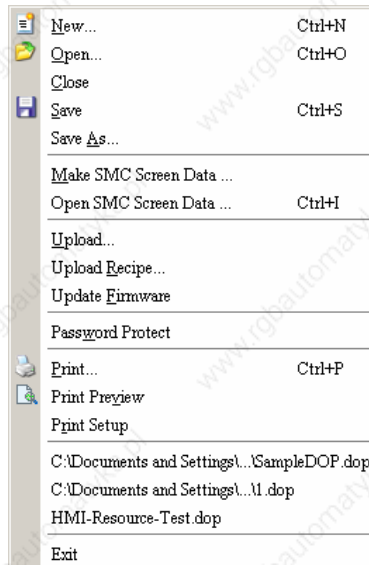


Fig. 2.3.1 File options

■ Create a New Application



Creates a new application by choosing **File > New** (Fig.

2.3.2) or clicking the New icon from toolbar (Fig. 2.3.3), or using keyboard shortcuts by pressing **Ctrl + N**.

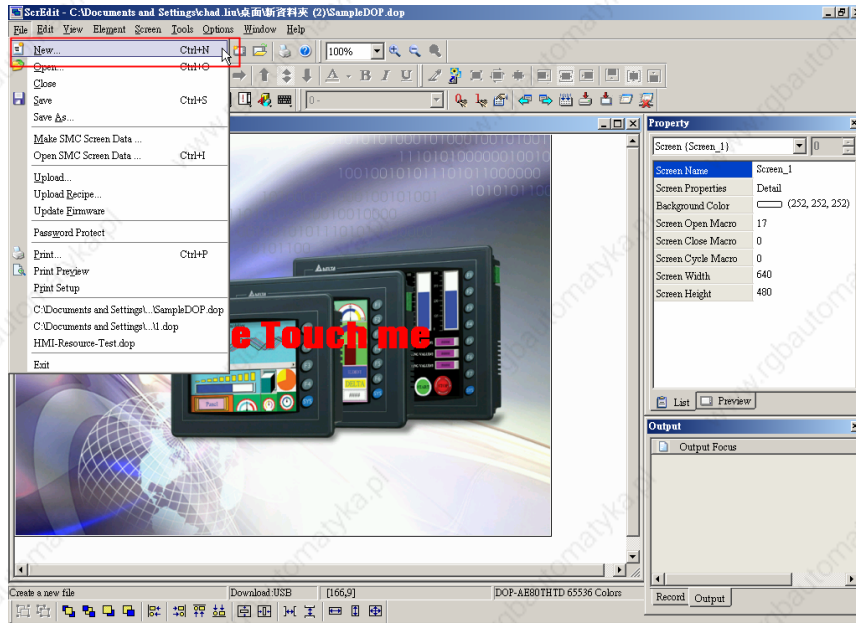


Fig. 2.3.2 Create new application (Choosing New command from menu bar)

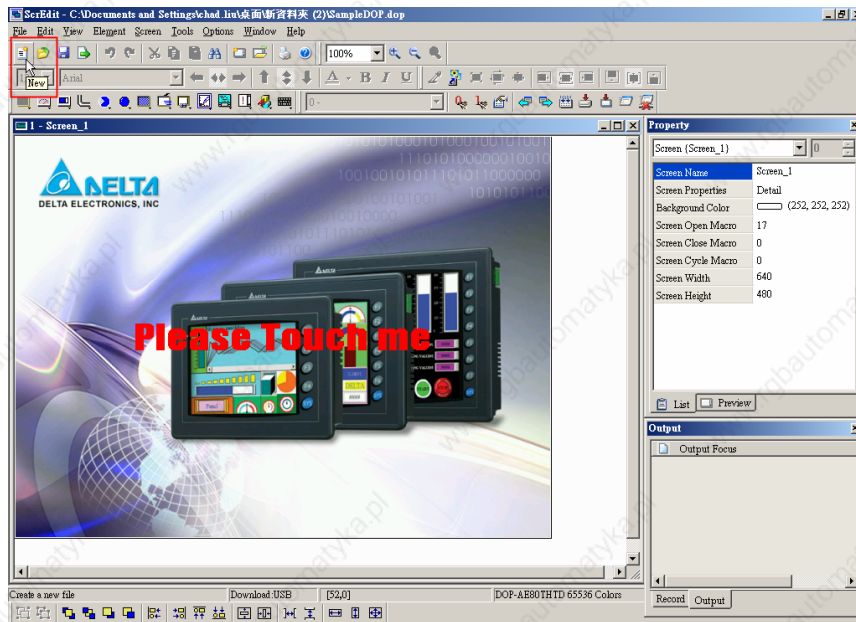


Fig. 2.3.3 Create new application (Choosing New icon from toolbar)

1. If this is the first time use and there is no old application, the following dialog box (Fig. 2.3.4) will show up for the users to input application name, screen name, screen ID, HMI type and connecting base port controller after creating a new application.

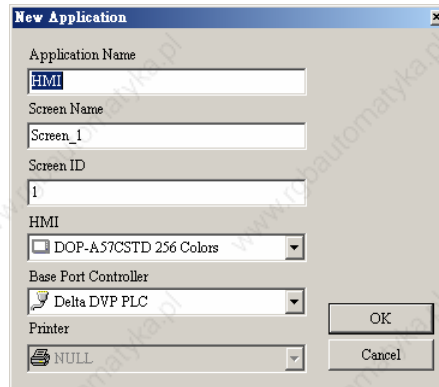


Fig. 2.3.4 New application dialog box

2. If other application files already exist and are open, the users will get the following dialog box to remind the users of saving application (Fig. 2.3.5) before creating new application. Press **Yes** button to save the existed file, press **No** button not to save the file and press **Cancel** button to cancel the save operation. After the users press the **Yes** or **No** button, the new application dialog box will appear again (Fig. 2.3.4).

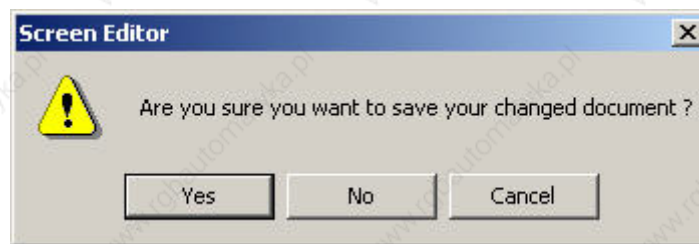


Fig. 2.3.5 Saving dialog box

3. Input application name, screen name, select HMI model and connecting base port controller (Fig. 2.3.6), and then press **OK** button.

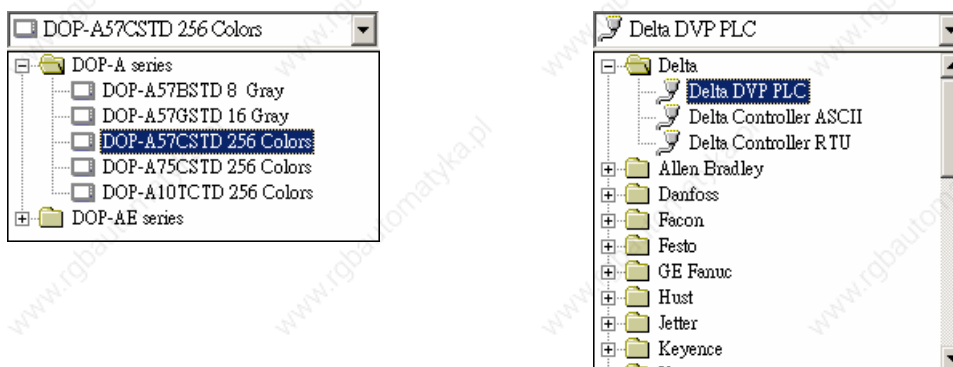



Fig. 2.3.6 HMI model and base port controller options

■ Open Old Application



Open current application by choosing **File > Open** (Fig.

2.3.7) or clicking the Open icon  from toolbar, or using keyboard shortcuts by pressing **Ctrl + O**.

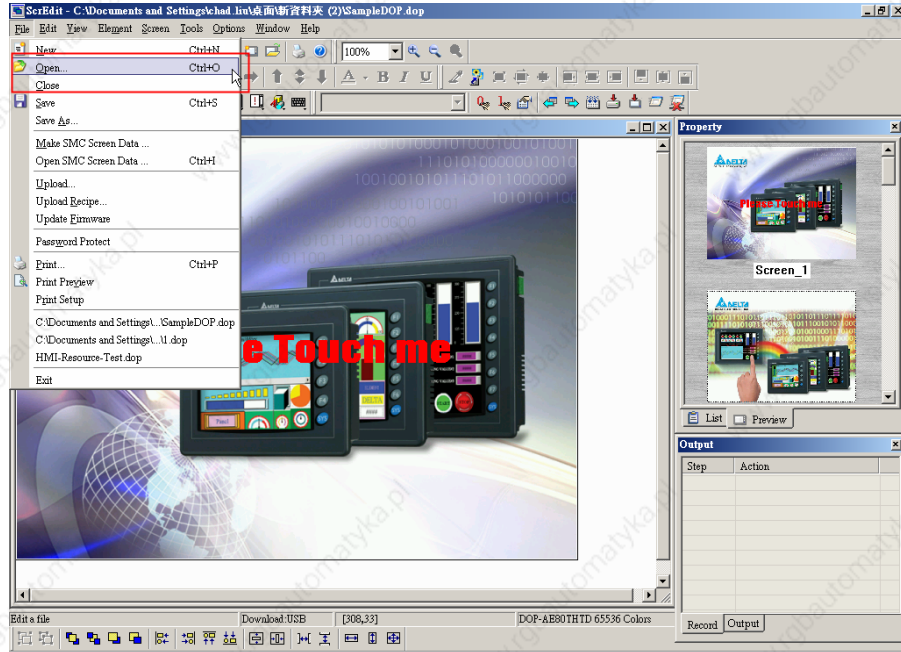


Fig. 2.3.7 Open old application (Choosing Open command from menu bar)

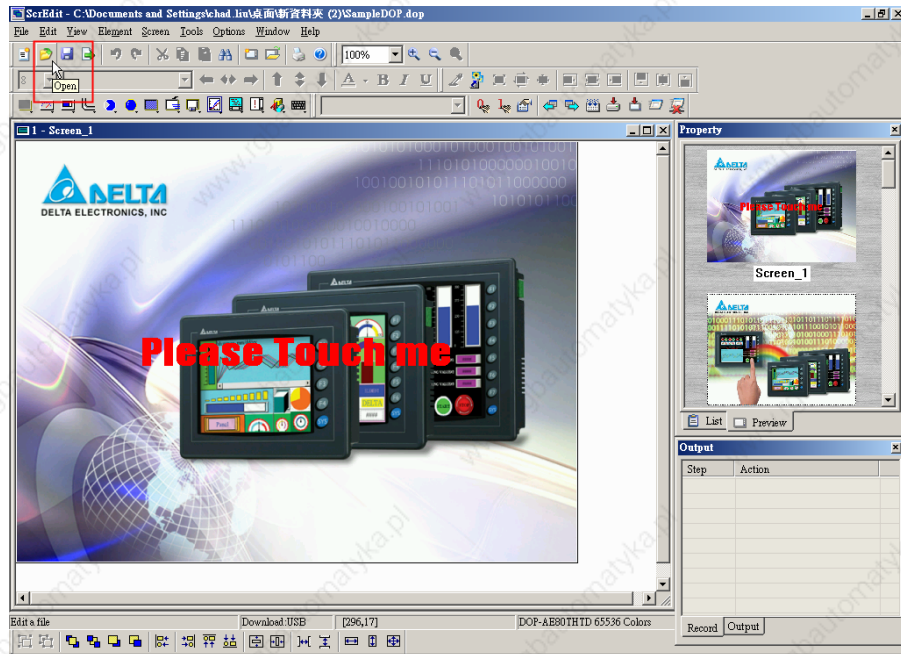


Fig. 2.3.8 Open old application (Choosing Open icon from toolbar)

1. If other application files exist before opening an old application, the users will get the Saving dialog box (Fig. 2.3.5) to remind the users of saving file and then get the following dialog box for opening existing dop file (Fig. 2.3.9).
2. If save operation is complete or there is no old application files, the following dialog box for opening existing dop file will show up directly.

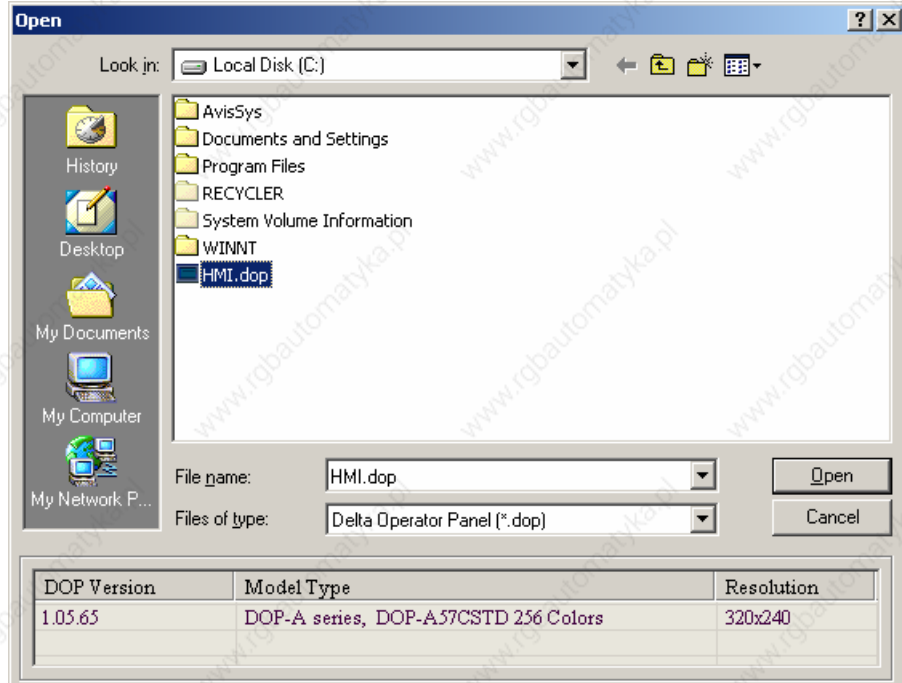


Fig. 2.3.9 Open an old application in ScrEdit

■ Close File



Closes application by clicking **File > Close** (Fig. 2.3.10).

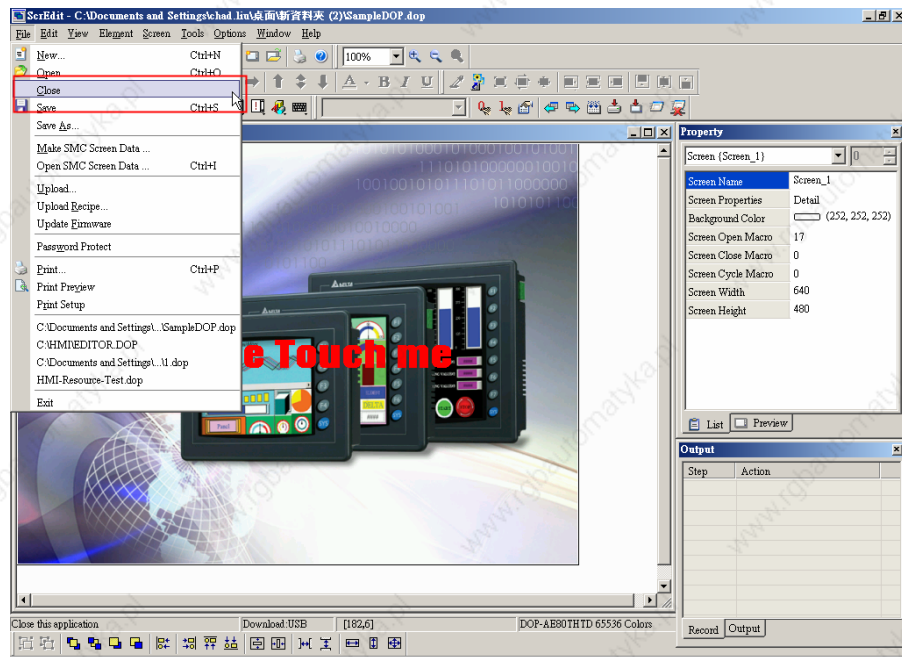


Fig. 2.3.10 Close application (Choosing Close command from menu bar)

1. If application didn't get saved before issuing the command of closing application, the users will get saving dialog box (Fig. 2.3.11) to remind the users of saving application.

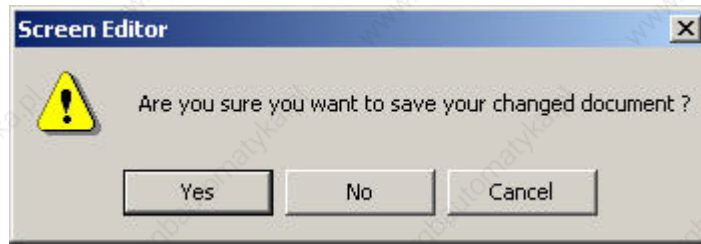



Fig. 2.3.11 Saving dialog box

■ Save File



Save current application into hard disk with extension file "dop" by choosing **File > Save** (Fig. 2.3.12) or clicking the

Save icon  (Fig. 2.3.13), or using keyboard shortcuts by pressing **Ctrl + S**. If the application is a new file, the Save as dialog box will show up (Fig. 2.3.15). If the application is an old file, the Save function will perform immediately and the Save as dialog box will not show up.

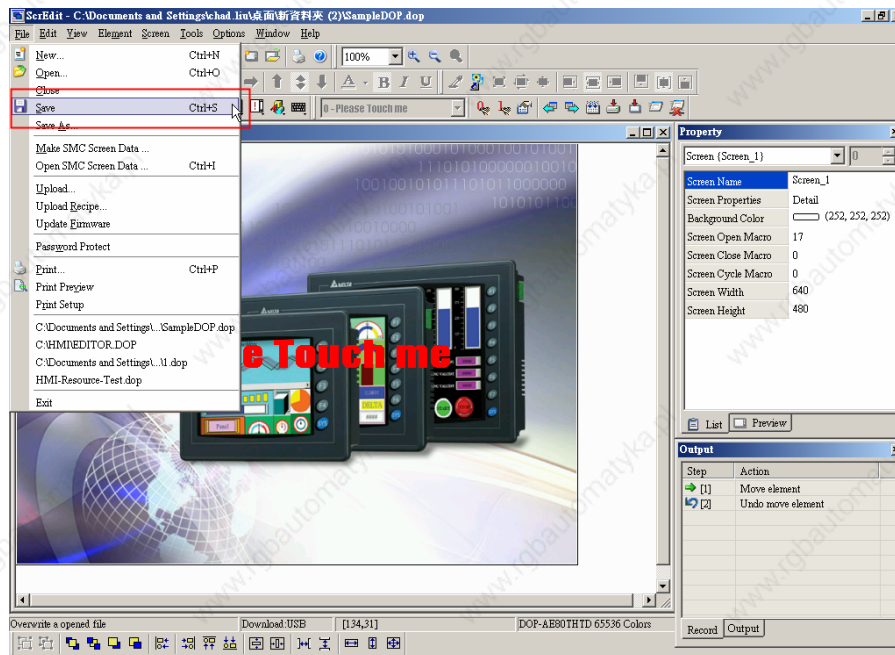


Fig. 2.3.12 Save file (Choosing Save command from menu bar)

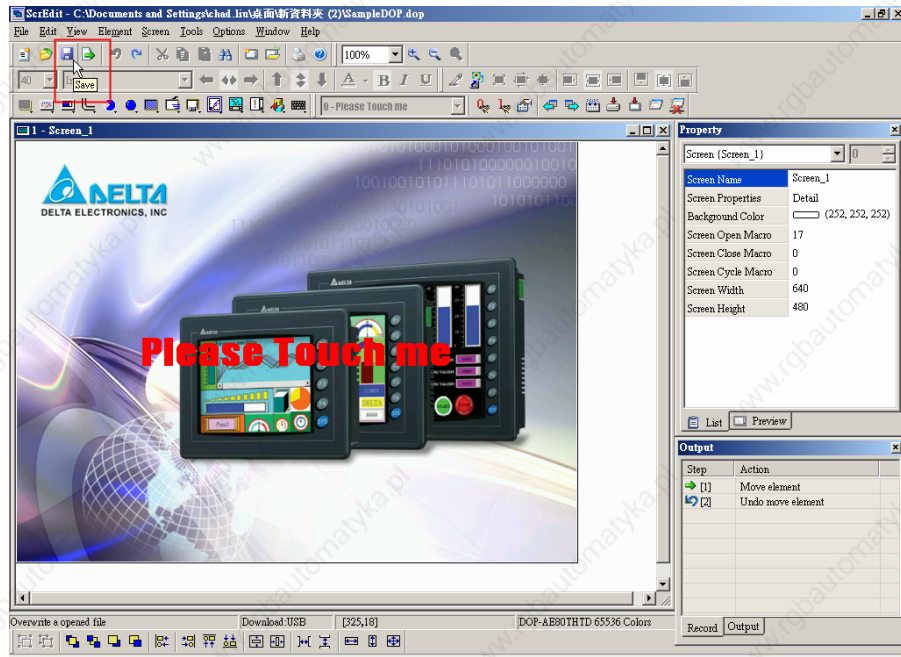


Fig. 2.3.13 Save file (Choosing Save icon from toolbar)

■ Save As



Save current application to another file name by clicking **File > Save As** (Fig. 2.3.14). The users will get Save as dialog box (Fig. 2.3.15) to input application name with extension file dop. This dialog also appears automatically when the first time any application file is saved no matter whether Save As or Save command is used.

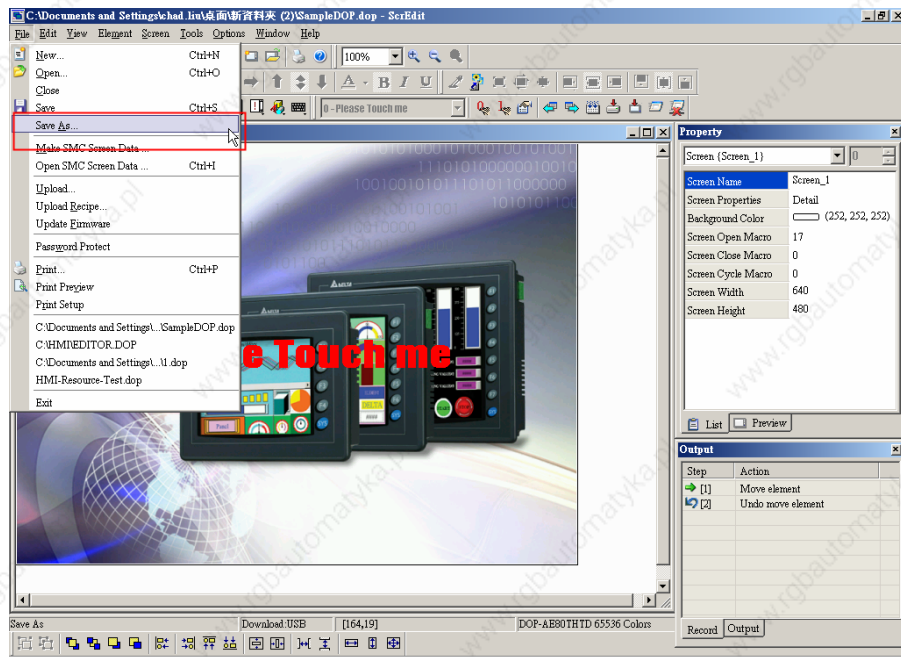


Fig. 2.3.14 Choosing Save As command from menu bar

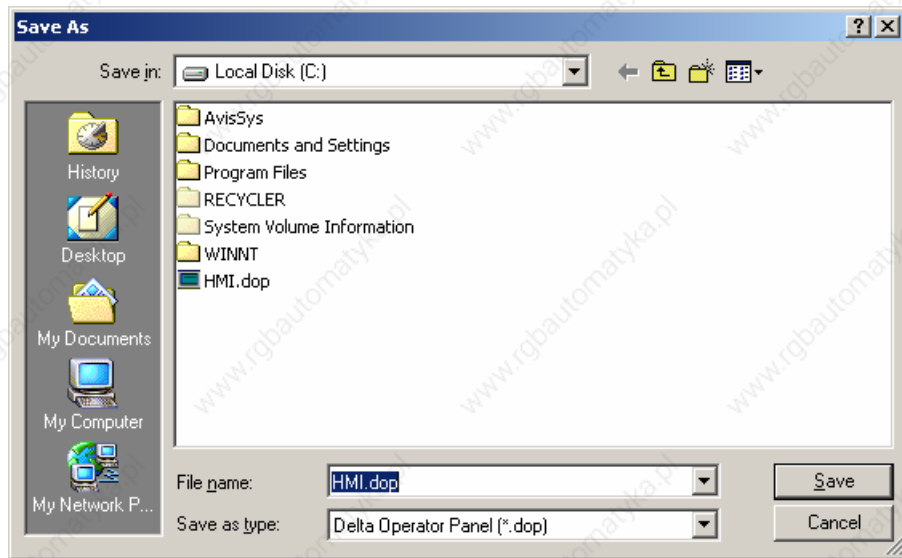


Fig. 2.3.15 Save as dialog box (Dialog box that let user input application name to save as.)

■ **Make SMC Screen Data**

Make SMC Screen Data ...

Before using this command, ensure to compile the editing screen data. If not execute the compilation first, the ScrEdit cannot make screen data and an error message dialog box will show up (Fig. 2.3.16). Please execute the compilation first and then clicking **File > Make SMC Screen Data** to copy the compiled HMI program into SMC card (Fig. 2.3.17). If the SMC card with compiled HMI program stored inside is inserted into HMI, HMI will startup by reading the data of SMC card directly.



Fig. 2.3.16 Error message dialog box when making SMC screen data



Fig. 2.3.17 Make SMC Screen Data Dialog Box

■ Open SMC Screen Data



In HMI, the users can move the screen data saved in the flash memory into SMC card through folder manager. Then, perform **Open SMC Screen Data** function and the users will get the users will get Fig. 2.3.17 dialog box. At this time, the users can open the screen data and edit the HMI screen data directly.

■ Upload Screen Data and Recipe



After clicking **File > Upload** (Fig. 2.3.18), the password dialog box will show up first, the users need to input password (the password is the highest priority saved in HMI) to get save as dialog box (Fig. 2.3.15). After inputting application file name, the uploading will start (Fig. 2.3.20). The users can get the progress with progress box and stop uploading by clicking **Stop** button. When progress goes to 100%, it indicates that the uploading is complete. The users can press **Stop** button to exit the dialog box. The file that is uploaded from HMI can be restored to original editing file for user to edit. This option is to avoid losing the original editing file.

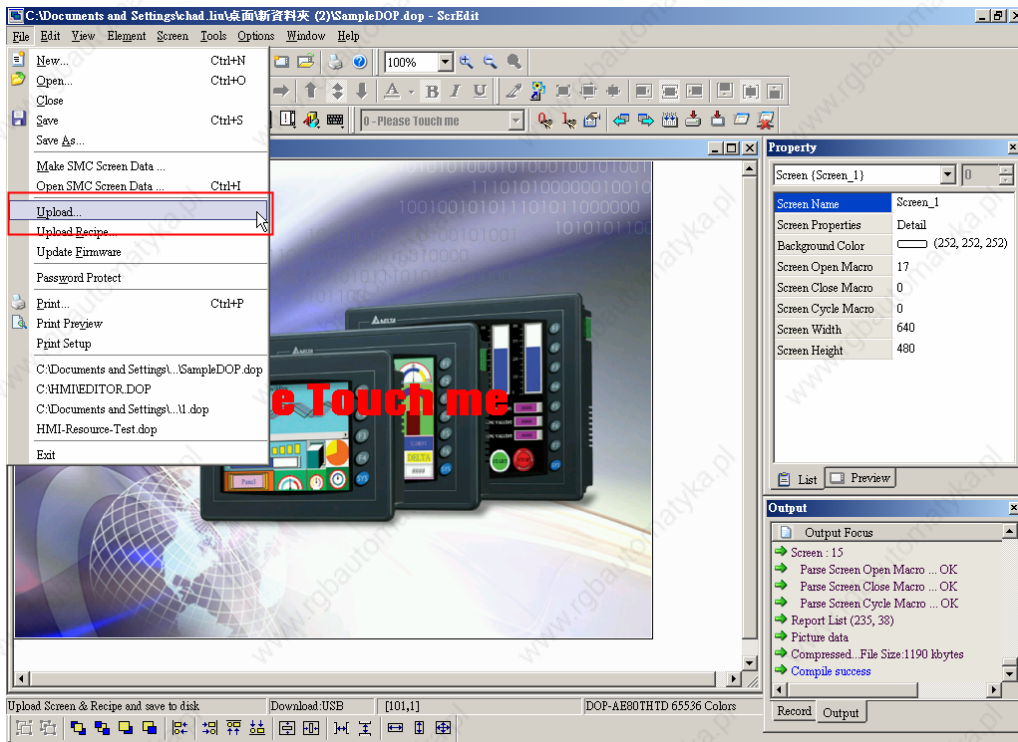


Fig. 2.3.18 Choosing Upload command from menu bar

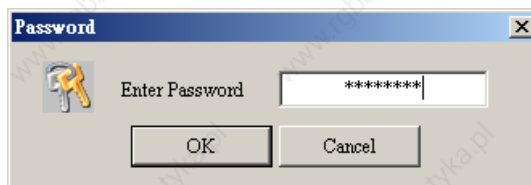


Fig. 2.3.19 Enter password dialog box

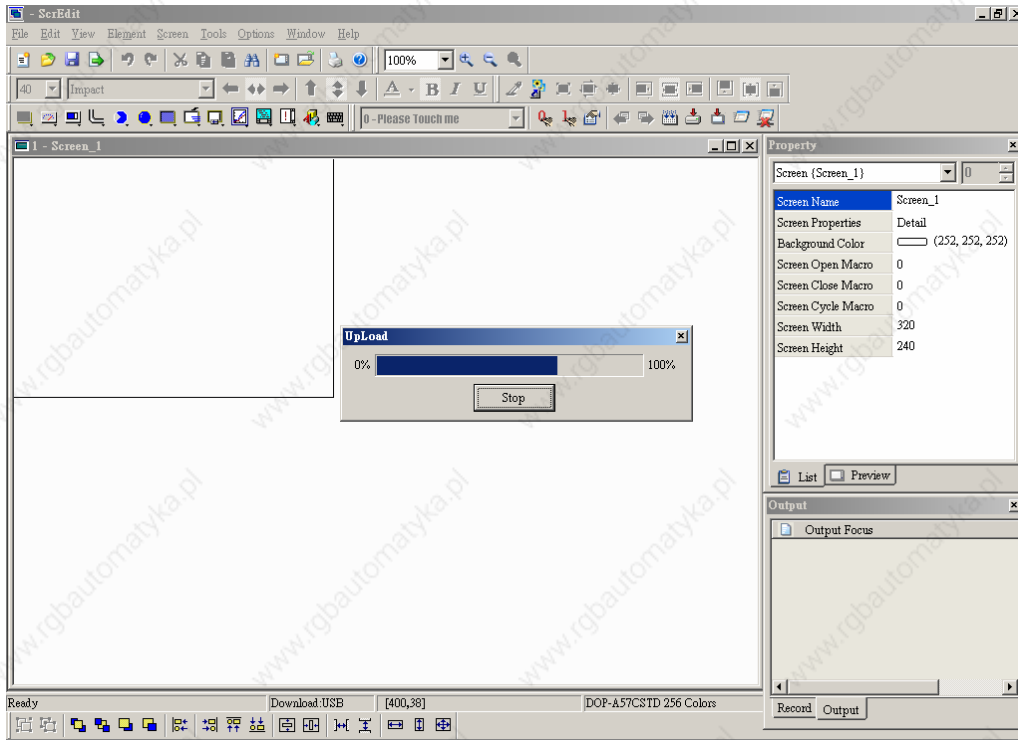


Fig. 2.3.20 Uploading screen

■ Upload Recipe

Upload Recipe...

This function is similar to upload function (Fig. 2.3.20) but it can only upload recipe (Fig. 2.3.21). It also needs password (the highest priority password saved in HMI) before uploading.

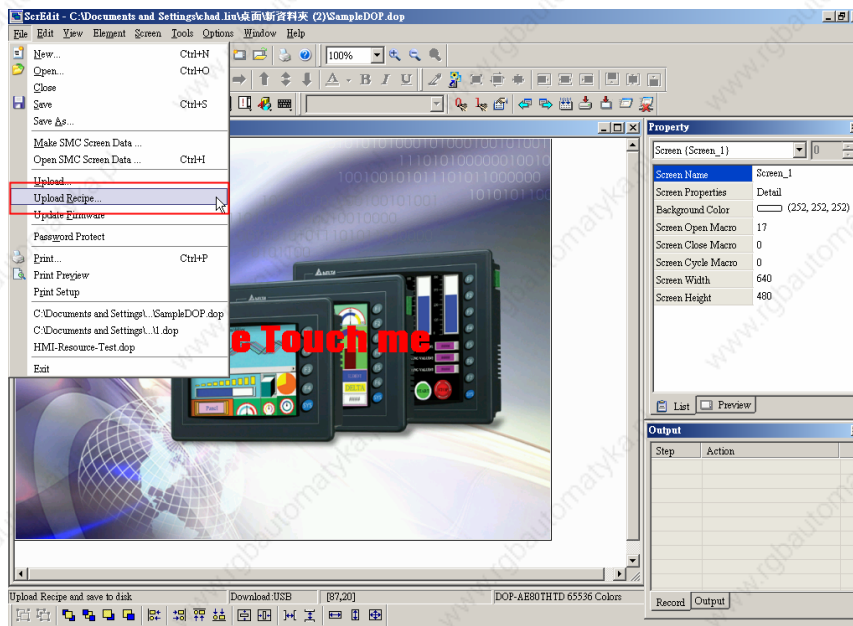


Fig. 2.3.21 Choosing Upload Recipe command from menu bar

■ Update Firmware

Update Firmware

This option is for upgrading HMI firmware or adding function for HMI (Fig. 2.3.22).

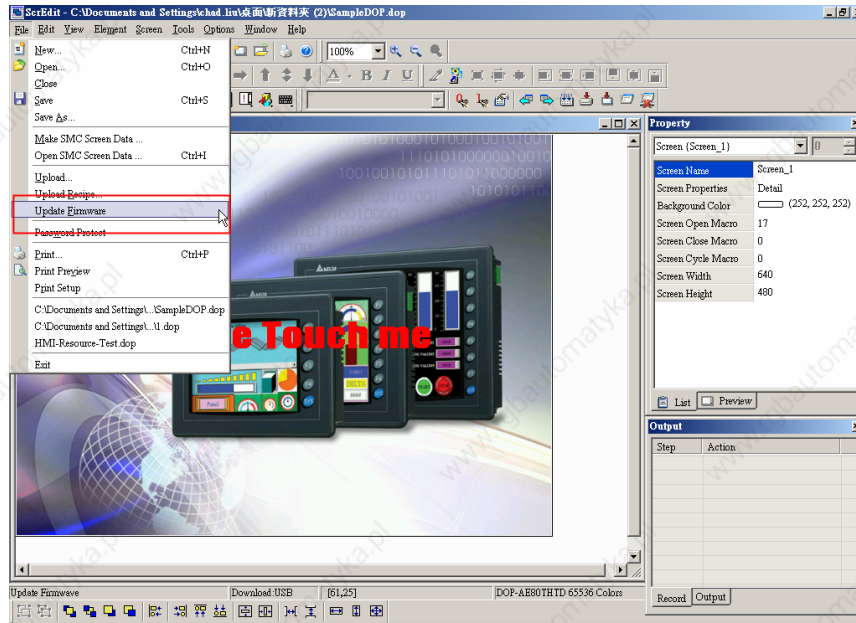


Fig. 2.3.22 Choosing Update Firmware command from menu bar

■ Password Protect

Password Protect

The users can enable and disable password protect function by clicking **File > Password protect** (Fig. 2.3.23). Once password protect function is enabled, the users will get Fig. 2.3.24 dialog box and symbol before “Password Protect” command. If the symbol shows before “Password Protect” command from File menu, it indicates that this dop file is password protected and the users will need to input password before opening dop file. The password is set by clicking **Option > Workstation Setup** (Fig. 2.3.26). If the password protect function is disabled, the Fig. 2.3.25 dialog box will show up.

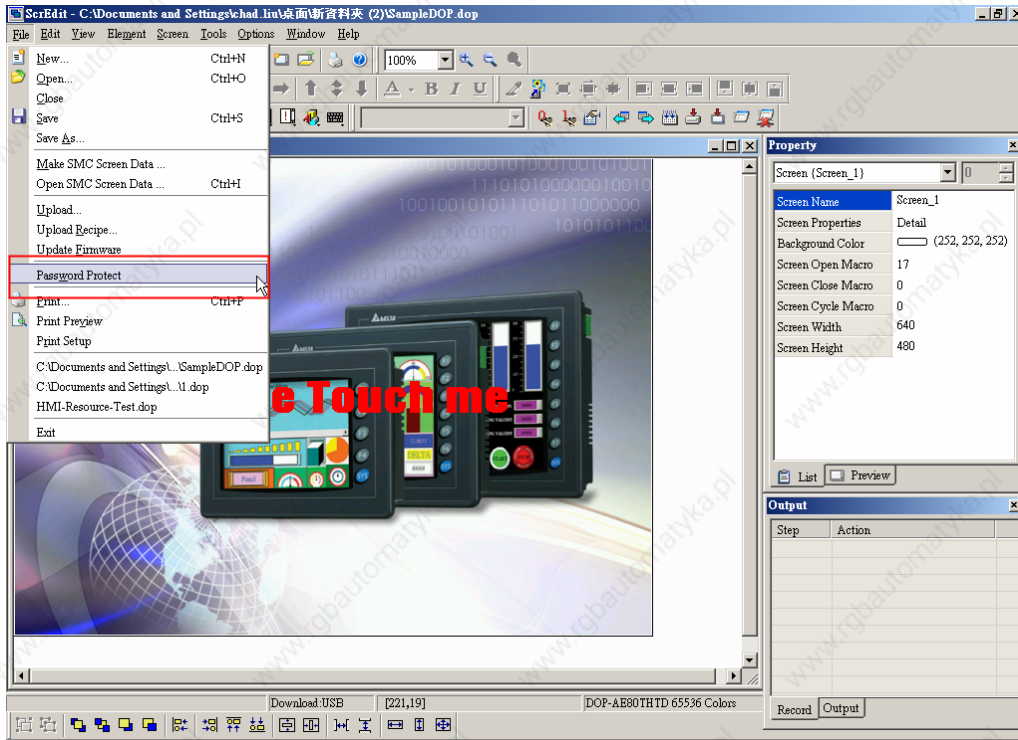


Fig. 2.3.23 Choosing Password Protect command from menu bar



Fig. 2.3.24 Password protect function is enabled



Fig. 2.3.25 Password protect function is disabled

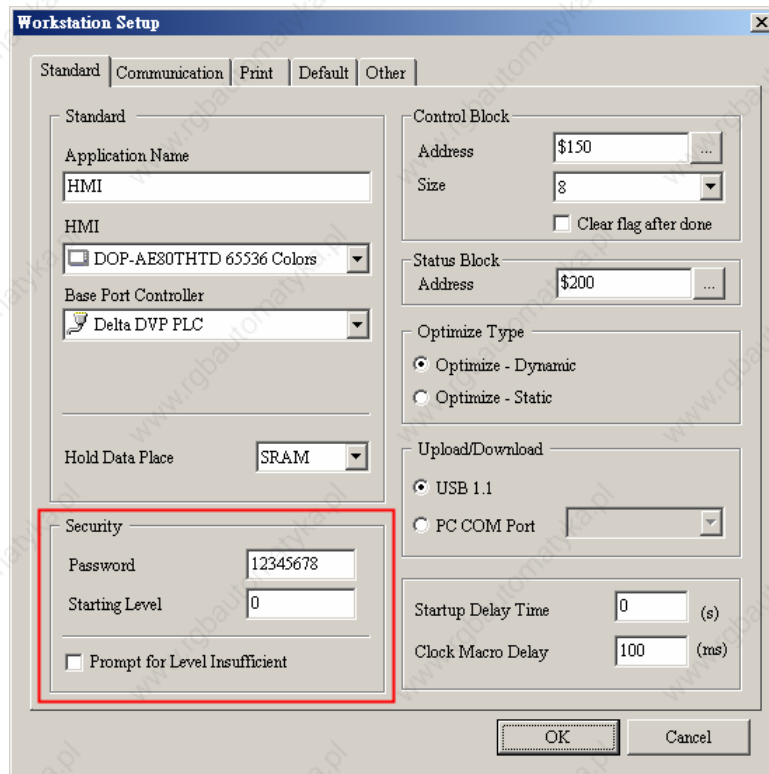


Fig. 2.3.26 Password settings

■ Print



Print current screen by choosing **File > Print** (Fig.2.3.27), or clicking the Print icon  from toolbar (Fig. 2.3.28), or using keyboard shortcuts by pressing **Ctrl + P**.

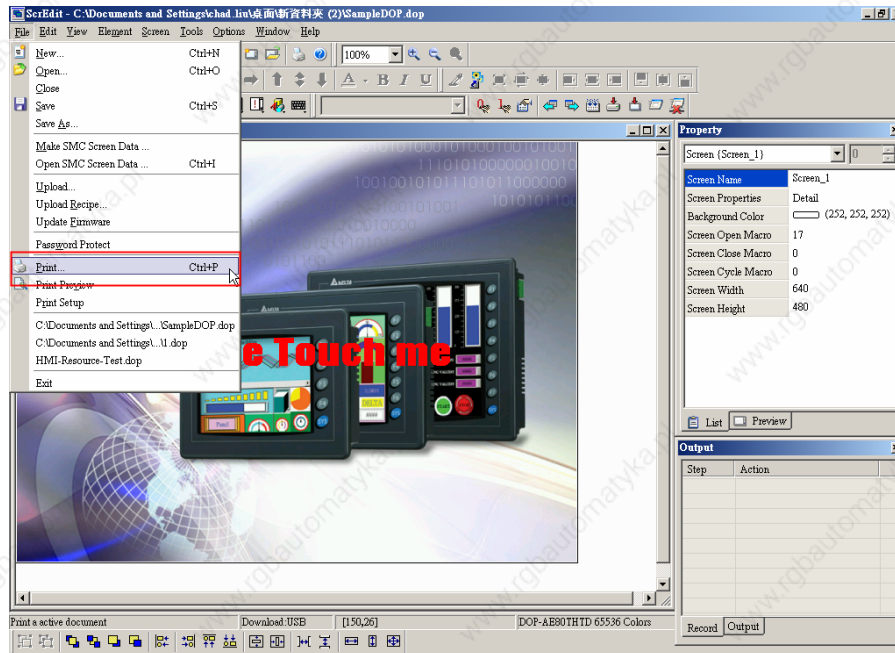


Fig. 2.3.27 Choosing Print command from menu bar

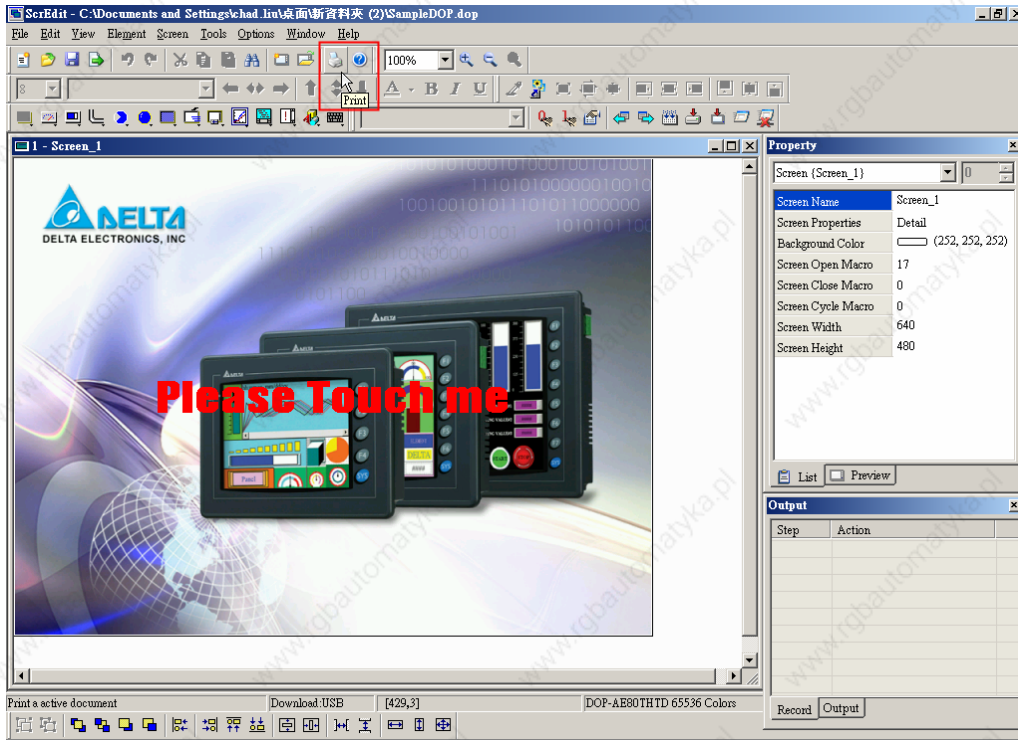


Fig. 2.3.28 Choosing Print icon from toolbar

■ Print Preview



Select this function by clicking **File > Print Preview** (Fig. 2.3.29). Using this function can preview the full page after printing (Fig. 2.3.30).

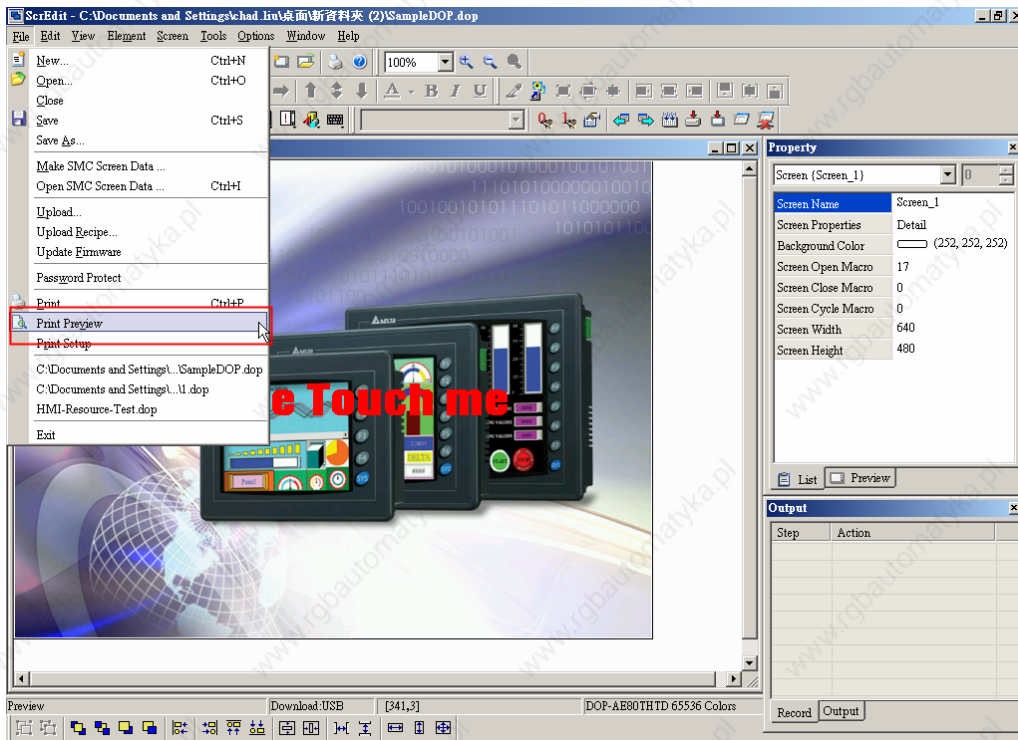


Fig. 2.3.29 Choosing Print Preview command from menu bar

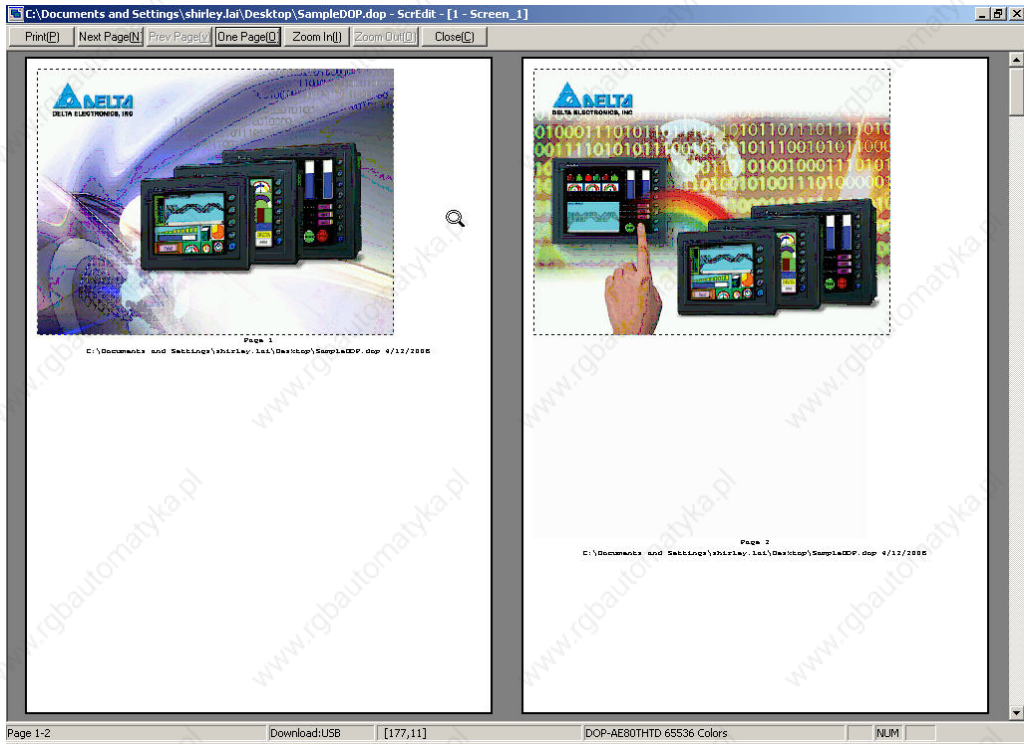


Fig. 2.3.30 Print Preview screen

■ **Print Setup**

Print Setup

Printer and paper settings. Select this function by clicking **File > Print Setup** (Fig. 2.3.31). Using this function can set the property of printer, print paper and print direction, etc. several functions (Fig. 2.3.32).

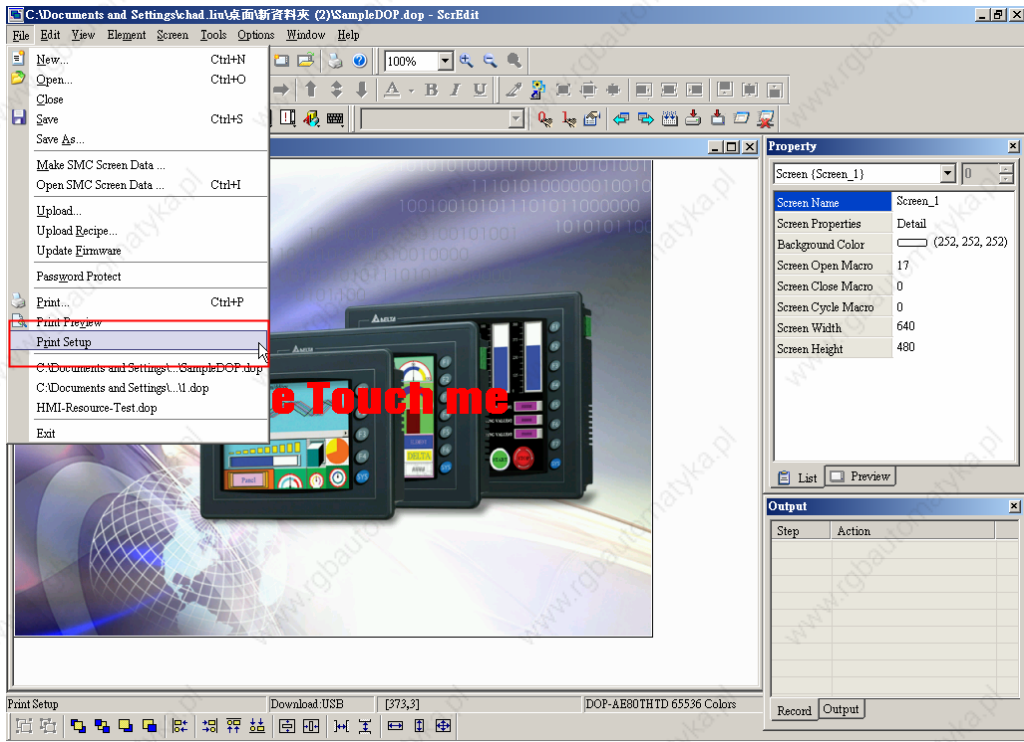


Fig. 2.3.31 Choosing Print Setup command from menu bar

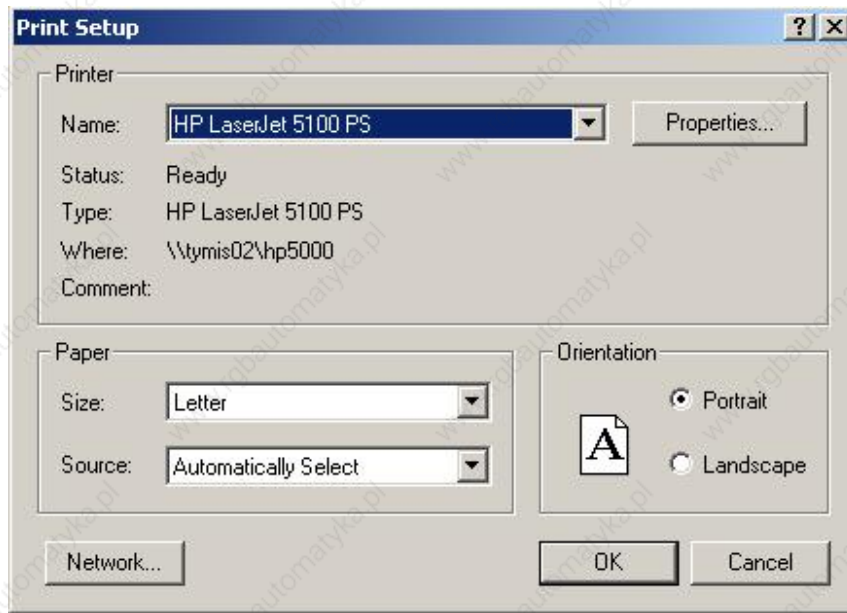


Fig. 2.3.32 Print Setup dialog box

■ File Quick Access

By default, ScrEdit presents a list of the four most recent used files on the File menu for quick access (Fig. 2.3.33). Just click the file name to open the file. This function is similar to the Open command and the users can refer to the description of Open command on the page 2-15. If the saving path is too long, the too long path will display as "...". The users still can see the complete dop file name.

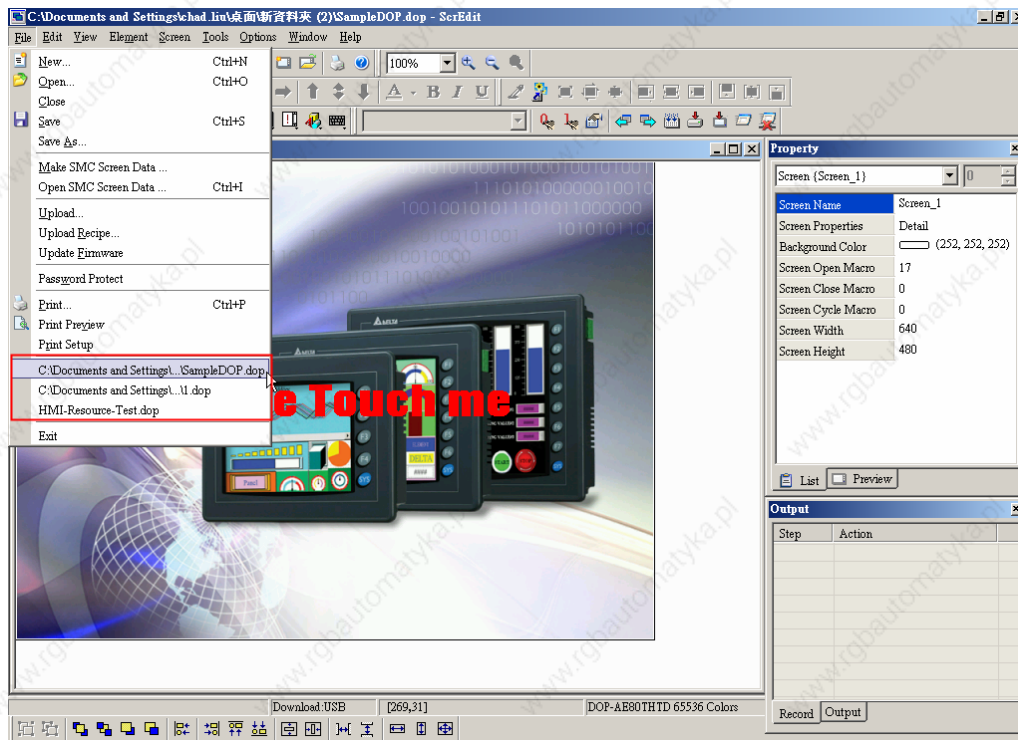


Fig. 2.3.33 Most recent used files

■ Exit

Exit

Exit function is to close all open editing files and offer to save those that have not been save yet and finally exit the ScrEdit. Select this function by clicking **File > Exit** (Fig. 2.3.34). If the file has been changed or not saved yet, the saving dialog box (Fig. 2.3.11) will show up to remind the users of saving application. If the users press **Cancel** button at this time, the exit command is cancelled. Either pressing **Yes** button to save the file, or pressing **No** button not to save the file can exit the ScrEdit. After the users press the **Yes** button, the Save As dialog box will appear (Fig. 2.3.15) for saving the file.

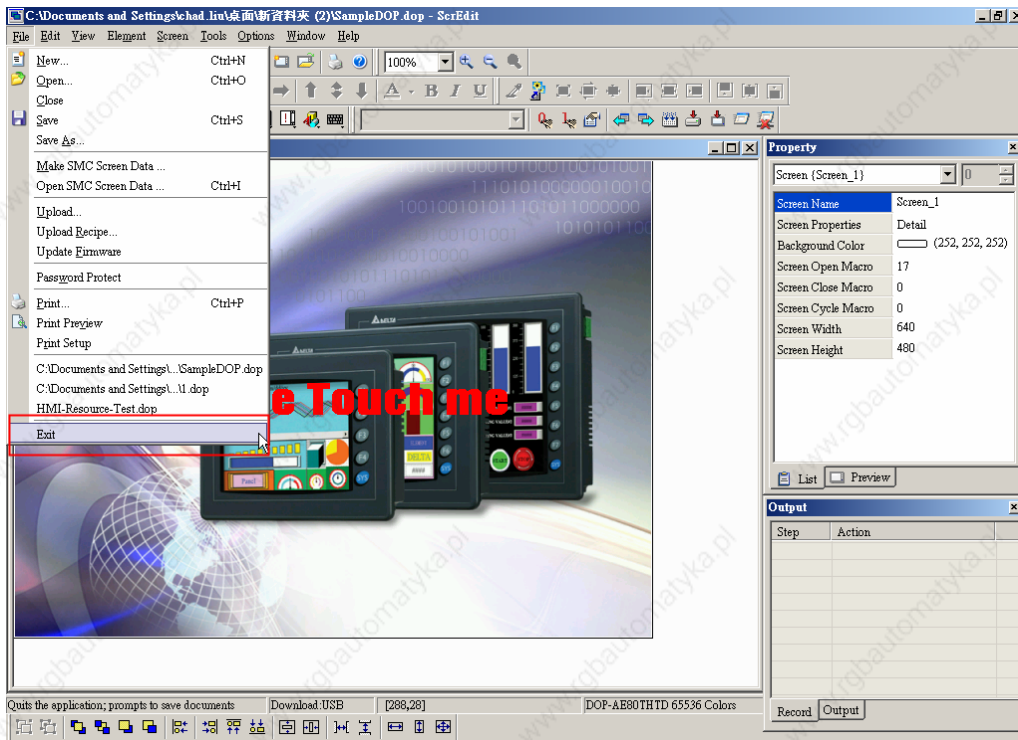


Fig. 2.3.34 Choosing Exit command from menu bar

2.4 Menu Bar and Toolbar (Edit)

■ Edit

Adopt Microsoft Office style pull-down menu and provide user-friendly Edit pull-down menu (Fig. 2.4.1).

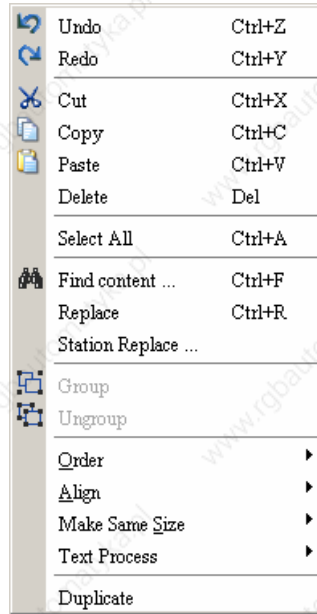



Fig. 2.4.1 Edit options

■ Undo



Undo the last action. Select this function by choosing **Edit > Undo**

(Fig.2.4.2) or clicking the Undo icon  from toolbar (Fig.2.4.3), or use keyboard shortcuts by pressing **Ctrl + Z**. All actions are recorded in output window.

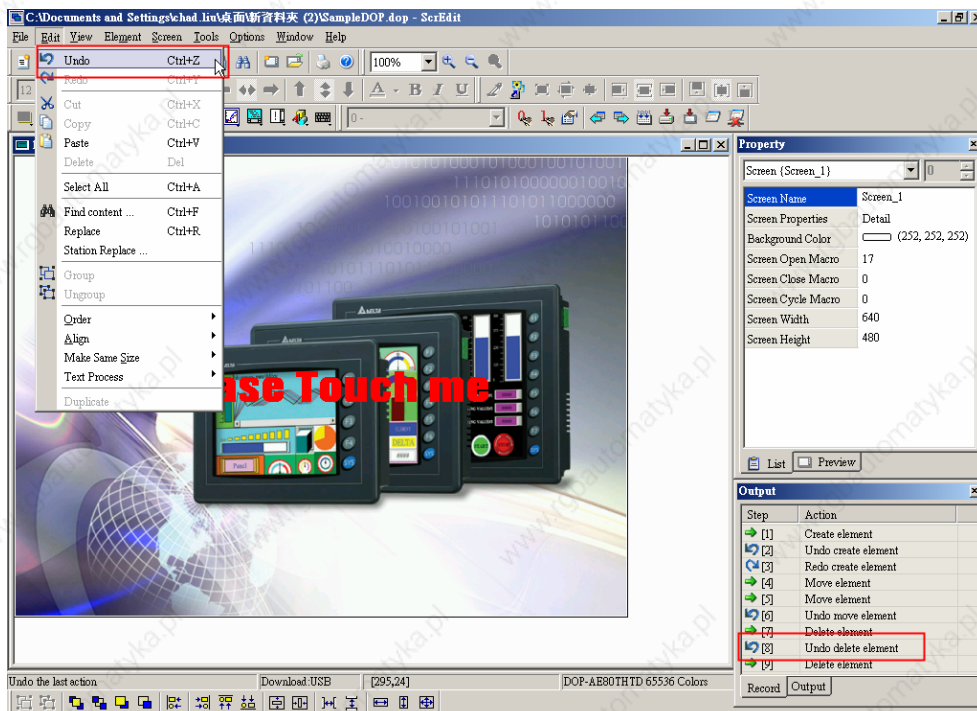


Fig. 2.4.2 Choosing Undo command from menu bar

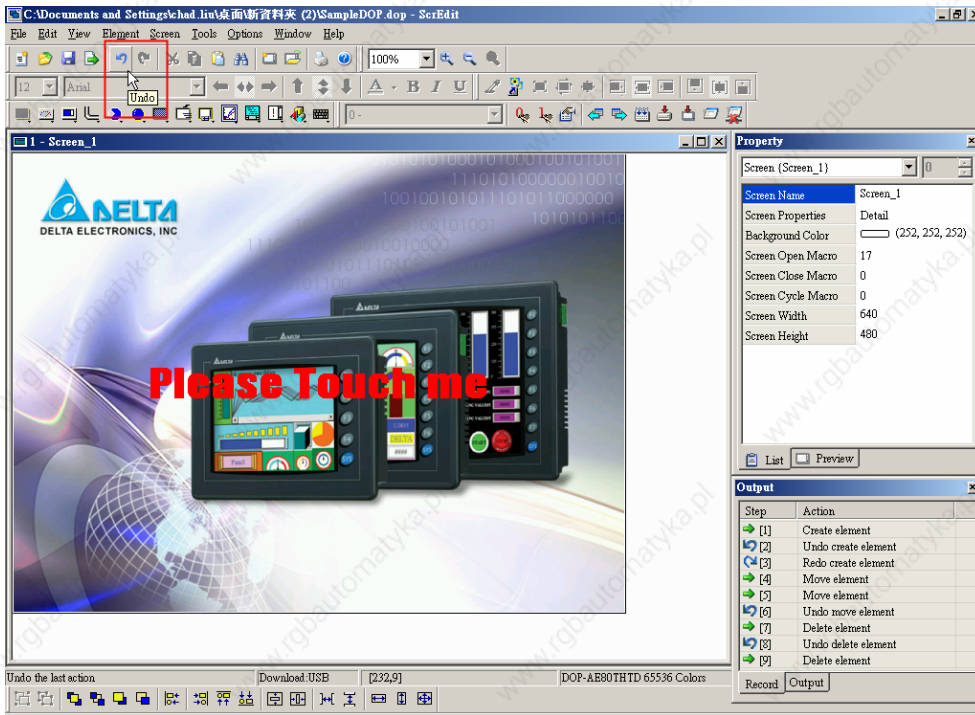



Fig. 2.4.3 Choosing Undo icon from toolbar

■ Redo



Redo the undo action. Select this function by choosing **Edit > Redo**

(Fig.2.4.4 or clicking the Redo icon  from toolbar (Fig.2.4.5), or use keyboard shortcuts by pressing **Ctrl + Y**. All actions are recorded in output window.

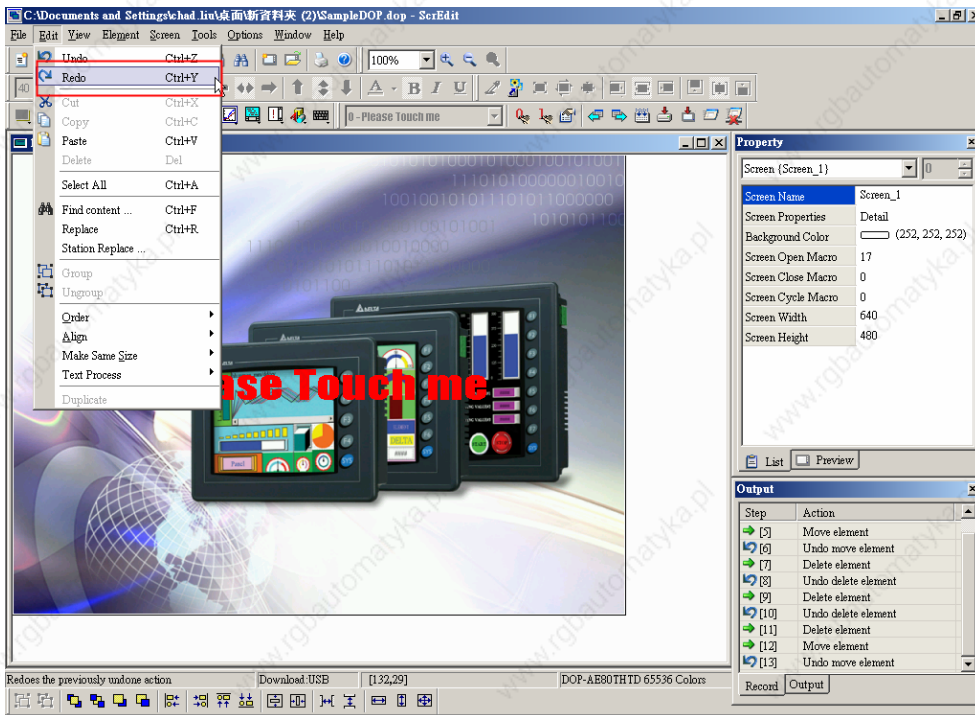


Fig. 2.4.4 Choosing Redo command from menu bar

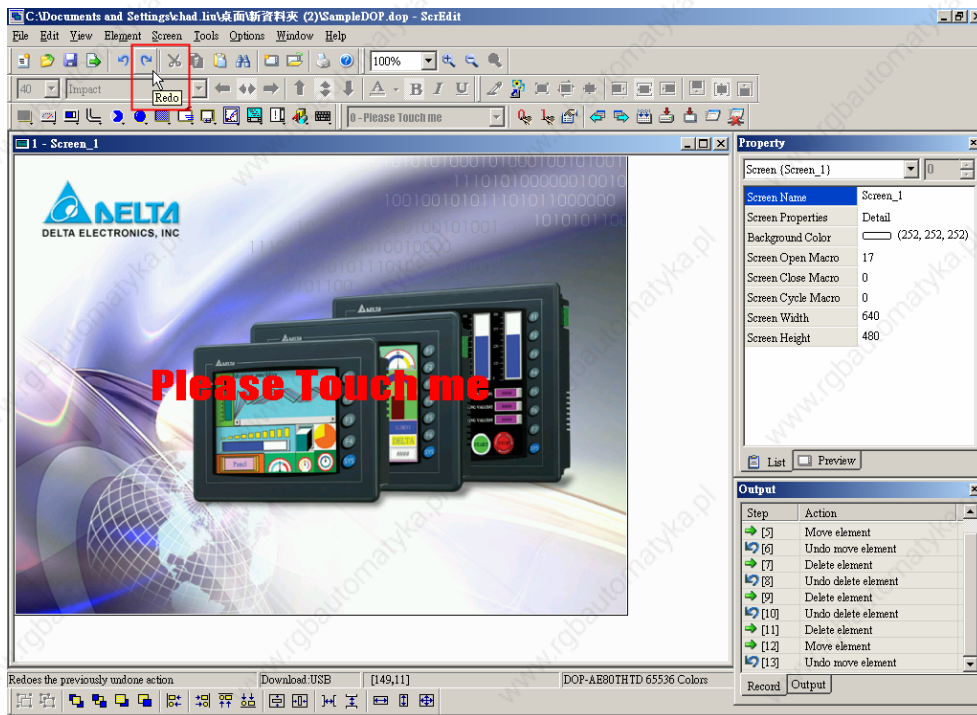



Fig. 2.4.5 Choosing Redo icon from toolbar

■ Cut



Deletes the selected element and save it in clipboard to paste to other place. Select this function by choosing **Edit > Cut** (Fig. 2.4.6) from menu bar or clicking the Cut icon  from toolbar (Fig.2.4.7), or use keyboard shortcuts by pressing **Ctrl + X**.

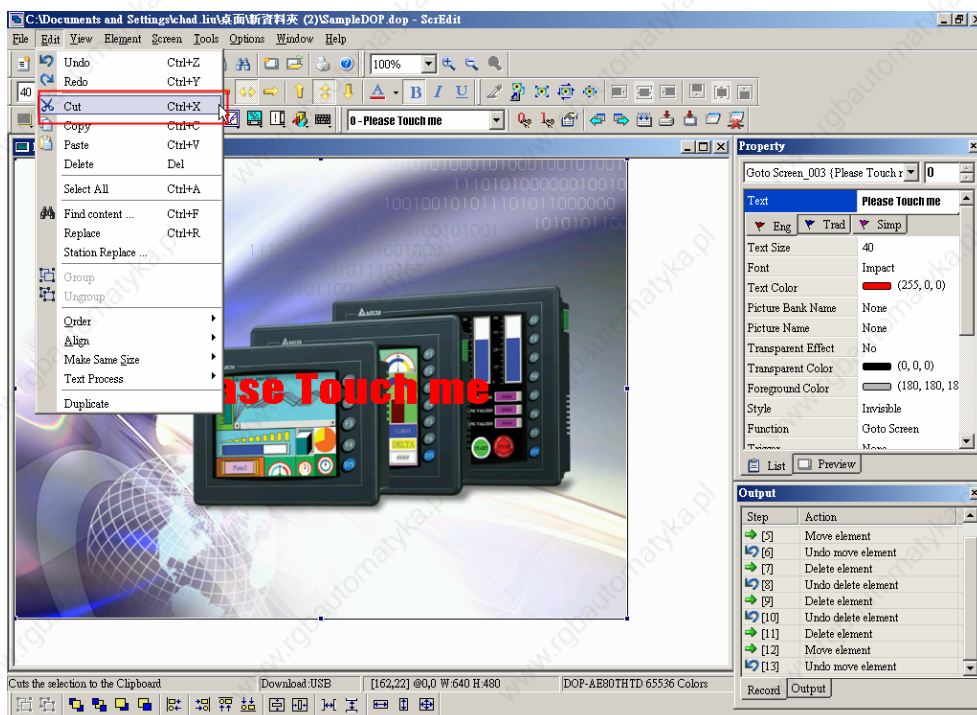



Fig. 2.4.6 Choosing Cut command from menu bar



Fig. 2.4.7 Choosing Cut icon from toolbar

■ Copy



Copy the selected element to the clipboard. Select this function by choosing **Edit > Copy** (Fig. 2.4.8) from menu bar or clicking the Copy icon  from toolbar (Fig.2.4.9), or use keyboard shortcuts by pressing **Ctrl + C**.

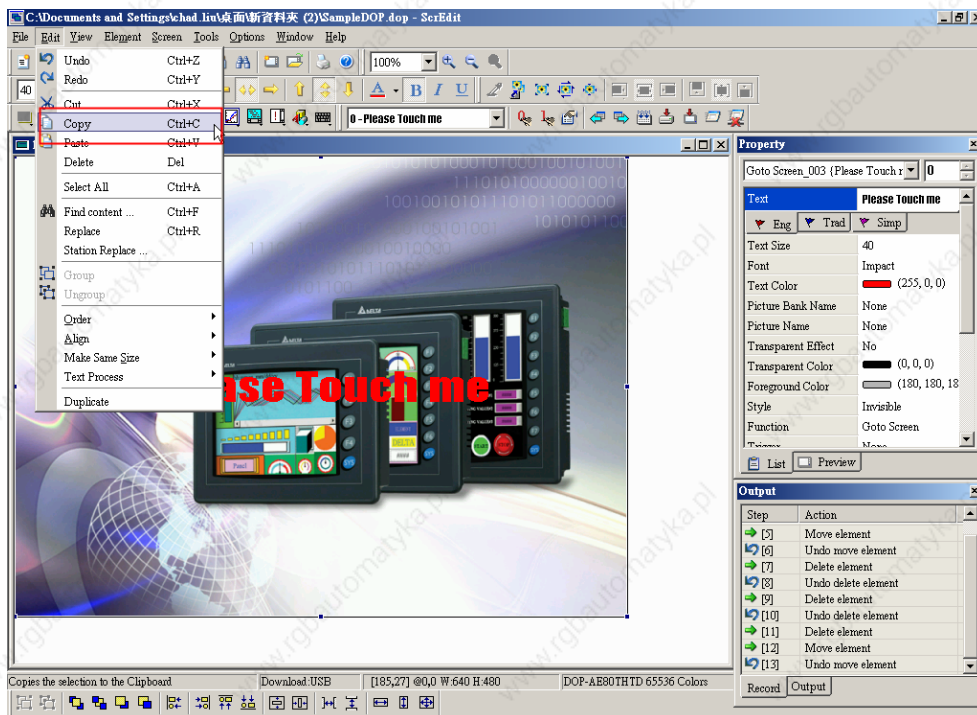


Fig. 2.4.8 Choosing Copy command from menu bar

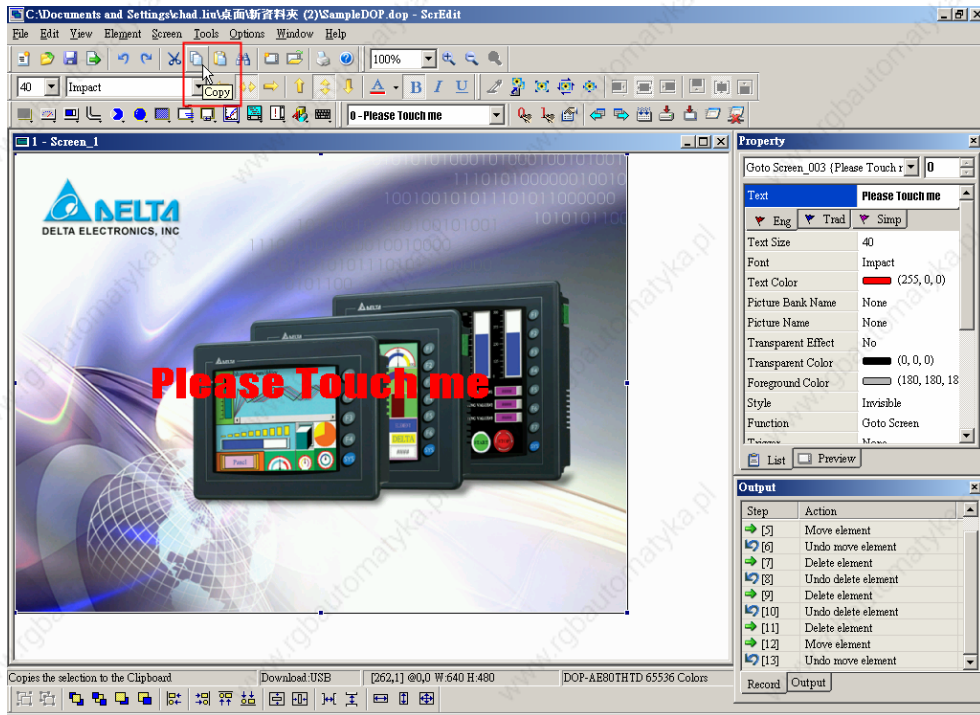



Fig. 2.4.9 Choosing Copy icon from toolbar

■ Paste



Paste element from clipboard. Select this function by choosing **Edit >**

Paste (Fig. 2.4.10) from menu bar or clicking the Paste icon  from toolbar (Fig.2.4.11), or use keyboard shortcuts by pressing **Ctrl + V**.

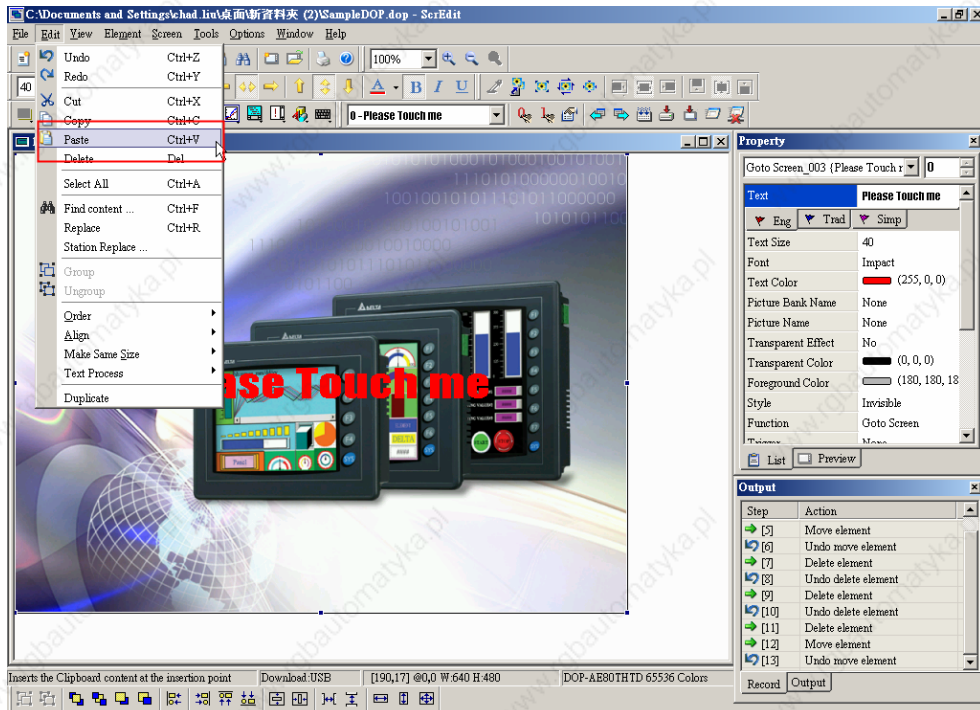


Fig. 2.4.10 Choosing Paste command from menu bar

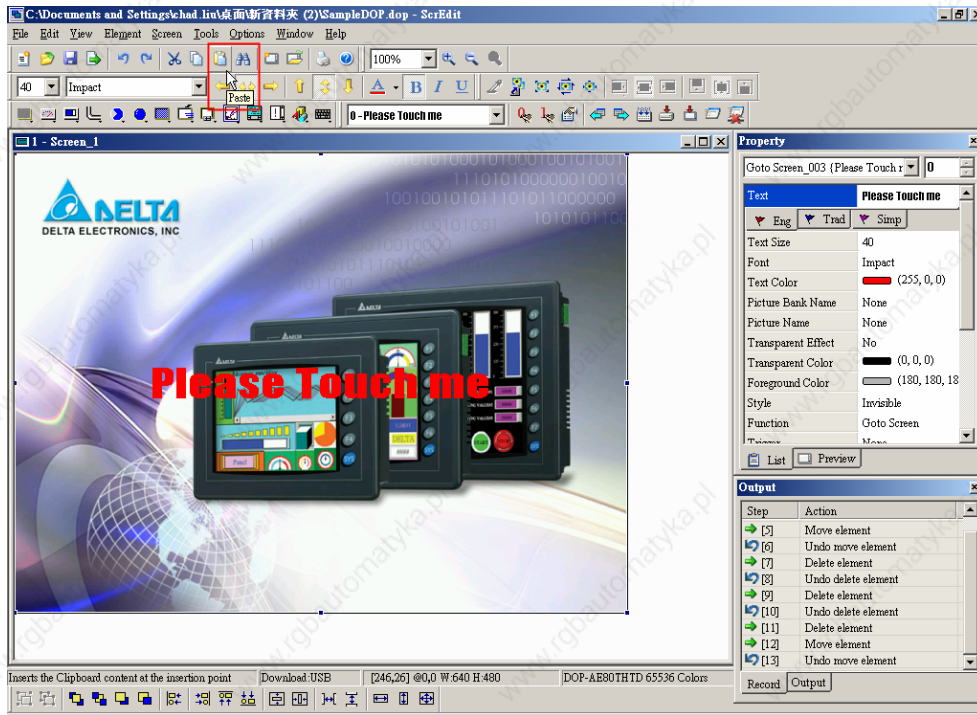


Fig. 2.4.11 Choosing Paste icon from toolbar

■ Delete



Delete selected element. Select this function by choosing **Edit > Delete** (Fig. 2.4.12) from menu bar or use keyboard shortcuts by pressing **Del**.

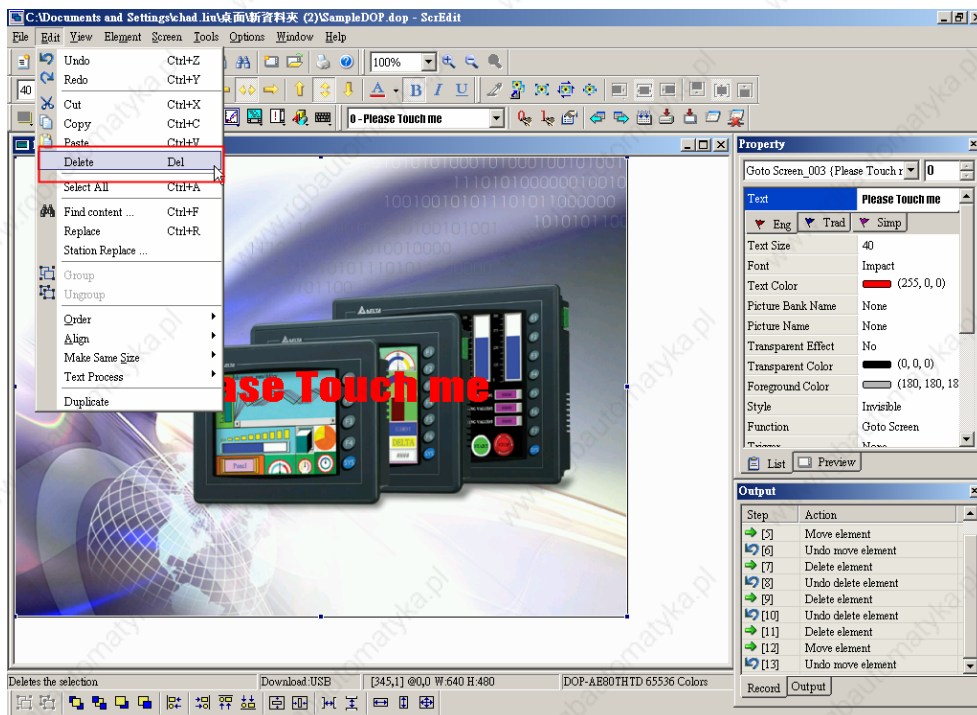


Fig. 2.4.12 Choosing Delete command from menu bar

■ **Select All**

Select All Ctrl+A

It is used to select all elements. Select this function by choosing **Edit > Select All** (Fig. 2.4.13) from menu bar or use keyboard shortcuts by pressing **Ctrl + A**. When selecting all, the element at the left upper corner will be selected with square filled with blue and white border as a base element. Others will be selected with square filled with white and black border. The base element is used to align or resize.

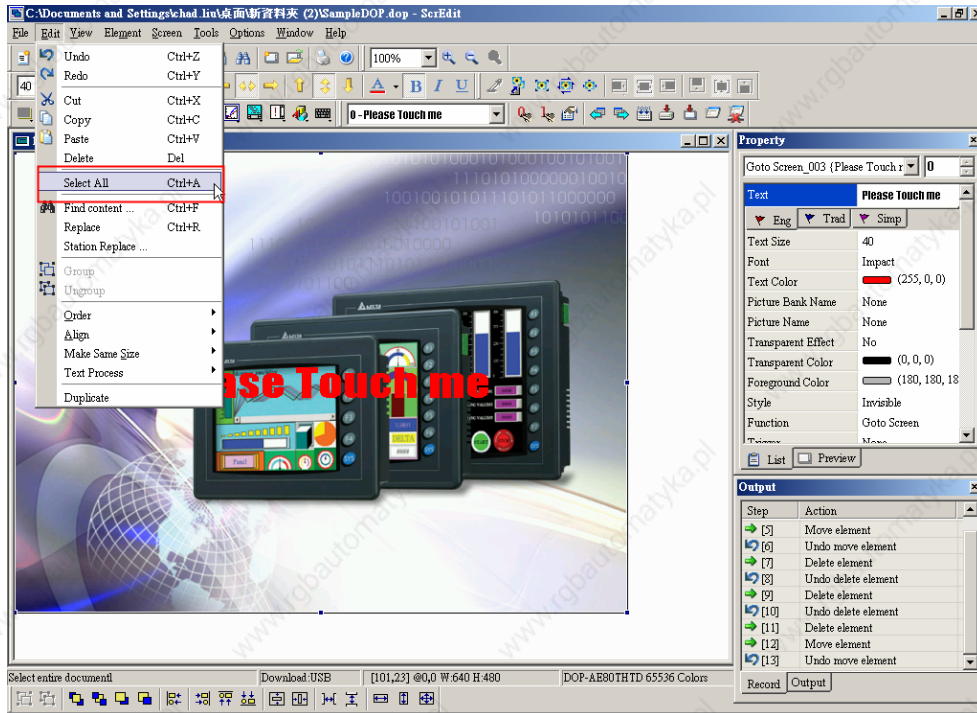


Fig. 2.4.13 Choosing Select All command from menu bar

■ **Find content**

Find content ... Ctrl+F

It is used to find the content matches the find criteria. Select this function by choosing **Edit > Find content** (Fig. 2.4.14) from menu bar or use keyboard shortcuts by pressing **Ctrl + F**. The users can find element text, read address, write address or memory address in current screen, or all screens (Fig. 2-4-15). Once it finds, the result of find content will be shown in the output window. Click some of the result of find content, it will jump to its location in ScrEdit.

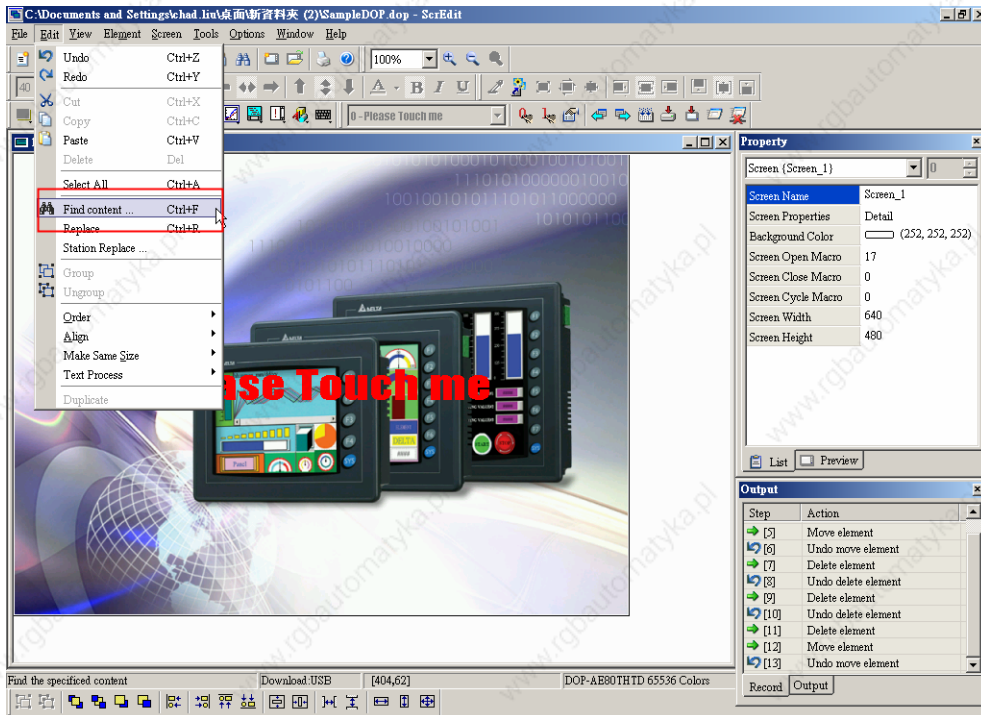


Fig. 2.4.14 Choosing Find content command from menu bar

Find content Options

Find

Find What

Options

Current Screen

All Screen

Type

Text

Read Address

Write Address

All Address

Match whole word only

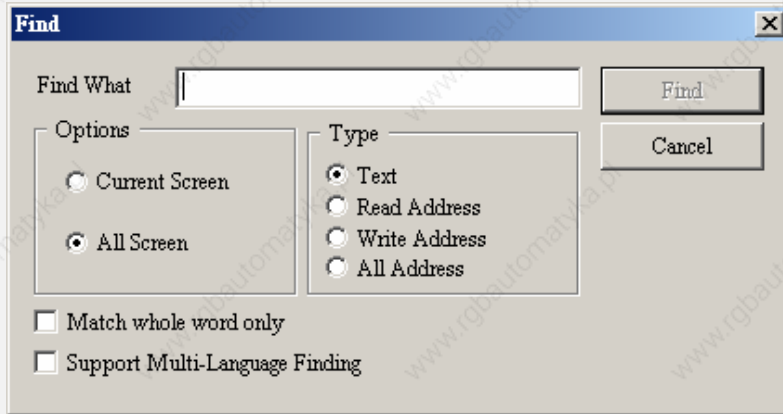
Support Multi-Language Finding

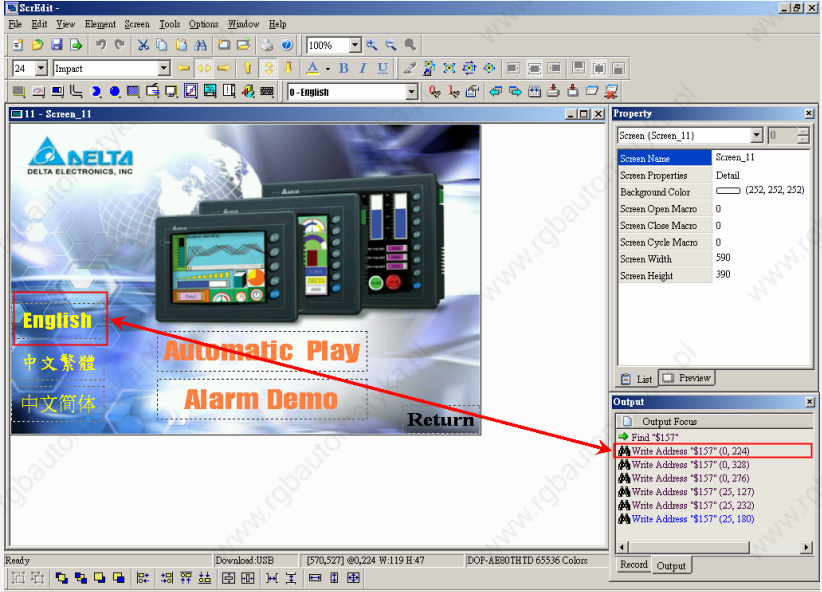
Find

Cancel

Find What	This field is where the users enter the word or phase that the users are looking for
-----------	--

Find content Options



Options	Current Screen	<p>This cause ScrEdit to navigate the current screen only and find the matching word or phase that the users are looking for. The output window will display all matching words or phases. When the users double click the word or phase, ScrEdit will jump to that location of the matching word or phase. Please refer to the example screen below.</p>  <p style="text-align: center;">Fig. 2.4.15</p>
	All Screen	<p>This cause ScrEdit to navigate all screens and find the word or phase that the users are looking for. The output window will display all matching words or phases. When the users double click the word or phase, ScrEdit will also jump to that location of the matching word or phase.</p>
Type	Text	<p>This cause ScrEdit to find the text that the users type only.</p>
	Read Address	<p>This cause ScrEdit to find the read address that the users type only.</p>
	Write Address	<p>This cause ScrEdit to find the write address that the users type only.</p>
	All Address	<p>This cause ScrEdit to find the read and write address that the users type only.</p>
Check Box	<p>If “Match whole word only” this box is checked, only the exact word or phase that the users type will be found. If “Match whole word only” this box is not checked, all words that contain the word or phase that the users type will be found.</p> <p>If “Support Multi-Language Finding” this box is checked, all multi language words that contain the word or phase that the users type will be found. However, “Support Multi-Language Finding” option can only be enabled when the find content type is text.</p>	

■ Replace

Replace Ctrl+R

It is used to replace the content matches the replace criteria. Using this command can replace text, read address and write address in current screen or all screens. Its function is very similar to Find command expect that it not only can find the word or phase that the users are looking for but also can replace it with a new entry. The replace content type could be text, read and write address and the replace content data type could be Bit, Word or Double Word. The function of replace content data type is enabled only when the replace content type is either read or write address. Select this function by choosing **Edit > Replace** (Fig. 2.4.16) from menu bar or use keyboard shortcuts by pressing **Ctrl + R**.

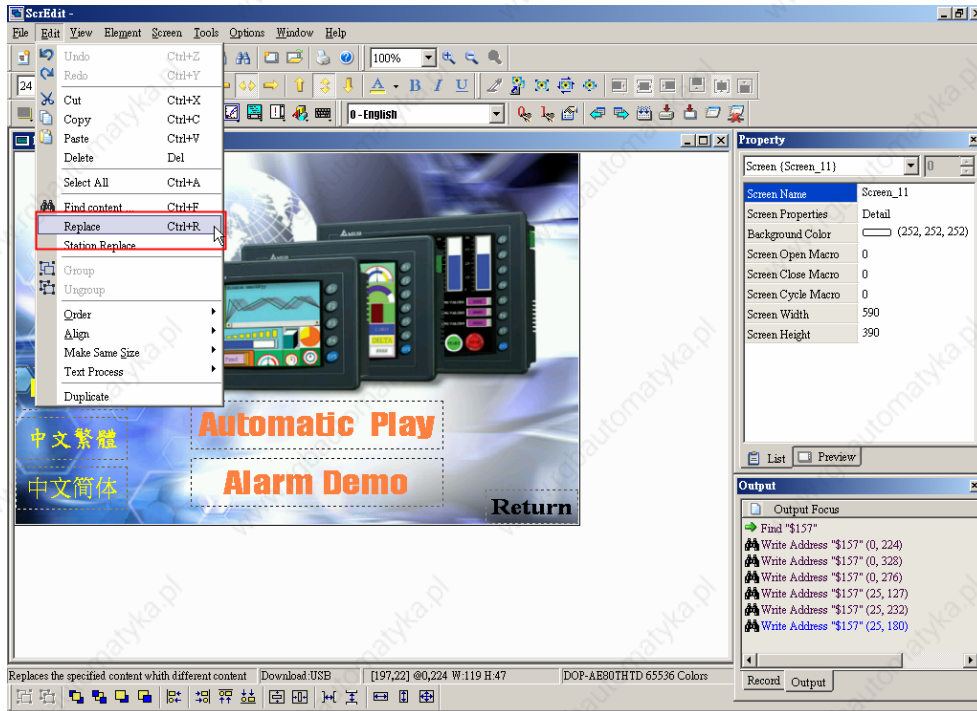


Fig. 2.4.16 Choosing Replace command from menu bar

Replace Options

Replace

Find What:

Replace With:

Options

Current Screen

All Screen

Type

Text

Read Address

Write Address

Data Type

Bit

WORD

DWORD

Replace

Replace All

Cancel

Find What	This field is where the users enter the word or phase that the users are looking for	
Replace With	This field is where the users enter the word or phase that the users want to replace with	
Options	Current Screen	This cause ScrEdit to navigate the current screen only, find the matching word or phase that the users are looking for and replace it.

2-38


Revision 05/30/2006, EH00

Replace Options

	All Screen	This cause ScrEdit to navigate all screens and find the matching word or phase that the users are looking for and replace it.
Type	Text	This cause ScrEdit to find and replace the text that the users type only.
	Read Address	This cause ScrEdit to find and replace the read address that the users type only.
	Write Address	This cause ScrEdit to find and replace the write address that the users type only.
Data Type	Bit	The function of replace content data type is enabled only when the replace content type is either read or write address. The replace content data type could be Bit, Word or Double Word.
	WORD	
	DWORD	
Replace Replace All	<p>Replace button is used to replace the word or phase that the users type and find and select the next one. For example, the users want to replace the write address from \$157 to \$158, enter \$157 in Find What field, enter \$158 in Replace With field and press Replace button. ScrEdit will find the matching word and press Yes button to replace the word.</p> <p>Replace All button is used to replace all found matching words automatically.</p>	

■ Group



It is used to group elements in ScrEdit. Select this function by choosing **Edit > Group** (Fig. 2.4.17) from menu bar or clicking the Group icon  from toolbar (Fig.2.4.18). When two or more elements are grouped, it will be regarded as a single unit and move together but the element size cannot be changed.

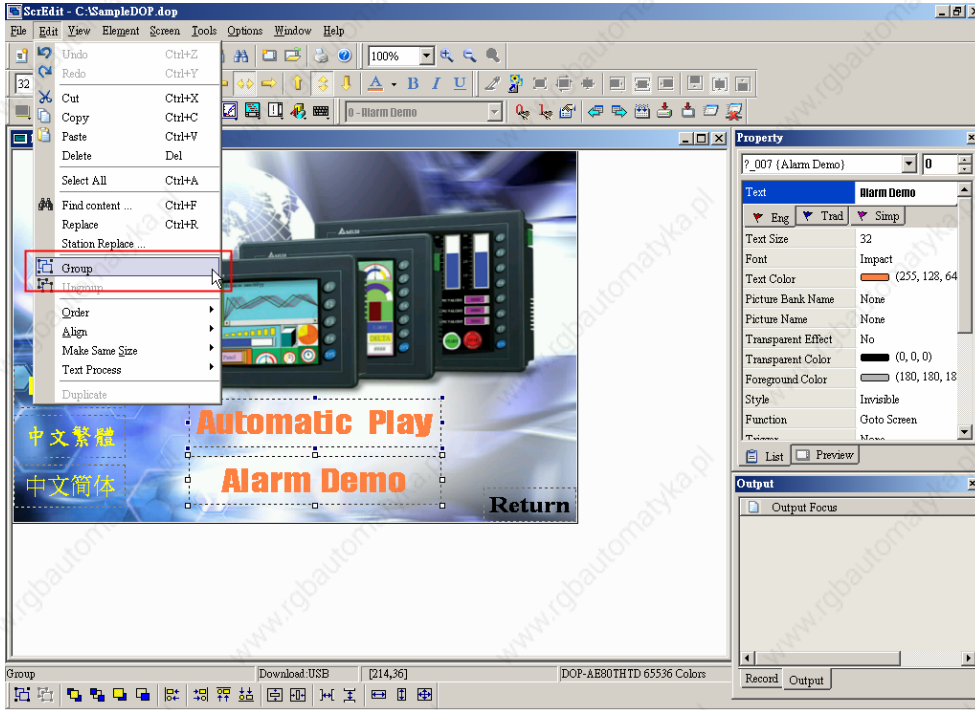


Fig. 2.4.17 Choosing Group command from menu bar

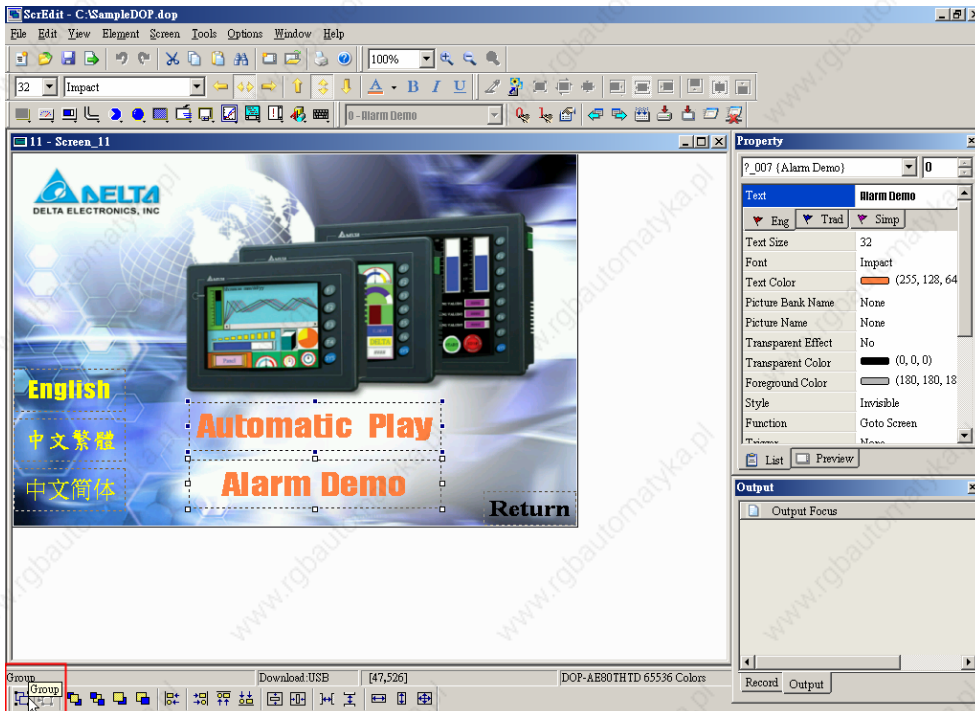



Fig. 2.4.18 Choosing Group icon from toolbar

■ Ungroup



It is used to ungroup elements in ScrEdit. Select this function by choosing **Edit > Ungroup** (Fig. 2.4.19) from menu bar or clicking the Group icon  from toolbar (Fig.2.4.20).

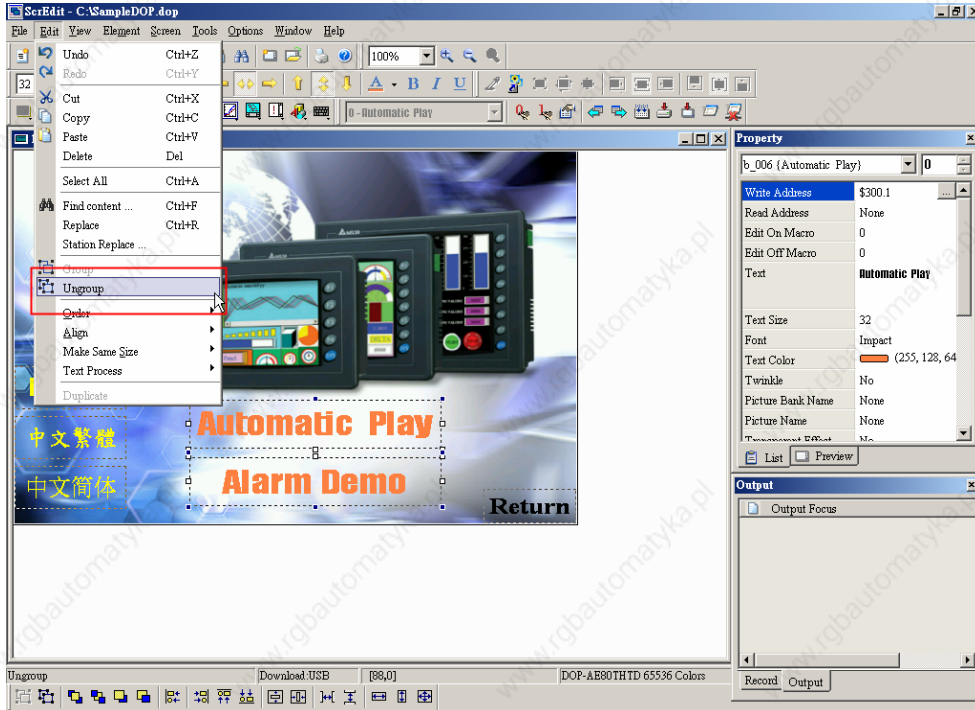


Fig. 2.4.19 Choosing Ungroup command from menu bar

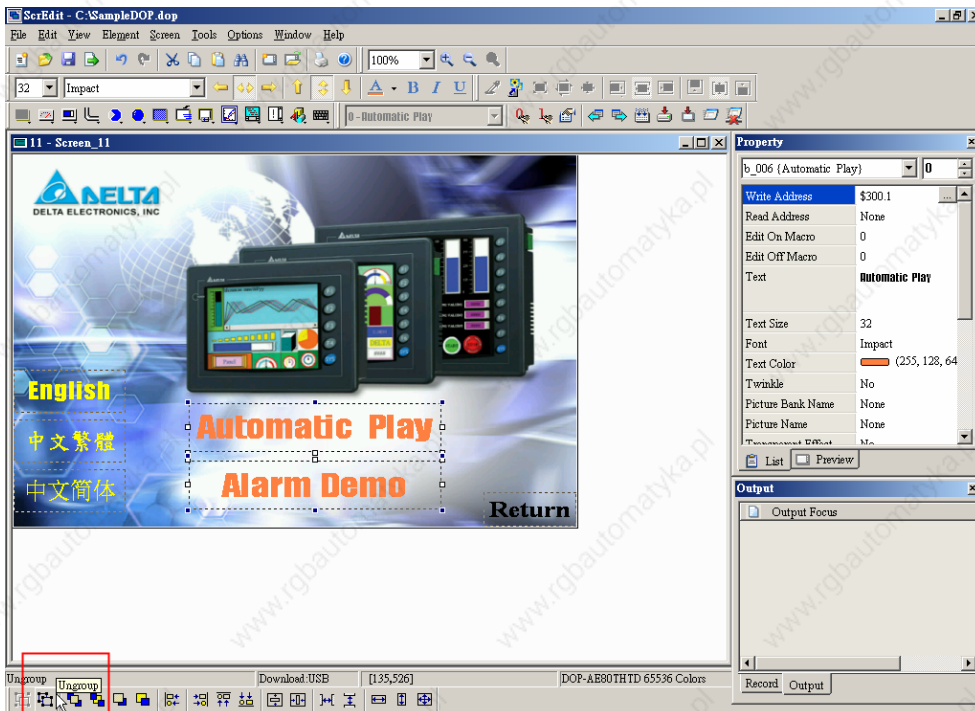



Fig. 2.4.20 Choosing Ungroup icon from toolbar

■ Order

Order

It is used to set and change the stacking order of the selected element. Select this function by choosing **Edit > Order** (Fig. 2.4.21) from menu bar or clicking the Order icons  from toolbar (Fig.2.4.22).



Bring to Top. Move the selected element to the front of all other elements.



Send to Bottom. Move the selected element behind all other elements.



Bring Forward. Move the selected element forward one position.



Send Backward. Move the selected element behind one position.

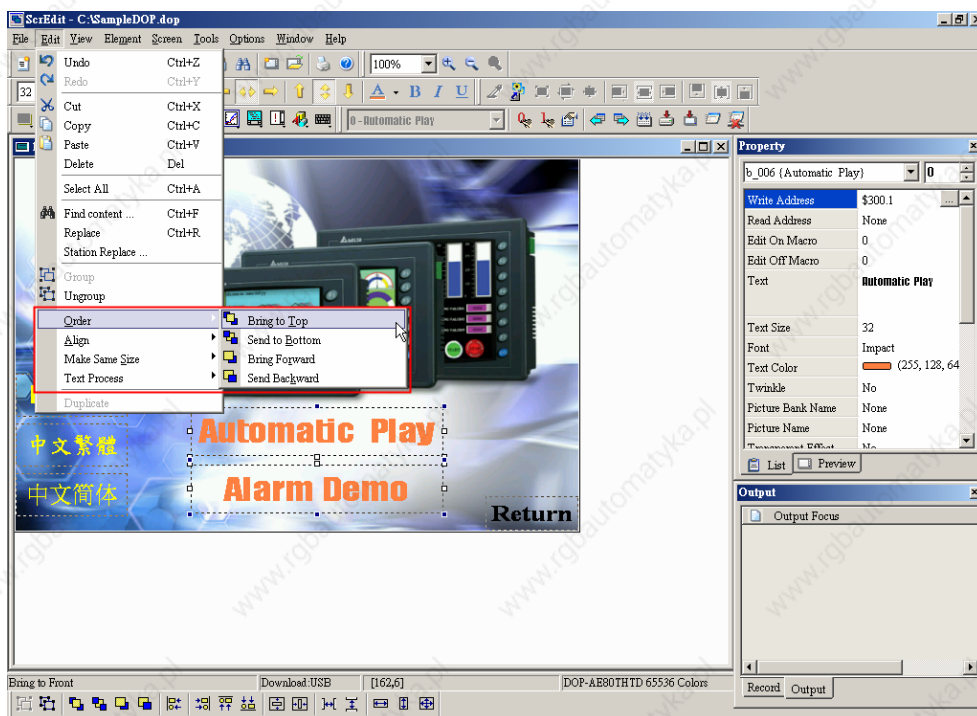


Fig. 2.4.21 Choosing Order commands from menu bar

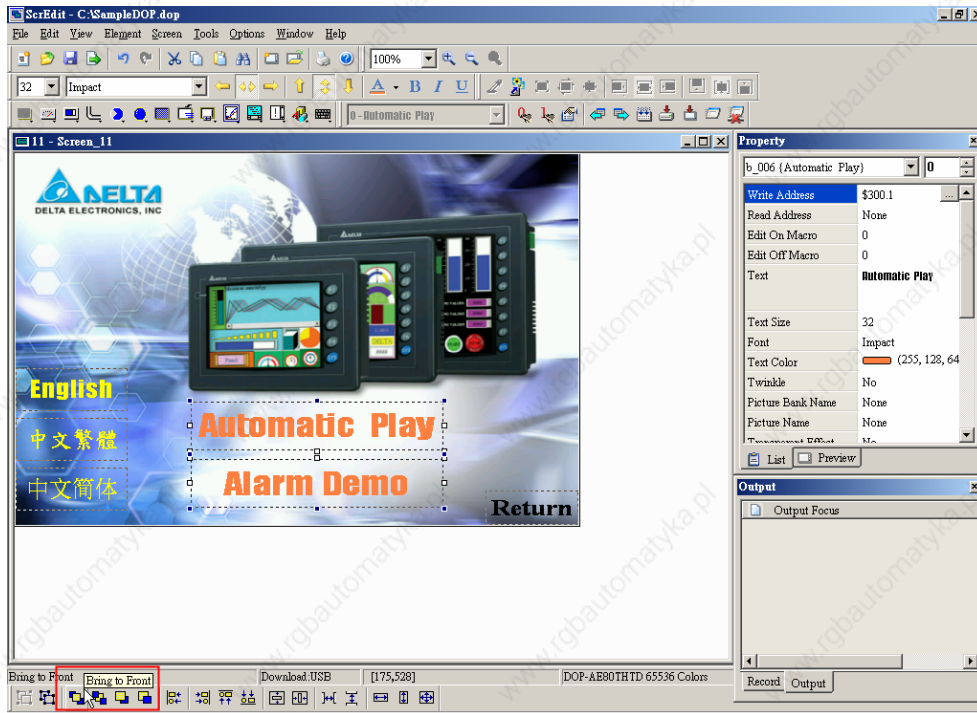










Fig. 2.4.22 Choosing Order icons from toolbar

■ **Align**



It is used to align the element. The users can select this function by choosing **Edit > Align** (Fig. 2.4.23) from menu bar or clicking the Align icons from toolbar (Fig.2.4.24).

The Align icons includes:

-  : Align Left;  : Align Right;  : Align Top;  : Align Bottom;
-  : Center Vertically;  : Center Horizontally;
-  : Space Evenly For Across;  : Space Evenly For Down.

Align Left, Align Right, Align Top and Align Bottom commands are available when two or more elements are selected. That is because the element only can be left, right, top and bottom aligned relative to another element. Align Vertical Center and Align Horizontal Center commands are available when one or more elements are selected. Across Space Evenly and Down Space Evenly are available when three or more elements are selected.

After Align commands are used, the coordinates of the elements will be changed to the coordinates of the new position.

Center Vertically: Set the element to be the vertical position of the work place.

Center Horizontally: Set the element to be the horizontal position of the work place.

Space Evenly For Across: Make all the elements align in a consistent width.

Space Evenly For Down: Make all the elements align in a consistent height.

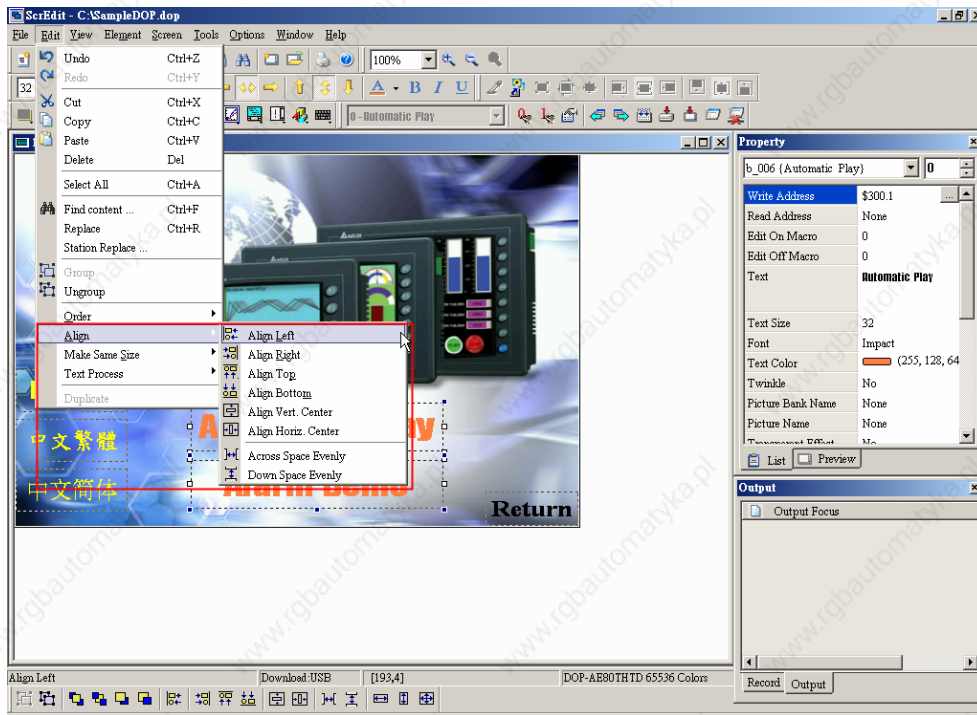


Fig. 2.4.23 Choosing Align commands from menu bar

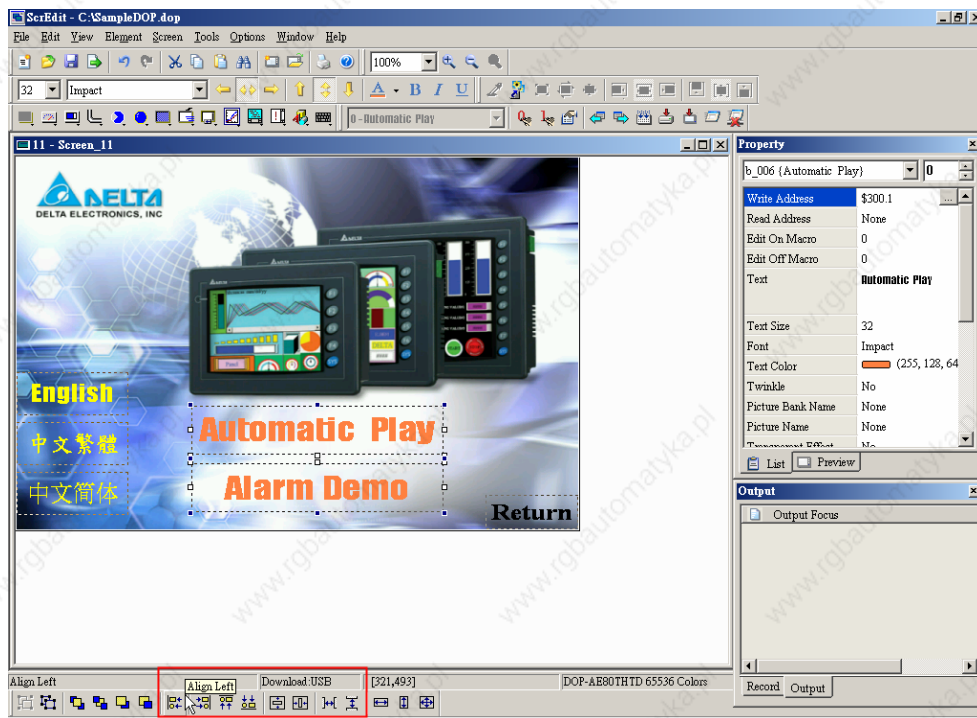


Fig. 2.4.24 Choosing Align icons from toolbar

■ Make Same Size

Make Same Size

It is used to make the element to be the same size. The users can select this function by choosing **Edit > Make Same Size** (Fig. 2.4.25) from menu bar or clicking the Make Same Size icons from toolbar (Fig.2.4.26).

This function is available only when two or more elements are selected. The users have to select one element first and treat it as standard, and use this command to make other two or more elements to be the same size.

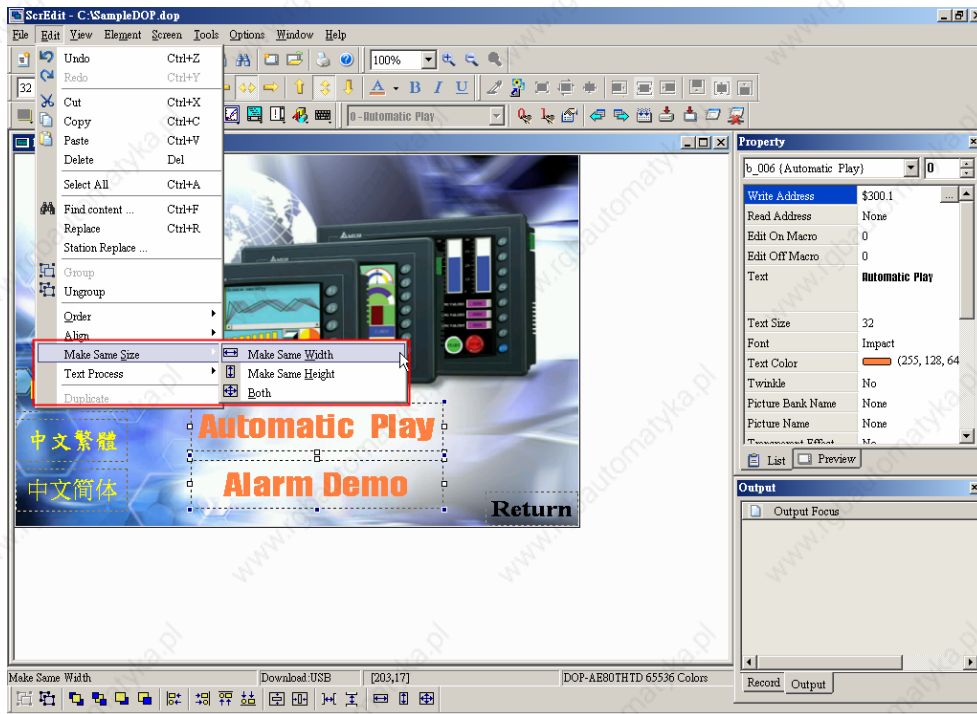


Fig. 2.4.25 Choosing Make Same Size commands from menu bar

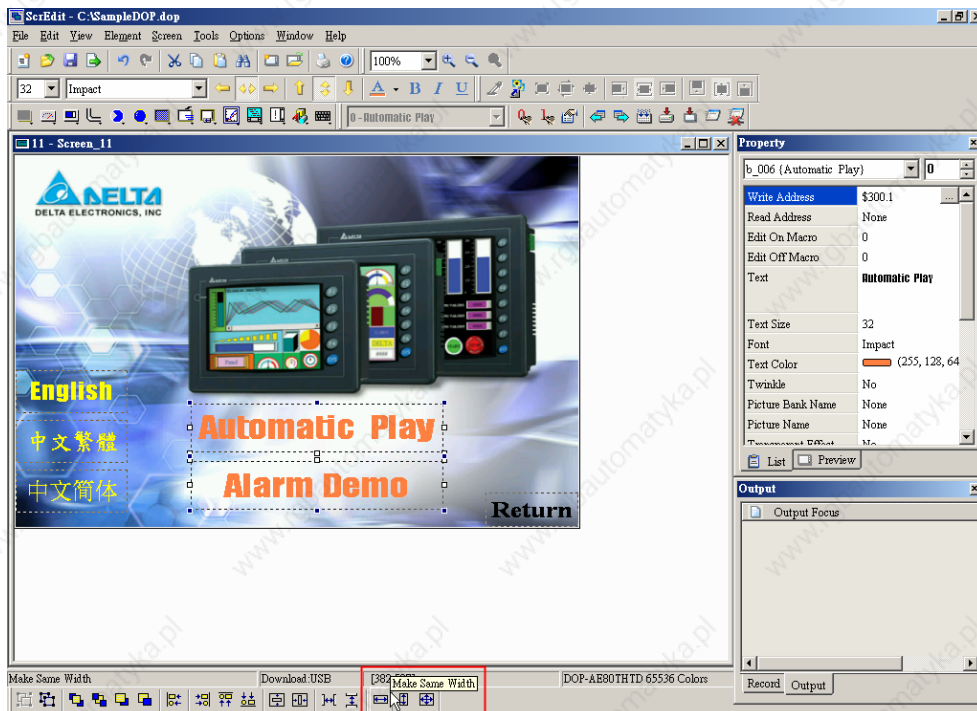


Fig. 2.4.26 Choosing Make Same Size icons from toolbar

■ Text Process

Text Process

It is used to set and change text direction and import text in ScrEdit. The users can select this function by choosing **Edit > Text Process** (Fig. 2.4.27) from menu bar or clicking the Text Process icons from toolbar.

next to the Text Process command represents that this function is enabled. In the Import Text dialog box, the users can decide if use Text Bank Edit Font or not. If the users check the box next to Text Bank Edit Font, the imported text will be display by adopting the fonts of Text Bank. For the settings of Text Bank, please refer to **Option > Text Bank**.

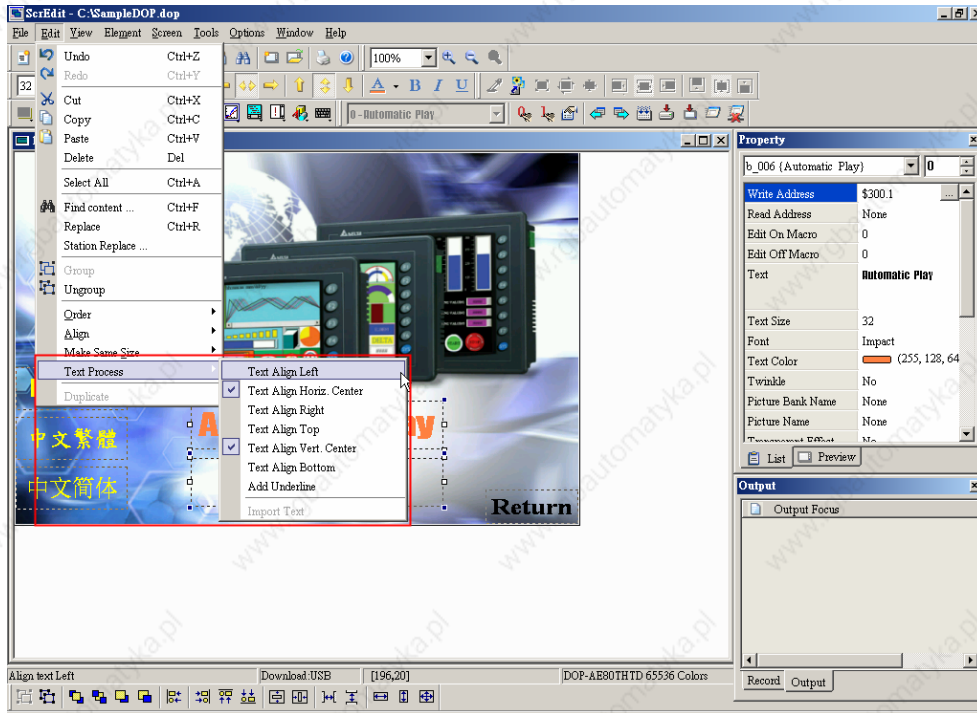


Fig. 2.4.27 Choosing Text Process commands from menu bar

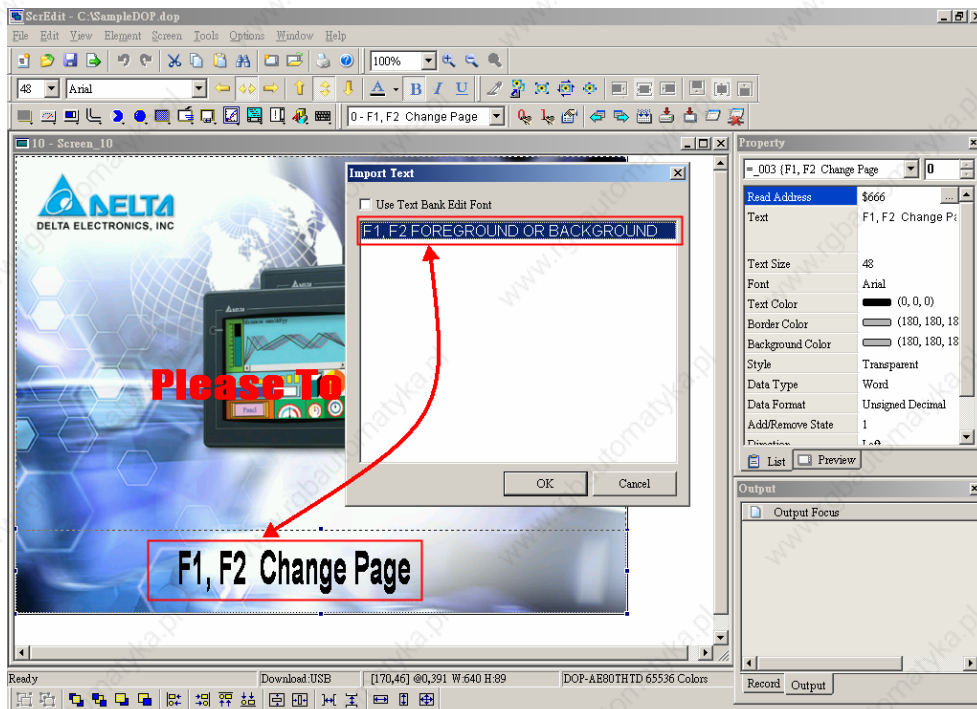


Fig. 2.4.28 Import Text dialog box

■ Duplicate

Duplicate

It allows the users to copy one or more elements at the same time. After selecting this function by choosing **Edit > Duplicate** from menu bar, the Fig. 2.4.29 dialog box will show up. The users can enter the number of columns and rows to get the total copy numbers. The minimum entry number should be more than 2 as the original element is also one of the total copy numbers. If the users only want to copy the number of Rows, please uncheck the box next to Columns and vice versa.

Spacing (pixels): This option is used to set the spacing between every element. After this option is set, the duplicated elements will be placed in this spacing.

Increase / Decrease Address: This option is used to place the element that the users copy by ascending or descending address. The unit of the address can be Word or Bit.

X-direction / Y-direction: This option is used to place the element that the users copy by horizontal (X-direction) or vertical (Y-direction) direction.

Please refer to Fig 2-4-30 and Fig. 2-4-31 for example.

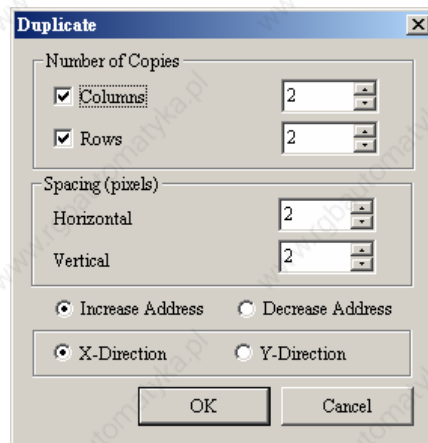


Fig. 2.4.29 Duplicate dialog box

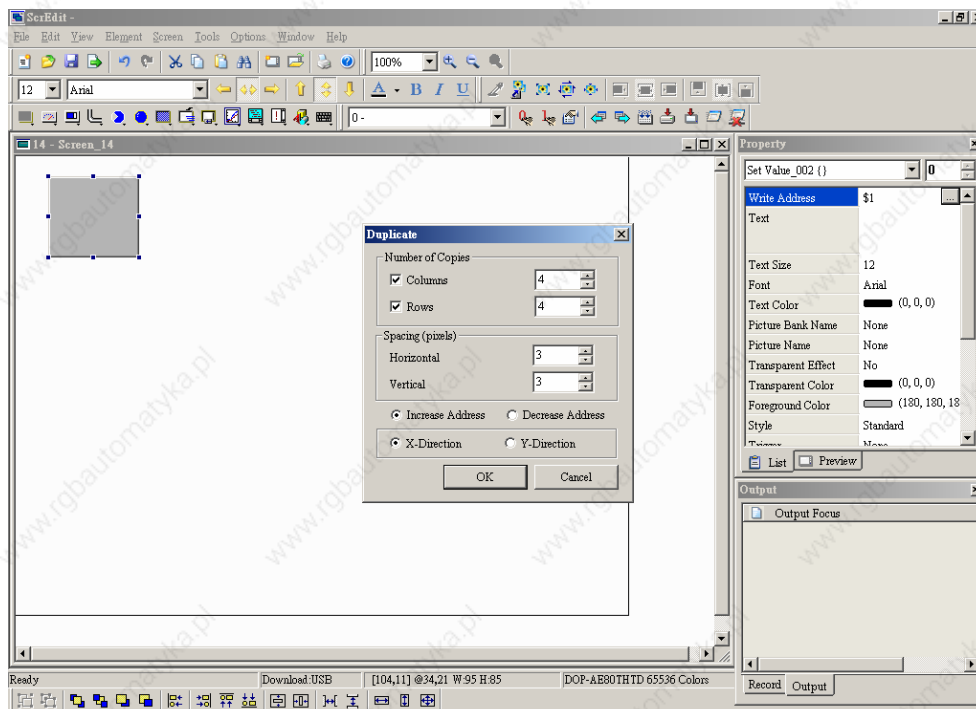


Fig. 2.4.30 Duplicate Example 1

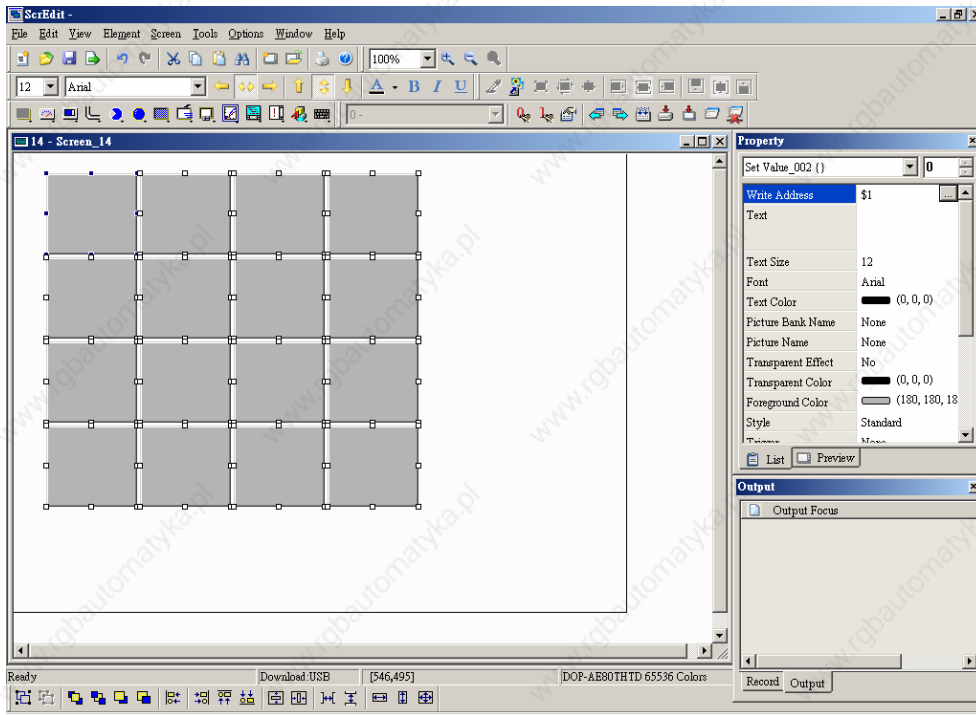


Fig. 2.4.31 Duplicate Example 2

2.5 Menu Bar and Toolbar (View)

View

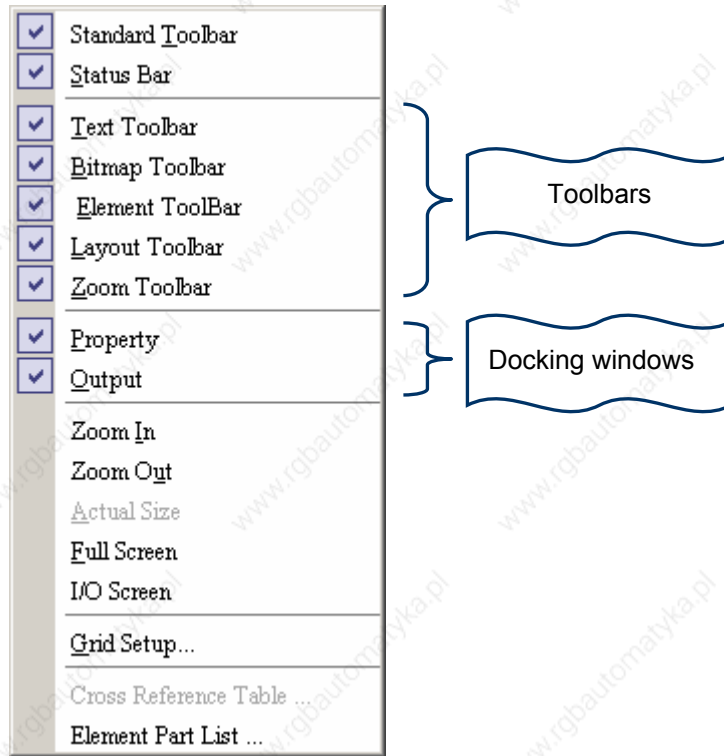


Fig. 2.5.1 View options

In View options, the users can decide how toolbars and docking windows display. Once the users click it, it will have icon in front of it and display on screen. By default, the Property table and Output window should display on the right side of the screen. The users can also arrange these toolbars and docking windows by themselves (Fig. 2.5.2).

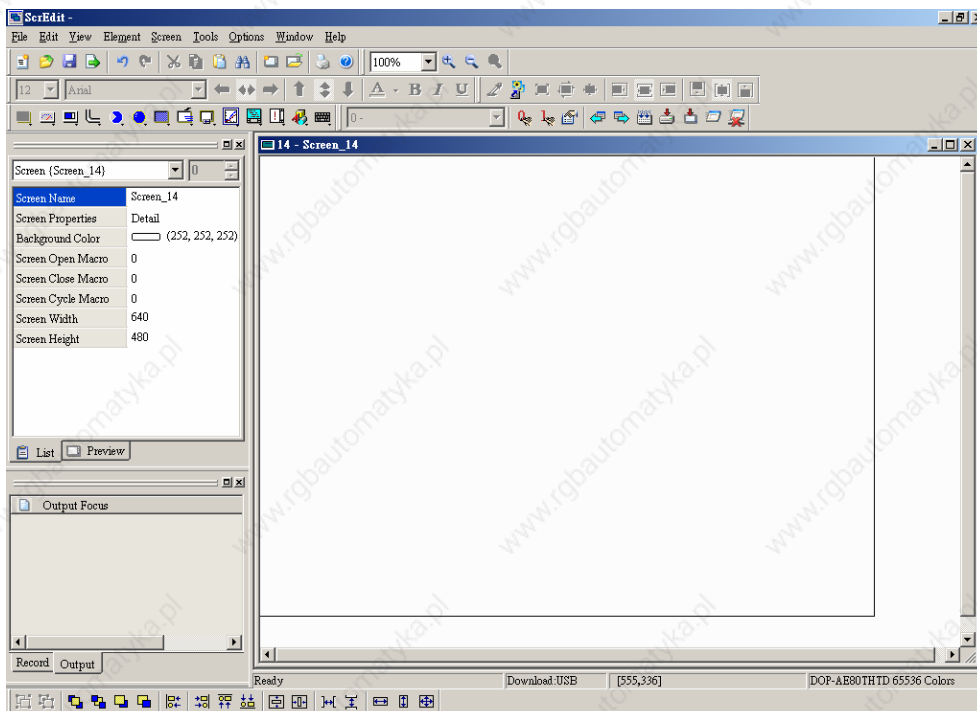


Fig. 2.5.2 Docking Windows

■ **Standard Toolbar**



Table. 2.5.1 Standard toolbar

Icon	Function	Description
	New	Create a new application
	Open	Open an old application
	Save	Save current edited application
	Export	Export an application to BMP format
	Undo	Undo an action (some can't be undo)
	Redo	Redo an action
	Cut	Cut selected elements
	Copy	Copy selected elements
	Paste	Paste the element you copy or cut
	Find Content	Find specific text, write address or read address
	New Screen	Create a new screen
	Open Screen	Open an old screen
	Print	Print current application
	Help	Screen editor version

■ **Status Bar**

Display current editing states.

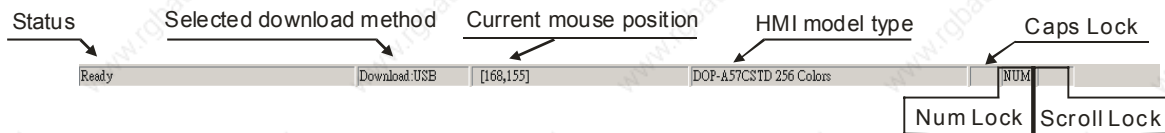











Fig. 2.5.3 Status bar

■ **Text Format Toolbar**



Table. 2.5.2 Text toolbar












Icon	Function	Description
	Font Size	Display and change text size

Icon	Function	Description
	Font	Font
	Aligns Left	Align text to left
	Center Horizontal	The space at the right/left sides of text will be the same
	Aligns Right	Align text to right
	Aligns Top	Align text to top
	Center Vertical	The space at the top/bottom sides of text will be the same
	Aligns Bottom	Align text to bottom
	Text Color	Change text color
	Bold	Text bold
	Italic	Text Italic
	Underline	Add line under text

■ **Bitmap Toolbar**



Table. 2.5.3 Bitmap toolbar

Icon	Function	Description
	Select Transparent Color	Use sucker tool to suck the color of the picture and determine the transparent color of the picture
	Change Mode for Process All State Picture	If this function is enabled (this icon is pressed), not only the current picture with current state but also all pictures with all states will be stretched, resized or aligned
	Picture Stretch All	Stretch the selected picture to the whole range of the element.
	Picture Stretch Ration 1: 1	Scale the picture relative to original picture size
	Picture Actual	Resize the selected picture to the actual picture size
	Picture Align Left	Align the selected picture to left
	Picture Align Horizontal Center	The space at the right/left sides of the selected picture will be the same
	Picture Align Right	Align the selected element to right
	Picture Align Top	Align the selected element to top
	Picture Align Vertical Center	The space at the top/bottom sides of the selected element will be the same
	Picture Align Bottom	Align the selected element to bottom

■ Element Toolbar

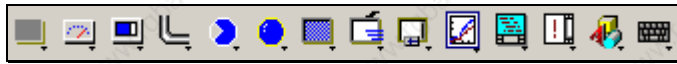























































































Table. 2.5.4 Element toolbar

Icon	Function	Drop-down Menu
	Button	<ul style="list-style-type: none">  Set  Reset  Momentary  Maintained  Multistate  Set Value  Set Constant  Increment  Decrement  Goto Screen  Previous Page <ul style="list-style-type: none">  System Date<u>T</u>ime  Password Table Setup  Enter Password  Contrast <u>B</u>rightness  Low Security  System Menu  Report List
	Meter	<ul style="list-style-type: none">  Meter(1)  Meter(2)  Meter(3)
	Bar	<ul style="list-style-type: none">  <u>N</u>ormal  <u>D</u>eviation
	Pipe	<ul style="list-style-type: none">  Pipe(1)  Pipe(2)  Pipe(3)  Pipe(4)  Pipe(5)  Pipe(6)  Pipe(7)
	Pie	<ul style="list-style-type: none">  Pie(1)  Pie(2)  Pie(3)  Pie(4)
	Indicator	<ul style="list-style-type: none">  <u>M</u>ultistate Indicator  <u>R</u>ange Indicator  <u>S</u>imple Indicator












Icon	Function	Drop-down Menu
	Display	<ul style="list-style-type: none">  Numeric Display  Character Display  Date Display  Time Display  Day-of-week Display  Prestored Message  Moving Sign
	Movement	<ul style="list-style-type: none">  State Graphic  Animated Graphic  Dynamic Line  Dynamic Rectangle  Dynamic Ellipse
	Input	<ul style="list-style-type: none">  Numeric Entry  Character Entry
	Curve	<ul style="list-style-type: none">  Trend Graph  X-Y Chart
	History	<ul style="list-style-type: none">  Historical Trend Graph  Historical Data Table  Historical Event Table
	Alarm	<ul style="list-style-type: none">  Alarm History Table  Active Alarm List  Alarm Frequency Table  Alarm Moving Sign
	Graphic	<ul style="list-style-type: none">  Line  Rectangle  Circle  Polygon  Arc  Text  Scale  Table
	Keypad	<ul style="list-style-type: none">  Keypad (1)  Keypad (2)  Keypad (3)

■ Build / Layout Toolbar

Build Toolbar










Table. 2.5.5 Build toolbar








Icon	Function	Description
	Current Element State	Text on selected element
	View State OFF/1	Switch and view current state OFF/1
	View State ON/1	Switch and view current state ON/1
	Display All Read/Write Address	Display all read/write addresses of all elements
	Previous windows	Select previous windows
	Next windows	Select the next windows
	Compile	Compile current element
	Download Screen Recipe	Download screen data and recipe
	Download Screen Data	Download screen data
	On-line Simulation	Test editing file at PC side and it needs to connect to PLC
	Off-line Simulation	Test editing file at PC side and it doesn't need to connect to PLC

Layout Toolbar



Table. 2.5.6 Layout toolbar

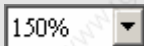



Icon	Function	Description
	Group	Group the selected elements
	Ungroup	Ungroup the selected elements
	Bring to Top	Move the selected element to the front of all other elements
	Send to Bottom	Move the selected element behind all other elements
	Bring Forward	Move the selected element forward one position
	Send Backward	Move the selected element behind one position
	Align Left	Align the selected elements to left
	Align Right	Align the selected elements to right
	Align Top	Align the selected elements to top
	Align Bottom	Align the selected elements to bottom

Icon	Function	Description
	Center Vertically	Set the element to be the vertical position of the work place
	Center Horizontally	Set the element to be the horizontal position of the work place
	Space Evenly For Across	Make all the elements align in a consistent width
	Space Evenly For Down	Make all the elements align in a consistent height
	Make Same Width	Make the selected elements to be the same width
	Make Same Height	Make the selected elements to be the same height
	Make Same Size	Make the selected elements to be the same size

■ **Zoom Toolbar**



Table. 2.5.7 Zoom toolbar

Icon	Function	Description
	Zoom level	Let you set a zoom level, including 25%, 50%, 75%, 100%, 150%, 200% and 300%
	Zoom in	Let you change the magnification level, including 150%, 200% and 300%.
	Zoom out	Let you reduce the magnification level, including 25%, 50% and 75%.
	1:1	Let you change element size to actual size (100%).

■ **Property Table**

Element property table. Please refer to Chapter 3 for detailed description.

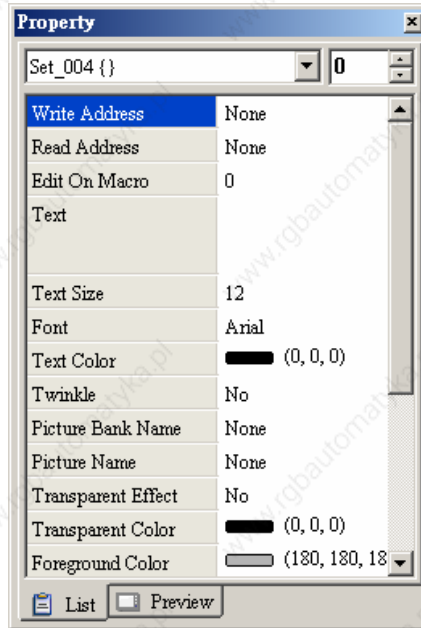


Fig. 2.5.4 Property table

■ **Output Window**

All editing actions and output message when compile function is enable will be shown here for users' reference. It is convenient for tracing error address when creating and editing screen (See Fig. 2.5.5, Fig. 2.5.6, Fig. 2.5.7 and Fig. 2.5.8).

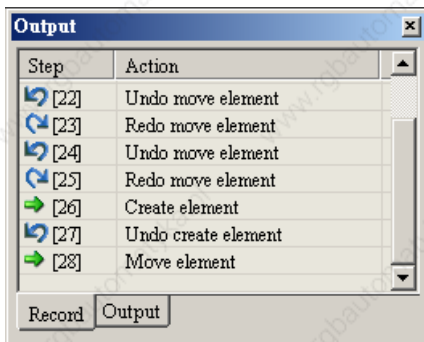


Fig. 2.5.5 Output window

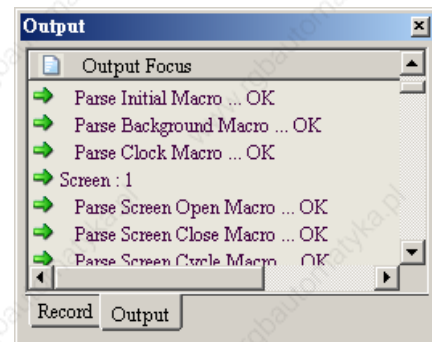


Fig. 2.5.6 Output window during editing

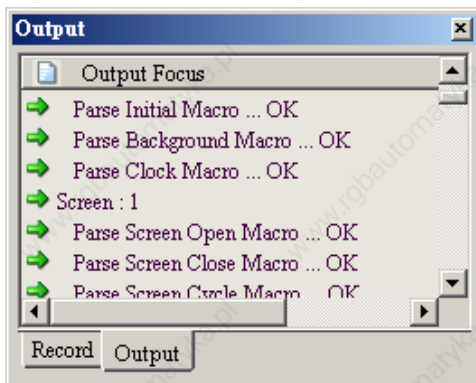


Fig. 2.5.7 Output result

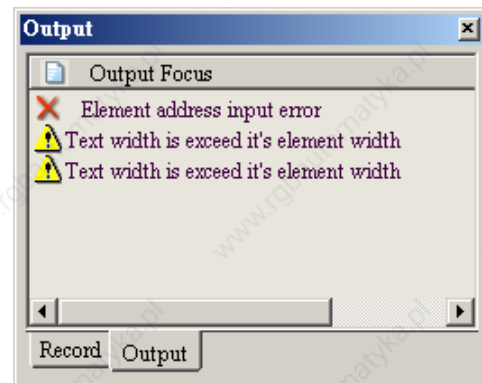


Fig. 2.5.8 Error output

■ Zoom In

Zoom In	Zoom in to get a close look at the elements on ScrEdit work place. (Refer to Fig. 2.5.9, Fig. 2.5.10, Fig. 2.5.11 and Fig. 2.5.12)
---------	--

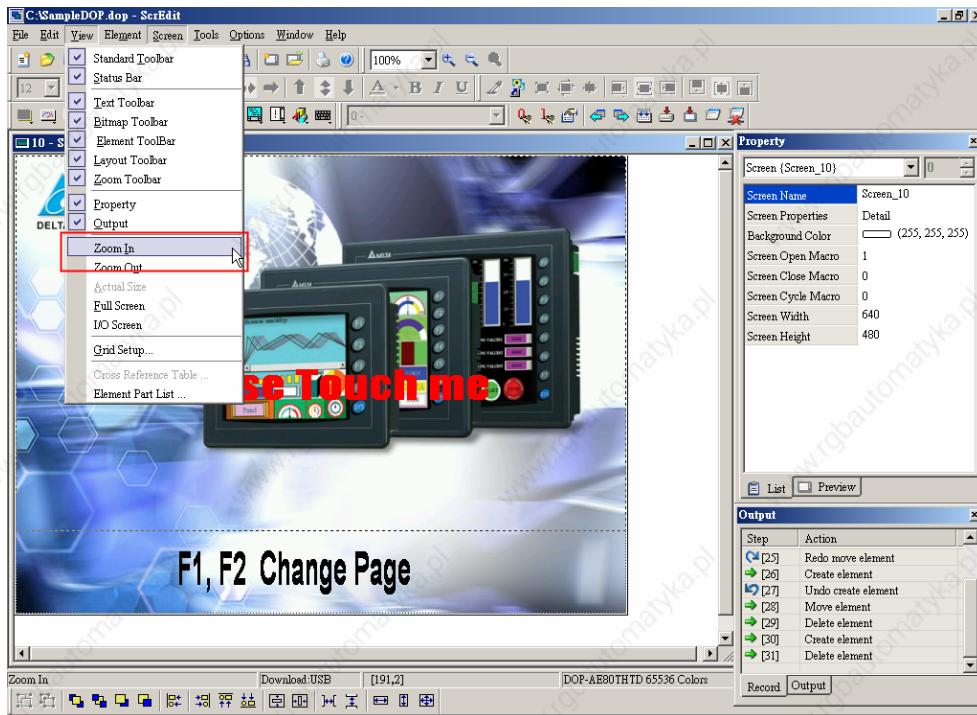


Fig. 2.5.9 Choosing Zoom In command from menu bar

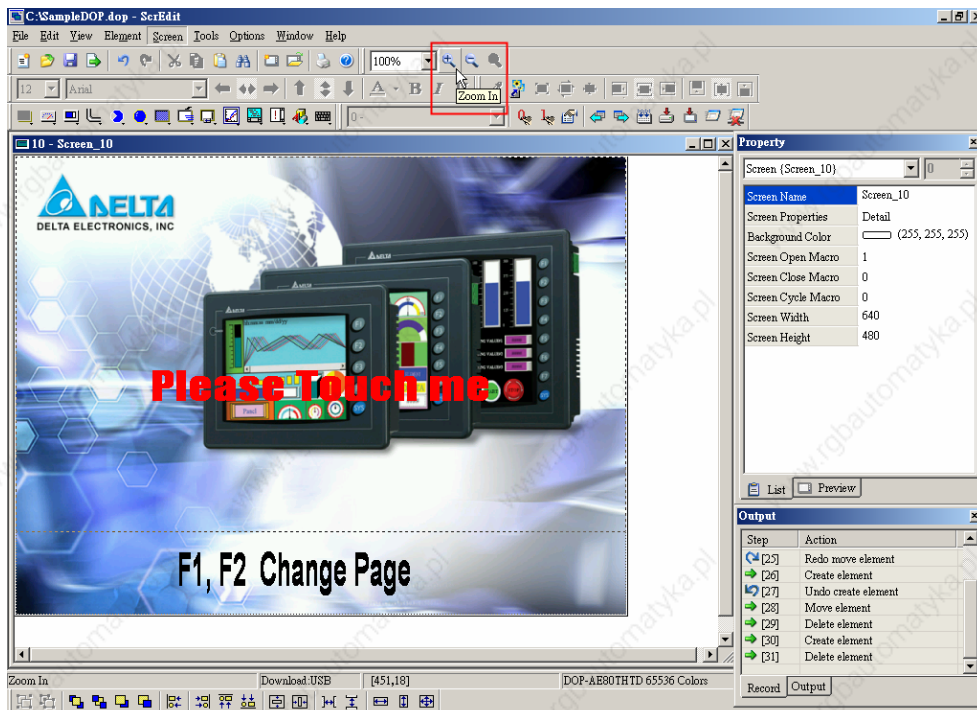


Fig. 2.5.10 Choosing Zoom In icon from toolbar

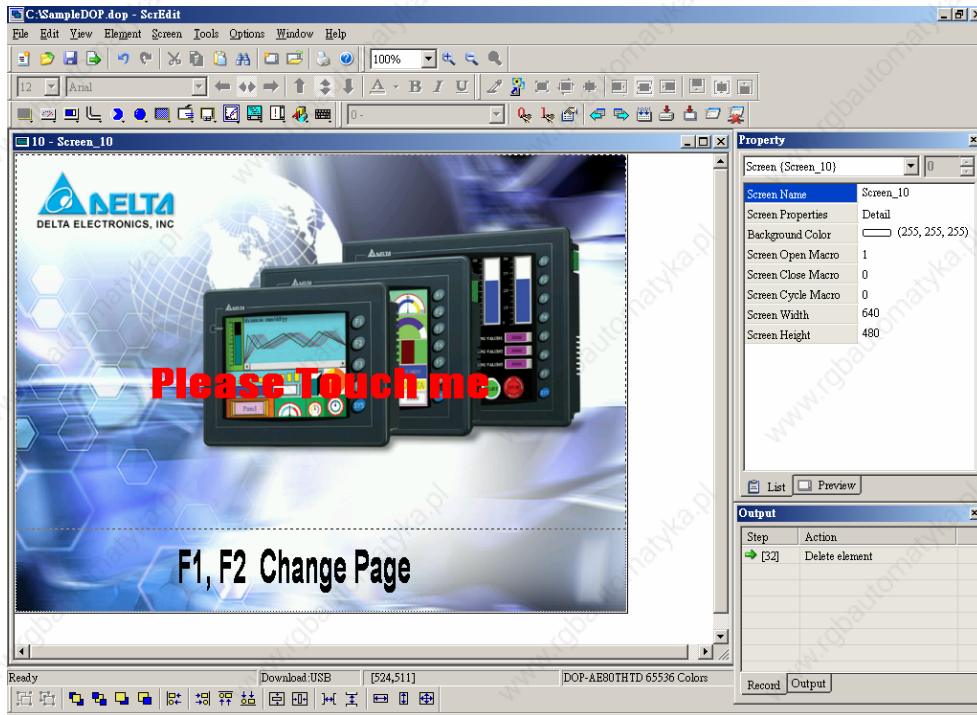


Fig. 2.5.11 Zoom level = 100% (Before Choosing Zoom In command)

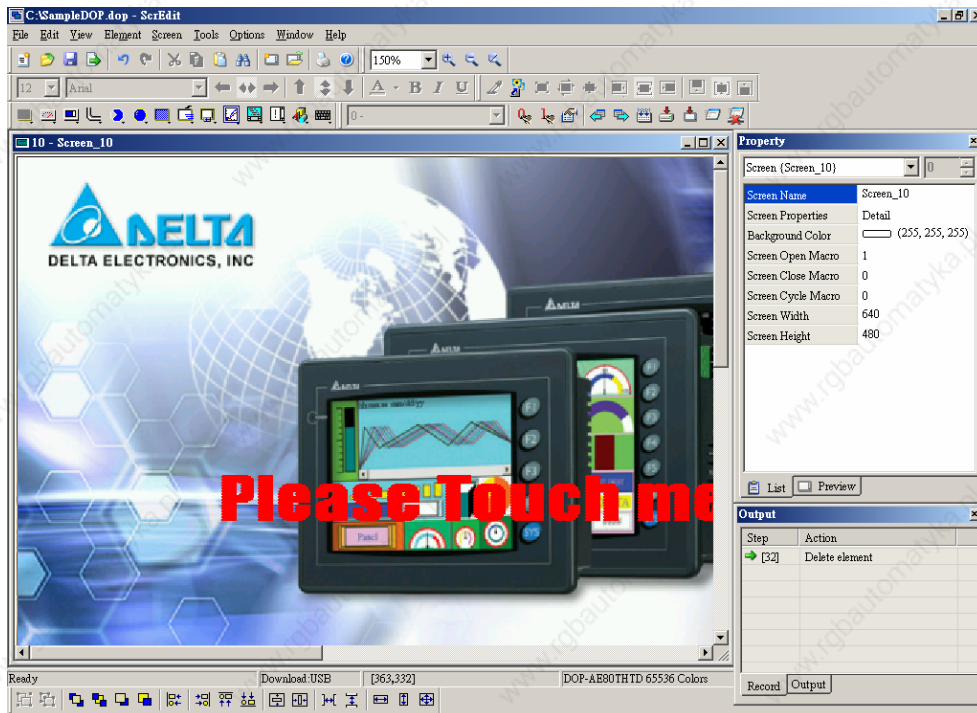


Fig. 2.5.12 Zoom level = 150% (After Choosing Zoom In command)

■ Zoom Out

Zoom Out

Zoom out to see more look of the elements on ScrEdit work place. (Refer to Fig. 2.5.13, Fig. 2.5.14 and Fig. 2.5.15)

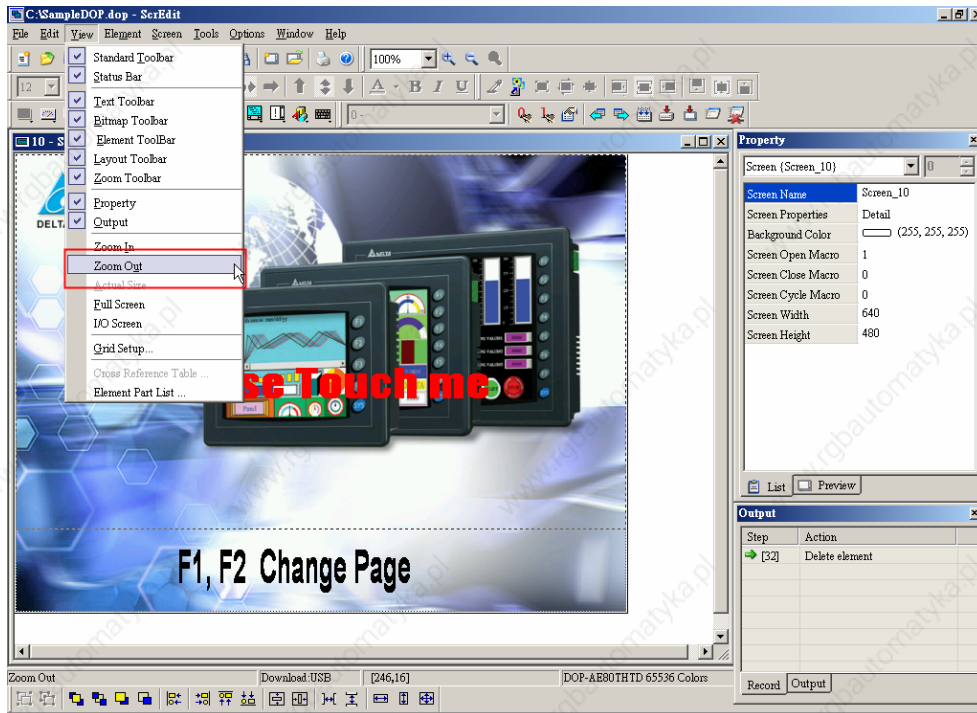


Fig. 2.5.13 Choosing Zoom Out command from menu bar

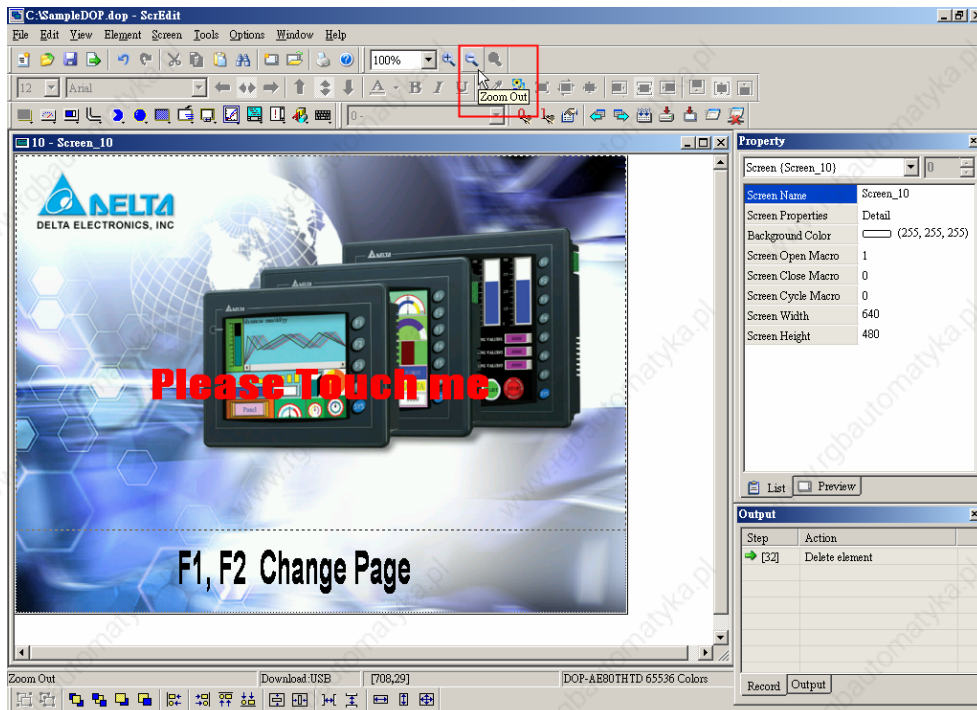


Fig. 2.5.14 Choosing Zoom Out icon from toolbar

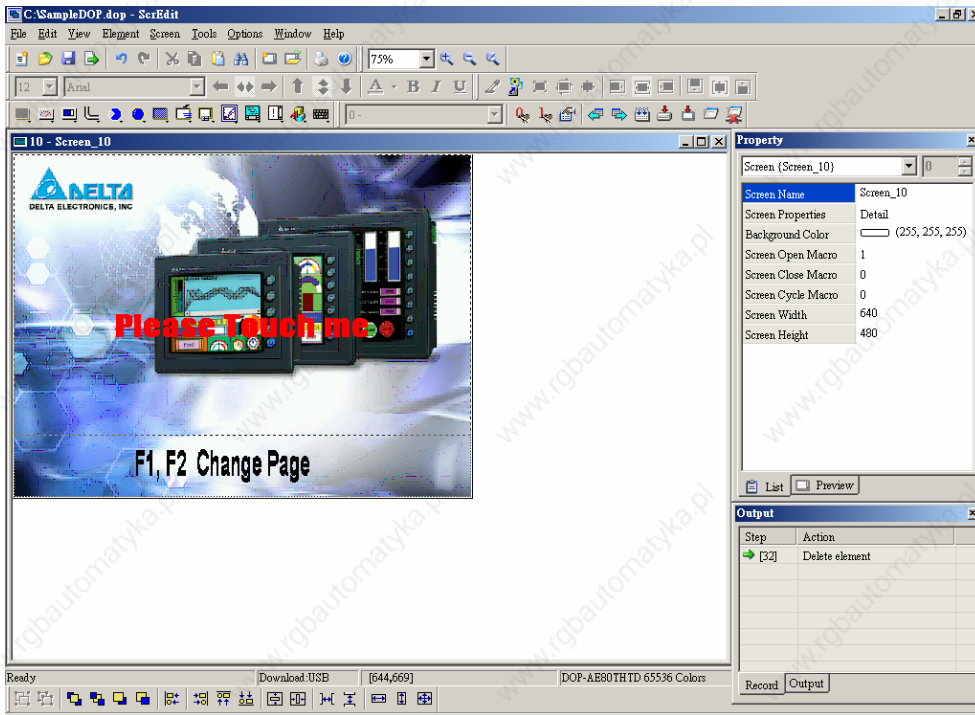




Fig. 2.5.15 Zoom level = 75% (After Choosing Zoom Out command)

■ **Actual Size**

Actual Size

Return to actual size (100%). This size is relative to the screen size of HMI.

No matter zoom in or zoom out command, the zoom level could be 20%, 50%, 75%, 100%, 150%, 200% and 300%. The users can also zoom in or out by clicking icon  or  or selecting the Zoom level directly (Fig. 2.5.16).

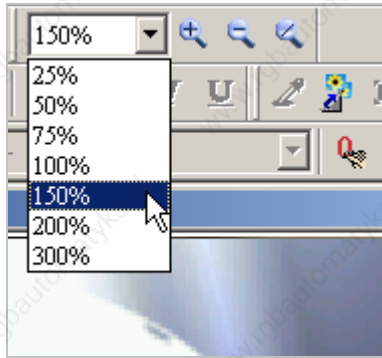


Fig. 2.5.16 Zoom level

■ **Full Screen**

Full Screen

As Fig. 2.5.17. Full screen provides maximum view to edit in ScrEdit. Full screen view will hide all toolbars and docking windows other than the ScrEdit work place itself. Fig. 2.5.17 full screen also shows the reference macro command.



Fig. 2.5.17 Full Screen (Pressing Esc key or left-click the mouse can exit Full screen)

■ I/O Screen

I/O Screen

As Fig. 2.5.18. I/O screen also provides maximum view to edit in ScrEdit just like Full screen. But the difference is that I/O Screen will show the read and write addresses of the element and also shows the reference macro command.



Fig. 2.5.18 I/O Screen (Pressing Esc key or left-click the mouse can exit Full screen)

■ Grid Setup

Grid Setup...

Grid Setup is a function that can help the users to align and position the element more easily and precisely. The distance (spacing) between the grid dots can be set by the users freely (Fig. 2.5.19 and Fig. 2.5.20).

Show Grid: Show the grid dots on the screen.

Snap to Grid: Make the elements snap to grid so that the elements can jump between grid lines when the users move them.

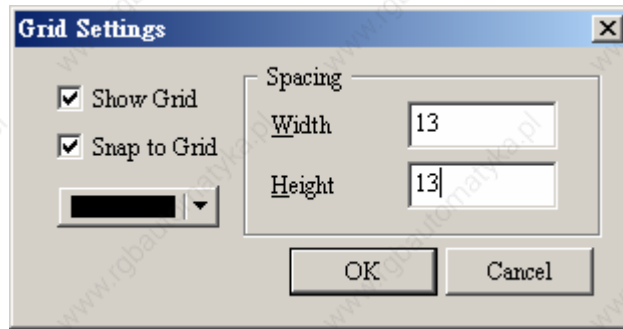


Fig. 2.5.19 Grid Settings dialog box

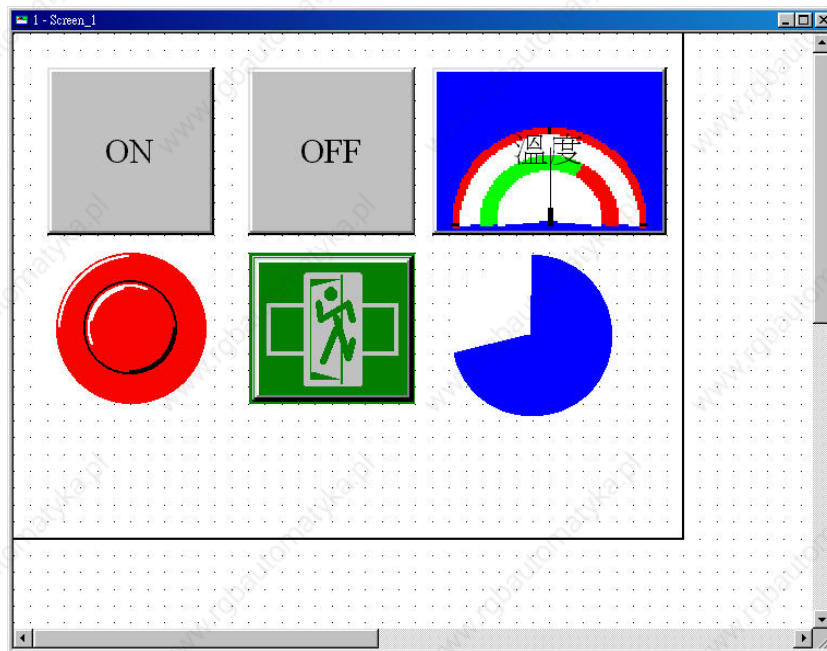


Fig. 2.5.20 Show Grid screen

2.6 Menu Bar and Toolbar (Element)

■ Element

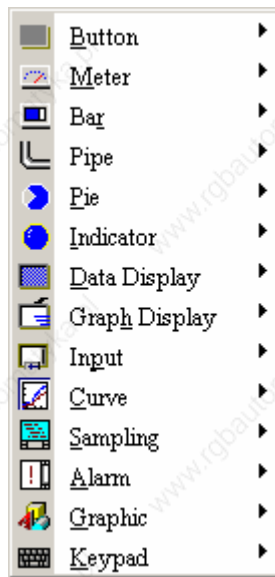


Fig. 2.6.1 Element options

Screen editor provides 14 types of elements and there are lots of styles for each type. These 14 types include button, meter, bar, pipe, pie, indicator, data display, graph display, input, curve, sampling, alarm, graphic and, keypad, etc. The users can select desired element from the pull-down menu and drag the size needed on ScrEdit work place (as Fig. 2.6.2 and Fig. 2.6.3).

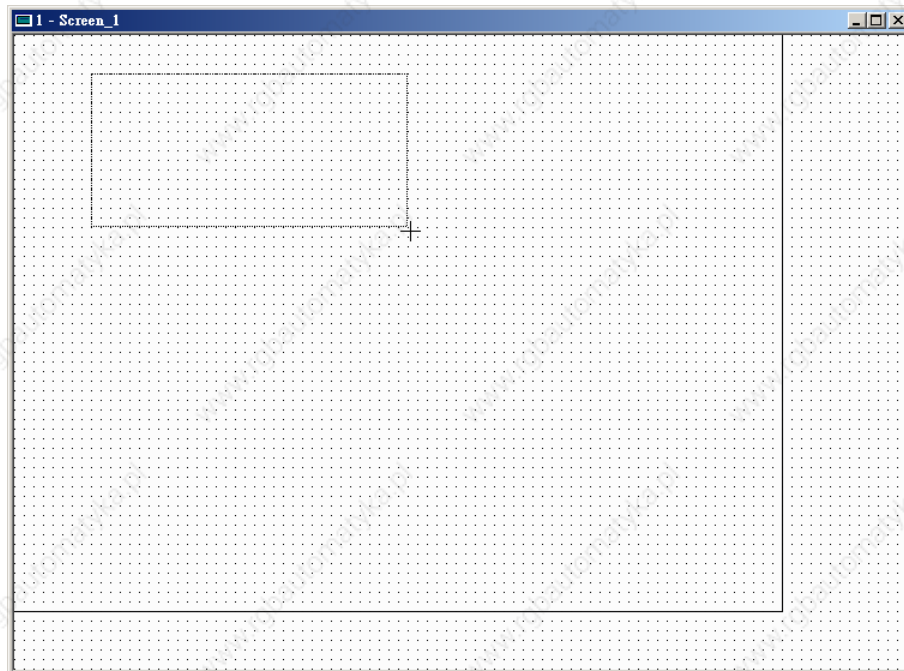


Fig. 2.6.2 Drag mouse to determine the element size

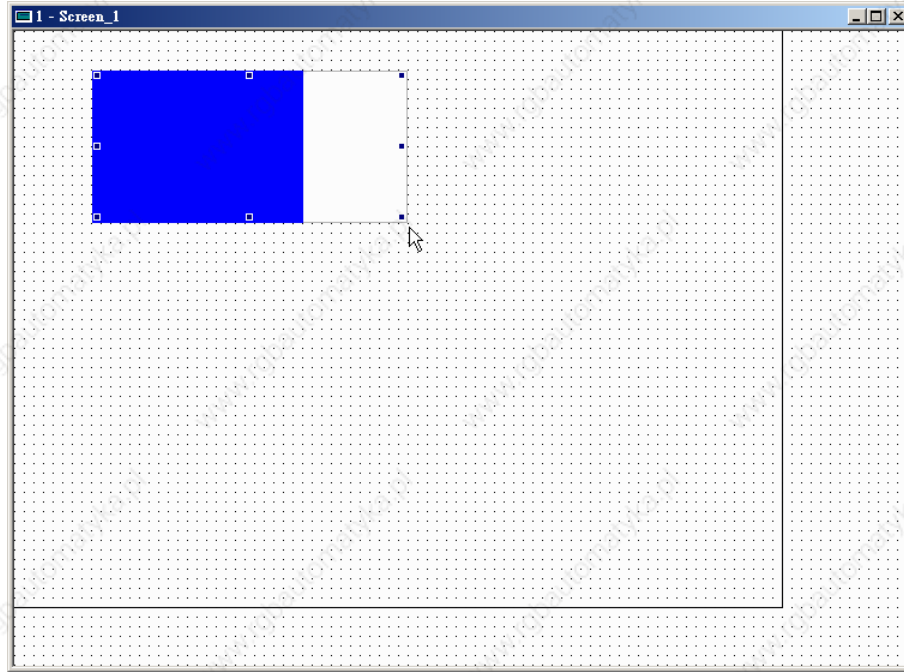


Fig. 2.6.3 Element display (Create an element)

The users can also right-click the mouse to select the desired element. For the property of each element, please refer to Chapter 3 for detailed description.

■ **Create an Element**

The users can select an element by right-clicking the mouse in work place. Place your mouse pointer in work place and right-click the mouse to get pull-down menu. Then, the users can select the desired element and determine the element size by left-clicking the mouse. Later set the property of the element (Fig. 2.6.4, Fig. 2.6.5, Fig. 2.6.6 and Fig. 2.6.7).

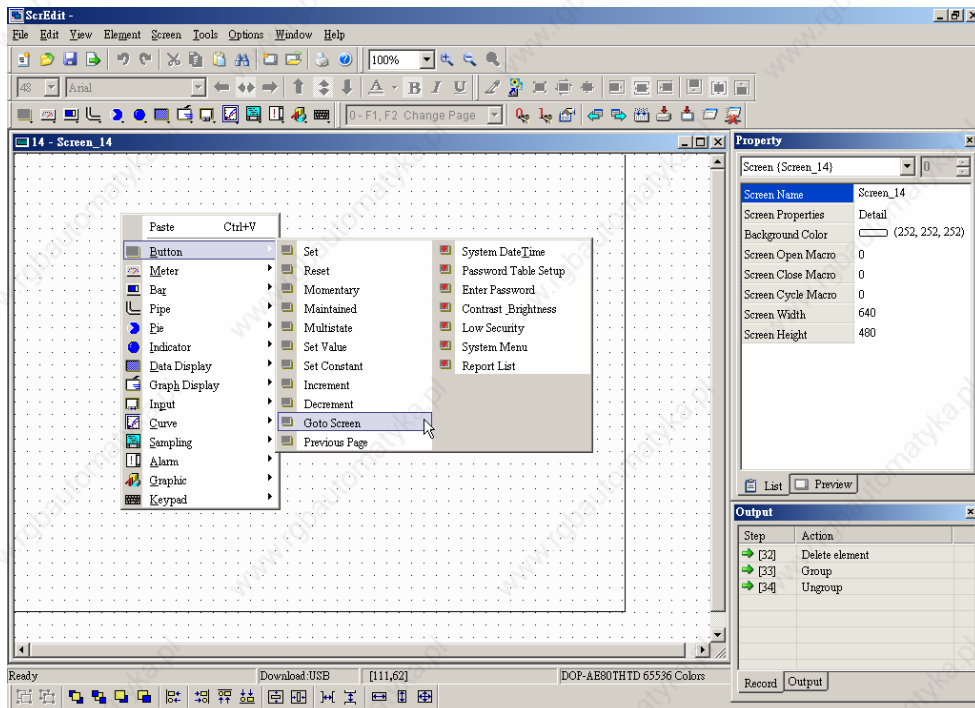


Fig. 2.6.4 Right-click the mouse to select the element

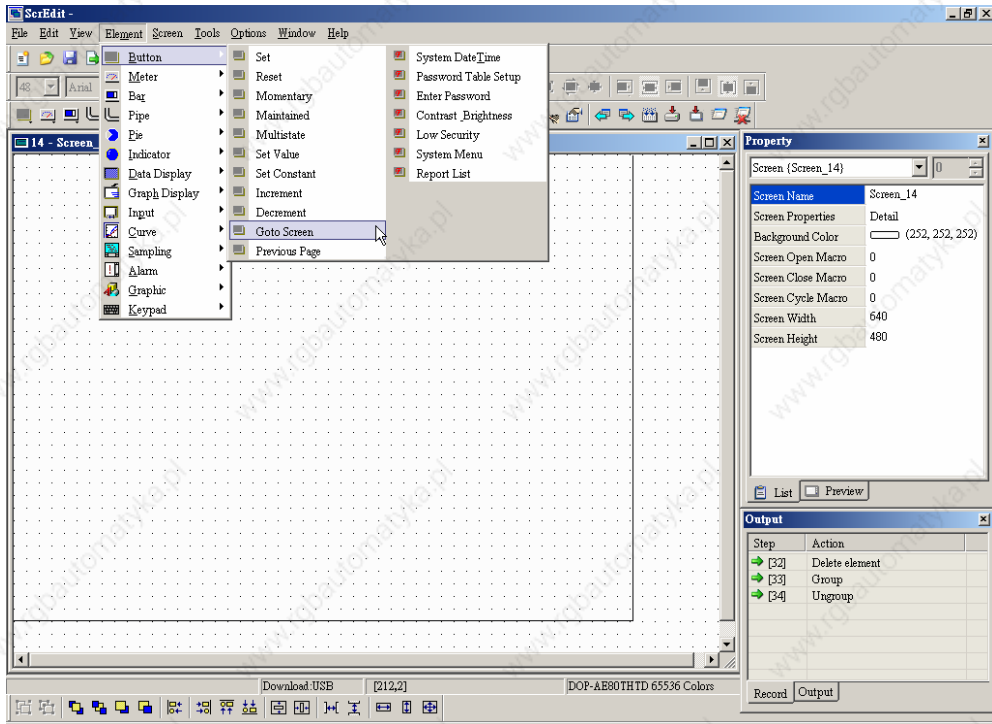


Fig. 2.6.5 Select an element by choosing Element command from menu bar

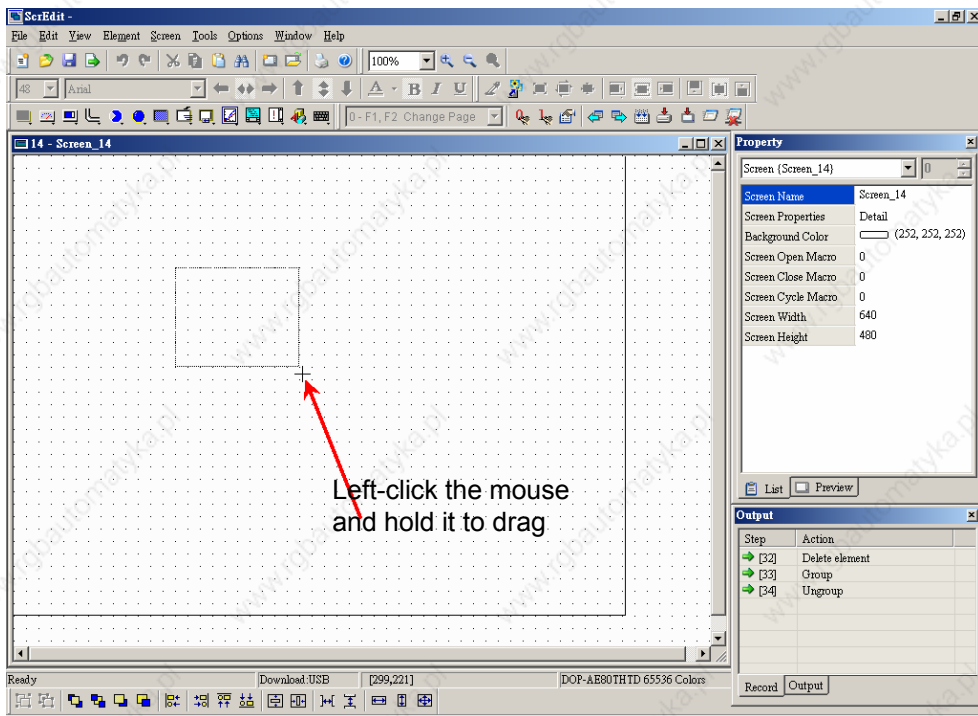


Fig. 2.6.6 Drag with left mouse button

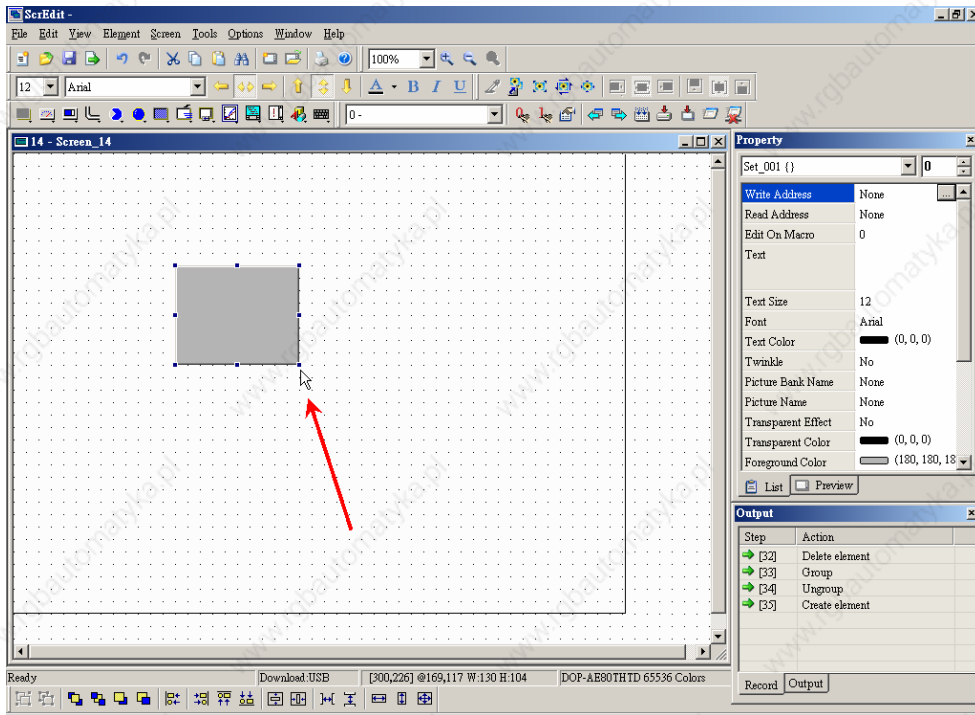



Fig. 2.6.7 Release left mouse button to create an element

■ Move an Element

The users can use the mouse to move an element. Mouse operation is the same as working in **Windows®** operating system. When the mouse cursor becomes a four-arrow icon , the users can hold down it by left-clicking the mouse and move the element freely (Fig. 2.6.8, Fig. 2.6.9 and Fig. 2.6.10).

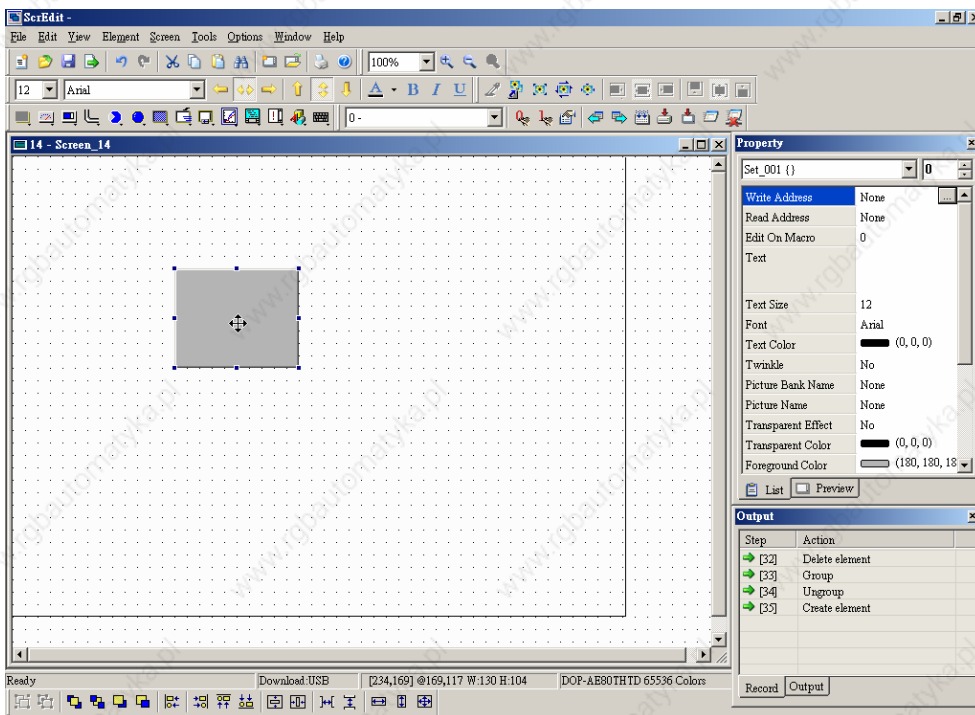


Fig. 2.6.8 Mouse cursor becomes a four-arrow icon 

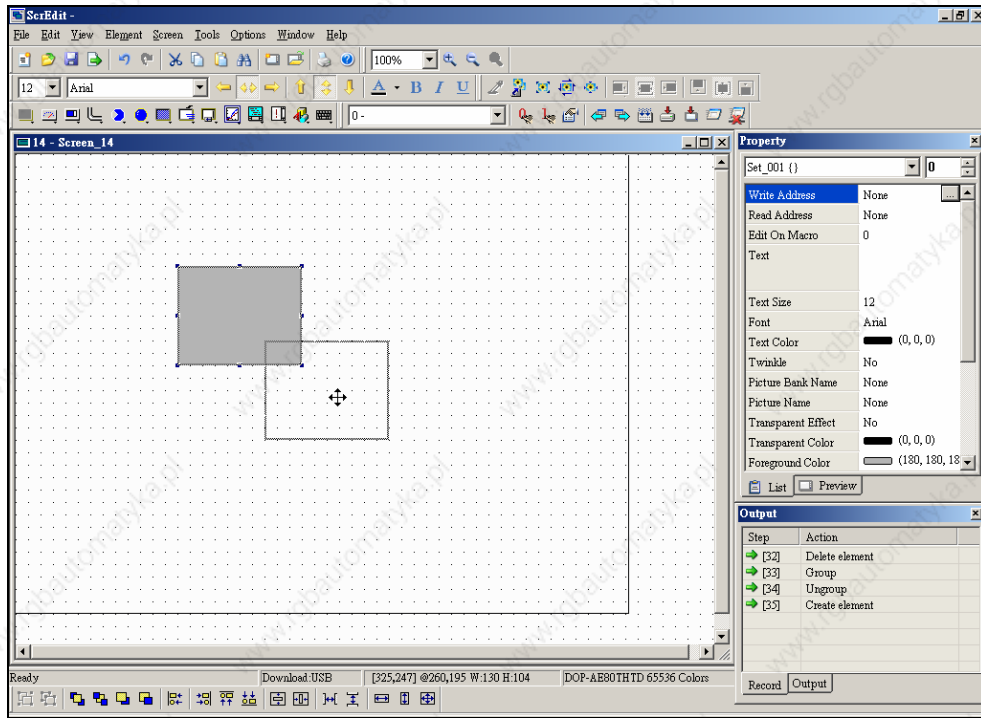



Fig. 2.6.9 Hold down  by left-clicking the mouse and move the element freely

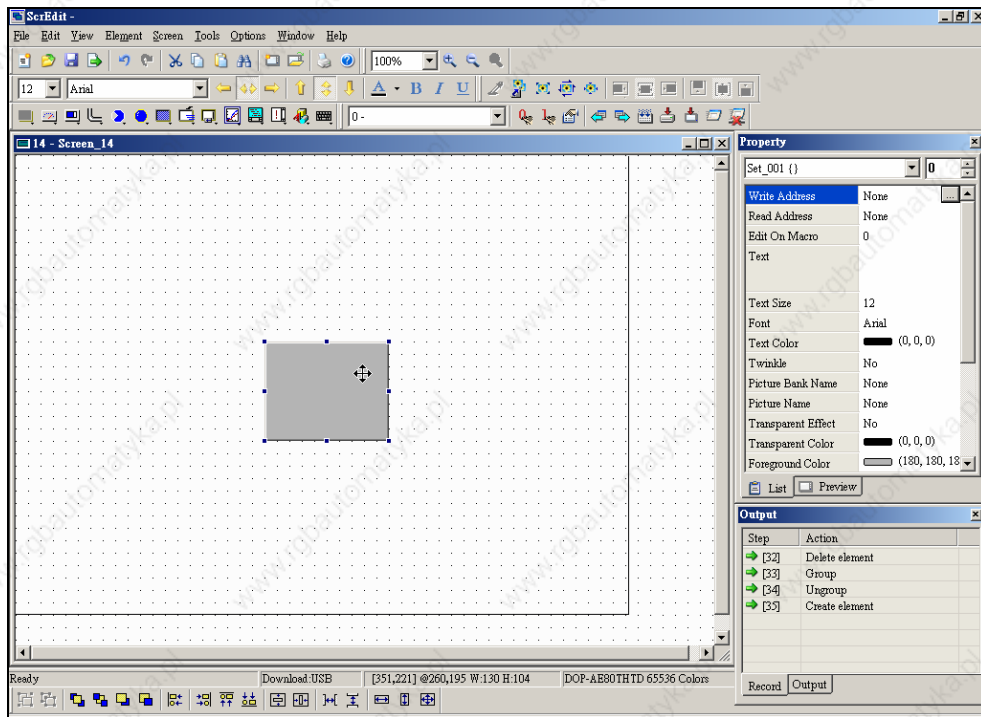



Fig. 2.6.10 Release the mouse left button to finish the movement

■ **Modify Element Width**

The users can also use the mouse to modify the width of an element. When the mouse cursor becomes a two-arrow icon , the users can hold down it by left-clicking the mouse and modify the element width (Fig. 2.6.11, Fig. 2.6.12 and Fig. 2.6.13).

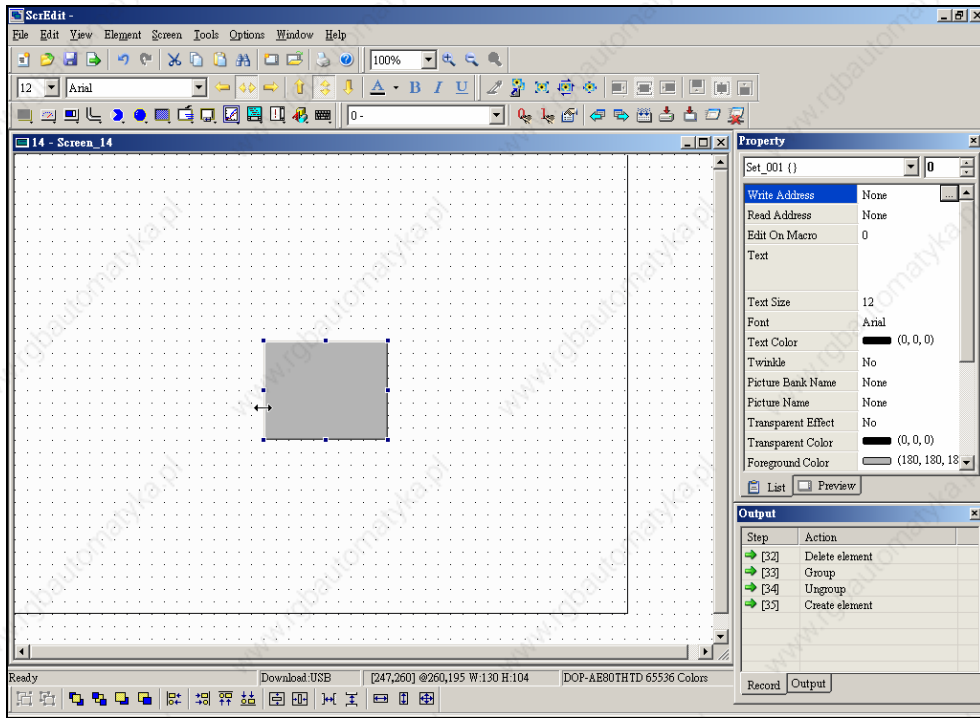


Fig. 2.6.11 Mouse cursor becomes a two-arrow icon ↔

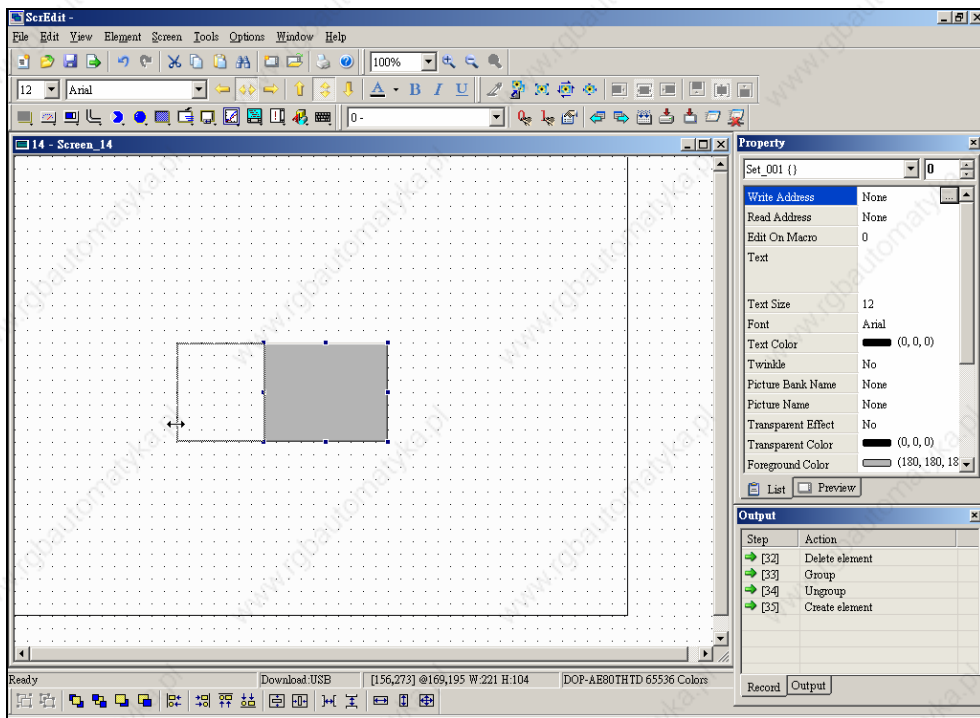


Fig. 2.6.12 Hold down ↔ by left-clicking the mouse and modify the element width

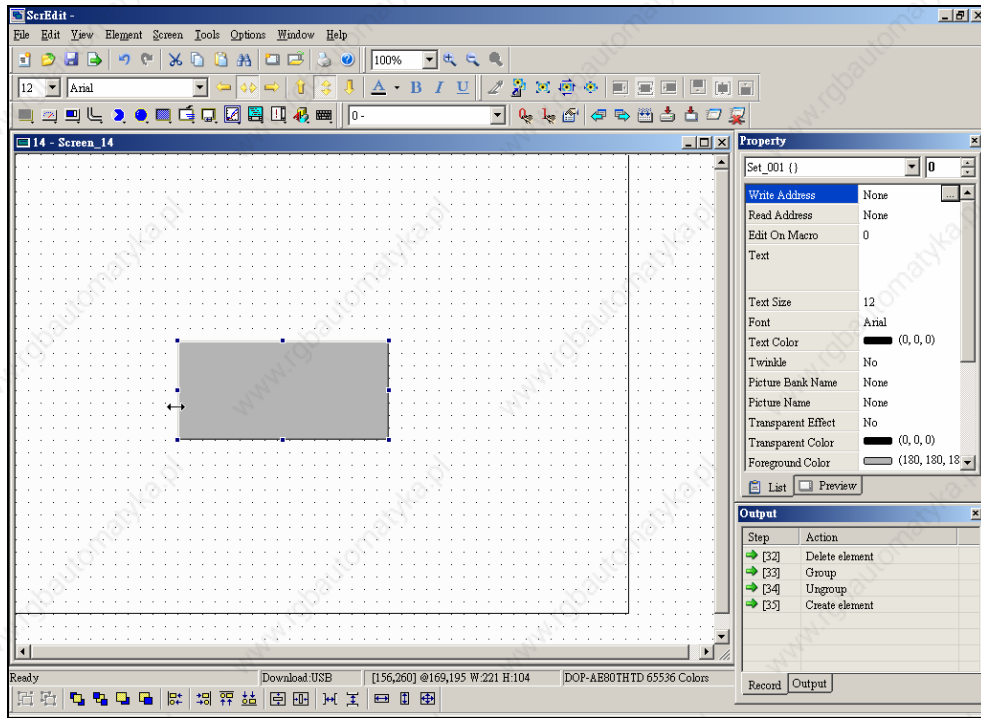



Fig. 2.6.13 Release the mouse left button to finish the modification

■ **Modify Element Height**

The users can also use the mouse to modify the height of an element. When the mouse cursor becomes a two-arrow icon , the users can hold down it by left-clicking the mouse and modify the element height (Fig. 2.6.14, Fig. 2.6.15 and Fig. 2.6.16).

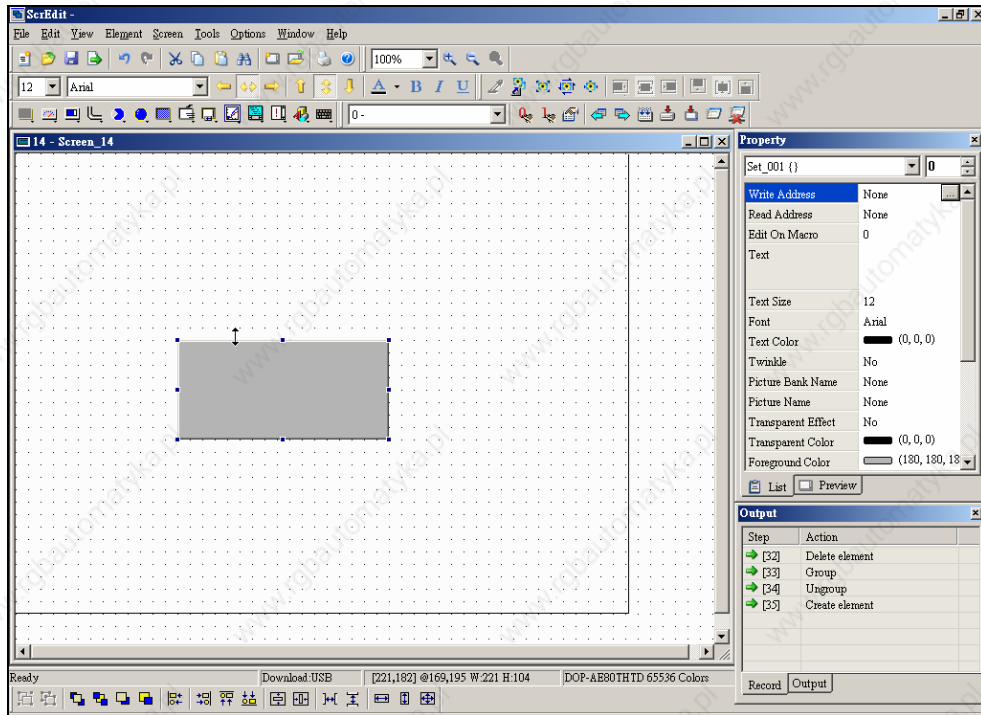



Fig. 2.6.14 Mouse cursor becomes a two-arrow icon 

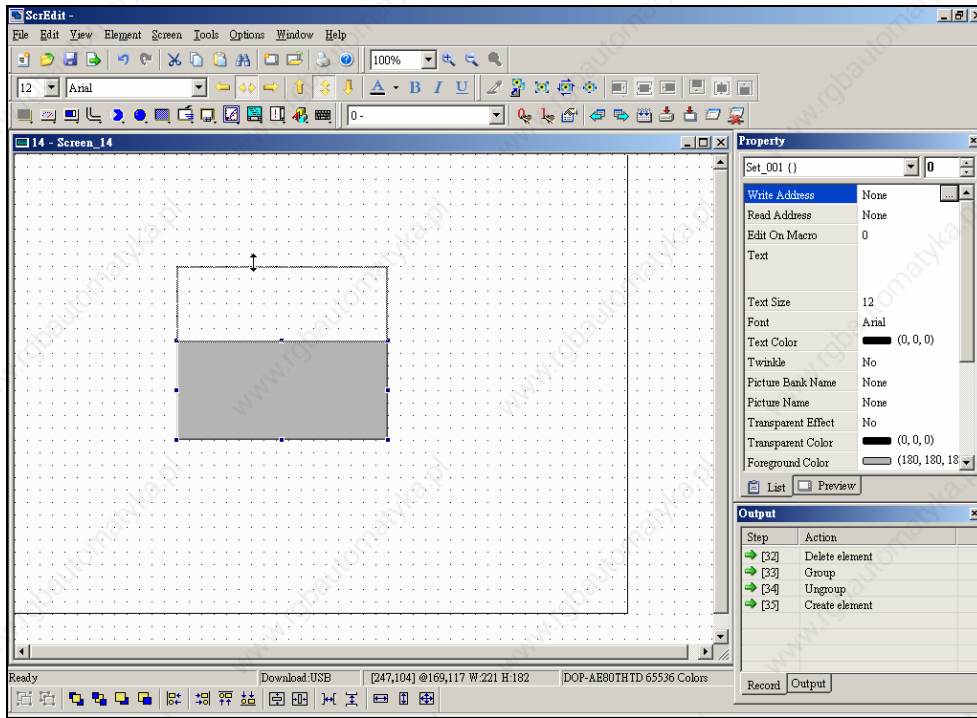



Fig. 2.6.15 Hold down  by left-clicking the mouse and modify the element height

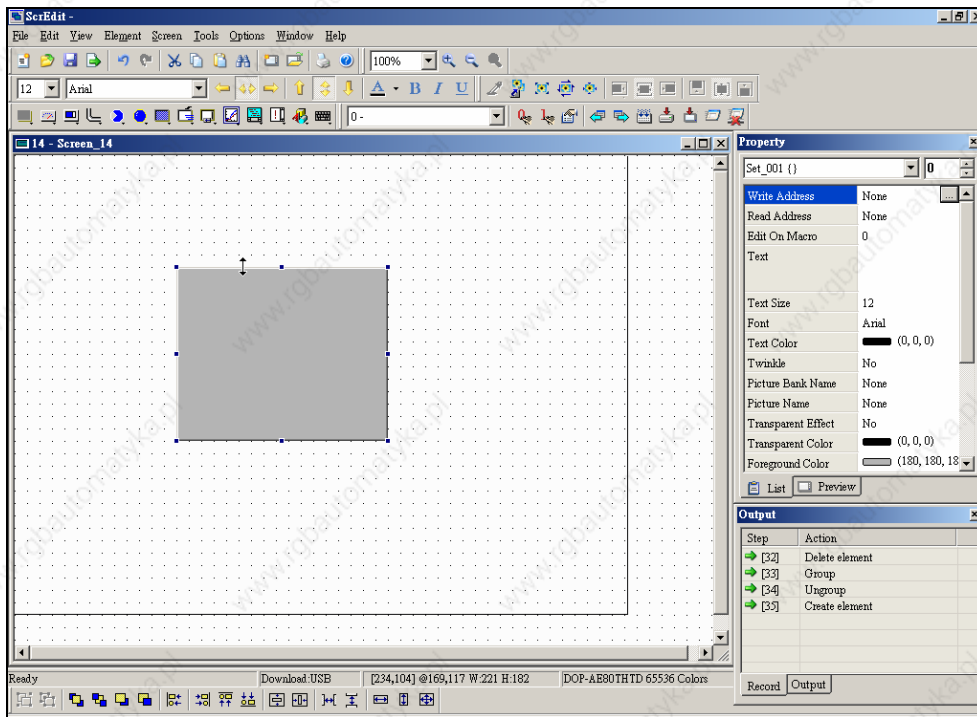



Fig. 2.6.16 Release the mouse left button to finish the modification

■ **Modify Element Width and Height Simultaneously (Method 1)**

The users can also use the mouse to modify the width and height of an element simultaneously. When the mouse cursor becomes a two-arrow icon , the users can hold down it by left-clicking the mouse and modify the element width and height at the same time (Fig. 2.6.17, Fig. 2.6.18 and Fig. 2.6.19).

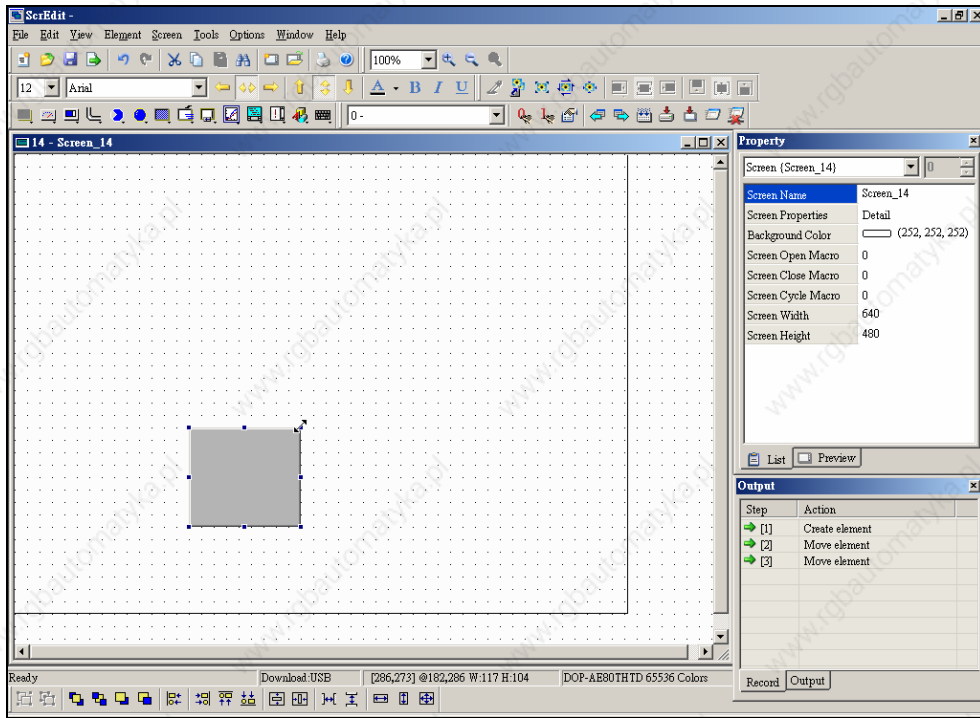


Fig. 2.6.17 Mouse cursor becomes a two-arrow icon ↔

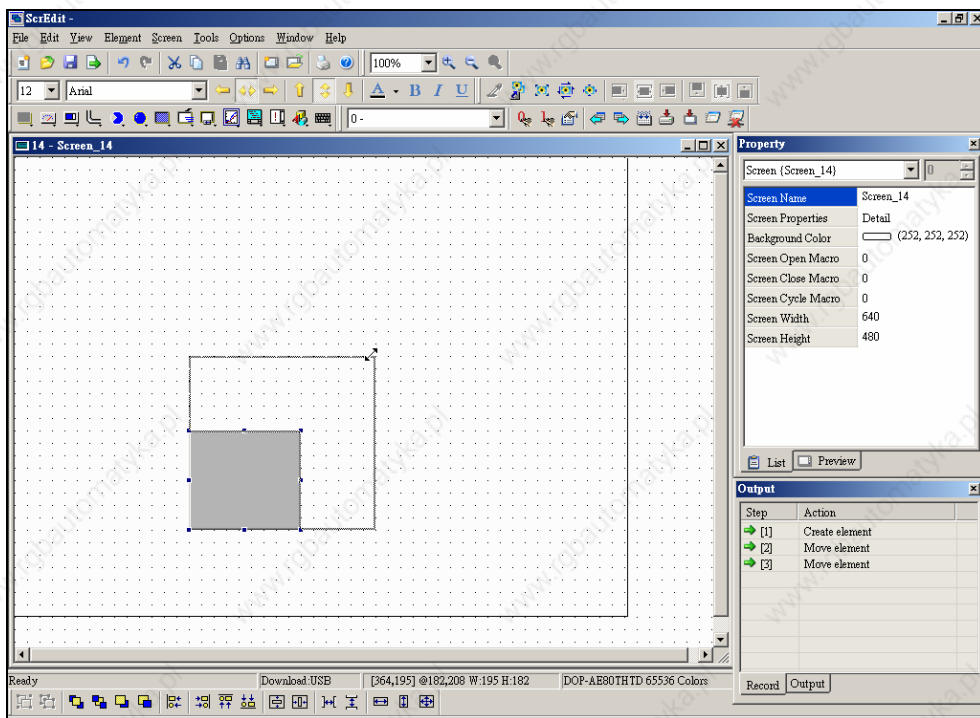


Fig. 2.6.18 Hold down ↔ by left-clicking the mouse and modify the element width and height

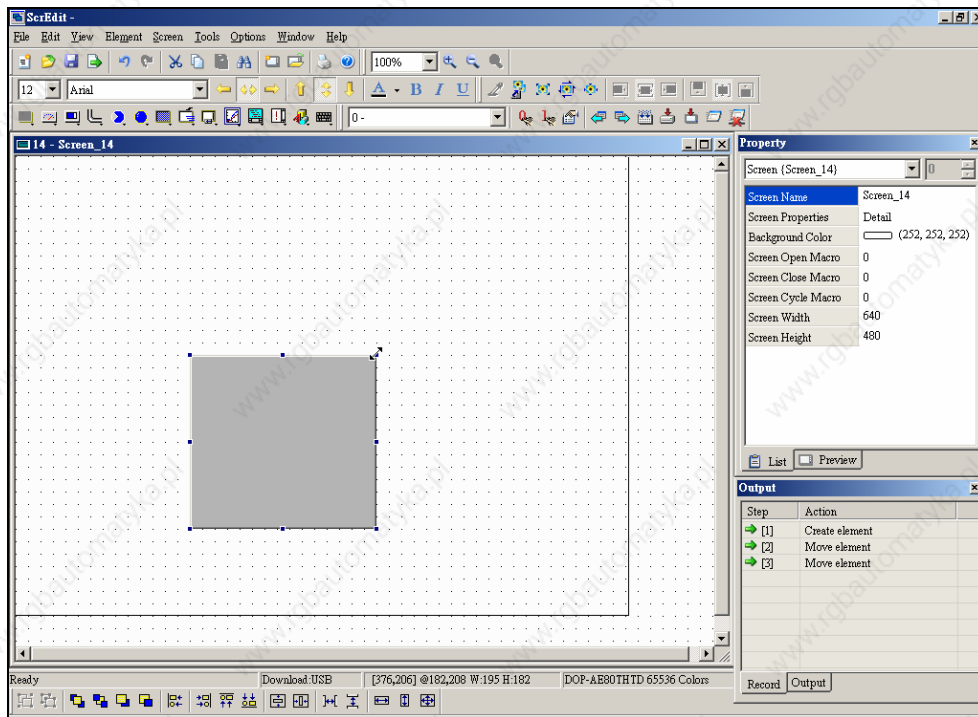



Fig. 2.6.19 Release the mouse left button to finish the modification

■ **Modify Element Width and Height Simultaneously (Method 2)**

The users can also use the mouse to modify the width and height of an element simultaneously. When the mouse cursor becomes a two-arrow icon , the users can hold down it by left-clicking the mouse and modify the element width and height at the same time (Fig. 2.6.20, Fig. 2.6.21 and Fig. 2.6.22).

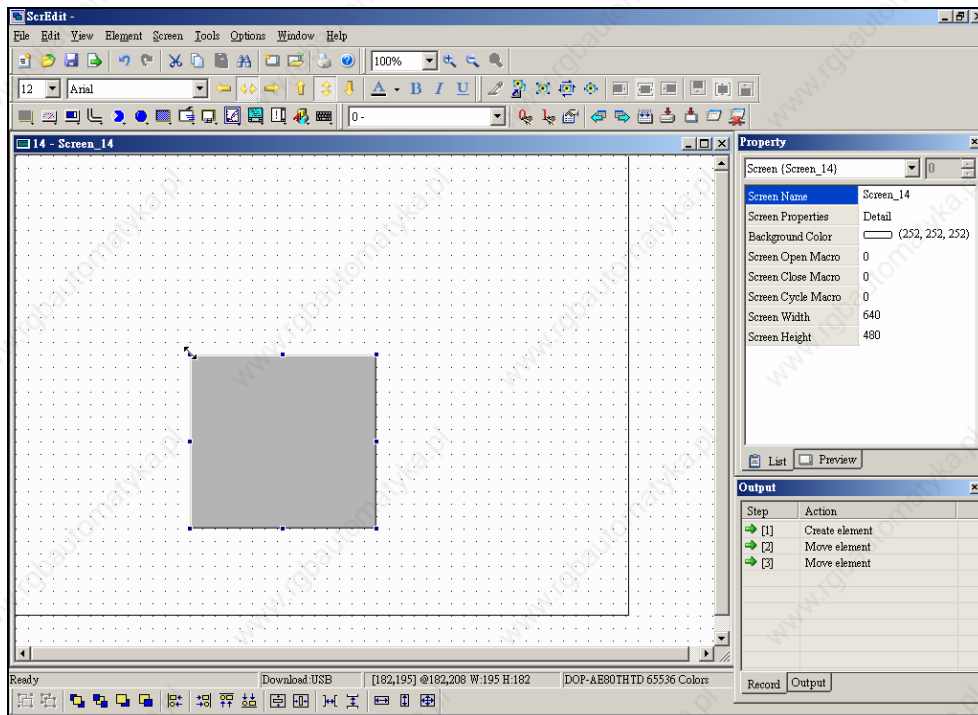


Fig. 2.6.20 Mouse cursor becomes a two-arrow icon 

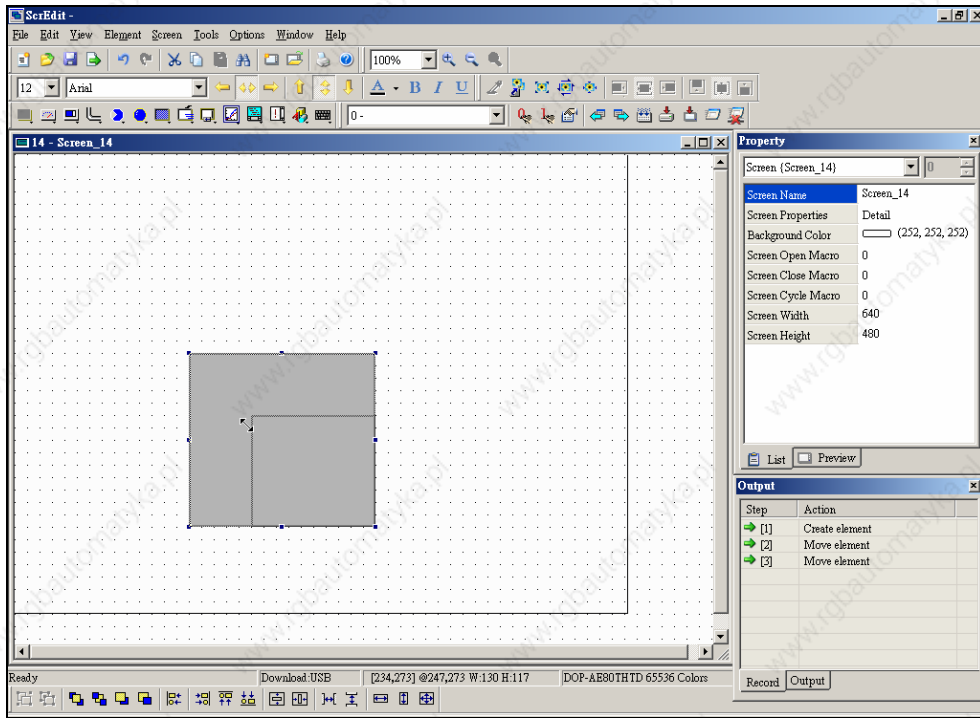



Fig. 2.6.21 Hold down  by left-clicking the mouse and modify the element width and height

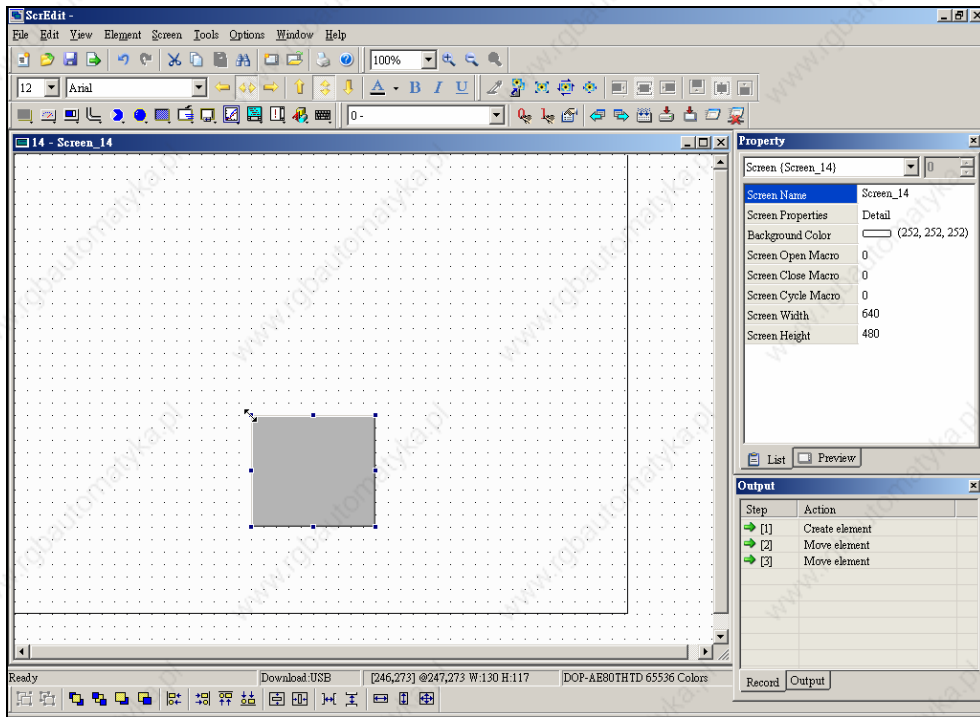




Fig. 2.6.22 Release the mouse left button to finish the modification

■ **Input characters**

The users can input a string of characters that **Windows®** operating system accepts in the property table. When the mouse cursor becomes an icon , the users can start to input any characters that **Windows®** operating system accepts at where the cursor  blinks (Fig. 2.6.23 and Fig. 2.6.24).

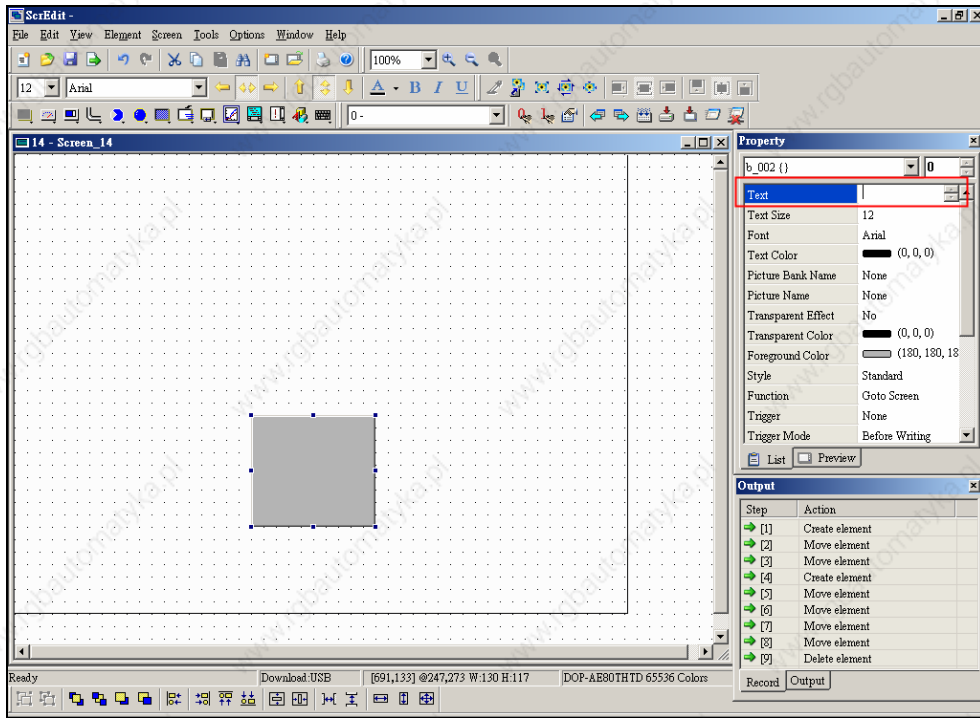


Fig. 2.6.23 Mouse cursor becomes an icon I (Ready to input characters display)

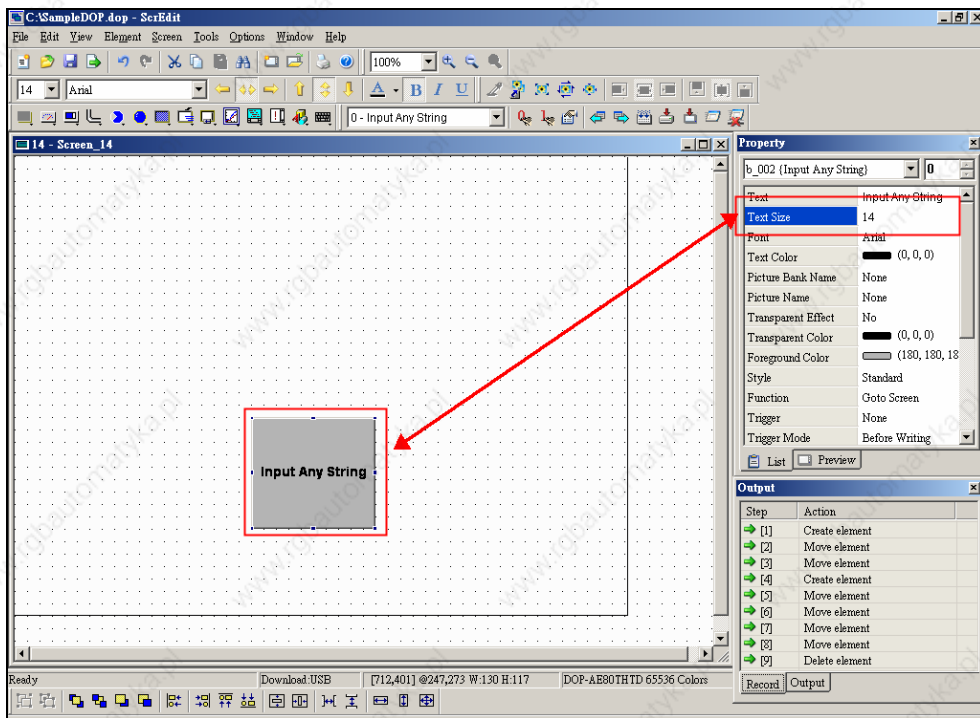


Fig. 2.6.24 Input characters for the element

■ Right-click the mouse

The users can find that different menu will pop up when right-clicking the mouse (Fig. 2.6.25, Fig. 2.6.26 and Fig. 2.6.27).

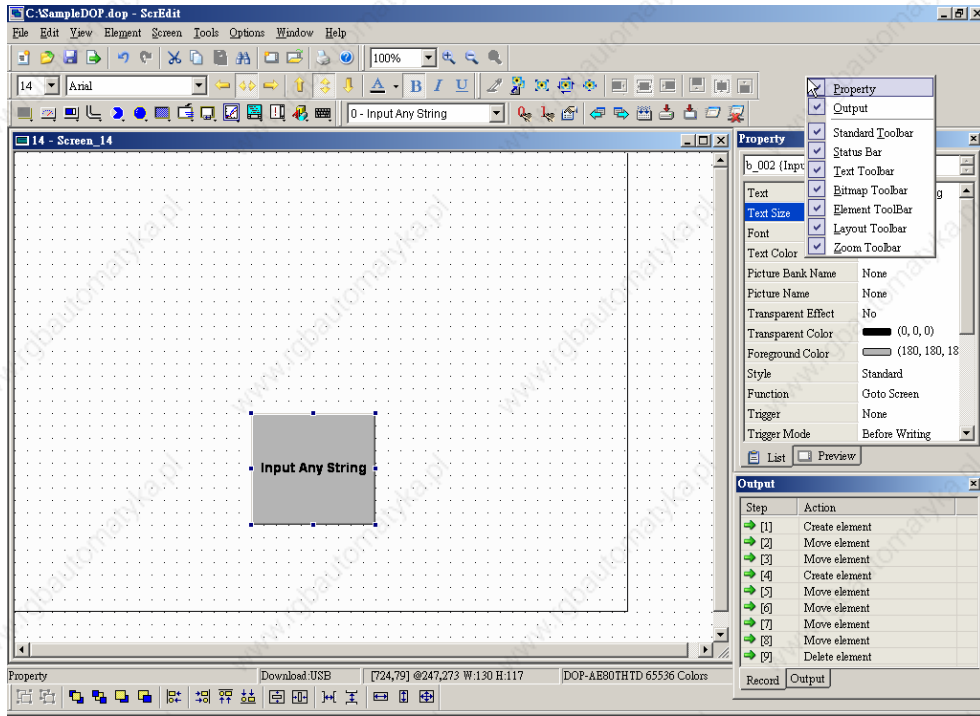


Fig. 2.6.25 Right-click the mouse on Toolbar – Toolbars display setup menu

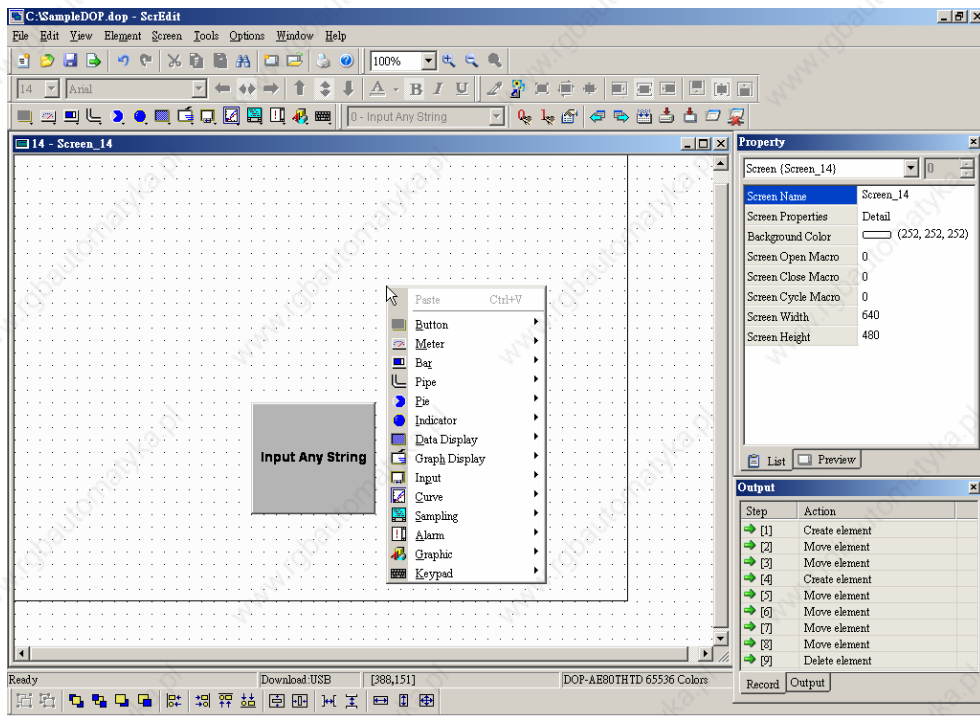


Fig. 2.6.26 Right-click the mouse in Work Place – Element Selection Menu

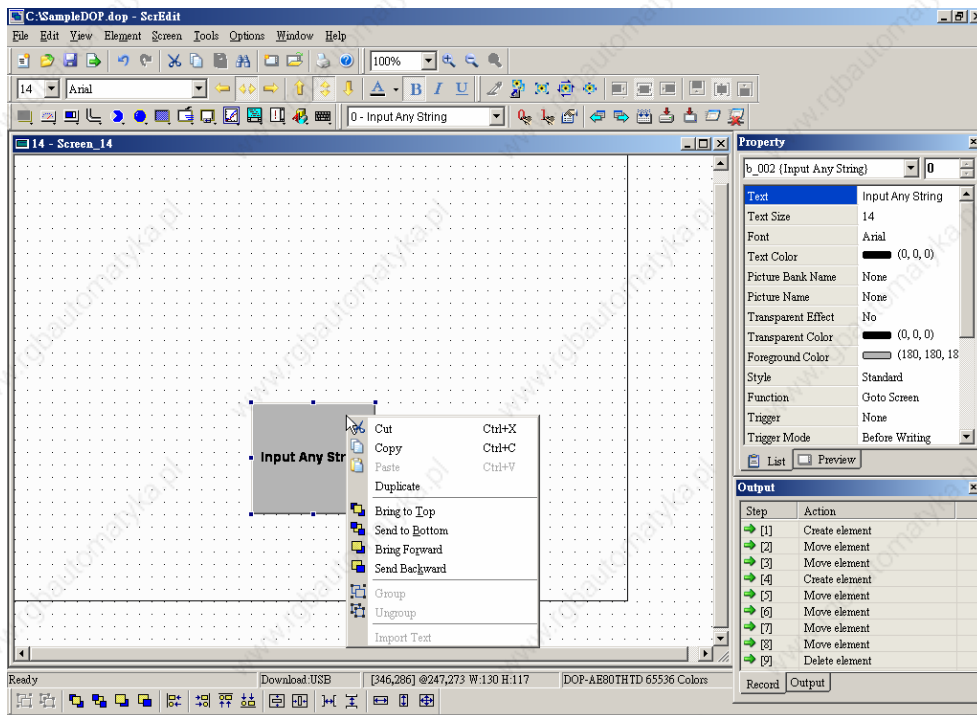


Fig. 2.6.27 Right-click the mouse on the element – Element Editing Menu

■ **Cross Reference Table**

Cross Reference Table ...

When creating and editing various kinds of elements, what usually happens is that the repeat use of the same address. In order to avoid this situation, ScrEdit provides the cross reference table function for the users' convenience and quick reference. The users can view the read and write addresses of the selected element and see their relationship or connection with the addresses of other elements, macro commands or system control area. The users can see how to choose **Cross Reference Table** command from menu bar in Fig. 2.6.28. Fig. 2.6.29 is one simple example to introduce the usage of this function. The first row of the cross reference table displays the referred element the users selected and the other rows below the first row displays the elements which have the same write address. The users can double-click the row and ScrEdit will switch to the corresponding screen of the referred address automatically. In Fig.2.6.29, ScrEdit switches to the corresponding screen of the referred address automatically and select the reference element.

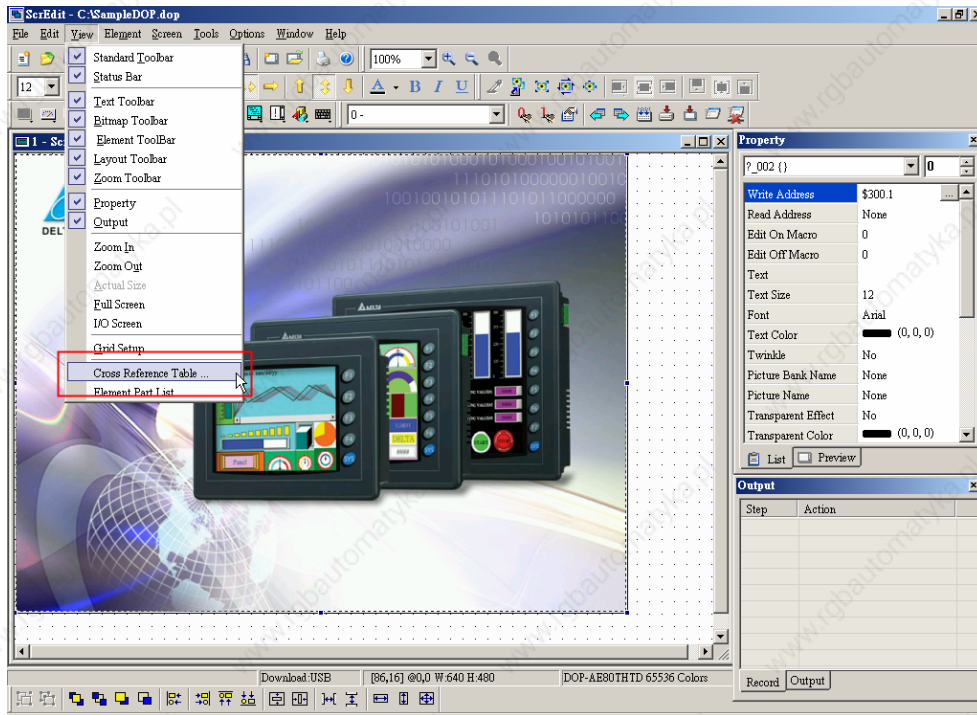


Fig. 2.6.28 Choosing Cross Reference Table command from menu bar

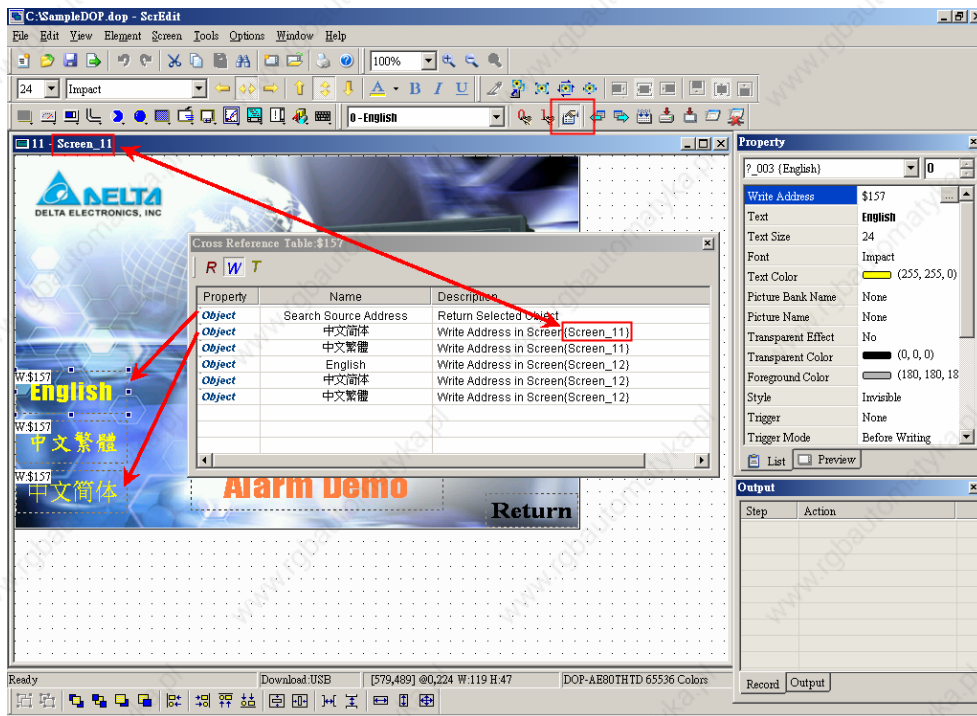


Fig. 2.6.29 Cross Reference Table dialog box

■ Element Part List

Element Part List ...

When **Element Part List** function is enabled (Fig. 2.6.30), ScrEdit will sort out and classify all the elements on the current screen. The users can click the tab to switch to the classification that the users want to view. The related addresses and corresponding properties will be listed in each classification (Name, Describe, Write / Read address, Trigger address, Trigger type, Interlock and Level) in each tab (Fig. 2.6.31). The users can double-click the column to let ScrEdit select the element automatically and allow the users to edit the detailed property of the selected element in property table.

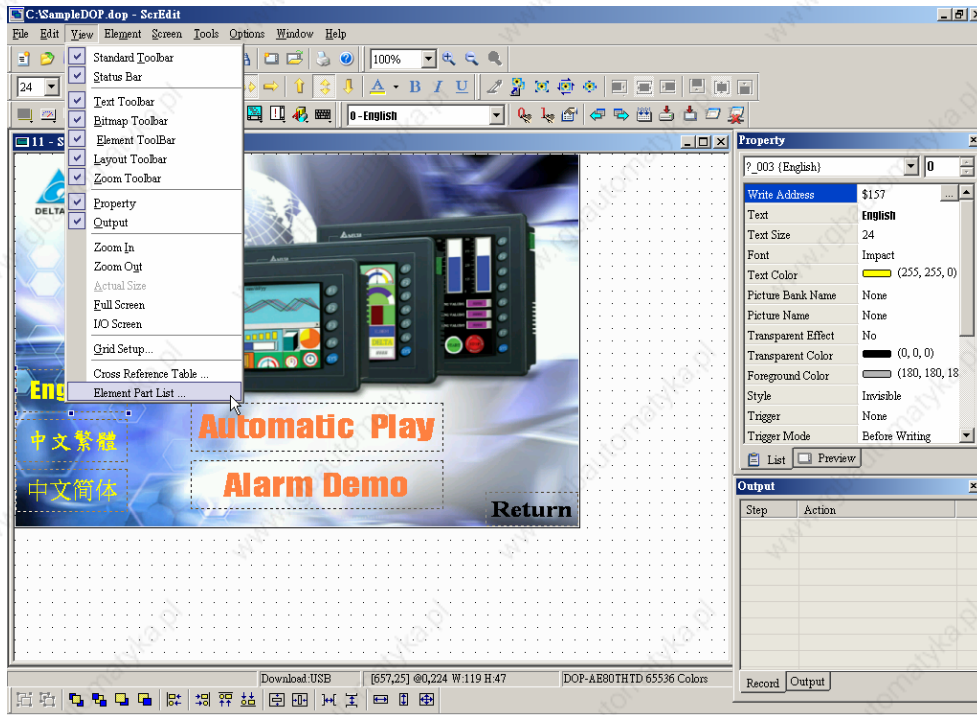


Fig. 2.6.30 Choosing Element Part List command from menu bar

Object Address List

Graphic Button Alarm Sampling

Name	Describe	Write	Read	Trigger	Trigger Type	InterLock	Level
Goto Screen_002				None	Before Writing	None	On
Set Constant_004		\$157		None	Before Writing	None	On
Set Constant_005		\$157		None	Before Writing	None	On
Set Constant_006		\$157		None	Before Writing	None	On
Goto Screen_008				None	Before Writing	None	On

Fig. 2.6.31 Element Part List dialog box

2.7 Menu Bar and Toolbar (Screen)

■ Screen

In Screen options, ScrEdit provides some screen editing functions (Fig. 2.7.1). Please refer to the following sections for more detailed introduction.

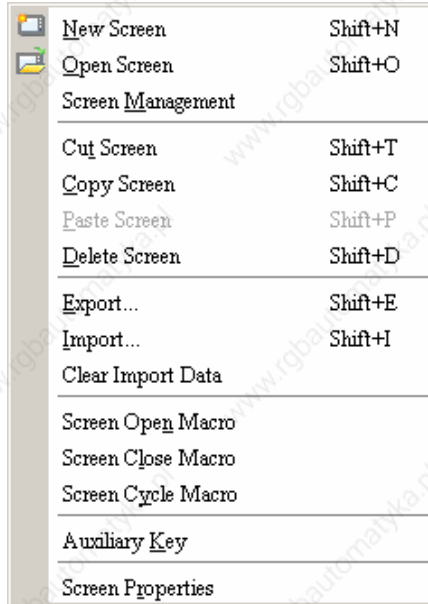


Fig. 2.7.1 Screen options

If the users press close box as in Fig. 2.7.2, it will hide the current screen without exiting. In Windows, it will exit the current screen by clicking close box and remind the users to save before exiting. However, in ScrEdit environment, the current screen will not be deleted and it will not remind the users to save also. The function of clicking close box only hides current screen.

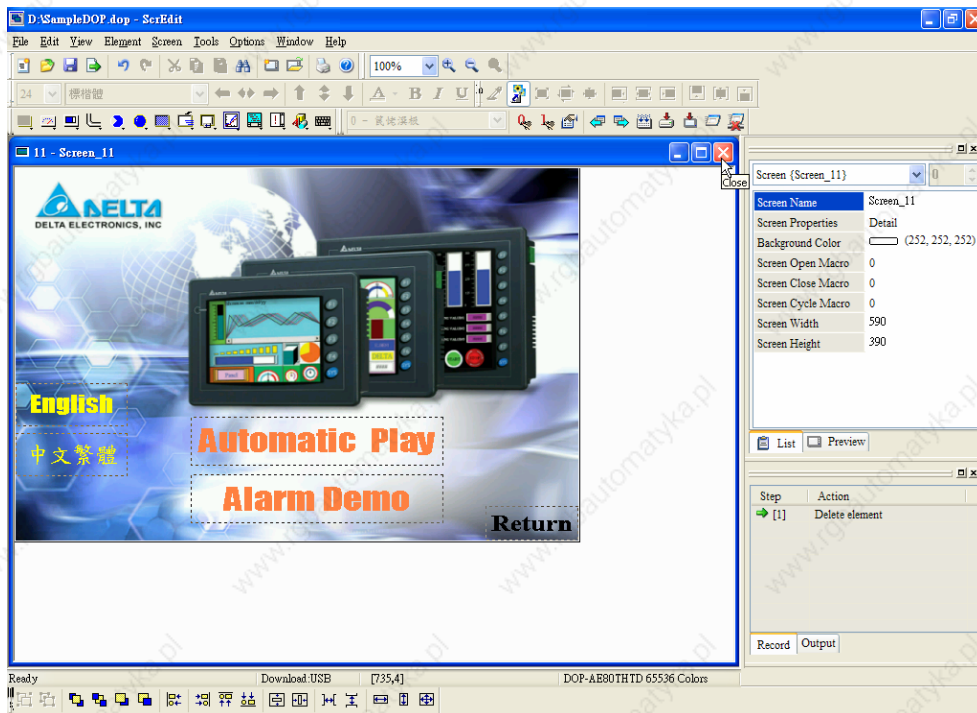



Fig. 2.7.2 Close Screen

■ New Screen



Create a new screen. The users can choose **Screen > New**

Screen (Fig. 2.7.3) or click the New Screen icon  (Fig. 2.7.4), or use keyboard shortcuts by pressing **Shift + N** to open a new editing screen. The new screen can be named and numbered by the users. The setting dialog box is shown as Fig. 2.7.5.

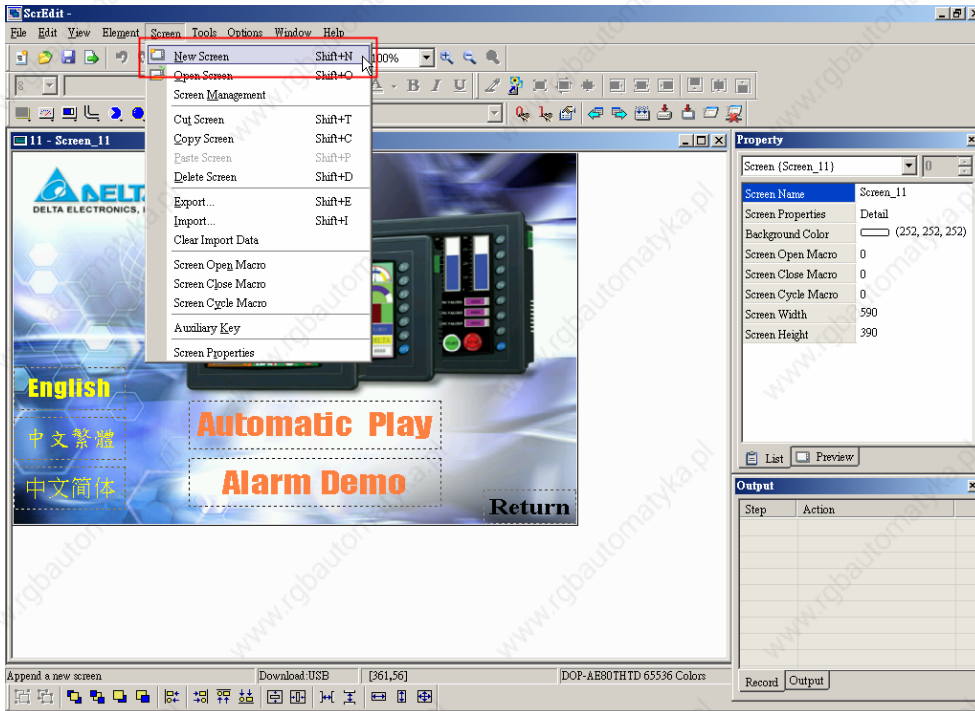


Fig. 2.7.3 Choosing New Screen command from menu bar

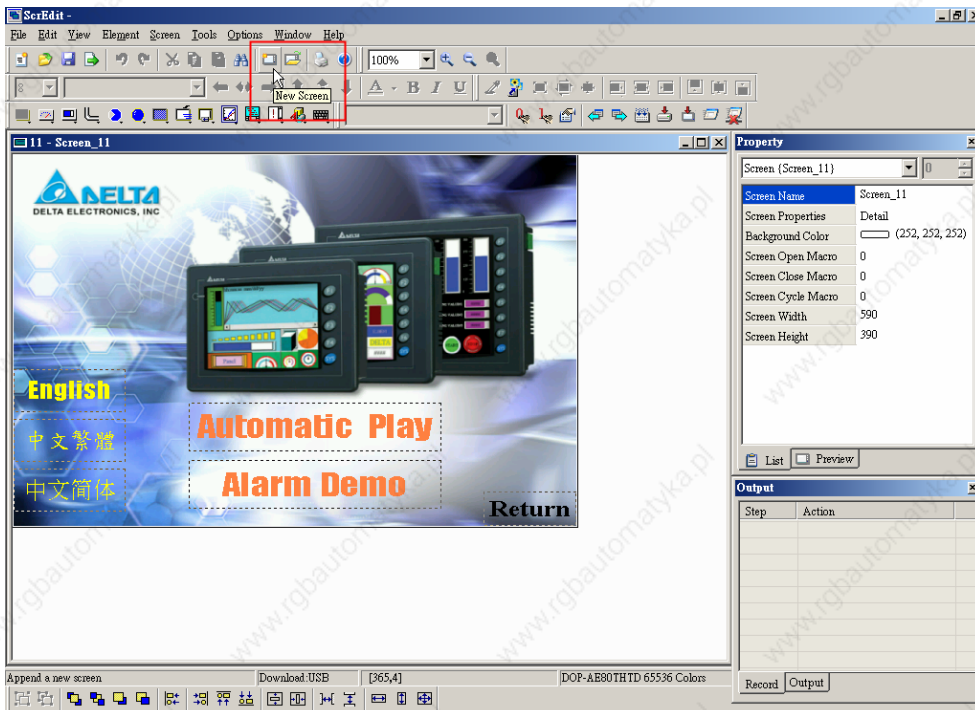


Fig. 2.7.4 Choosing New Screen icon from toolbar

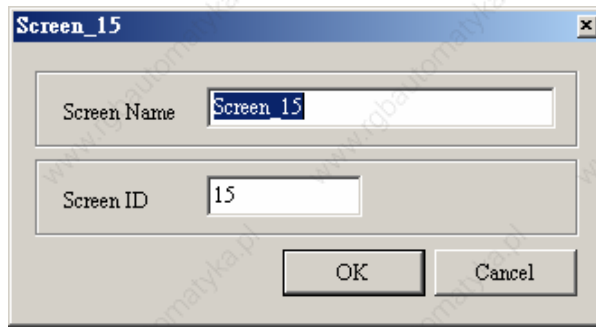



Fig. 2.7.5 New Screen dialog box

■ Open Screen



Open an old screen. The users can choose **Screen > Open**

Screen (Fig. 2.7.6) or click the Open Screen icon  (Fig. 2.7.7), or use keyboard shortcuts by pressing **Shift + O**. When choosing open screen, the users can preview each screen in Open Screen dialog box (Fig. 2.7.8).

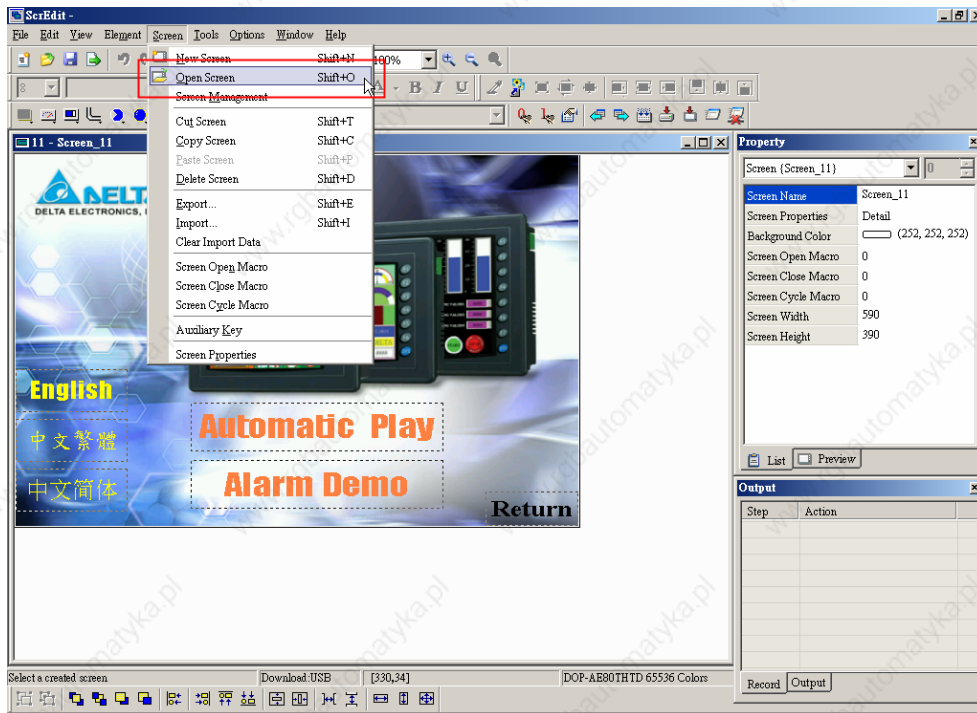


Fig. 2.7.6 Choosing Open Screen command from menu bar

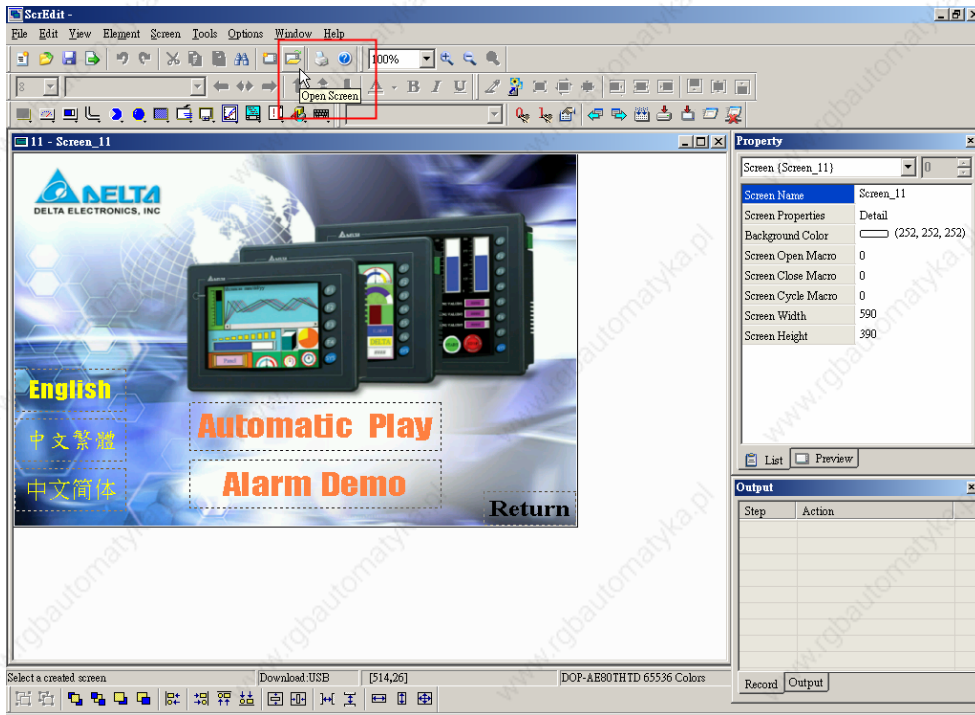


Fig. 2.7.7 Choosing Open Screen icon from toolbar

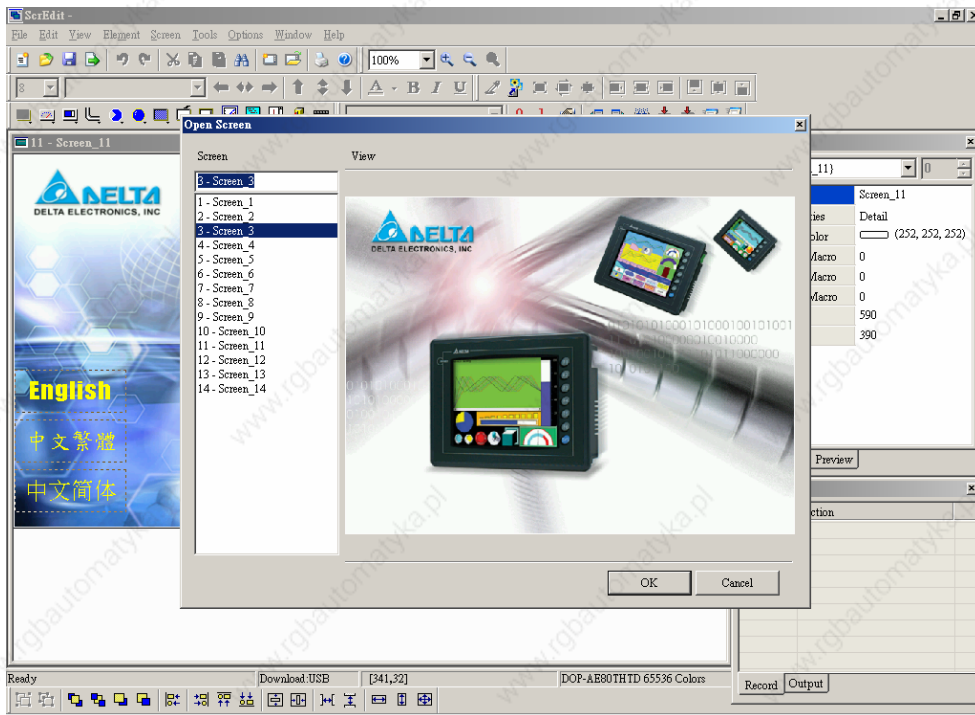


Fig. 2.7.8 Open Screen dialog box

■ Screen Management

Screen Management

When **Screen Management** function is enabled (Fig. 2.7.9, Fig. 2.7.10), the users can duplicate, paste and cut the screen by the mouse, just like the function of Windows Explorer in **Windows®** operating system. In Screen Management dialog box, the users can right click the mouse to manage all of the screens (Fig. 2.7.11). Right-clicking the mouse to select the **Edit Save Screen** function, and then the users can drag the mouse to determine the screen saver display (Fig. 2.7.12). For the setting of screen saver, please click **Options > Configuration > Other**.

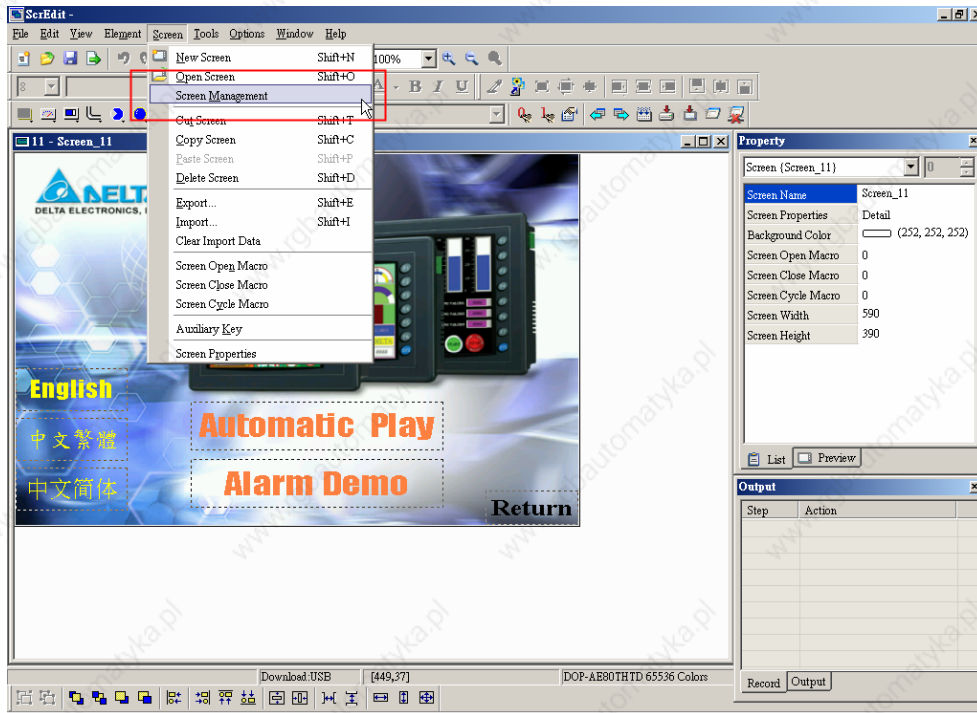


Fig. 2.7.9 Choosing Screen Management command from menu bar

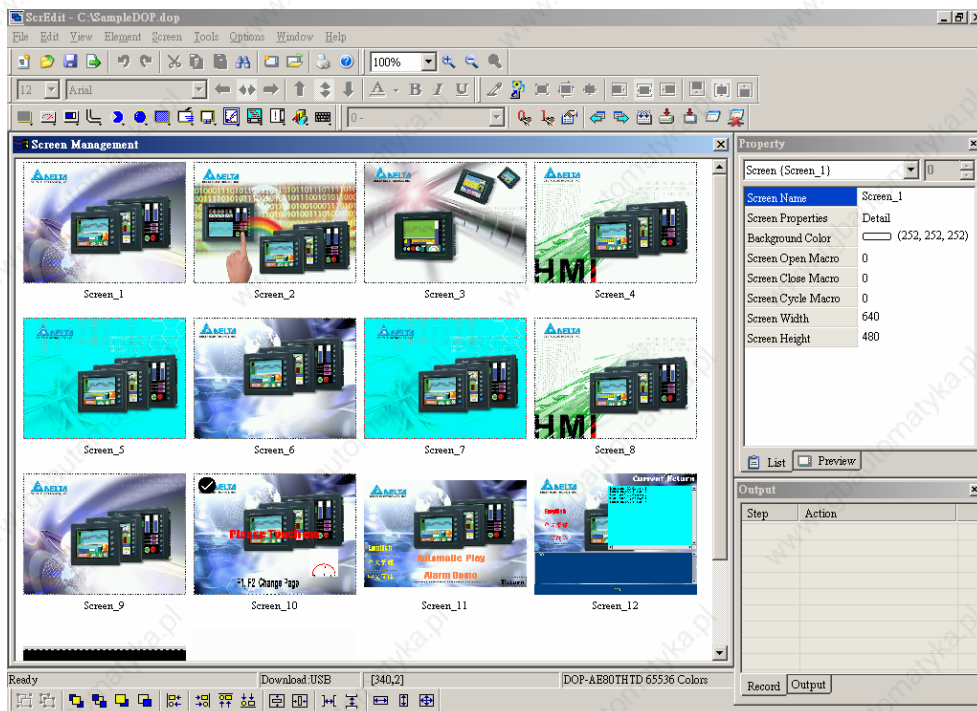


Fig. 2.7.10 Screen Management dialog box

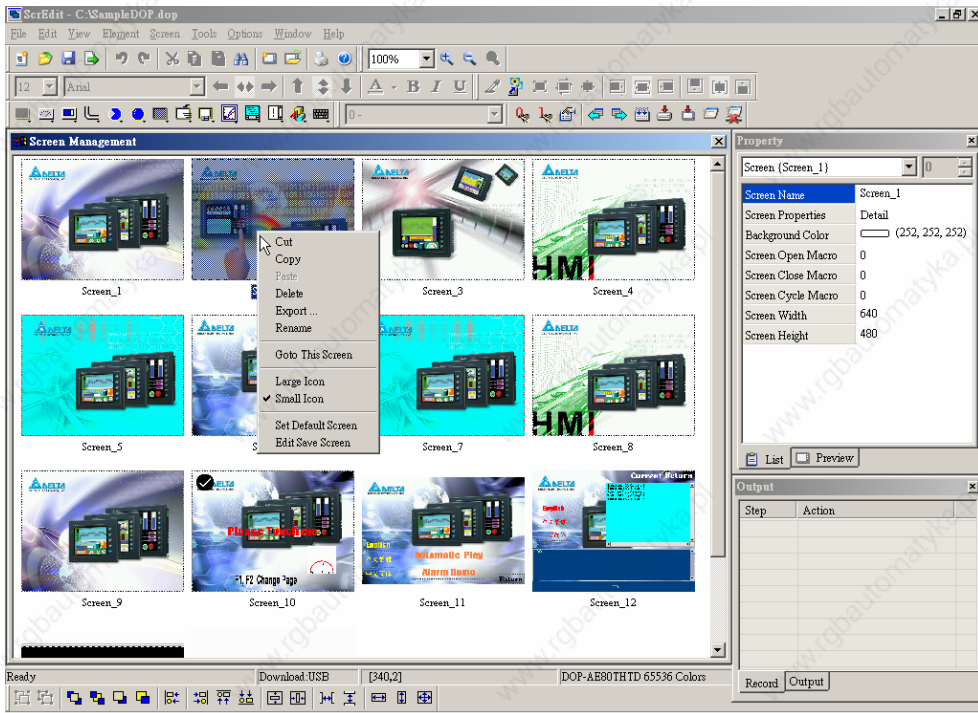


Fig. 2.7.11 Right-click the mouse to select Edit Save Screen function

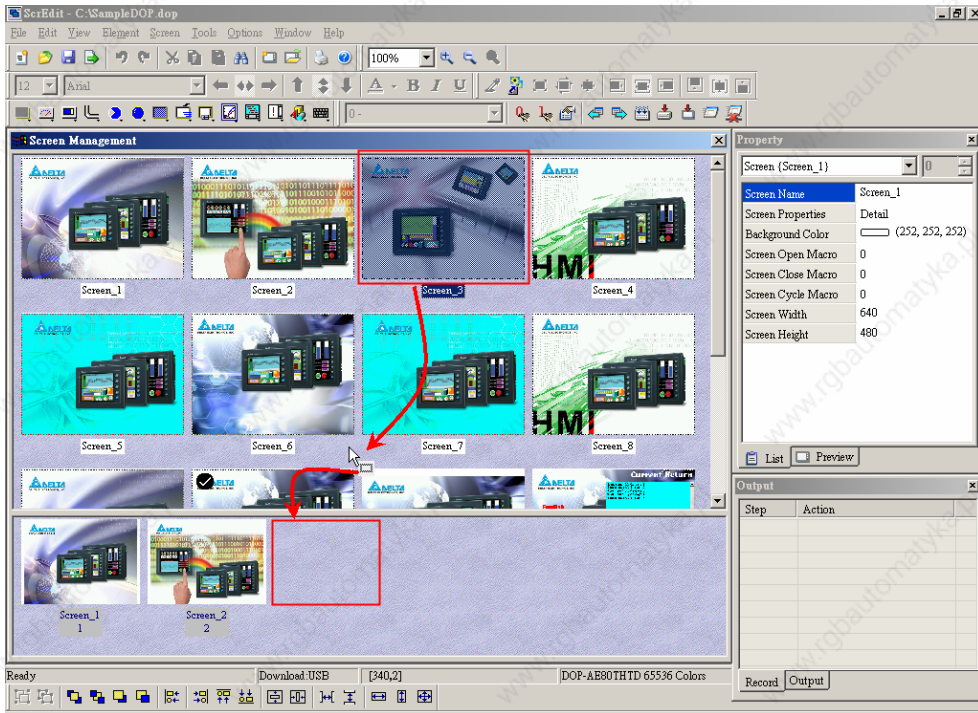


Fig. 2.7.12 Drag the mouse to determine the screen saver display

■ **Cut Screen**

Cut Screen **Shift+T**

Cut whole screen to clipboard, just like the Microsoft Office Clipboard function. The difference is that Microsoft Office Clipboard allows the users to cut text and graphic items and the Cut Screen function only allows the users to cut whole screen. The users can execute this function by choosing **Screen > Cut Screen** (Fig. 2.7.13), or use keyboard shortcuts by pressing **Shift + T** (Fig. 2.7.14).

Note: The users cannot undo the action of cut screen. It is the same as delete screen that screen will be lost but it can be pasted to get the same screen.

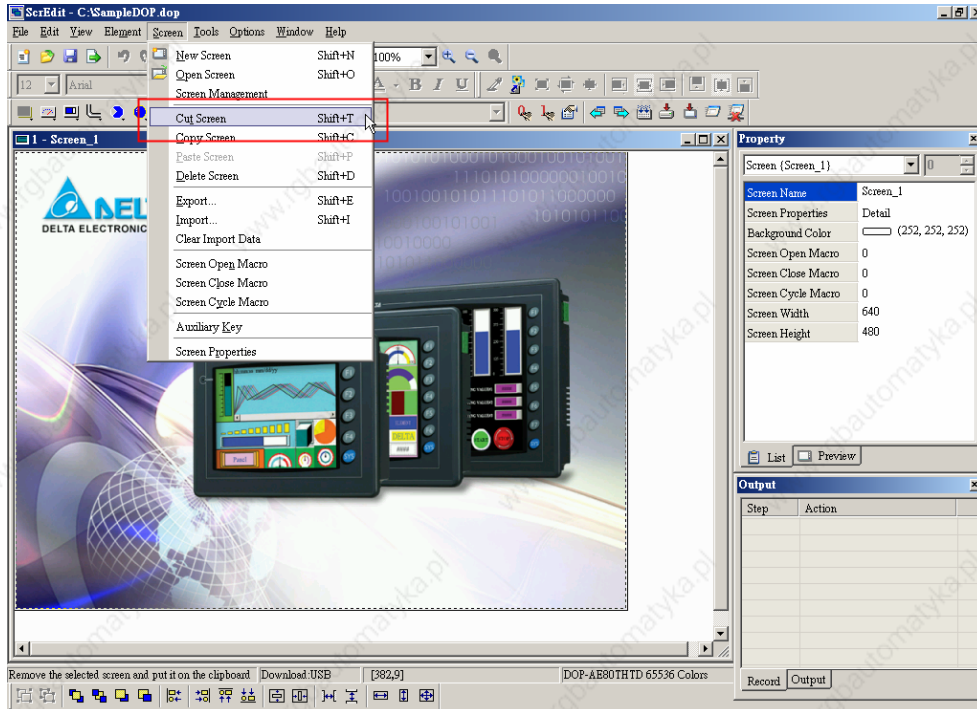


Fig. 2.7.13 Choosing Cut Screen command from menu bar

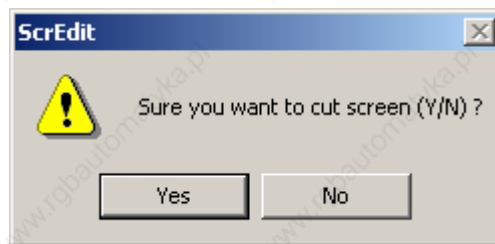


Fig. 2.7.14 Cut Screen message

■ **Copy Screen**

Copy Screen **Shift+C**

Copy whole screen. The users can execute this function by clicking **Screen > Copy Screen** (Fig. 2.7.15) or use keyboard shortcuts by pressing **Shift + C**.

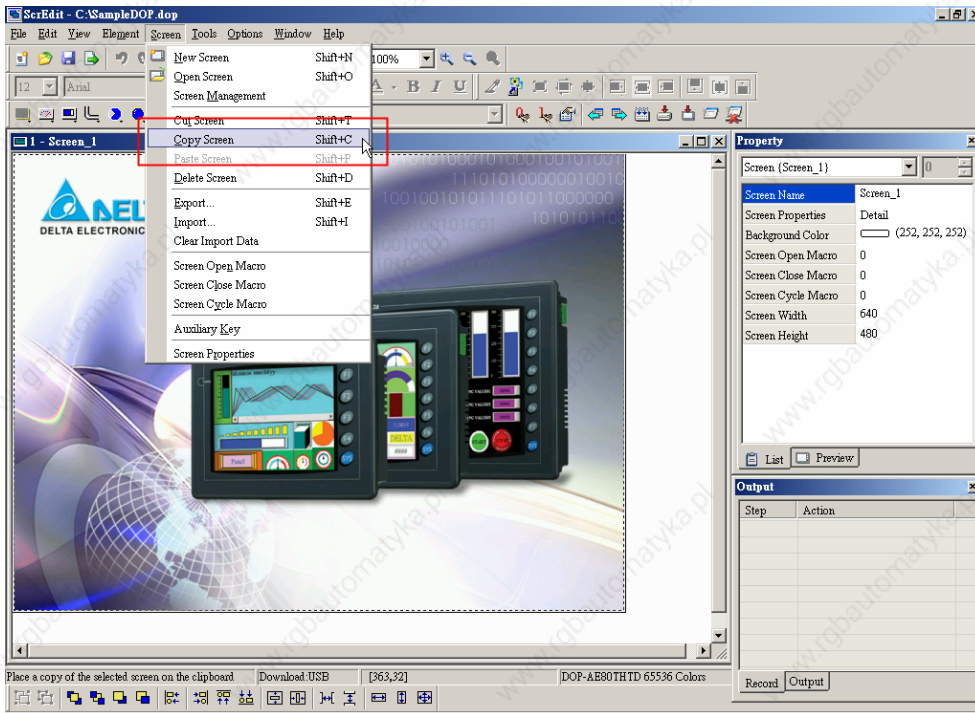


Fig. 2.7.15 Choosing Copy Screen command from menu bar

■ Paste Screen

Paste Screen Shift+P

The users can paste screen by clicking **Screen > Paste Screen** (Fig. 2.7.16) or use keyboard shortcuts by pressing **Shift + P**. All screen setting will be the same as original screen after pasting but screen name will be given automatically.

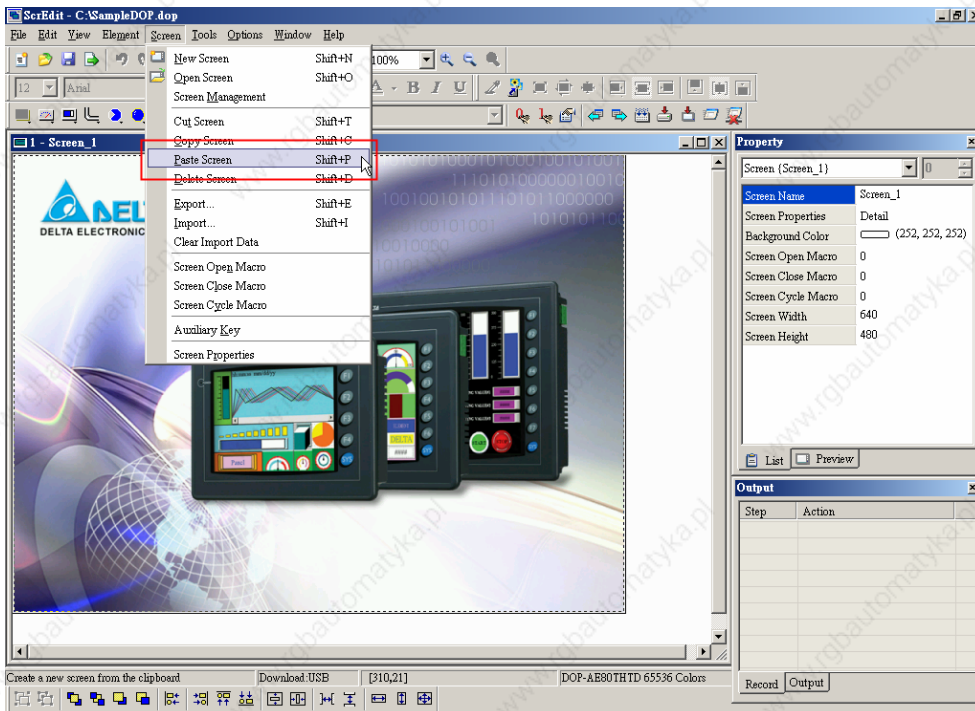


Fig. 2.7.16 Choosing Paste Screen command from menu bar

■ Delete Screen

Delete Screen **Shift+D**

Delete the current editing screen or element. The users can delete screen by clicking **Screen > Delete Screen** (Fig. 2.7.13) or use keyboard shortcuts by pressing **Shift + D**.

Note: After executing Delete Screen, the users cannot undo the action of delete screen. Please consider it carefully before taking action.

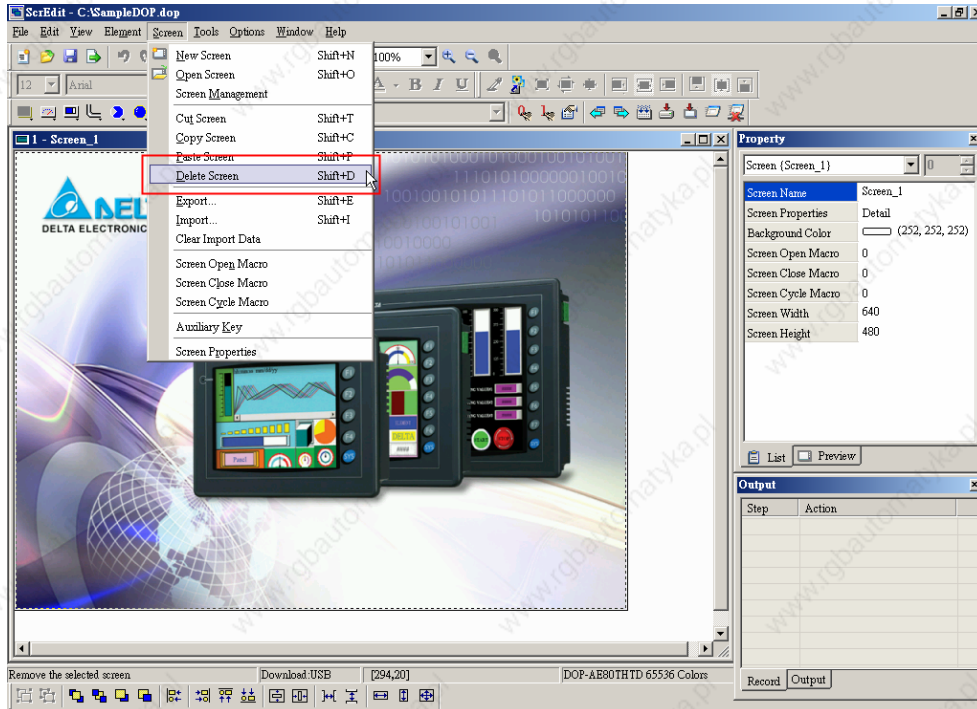


Fig. 2.7.17 Choosing Delete Screen command from menu bar

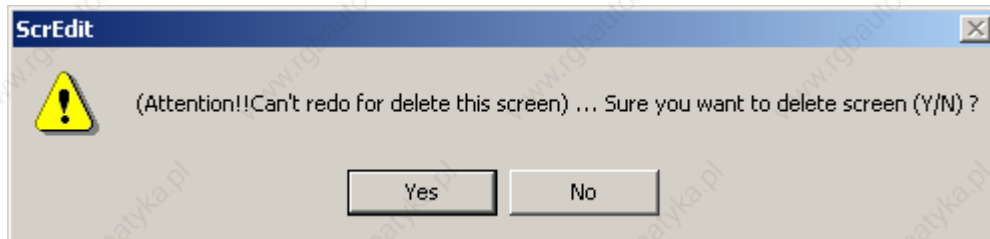



Fig. 2.7.18 Delete Screen Message

■ Export

Export... **Shift+E**

Export an application to BMP format. The users can execute this function by clicking **Screen > Export** (Fig. 2.7.19) or clicking the

Export icon  (Fig. 2.7.20), or use keyboard shortcuts by pressing **Shift + E**.

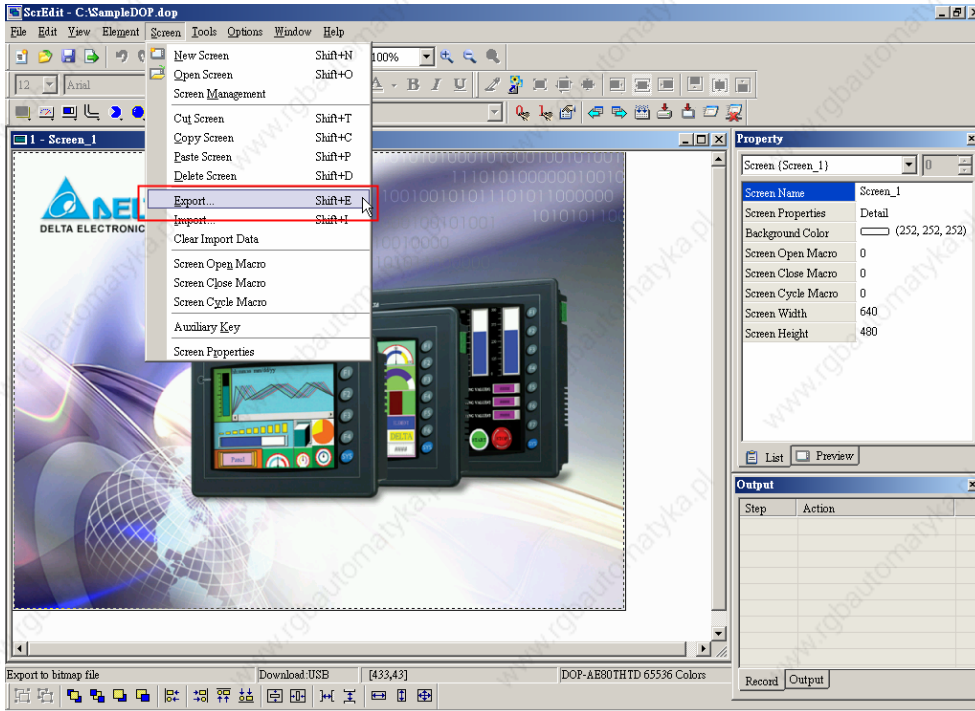


Fig. 2.7.19 Choosing Export command from menu bar

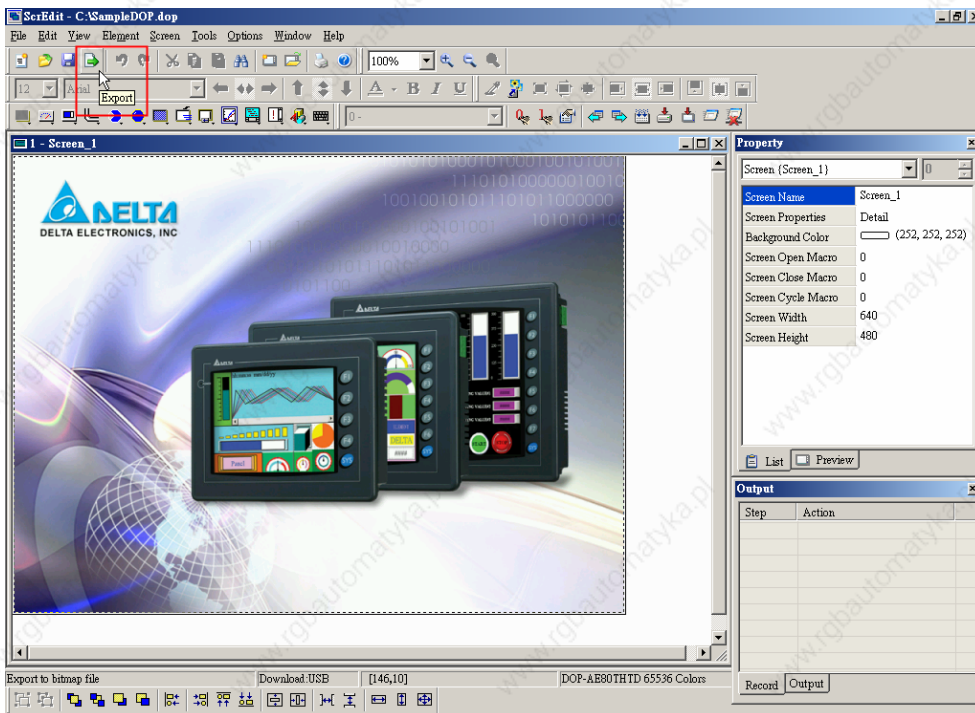


Fig. 2.7.20 Choosing Export icon from toolbar

■ Import

Import... **Shift+I**

Import a picture to be the ground of the editing screen. Please notice that this ground of the editing screen is different than the base screen. The nature of imported picture differs greatly from that of base screen. The imported picture cannot exist in ScrEdit as an element. However, the base screen can be regarded as an element and then exist in the editing screen after compile operation is completed. The file types of available imported picture can be BMP, JPG and GIF, etc. The users can execute this function by clicking **Screen > Import** (Fig. 2.7.21) or use keyboard shortcuts by pressing **Shift + I**.

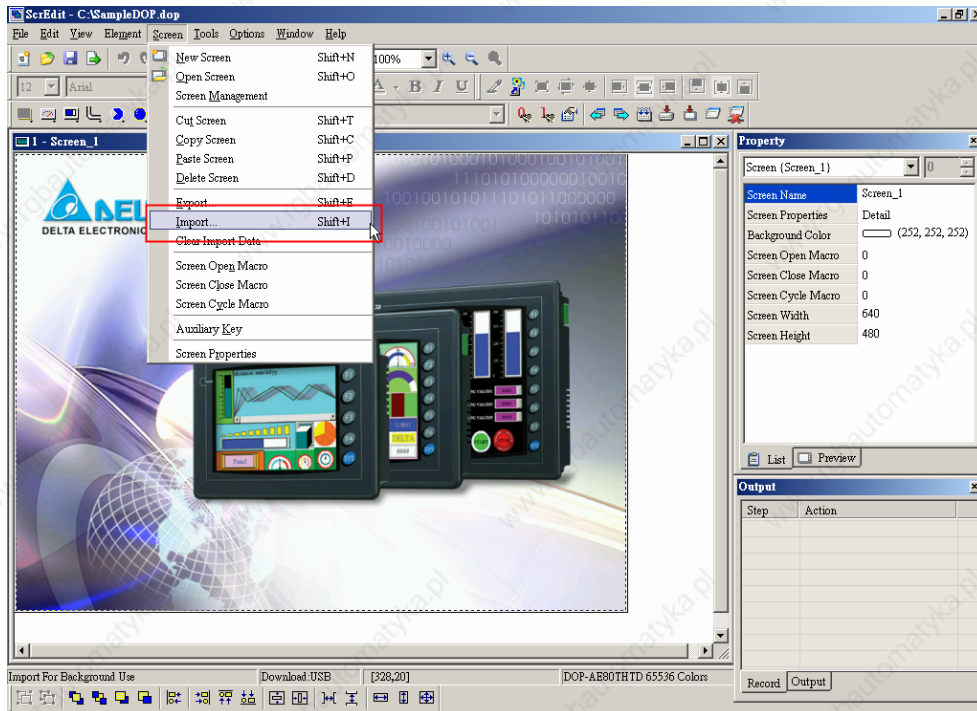


Fig. 2.7.21 Choosing Import command from menu bar

■ Clear Import Data

Clear Import Data

The users can free more disk space by clearing the imported data that the users do not want to use. Execute this function by clicking **Screen > Clear Import Data** (Fig. 2.7.22).

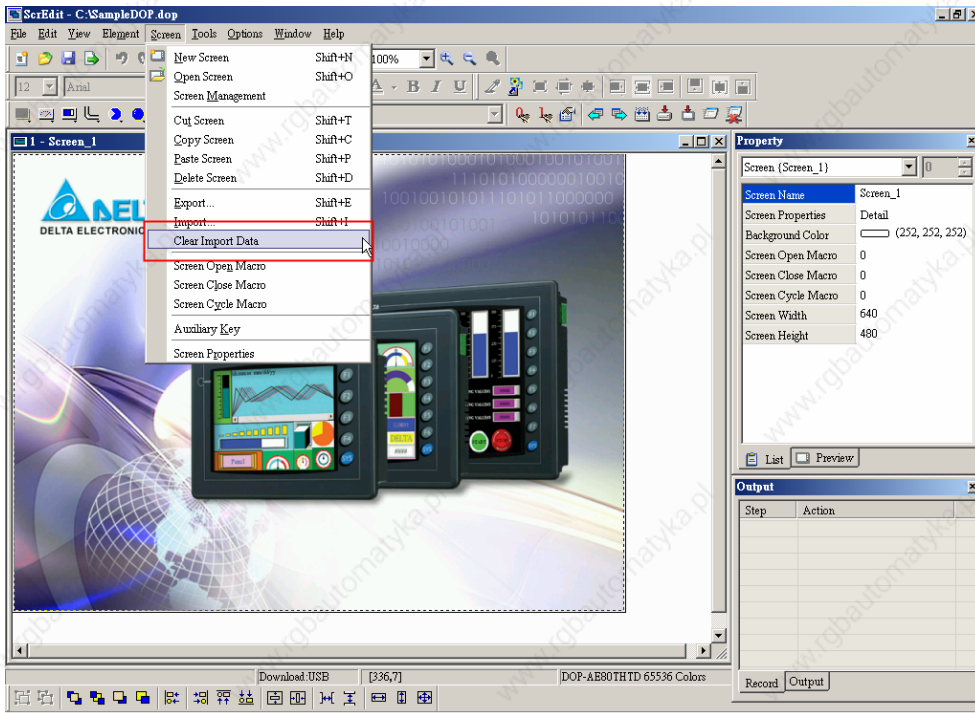


Fig. 2.7.22 Choosing Clear Import Data command from menu bar

■ Screen Open Macro

Screen Open Macro

When **Screen Open Macro** function is selected, the Macro will be executed automatically once opening screen. (Please refer to Chapter 4 for the usage and editing method of Macro.)

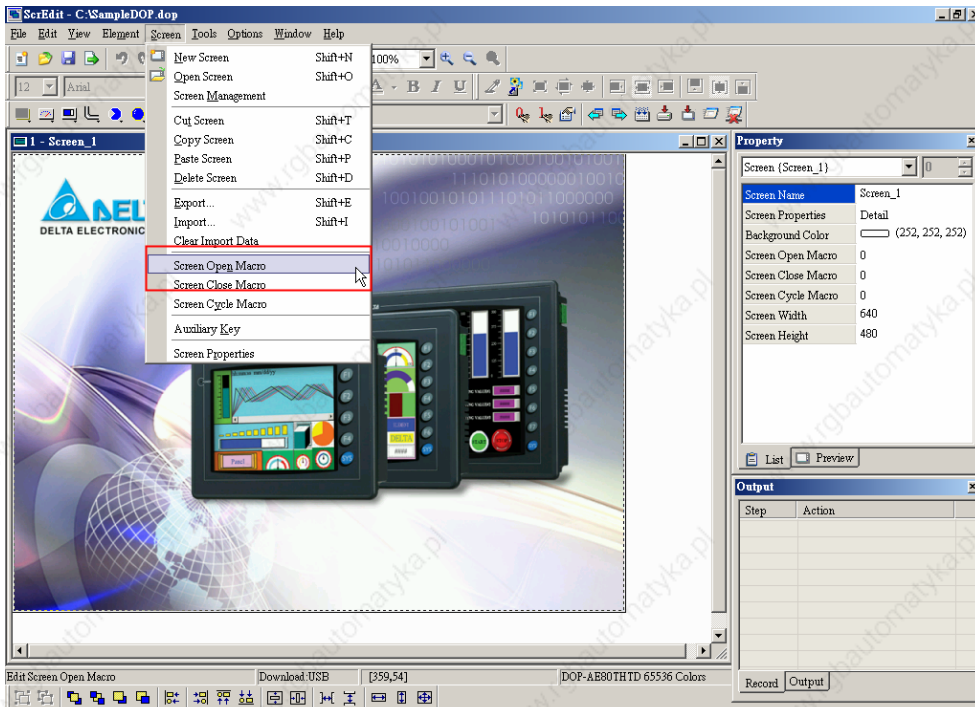


Fig. 2.7.23 Choosing Screen Open Macro command from menu bar

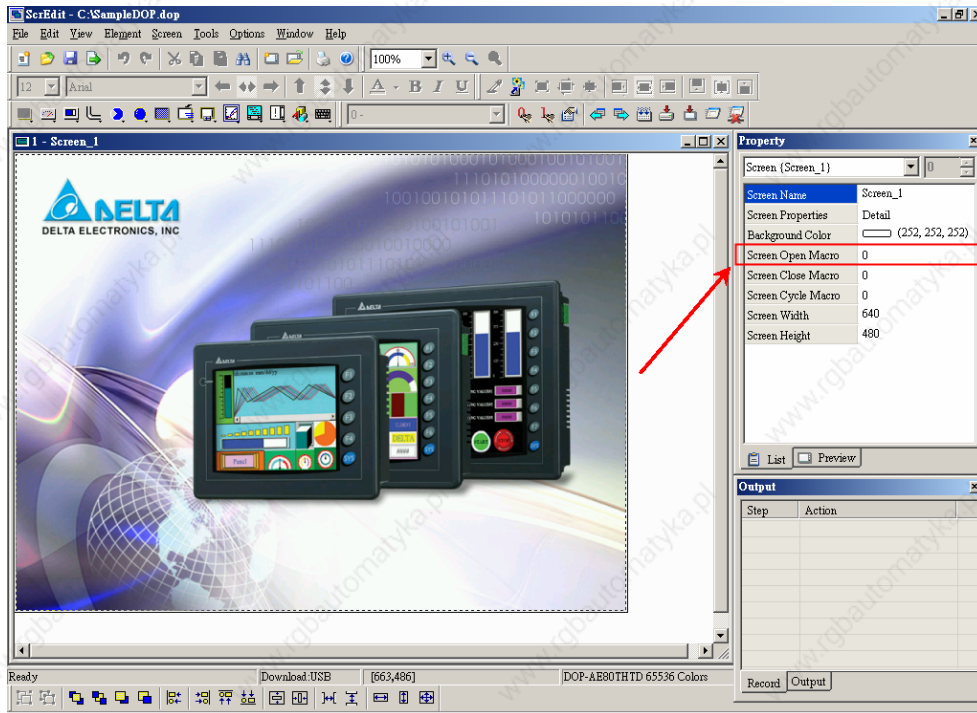


Fig. 2.7.24 Choosing Screen Open Macro from docking windows

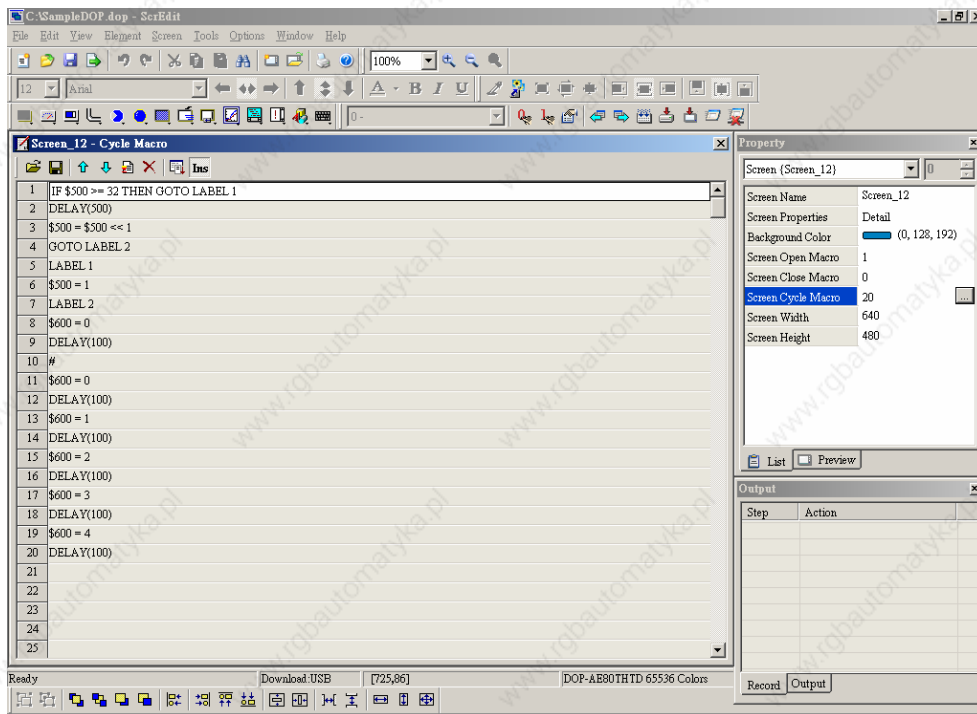


Fig. 2.7.25 Screen Open Marco editing environment

■ **Screen Close Macro**

Screen Close Macro

When **Screen Close Macro** function is selected, the Macro will be executed automatically once screen get closed. (Please refer to Chapter 4 for the usage and editing method of Macro.)

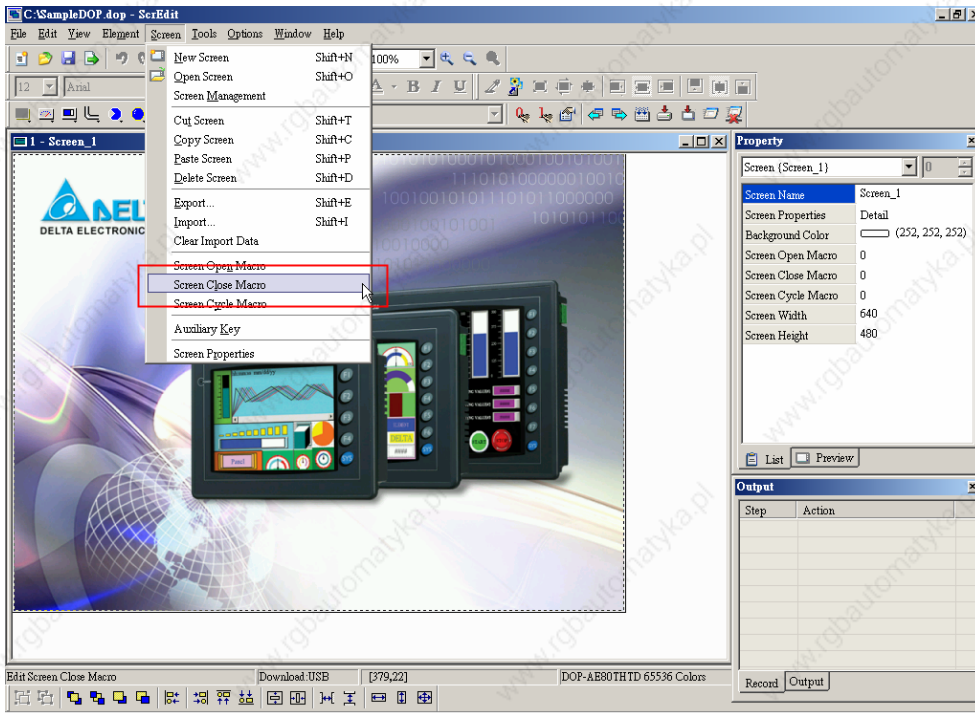


Fig. 2.7.26 Choosing Screen Close Macro command from menu bar

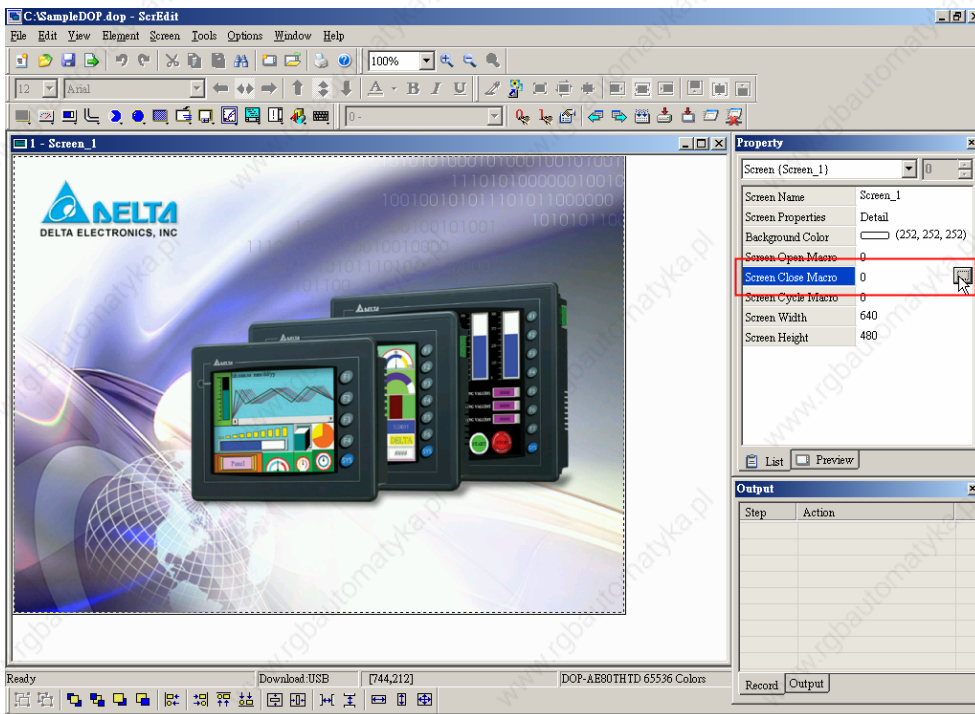


Fig. 2.7.27 Choosing Screen Close Macro from docking windows

■ **Screen Cycle Macro**

Screen Cycle Macro

When **Screen Cycle Macro** function is selected, the Macro will be executed periodically once screen get displayed. (Macro will be executed periodically by cycle time setting) (Please refer to Chapter 4 for the usage and editing method of Macro.)

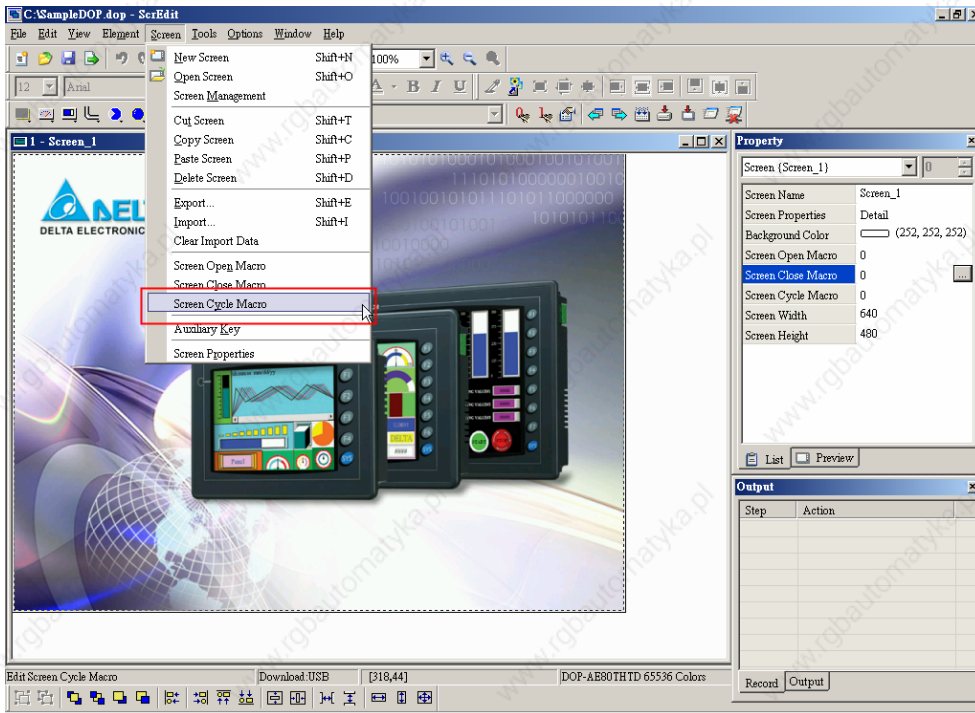


Fig. 2.7.28 Choosing Screen Cycle Macro command from menu bar

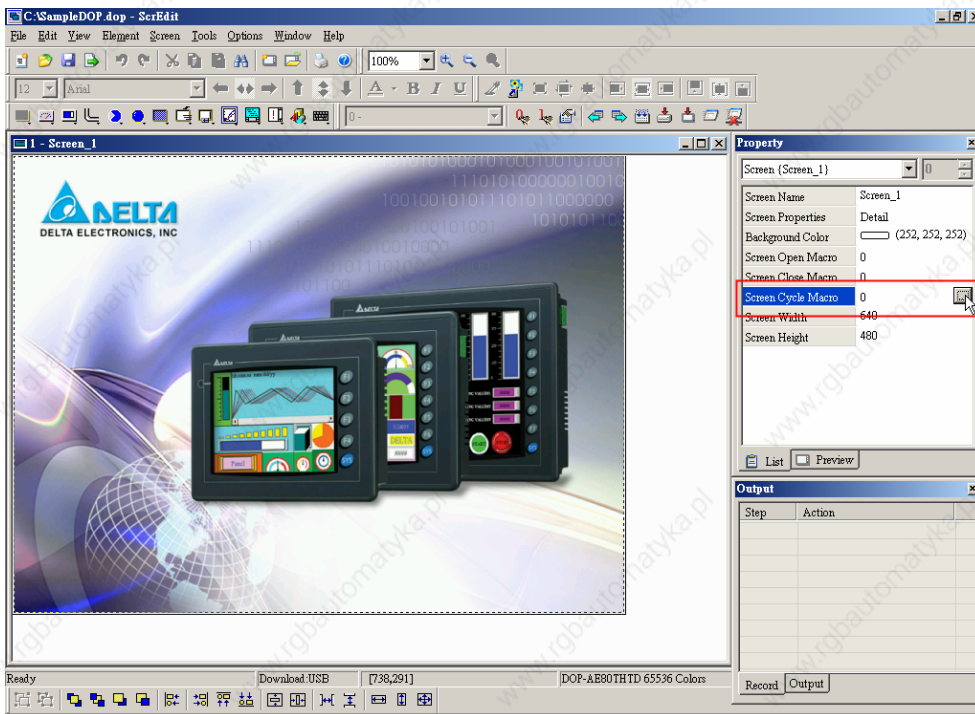


Fig. 2.7.29 Choosing Screen Cycle Macro from docking windows

■ **Auxiliary Key**

Auxiliary Key

DOP series HMI allows the users can determine the function of auxiliary keys in each screen. The users can execute this function by clicking **Screen > Auxiliary Key** (Fig. 2.7.30). Auxiliary key set up for each screen can be completed by pressing the auxiliary keys on HMI panel (Fig. 2.7.31) or on the screen (Fig. 2.7.32).

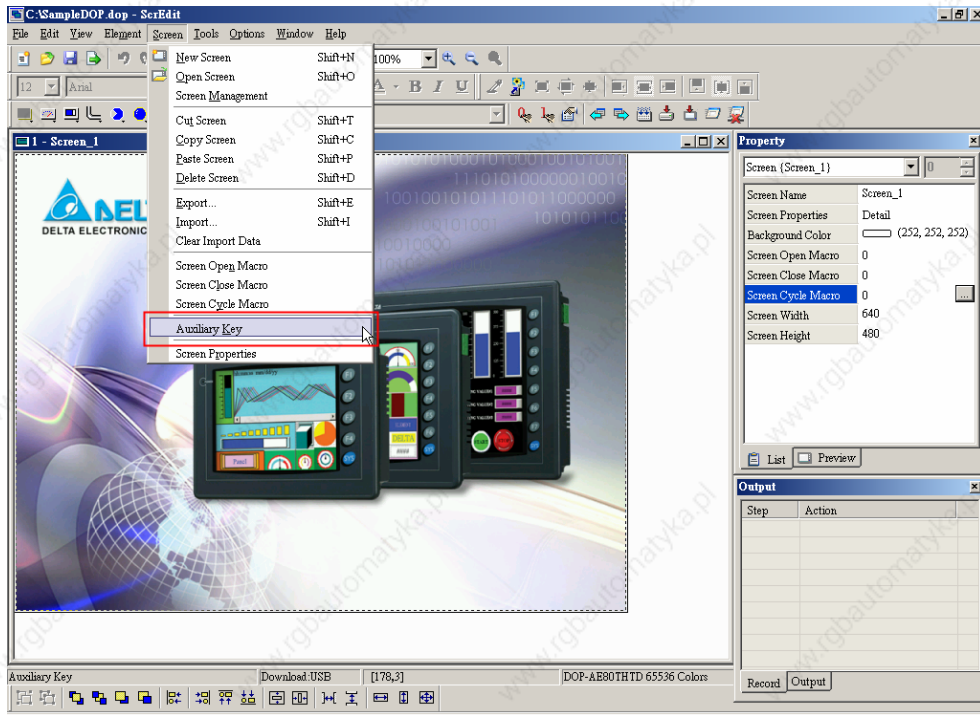


Fig. 2.7.30 Choosing Auxiliary Key command from menu bar



Fig. 2.7.31 Auxiliary Keys on HMI panel

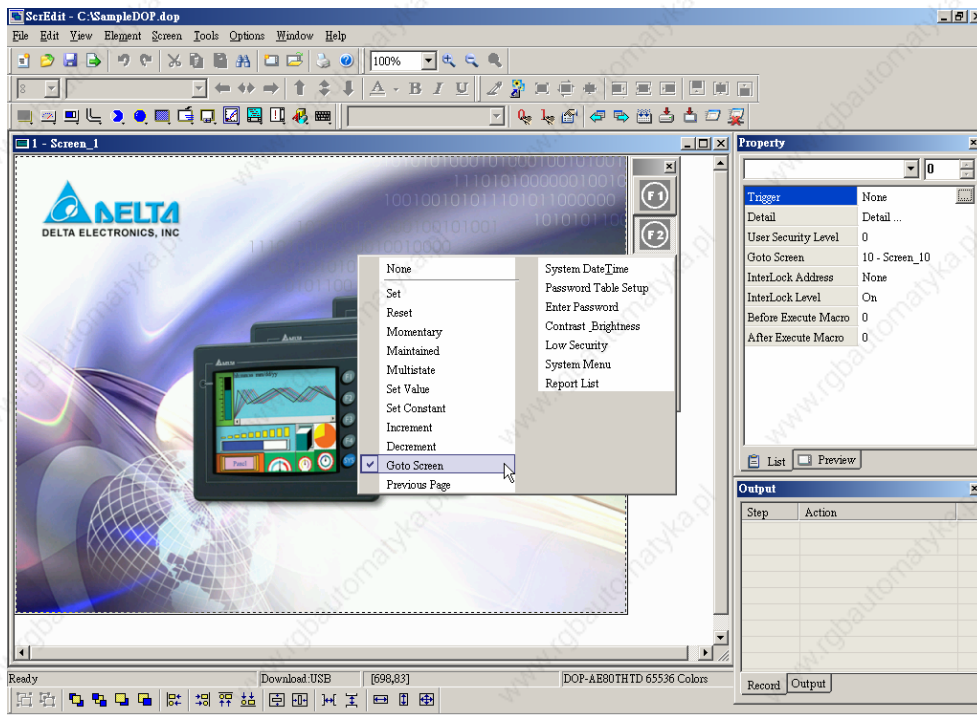


Fig. 2.7.32 Auxiliary Key setting on the screen

In Table 2.7.1, the users can know how many user-defined auxiliary keys are available for each model.

Table. 2.7.1 Available user-defined auxiliary keys

DOP-A Series Model Name	Available User-defined Auxiliary Keys
DOP-A57BSTD	4
DOP-A57GSTD	4
DOP-A57CSTD	4
DOP-A75CSTD	6
DOP-A10TCTD	7
DOP-AE Series Model Name	Available User-defined Auxiliary Keys
DOP-AE57BSTD	4
DOP-AE57GSTD	4
DOP-AE57CSTD	4
DOP-AE80THTD	6
DOP-AE10THTD	7

■ **Screen Properties**

Screen Properties

The users can decide the properties of the current editing screen by clicking **Screen > Screen Properties** (Fig. 2.7.33) or choosing **Screen Properties** from docking windows to set the current screen (Fig. 2.7.34). For the setting of Screen Properties, please refer to Table 2.7.2.

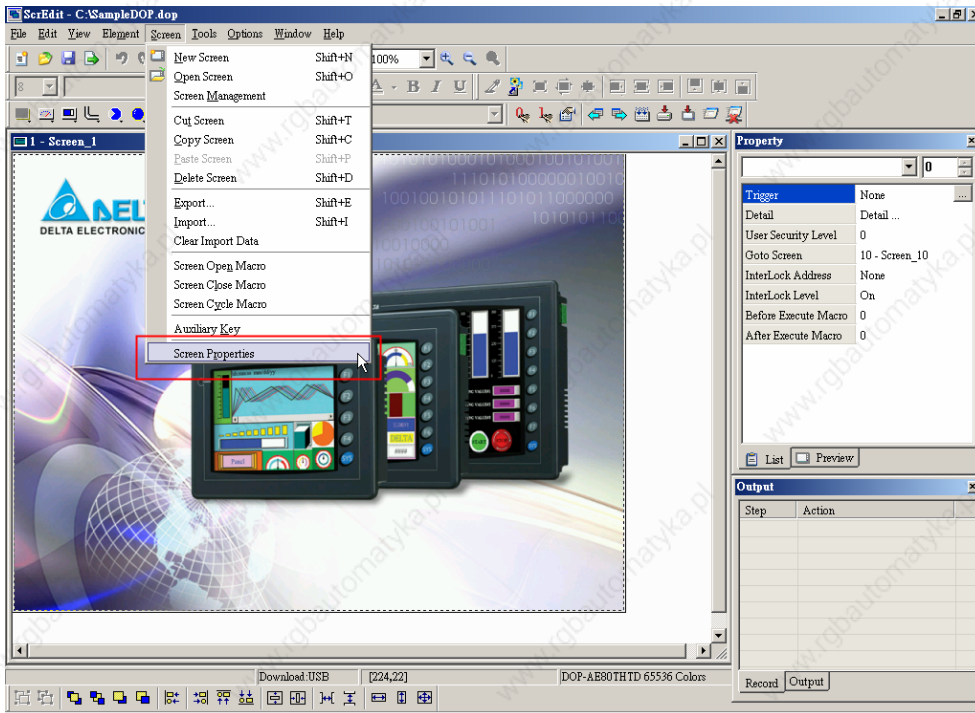


Fig. 2.7.33 Choosing Screen Properties command from menu bar

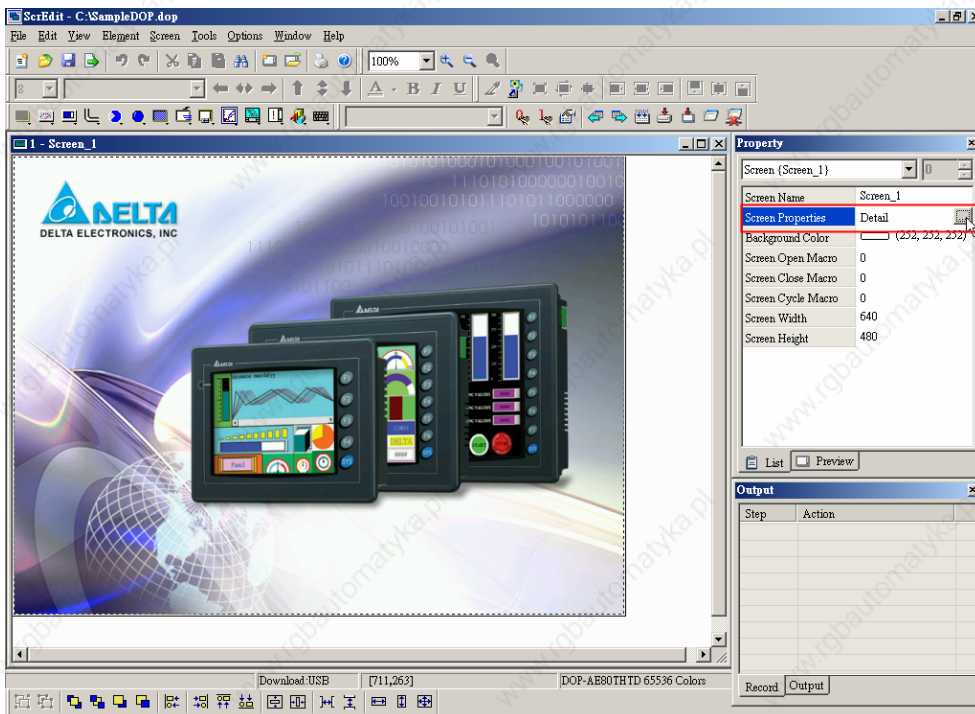


Fig. 2.7.34 Choosing Screen Properties from docking windows

Table. 2.7.2 Screen Properties setting

Function		Description
Screen Number		The screen number range is within 1~65535 and the number cannot be repeated.
Screen Application	General View Screen	Regarded as general view screen. The element created by the users can be downloaded to HMI after compile operation and display on HMI LCD display. The input type element, such as Button, Input and Keypad can be pressed on HMI display and used to execute print function.
	Apply Print Screen	<ol style="list-style-type: none"> 1. Regarded as print screen. The printer can print the element created by the users after compile operation. This option is only available in DOP-AE series HMI and only can be enabled after the printer is set. For the setting of the printer, please click Option > Configuration > Print (Fig. 2.7.35). 2. When Apply Print Screen function is selected, the editing range will be scaled to the actual paper size of the printer. The users can only print the elements within the range of the paper size. When the users select this option, all history data or sampling records of the editing elements can be printed out. This option is usually used for print typesetting. <p>The users can find printer setting by clicking Option > Configuration > Print shown as Fig. 2.7.35 below.</p>

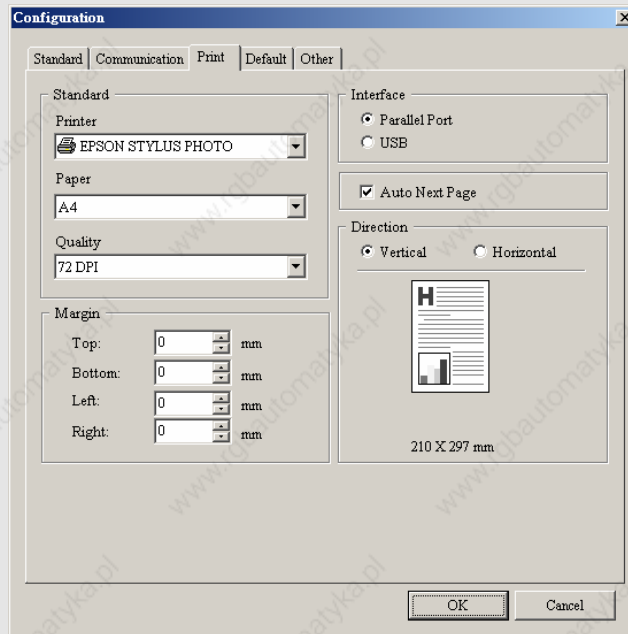
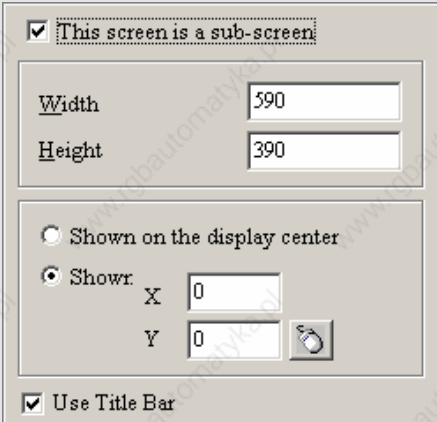




Fig. 2.7.35 Print tab in Configuration option

Function		Description
Sub-screen Setting	Check the check box next to “This screen is a sub-screen”	<p>The check box next to “This screen is a sub-screen” can be checked only when General View Screen option is selected. Therefore, before setting sub-screen function, please ensure General View Screen option is selected.</p>  <p>Fig. 2.7.36 Sub-screen setting</p>
Screen Width		It is used to set the width of sub-screen and the unit is Pixel.
Screen Height		It is used to set the height of sub-screen and the unit is Pixel.
Sub-screen Position		<p>The users can decide the sub-screen is shown on the center position of HMI display or specify the display position freely. Only input the coordinate value directly (X and Y axis) or press the mouse button  to drag the sub-screen to the position the users decided (Fig. 2.7.37).</p>  <p>Fig. 2.7.37 Sub-screen position</p>
Title Bar		When the check box next to “Use Title Bar” is checked, the title bar will be shown when opening sub-screen.
Cycle Macro Delay Time		It is used to set Cycle Macro Delay Time when this screen is executed every time. The range of the cycle macro delay time is within 100ms ~ 5s.
Fast Refresh Rate		There are three levels of the Fast Refresh Rate and they are High, Medium and Low. The purpose of this function is used to make some elements can be displayed immediately when switching screen. Please notice that it only allows four elements can be renewed immediately in each screen.

Function		Description
Hard Copy Region	Setting	The users can find this function in DOP-AE series HMI only. If the users want to enable this function, setting the printer in advance is necessary. Please go to Option > Configuration > Print (Fig. 2.7.35) and select the printer first. When this function is enabled, if one report list button is created and its assigned output device is a printer, HMI will check for the screen that print typesetting has been executed and check if it is necessary to output the screen to the printer for printing out. If the screen without print typesetting needs to be output to HMI, HMI will refer to the setting in Hard Copy Region option and execute the screen-printing.
	Top-Left	It is used to set the region of HMI printing area (also called Hard Copy Region) and the unit is Pixel.
	Right-Bottom	
Base Screen	Check the check box next to "Need a base screen"	Every screen can specify any one of editing screen as base screen. When the check box next to "Need a base screen" is checked, the base screen will be moved to the back (behind all other elements) as a ground picture. After compile operation is completed and the screen data is downloaded to HMI, HMI will execute all of the elements on the base screen correctly.

2.8 Menu Bar and Toolbar (Tools)

■ Tools



Fig. 2.8.1 Tools options

■ Compile



It is used to compile editing screen to the format for HMI. If this application is a new application, it will remind the users of saving before compiling. If this application has been saved or it is an old application, it will compile directly. During compiling, all of the compiling messages, including any errors, will be written to output field. An object file would be produced if there were no error during compiling process. The users can execute this function by clicking **Tools > Compile** (Fig. 2.8.2) or clicking icon directly (Fig. 2.8.3) or using keyboard shortcuts by pressing **Ctrl + F7**.

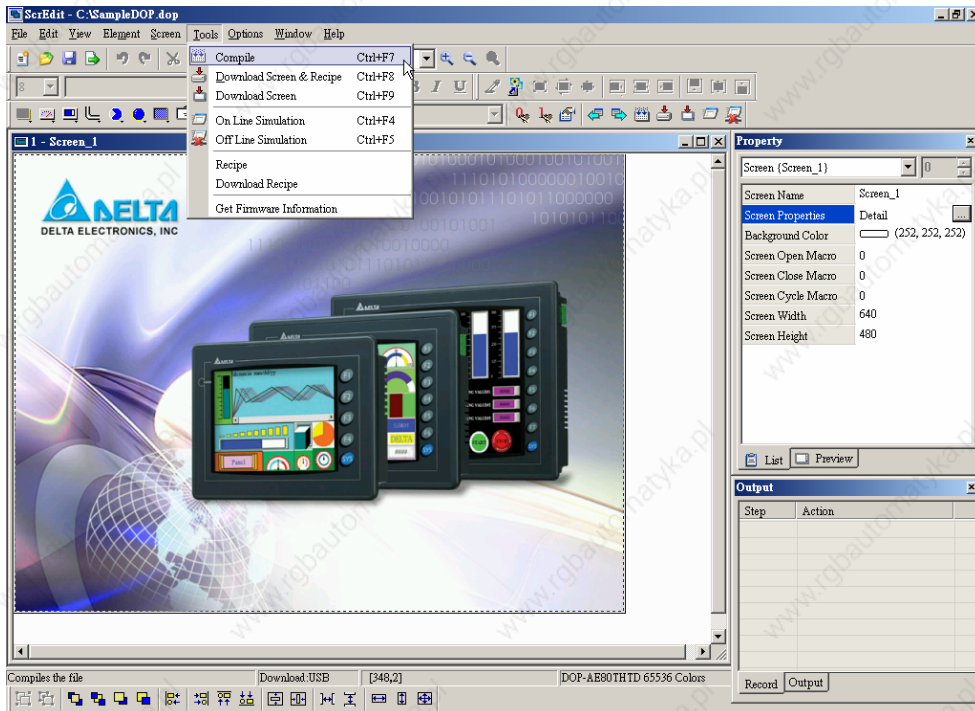


Fig. 2.8.2 Choosing Compile command from menu bar

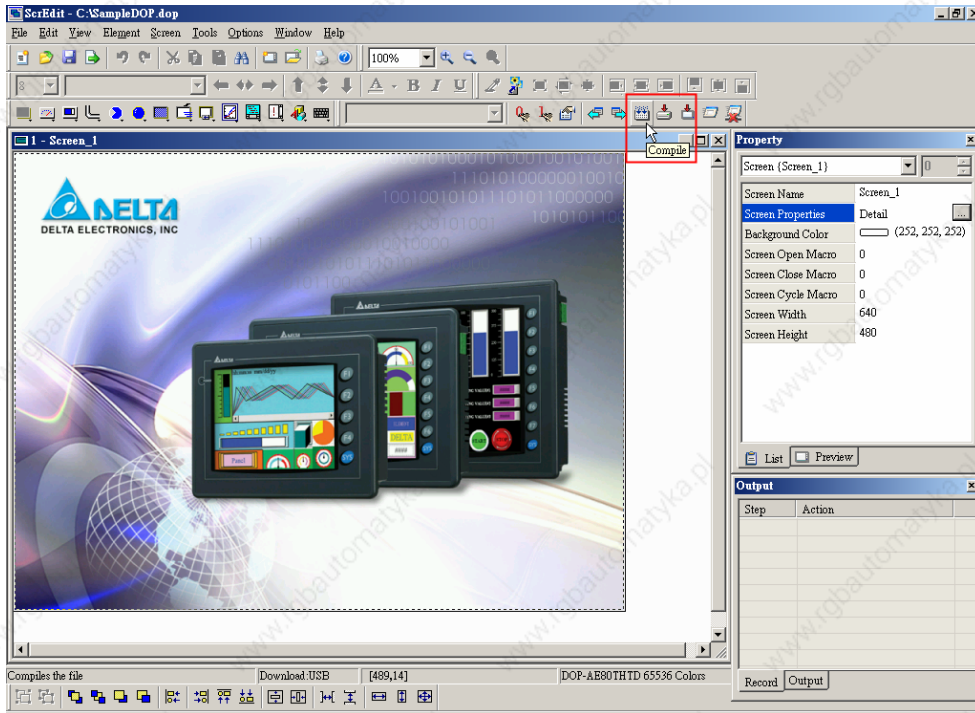


Fig. 2.8.3 Choosing Compile icon from toolbar

Table 2.8.1 Debug Compiling Error

Debug Compiling Error during Compiling Process

1. Create a new application.
2. Create two editing screens.
3. Create a button element on these two screens respectively and do not change the element default property as the Fig. 2.8.4 below.

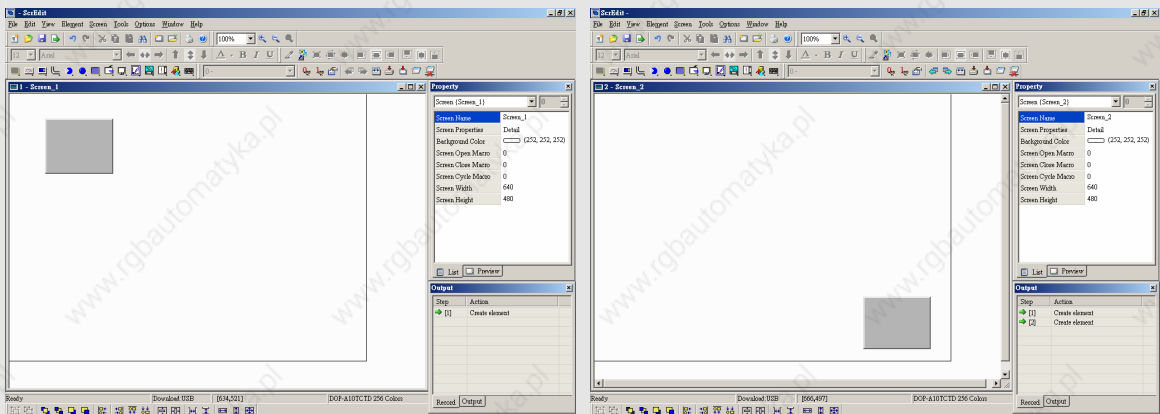



Fig. 2.8.4

Debug Compiling Error during Compiling Process

- When pressing  icon to execute compile operation, error message dialog box will pop up to warn the users of compiling error and show how many errors there are. In Fig. 2.8.5, we can see that there are two errors occurred and they are all displayed in the output window.

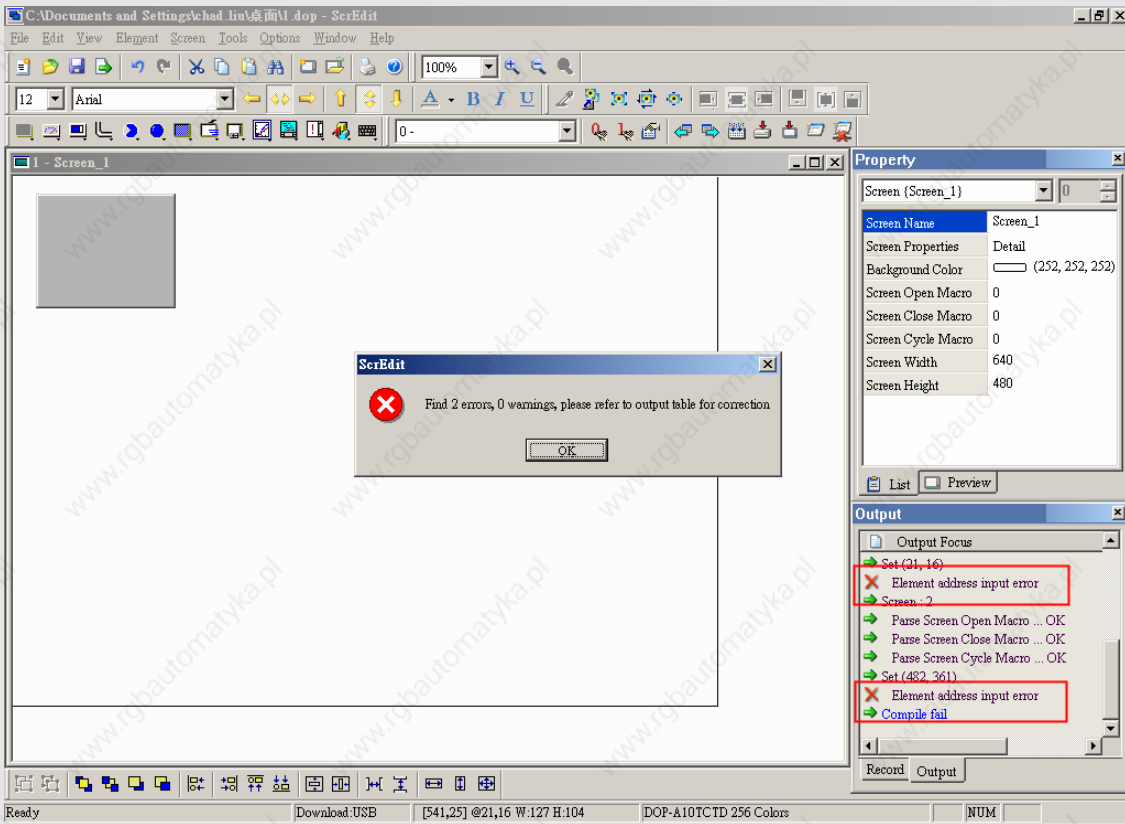



Fig. 2.8.5 Compiling errors during compiling process

- Once error occurs, the correspondent message will display in output window. The users can click the error message and ScrEdit will switch to error element window automatically.

■ **Download Screen & Recipe**



The users can download screen data and recipe to HMI by clicking **Tools > Download Screen & Recipe** (Fig. 2.8.6) or

clicking  icon directly (Fig. 2.8.7) or using keyboard shortcuts by pressing **Ctrl + F8**. If PC cannot connect to HMI, the error messages will display and warn the users (Fig. 2.8.9 and Fig. 2.8.10). The users can set download interface by clicking **Options > Configuration** or by clicking **Options > Environment**. The download interface can be USB or RS-232.

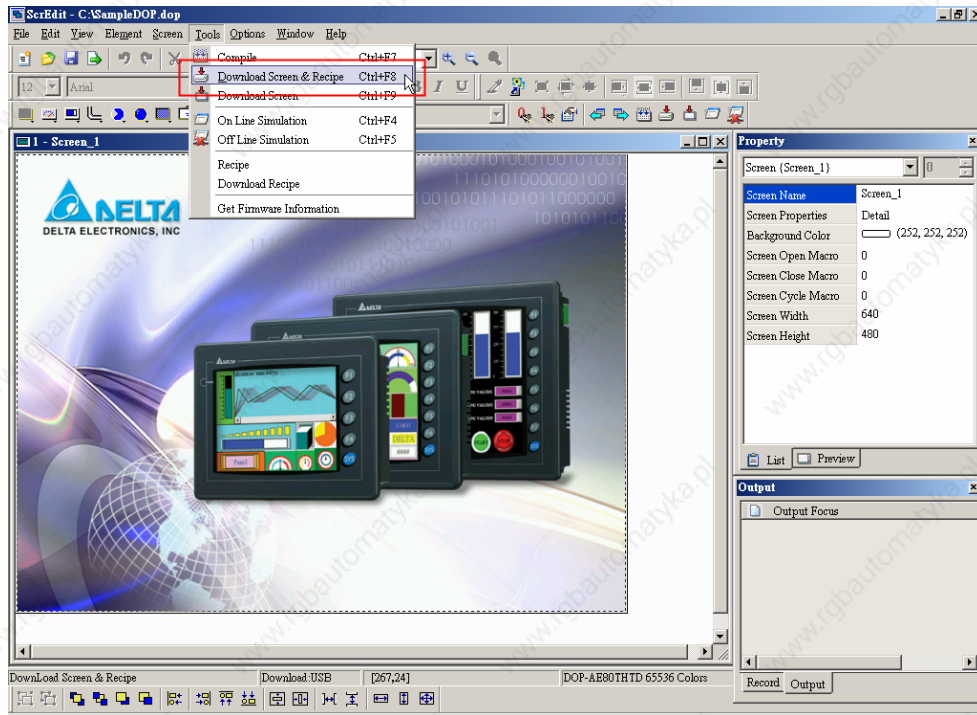


Fig. 2.8.6 Choosing Download Screen & Recipe command from menu bar

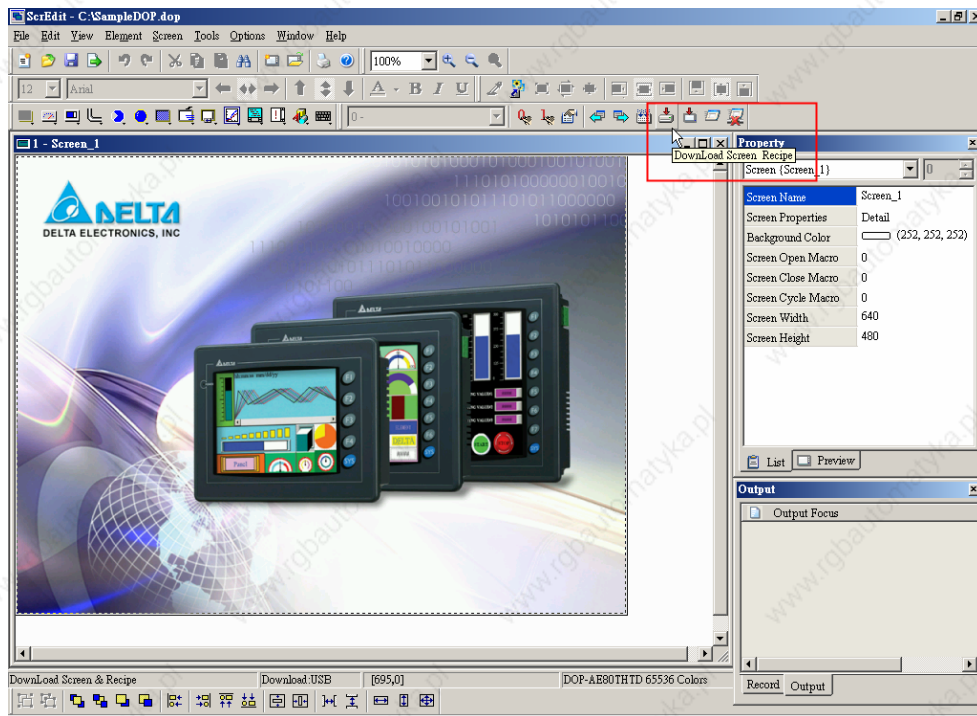


Fig. 2.8.7 Choosing Download Screen & Recipe icon from toolbar

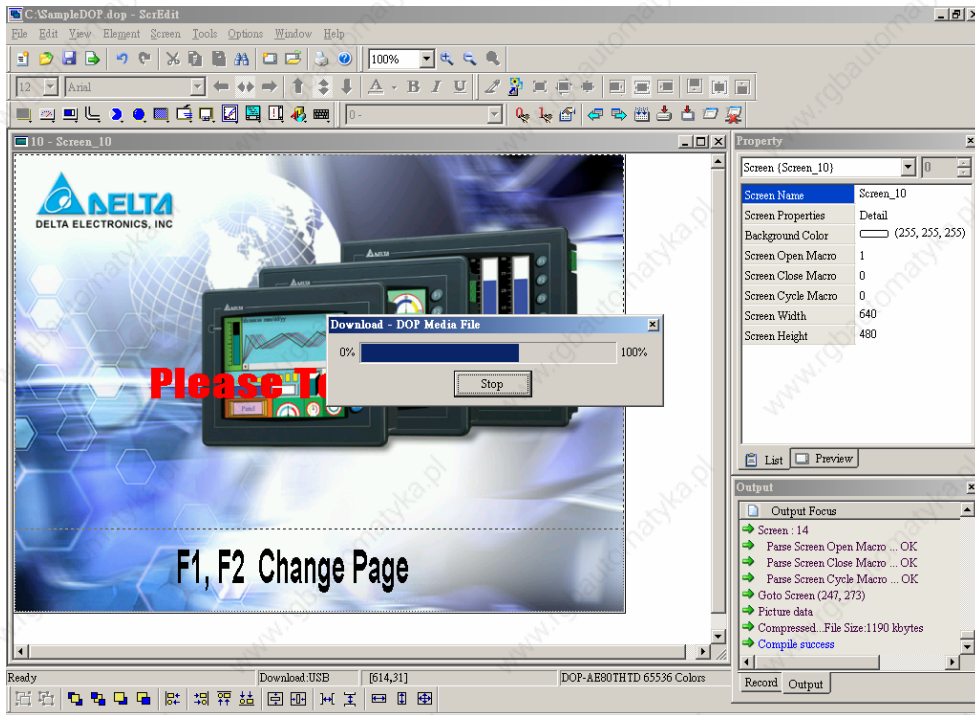


Fig. 2.8.8 Start to download (the progress will be from 0 to 100%)

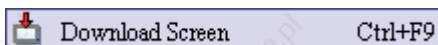



Fig. 2.8.9 USB open error message



Fig. 2.8.10 USB disconnect error message

■ Download Screen



It is only used to download screen data to HMI. The users can execute it by clicking **Tools > Download Screen** (Fig. 2.8.11) or clicking icon  directly (Fig. 2.8.12) or using keyboard shortcuts by pressing **Ctrl + F9**. For the download screen, please refer to Fig. 2.8.8 above.

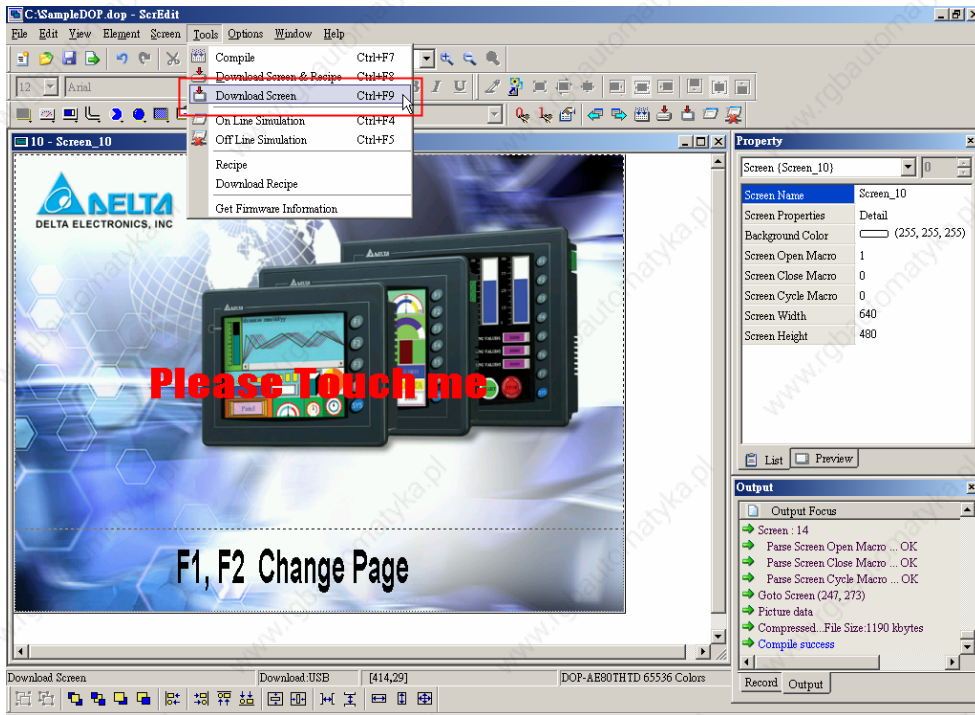


Fig. 2.8.11 Choosing Download Screen command from menu bar

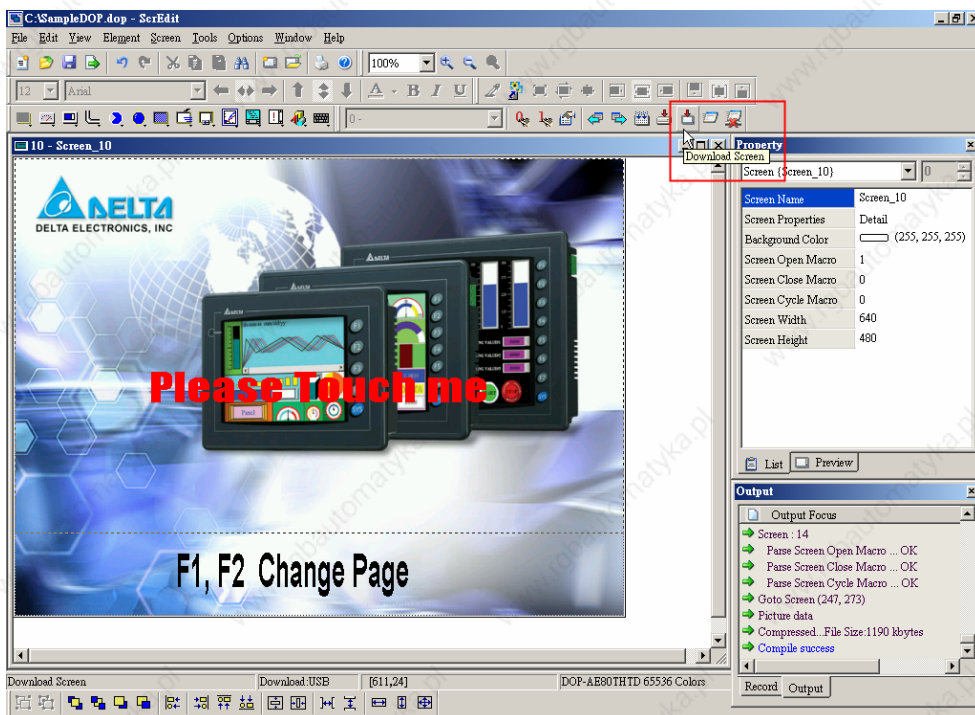




Fig. 2.8.12 Choosing Download Screen icon from toolbar

■ On Line Simulation

 On Line Simulation **Ctrl+F4**

It is used to simulate DOP series HMI by computer but HMI should also connect to PLC first to drive PLC by PC simulation through PC communication port (COM1 and 2). Therefore, the users cannot execute online simulation without connecting PLC. But the users can execute offline simulation without connecting PLC. On Line Simulation function can execute by clicking **Tools**

> **On Line Simulation** (Fig. 2.8.13) or clicking  directly (Fig. 2.8.14) or using keyboard shortcuts by pressing **Ctrl + F4**. For On Line Simulation Screen, the users can refer to Fig. 2.8.15 below.

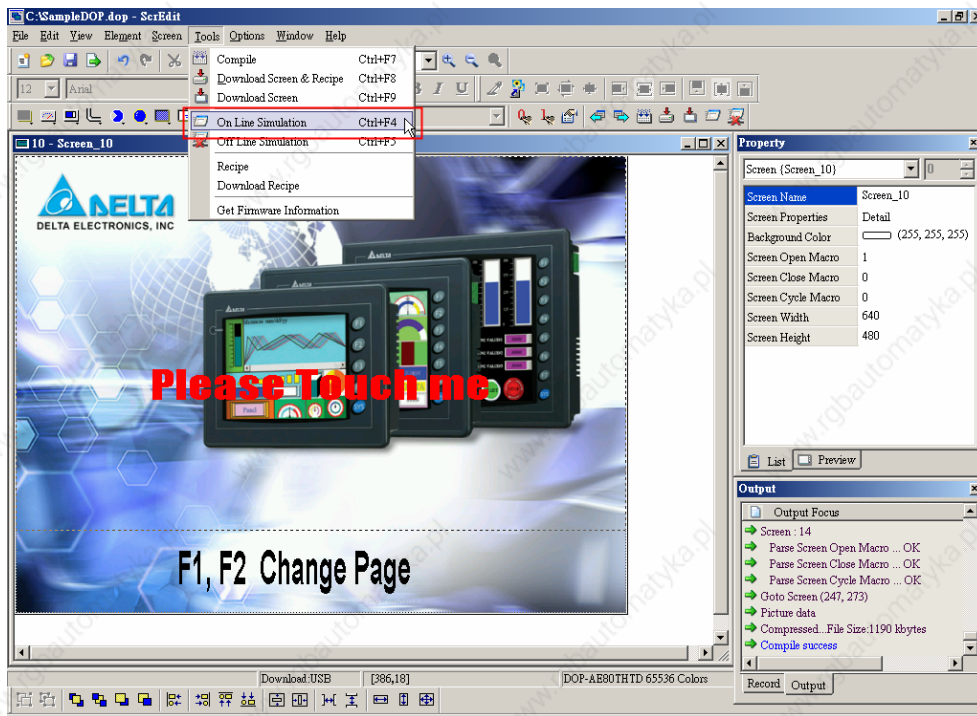


Fig. 2.8.13 Choosing On Line Simulation command from menu bar

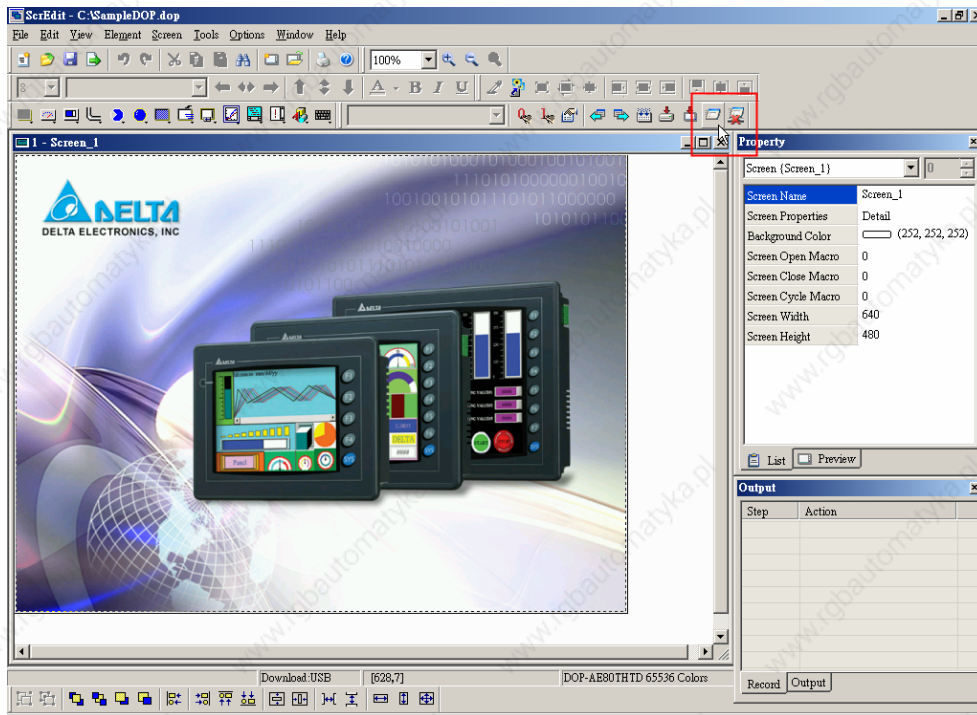
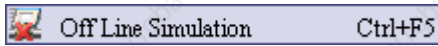


Fig. 2.8.14 Choosing On Line Simulation icon from toolbar




Fig. 2.8.15 On Line Simulation Screen

■ Off Line Simulation



It is used to test if the editing screen, read/write addresses and Macro on is correct on developed program without connecting to PLC. The users can execute this function by clicking **Tools > Off**

Line Simulation (Fig. 2.8.16) or clicking icon  (Fig. 2.8.17) or using keyboard shortcuts by pressing **Ctrl + F5**.

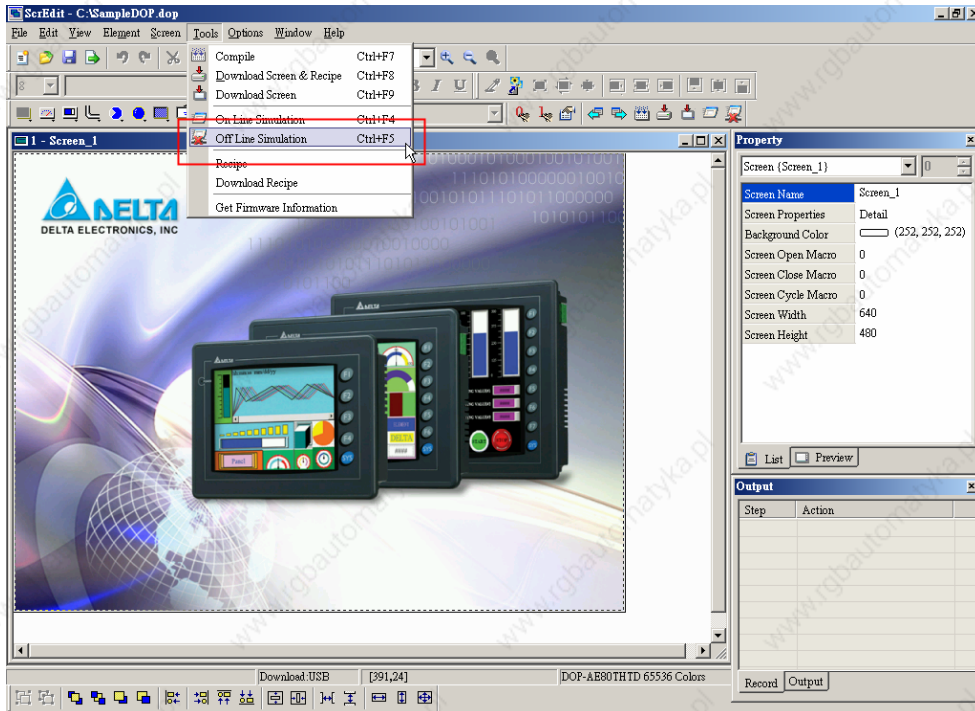


Fig. 2.8.16 Choosing Off Line Simulation command from menu bar

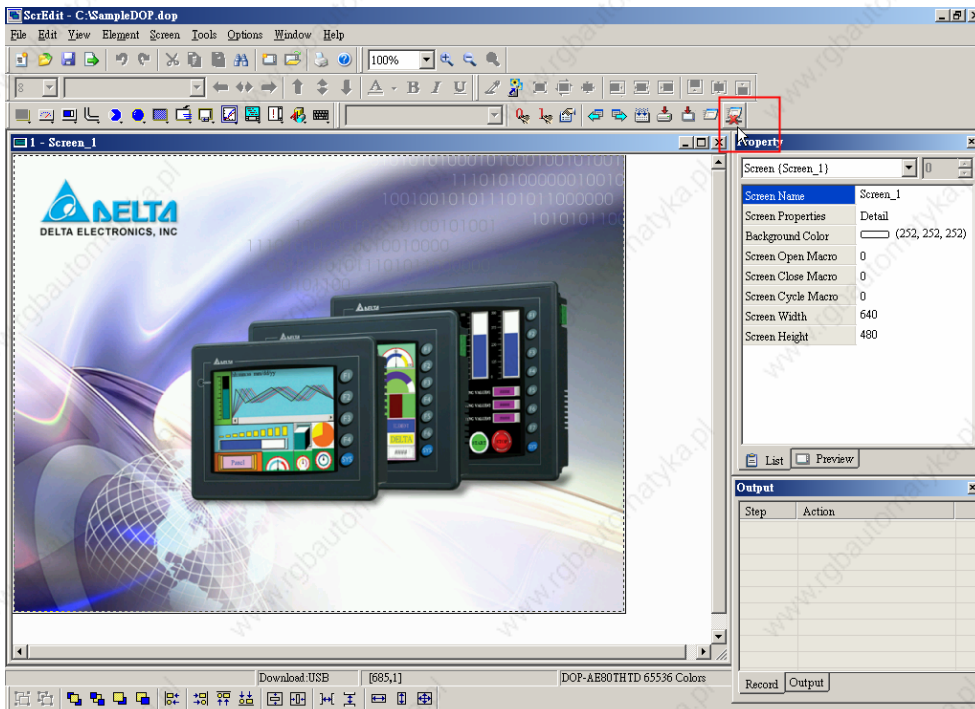


Fig. 2.8.17 Choosing Off Line Simulation icon from toolbar

■ Recipe

Recipe

Recipe function provides the controller a convenient parameter input method. The users can transmit the designated parameter to the controller by using HMI recipe after finishing editing recipe. Recipe can be set and modified by recipe dialog box and can be saved and used independently without application. Therefore, recipes can be used for all brands of models. Before using recipe, the users should enable recipe function first by clicking **Tools > Recipe** (Refer to Fig. 2.8.18). After the recipe function is enabled, the **Recipe Setup** dialog box will pop up (Fig. 2.8.19) and then the users can start to edit the recipe. For the setting of Recipe Setup dialog box, please refer to Table 2.8.2 below.

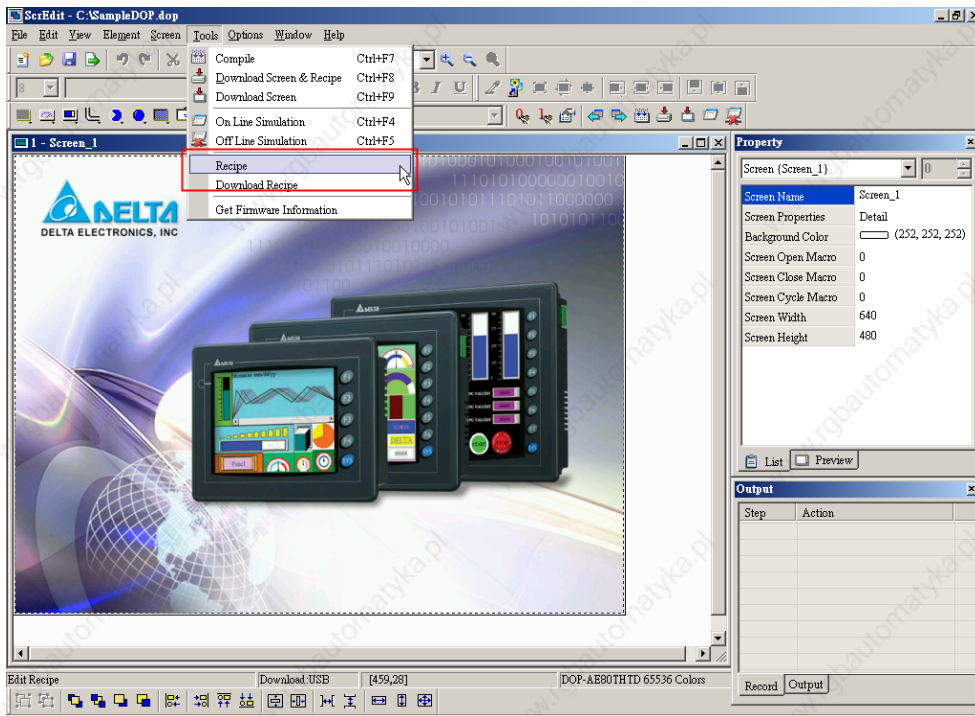


Fig. 2.8.18 Choosing Recipe command from menu bar

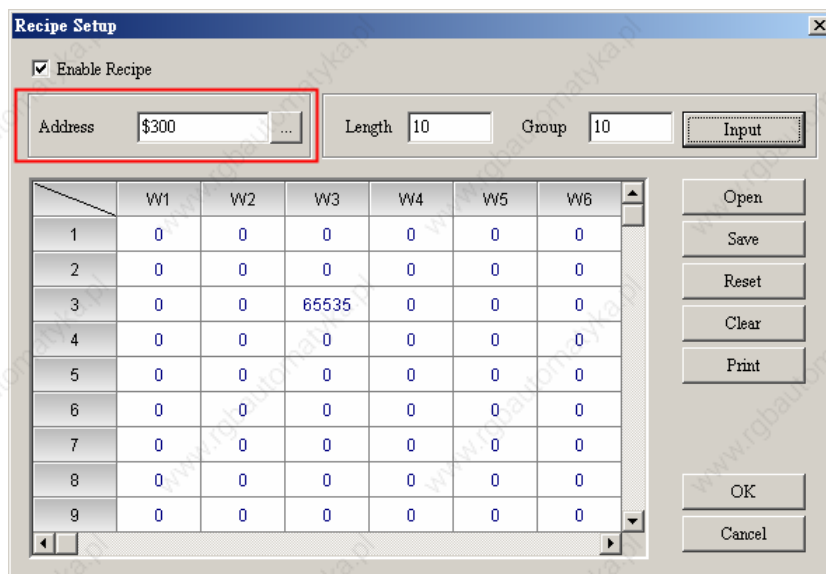


Fig. 2.8.19 Recipe Setup dialog box

In Fig. 2.8.19, there are 10 groups of parameter inputs and the length for each group is 10 WORDs. The users can determine which group is transmitted to PLC designated address (circled in red color in Fig. 2.8.19) by HMI recipe parameter.

■ **Download Recipe**

Download Recipe

Downloads recipe to HMI. It can save time when the users want to download recipe date only. What the users need to do is to click **Tools > Download Recipe** and then the recipe data can be downloaded to HMI. The general extension name of recipe file is rcp (Fig. 2.8.20).

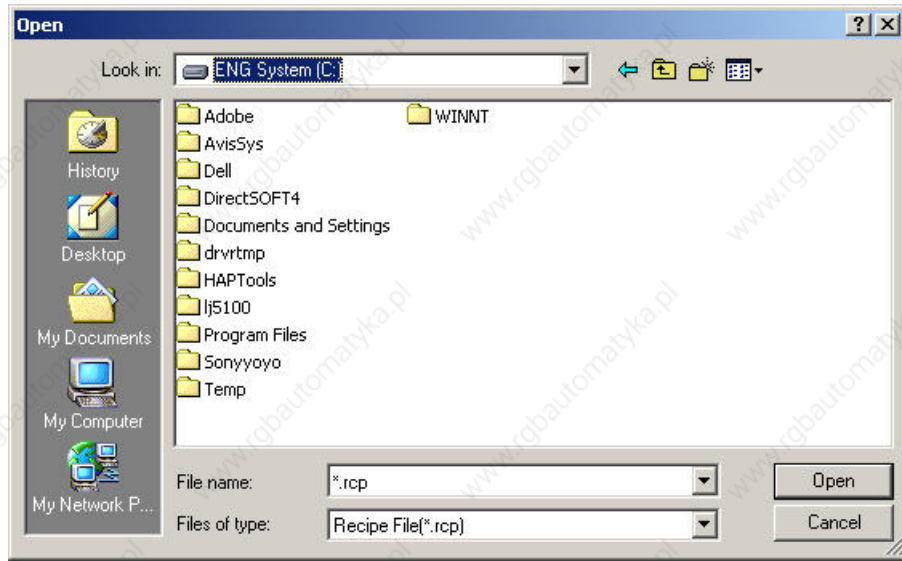
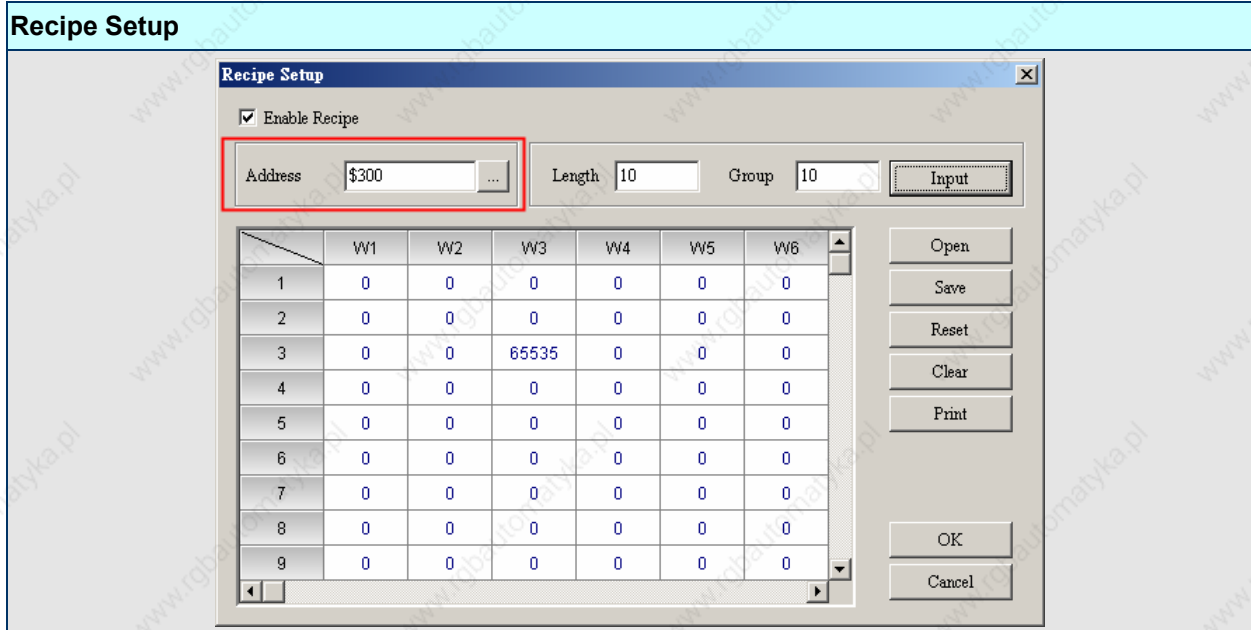



Fig. 2.8.20 Download Recipe

Table 2.8.2 Recipe Editing



Enable Recipe When the check box next to “Enable Recipe” is checked, the recipe function is enabled. If the users do not enable this function, the users can not do this function even the users have downloaded recipe data.

Address The users can input the starting address of recipe data here. It can accept the address in PLC input format and internal memory format. The users also can click  button to get the address input dialog box shown as (Fig. 2.8.21) to input starting address.

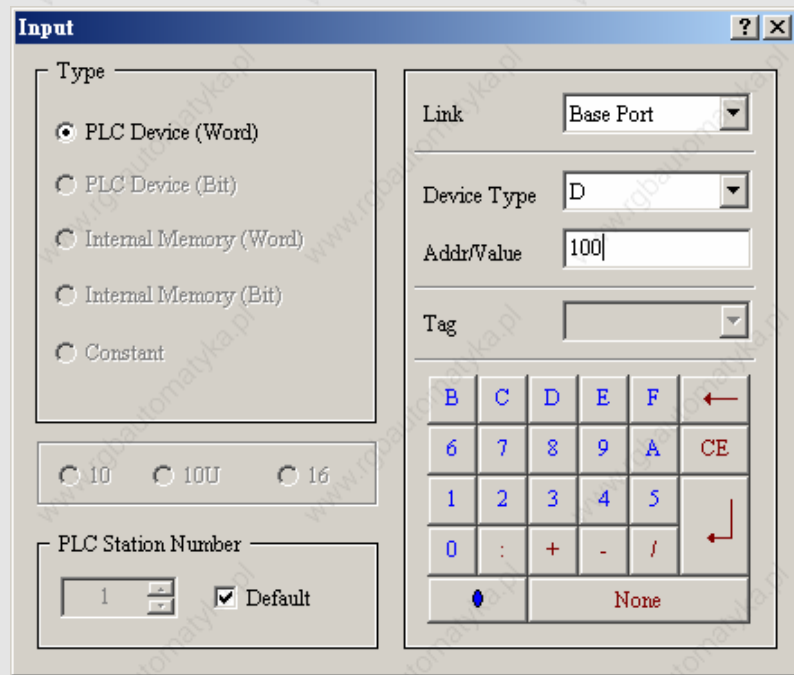





Fig. 2.8.21 Input starting address dialog box

Recipe Setup	
Length	<p>It is used to set the recipe length. The unit is word and it should be set to more than 0. Otherwise, the following dialog box shown as Fig. 2.8.22 will display on the screen.</p> <div style="text-align: center;">  <p>The dialog box has a title bar 'ScrEdit' with a close button. It contains a red 'X' icon, the text 'Min. Length must > 0', and an 'OK' button.</p> </div> <p style="text-align: center;">Fig. 2.8.22 Length input error message</p>
Group	<p>It is used to set group number of recipe. It is convenient for the users to use recipe by switching. The group number should be set to more than 0. Otherwise, the following dialog box shown as Fig. 2.8.23 will display on the screen.</p> <div style="text-align: center;">  <p>The dialog box has a title bar 'ScrEdit' with a close button. It contains a red 'X' icon, the text 'Min. Group must > 0', and an 'OK' button.</p> </div> <p style="text-align: center;">Fig. 2.8.23 Group input error message</p>
Input	<div style="text-align: right; margin-bottom: 5px;"> <input type="button" value="Input"/> </div> <p>After setting length and group number of recipe, the users can click <input type="button" value="Input"/> button to edit the recipe data. The memory size for recipe is limited. When the Hold Data Place is selected as SRAM, the memory size for recipe is 64K. It indicates that the total recipe size should be less than 64K. (Length x groups should be less than 64 X 1024) If one of them is 0 or exceeds the limit, the users will see a warning message shown as Fig. 2.8.24 displayed on the screen.</p> <div style="text-align: center;">  <p>The dialog box has a title bar 'ScrEdit' with a close button. It contains a red 'X' icon, the text 'The Length size and Group size should be less than 64K word', and an 'OK' button.</p> </div> <p style="text-align: center;">Fig. 2.8.24 Input error message</p> <p>Some HMI, such as DOP-AE80THTD、DOP-AE10THTD support USB host function. It indicates that these models have a built-in USB host interface and the users can input more recipe data via this interface. However, there is still a limit for the input value of recipe length and groups. When Hold Data Place is selected as USB disk, the length x groups should be less than 4×1024×1024 (4Mbytes). The users can change the selection of Hold Data Place by clicking Options > Configuration > Standard. Please refer to Fig. 2.8.25 on next page.</p>

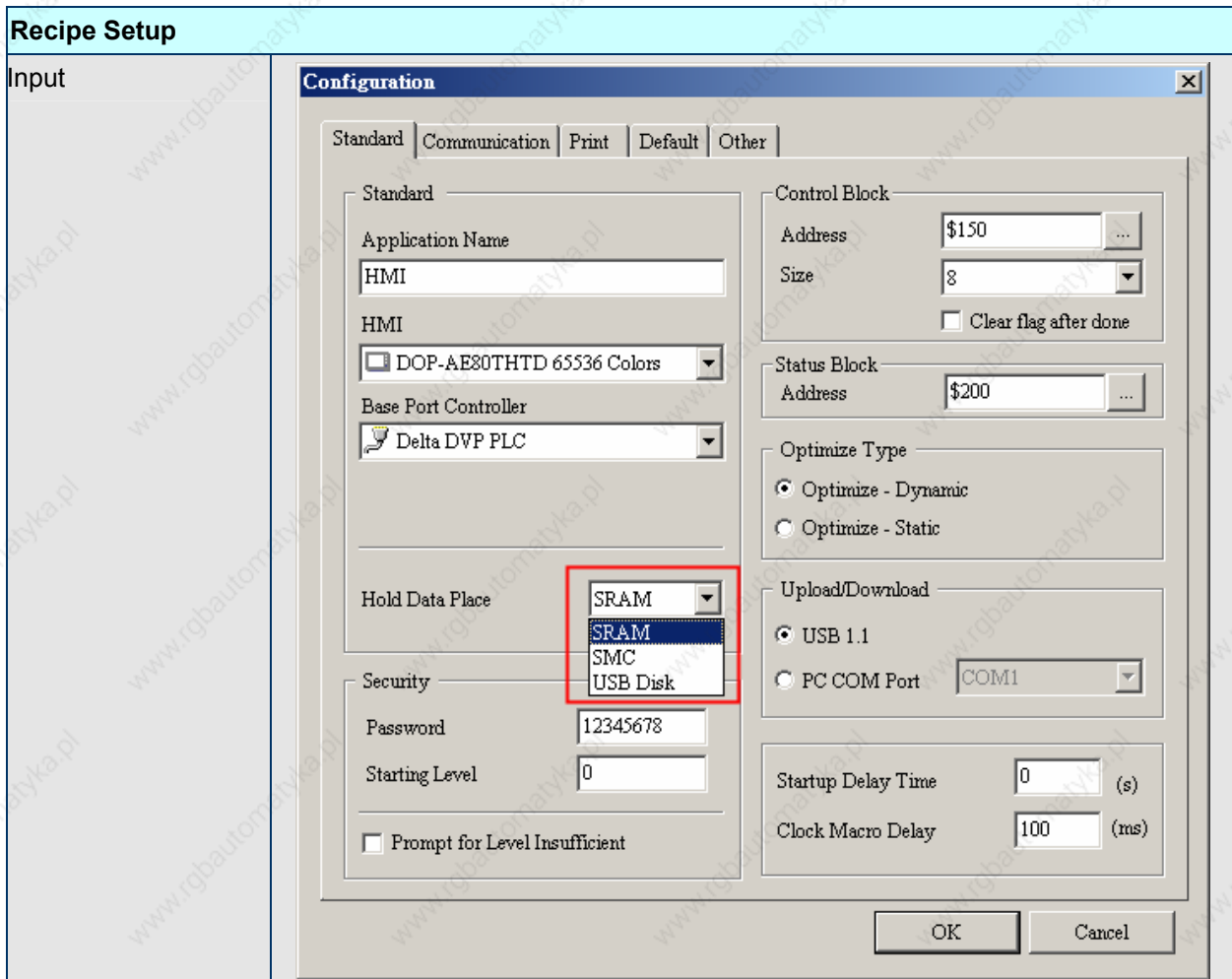


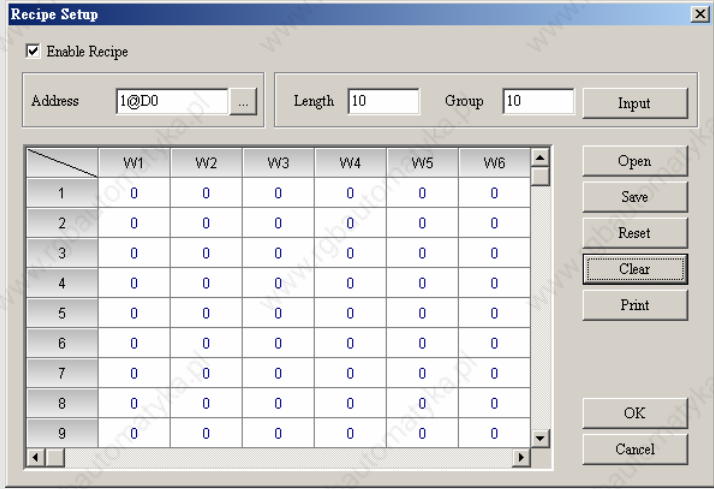

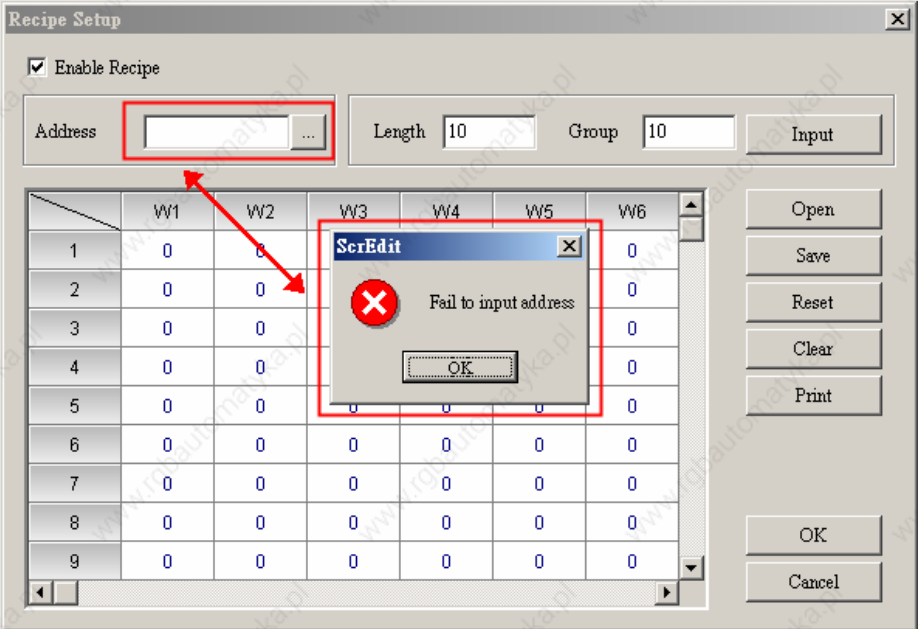
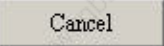


Fig. 2.8.25

<p>Open</p>	<p>The users can load recipe data by clicking  button. The loaded recipe data do not contain the starting address of recipe data. Therefore, regardless of which PLC brand connecting to HMI, they all can use the same recipe file. It also can open Windows® Excel CSV file.</p>
<p>Save</p>	<p>It is used to save the editing recipe data to be a file. When saving recipe file, the starting address will not be saved. This lets the users can use the same recipe file in the different PLC brand. The users also can save the recipe file as Windows® Excel CSV file.</p>
<p>Reset</p>	<p>When the users click  button, all related recipe setting and input recipe data will be deleted.</p>

Recipe Setup	
Clear	<p>All input recipe will be cleared to 0 (zero) when clear function is selected. Please refer to Fig. 2.8.26 below.</p>  <p style="text-align: center;">Fig. 2.8.26</p>
Print	<p>It will print all recipe data on current screen.</p>
OK	<p>After inputting the recipe data, the users can click  button to save the recipe data for transmitting or modifying. At the same time, ScrEdit will check the validity of all input recipe data. If there is invalid input recipe data value, the OK function will not be executed successfully. For example, in Fig. 2.8.27, ScrEdit find an error and a warning message dialog box display on the screen as the users do not input the address.</p>  <p style="text-align: center;">Fig. 2.8.27</p>
Cancel	<p>It will force to exit the Recipe Setup dialog box without saving anything after clicking  button. Therefore, please consider carefully before clicking this button.</p>

2.9 Menu Bar and Toolbar (Options)

Options

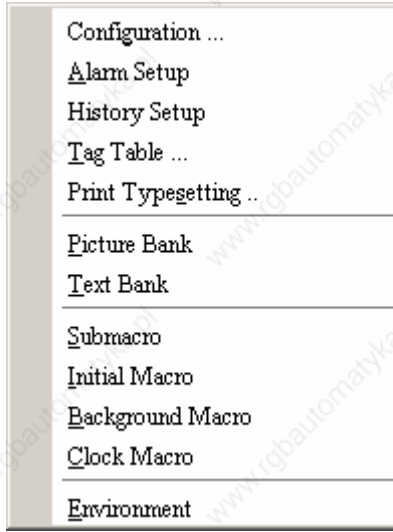
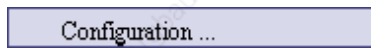


Fig. 2.9.1 Options options

Configuration



The users can execute this function by clicking **Options > Configuration** (Fig. 2.9.2). This dialog box is divided into five tabs: Standard, Communication, Print, Default and Other. These tabs are covered in detail in the following sections.

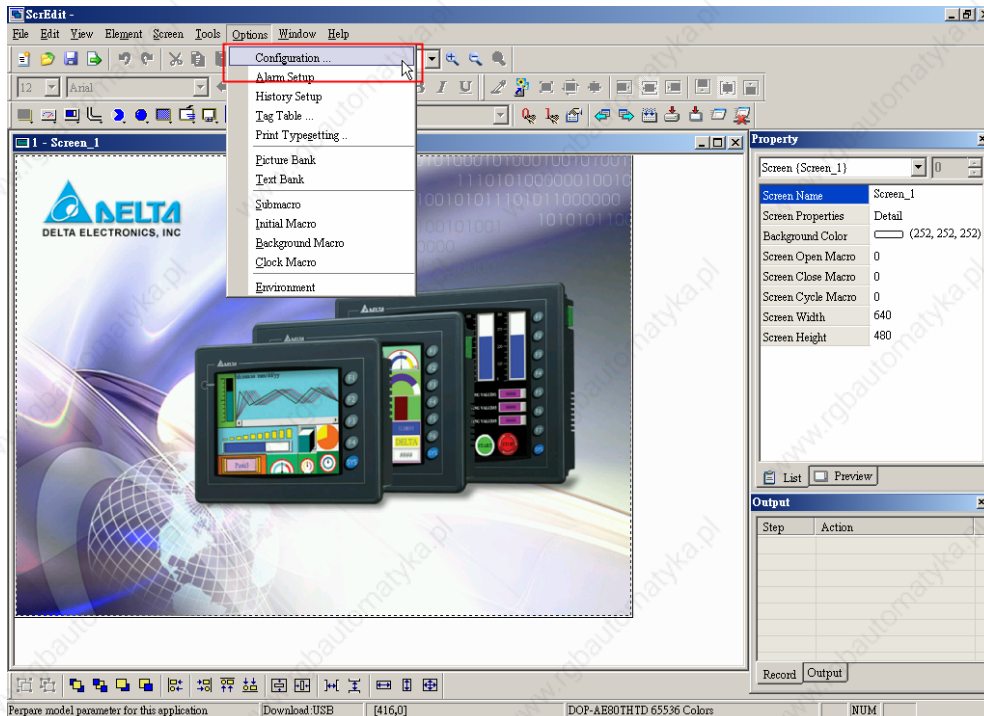
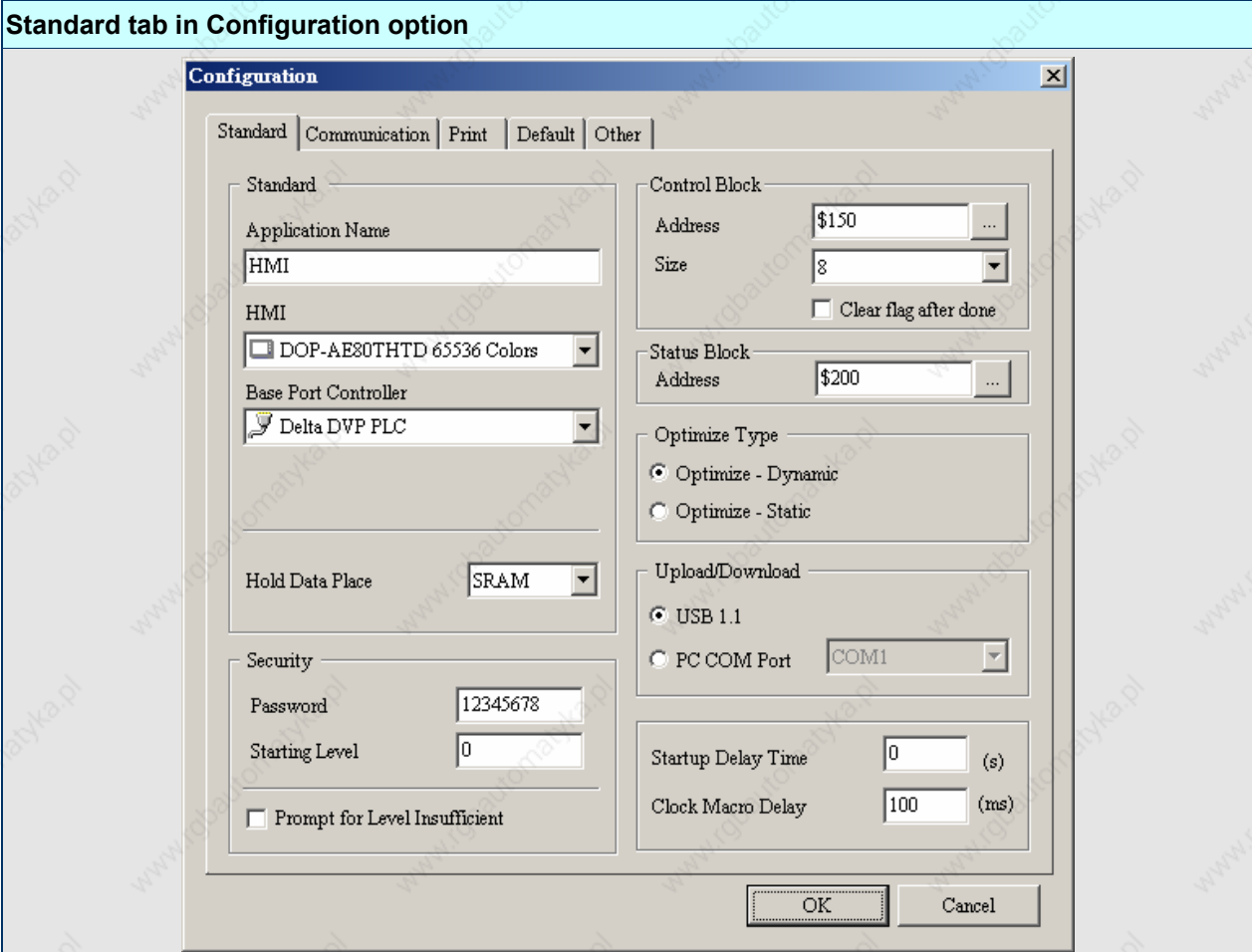
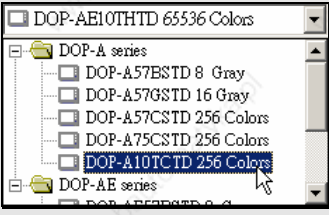
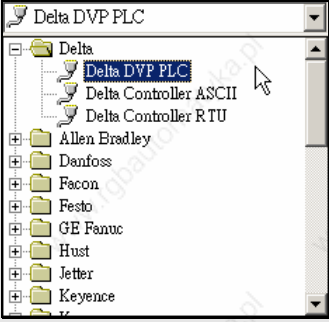


Fig. 2.9.2 Choosing Configuration command from menu bar

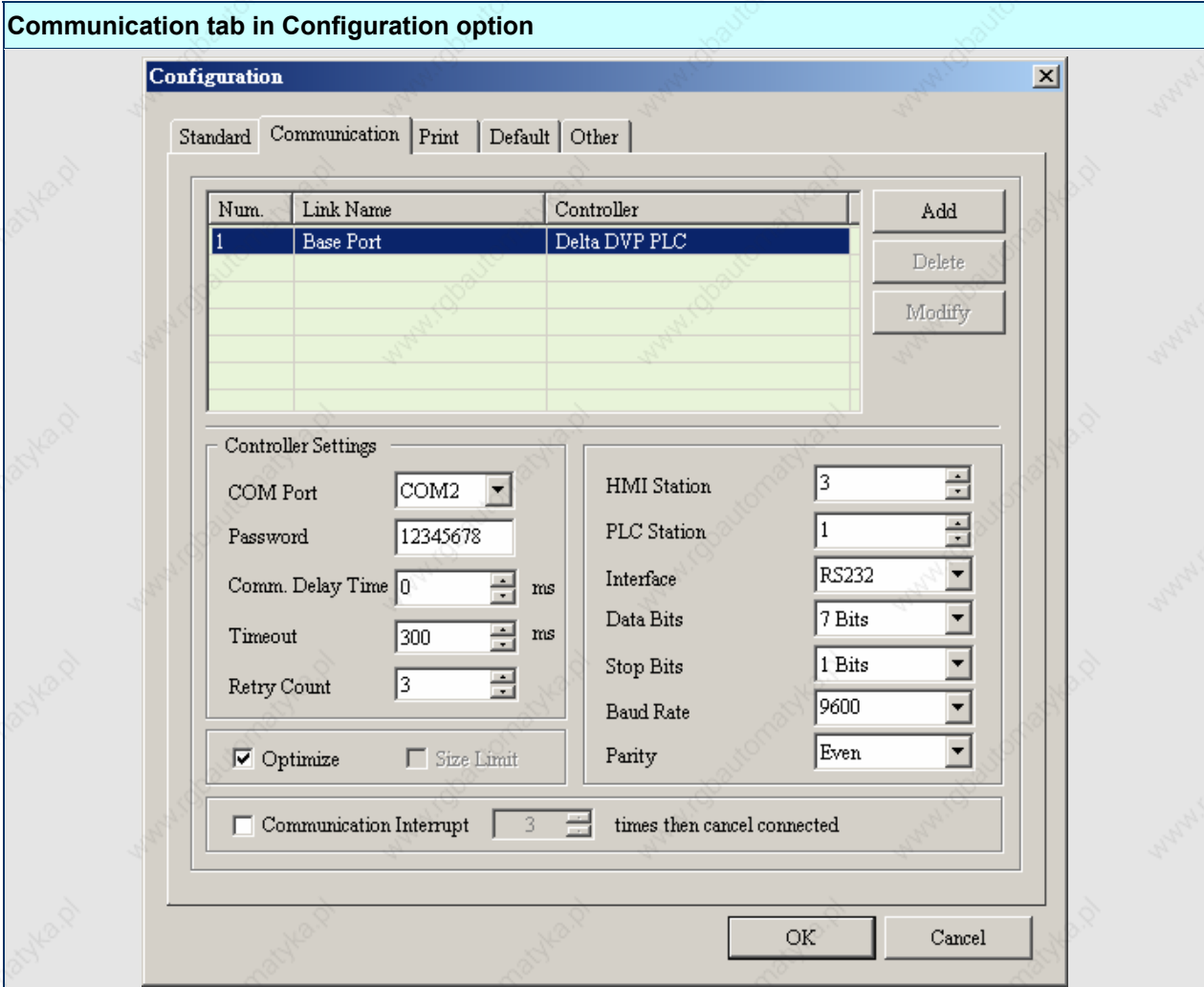
Table 2.9.1 Standard Tab

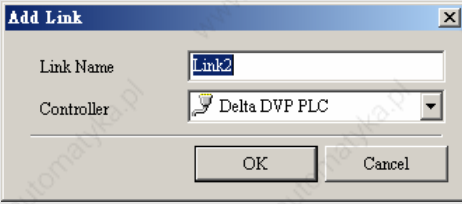


<p>Application Name (Standard)</p>	<p>It is also File Name.</p>
<p>HMI Type (Standard)</p>	<p>It is used to select DOP series HMI type for different functions and requirements.</p> 
<p>Base Port Controller (Standard)</p>	<p>It is used to set connecting external controller: Screen Editor provide various controllers sorted by manufacturers for the users to select.</p> 

Standard tab in Configuration option	
Hold Data Place (Standard)	The backup memory data can be saved in SRAM, SMC and USB Disk these three places. The users can select one of them from the Hold Data Place drop-down list. However, USB Disk selection is available in some HMI types only. If DOP-A57BSTD is chosen, the backup memory data only can be saved in SRAM and SMC.
Password (Security)	It is used to set the highest priority password. There are 8 levels for the password. Meanwhile, this password is also the protection password for the file (application).
Starting Level (Security)	It is used to set start-up priority. The highest level is 7 and the lowest level is 0.
Address (Control Block)	It is used to set the starting address of system control block.
Size (Control Block)	The length of control block will be different depending on different function. (For example, the length should be at least 8 Words when using multi-language function). For more detailed information of system control block, please refer to Chapter 5. Note: Please notice that the when the control block size is set to 0, the control block function is disabled.
Clear flag after done	If this check box is checked, the register in the control block will be cleared to 0 when any operation has been finished in the control block.
Address (Status Block)	It is used to set the starting address of system status block. The length is constant 6 words. Each word indicates the different status value of HMI system. Refer to chapter 4 for important parameters of system status area. For more detailed information of system status block, please refer to Chapter 5.
Optimize Type	Optimize - Dynamic When switching the screen, optimize all elements that read addresses on the screen. Please notice that when this function is selected, all elements that read addresses on the screen will display incorrect value in a short time. The display value will become normal after optimization is completed.
	Optimize - Static Optimize all elements that read addresses on the screen during compile operation.
Upload / Download	The users can select USB or PC communication port (i.e. RS-232) to upload and download.
Startup Delay Time	It is used to set delay time for waiting the startup of external controller (i.e. PLC). PLC. The range is 0 ~ 255 seconds.
Clock Macro Delay	It is used to set interval time when executing clock macro every time. The range is 100 ~ 65535ms.

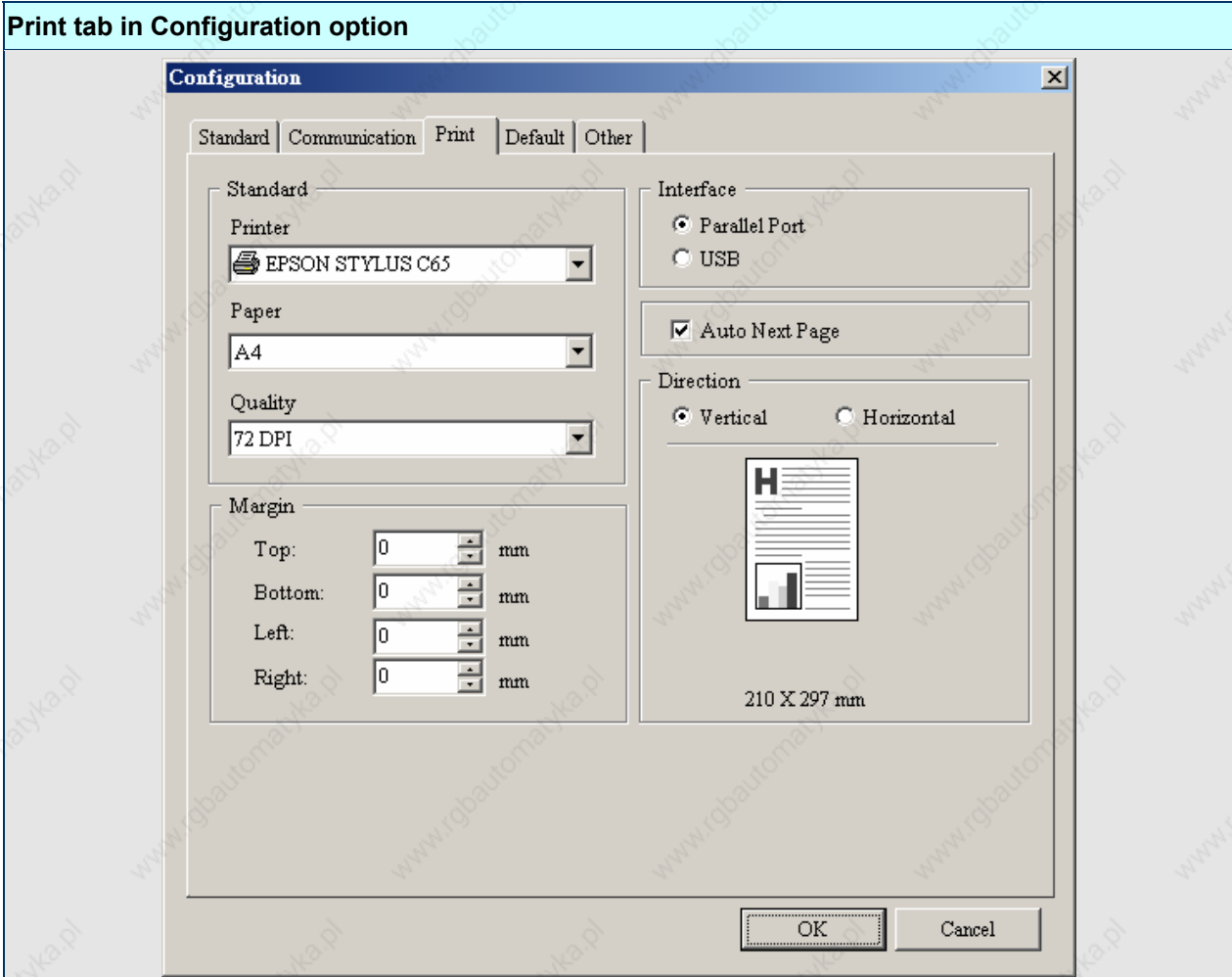
Table 2.9.2 Communication Tab



Add / Delete Controller Connection	Add	<p>Press Add button to determine the connecting device name and the controller:</p>  <p>It is used to set the connecting PLC. Available connecting PLC will be different depending on HMI type. (DOP series can support three max. different controllers simultaneously.)</p>
	Delete	It is used to delete the existed connecting controller (One application needs to connect at least one controller).
	Modify	Modify the connecting controller or change the controller name.
Controller Settings	COM Port	It is used to set COM port that used to communicate with HMI (COM1 or COM2). COM3 port only provided in some types of HMI, e.g. DOP AE series.
	Password	Entering password is necessary for some connecting controllers before communication.
	Comm. Delay Time	It is used to set delay time for waiting the startup of external controller (i.e. PLC). The range is within 0 ~ 255 ms.

Communication tab in Configuration option	
Timeout	It is used to set communication time out time when communicating with the external controller. The range is within 100 ~ 65535ms.
Retry Count	HMI will try to send communication command to the external controller repeatedly if the external controller does not respond during communication. This option is used to set the number of retry count times. A communication error dialog box will not appear unless the number of retry count times is reached. The range is within 0 ~ 255 times.
Optimize	Use this option to enable optimization function. If optimization function is enabled, all read addresses of all related elements will be optimized.
Size Limit	This function is available only when "Optimize – Static" on Standard tab is selected. It is used to avoid that the screen updating speed may slow down when reading too long continuous address.
When the check box next to "Communication Interrupt times then cancel connected" is checked, HMI will stop communicating with the external controllers after the communication interrupt times is reached. The purpose of this function is to avoid the communication error dialog box will always show on the HMI screen when the communication error occurs after HMI has retried. The range is within 1 ~ 255 times.	
HMI Station	It is used to set HMI station number. The range is within 0 ~ 255.
PLC Station	It is used to set PLC station number. If PLC does not set station number, it will use this default setting. The range is within 0 ~ 255.
Interface	It is used to set communication interface. The default setting is RS232. There are RS232, RS422 and RS485 three options.
Data Bits	There are 7 Bits and 8 Bits two options.
Stop Bits	There are 1 Bits and 2 Bits two options.
Baud Rate	Communication baud rate. There are 4800, 9600, 19200, 38400, 57600 and 115200 these options. The users can enter the setting value directly also but the max. setting value can not exceed 187500.
Parity	There are None, Odd and Even three options.

Table 2.9.3 Print Tab



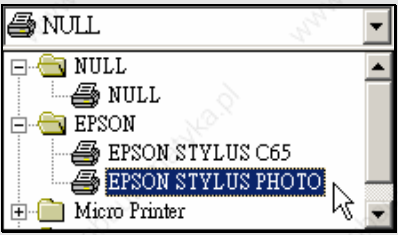
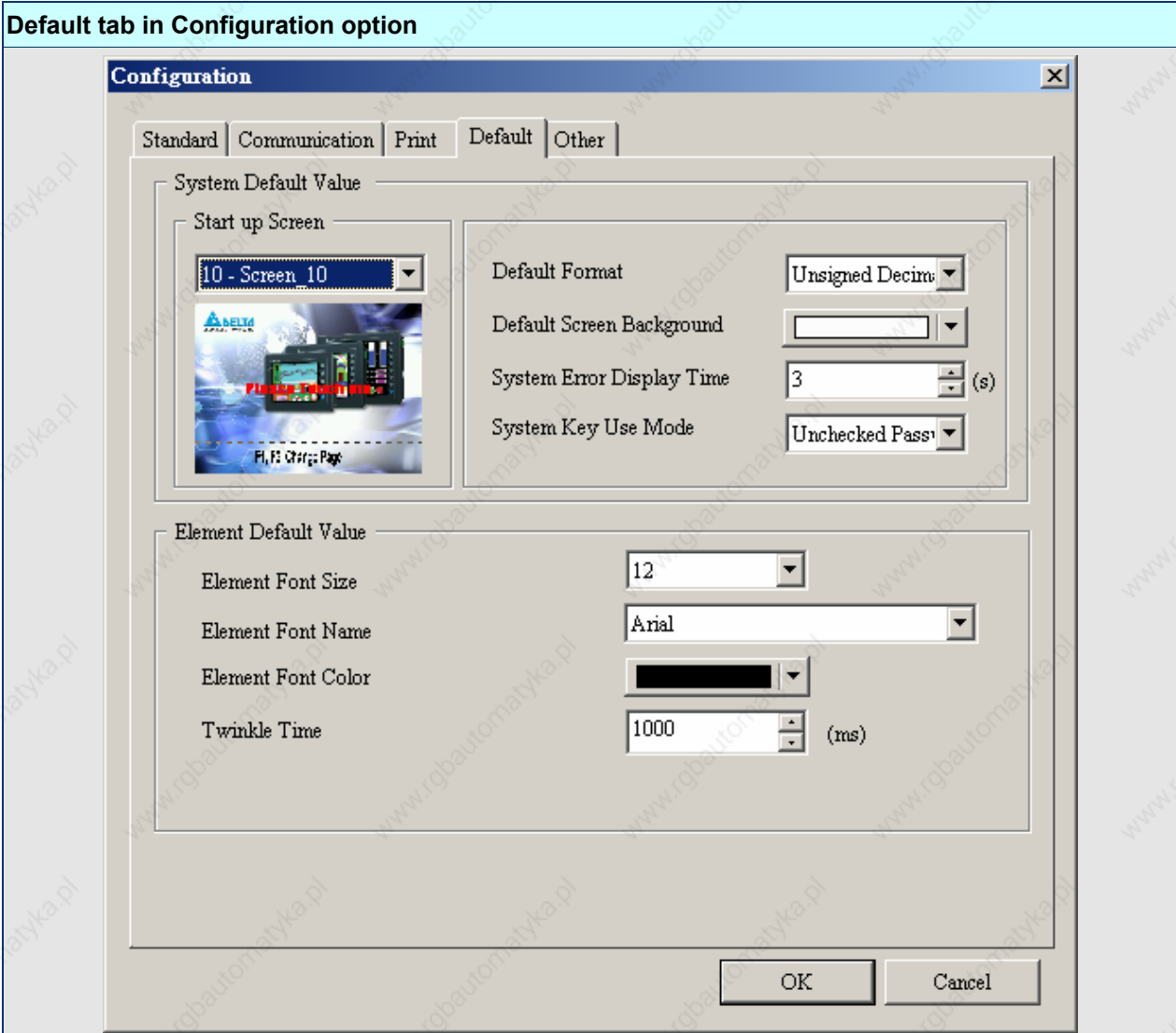
Standard	Printer	Use this option to set the connecting printer. The users can use the drop-down list to specify the printer. The printers in the list are sorted by the manufacturers and the users can find the printer easily. 
	Paper	The users can use Paper drop-down list to select the paper size. The predefined paper sizes in the list are A4 and Letter only.
	Quality	Only 72DPI option is provided.
Margin	The users can determine the blank space (margins) that will not be printed by using this option. Use this option can specify the top, bottom, left and right margins and the unit is mm.	
Interface	It is used to set printer interface. The users can specify the communication port of the printer. There are Parallel Port and USB two options.	
Auto Next Page	When the “Auto Next Page” option is selected, the printer will print the next page automatically. If the checkbox next to “Auto Next Page” is not checked, the printer will print continuously without breaking for different pages.	
Direction	It is used to set printing direction (orientation). There are Vertical (Portrait) and Horizontal (Landscape) two options.	

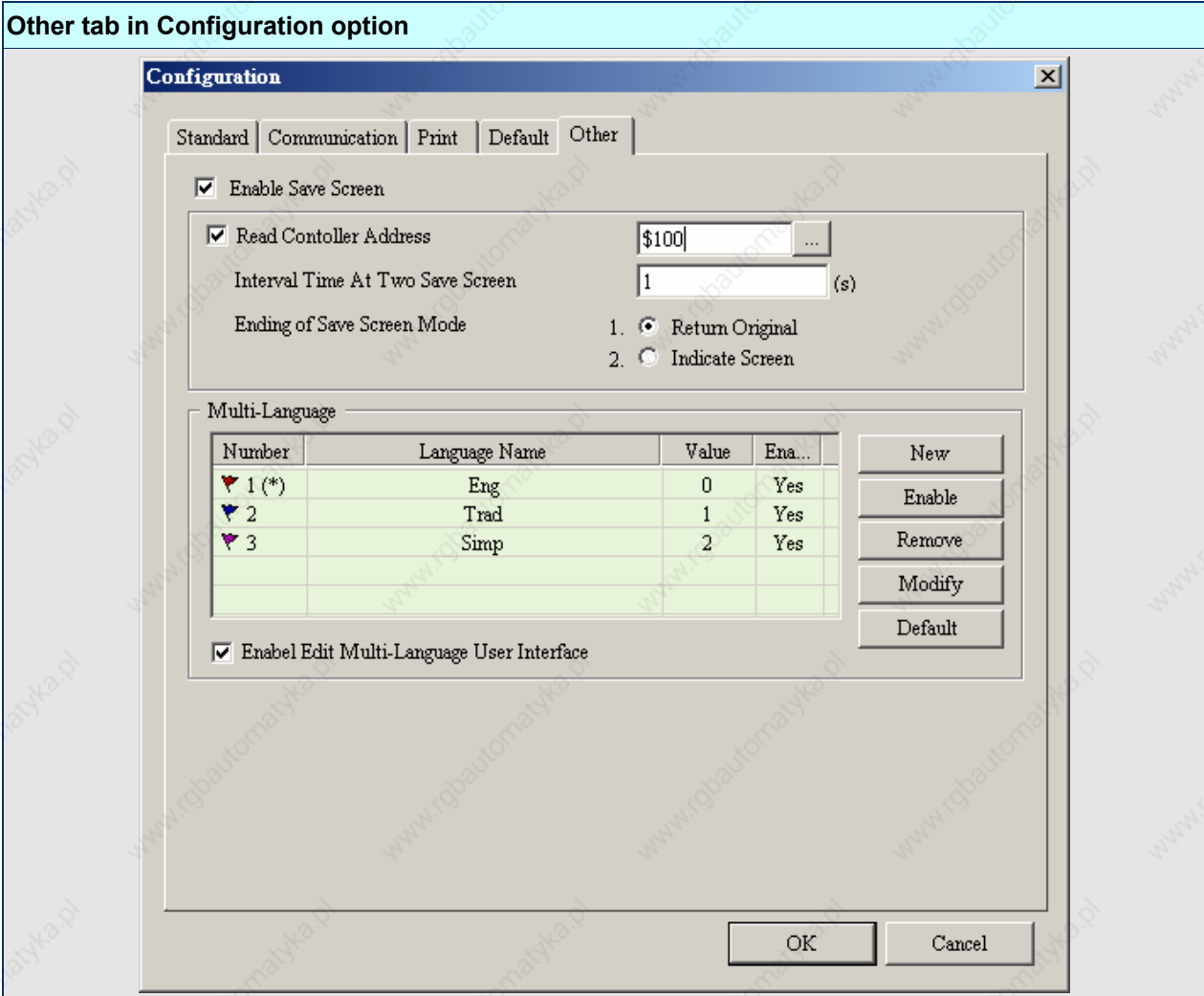
Table 2.9.4 Default Tab



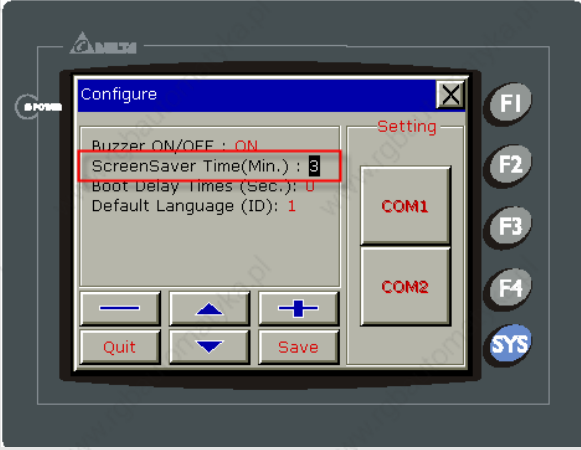


System Default Value	Start up Screen	Use this option to set the first display screen when HMI is powered on and started up.
	Default Format	When creating elements, it is used to set the default value format.
	Default Screen Background	When a new editing screen is created, the users can use this option to set the default screen background color.
	System Error Display Time	Use this option to set the display time of system error message dialog box. The range is within 0 ~ 5 seconds. Please notice that if the setting value is set to 0, it indicates that the system error message dialog box will not display on HMI screen.
	System Key Use Mode	It is used to set the system key action when the users press the key. There are Disable , Check Password and Unchecked Password these three options.
Element Default Value	Element Font Size	It is used to specify the default element font size when creating an element.
	Element Font Name	It is used to specify the default element font name when creating an element.
	Element Font Color	It is used to specify the default element font color when creating an element.

Default tab in Configuration option		
	Twinkle Time	It is used to specify the default element twinkle time when creating an element.

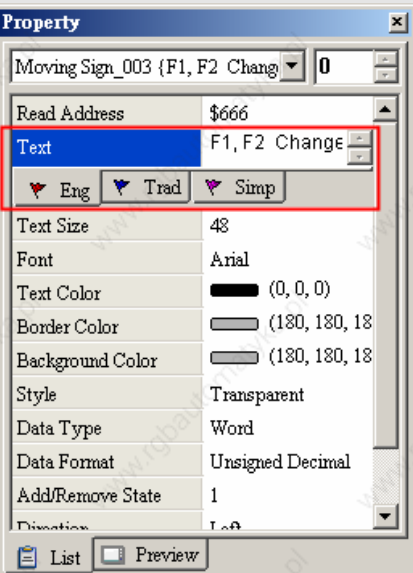
Table 2.9.5 Other Tab



Save Screen	In Screen Management option on page 2-66, there is more detailed description for introducing how to drag the mouse to determine the screen saver display.	
	Enable Save Screen	This option should be selected when the users want to use Edit Save Screen function in Screen Management option. If this option is not selected, even though the users have chosen the Edit Save Screen function, the screen saver will not be started up.
	Read Controller Address	1. The users can use this option to enable the screen saver. When the setting value is 0, it indicates that the screen saver function is disabled. If the setting value is a non-zero value, it indicates that the screen saver function is enabled. When the users touch the HMI screen, the screen saver function is ineffective.

Other tab in Configuration option	
Read Controller Address	<p>2. If this option is not selected, the screen saver will be enabled automatically when the Screen Saver Time set in HMI is reached. If the screen saver function is enabled, the users can touch the HMI screen to disable it.</p> 
Interval Time At Two Save Screen	User this option can set the interval time between two screen savers. The range is within 1 ~ 255 second.
Ending of Save Screen Mode	<ol style="list-style-type: none"> 1. Return Original: Return to the original screen at that time when the screen saver is enabled. 2. Indicate Screen: Specify the screen that will show after the screen saver program ends.
Multi-Language	<p>New</p> <p>Pressing New button can add a language option.</p>  <p>As shown as the figure above, the users have to enter the language name and setting value. The setting value will be referred by the system when setting multi-language. The range of the setting value is within 0 ~ 255. Setting language name is easy for text editing. The users can press  button to change the flag color on the language name tab.</p>
Enable/Disable	Delta HMI allows the users to edit multi-language screen, however the users can use this option to determine which languages are supported (enabled) or not supported (disabled) as the users wish when downloading data to HMI.
Remove	Remove the existing language. Ensure to keep at least one language for an application.
Modify	Modify the existing language name and setting value.

Other tab in Configuration option

	<p>Enable Edit Multi-Language User Interface</p>	<p>Use this option can enable multi-language user interface. The users can view multi-language display in property table if this option is selected. The editing interface will be shown as the figure below:</p> 
--	--	--

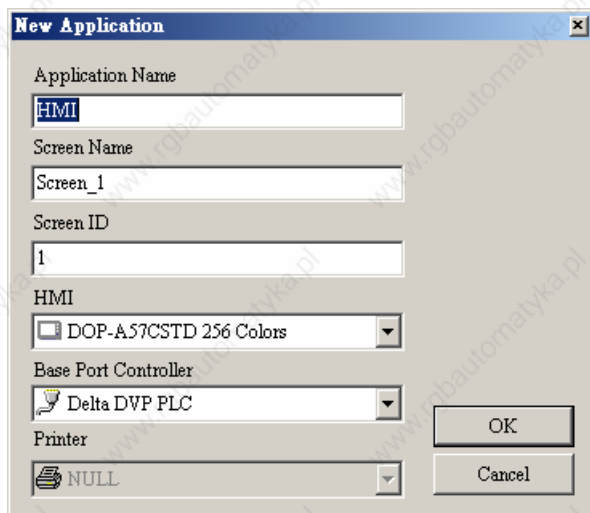
How to Use Multi Language Function

Example:

Create a Screen that has “English”, “Traditional Chinese” and “Simplified Chinese” three languages selection for the users to switch. Also, teach the users how to set an “Increment” button to switch the language selection within the screen.

1. Create a new application.

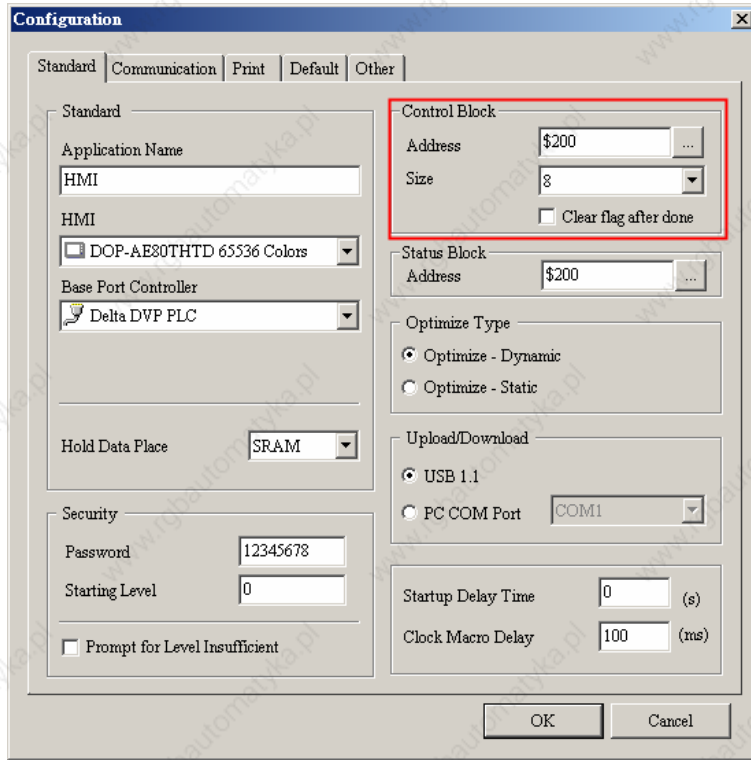
Select HMI model “DOP-A57CSTD 256 Colors”.



2. Create two button elements on the screen. “Set” and “Increment” these two button elements.

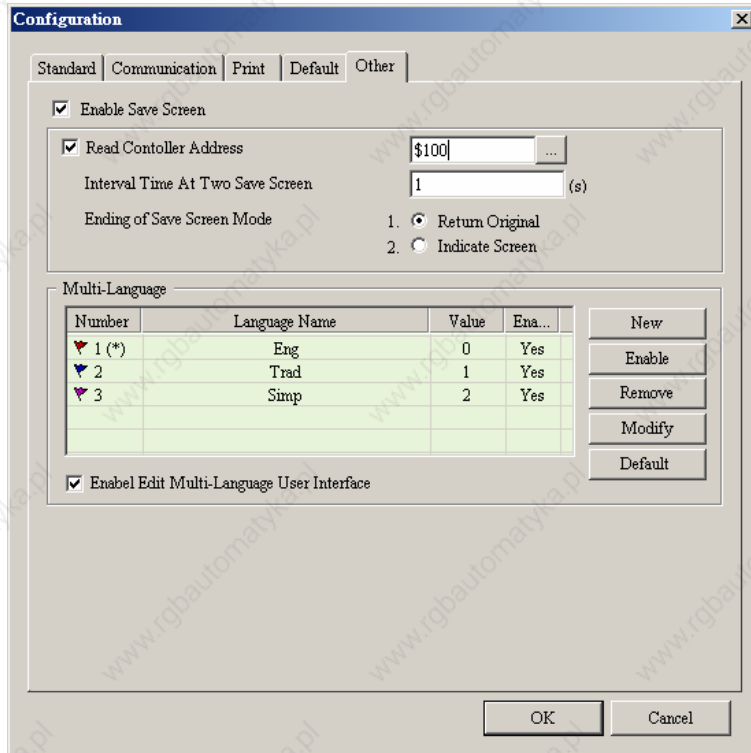
3. Control Block (Options > Configuration) Settings

Set the address as \$200 and set the size is 8.

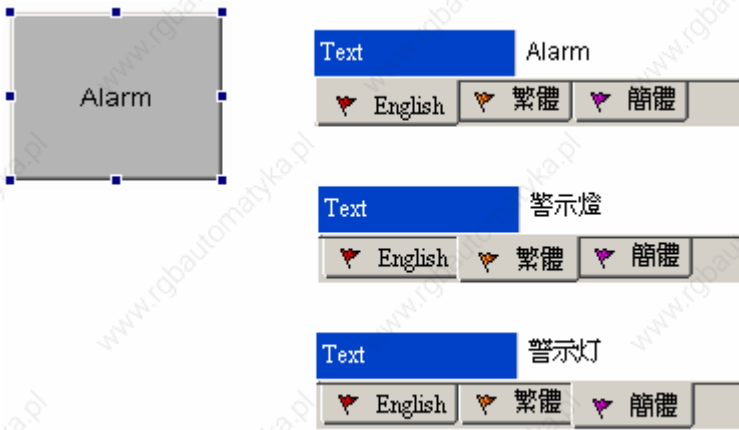


4. Multi-Language Settings

Add “English”, “Traditional Chinese” and “Simplified Chinese” three languages. The setting value are 0, 1 and 2 for each language respectively.

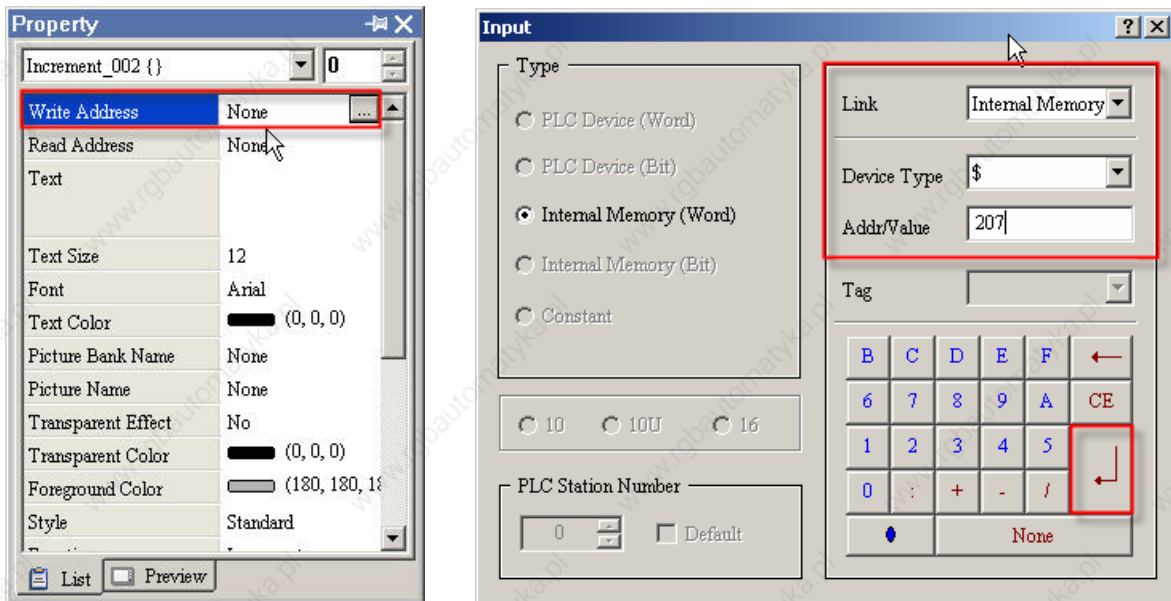


5. Set the display text of “Set” button element in different languages.

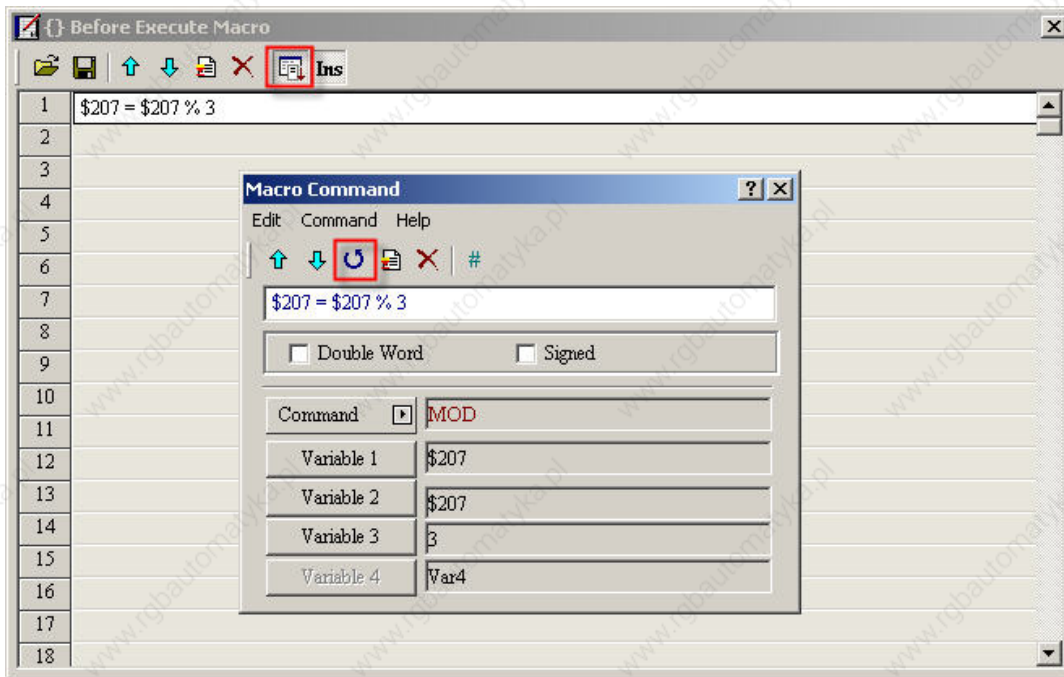
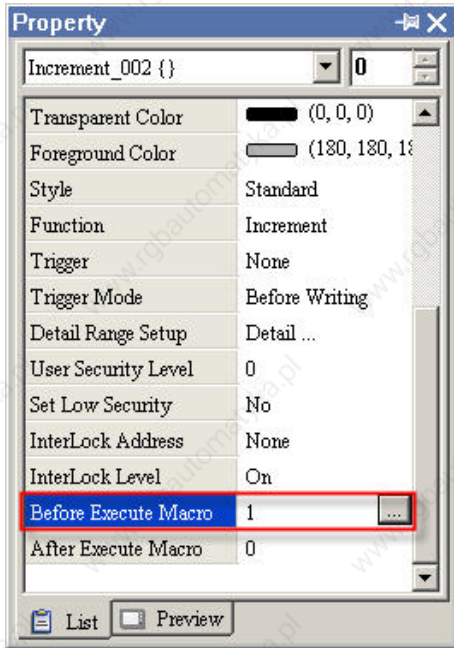


- Double click the English tab and enter “Alarm” in English.
- Double click the Traditional Chinese tab and enter “警示燈” in Traditional Chinese.
- Double click the “Simplified Chinese” and enter “警示灯” in Simplified Chinese”

6. In property setting of “Increment” button element, please set the write address as the **internal memory \$207**.



- Then, set the setting value of "Before Execute Macro". The users can enter the Macro command as **\$207=\$207%3**.



- Select **Compile** command and execute **Off Line Simulation**. Then, the users can see the text of the "Set" button is changed in different language by pressing the "Increment" button element.

■ Alarm Setup

Alarm Setup

The users can set alarm by clicking **Options > Alarm Setup** (Fig. 2.9.3). The alarm setup should set with the alarm function in element settings. HMI will execute alarm function automatically if both settings are all set. When the specified conditions are matched (If condition occurs in specific address, ON enabled or OFF enabled) after setting, HMI will display a Alarm Setup warning dialog box automatically. In this dialog box (Fig. 2.9.4), there are Delete, Modify, Import, Export and Close for the users to use. For more information for the settings of Alarm Setup, please refer to the Table 2.9.6 on the following page and Chapter 3 for more description.

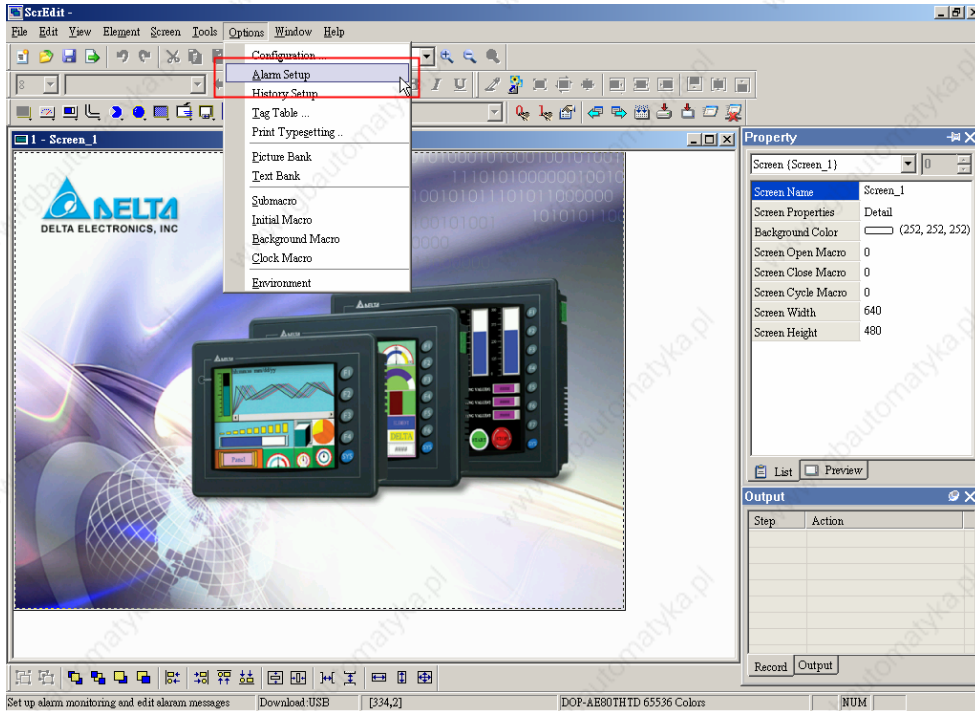


Fig. 2.9.3 Choosing Alarm Setup command from menu bar

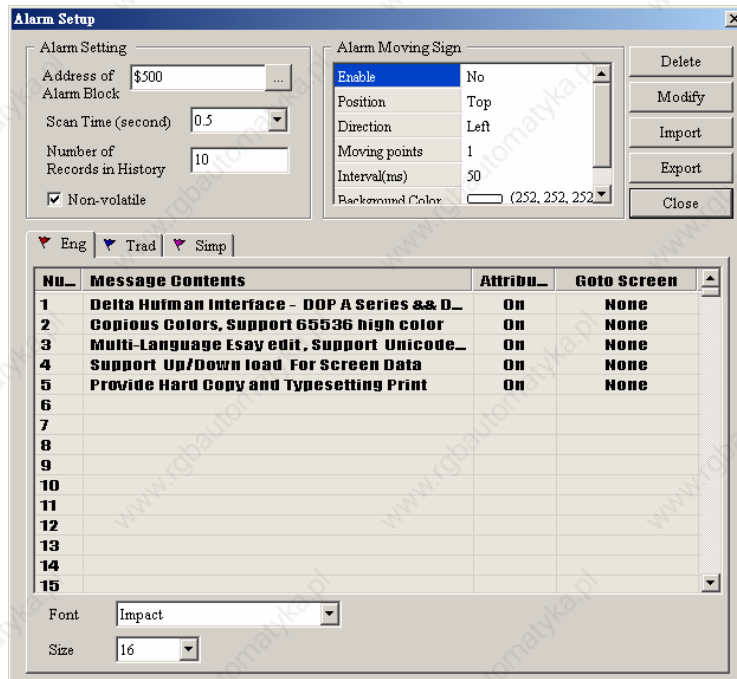
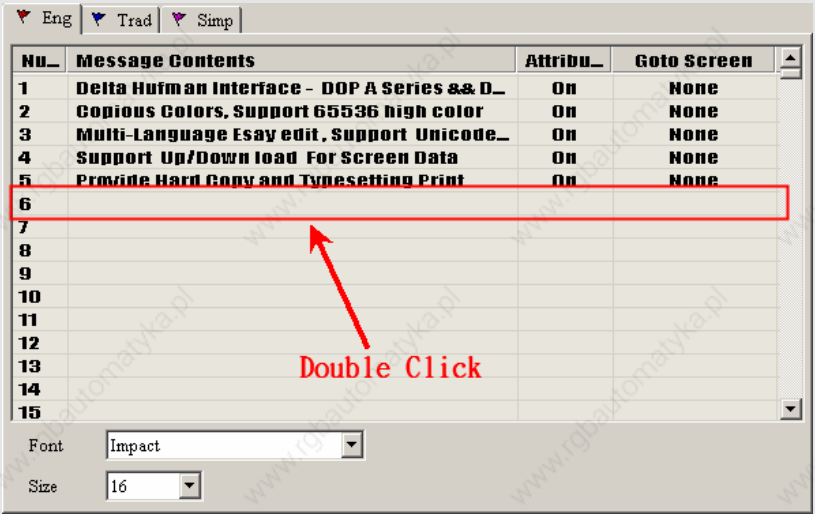
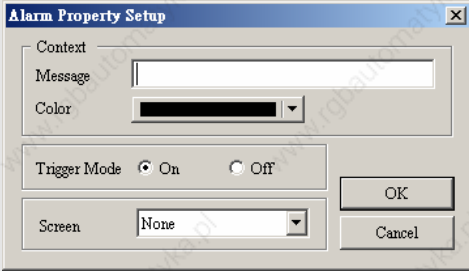


Fig. 2.9.4 Alarm Setup Dialog Box

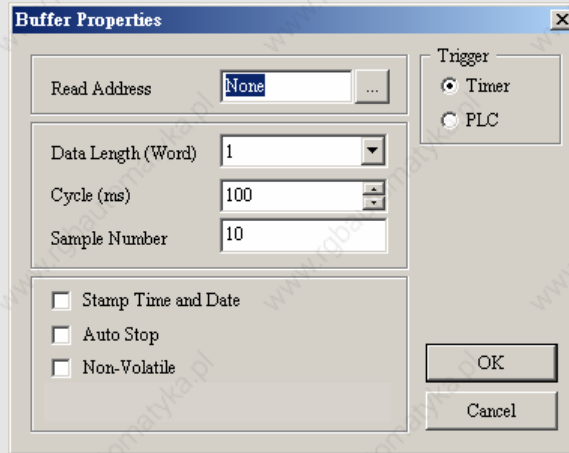
Table 2.9.6 Alarm Setup Settings

Alarm Setup Dialog Box		
Alarm Setting	Address of Alarm Block	Use this option to set the alarm starting address. It provides 512 alarms, 32 Words.
	Scan Time (second)	It is used to set the how long the HMI scan one time. The unit is second.
	Number of Records in History	Use this option to save data in order. When the number of records exceeds this setting value, it will delete the first record and insert the new record into the last address. For example, if the setting value is set to 100 and the number of records in history exceeds 100, the first record will be deleted and the second record will become to the third record, the third record will become to the forth record...and the 100th record will become to 99th record. Therefore, the new record (101st record) will become to 100th record.
	Non-volatile	Using this option can enable to save data in SRAM when the power is turned off. The capacity for saving alarm data of DOP-A series is 8MBytes and DOP-AE series is 16MBytes . (The power of SRAM is battery when the power is turned off.) (In some HMI models, the users can save data in USB Disk or SMC card when the power is turned off and the capacity for saving alarm data depends on the capacity of USB Disk or SMC card.)
	Alarm Property Setup	<p>The users can double click a row of the alarm message contents table to edit the alarm property.</p> <p>(Please notice that there are three languages tabs in Alarm Setup dialog box as multi-language function is also supported here. The users can click the tab to edit the alarm message contents according to the users' requirement.)</p>  <p>The following Alarm Property Setup dialog box will display after double clicking the row.</p> 
	Message	Display message when an alarm occurs.
	Color	Display message color when an alarm occurs.

Alarm Setup Dialog Box				
		Trigger Mode	Use this option to determine the Bit is On or Off when an alarm occurs.	
		Screen	Display screen when an alarm occurs.	
	Delete	Delete the alarm message contents.		
	Modify	Modify the alarm message contents. The users also can double click the mouse to perform this function.		
	Import	Import the Alarm Describe File into the alarm message contents table.		
	Export	Export the alarm message contents from HMI and convert them to be Alarm Describe .		
	Close	Exit the Alarm Setup dialog box.		
Alarm Moving Sign	Enable	It is used to enable the alarm moving sign.		
	Position	It is used to determine the display position of alarm moving sign. It can be Top or Bottom.		
	Direction	Left	Alarm message will move from right to left (Move to left).	
		Right	Alarm message will move from left to right (Move to right).	
		Up	Alarm message will move from bottom to top (Move to Up).	
		Down	Alarm message will move from top to bottom (Move to Down).	
	Moving points	It is used to set the moving points every time for the alarm moving sign. The unit is Pixel and the range is within 1 ~ 50 points.		
	Interval (ms)	It is used to set the interval time every time for the alarm moving sign. The unit is ms and the range is within 50 ~ 3000 ms.		
Background Color	It is used to set the background color of the alarm moving sign.			

History Setup Dialog Box

Append Pressing Append button can add a history data. Max. 12 history data can be added. After the Append button is pressed, the following Buffer Properties dialog box will display.



Read Address	It is used to set the starting address for sampling the history data.
Data Length (Word)	It is used to set how much Word the users want to sample? The range is within 1 ~ 13 continuous Words. It indicates that max. 13 continuous words can be sampled.
Cycle (ms)	It is used to set the sampling cycle time for reading address (how long is it to read address one time). If the Trigger option is PLC, this option will be ineffective. The range of the sampling cycle time is within 0 ~ 86400000 ms.
Sample Number	This option is used with the Auto Stop option. If the Auto Stop option is selected, HMI will stop recording the data after the numbers of records have reached the setting value of Sample Number option. If the Auto Stop option is not selected, when record number of data exceeds the setting value of Sample Number option, it will delete the first record and insert the new record into the last address. For example, if the setting value is set to 100 and the number of records in history exceeds 100, the first record will be deleted and the second record will become to the third record, the third record will become to the forth record...and the 100th record will become to 99th record. Therefore, the new record (101st record) will become to 100th record.
Stamp Time and Date	Use this option to determine if the time and date are also recorded during sampling operation.
Auto Stop	Use this option to determine if HMI stop recording when the max. number of record data is reached.
Non-Volatile	Using this option can enable to save sampling data in SRAM when the power is turned off. The capacity for saving history data of DOP-A series is 240MBytes and DOP-AE series is 360MBytes . (The power of SRAM is battery when the power is turned off.) (In some HMI models, the users can save data in USB Disk or SMC card when the power is turned off and the capacity for saving history data depends on the capacity of USB Disk or SMC card.)
Trigger	There are Timer and PLC two options.
OK / Cancel	Press OK button to save the data and exit. Press Cancel to exit without saving data.
Delete	Pressing Delete button can delete a history data.
Modify	Pressing Modify button can modify a history data.

■ Tag Table

Tag Table ...

It is used to replace the specific address with the user-defined words or characters. For example, if the users want to replace PLC address 1@Y0 with the word "OS", just define it in Tag Table option in advance.

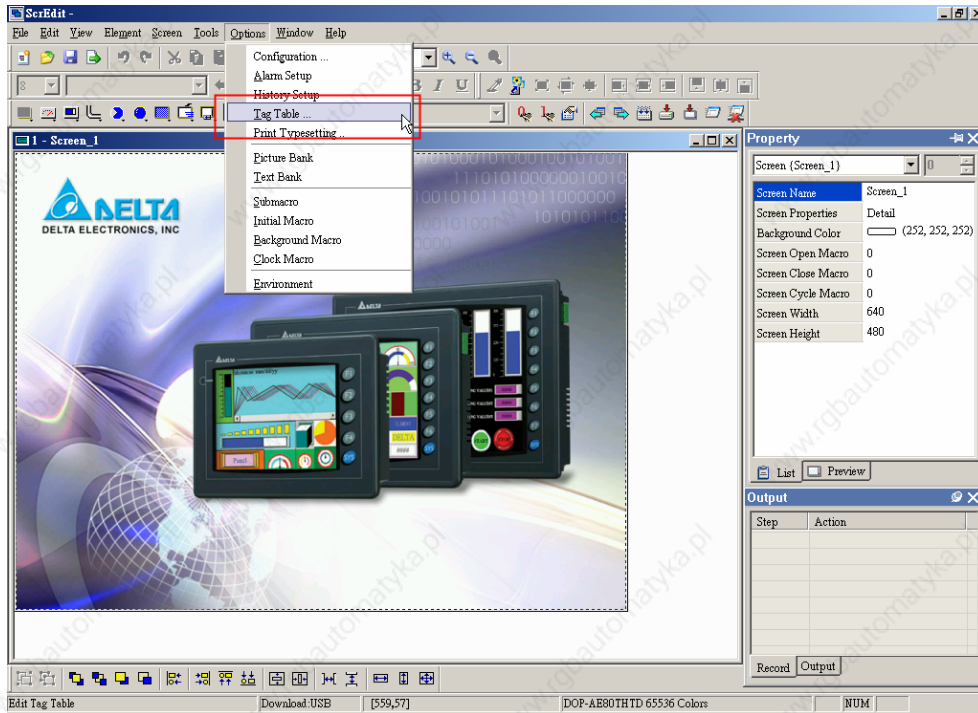


Fig. 2.9.6 Choosing Tag Table command from menu bar

Table 2.9.8 Tag Table Settings

Tag Table Dialog Box

Num...	Name	Address	Contents
1	OS	1@Y0	OPERATIONSYSTEM

Buttons: Open, Save, Add, Delete, OK, Cancel

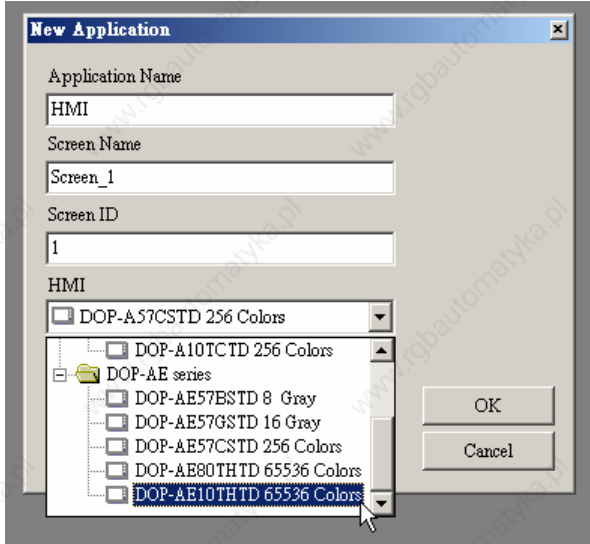
Open	Open a Tag File and import it into HMI.
Save	Save the settings or changes made in Tag Table dialog box as a Tag File.

How to Use Print Typesetting Function

Example:

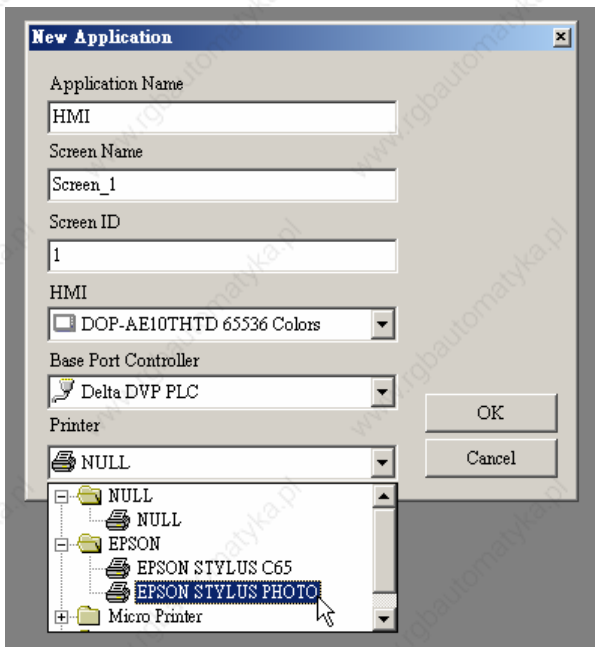
Printer and Page Setup

1. Print Typesetting function only provided in DOP-AE series.



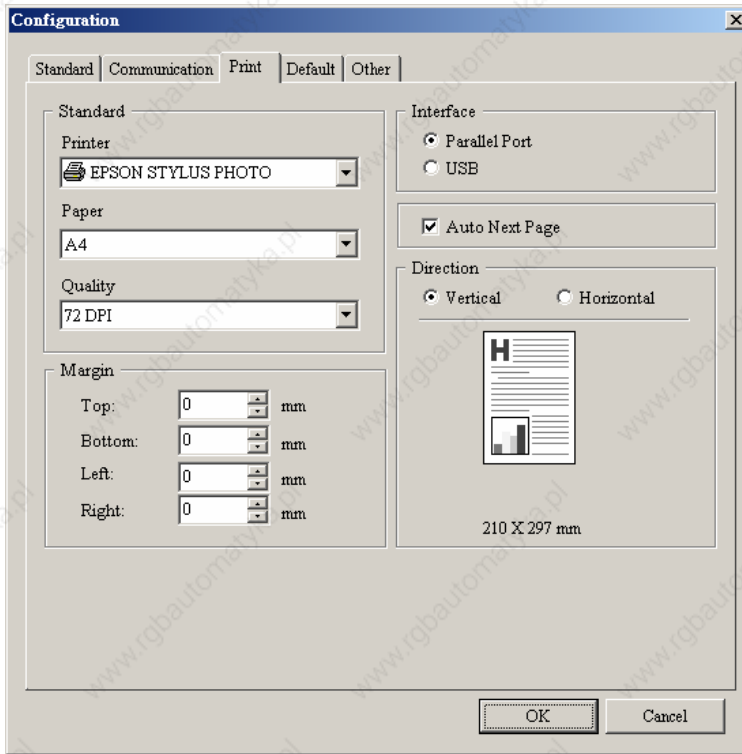
2. Select Printer

The users can click **File > New** to get into the New Application tab and select the printer using the “Printer” drop-down list in New Application tab. Or click **Options > Configuration > Print** to select a printer.



3. Configuring Print Setup

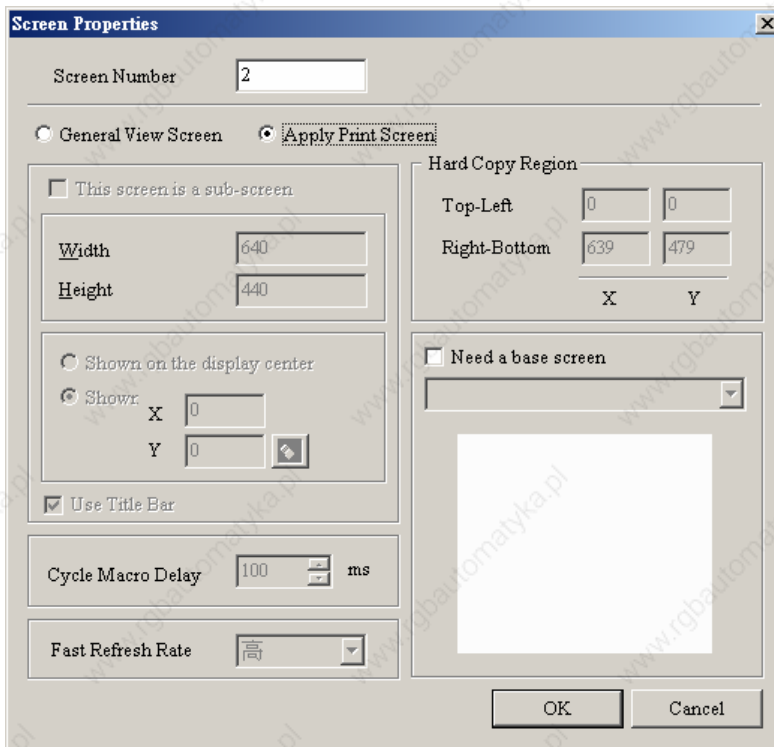
The users can click **Options > Configuration > Print** to enter into “Print” tab. Then, use the Print tab to configure the settings of printer, paper, quality and margin, etc. options.



Create Printing Report

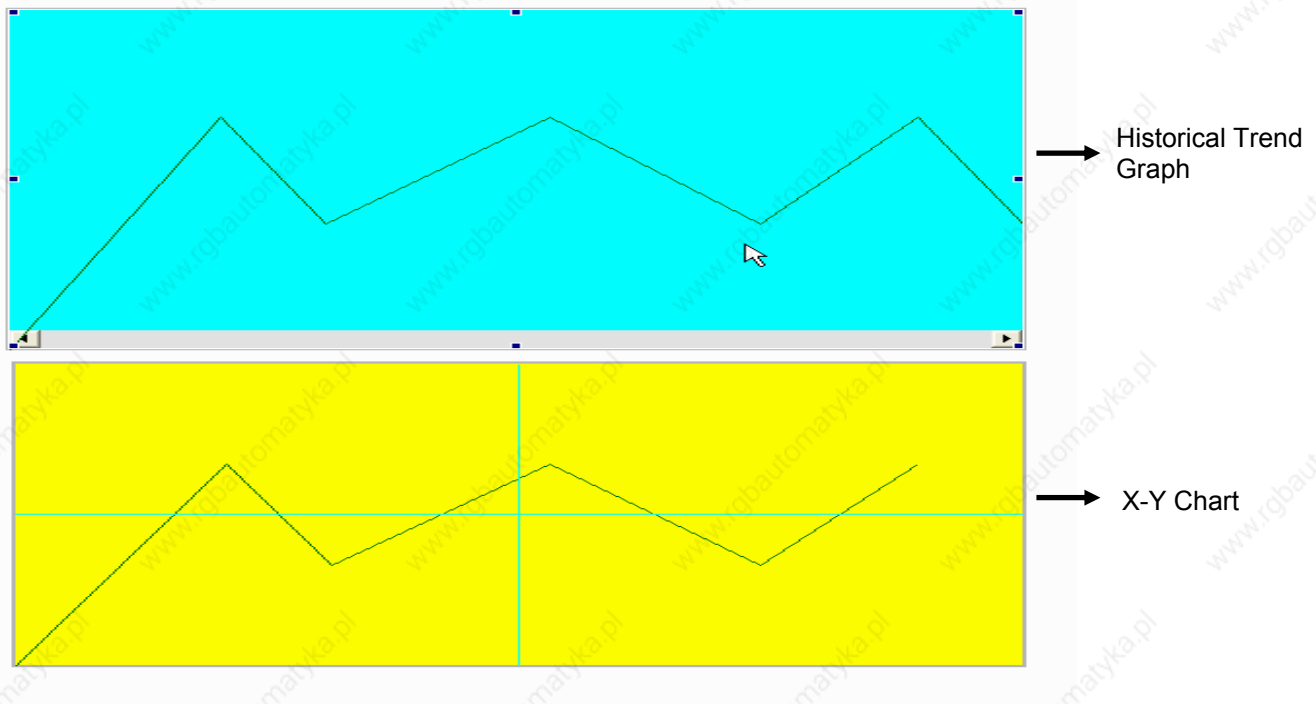
Step 1:

Creating a new screen first (Click **Screen** > **New Screen**) and set it as **Apply Print Screen** in Screen Properties tab (Click **Screen** > **Screen Properties**). For the description of Apply Print Screen function, please refer to Table. 2.7.2 Screen Properties setting on page 2-80.



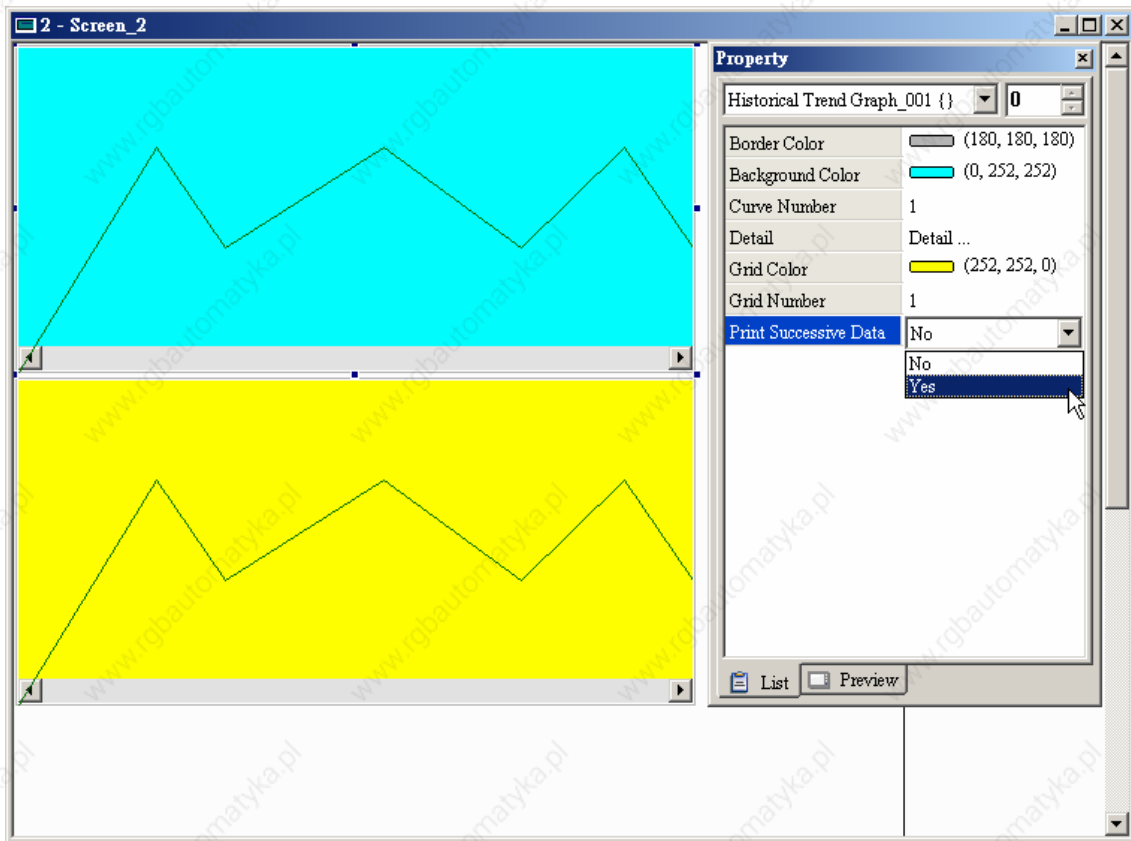
Step 2:

Create the element that the users want to print out. For example, if the users want to print a Historical Trend Graph and a X-Y Chart, the users can create a Historical Trend Graph (Click **Element** > **Sampling** > **Historical Trend Graph**) and a X-Y Chart (Click **Element** > **Curve** > **X-Y Chart**) first and then set their properties in the Property table. The Property table provides element property setting for each element. For the information for element property settings for each element, please refer to Chapter 3 for more detailed description.



Step 3:

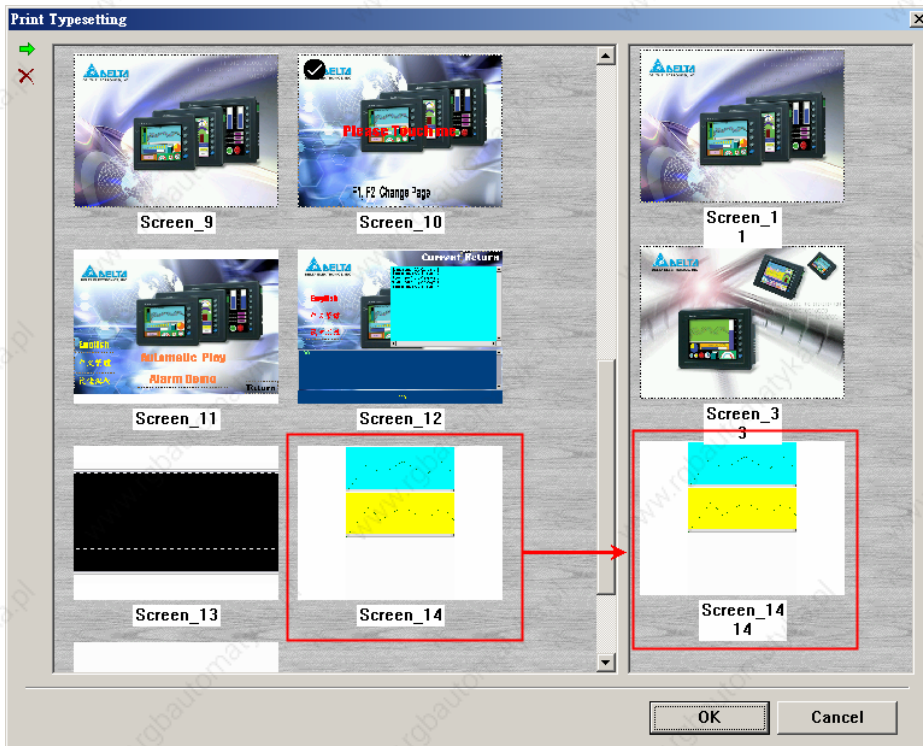
The users can choose “Yes” or “No” using the “Print Successive Data” drop-down list to determine whether Print Successive Data function is selected or not. When “Yes” is selected, it indicates that Print Successive Data function is enabled, and all the sampling records and data for the element will be printed out completely.



Print Screen Layout and Output

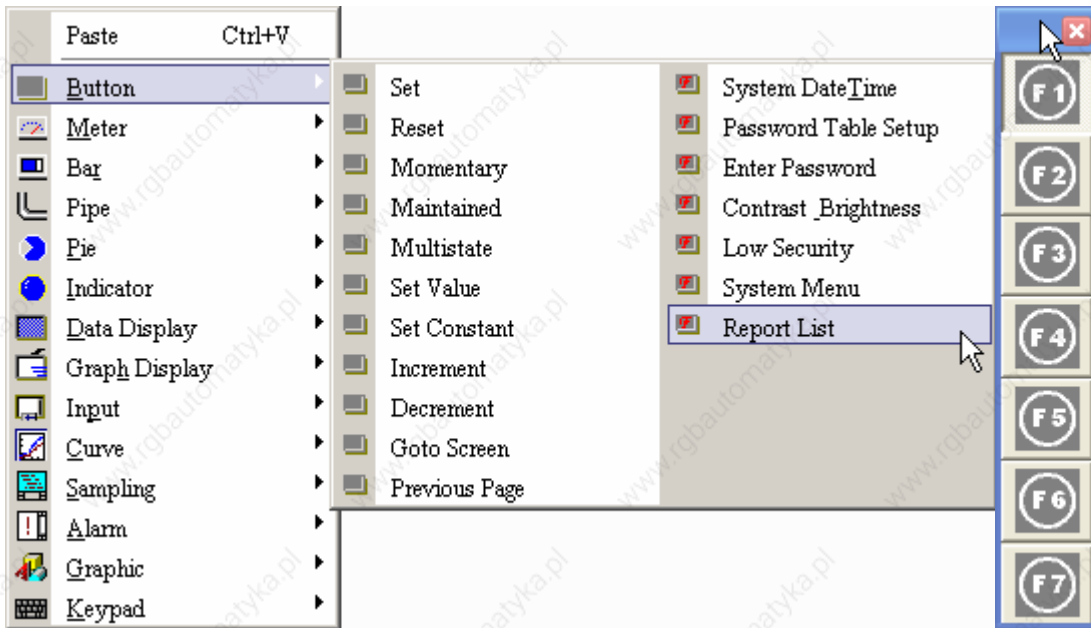
Step 1:

Click **Options > Print Typesetting**. Then drag the mouse to decide which screen needed to be typeset and printed out. The screens on the left side are all created screens and the screens on the right side are the selected screens. If a "General View Screen" is dragged to the right side, it will become "Apply Print Screen" (Screen Properties) automatically.



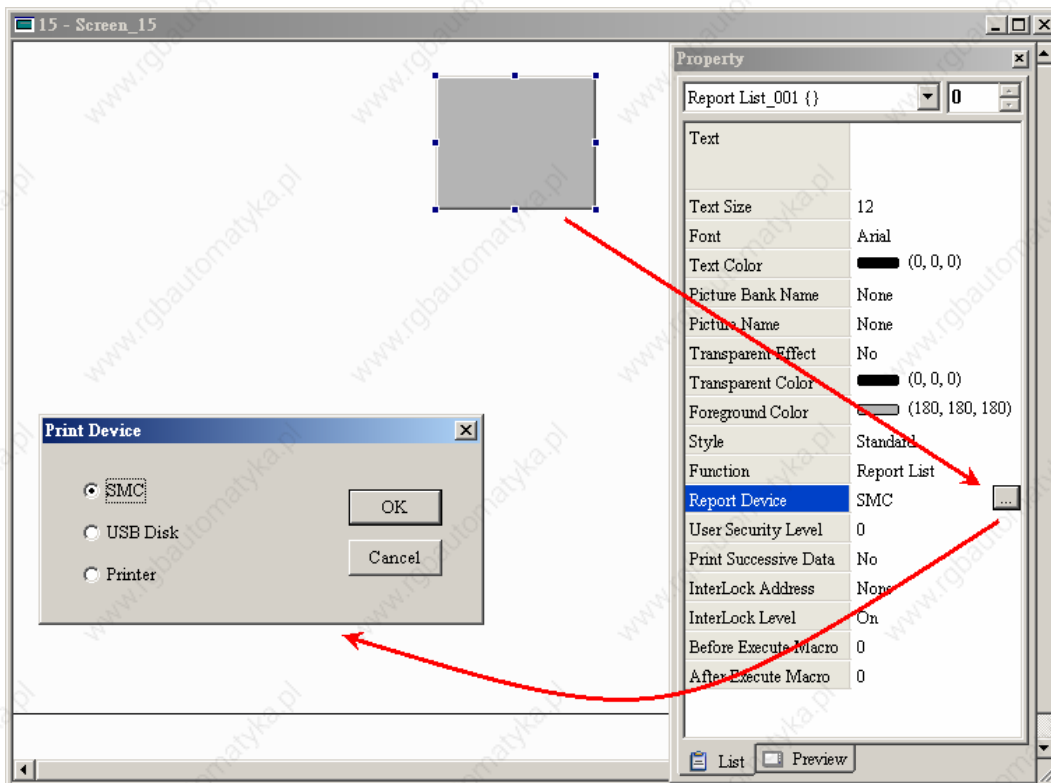
Step2:

Right clicking the mouse or use function key to create a “Report List” button on a “General View Screen”. Then, use this “Report List” button to enable the print function.



Step 3:

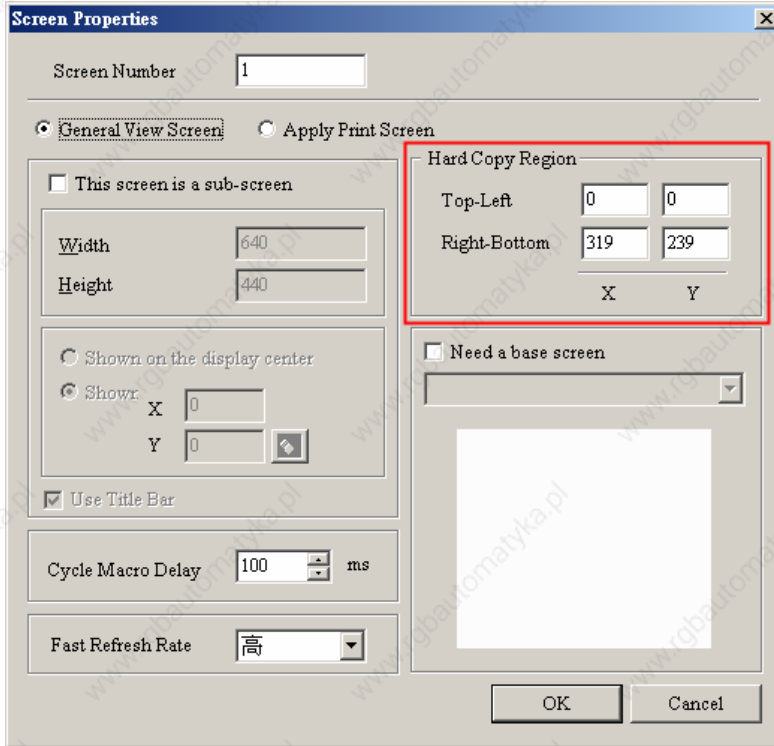
Set the properties of the “Report List” option. The Report Device can be SMC, USB Disk, and Printer. Please notice that if the users select SMC or USB Disk, the data will be outputted to SMC or USB Disk only and it will not be printed out.



How to Use Hard Copy Function

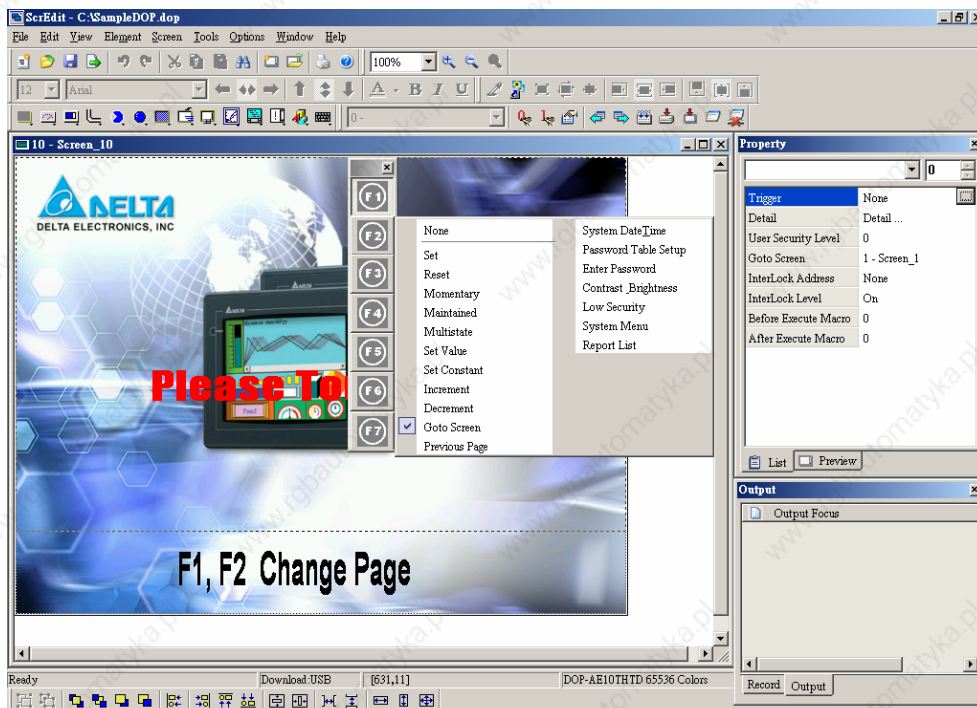
The Hard Copy function is available only when the screen is a “General View Screen”. If HMI detects the “Print Typesetting” function is already set for the editing screen, the “Hard Copy” function will be ineffective.

Step1: Set the Hard Copy Region in Screen Properties tab.



Step2: Enable the Print function.

Right clicking the mouse or use function key to create a “Report List” button on a “General View Screen”. Then, use this “Report List” button to enable the print function, just like “Print Typesetting” function.



Picture Bank

Picture Bank

The users can use this option to import various pictures to rich the screens selection and make the Picture Bank to be more plentiful. Please Click **Options > Picture Bank** to execute this function.

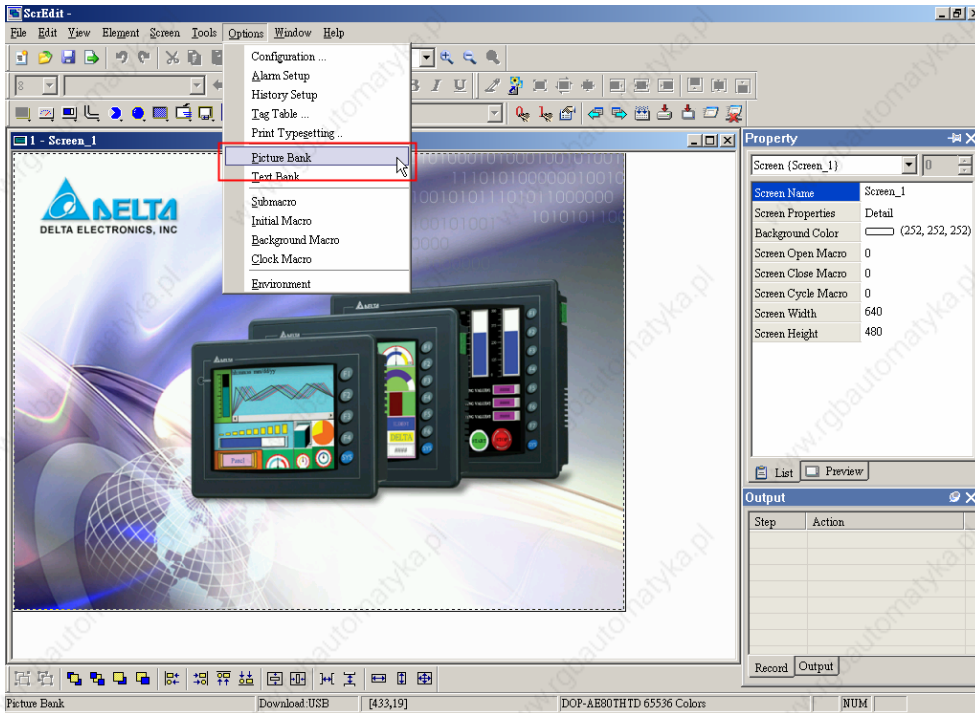


Fig. 2.9.8 Choosing Picture Bank command from menu bar

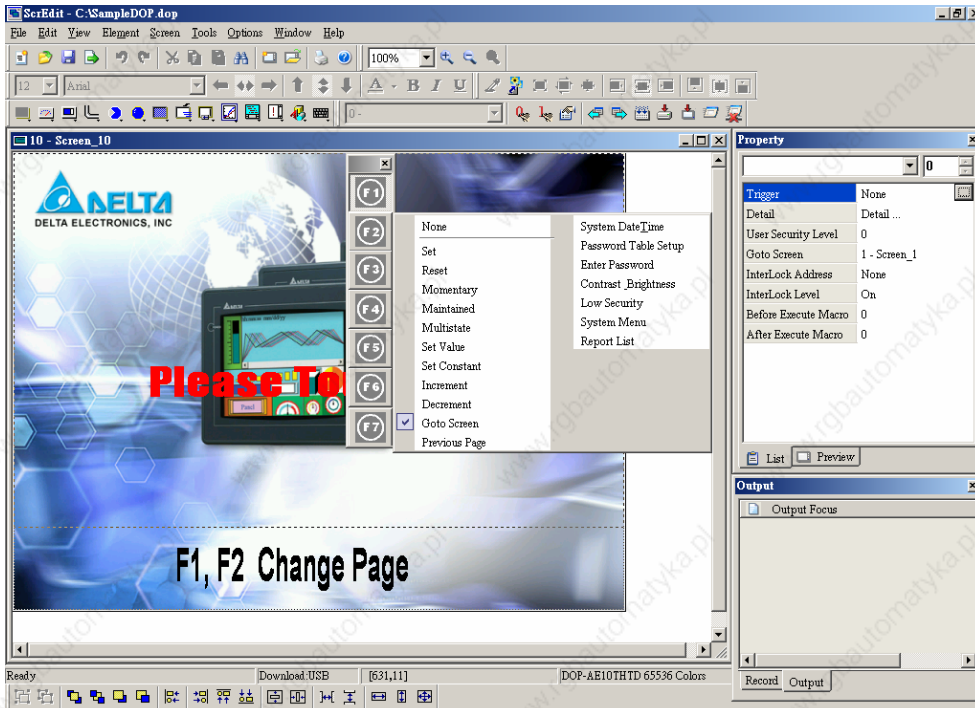








Fig. 2.9.9 Picture Bank

Table 2.9.9 Picture Bank Settings



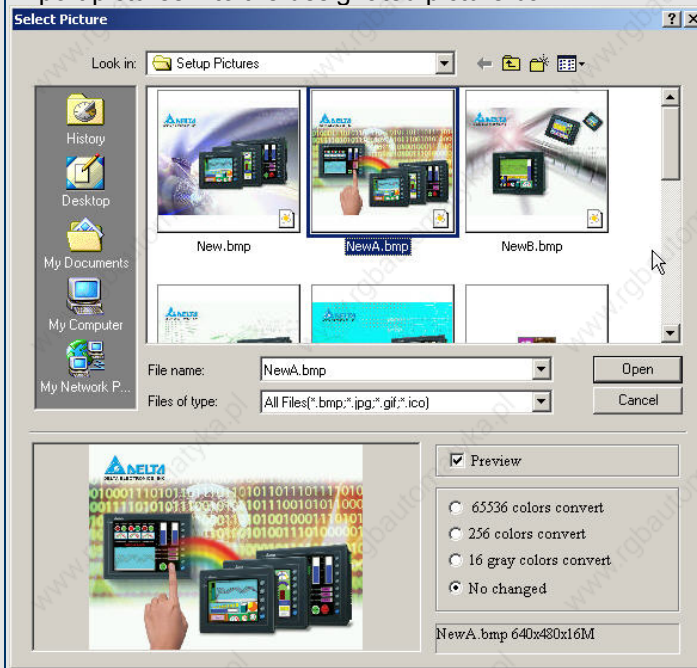
Click Picture Bank option to browse all pictures saved in Picture Bank. When one picture is selected, the users can see the picture in the preview window. Double left-clicking the mouse on the selected picture can display the picture in an actual size view.

 <p>New Picture Bank</p>	<p>Create a new picture bank. After clicking the icon , the following New Picture Bank dialog box will display on the screen.</p> 
 <p>Open Picture Bank</p>	<p>Open a picture bank file (*.pib file).</p>
 <p>Uninstall Picture Bank</p>	<p>Uninstall the selected picture bank. The uninstall picture bank will be moved to Recycle Bin.</p>
 <p>Save</p>	<p>Save the modified picture into the picture bank.</p>

Picture Bank Browse Dialog Box

Import Picture

Import pictures into the designated picture bank.



The formats of the pictures in the picture bank can be BMP, JPG, GIF(static) and ICON pictures. When selecting this function, the dialog box shown above will display. Then, the users can convert the picture color in advance to speed the compile time or choose “No changed” option to remain the original color.

Export

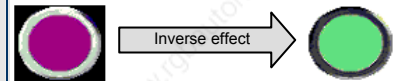
Export pictures in BMP format from the picture bank.

Delete

Delete pictures in the picture bank.

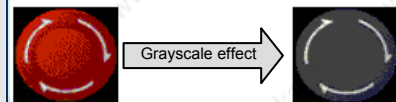
Inverse

Inverse the picture color. Negative effect.



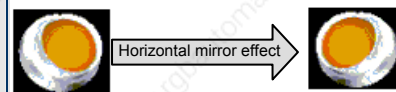
Grayscale

Convert the colorful picture to 256 grayscale color.



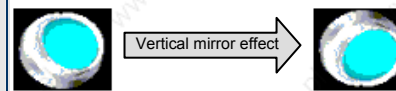
Horizontal Mirror

Horizontal mirror effect.



Vertical Mirror

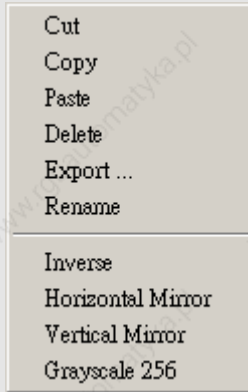
Vertical mirror effect.



Picture Bank Browse Dialog Box

Shortcut Menu

The users can right-click the mouse to display a shortcut menu shown on the figure below. This shortcut menu is a menu that shows a list of commands relevant to picture bank option for the users to manage the pictures in the picture bank more quickly and efficiently.



■ **Text Bank**



Input common or frequently used text and terms into Text Bank. The users can select the text from the Text Bank and enter them on the element more easily and quickly if necessary.

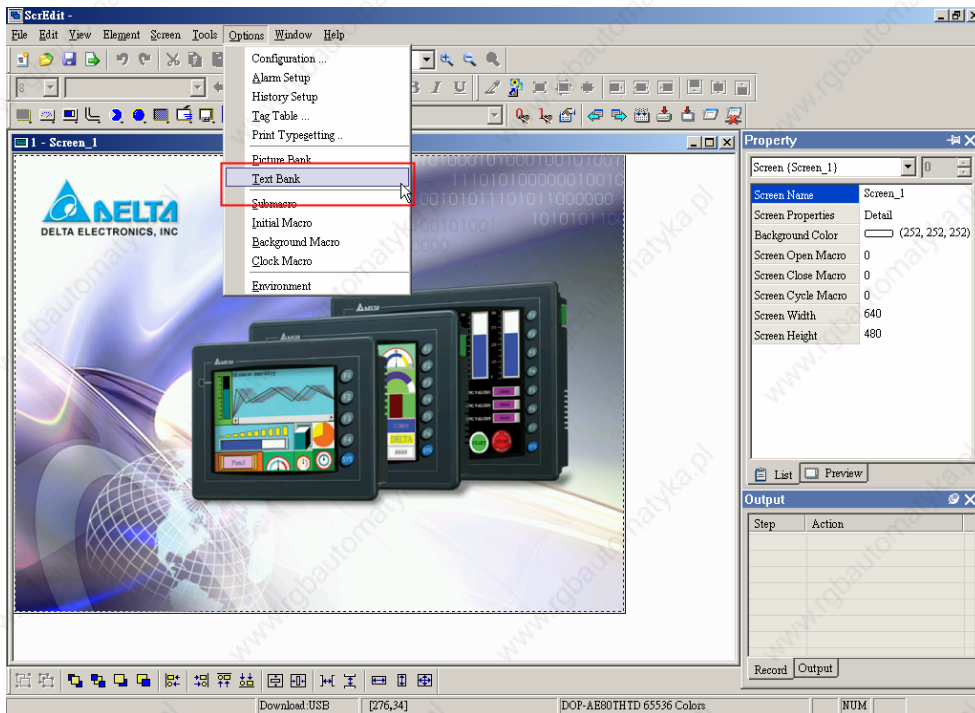
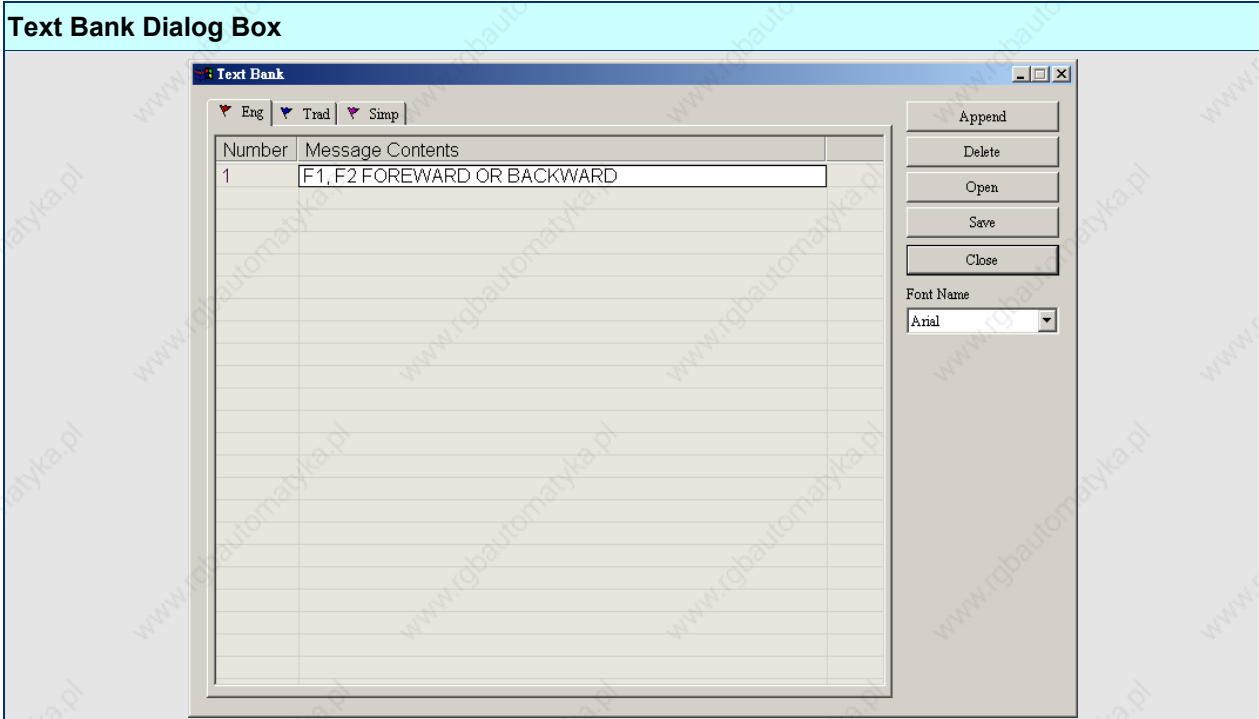


Fig. 2.9.10 Choosing Text Bank command from menu bar

Table 2.9.10 Text Bank Settings



Append	Press Append button to add the text into Text Bank. The multi-language editing is supported in Text Bank option. The users can input the text or terms in different language and saved them in Text Bank. The multi-language font can also be set simultaneously.
Delete	Press Delete button to remove the input text or terms in Text Bank.
Open	Press Open button to open and import the text or terms into Text Bank.
Save	Press Save button to save and export the text file.
Close	Close and exit the text bank dialog box.

■ Submarro

Submacro

Use this option to edit sub-macro and be called by other Macro. For the Macro function, please refer to Chapter 4 for more details.

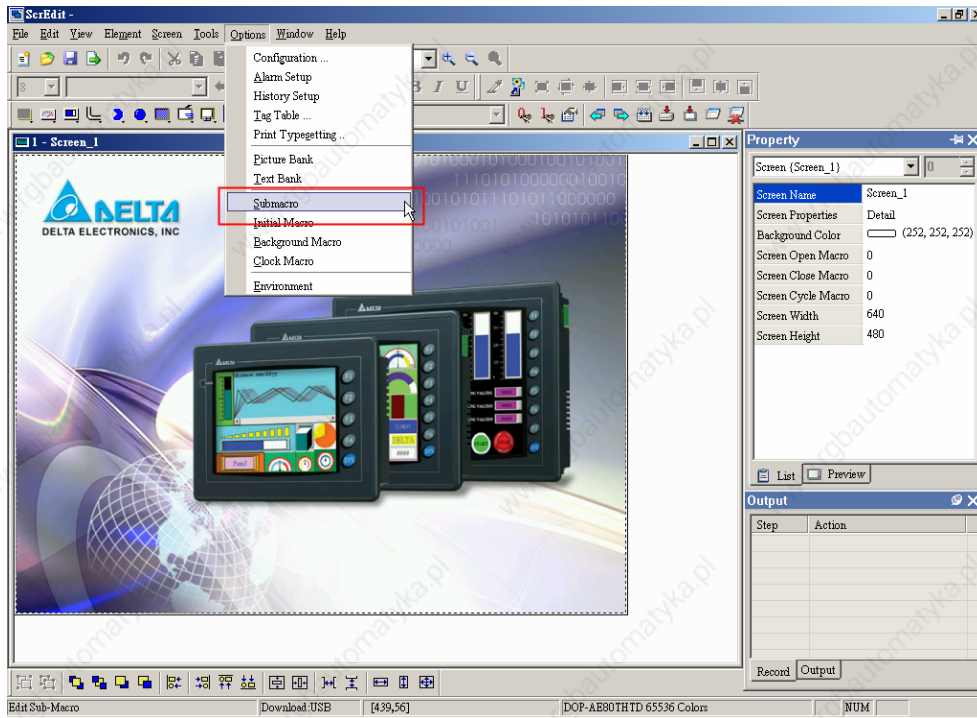


Fig. 2.9.11 Choosing Submacro command from menu bar

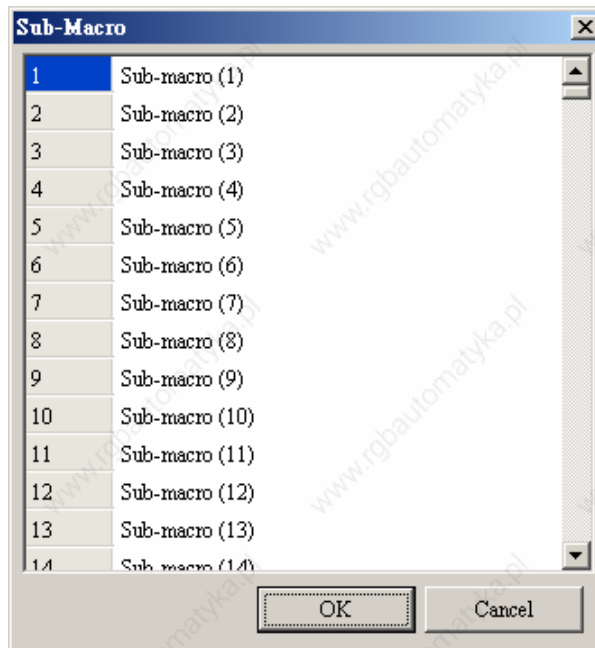


Fig. 2.9.12 Submarco dialog box

■ Initial Macro

Initial Macro

Use this option to edit initial macro. The initial macro will be executed automatically after the power is applied to HMI (power on). For the Macro function, please refer to Chapter 4 for more details.

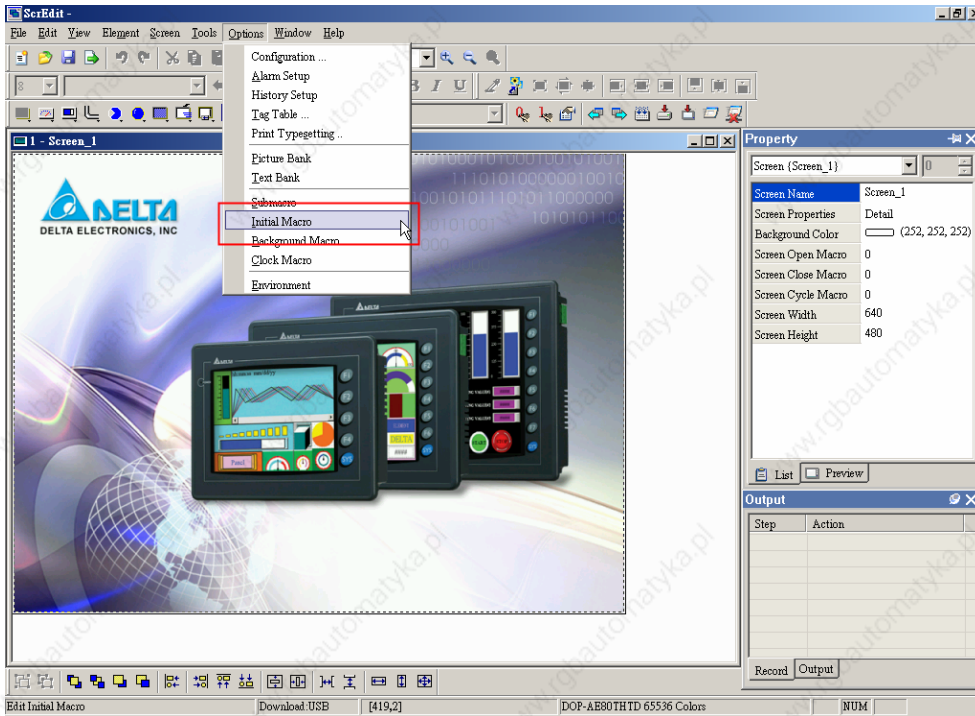


Fig. 2.9.13 Choosing Initial Macro command from menu bar

■ Background Macro

Background Macro

Use this option to edit background macro. For the Macro function, please refer to Chapter 4 for more details.

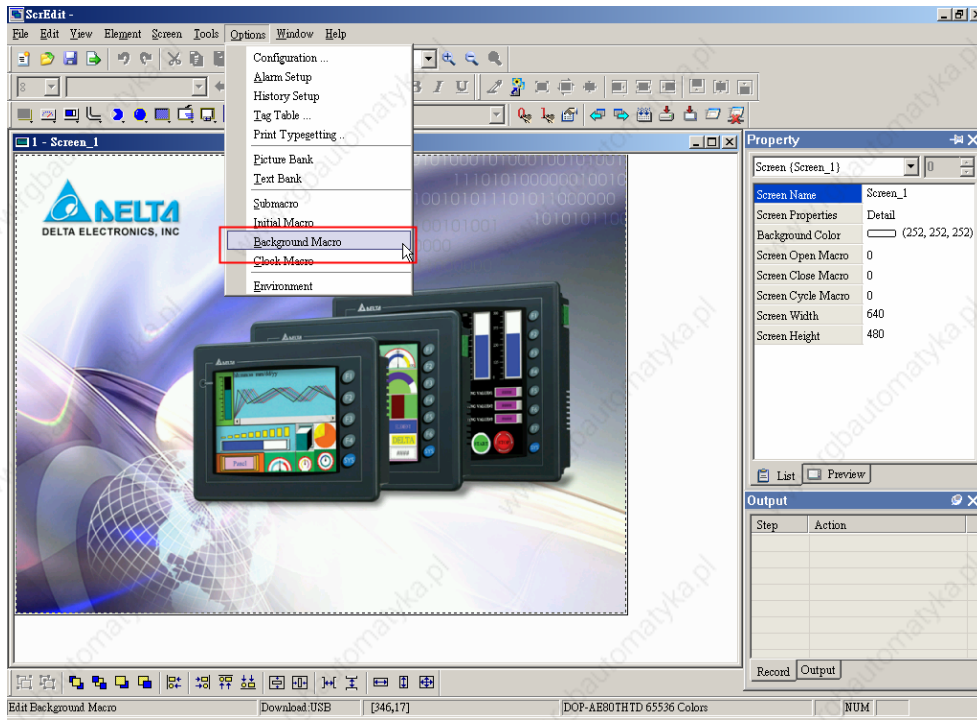


Fig. 2.9.14 Choosing Background Macro command from menu bar

■ Clock Macro

Clock Macro

Use this option to edit clock macro. After HMI is turned power on and starting initial setup, the clock macro will be executed automatically by clock setting time. For the Macro function, please refer to Chapter 4 for more details.

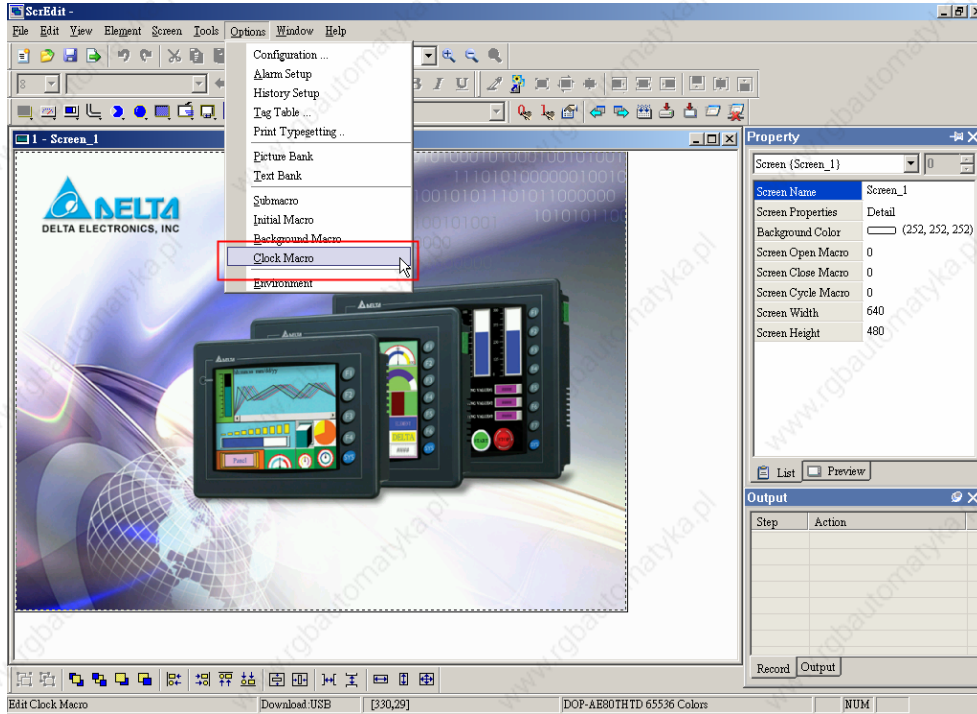


Fig. 2.9.15 Choosing Clock Macro command from menu bar

■ Environment

Environment Use this option to complete the environment settings of Screen Editor.

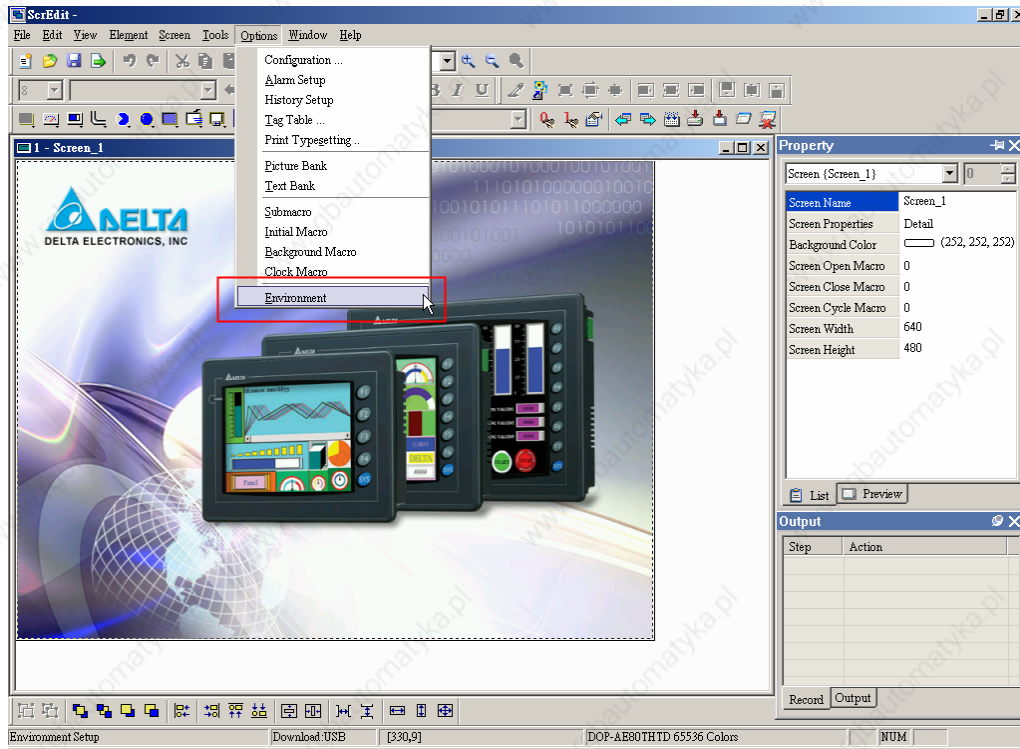
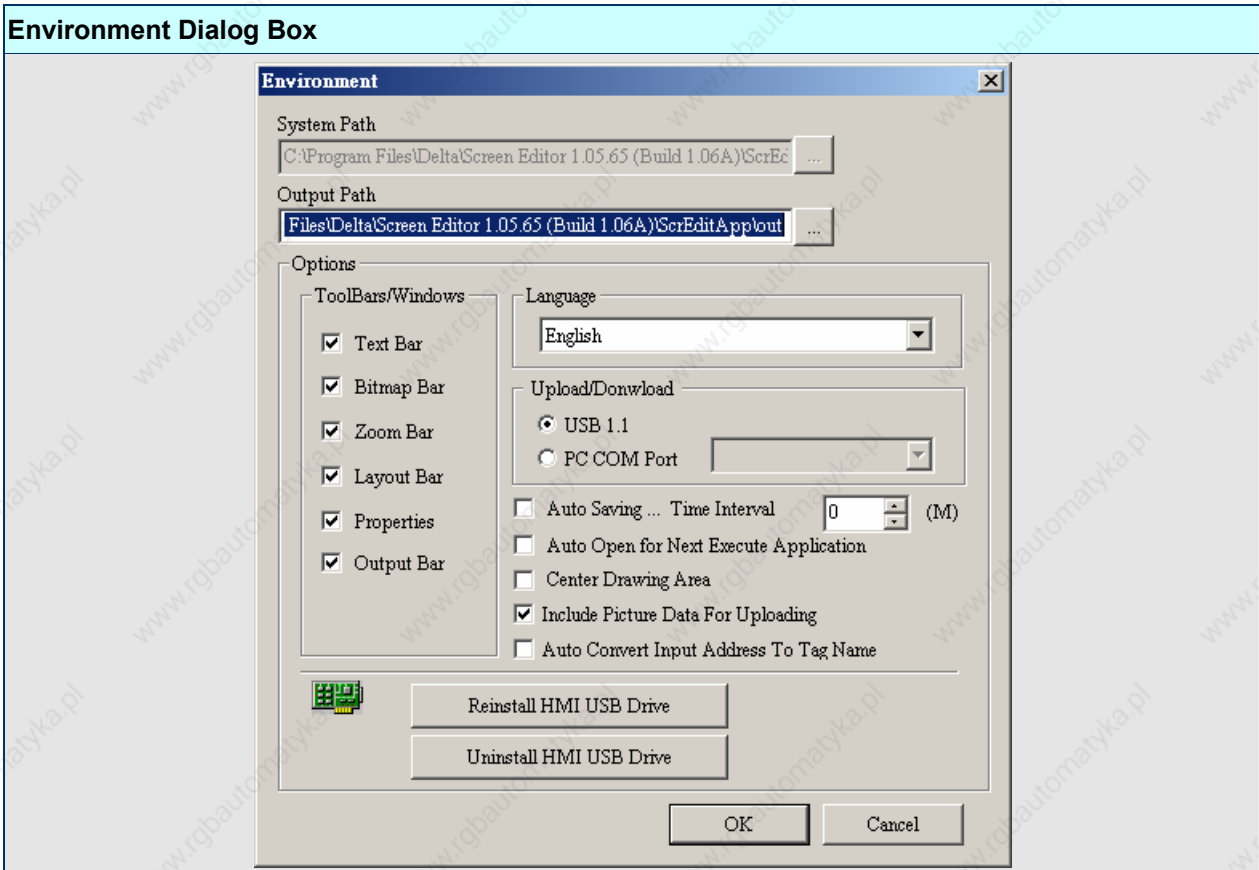


Fig. 2.9.16 Choosing Environment command from menu bar

Table 2.9.11 Environment Settings



System Path	This is used to set the location where ScrEdit save the system files, including some system reference data and dynamic link library (*.dll) files. In order to avoid the system error and failure to find the file, we recommend the users not to change this setting if not necessary. (This option by system default is disabled.)	
Output Path	This is used to set the location where ScrEdit save the output file after compile operation. Some functions, such as on-line simulation, off-line simulation, file download and upload all refer to the files in this location.	
Options	ToolBars/Windows	It is used to set if toolbars or ducking windows display or not display on the screen.
	Language	The users choose English , Traditional Chinese and Simplified Chinese from the “Language” drop-down list.
	Upload/Download	It is used to determine the communication interface for upload and download. It can be USB or PC COM Port.
	Auto Saving... Time Interval	It is used to have ScrEdit automatically save the file every specified number of minutes. The unit is M(minute) and the setting range is within 0M ~ 120M.
	Auto Open for Next Execute Application	It is used to have ScrEdit automatically open the specified file every time the users execute ScrEdit.

Environment Dialog Box	
Center Drawing Area	<p>When this option is selected, the editing screen will be placed in the center position.</p> 
Include Picture Data For Uploading	<p>If this option is selected, all pictures will be also uploaded when ScrEdit upload function is enabled. All uploaded pictures will be saved in a file named as “_LOCALTEMP01.PIB”. The “Picture Bank Name” and the “Picture Name” (set in Property ducking window) of the editing elements will refer to and link to this file too. If ScrEdit ends the editing abnormally, the file name will be named as “_LOCALTEMP02.PIB, _LOCALTEMP03.PIB ...”, and vise versa when execute uploading next time. The last two numbers at the end of the file name will increase progressively.</p>
Auto Convert Input Address To Tag Name	<p>For example, if the users want to replace PLC address 1@Y0 with the word “OS”, just define it in Tag Table option in advance. When this option is selected, ScrEdit will automatically convert input address 1@Y0 to the word “OS”.</p>
Driver	<p>Reinstall HMI USB Drive: Press it to reinstall the HMI USB driver Uninstall HMI USB Drive: Press it to uninstall the HMI USB driver</p>
OK	<p>Press OK button to save the modified settings and exit the Environment dialog box.</p>
Cancel	<p>Press Cancel button exit the Environment dialog box without saving.</p>

2.10 Menu Bar and Toolbar (Window)

■ Window

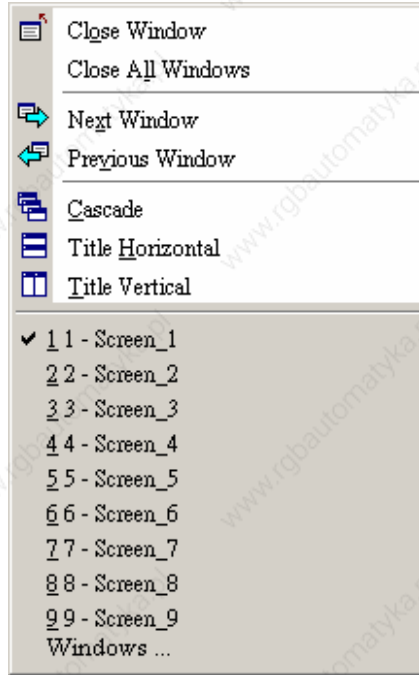
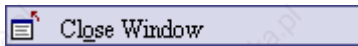


Fig. 2.10.1 Window options

■ Close Window



It is used to hide the current window, NOT exit the current window. The users can execute this function by clicking **Window > Close Window** (Fig. 2.10.2). If the users want to display the hidden window, please click **Screen > Open Screen** (Fig. 2.7.6) to open an old screen.

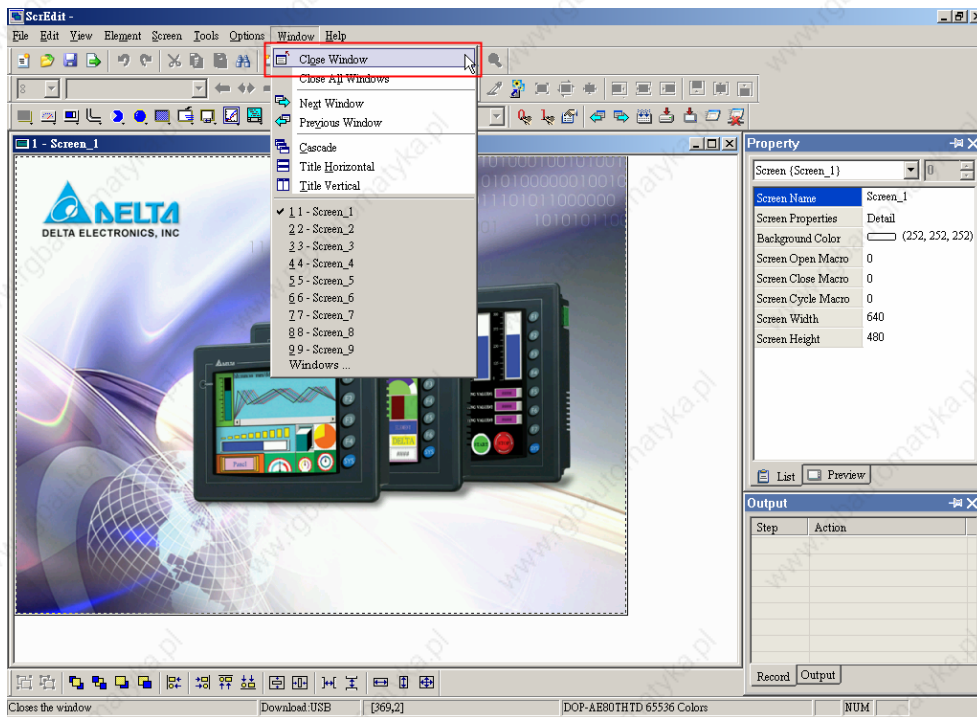
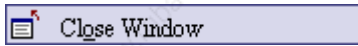


Fig. 2.10.2 Choosing Close Window command from menu bar

■ Close All Windows



It is used to hide all windows, NOT exit all windows. The users can execute this function by clicking **Window > Close All Windows** (Fig. 2.10.3). If the users want to display the hidden window, please click **Screen > Open Screen** (Fig. 2.7.6) to open old screens.

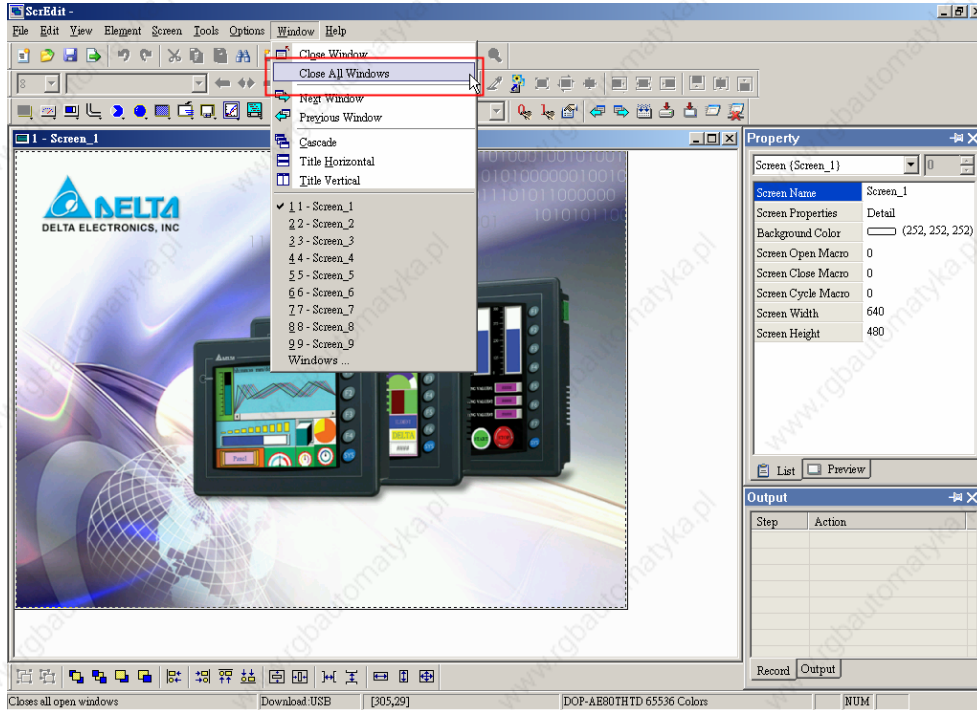


Fig. 2.10.3 Choosing Close All Windows command from menu bar

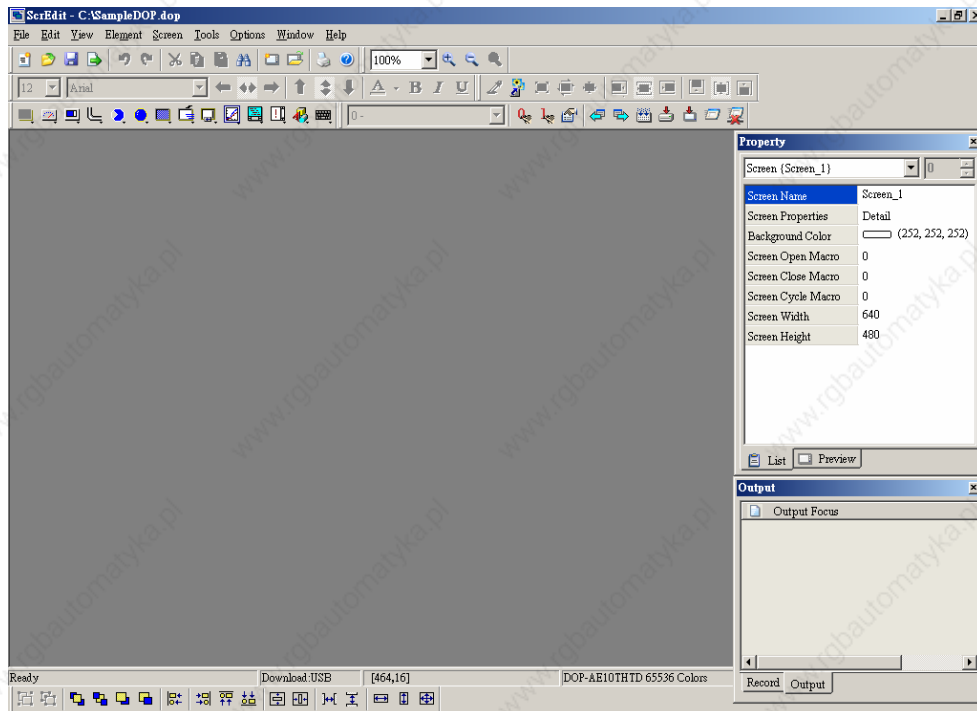


Fig. 2.10.4 Screen status after all windows are closed

■ Next Window



It is used to switch the current window to the next window. If the current window is the last window, the current window will not be changed even if this function is executed.

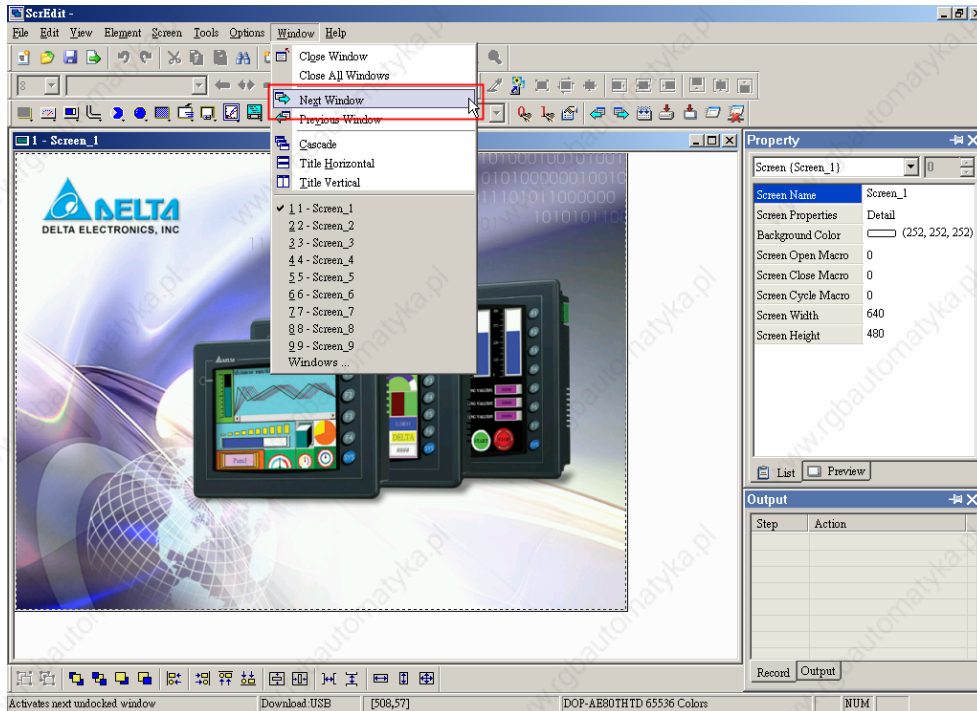


Fig. 2.10.5 Choosing Next Window command from menu bar

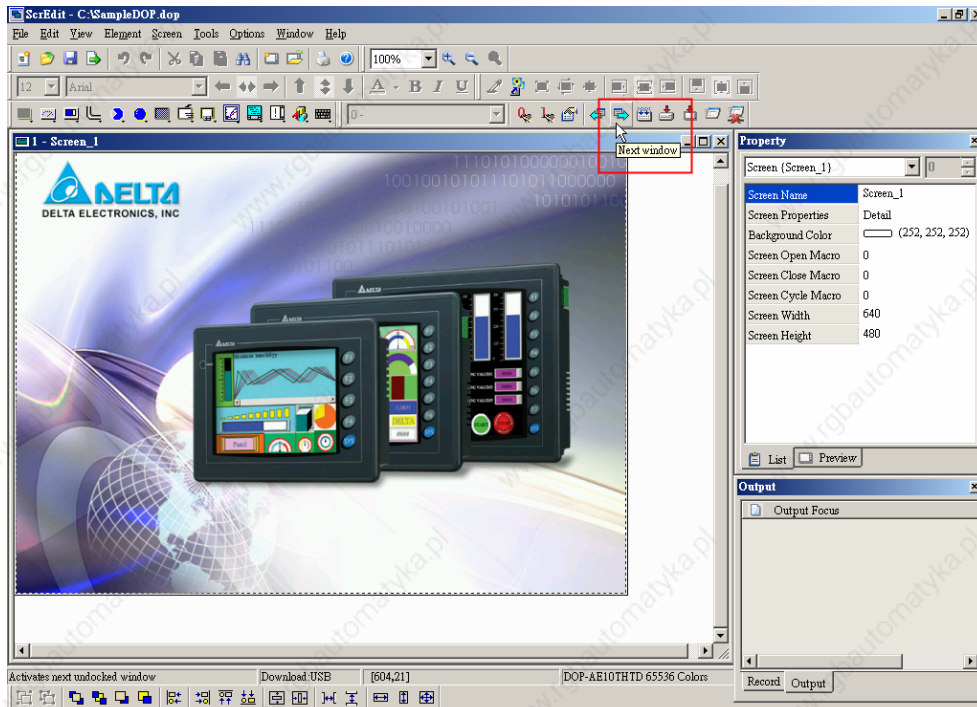


Fig. 2.10.6 Choosing Next Window icon from toolbar

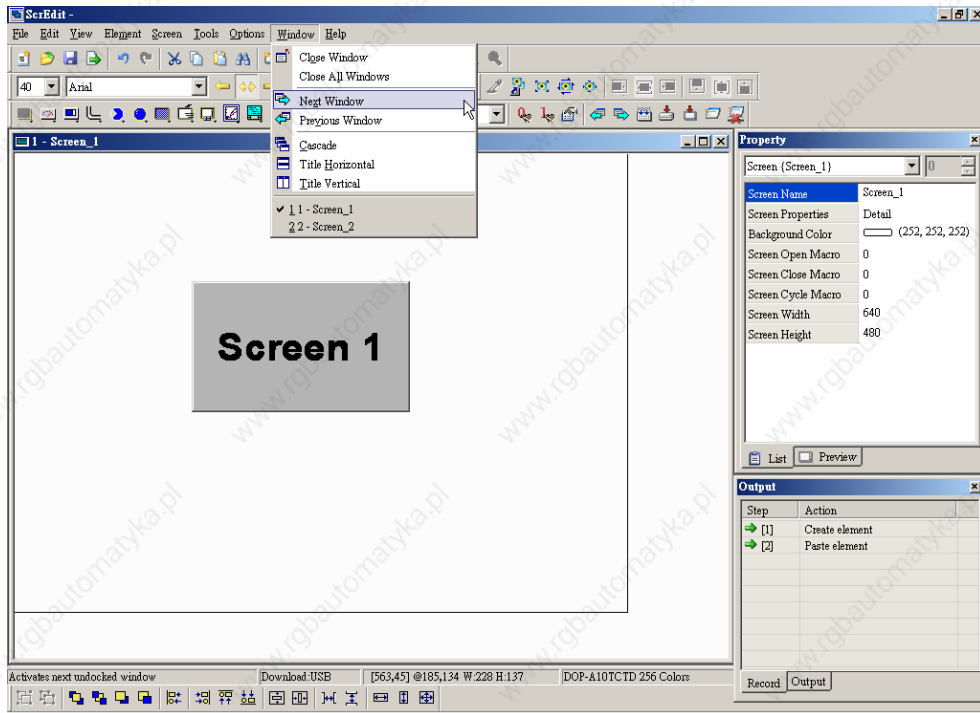


Fig. 2.10.7 Example screen1 for choosing next window (Before switching to next window)

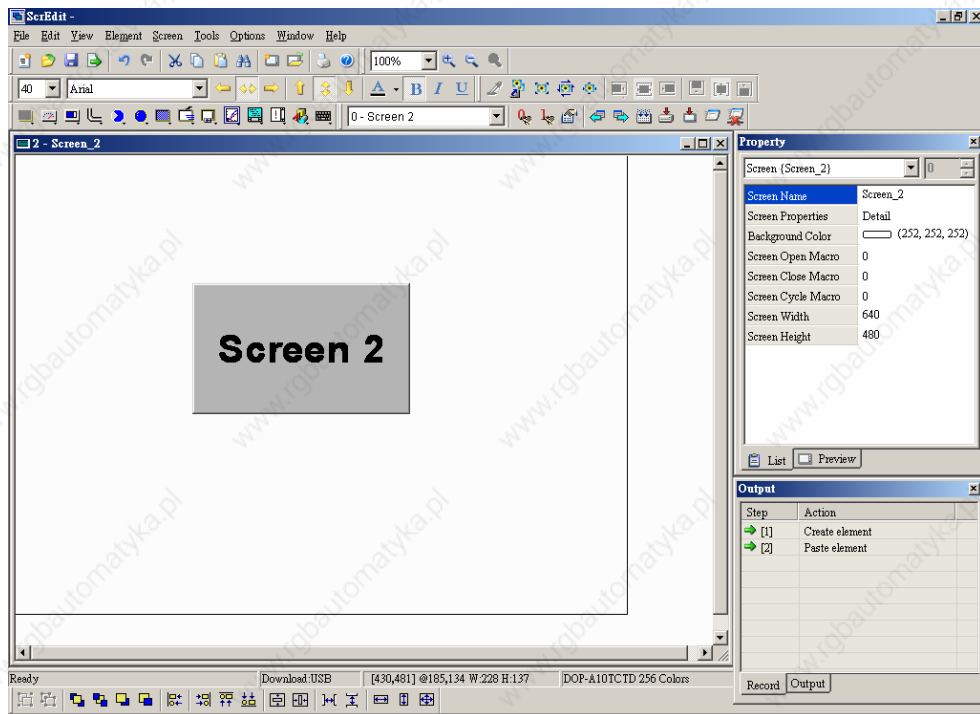


Fig. 2.10.8 Example screen 2 for choosing next window (After clicking "Next Window")

■ Previous Window



It is used to switch the current window to the previous window. If the current window is the first window, the current window will not be changed even if this function is executed.

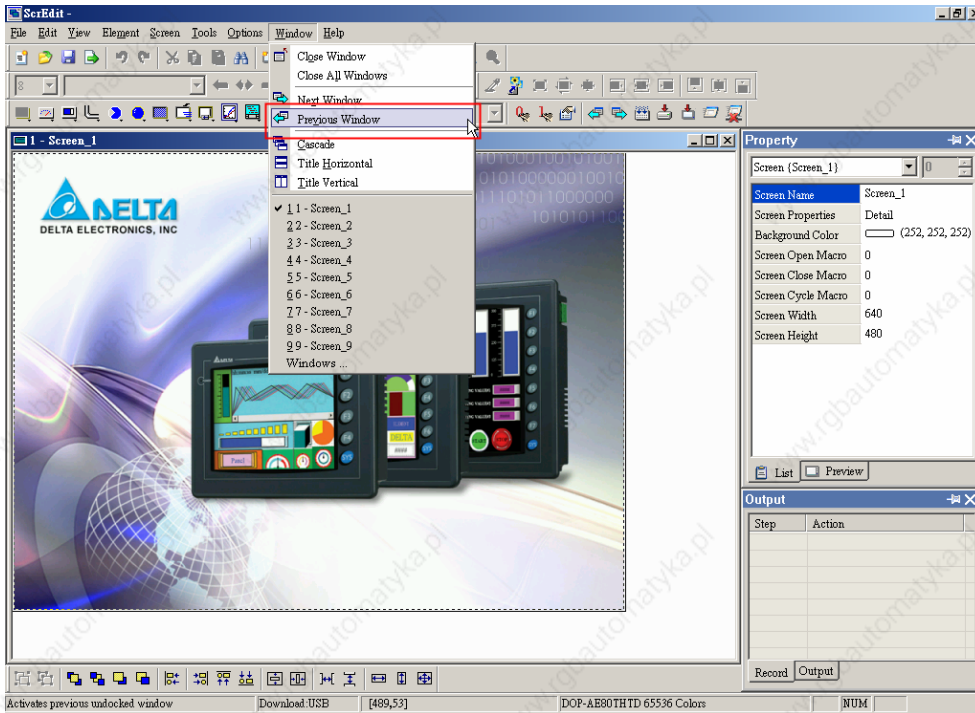


Fig. 2.10.9 Choosing Previous Window command from menu bar

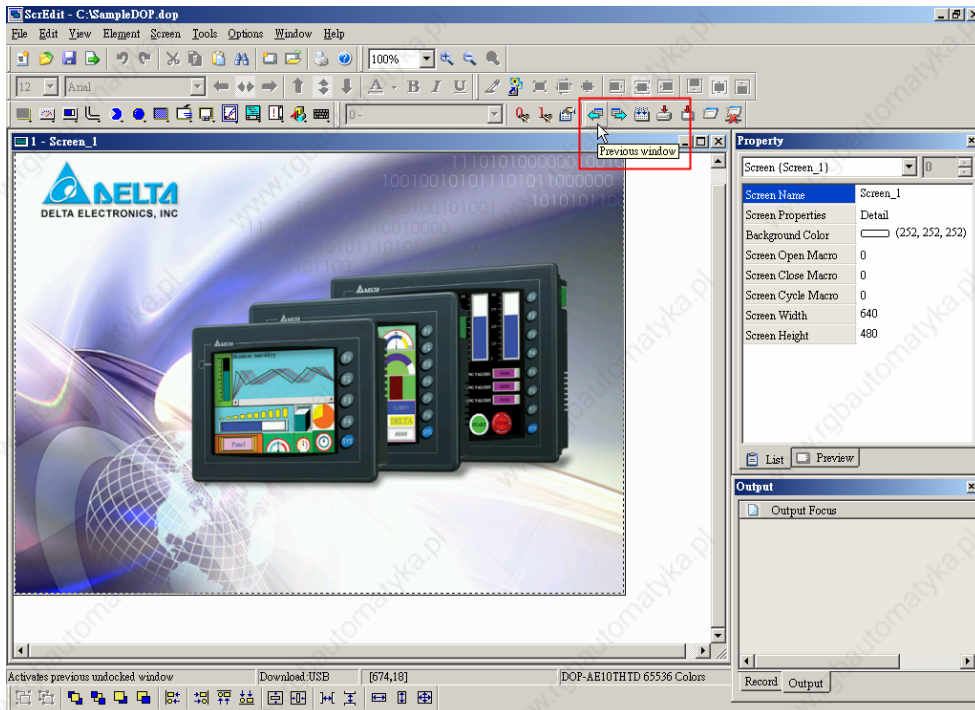


Fig. 2.10.10 Choosing Previous Window icon from toolbar

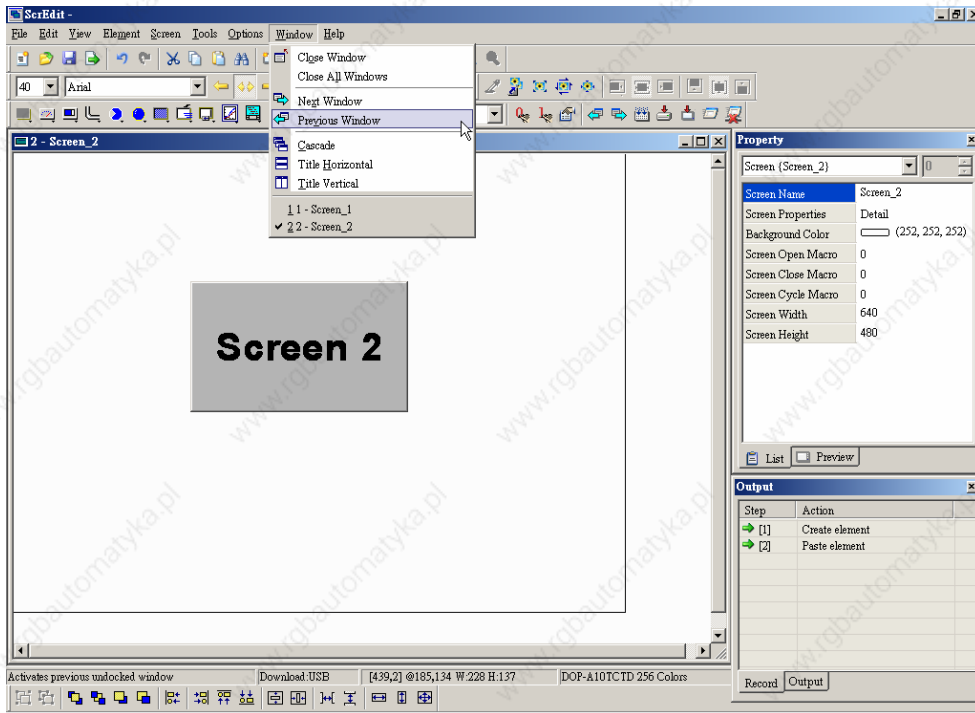


Fig. 2.10.11 Example screen1 for choosing previous window (Before switching to previous window)

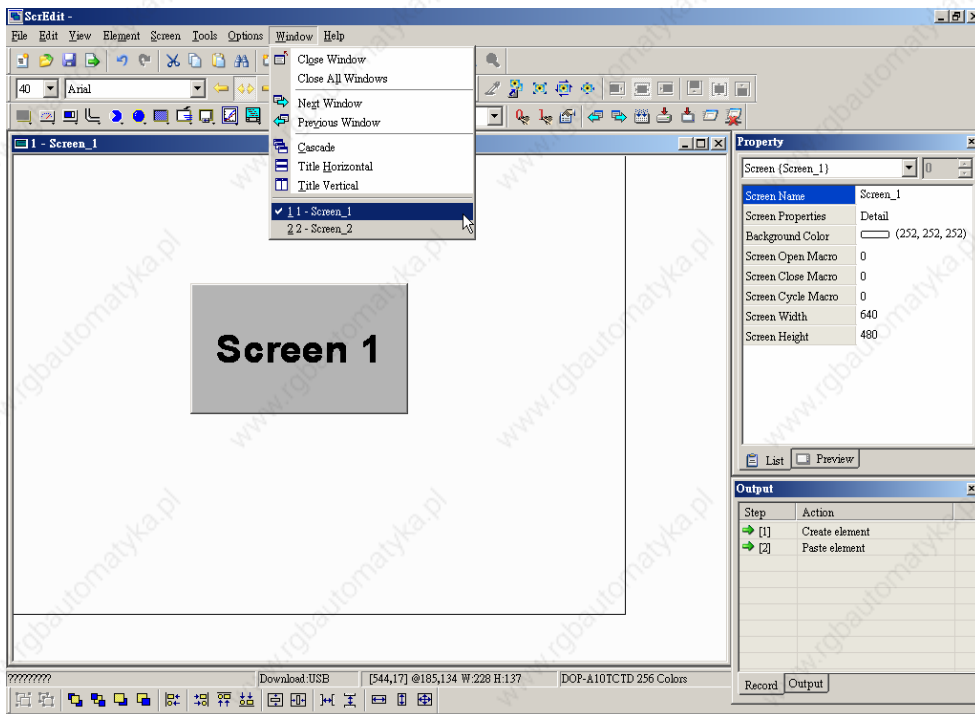


Fig. 2.10.12 Example screen 2 for choosing previous window (After clicking "Previous Window")

■ Cascade



Cascade display. Display all editing windows so that they overlap. The title bar of each window is visible but only the top window is fully visible. The users can execute this function by clicking **Window > Cascade** (Fig. 2.10.13). The opened windows are displayed in an overlapped pattern as shown as Fig. 2.10.14.

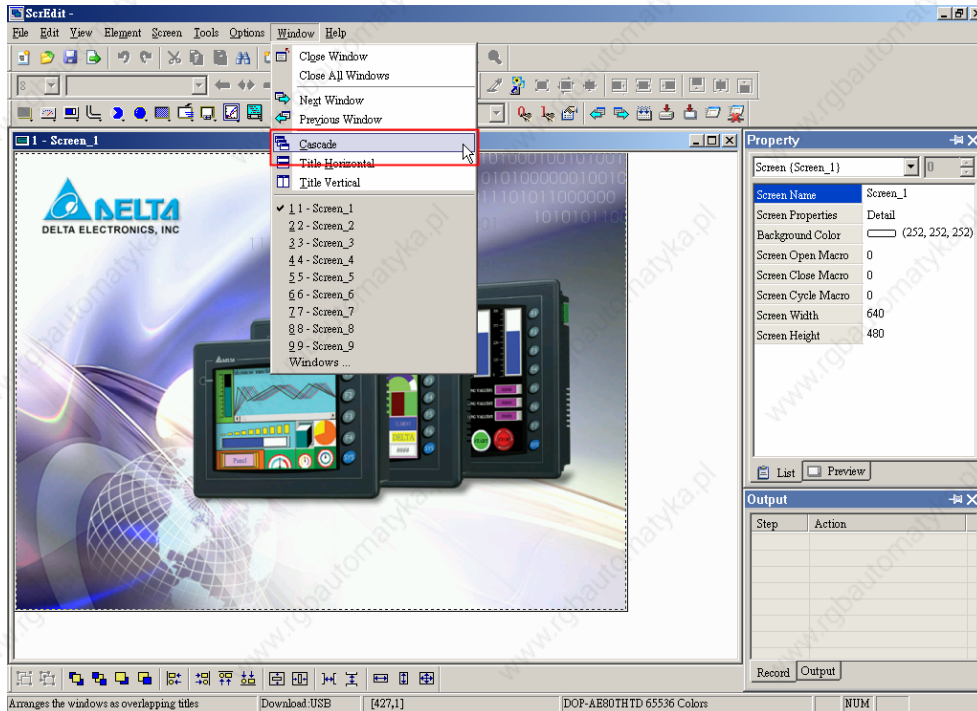


Fig. 2.10.13 Choosing Cascade command from menu bar

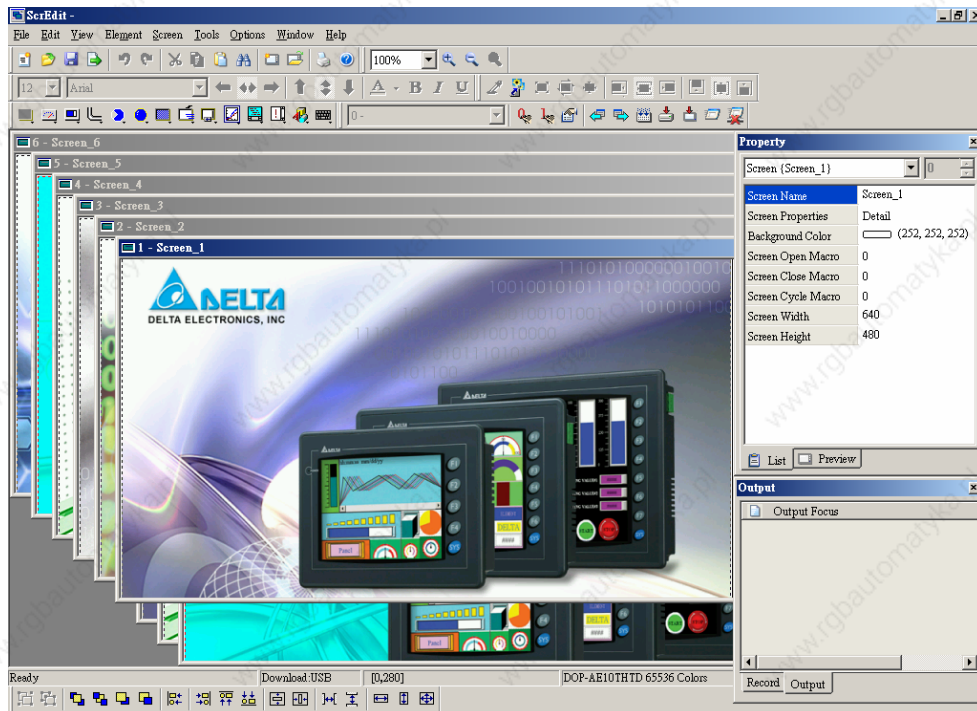


Fig. 2.10.14 Screen display after choosing Cascade command

■ Title Horizontal



Display all editing windows from top to bottom. The users can execute this function by clicking **Window > Title Horizontal** (Fig. 2.10.15). The opened windows are displayed horizontally as shown as Fig. 2.10.16.

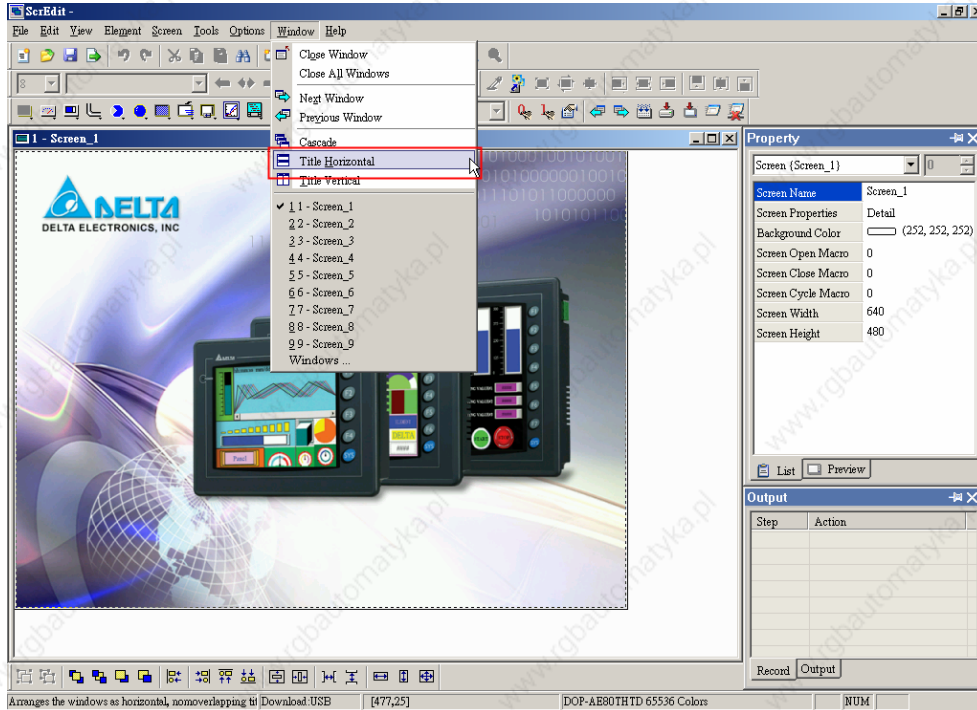


Fig. 2.10.15 Choosing Title Horizontal command from menu bar

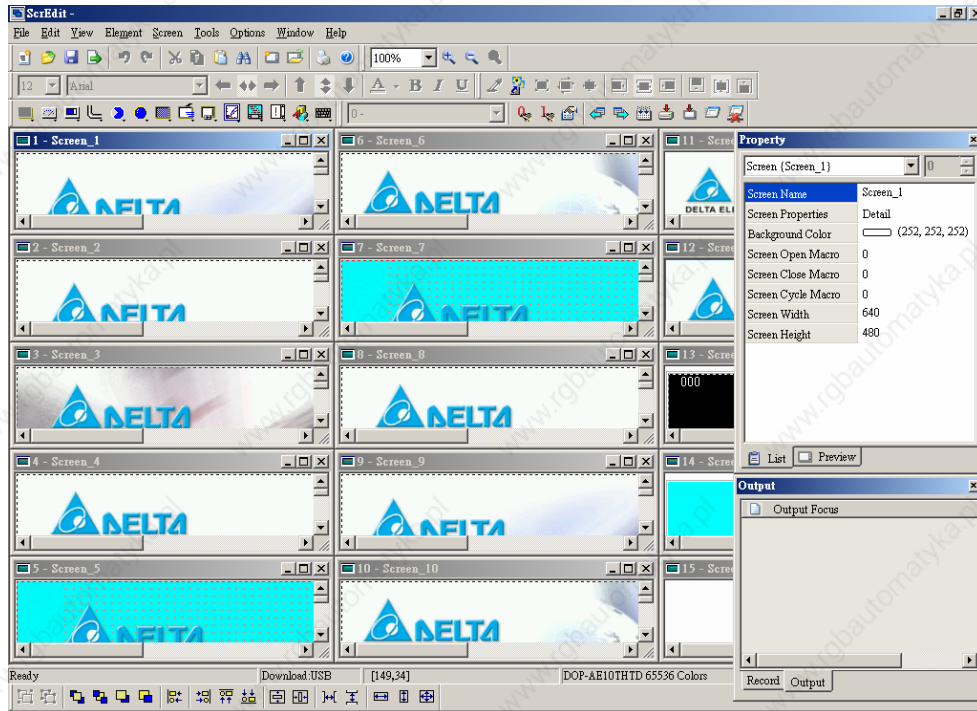


Fig. 2.10.16 Screen display after choosing Title Horizontal command

■ Title Vertical



Display all editing windows from left to right. The users can execute this function by clicking **Window > Title Vertical** (Fig. 2.10.17). The opened windows are displayed vertically as shown as Fig. 2.10.18.

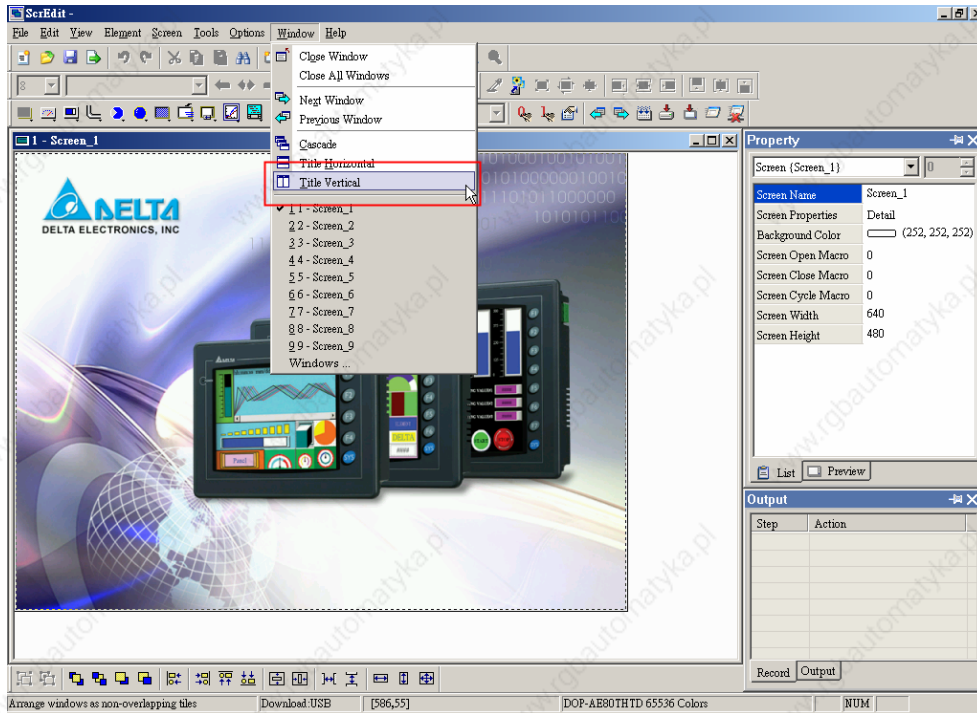


Fig. 2.10.17 Choosing Title Vertical command from menu bar

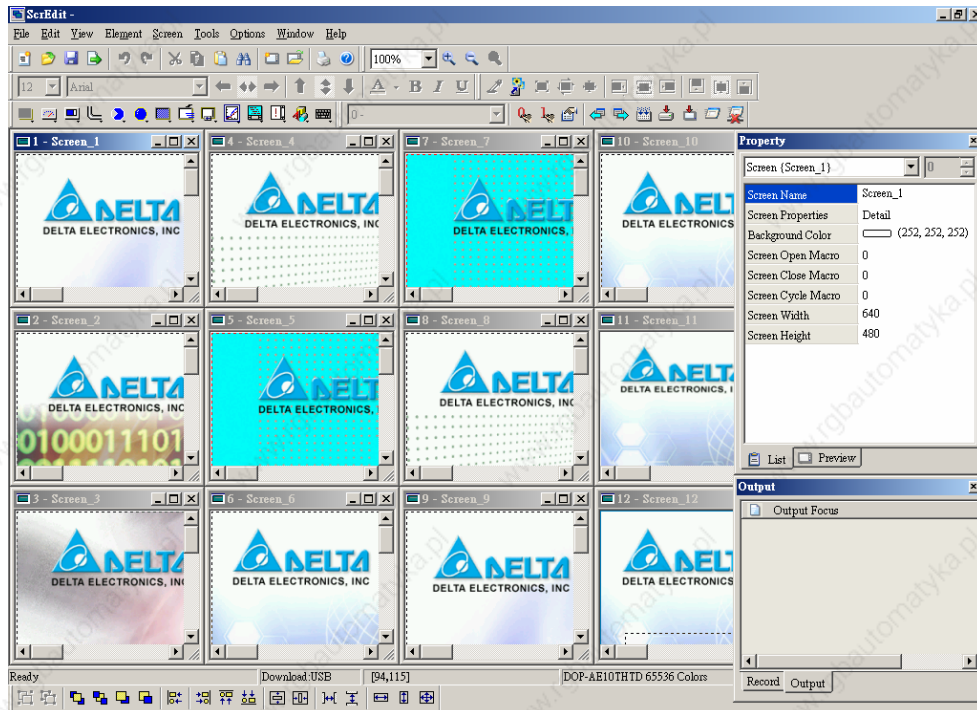


Fig. 2.10.18 Screen display after choosing Title Vertical command

■ Window Summary

ScrEdit shows a list of all opened screens at the bottom of “Window” pull-down menu for quick access. Just click the file name to open the file and view the screen directly.

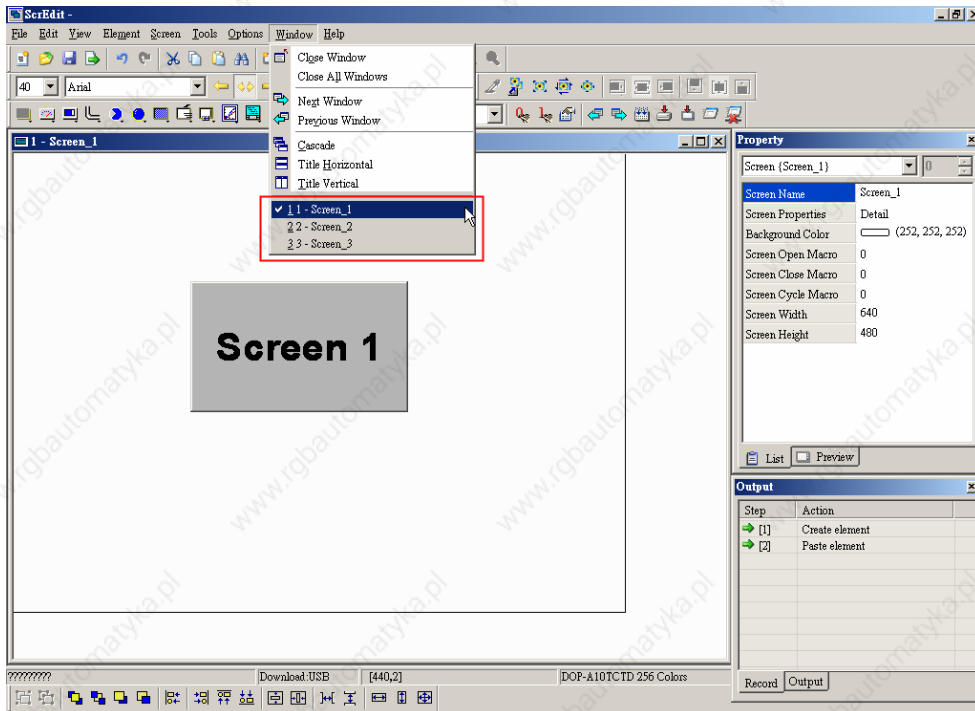


Fig. 2.10.19 Window Summary

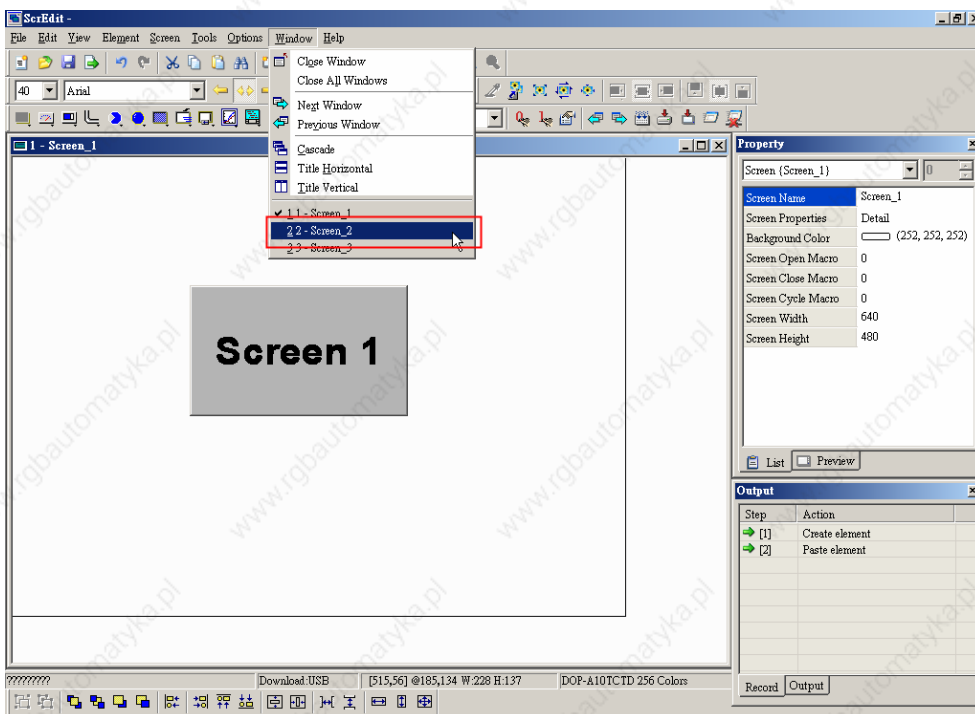


Fig. 2.10.20 Choosing Screen 2 from Window menu bar

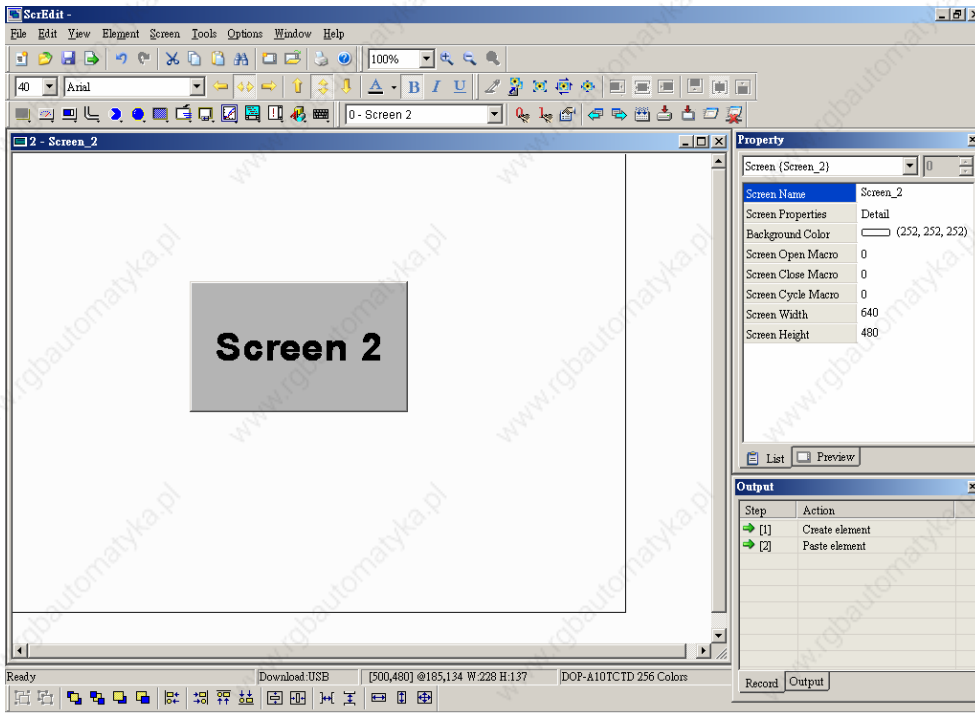


Fig. 2.10.21 Switching to Screen 2

2.11 Menu Bar and Toolbar (Help)

- Help



Fig. 2.11.1 Help option

- About ScrEdit



Display the version information of Screen Editor.



Fig. 2.11.2 Screen Editor Version

Chapter 3 Element Function

In order to meet different applications and requirements, ScrEdit provides various elements for the users to use and design. Before using and designing these elements, please read this chapter first to understand how to choose an element and the special function of each element in ScrEdit.

3.1 How to Choose Element

There are three methods for choosing elements when editing the screens:

1. Right-click the mouse in the work place and a shortcut menu will display as Fig. 3.1.1. The users can choose the desired elements by the mouse.
2. Choose Element command from menu bar as Fig. 3.1.2.
3. Choose Element icon from toolbar as Fig. 3.1.3.

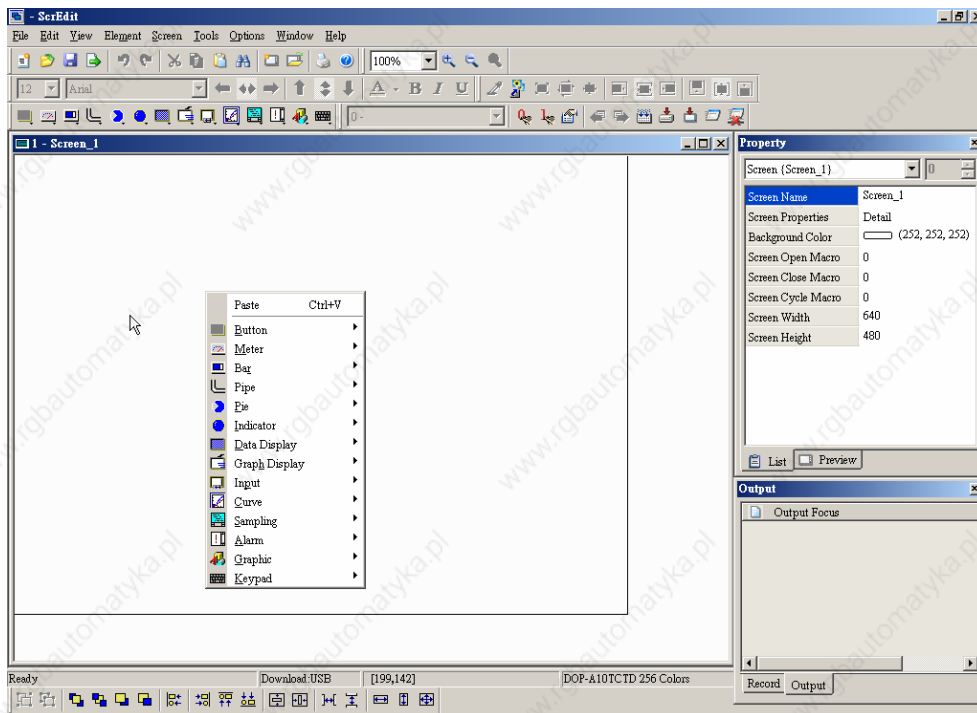


Fig. 3.1.1 Shortcut menu display

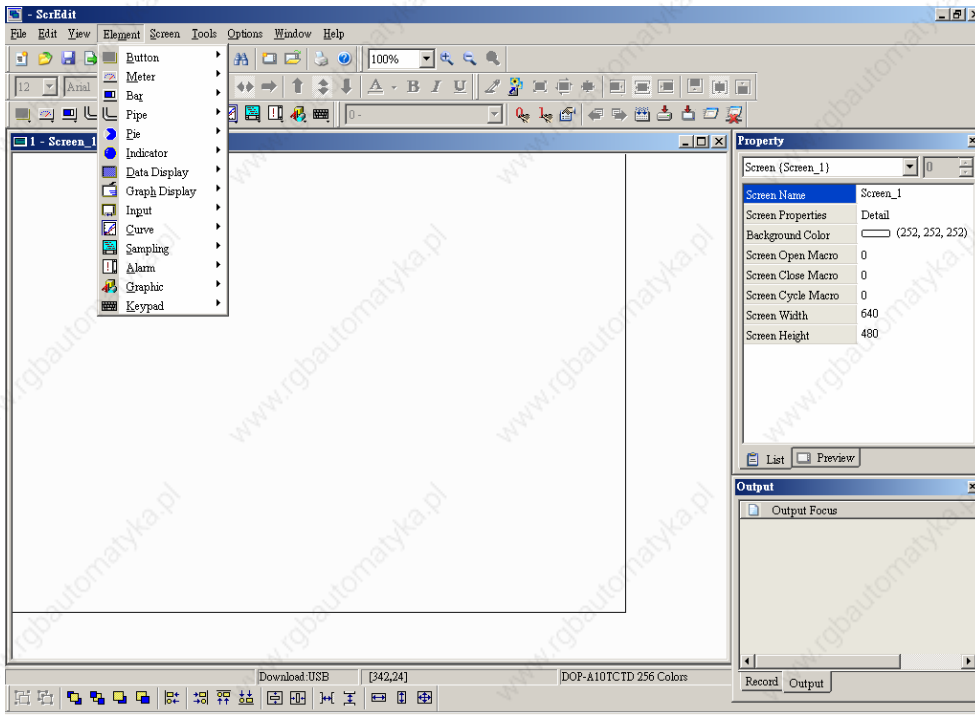


Fig. 3.1.2 Choosing Element command from menu bar

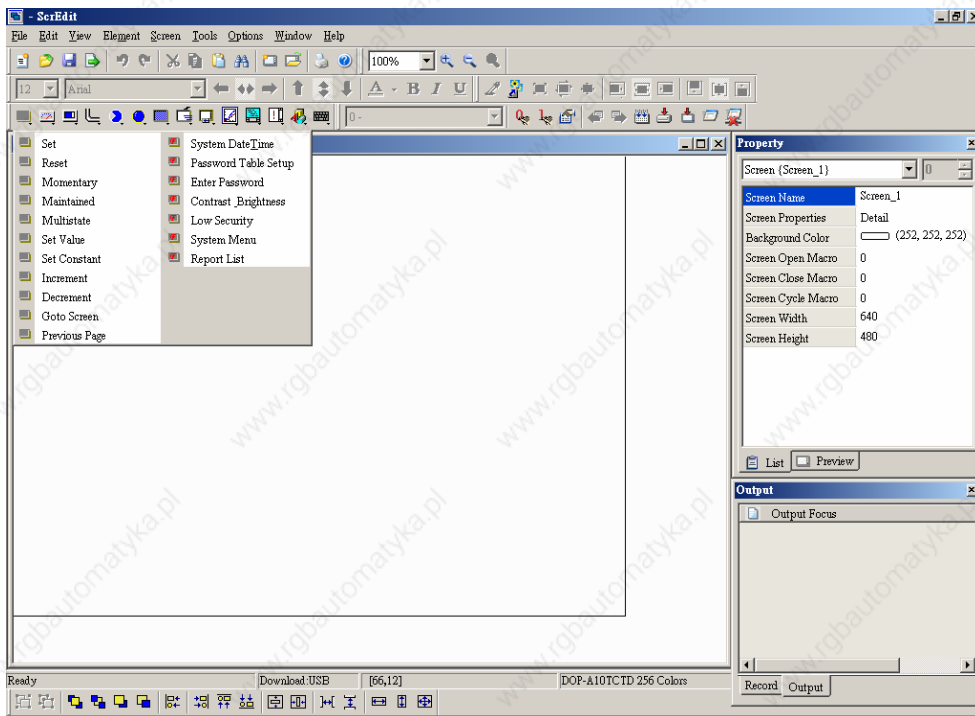


Fig. 3.1.3 Choosing Element icon from toolbar

After selecting an element, left-click and drag the mouse on work place to create an new element as shown in the following Fig. 3.1.4.

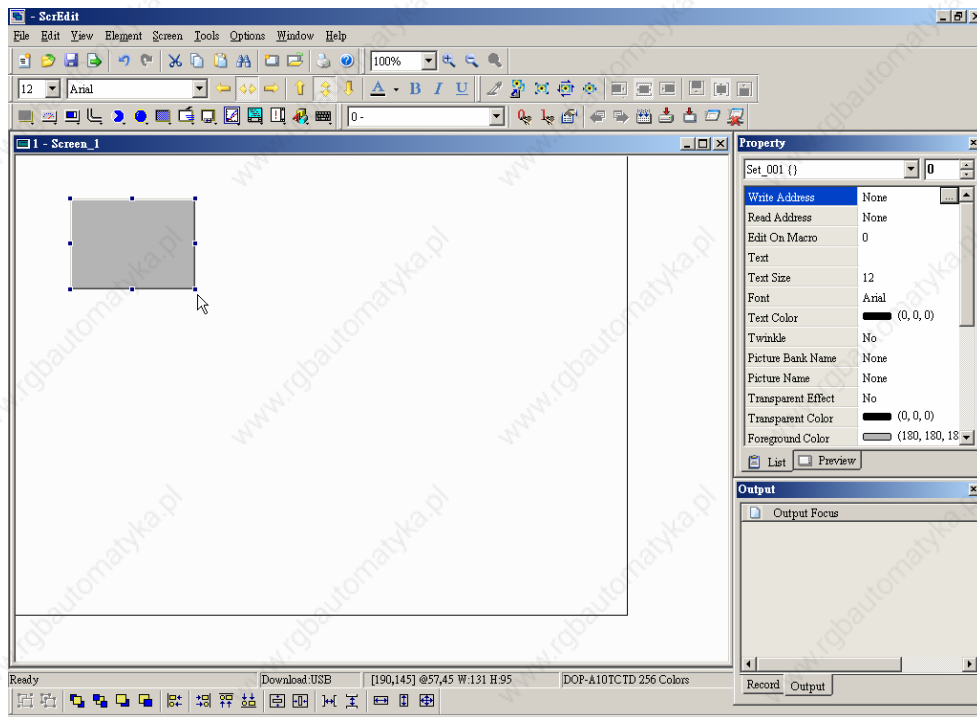


Fig. 3.1.4 Creating an element by the mouse

3.2 Button Element



Fig. 3.2.1 Button element options

Table 3.2.1 Button elements


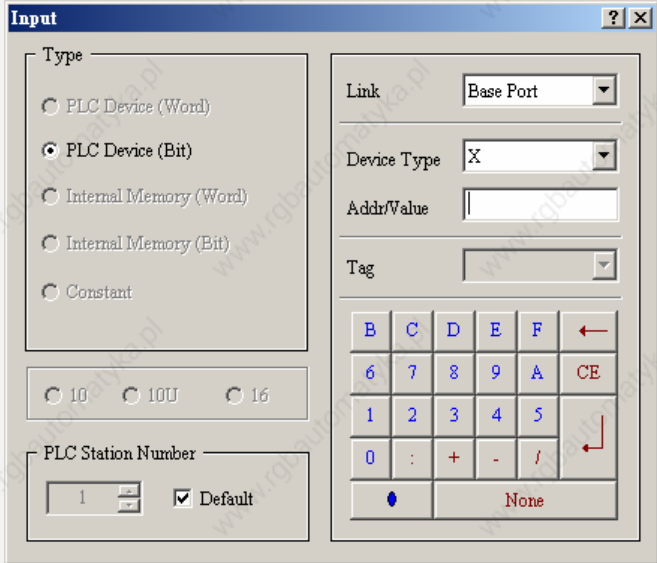
Button Type	Macro	Read	Write	Function
Set	ON	Yes	Yes	After pressing this button, the state of the setting address (Bit) will be set to ON. The state of the setting address will be always ON even if the users release the button or press it again. If there is an ON Macro, it will be executed simultaneously.
Reset	OFF	Yes	Yes	After pressing this button, the state of the setting address (Bit) will be set to OFF. The state of the setting address will be always OFF even if the users release the button or press it again. If there is an OFF Macro, it will be executed simultaneously.
Momentary	ON OFF	Yes	Yes	After pressing this button, the state of the setting address (Bit) will be set to ON and execute ON Macro at the same time. The state of the setting address will be ON when releasing the button and be OFF when pressing it again. If the users execute OFF Macro simultaneously, it will still be OFF when releasing the button.
Maintained	ON OFF	Yes	Yes	After pressing this button, the state of the setting address (Bit) will be set to ON. The state of the setting address will be OFF when releasing the button. If there is ON / OFF Macro, it will be executed simultaneously.
Multistate	No	Yes	Yes	There are 1~256 user-defined multi-states for setting. The users can set the execution sequence to the next state or the previous state. If the users set to the next state, the state will become state 2. If the users set to the previous state, the state 2 will become state 1.
Set Value	No	No	Yes	After pressing this button, the “Numeric keypad” dialog box will pop up on HMI screen for the users to input the setting value directly. After inputting the setting value and pressing ENTER key, HMI will transmit the input value to the setting address.
Set Constant	No	No	Yes	After pressing this button, HMI will write the specific value into the setting address.


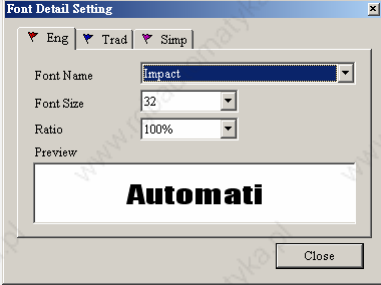
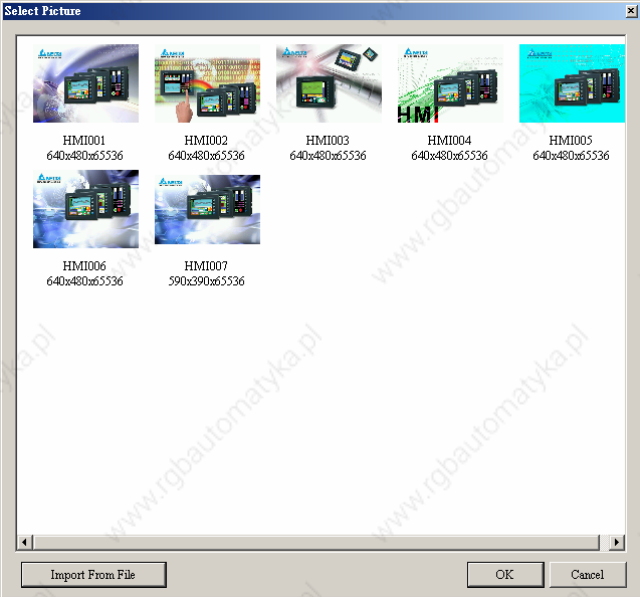
Button Type	Macro	Read	Write	Function
Increment	No	Yes	Yes	After pressing this button, HMI will add up the value contained within the setting address and the setting constant value, and store the addition result back into the setting address.
Decrement	No	Yes	Yes	After pressing this button, HMI will subtract the setting constant value from the value contained within the setting address, and store the subtraction result back to the setting address.
Goto Screen	No	No	No	After pressing this button, it will switch to the screen that the users designated.
Previous Page	No	No	No	After pressing this button, it will go back to the previous main screen.


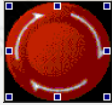
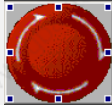




■ General Buttons

After pressing these buttons, HMI will transmit ON/OFF signal to PLC. There are four types of these buttons: Set button, Reset button, Momentary and Maintained buttons. Please refer to the following Table 3.2.2 for the property description of general buttons.

Table 3.2.2 Property description of general buttons

Property Description of General Buttons			
Write Address Read Address	<p>Pressing  button next to the "Write Address" or "Read Address" can enter into the following "Input" dialog box and select the write address or the read address.</p>  <p>The link type can be Base Port or Internal Memory. If the users connecting to multi connections, the new connections will be also added into the "Link" drop-down list. After selecting the Link option and Device Type, and input correct address, then press Enter key, the corresponding numeric value will be recorded on the element that the users selected. Device types are described as follows:</p>		
\$	Internal Register (SDRAM)	RCP	Receipt register
\$M	Non-volatile Internal Register (SRAM)	RCPNO	Receipt Number Register
*\$	Indirect Address Register (SDRAM)	Other	Other device name supported by other brands PLC. Please refer to the user manual of the PLC.

Property Description of General Buttons			
<p>Edit On/Off Macro</p>	<p>Edit On and Off Macro. For the Macro function, please refer to Chapter 4 for more details.</p>		
<p>Text Text Size Font Text Color</p>	<p>The users can set the text, text size, font and text color that provided by Windows® to determine the text display on the element. When the users press  button next to “Font”, the following “Font Detail Setting” dialog box will display.</p>  <p>In “Font Detail Setting” dialog box, the users can select Font Name, Font Size and Ratio of the text and view the text format from the Preview window in advance. If the multi-language function is used, the users can see different language tabs and edit different language font setting in “Font Detail Setting” dialog box. Please refer to the example figure above.</p>		
<p>Twinkle</p>	<p>When Yes is selected, it indicates that the element will twinkle to remind the users.</p>		
<p>Picture Bank Name Picture Name</p>	<p>The users can determine the picture of the element by clicking “Picture Bank Name”. (If “Picture Bank Name” has been selected, the users can click “Picture Name” to determine the picture of the element). The following dialog box will display when the users select the existed Picture Bank Name from the drop-down list.</p>  <p>In this dialog box, the users can double click the mouse to select an element. The users can also press Shift and left key of the mouse to import several pictures into the designated element at the same time. The selected several pictures will be stored in each state of the element in order. If the number of the selected pictures is more than the number of the element state, only the pictures to the number of the element state will be imported and the remainder will be ignored and not be imported into the element.</p> <table border="1"> <tr> <td> <p>Import From File</p> </td> <td> <p>Press this button to import the pictures directly. The users do not need to exit the dialog box and click “Option” > “Picture Bank” command again.</p> </td> </tr> </table>	<p>Import From File</p>	<p>Press this button to import the pictures directly. The users do not need to exit the dialog box and click “Option” > “Picture Bank” command again.</p>
<p>Import From File</p>	<p>Press this button to import the pictures directly. The users do not need to exit the dialog box and click “Option” > “Picture Bank” command again.</p>		

Property Description of General Buttons				
Transparent Effect Transparent Color	<p>Use sucker tool  to suck the color of the picture and determine the transparent color of the picture. The effect on the element before and after this action happens is shown as the figures below.</p> <p>Please check whether the color of the selected element is 16M bits (65536) colors or not. This function is invalid and a warning message dialog box may display if the users apply this function on the 16M bits (65536) colors element (created on the screen of DOP-AE series HMI) in 256 colors editing environment (on the screen of DOP-A series HMI). If the element is converted in 256 colors after import action, we recommend the users to choose the transparent color by clicking the mouse, not using drop-down list. There are only 144 colors available in the drop-down list. The users can select the colors from the drop-down list to specify the transparent color but there may be chromatic aberration from our visual experience.</p> <p>For example, RGB(0,0,0) is black color, but RGB(1,1,1) is also black color. However, the element color is RGB(0,1,0) and it is also black color visually.</p>			
	The effect before this action happens		The effect after this action happens	
				
Foreground Color Style	Standard	Raised	Round	Invisible
				
The users can specify the button style and foreground color as the figures above by using this option.				
Function	The users can modify the element characteristic directly without re-create a new element. The elements that their characteristics can be modified directly by using this option are: Set button, Reset button, Momentary button and Maintained button these four kinds of buttons.			
Push Time (second)	Use this option to set the active time of the button. When this option is set, the button will be active after pressing the button longer than the setting time. Using this option can avoid malfunction. The range is within 0 ~ 10 seconds.			
User Security Level	Use this option to set the user priority for pressing this element. Only the priority that is higher than the current setting can use this element.			
Set Low Security	Use this option to force the current priority to be the lowest after the button is pressed. This can prevent the misoperation made by the users (operators).			
InterLock Address InterLock Level	It is similar to the Latch function. When read address is changed from Low to High (or from High to Low, this is determined by the property of "InterLock Level"), this button can be enabled.			
Before Execute Macro	When this option is set, the input macro will be enabled and executed before this button is pressed.			
After Execute Macro	When this option is set, the input macro will be enabled and executed after this button is pressed.			

Example of Button Elements:



Fig. 3.2.2 Example of Button elements

■ Multistate Buttons

Table 3.2.3 Property description of Multistate buttons

Property Description of Multistate Buttons		
The state number will be different by the unit. There are 1-256 states if its unit is WORD, 16 states if its unit is LSB and 2 states if its unit is Bit. The unit of read/write address will be different by the value unit. If the value unit is WORD or LSB, the unit of read/write address will be WORD. If the value unit is Bit, the unit of read/write address will be Bit. After obtaining the data from the read address, it will increase or decrease gradually according to the next state or previous state and write the new value to the write address. The state change of this button depends on the read address. If it is needed to add or delete the total state numbers, only add or delete the state numbers in element property table.		
Write Address Read Address	It is used to set the read and write address. The link type can be Base Port or Internal Memory. (Please refer to Table 3.2.2 Property Description of General Buttons.)	
Text / Text Size Font / Text Color	The users can set the text, text size, font and text color that provided by Windows® to determine the text display on the element. (Please refer to Table 3.2.2 Property Description of General Buttons.)	
Twinkle	When Yes is selected, it indicates that the element will twinkle to remind the users.	
Picture Bank Name Picture Name	(Please refer to Table 3.2.2 Property Description of General Buttons.)	
Transparent Effect Transparent Color	(Please refer to Table 3.2.2 Property Description of General Buttons.)	
Foreground Color Style	(Please refer to Table 3.2.2 Property Description of General Buttons.)	
Push Time (second)	Use this option to set the active time of the button. When this option is set, the button will be active after pressing the button longer than the setting time. Using this option can avoid malfunction. The range is within 0 ~ 10 seconds.	
Data Length	Bit	Multistate button can have two states.
	Word	Multistate button can have 256 states.
	LSB	Multistate button can have 16 states.
Data Format	It provides BCD, Signed Decimal, Unsigned Decimal and Hex four kinds of data format to define the read memory content.	

Property Description of Multistate Buttons	
Add/Remove State	It is used to set the state number of multistate button. There are 1-256 states can be set if its unit is WORD, 16 states can be set if its unit is LSB and 2 states can be set if its unit is Bit.
Sequence	It is used to switch the sequence of multistate state (previous state/next state).
User Security Level	Use this option to set the user priority for pressing this element. Only the priority that is higher than the current setting can use this element.
Set Low Security	Use this option to force the current priority to be the lowest after the button is pressed. This can prevent the misoperation made by the users (operators).
InterLock Address InterLock Level	It is similar to the Latch function. When read address is changed from Low to High (or from High to Low, this is determined by the property of "InterLock Level"), this button can be enabled.
Before Execute Macro	When this option is set, the input macro will be enabled and executed before this button is pressed.
After Execute Macro	When this option is set, the input macro will be enabled and executed after this button is pressed.

Example of Multistate Buttons:

When the data length is LSB (D100.0-D100.1~D100.3-D100.4):

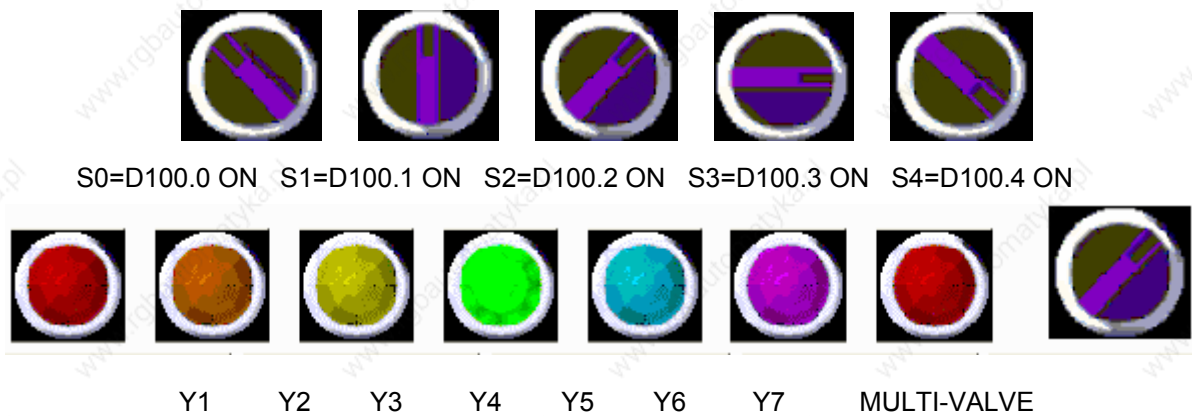


Fig. 3.2.3 Multistate buttons display

■ Set Value Button

Table 3.2.4 Property description of Set Value buttons

Property Description of Set Value Buttons	
After pressing this button on the screen, a system built-in numeric keypad (TEN-KEY) will show up and the users can use it to input the setting value directly. When pressing ENTER key, HMI will send the input setting value to PLC corresponding register. The maximum and minimum input setting values are all user-defined. The users can also specify the trigger mode to trigger the designated PLC address before or after writing the setting value.	
Write Address	It is used to set the write address. The link type can be Base Port or Internal Memory. (Please refer to Table 3.2.2 Property Description of General Buttons.)
Text / Text Size Font / Text Color	The users can set the text, text size, font and text color that provided by Windows® to determine the text display on the element. (Please refer to Table 3.2.2 Property Description of General Buttons.)

Property Description of Set Value Buttons																		
Picture Bank Name Picture Name	(Please refer to Table 3.2.2 Property Description of General Buttons.)																	
Transparent Effect Transparent Color	(Please refer to Table 3.2.2 Property Description of General Buttons.)																	
Foreground Color Style	(Please refer to Table 3.2.2 Property Description of General Buttons.)																	
Trigger Trigger Mode	The users can use this setting to trigger the designated PLC address to be ON before or after writing the setting value. Note: this function can only trigger PLC address to be ON. If the PLC address needs to be triggered again, the users should set the address to be OFF by themselves.																	
Detail Range Setup																		
	Data Length	There are 16bits Word and 32bits Double Word two options.																
	Data Format	It provides different kinds of data format for different data length:																
		<table border="1"> <thead> <tr> <th>Word</th> <th>Double Word</th> </tr> </thead> <tbody> <tr> <td>1. BCD</td> <td>1. BCD</td> </tr> <tr> <td>2. Signed BCD</td> <td>2. Signed BCD</td> </tr> <tr> <td>3. Signed Decimal</td> <td>3. Signed Decimal</td> </tr> <tr> <td>4. Unsigned Decimal</td> <td>4. Unsigned Decimal</td> </tr> <tr> <td>5. Hex</td> <td>5. Hex</td> </tr> <tr> <td>6. Binary</td> <td>6. Binary</td> </tr> <tr> <td></td> <td>7. Floating</td> </tr> </tbody> </table>	Word	Double Word	1. BCD	1. BCD	2. Signed BCD	2. Signed BCD	3. Signed Decimal	3. Signed Decimal	4. Unsigned Decimal	4. Unsigned Decimal	5. Hex	5. Hex	6. Binary	6. Binary		7. Floating
	Word	Double Word																
	1. BCD	1. BCD																
	2. Signed BCD	2. Signed BCD																
	3. Signed Decimal	3. Signed Decimal																
4. Unsigned Decimal	4. Unsigned Decimal																	
5. Hex	5. Hex																	
6. Binary	6. Binary																	
	7. Floating																	
Minimum	The users can set the minimum and maximum of input setting value to determine the range of input setting value.																	
Maximum																		
Integral Digits	Use this option to determine the digit number of integer and decimal fraction. The digit number is not a real digit number value. It is only the display format. The digit number will be a real decimal number only when the data format is selected as "Floating".																	
Fractional																		
	When the users have input the minimum and maximum value, after pressing OK button, HMI will examine the value by referring to the selected data length, data format, integral and fractional digits.																	
User Security Level	Use this option to set the user priority for pressing this element. Only the priority that is higher than the current setting can use this element.																	
Set Low Security	Use this option to force the current priority to be the lowest after the button is pressed. This can prevent the misoperation made by the users (operators).																	
InterLock Address InterLock Level	It is similar to the Latch function. When read address is changed from Low to High (or from High to Low, this is determined by the property of "InterLock Level"), this button can be enabled.																	

Property Description of Set Value Buttons	
Before Execute Macro	When this option is set, the input macro will be enabled and executed before this button is pressed.
After Execute Macro	When this option is set, the input macro will be enabled and executed after this button is pressed.

Example of Set Value Button:

Press Set Value button and the Numeric keypad (TEN-KEY) dialog box will display on the screen. The users can input a value and write it into the PLC corresponding register M100.

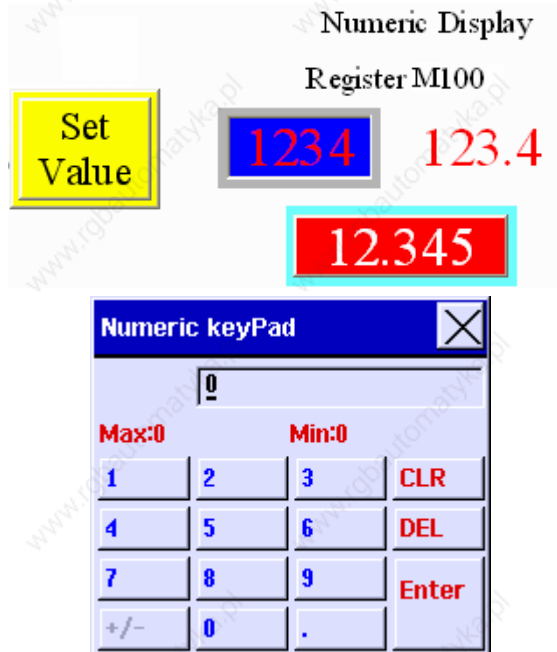
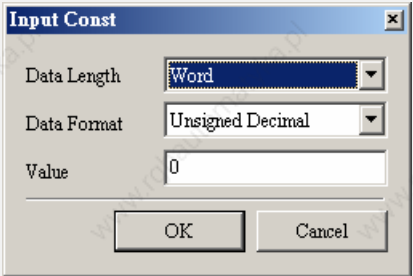


Fig. 3.2.4 Numeric keypad (TEN-KEY) dialog box

■ Set Constant Button

Table 3.2.5 Property description of Set Constant buttons

Property Description of Set Constant Buttons	
After pressing this button on the screen, HMI will send the specified constant value to PLC corresponding register. It has the same function as Set Value button. The users can also specify the trigger mode to trigger the designated PLC address before or after writing the setting value.	
Write Address	It is used to set the write address. The link type can be Base Port or Internal Memory. (Please refer to Table 3.2.2 Property Description of General Buttons.)
Text / Text Size Font / Text Color	The users can set the text, text size, font and text color that provided by Windows® to determine the text display on the element. (Please refer to Table 3.2.2 Property Description of General Buttons.)
Picture Bank Name Picture Name	(Please refer to Table 3.2.2 Property Description of General Buttons.)
Transparent Effect Transparent Color	(Please refer to Table 3.2.2 Property Description of General Buttons.)
Foreground Color Style	(Please refer to Table 3.2.2 Property Description of General Buttons.)

Property Description of Set Constant Buttons		
Trigger Trigger Mode	The users can use this setting to trigger the designated PLC address to be ON before or after writing the setting value. Note: this function can only trigger PLC address to be ON. If the PLC address needs to be triggered again, the users should set the address to be OFF by themselves.	
Detail Range Setup		
	Data Length	There are 16bits Word and 32bits Double Word two options.
	Data Format	There are following data format provided: Word/Double Word 1. BCD 2. Signed BCD 3. Signed Decimal 4. Unsigned Decimal 5. Hex
	Value	It is used to enter the constant value that the users want to write. After pressing OK button, HMI will examine the value by referring to the selected data length and data format.
User Security Level	Use this option to set the user priority for pressing this element. Only the priority that is higher than the current setting can use this element.	
Set Low Security	Use this option to force the current priority to be the lowest after the button is pressed. This can prevent the misoperation made by the users (operators).	
InterLock Address InterLock Level	It is similar to the Latch function. When read address is changed from Low to High (or from High to Low, this is determined by the property of "InterLock Level"), this button can be enabled.	
Before Execute Macro	When this option is set, the input macro will be enabled and executed before this button is pressed.	
After Execute Macro	When this option is set, the input macro will be enabled and executed after this button is pressed.	

Example of Set Constant buttons:

After pressing the Set Constant button, HMI will transmit the constant value to PLC corresponding register D1000.

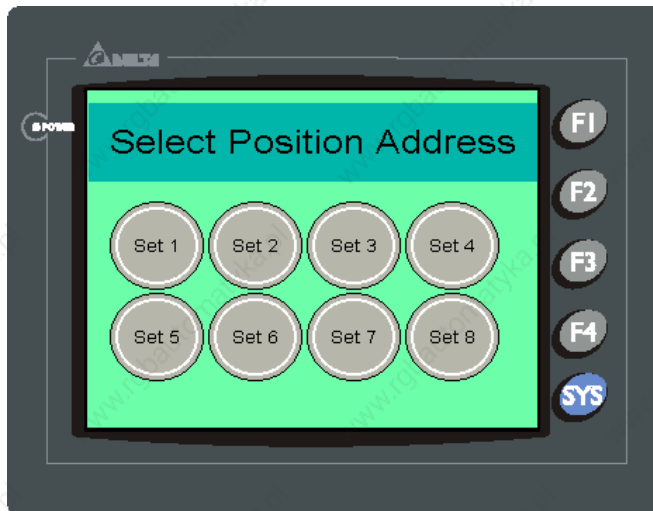
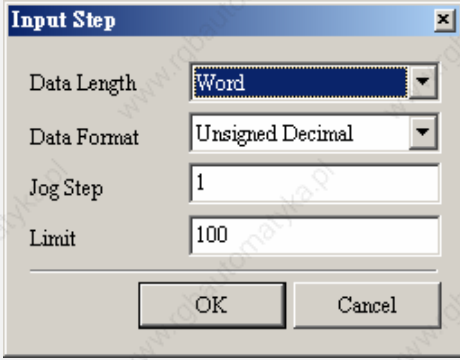


Fig. 3.2.5 Example of Set Constant buttons

■ Increment / Decrement

Table 3.2.6 Property description of Increment / Decrement buttons

Property Description of Increment / Decrement Buttons	
After pressing this button on the screen, HMI will read the value from PLC and add or subtract the set constant value. Then, write the result into PLC corresponding register. If the addition or subtraction result exceeds the limit (minimum and maximum) set in HMI, HMI will save the limit value (minimum and maximum) into the PLC corresponding address.	
Write Address Read Address	It is used to set the read and write address. The link type can be Base Port or Internal Memory. (Please refer to Table 3.2.2 Property Description of General Buttons.)
Text / Text Size Font / Text Color	The users can set the text, text size, font and text color that provided by Windows® to determine the text display on the element. (Please refer to Table 3.2.2 Property Description of General Buttons.)
Picture Bank Name Picture Name	(Please refer to Table 3.2.2 Property Description of General Buttons.)
Transparent Effect Transparent Color	(Please refer to Table 3.2.2 Property Description of General Buttons.)
Foreground Color Style	(Please refer to Table 3.2.2 Property Description of General Buttons.)
Function	The users can modify the element characteristic directly without re-create a new element. The elements that their characteristics can be modified directly by using this option are: Increment button and Decrement button.
Trigger Trigger Mode	The users can use this setting to trigger the designated PLC address to be ON before or after writing the setting value. Note: this function can only trigger PLC address to be ON. If the PLC address needs to be triggered again, the users should set the address to be OFF by themselves.

Property Description of Increment / Decrement Buttons	
Detail Range Setup	
Data Length	There are 16bits Word and 32bits Double Word two options.
Data Format	There are following data format provided: Word/Double Word 1. BCD 2. Signed BCD 3. Signed Decimal 4. Unsigned Decimal 5. Hex
Jog Step	It is used to set the increasing and decreasing value when pressing the Increment and Decrement button every time.
Limit	It is used to set the limit of the increment and decrement value. After pressing OK button, HMI will examine the input increment & decrement value and limit value also by referring to the selected data length and data format.
User Security Level	Use this option to set the user priority for pressing this element. Only the priority that is higher than the current setting can use this element.
Set Low Security	Use this option to force the current priority to be the lowest after the button is pressed. This can prevent the misoperation made by the users (operators).
InterLock Address InterLock Level	It is similar to the Latch function. When read address is changed from Low to High (or from High to Low, this is determined by the property of "InterLock Level"), this button can be enabled.
Before Execute Macro	When this option is set, the input macro will be enabled and executed before this button is pressed.
After Execute Macro	When this option is set, the input macro will be enabled and executed after this button is pressed.

Example of Increment / Decrement Buttons:

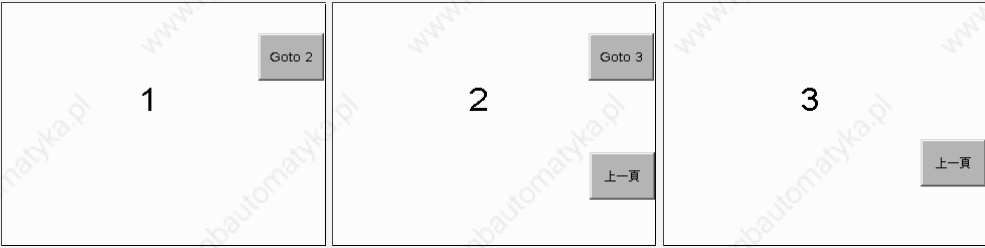
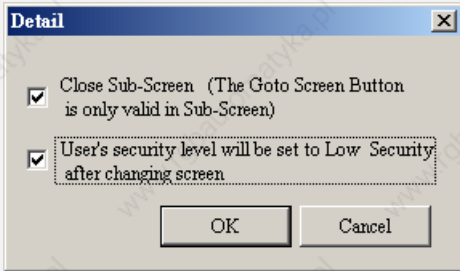
Adjust D1000 value by pressing buttons +/-.

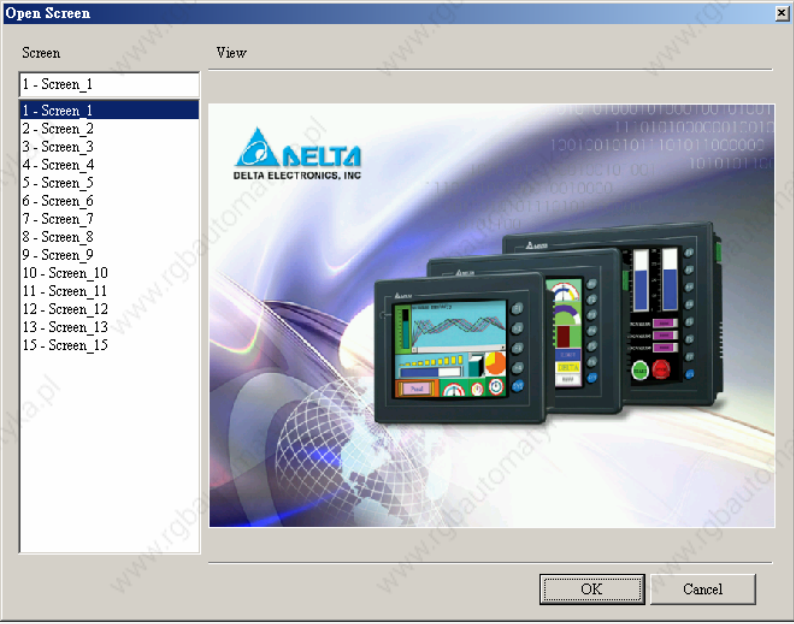


Fig. 3.2.6 Example of Increment / Decrement buttons

■ Goto Screen / Previous Page (Previous View) Buttons

Table 3.2.7 Property description of Goto Screen / Previous Page (Previous View) buttons

Property Description of Goto Screen / Previous Page (Previous View) Buttons	
<p>There are three kinds of selection for switching screens:</p> <ol style="list-style-type: none"> 1. Goto screen: press this button on the screen and HMI can go to a specific screen. 2. Previous page: press this button on the screen and HMI can switch to the previous screen. 3. Previous view: press this button on the screen and HMI can switch to previous view, just like Back command in Windows® Explorer Browse. 	
	
<p>The above example screens describe the operation of previous page button. In screen 1, if press “Goto 2” button, HMI will switch to the screen 2. If press “Goto 3” button on screen 2, HMI will switch to screen 3. Then, if press previous page button on screen 3, HMI will return to screen 2. If press previous page button on screen 2, HMI will switch to screen. (Note: however, if the function of the button created on screen 2 is “previous view”, not “previous page”, when press “previous view” button on screen 2, HMI will switch to screen 3, not screen 1 and this is just the difference between “Previous page” and “Previous view”.)</p>	
Text / Text Size Font / Text Color	The users can set the text, text size, font and text color that provided by Windows® to determine the text display on the element. (Please refer to Table 3.2.2 Property Description of General Buttons.)
Picture Bank Name Picture Name	(Please refer to Table 3.2.2 Property Description of General Buttons.)
Transparent Effect Transparent Color	(Please refer to Table 3.2.2 Property Description of General Buttons.)
Foreground Color Style	(Please refer to Table 3.2.2 Property Description of General Buttons.)
Function	The users can modify the element characteristic directly without re-create a new element. The elements that their characteristics can be modified directly by using this option are: Goto button, Previous page and Previous view buttons.
Trigger Trigger Mode	The users can use this setting to trigger the designated PLC address to be ON before or after writing the setting value. Note: this function can only trigger PLC address to be ON. If the PLC address needs to be triggered again, the users should set the address to be OFF by themselves.
Detail	<p>This dialog box will pop up only when the button function is “Goto screen”.</p> 
Close Sub-Screen	When this option is selected, it indicates that this Goto screen button is only valid in Sub-Screen. When pressing this button, the current (active) sub screen will be closed.

Property Description of Goto Screen / Previous Page (Previous View) Buttons	
	<p>User's security level will be set to Low Security after changing screen.</p> <p>When this option is selected, it will force the current user's priority to be the lowest after the button is pressed. This can prevent the misoperation made by the users (operators).</p>
User Security Level	Use this option to set the user priority for pressing this element. Only the priority that is higher than the current setting can use this element.
Goto Screen	<p>When clicking this option, the following dialog box will pop up:</p>  <p>In this "Open Screen" dialog box, the users can select the desired screen from left side and the preview screen will display on the right side. After selecting the screen and pressing OK button, HMI will record the designated screen to this Goto button element.</p>
InterLock Address InterLock Level	It is similar to the Latch function. When read address is changed from Low to High (or from High to Low, this is determined by the property of "InterLock Level"), this button can be enabled.
Before Execute Macro	When this option is set, the input macro will be enabled and executed before this button is pressed.
After Execute Macro	When this option is set, the input macro will be enabled and executed after this button is pressed.

Example of Goto Screen buttons:

Use different screen buttons to switch to the designated screen

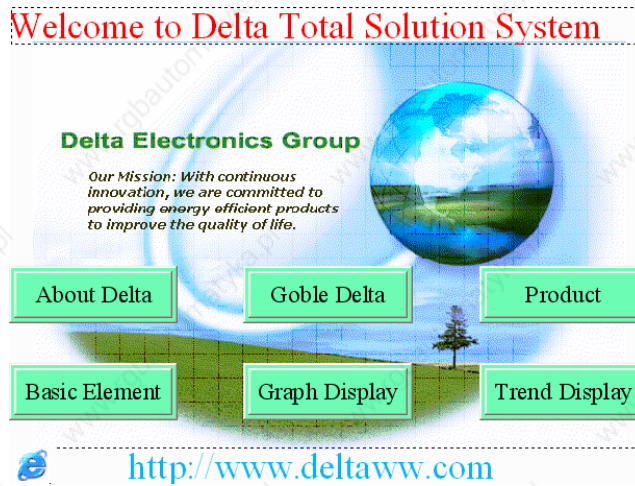


Fig. 3.2.7 Example of Goto Screen buttons

■ **System Function Button**




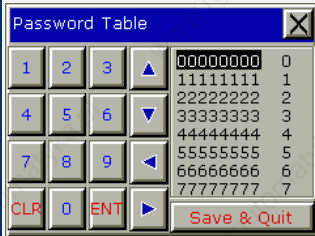
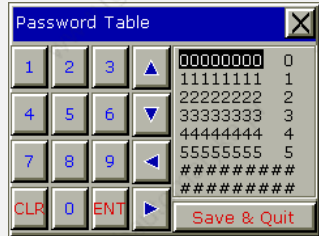

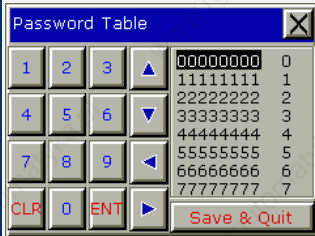
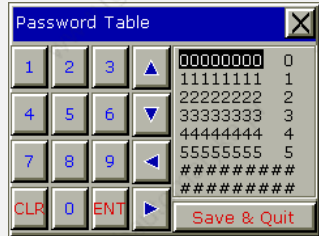

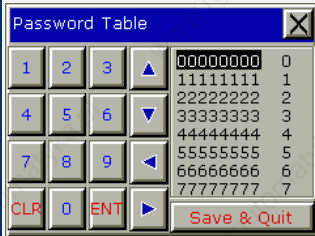
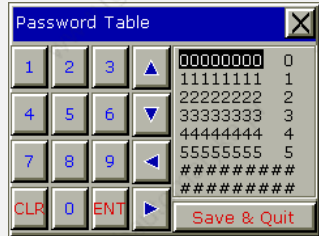
Fig. 3.2.5 System function button options


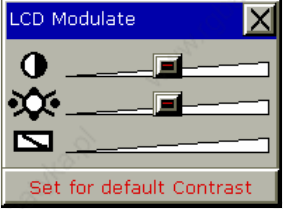
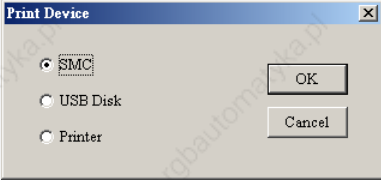
Table 3.2.8 System function buttons

Button Type	Macro	Read	Write	Function
System Date Time	No	No	No	It is used to set HMI system time and date (year-month-day, hours:minutes:seconds)
Password Table Setup	No	No	No	It is used to set all password priority.
Enter Password	No	No	No	HMI provides passwords function.
Contrast Brightness	No	No	No	It is used to adjust HMI contrast and brightness.
Low Security	No	No	No	After pressing this button, HMI will set the password to the lowest level (Level is 0).
System Menu	No	No	No	After pressing this button, HMI will change screen to system menu.
Report List	No	No	No	After pressing this button, HMI will output the screen data to the specific device. It is usually used with print function.

For the property description of system function buttons, please refer to the following Table 3.2.9:

Table 3.2.9 System function buttons

Property Description of System Function Buttons					
Text / Text Size Font / Text Color	The users can set the text, text size, font and text color that provided by Windows® to determine the text display on the element. (Please refer to Table 3.2.2 Property Description of General Buttons.)				
Picture Bank Name Picture Name	(Please refer to Table 3.2.2 Property Description of General Buttons.)				
Transparent Effect Transparent Color	(Please refer to Table 3.2.2 Property Description of General Buttons.)				
Foreground Color Style	(Please refer to Table 3.2.2 Property Description of General Buttons.)				
Function	<p>The users can modify the element characteristic directly without re-create a new element. The elements that their characteristics can be modified directly by using this option are the following items:</p> <table border="1"> <tr> <td>System Date & Time</td> <td> <p>Use this option to set the system date and time of HMI. The users only need to press SYS button on HMI panel to enter HMI system setting screen and edit the date & time as the figure below.</p>  </td> </tr> <tr> <td>Password Table Setup</td> <td> <p>After selecting this option, determine the open level according to the User Security Level in property table. After downloading screen data to HMI, if the user security level is lower than the setting level, this "Password Table" will not be opened and only the "Password Keypad" dialog box will display. Password Table can be opened or not depends on whether the user security is higher than the setting level or not. Even though the users can open Password Table, it only indicates that the users can change the password that level is lower than the users'. The users still cannot change or view those passwords that are higher than the users'.</p> <div style="display: flex; justify-content: space-around;"> <div style="text-align: center;">  <p>Maximum Priority</p> </div> <div style="text-align: center;">  <p>Password 5 Levels</p> </div> </div> </td> </tr> </table>	System Date & Time	<p>Use this option to set the system date and time of HMI. The users only need to press SYS button on HMI panel to enter HMI system setting screen and edit the date & time as the figure below.</p> 	Password Table Setup	<p>After selecting this option, determine the open level according to the User Security Level in property table. After downloading screen data to HMI, if the user security level is lower than the setting level, this "Password Table" will not be opened and only the "Password Keypad" dialog box will display. Password Table can be opened or not depends on whether the user security is higher than the setting level or not. Even though the users can open Password Table, it only indicates that the users can change the password that level is lower than the users'. The users still cannot change or view those passwords that are higher than the users'.</p> <div style="display: flex; justify-content: space-around;"> <div style="text-align: center;">  <p>Maximum Priority</p> </div> <div style="text-align: center;">  <p>Password 5 Levels</p> </div> </div>
System Date & Time	<p>Use this option to set the system date and time of HMI. The users only need to press SYS button on HMI panel to enter HMI system setting screen and edit the date & time as the figure below.</p> 				
Password Table Setup	<p>After selecting this option, determine the open level according to the User Security Level in property table. After downloading screen data to HMI, if the user security level is lower than the setting level, this "Password Table" will not be opened and only the "Password Keypad" dialog box will display. Password Table can be opened or not depends on whether the user security is higher than the setting level or not. Even though the users can open Password Table, it only indicates that the users can change the password that level is lower than the users'. The users still cannot change or view those passwords that are higher than the users'.</p> <div style="display: flex; justify-content: space-around;"> <div style="text-align: center;">  <p>Maximum Priority</p> </div> <div style="text-align: center;">  <p>Password 5 Levels</p> </div> </div>				

Property Description of System Function Buttons					
Enter Password	<p>This button provides HMI a password input interface. It will open the corresponding priority by the input password. The higher level the users input, the higher priority the users have.</p> 				
Contrast Brightness	<p>This button provides the users to adjust HMI LCD contrast and brightness settings. After pressing this button, the users will get the following pop-up window to adjust HMI LCD contrast and brightness settings. If the users press "Set for default Contrast" button, it will set HMI LCD to the default settings.</p> 				
Low Security	<p>Using this button can set the user priority to the lowest (Level 0). This option makes the user priority level become the lowest to protect control system parameter not to be modified when the users exit the different screens. It can also avoid the misoperation that may cause system error. (This function is also provided for Goto screen button.)</p>				
System Menu	<p>After pressing this button, HMI will be back to system menu screen. The users can return to operation screen just by activating "Run" function or startup HMI again.</p>				
Report List	<p>This button has many functions. It can be used flexibly depending on the properties of the "Report List" option (Please refer to page 2-124 in Chapter 2 and the following description of Report Device).</p>				
Trigger Trigger Mode	<p>The users can use this setting to trigger the designated PLC address to be ON before or after writing the setting value. Note: this function can only trigger PLC address to be ON. If the PLC address needs to be triggered again, the users should set the address to be OFF by themselves.</p>				
Report Device	<p>This option is provided in Report List button only. When the users select a Report List button, the users can set this option in the property table.</p>  <p>The Report Device window is shown as the figure above. The Report Device can be SMC, USB Disk, and Printer. Please note that USB Disk and Printer are provided in DOP-AE series HMI only.</p> <table border="1"> <tr> <td>SMC</td> <td>Output the history records and alarm data to SMC card.</td> </tr> <tr> <td>USB Disk</td> <td>Output the history records and alarm data to USB Disk.</td> </tr> </table>	SMC	Output the history records and alarm data to SMC card.	USB Disk	Output the history records and alarm data to USB Disk.
SMC	Output the history records and alarm data to SMC card.				
USB Disk	Output the history records and alarm data to USB Disk.				

Property Description of System Function Buttons		
	Printer	HMI will check if Print Typesetting function is set or not first. If Print Typesetting function is set already, the screen data will be output to the printer directly. If HMI detects the Print Typesetting function is not set yet, the Hard Copy function will be enabled.
User Security Level		Use this option to set the user priority for pressing this element. Only the priority that is higher than the current setting can use this element.
InterLock Address InterLock Level		It is similar to the Latch function. When read address is changed from Low to High (or from High to Low, this is determined by the property of "InterLock Level"), this button can be enabled.
Before Execute Macro		When this option is set, the input macro will be enabled and executed before this button is pressed.
After Execute Macro		When this option is set, the input macro will be enabled and executed after this button is pressed.

Example of System Function Buttons:

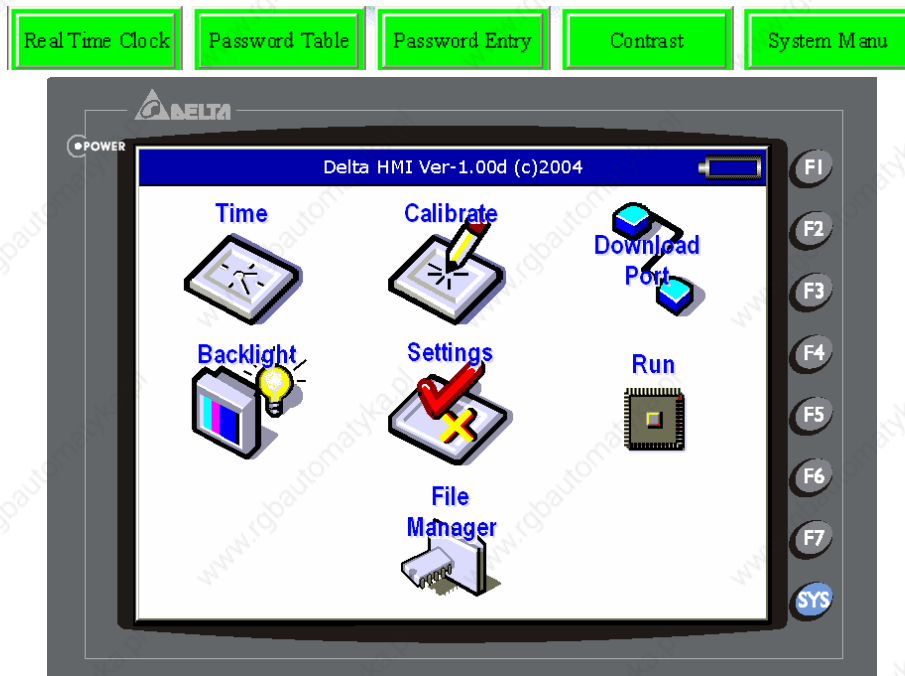


Fig. 3.2.8 HMI System Menu Screens

3.3 Meter Element

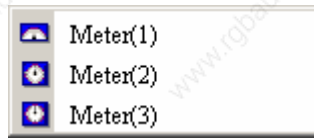
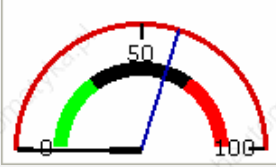
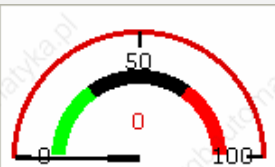


Fig. 3.3.1 Meter element options

Table 3.3.1 Property Description of Meter Element

Property Description of Meter Element							
<p>The users can set meter appearance in the property table, such as the style, the color (including border color, background color, stitch color, scale color) and the scale region number, etc. Also, the max. & min. value and high & low limit can be defined in Detail Setup dialog box. It can be used to calculate the specified address and measure if it exceeds the limit or not. The users can also use various colors to show clearly and this is convenience for the users to recognize.</p>							
Read Address	It is used to set the read address. The link type can be Base Port or Internal Memory. (Please refer to Table 3.2.2 Property Description of General Buttons.)						
Text / Text Size Font / Text Color	The users can set the text, text size, font and text color that provided by Windows® to determine the text display on the element. (Please refer to Table 3.2.2 Property Description of General Buttons.)						
Border Color	It is used to set the border color of meter element.						
Background Color	It is used to set the background color of meter element.						
Style	<table border="1" style="width: 100%; border-collapse: collapse;"> <tr> <th style="width: 33%;">Standard</th> <th style="width: 33%;">Raised</th> <th style="width: 33%;">Sunken</th> </tr> <tr> <td style="text-align: center;"></td> <td style="text-align: center;"></td> <td style="text-align: center;"></td> </tr> </table>	Standard	Raised	Sunken			
	Standard	Raised	Sunken				
Detail Setup							
	Data Length	There are 16bits Word and 32bits Double Word two options.					
	Data Format	There are following data format provided:					
		<p>Word/Double Word</p> <ol style="list-style-type: none"> 1. BCD 2. Signed BCD 3. Signed Decimal 4. Unsigned Decimal 					
Minimum Value	It is used to set the display minimum and maximum value.						
Maximum Value							

Property Description of Meter Element		
Target Value Color		The users can decide if the target value display or not by using this option. If this option is set, the target value and its color set by the users will display just like the figure shown below: (Here we set the target value is 60 and its color is in blue.) 
Ranges (Enable range setting)		Please refer to the description of Low & High Region Color.
Variable target/range limits		When the target value and low & high limit is a variable value, the low limit address is <u>Read Address+1</u> , the high limit address is <u>Read Address+2</u> and the address of target value is <u>Read Address+3</u> .
Integral Digits		Use this option to determine the digit number of integer and decimal fraction. The digit number is not a real digit number value. It is only the display format.
Fractional Digits		
When the users have input the target value, minimum and maximum value, after pressing OK button, HMI will examine the value by referring to the selected data length, data format, integral and fractional digits.		
Low Region Color High Region Color		This option is available and displayed in the property table only when the “Ranges” option in the Detail Setup dialog box is selected. If the users set the low limit value is 30 and the color of low limit region is in green, and then set the high limit value is 70 and the color of high limit region is in red, the meter element will be shown as the figure below: 
Stitch Color		It is used to set the stitch color of the meter element.
Scale Color		It is used to set the scale color of the meter element.
Scale Region Number		It is used to set the scale region number of the meter element. The users can use the up or down buttons to increase or decrease the scale region number. The setting rang is within 1 ~ 10.

Example of Meter Element:

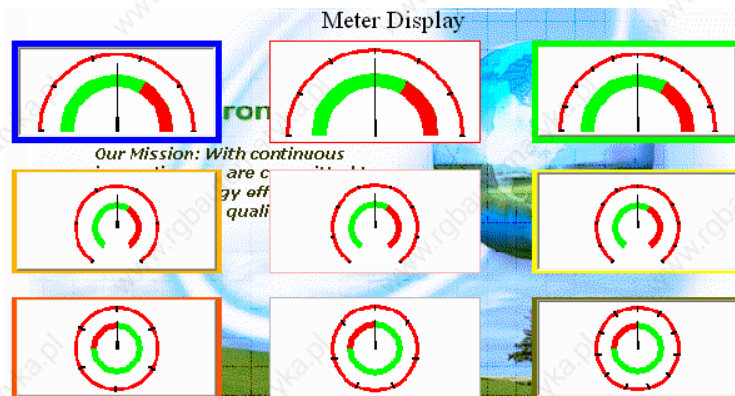


Fig. 3.2.9 Example of Meter element

3.4 Bar Element

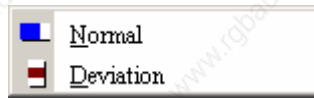






Fig. 3.4.1 Bar element options

Table 3.4.1 Property Description of Bar Element

Property Description of Normal Bar Element		
HMI reads the value of the corresponding PLC specific address (register) and converts the value to normal bar element and then displays it on the screen.		
Read Address	It is used to set the read address. The link type can be Base Port or Internal Memory. (Please refer to Table 3.2.2 Property Description of General Buttons.)	
Text / Text Size Font / Text Color	The users can set the text, text size, font and text color that provided by Windows® to determine the text display on the element. (Please refer to Table 3.2.2 Property Description of General Buttons.)	
Border Color	It is used to set the border color of the normal bar element.	
Foreground Color Background Color	It is used to set the foreground and background color of the normal bar element. For example, the foreground color of the following example bar element is green and its background color is yellow. 	
Style	Standard	
	  	
Display Format	Left	The display progressing direction is from right to the left.
	Right	The display progressing direction is from left to the right.
	Top	The display progressing direction is from bottom to the top.
	Botom	The display progressing direction is from top to the bottom.

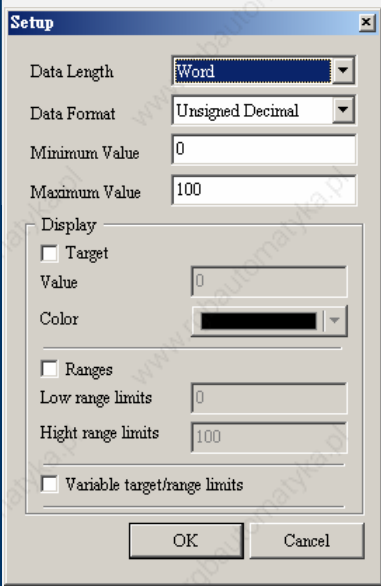






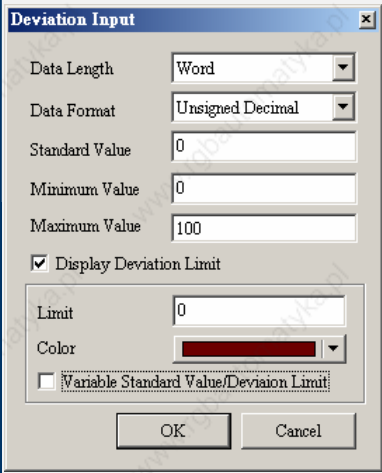




Property Description of Normal Bar Element										
Detail		<table border="1" style="width: 100%;"> <tr> <td>Data Length</td> <td>There are 16bits Word and 32bits Double Word two options.</td> </tr> <tr> <td>Data Format</td> <td>There are following data format provided:</td> </tr> <tr> <td></td> <td>Word/Double Word</td> </tr> <tr> <td></td> <td> <ol style="list-style-type: none"> 1. BCD 2. Signed BCD 3. Signed Decimal 4. Unsigned Decimal 5. Hex </td> </tr> </table>	Data Length	There are 16bits Word and 32bits Double Word two options.	Data Format	There are following data format provided:		Word/Double Word		<ol style="list-style-type: none"> 1. BCD 2. Signed BCD 3. Signed Decimal 4. Unsigned Decimal 5. Hex
	Data Length	There are 16bits Word and 32bits Double Word two options.								
	Data Format	There are following data format provided:								
		Word/Double Word								
		<ol style="list-style-type: none"> 1. BCD 2. Signed BCD 3. Signed Decimal 4. Unsigned Decimal 5. Hex 								
	Minimum Value	It is used to set the display minimum and maximum value.								
	Maximum Value									
Target Value Color	<p>The users can decide if the target value display or not by using this option. If this option is set, the target value and its color set by the users will display on the screen. HMI will refer to the minimum and maximum value and draw the proper reference line on the bar element just like the figure shown below: (Here we set the target value is 50 and its color is in red. The maximum and minimum value is 100 and 0 respectively.)</p> 									
Ranges (Enable range setting)	Please refer to the description of Low & High Region Color.									
Variable target/range limits	When the target value and low & high limit is a variable value, the low limit address is <u>Read Address+1</u> , the high limit address is <u>Read Address+2</u> and the address of target value is <u>Read Address+3</u> .									
When the users have input the target value, low & high limit, and minimum & maximum value, after pressing OK button, HMI will examine the value by referring to the selected data length and data format.										
Low Region Color High Region Color	<p>This option is available and displayed in the property table only when the “Ranges” option in the Detail dialog box is selected. If the users set the low limit value is 30 and the color of low limit region is in green, and then set the high limit value is 70 and the color of high limit region is in red, the bar element will be shown as the figures below (The min. & max. input value is 0 and 100 respectively.):</p> <div style="display: flex; justify-content: space-around; align-items: flex-end;"> <div style="text-align: center;">  <p>When the value is 20</p> </div> <div style="text-align: center;">  <p>When the value is 50</p> </div> <div style="text-align: center;">  <p>When the value is 80</p> </div> </div>									

Table 3.4.1 Property Description of Bar Element

Property Description of Deviation Bar Element			
HMI reads the value of the corresponding PLC specific address (register). Subtract the setting standard value from this read value and the users have a deviation value. Then, the users can convert the deviation value to deviation bar element and then display it on the screen.			
Read Address	It is used to set the read address. The link type can be Base Port or Internal Memory. (Please refer to Table 3.2.2 Property Description of General Buttons.)		
Text / Text Size Font / Text Color	The users can set the text, text size, font and text color that provided by Windows® to determine the text display on the element. (Please refer to Table 3.2.2 Property Description of General Buttons.)		
Border Color	It is used to set the border color of the deviation bar element.		
Foreground Color Background Color	It is used to set the foreground and background color of the deviation bar element. For example, the foreground color of the following example bar element is green and its background color is yellow. 		
Style	Standard		
	Raised		
	Sunken		
			
Display Format	Horizontal	The deviation value display horizontally.	
	Vertical	The deviation value display vertically.	
Detail		Data Length	There are 16bits Word and 32bits Double Word two options.
		Data Format	There are following data format provided: Word/Double Word 1. BCD 2. Signed BCD 3. Signed Decimal 4. Unsigned Decimal 5. Hex
	Standard Value	It is used to set the standard value for calculating deviation value.	
	Minimum Value	The minimum and maximum value in the deviation bar element.	
	Maximum Value		
	Display Deviation Limit	The deviation limit and color can be set only when this option is selected. Also, the deviation value will display in the designated color set by the users. If this option is not selected, the deviation value will be displayed in the foreground color directly on the screen.	
	Variable Standard Value/Deviation Limit	When standard value and high limit of deviation value is variable. The address of standard value is <u>Read Address+1</u> and the address of deviation limit value is <u>Read Address+2</u> .	

Property Description of Deviation Bar Element	
	<p>When the users have input the standard value, minimum & maximum value and deviation limit, after pressing OK button, HMI will examine the value by referring to the selected data length and data format.</p>
	<p>For example, if the data length is set to Word, the data format is set to Unsigned Decimal, standard value is set to 50, minimum value is set to 0, maximum value is set to 100 and deviation limit is set to 20, the deviation bar element will be shown as the figures below:</p> <div style="display: flex; justify-content: space-around; align-items: flex-start;"> <div style="text-align: center;">  <p>When the value is 10</p> </div> <div style="text-align: center;">  <p>When the value is 20</p> </div> </div> <div style="display: flex; justify-content: space-around; align-items: flex-start;"> <div style="text-align: center;">  <p>When the value is 70</p> </div> <div style="text-align: center;">  <p>When the value is 90</p> </div> </div>

Example of Deviation Bar Element:

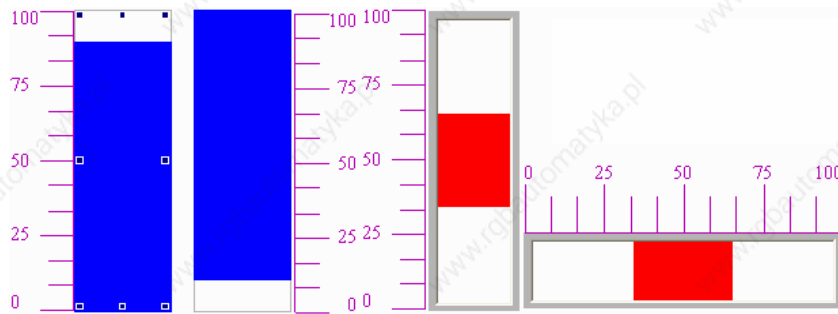


Fig. 3.4.2 Example of Deviation bar element

Read: D1000, use the deviation bar element to display the value of PLC corresponding register=Dn

3.5 Pipe Element

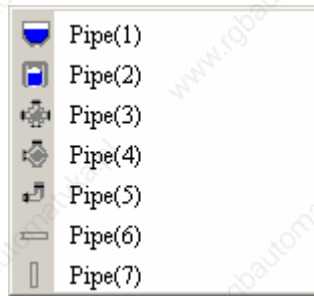


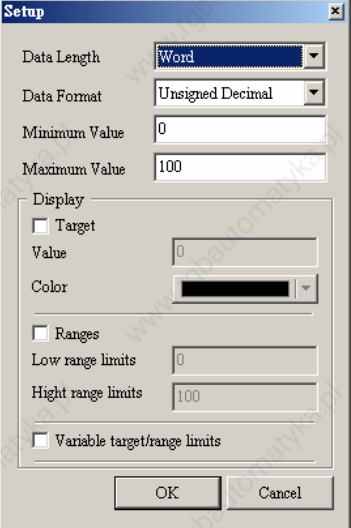



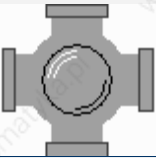





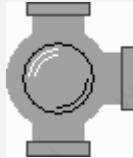

Fig. 3.5.1 Pipe element options



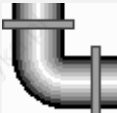
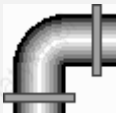
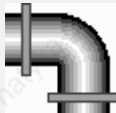
Table 3.5.1 Property Description of Pipe Element

Property Description of Pipe (1) / Pipe (2) Element									
HMI reads the value of the corresponding PLC specific address (register). Then, convert the value to Pipe (1) / Pipe (2) element and then display it on the screen.									
Read Address	It is used to set the read address. The link type can be Base Port or Internal Memory. (Please refer to Table 3.2.2 Property Description of General Buttons.)								
Text / Text Size Font / Text Color	The users can set the text, text size, font and text color that provided by Windows® to determine the text display on the element. (Please refer to Table 3.2.2 Property Description of General Buttons.)								
WaterMark Color Inside Tube Color	<p>It is used to set the watermark color and inside tube color of Pipe (1) and Pipe (2) element.</p> <div style="display: flex; justify-content: space-around;"> <div style="text-align: center;"> <p>Pipe (1) Element</p>  <p>The watermark color is in blue. The inside tube color is in black.</p> </div> <div style="text-align: center;"> <p>Pipe (2) Element</p>  <p>The watermark color is in red. The inside tube color is in white.</p> </div> </div>								
Style	Standard								
	Rotation 180								
Detail Setup	<div style="display: flex; justify-content: space-between;"> <div style="width: 45%;">  </div> <div style="width: 50%;"> <table border="1"> <tr> <td>Data Length</td> <td>There are 16bits Word and 32bits Double Word two options.</td> </tr> <tr> <td>Data Format</td> <td>There are following data format provided:</td> </tr> <tr> <td></td> <td>Word/Double Word</td> </tr> <tr> <td></td> <td> <ol style="list-style-type: none"> 1. BCD 2. Signed BCD 3. Signed Decimal 4. Unsigned Decimal 5. Hex </td> </tr> </table> </div> </div>	Data Length	There are 16bits Word and 32bits Double Word two options.	Data Format	There are following data format provided:		Word/Double Word		<ol style="list-style-type: none"> 1. BCD 2. Signed BCD 3. Signed Decimal 4. Unsigned Decimal 5. Hex
	Data Length	There are 16bits Word and 32bits Double Word two options.							
	Data Format	There are following data format provided:							
	Word/Double Word								
	<ol style="list-style-type: none"> 1. BCD 2. Signed BCD 3. Signed Decimal 4. Unsigned Decimal 5. Hex 								

Property Description of Pipe (1) / Pipe (2) Element		
	Minimum Value	It is used to set the minimum and maximum capacity of the pipe element.
	Maximum Value	
	Target Value Color	The users can decide if the target value display or not by using this option.
	Ranges (Enable range setting)	Please refer to the description of Low & High Region Color.
	Variable target/range limits	When the target value and low & high limit is a variable value, the low limit address is <u>Read Address+1</u> , the high limit address is <u>Read Address+2</u> and the address of target value is <u>Read Address+3</u> .
		When the users have input the target value, low & high limit, and minimum & maximum value, after pressing OK button, HMI will examine the value by referring to the selected data length and data format.
Low Region Color High Region Color		<p>This option is available and displayed in the property table only when the "Ranges" option in the Detail Setup dialog box is selected. If the users set the low limit value is 30 and the color of low limit region is in green, and then set the high limit value is 70 and the color of high limit region is in red, the pipe element will be shown as the figures below (The min. & max. input value is 0 and 100 respectively.):</p> <div style="display: flex; justify-content: space-around; align-items: center;"> <div style="text-align: center;">  <p>When the value is 20</p> </div> <div style="text-align: center;">  <p>When the value is 50</p> </div> <div style="text-align: center;">  <p>When the value is 80</p> </div> </div>

Property Description of Pipe (3) Element	
It is used to connect to several pipes. Pipe (3) element is shown as the figure below:	
	
Pipe Gauge	Use this option to set the pipe gauge. The selectable range is from 1 ~ 5. The setting value 1 represents at least 13 pixels and the setting value 2 represents at least 26 pixels and vise versa.

Property Description of Pipe (4) Element				
It is used to connect to several pipes. Pipe (4) element is shown as the figure below:				
				
Style	Standard	Rotation 90	Rotation 180	Rotation 270
				
Pipe Gauge	Use this option to set the pipe gauge. The selectable range is from 1 ~ 5. The setting value 1 represents at least 13 pixels and the setting value 2 represents at least 26 pixels and vice versa.			

Property Description of Pipe (5) Element				
It is used to connect to several pipes. Pipe (5) element is shown as the figure below:				
				
Style	Standard	Rotation 90	Rotation 180	Rotation 270
				
Pipe Gauge	Use this option to set the pipe gauge. The selectable range is from 1 ~ 5. The setting value 1 represents at least 13 pixels and the setting value 2 represents at least 26 pixels and vice versa.			














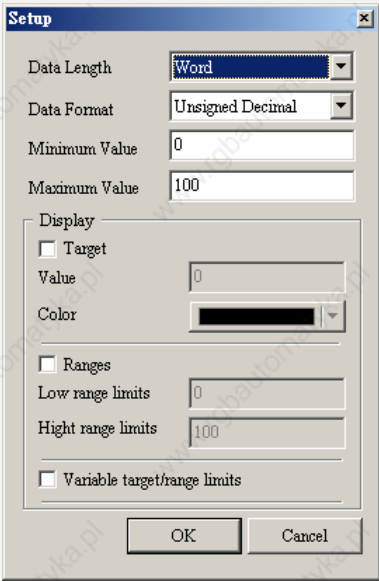
Property Description of Pipe (6) / Pipe (7) Element	
Horizontal and vertical pipes. It is used to display the direction of water flow.	
Read Address	It is used to set the read address. The link type can be Base Port or Internal Memory. (Please refer to Table 3.2.2 Property Description of General Buttons.)
Mobile Cursor Color	When there is any data occurred in the read address, the mobile cursor will display. The users can use this option to set the mobile cursor color.
Pipe Gauge	Use this option to set the pipe gauge. The selectable range is from 1 ~ 5. The setting value 1 represents at least 13 pixels and the setting value 2 represents at least 26 pixels and vice versa.

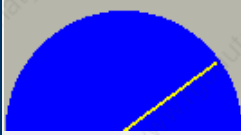

3.6 Pie Element



Fig. 3.6.1 Pie element options

Table 3.6.1 Property Description of Pie Element

Property Description of Pie Element									
<p>There are four kinds of Pie elements for the users to select. The users can use the element property table to set the minimum & maximum value, low & high limit and element color, etc. It can be used to display the size of the specific address and quickly judge its quantity by the increment and decrement measure of area. If the value of the address is less than the lower limit or higher than the high limit, it can change its color to show clearly for the users to recognize and give a warning to the users.</p>									
Read Address	It is used to set the read address. The link type can be Base Port or Internal Memory. (Please refer to Table 3.2.2 Property Description of General Buttons.)								
Text / Text Size Font / Text Color	The users can set the text, text size, font and text color that provided by Windows® to determine the text display on the element. (Please refer to Table 3.2.2 Property Description of General Buttons.)								
Border Color Foreground Color Background Color	It is used to set the border color, foreground and background color of the pie element. For example, the border color of the following example pie element is in blue, and the foreground color is set to green and its background color is in yellow. <div style="text-align: center;">  </div>								
Style	<table border="1" style="width: 100%; border-collapse: collapse;"> <tr> <td style="text-align: center;">Standard</td> <td style="text-align: center;">Raised</td> <td style="text-align: center;">Sunken</td> <td style="text-align: center;">Transparent</td> </tr> <tr> <td style="text-align: center;"></td> <td style="text-align: center;"></td> <td style="text-align: center;"></td> <td style="text-align: center;"></td> </tr> </table>	Standard	Raised	Sunken	Transparent				
	Standard	Raised	Sunken	Transparent					
									
Detail Setup		Data Length	There are 16bits Word and 32bits Double Word two options.						
		Data Format	There are following data format provided:						
			<p>Word/Double Word</p> <ol style="list-style-type: none"> 1. BCD 2. Signed BCD 3. Signed Decimal 4. Unsigned Decimal 5. Hex 						
	Minimum Value	It is used to set the minimum and maximum value of the pie element.							
	Maximum Value								

Property Description of Pie Element		
Target Value Color	The users can decide if the target value display or not by using this option. If this option is set, the target value and its color set by the users will display on the screen. HMI will refer to the minimum and maximum value and draw the proper reference line on the bar element just like the figure shown below: (Here we set the target value is 80 and its color is in yellow.)	
Ranges (Enable range setting)	Please refer to the description of Low & High Region Color.	
Variable target/range limits	When the target value and low & high limit is a variable value, the low limit address is <u>Read Address+1</u> , the high limit address is <u>Read Address+2</u> and the address of target value is <u>Read Address+3</u> .	
When the users have input the target value, low & high limit, and minimum & maximum value, after pressing OK button, HMI will examine the value by referring to the selected data length and data format.		
Low Region Color High Region Color	This option is available and displayed in the property table only when the "Ranges" option in the Detail Setup dialog box is selected. If the users set the low limit value is 30 and the color of low limit region is in green, and then set the high limit value is 70 and the color of high limit region is in red, the pie element will be shown as the figures below (The min. & max. input value is 0 and 100 respectively.):	 <p>When the value is 20 When the value is 50 When the value is 80</p>

Example of Pie Element:

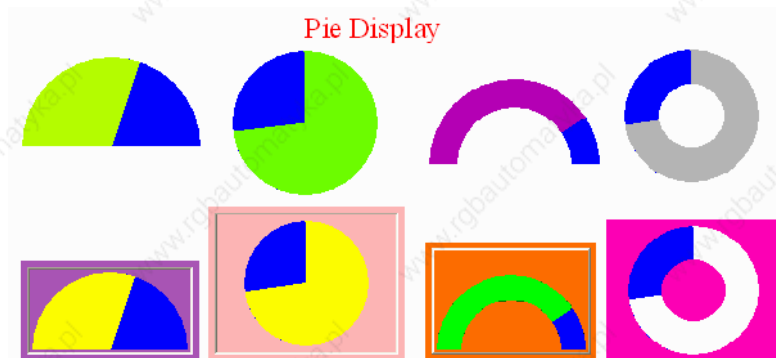


Fig. 3.6.2 Example of Pie element

3.7 Indicator

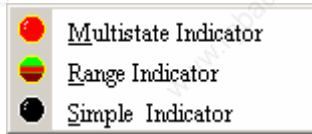


Fig. 3.7.1 Indicator element options

Table 3.7.1 Property Description of Multistate Indicator Element

Property Description of Multistate Indicator Element							
Multistate indicator provides a method to indicate the state of some specific address. It will send state changes message to user no matter it is Bit, LSB or WORD. If this address is an significant indicator or important message or important alarm, it can be used to inform the users immediately by changing state display method or different text setting. Or let the users know more information according to the changes of different states to make the users can also handle the corresponding situation at the first time.							
Read Address	It is used to set the read address. The link type can be Base Port or Internal Memory. (Please refer to Table 3.2.2 Property Description of General Buttons.) When the read address is set to the contact of the controller, i.e. PLC, the multistate indicator will change depending on the state (ON or OFF) of PLC corresponding contact. For example, the users can set that when the value is 1, the indicator will display the text "Start" and when the value is 0, the indicator will display the text "Stop". The users also can add picture into each state of the multistate indicator and then the corresponding picture will show when each state is activated.						
Text / Text Size Font / Text Color	The users can set the text, text size, font and text color that provided by Windows® to determine the text display on the element. (Please refer to Table 3.2.2 Property Description of General Buttons.)						
Twinkle	When Yes is selected, it indicates that the element will twinkle to remind the users.						
Picture Bank Name Picture Name	(Please refer to Table 3.2.2 Property Description of General Buttons.)						
Transparent Effect Transparent Color	(Please refer to Table 3.2.2 Property Description of General Buttons.)						
Foreground Color Style	(Please refer to Table 3.2.2 Property Description of General Buttons.)						
Data Length	<table border="1"> <tr> <td>Bit</td> <td>Indicator element can have two states.</td> </tr> <tr> <td>Word</td> <td>Indicator element can have 256 states.</td> </tr> <tr> <td>LSB</td> <td>Indicator element can have 16 states.</td> </tr> </table>	Bit	Indicator element can have two states.	Word	Indicator element can have 256 states.	LSB	Indicator element can have 16 states.
Bit	Indicator element can have two states.						
Word	Indicator element can have 256 states.						
LSB	Indicator element can have 16 states.						
Data Format	It provides BCD, Signed Decimal, Unsigned Decimal and Hex four kinds of data format to define the read memory content.						
Add/Remove State	It is used to set the state numbers of multistate indicator. If the data length of the value is in Word, 1~256 states can be set. If the data length of the value is in LSB, 16 states can be set. If the data length of the value is in Bit, only 2 states can be set.						

Example of Indicator Elements:



Table 3.7.2 Property Description of Range Indicator Element

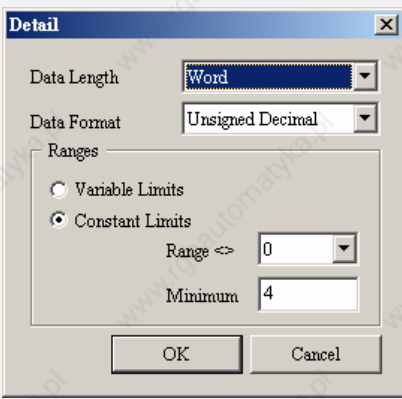
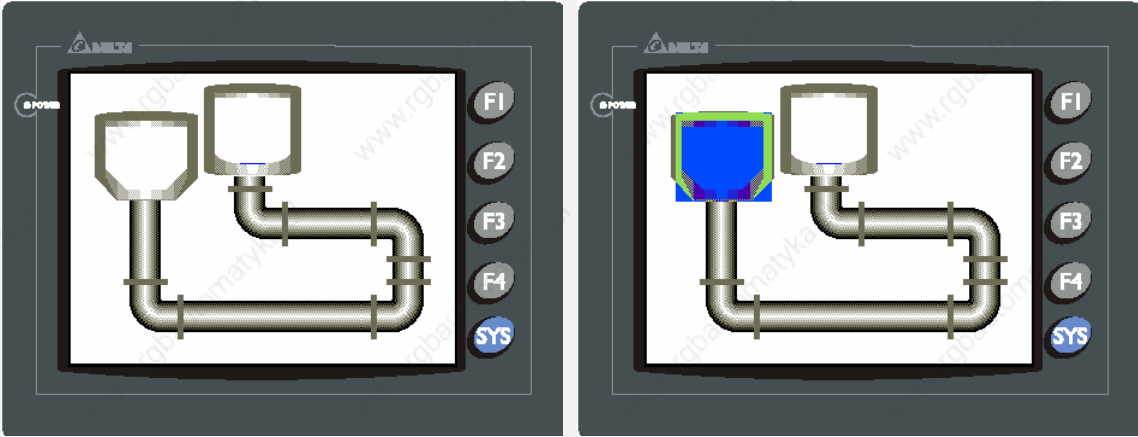
Property Description of Range Indicator Element																					
Range indicator provides a method to indicate the state of some specific address. It will send state changes message to user no matter it is Bit, LSB or WORD. HMI reads the value of the corresponding PLC specific address (register) and compare this read value with the lower limit value and then, display the corresponding state of comparison result on HMI screen.																					
Read Address	It is used to set the read address. The link type can be Base Port or Internal Memory. (Please refer to Table 3.2.2 Property Description of General Buttons.)																				
Text / Text Size Font / Text Color	The users can set the text, text size, font and text color that provided by Windows® to determine the text display on the element. (Please refer to Table 3.2.2 Property Description of General Buttons.)																				
Twinkle	When Yes is selected, it indicates that the element will twinkle to remind the users.																				
Picture Bank Name Picture Name	(Please refer to Table 3.2.2 Property Description of General Buttons.)																				
Transparent Effect Transparent Color	(Please refer to Table 3.2.2 Property Description of General Buttons.)																				
Foreground Color Style	(Please refer to Table 3.2.2 Property Description of General Buttons.)																				
Add/Remove State	It is used to set the state numbers of range indicator. If the data length of the value is in Word, 1~256 states can be set. If the data length of the value is in LSB, 16 states can be set. If the data length of the value is in Bit, only 2 states can be set.																				
Detail																					
	<table border="1"> <tr> <td>Data Length</td> <td>There are 16bits Word and 32bits Double Word two options.</td> </tr> <tr> <td>Data Format</td> <td>There are following data format provided:</td> </tr> <tr> <td></td> <td>Word/Double Word</td> </tr> <tr> <td></td> <td> <ol style="list-style-type: none"> BCD Signed BCD Signed Decimal Unsigned Decimal </td> </tr> </table>	Data Length	There are 16bits Word and 32bits Double Word two options.	Data Format	There are following data format provided:		Word/Double Word		<ol style="list-style-type: none"> BCD Signed BCD Signed Decimal Unsigned Decimal 												
Data Length	There are 16bits Word and 32bits Double Word two options.																				
Data Format	There are following data format provided:																				
	Word/Double Word																				
	<ol style="list-style-type: none"> BCD Signed BCD Signed Decimal Unsigned Decimal 																				
Range	<table border="1"> <tr> <td>Constant Limits</td> <td colspan="4">Selecting this option can use default 5 states to set the range. If there is n numbers of states, it indicates that there is Range n-1 for the users to use. The users can specify the foreground color of state 0, 1, 2, 3, and 4 as red, green, blue, yellow and purple respectively.</td> </tr> <tr> <td></td> <td>Range 0</td> <td>Range 1</td> <td>Range 2</td> <td>Range 3</td> </tr> <tr> <td></td> <td>100</td> <td>50</td> <td>33</td> <td>1</td> </tr> <tr> <td></td> <td colspan="4">When the value of read address is higher than 100, the range indicator will display in red. When the value of the read address is higher than 50, the range indicator will display in green, and vise versa.</td> </tr> </table>	Constant Limits	Selecting this option can use default 5 states to set the range. If there is n numbers of states, it indicates that there is Range n-1 for the users to use. The users can specify the foreground color of state 0, 1, 2, 3, and 4 as red, green, blue, yellow and purple respectively.					Range 0	Range 1	Range 2	Range 3		100	50	33	1		When the value of read address is higher than 100, the range indicator will display in red. When the value of the read address is higher than 50, the range indicator will display in green, and vise versa.			
	Constant Limits	Selecting this option can use default 5 states to set the range. If there is n numbers of states, it indicates that there is Range n-1 for the users to use. The users can specify the foreground color of state 0, 1, 2, 3, and 4 as red, green, blue, yellow and purple respectively.																			
	Range 0	Range 1	Range 2	Range 3																	
	100	50	33	1																	
	When the value of read address is higher than 100, the range indicator will display in red. When the value of the read address is higher than 50, the range indicator will display in green, and vise versa.																				
Variable Limits	When this option is selected, there is Range n-1 for the users to use. n represents the total state numbers and n-1 represents the total range numbers. For example, if the read address is \$0, and the total state number of the element is 5, it indicates that there is Range 0~4 for the users to use. Then, the lower limit value of Range 0 is \$1, the lower limit value of Range 1 is \$2 and vise versa.																				

Table 3.7.3 Property Description of Simple Indicator Element

Property Description of Simple Indicator Element	
<p>For the users' convenience, simple indicator provides two states (ON/OFF) to let the users change the base picture quickly. The users can also import the completed CAD drawing into a simple indicator element directly by clicking Screen > Import command. In the following left example figure, there are simple indicator elements on the top of the pipe element. The simple indicator elements will change as shown as the right figure below.</p>	
	
Read Address	It is used to set the read address. The link type can be Base Port or Internal Memory. (Please refer to Table 3.2.2 Property Description of General Buttons.)
Text / Text Size Font / Text Color	The users can set the text, text size, font and text color that provided by Windows® to determine the text display on the element. (Please refer to Table 3.2.2 Property Description of General Buttons.)
XOR Color	It is used to set XOR color of base picture.

3.8 Data Display

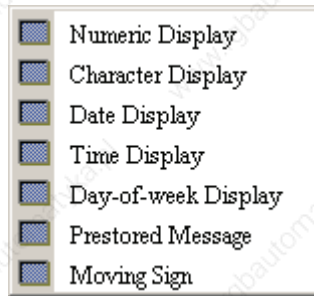


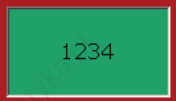




Fig. 3.8.1 Data Display element options

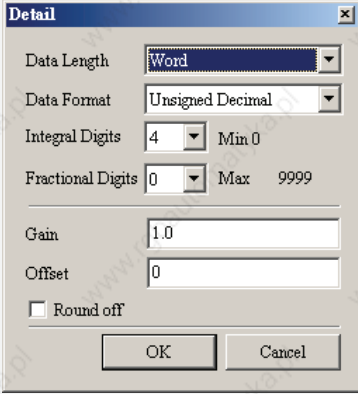
Table 3.8.1 Function of Data Display elements

Element Type	Function
Numeric Display	Display the value of the specific address.
Character Display	Display the text or character of the specific address.
Date Display	Display date of HMI.
Time Display	Display time of HMI.
Day-of-week Display	Display day-of-week of HMI.
Prestored Message	Display message according to the state of HMI.
Moving Sign	Display message by moving sign according to the state of HMI.

■ Numeric Display

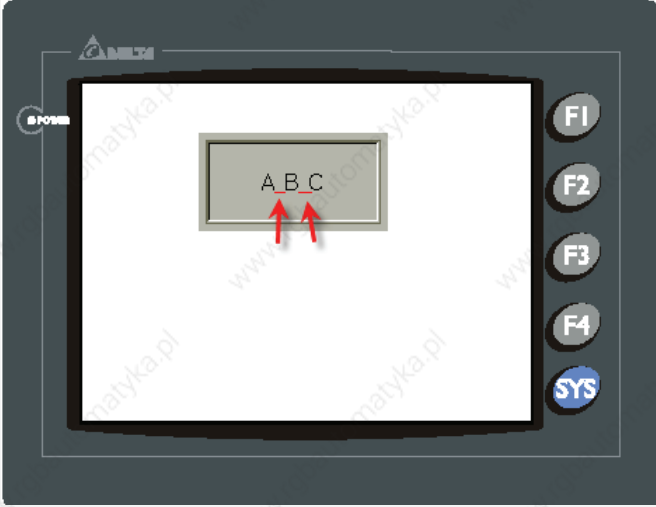
Table 3.8.2 Property Description of Numeric Display Element

Property Description of Numeric Display Element				
This element will read the value of the setting address and display the read value immediately in the format set by the users.				
Read Address	It is used to set the read address. The link type can be Base Port or Internal Memory. (Please refer to Table 3.2.2 Property Description of General Buttons.)			
Text Size Text Color	The users can set the text size and text color that provided by HMI to determine the text display on the element. HMI provides 8~64 kinds of default text font for the users to use.			
Border Color Background Color	Border Color option can be set only when the style of the numeric display element is selected as Raised and Sunken. The style of the element below is selected as "Sunken". Its background color is set to green and its border color is set to red.  (If the style of the element is set to Transparent, the Border Color and Background Color these two options are disabled.)			
Style	Standard	Raised	Sunken	Transparent
				

Property Description of Numeric Display Element																							
Leading Zero	<p>The following figures show the difference if the users select the Leading Zero option. (Please note that the integral digits is set to 4.)</p> <div style="display: flex; align-items: center; margin-bottom: 10px;"> <div style="border: 1px solid gray; padding: 5px; margin-right: 10px;">0888</div> <p>(If YES is selected, the numeric value will show as this one.)</p> </div> <div style="display: flex; align-items: center;"> <div style="border: 1px solid gray; padding: 5px; margin-right: 10px;">888</div> <p>(If NO is selected, the numeric value will show as this one.)</p> </div>																						
Detail	<div style="text-align: center;">  </div> <table border="1" style="width: 100%; border-collapse: collapse;"> <tr> <td>Date Length</td> <td colspan="2">There are 16bits Word and 32bits Double Word two options.</td> </tr> <tr> <td rowspan="2">Data Format</td> <td colspan="2">There are following data format provided:</td> </tr> <tr> <td style="text-align: center;">Word</td> <td style="text-align: center;">Double Word</td> </tr> <tr> <td></td> <td> <ol style="list-style-type: none"> 1. BCD 2. Signed BCD 3. Signed Decimal 4. Unsigned Decimal 5. Hex 6. Binary </td> <td> <ol style="list-style-type: none"> 1. BCD 2. Signed BCD 3. Signed Decimal 4. Unsigned Decimal 5. Hex 6. Binary 7. Floating </td> </tr> <tr> <td>Integral Digits</td> <td colspan="2" rowspan="2">Use this option to determine the digit number of integer and decimal fraction. The digit number is not a real digit number value. It is only the display format. The digit number will be a real decimal number only when the data format is selected as "Floating".</td> </tr> <tr> <td>Fractional Digits</td> </tr> <tr> <td>Gain (a)</td> <td colspan="2" rowspan="2">The users can use $y = (a) \times (\text{read address value}) + (b)$ this equation to determine the display numeric value (y). For example, if Gain value (a) is 2 and Offset value (b) is 3, when the read address value is 3, then the display numeric value will be equal to $(2) \times 3 + (3) = 9$.</td> </tr> <tr> <td>Offset (b)</td> </tr> <tr> <td>Round off</td> <td colspan="2">If this option is selected, after the operation of the equation above, all numeric values can be rounded off and display on the screen.</td> </tr> </table>	Date Length	There are 16bits Word and 32bits Double Word two options.		Data Format	There are following data format provided:		Word	Double Word		<ol style="list-style-type: none"> 1. BCD 2. Signed BCD 3. Signed Decimal 4. Unsigned Decimal 5. Hex 6. Binary 	<ol style="list-style-type: none"> 1. BCD 2. Signed BCD 3. Signed Decimal 4. Unsigned Decimal 5. Hex 6. Binary 7. Floating 	Integral Digits	Use this option to determine the digit number of integer and decimal fraction. The digit number is not a real digit number value. It is only the display format. The digit number will be a real decimal number only when the data format is selected as "Floating".		Fractional Digits	Gain (a)	The users can use $y = (a) \times (\text{read address value}) + (b)$ this equation to determine the display numeric value (y). For example, if Gain value (a) is 2 and Offset value (b) is 3, when the read address value is 3, then the display numeric value will be equal to $(2) \times 3 + (3) = 9$.		Offset (b)	Round off	If this option is selected, after the operation of the equation above, all numeric values can be rounded off and display on the screen.	
Date Length	There are 16bits Word and 32bits Double Word two options.																						
Data Format	There are following data format provided:																						
	Word	Double Word																					
	<ol style="list-style-type: none"> 1. BCD 2. Signed BCD 3. Signed Decimal 4. Unsigned Decimal 5. Hex 6. Binary 	<ol style="list-style-type: none"> 1. BCD 2. Signed BCD 3. Signed Decimal 4. Unsigned Decimal 5. Hex 6. Binary 7. Floating 																					
Integral Digits	Use this option to determine the digit number of integer and decimal fraction. The digit number is not a real digit number value. It is only the display format. The digit number will be a real decimal number only when the data format is selected as "Floating".																						
Fractional Digits																							
Gain (a)	The users can use $y = (a) \times (\text{read address value}) + (b)$ this equation to determine the display numeric value (y). For example, if Gain value (a) is 2 and Offset value (b) is 3, when the read address value is 3, then the display numeric value will be equal to $(2) \times 3 + (3) = 9$.																						
Offset (b)																							
Round off	If this option is selected, after the operation of the equation above, all numeric values can be rounded off and display on the screen.																						
Fast Refresh	<p>If this option is selected, the element can be displayed immediately when switching the screen. Please note that only 4 elements (including display element and input element) can be fast refreshed on one screen. The users can set the Fast Refresh Rate by clicking Screen > Screen Properties command. There are three levels of the Fast Refresh Rate and they are High, Medium and Low.</p>																						

■ Character Display

Table 3.8.3 Property Description of Character Display Element

Property Description of Character Display Element	
The users can use this element to read the value of the specific address, convert them to text or character and display on the screen. The read value must be in ASCII format or the users cannot see the display text or character. (The max. string length is 28 words.)	
Read Address	It is used to set the read address. The link type can be Base Port or Internal Memory. (Please refer to Table 3.2.2 Property Description of General Buttons.)
Text Size Text Color	The users can set the text size and text color that provided by HMI to determine the text display on the element. HMI provides 8~64 kinds of default text font for the users to use.
Border Color Background Color	(Please refer to Table 3.8.2 Property Description of Numeric Display Element.)
Style	(Please refer to Table 3.8.2 Property Description of Numeric Display Element.)
String Length	<p>The range is with 1 ~ 28 words.</p>  <p>If we set the read address as Internal Memory 0, i.e. \$0, the string length is 5 and set Screen Open Macro as follows: \$0 = 65 \$1 = 66 \$2 = 67 \$3 = 68 \$4 = 69 Then, the above screen will display. Please note that character display element reads the Byte value, and the data length of the internal memory \$ address is Word, therefore, when reading the Internal Memory \$0, the display character will be A(65)_ (0) B(66)_ (0) C(67)_ (0)... and vice versa.</p>
Fast Refresh	If this option is selected, the element can be displayed immediately when switching the screen. <u>Please note that only 4 elements (including display element and input element) can be fast refreshed on one screen.</u> The users can set the Fast Refresh Rate by clicking Screen > Screen Properties command. There are three levels of the Fast Refresh Rate and they are High, Medium and Low.

■ Date Display

Table 3.8.4 Property Description of Data Display Element

Property Description of Date Display Element	
Display HMI system date. There are several date formats selectable for the users to use.	
Text Size Text Color	The users can set the text size and text color that provided by HMI to determine the text display on the element. HMI provides 8~64 kinds of default text font for the users to use.
Border Color Background Color	(Please refer to Table 3.8.2 Property Description of Numeric Display Element.)
Style	(Please refer to Table 3.8.2 Property Description of Numeric Display Element.)
Date Format	Provide MM/DD/YY , DD/MM/YY , DD.MM.YY three kinds of formats.

■ Time Display

Table 3.8.5 Property Description of Time Display Element

Property Description of Time Display Element	
Display HMI system time. There are several time formats selectable for the users to use.	
Text Size Text Color	The users can set the text size and text color that provided by HMI to determine the text display on the element. HMI provides 8~64 kinds of default text font for the users to use.
Border Color Background Color	(Please refer to Table 3.8.2 Property Description of Numeric Display Element.)
Style	(Please refer to Table 3.8.2 Property Description of Numeric Display Element.)
Time Format	Provide HH:MM:SS , HH:MM two kinds of formats.

■ Day-of-week Display

Table 3.8.6 Property Description of Day-of-week Display Element

Property Description of Day-of-week Display Element	
Display the day (Sunday ~ Monday) of the week. The state default setting of the Day-of-week display element is set to 7. It indicates that there are 7 states for this element. Each state has its predefined day description, such as SUN, MON ... SAT. The users can change it directly in the property table.	
Text / Text Size Font / Text Color	The users can set the text, text size, font and text color that provided by Windows® to determine the text display on the element. (Please refer to Table 3.2.2 Property Description of General Buttons.)
Border Color Background Color	(Please refer to Table 3.8.2 Property Description of Numeric Display Element.)
Style	(Please refer to Table 3.8.2 Property Description of Numeric Display Element.)

■ Prestored Message

Table 3.8.7 Property Description of Prestored Message Element

Property Description of Prestored Message Element		
Display the state content of PLC corresponding contact or register directly. The users can set state number and text for each state.		
Read Address	It is used to set the read address. The link type can be Base Port or Internal Memory. (Please refer to Table 3.2.2 Property Description of General Buttons.)	
Text / Text Size Font / Text Color	The users can set the text, text size, font and text color that provided by Windows® to determine the text display on the element. (Please refer to Table 3.2.2 Property Description of General Buttons.)	
Border Color Background Color	(Please refer to Table 3.8.2 Property Description of Numeric Display Element.)	
Style	(Please refer to Table 3.8.2 Property Description of Numeric Display Element.)	
Data Type	Bit	It can have two states.
	Word	It can have 256 states.
	LSB	It can have 16 states.
Data Format	It provides BCD, Signed Decimal, Unsigned Decimal and Hex four kinds of data format to define the read memory content.	
Add/Remove State	It is used to set the state numbers of prestored message element. If the data length of the value is in Word, 1~256 states can be set. If the data length of the value is in LSB, 16 states can be set. If the data length of the value is in Bit, only 2 states can be set.	

■ Moving Sign

Table 3.8.8 Property Description of Moving Sign Element

Property Description of Moving Sign Element		
Moving sign is a sign that uses movement, lighting, or special display to depict and display the state content of PLC corresponding contact or register. The users can determine the display of the moving sign by the settings of the direction, moving points, and interval(ms) in the property table.		
Read Address	It is used to set the read address. The link type can be Base Port or Internal Memory. (Please refer to Table 3.2.2 Property Description of General Buttons.)	
Text / Text Size Font / Text Color	The users can set the text, text size, font and text color that provided by Windows® to determine the text display on the element. (Please refer to Table 3.2.2 Property Description of General Buttons.)	
Border Color Background Color	(Please refer to Table 3.8.2 Property Description of Numeric Display Element.)	
Style	(Please refer to Table 3.8.2 Property Description of Numeric Display Element.)	
Data Type	Bit	It can have two states.
	Word	It can have 256 states.
	LSB	It can have 16 states.
Data Format	It provides BCD, Signed Decimal, Unsigned Decimal and Hex four kinds of data format to define the read memory content.	

Property Description of Moving Sign Element		
Add/Remove State	It is used to set the state numbers of moving sign element. If the data length of the value is in Word, 1~256 states can be set. If the data length of the value is in LSB, 16 states can be set. If the data length of the value is in Bit, only 2 states can be set.	
Direction	Left	The display progressing direction is from right to the left.
	Right	The display progressing direction is from left to the right.
	Top	The display progressing direction is from bottom to the top.
	Bottom	The display progressing direction is from top to the bottom.
Moving Points	It is used to set the movement of the moving sign. The unit is Pixel and the range is within 1 ~ 50 Pixels.	
Interval(ms)	It is used to set the interval time between two movements. The unit is ms and the range is within 50 ~ 3000 ms.	

3.9 Graph Display

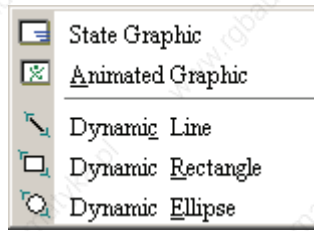


Fig. 3.9.1 Graph Display element options



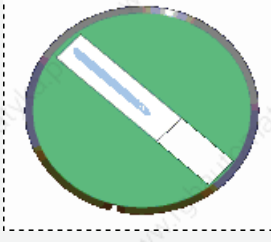
Table 3.9.1 Function of Graph Display elements

Element Type	Icon	Function
State Graphic		It is used to create and display one or more state pictures on the certain positions of the HMI screen. Different pictures can be shown on the screen according to the different states.
Animated Graphic		It is used to create and display an animated picture on any position of the HMI screen. The users can control the X and Y direction to move and show the animated pictures freely. Different pictures can be shown on the screen according to the different states.
Dynamic Line		It is used to draw and display a dynamic line on the HMI screen. The users can control the X and Y direction to move the dynamic line element and change its size freely.
Dynamic Rectangle		It is used to draw and display a dynamic rectangle on the HMI screen. The users can control the X and Y direction to move the dynamic rectangle element and change its size freely.
Dynamic Ellipse		It is used to draw and display a dynamic ellipse on the HMI screen. The users can control the X and Y direction to move the dynamic ellipse element and change its size freely.

■ Static Graphic

Table 3.9.2 Property Description of Static Graphic Element

Property Description of Static Graphic Element		
When HMI is connected to PLC, the users can create static graphic elements to read the value of several read addresses controlled by PLC. The read value of each state can be converted and transmitted to the static graphic elements and display on the HMI screen.		
Read Address	It is used to set the read address. The link type can be Base Port or Internal Memory. (Please refer to Table 3.2.2 Property Description of General Buttons.)	
Picture Bank Name	(Please refer to Table 3.2.2 Property Description of General Buttons.)	
Picture Name	(Please refer to Table 3.2.2 Property Description of General Buttons.)	
Transparent Effect	(Please refer to Table 3.2.2 Property Description of General Buttons.)	
Transparent Color	(Please refer to Table 3.2.2 Property Description of General Buttons.)	
Foreground Color	(Please refer to Table 3.2.2 Property Description of General Buttons.)	
Data Length	Bit	It can have two states.
	Word	It can have 256 states.
	LSB	It can have 16 states.
Data Format	It provides BCD, Signed Decimal, Unsigned Decimal and Hex four kinds of data format to define the read memory content.	

Property Description of Static Graphic Element	
Add/Remove State	It is used to set the state numbers of static graphic element. If the data length of the value is in Word, 1~256 states can be set. If the data length of the value is in LSB, 16 states can be set. If the data length of the value is in Bit, only 2 states can be set.
Auto Change	No When this option is selected, the value of the read address will be regarded as the state number. It means that the state number is determined by the value of the read address. For example, if the value of the read address \$0 is 0, it will switch to 0th state; if the value of the read address \$0 is 5, it will switch to 5th state.
	Yes When this option is selected and the value of the read address is a non-zero value, the static graphic element will change automatically.
	Variation When this option is selected, the property of the <u>Read Address</u> will be the condition of changing element. The element will change automatically according to <u>Read Address+1</u> . If the value of the <u>Read Address+1</u> is a non-zero value, the static graphic element will change automatically. Otherwise, it will not change.
Transparent	<p>If Yes is selected, it indicates that this element will be displayed in transparent color. It is usually used with the transparent color setting of the element. Please refer to the following example elements:</p> <div style="display: flex; flex-direction: column; align-items: center;"> <div style="display: flex; align-items: center; margin-bottom: 10px;">  <div style="margin-left: 10px;">The transparent color has not been set yet.</div> </div> <div style="display: flex; align-items: center; margin-bottom: 10px;">  <div style="margin-left: 10px;">The element transparent color has been set.</div> </div> <div style="display: flex; align-items: center;">  <div style="margin-left: 10px;">The transparent color of the whole drawing has been set.</div> </div> </div> <p>Note: If Yes is selected (set to Transparent), the foreground color option is disabled.</p>

Example of Static Graphic element:

The designated read address = D100. The internal memory value and each state should be as follows:



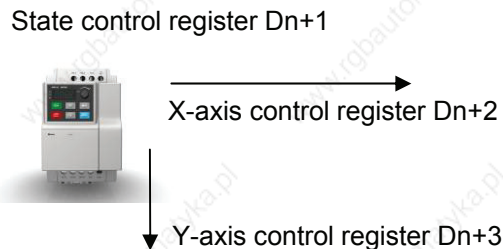
■ Animated Graphic

Table 3.9.3 Property Description of Animated Graphic Element

Property Description of Animated Graphic Element		
When HMI is connected to PLC, the users can create animated graphic elements to read the value of several read addresses controlled by PLC. The read value of each state can be converted and transmitted to the animated graphic elements and display on the HMI screen. The movement and moving position can also be controlled and show on the HMI screen.		
Read Address	It is used to set the read address. The link type can be Base Port or Internal Memory. (Please refer to Table 3.2.2 Property Description of General Buttons.)	
	Read Address	Use the value of <u>Read Address</u> to switch the state of animated graphic element.
	Read Address+1	Use the value of <u>Read Address+1</u> to be the horizontal axis position of the animated graphic element.
	Read Address+2	Use the value of <u>Read Address+2</u> to be the vertical axis position of the animated graphic element.
Picture Bank Name Picture Name	(Please refer to Table 3.2.2 Property Description of General Buttons.)	
Transparent Effect Transparent Color	(Please refer to Table 3.2.2 Property Description of General Buttons.)	
Clear Picture	Use this option to clear previous animated graphic element when moving the element or changing the state of the element.	
Data Length	Word	It can have 256 states.
	LSB	It can have 16 states.
Data Format	It provides BCD, Signed Decimal, Unsigned Decimal and Hex four kinds of data format to define the read memory content.	
Add/Remove State	It is used to set the state numbers of animated graphic. If the data length of the value is in Word, 1~256 states can be set. If the data length of the value is in LSB, 16 states can be set. If the data length of the value is in Bit, only 2 states can be set.	

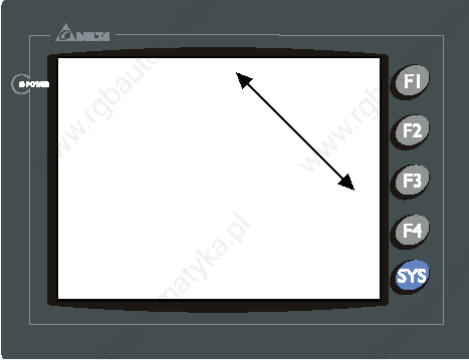
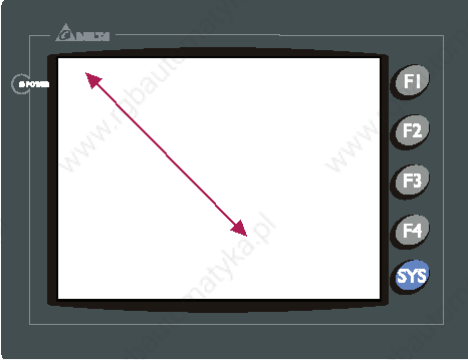
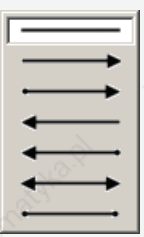
Example of Animated Graphic element:

The designated read address = D100. The internal memory value and each state should be as follows:



Dynamic Line

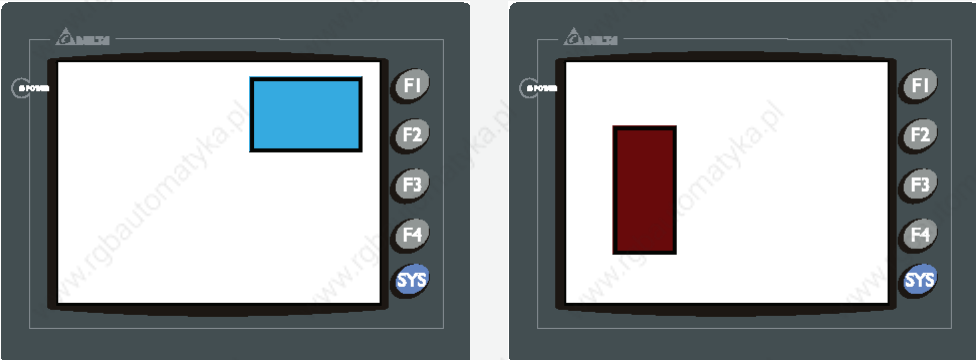
Table 3.9.4 Property Description of Dynamic Line Element


Property Description of Dynamic Line Element											
<p>The dynamic line element can be changed and moved depending on the value of the PLC corresponding contact or register.</p> <div style="display: flex; justify-content: space-around;">   </div>											
Read Address	<p>It is used to set the read address. The link type can be Base Port or Internal Memory. (Please refer to Table 3.2.2 Property Description of General Buttons.)</p> <table border="1" style="width: 100%;"> <tr> <td>Read Address</td> <td> <p>The value of the <u>Read Address</u> can be used only when <u>Variable Position</u> option is set to Yes. It is used to represent the left-top horizontal position (Left) of the element.</p> <p>When <u>Variable Position</u> option is set to No and <u>Variable Color</u> option is set to Yes, the value of the <u>Read Address</u> is used to represent the line color and the range is within 0 ~ 255.</p> </td> </tr> <tr> <td>Read Address +1</td> <td> <p>The value of the <u>Read Address+1</u> can be used only when <u>Variable Position</u> option is set to Yes. It is used to represent the left-top vertical position (Top) of the element.</p> </td> </tr> <tr> <td>Read Address +2</td> <td> <p>The value of the <u>Read Address+2</u> can be used only when <u>Variable Position</u> option is set to Yes. It is used to represent the right-bottom horizontal position (Right) of the element.</p> </td> </tr> <tr> <td>Read Address +3</td> <td> <p>The value of the <u>Read Address+3</u> can be used only when <u>Variable Position</u> option is set to Yes. It is used to represent the right-bottom vertical position (Bottom) of the element.</p> </td> </tr> <tr> <td>Read Address +4</td> <td> <p>The value of the <u>Read Address+4</u> can be used only when <u>Variable Color</u> option is set to Yes. It is used to represent the line color and the range is within 0 ~ 255.</p> </td> </tr> </table>	Read Address	<p>The value of the <u>Read Address</u> can be used only when <u>Variable Position</u> option is set to Yes. It is used to represent the left-top horizontal position (Left) of the element.</p> <p>When <u>Variable Position</u> option is set to No and <u>Variable Color</u> option is set to Yes, the value of the <u>Read Address</u> is used to represent the line color and the range is within 0 ~ 255.</p>	Read Address +1	<p>The value of the <u>Read Address+1</u> can be used only when <u>Variable Position</u> option is set to Yes. It is used to represent the left-top vertical position (Top) of the element.</p>	Read Address +2	<p>The value of the <u>Read Address+2</u> can be used only when <u>Variable Position</u> option is set to Yes. It is used to represent the right-bottom horizontal position (Right) of the element.</p>	Read Address +3	<p>The value of the <u>Read Address+3</u> can be used only when <u>Variable Position</u> option is set to Yes. It is used to represent the right-bottom vertical position (Bottom) of the element.</p>	Read Address +4	<p>The value of the <u>Read Address+4</u> can be used only when <u>Variable Color</u> option is set to Yes. It is used to represent the line color and the range is within 0 ~ 255.</p>
Read Address	<p>The value of the <u>Read Address</u> can be used only when <u>Variable Position</u> option is set to Yes. It is used to represent the left-top horizontal position (Left) of the element.</p> <p>When <u>Variable Position</u> option is set to No and <u>Variable Color</u> option is set to Yes, the value of the <u>Read Address</u> is used to represent the line color and the range is within 0 ~ 255.</p>										
Read Address +1	<p>The value of the <u>Read Address+1</u> can be used only when <u>Variable Position</u> option is set to Yes. It is used to represent the left-top vertical position (Top) of the element.</p>										
Read Address +2	<p>The value of the <u>Read Address+2</u> can be used only when <u>Variable Position</u> option is set to Yes. It is used to represent the right-bottom horizontal position (Right) of the element.</p>										
Read Address +3	<p>The value of the <u>Read Address+3</u> can be used only when <u>Variable Position</u> option is set to Yes. It is used to represent the right-bottom vertical position (Bottom) of the element.</p>										
Read Address +4	<p>The value of the <u>Read Address+4</u> can be used only when <u>Variable Color</u> option is set to Yes. It is used to represent the line color and the range is within 0 ~ 255.</p>										
Line Color	It is used to set the display color of the dynamic line element.										
Twinkle	When Yes is selected, it indicates that the element will twinkle to remind the users.										
Line Size	The unit is Pixel and the range is within 1 ~ 8.										
Data Format	It provides BCD, Signed Decimal, Unsigned Decimal and Hex four kinds of data format to define the read memory content.										
Line Style	<p>There are following line styles can be selected.</p> 										
Variable Position	(Please refer to the description of Read Address above)										

Property Description of Dynamic Line Element	
Variable Color	(Please refer to the description of Read Address above)

■ Dynamic Rectangle

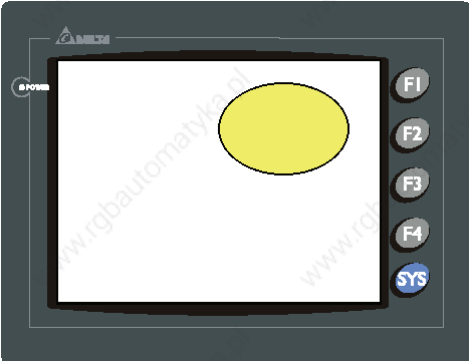
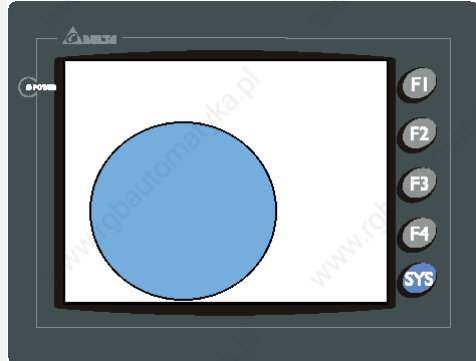
Table 3.9.5 Property Description of Dynamic Rectangle Element

Property Description of Dynamic Rectangle Element	
<p>The dynamic rectangle element, including element size and color can be changed and moved depending on the value of the PLC corresponding contact or register.</p>	
	
Read Address	It is used to set the read address. The link type can be Base Port or Internal Memory. (Please refer to Table 3.2.2 Property Description of General Buttons.)
Read Address	The value of the <u>Read Address</u> can be used only when <u>Variable Position</u> option is set to Yes. It is used to represent the left-top horizontal position (Left) of the element.
Read Address +1	The value of the <u>Read Address+1</u> can be used only when <u>Variable Position</u> option is set to Yes. It is used to represent the left-top vertical position (Top) of the element.
Read Address +2	The value of the <u>Read Address+2</u> can be used only when <u>Variable Size</u> option is set to Yes. It is used to represent the right-bottom horizontal position (Right) of the element.
Read Address +3	The value of the <u>Read Address+3</u> can be used only when <u>Variable Size</u> option is set to Yes. It is used to represent the right-bottom vertical position (Bottom) of the element.
Read Address +4	The value of the <u>Read Address+4</u> can be used only when <u>Variable Color</u> option is set to Yes. It is used to represent the rectangle foreground color and the range is within 0 ~ 255.
<p>Please note that when <u>Variable Position</u> option is set to No, the internal memory address of <u>Variable Size</u> option will increase one (one increment). (<u>Read Address</u> will represent the right-bottom horizontal position (Right) of the element. <u>Read Address+1</u> will represent the right-bottom vertical position (Bottom) of the element. <u>Read Address+2</u> will represent the foreground color of the element.)</p>	
Twinkle	When Yes is selected, it indicates that the element will twinkle to remind the users.
Foreground Color	It is used to set the foreground color of the dynamic rectangle element.
Line Size	The unit is Pixel and the range is within 1 ~ 8.
Data Format	It provides BCD, Signed Decimal, Unsigned Decimal and Hex four kinds of data format to define the read memory content.
Transparent	When this option is selected, the element will display only with the border and there is no color in the element. The Foreground Color option will be disabled also.

Property Description of Dynamic Rectangle Element	
Round Radius	0~38 pixels round radius are provided for selection. 
Variable Position	(Please refer to the description of Read Address above)
Variable Size	(Please refer to the description of Read Address above)
Variable Color	(Please refer to the description of Read Address above)

■ Dynamic Ellipse

Table 3.9.6 Property Description of Dynamic Ellipse Element

Property Description of Dynamic Ellipse Element											
<p>The dynamic ellipse element, including element size and color can be changed and moved depending on the value of the PLC corresponding contact or register.</p> <div style="display: flex; justify-content: space-around;">   </div>											
Read Address	<p>It is used to set the read address. The link type can be Base Port or Internal Memory. (Please refer to Table 3.2.2 Property Description of General Buttons.)</p> <table border="1" style="width: 100%;"> <tr> <td>Read Address</td> <td>The value of the <u>Read Address</u> can be used only when <u>Variable Central Point</u> option is set to Yes. It is used to represent the horizontal position of the element center point.</td> </tr> <tr> <td>Read Address +1</td> <td>The value of the <u>Read Address+1</u> can be used only when <u>Variable Central Point</u> option is set to Yes. It is used to represent the vertical position of the element center point.</td> </tr> <tr> <td>Read Address +2</td> <td>The value of the <u>Read Address+2</u> can be used only when <u>Variable Radius</u> option is set to Yes. It is used to represent the horizontal radius of the element.</td> </tr> <tr> <td>Read Address +3</td> <td>The value of the <u>Read Address+3</u> can be used only when <u>Variable Radius</u> option is set to Yes. It is used to represent the vertical radius of the element.</td> </tr> <tr> <td>Read Address +4</td> <td>The value of the <u>Read Address+4</u> can be used only when <u>Variable Color</u> option is set to Yes. It is used to represent the ellipse foreground color and the range is within 0 ~ 255.</td> </tr> </table> <p>Please note that when <u>Variable Central Point</u> option is set to No, the internal memory address of <u>Variable Radius</u> option will increase one (one increment). (<u>Read Address</u> will represent the horizontal radius of the element. <u>Read Address+1</u> will represent the vertical radius of the element. <u>Read Address+2</u> will represent the foreground color of the element.)</p>	Read Address	The value of the <u>Read Address</u> can be used only when <u>Variable Central Point</u> option is set to Yes. It is used to represent the horizontal position of the element center point.	Read Address +1	The value of the <u>Read Address+1</u> can be used only when <u>Variable Central Point</u> option is set to Yes. It is used to represent the vertical position of the element center point.	Read Address +2	The value of the <u>Read Address+2</u> can be used only when <u>Variable Radius</u> option is set to Yes. It is used to represent the horizontal radius of the element.	Read Address +3	The value of the <u>Read Address+3</u> can be used only when <u>Variable Radius</u> option is set to Yes. It is used to represent the vertical radius of the element.	Read Address +4	The value of the <u>Read Address+4</u> can be used only when <u>Variable Color</u> option is set to Yes. It is used to represent the ellipse foreground color and the range is within 0 ~ 255.
Read Address	The value of the <u>Read Address</u> can be used only when <u>Variable Central Point</u> option is set to Yes. It is used to represent the horizontal position of the element center point.										
Read Address +1	The value of the <u>Read Address+1</u> can be used only when <u>Variable Central Point</u> option is set to Yes. It is used to represent the vertical position of the element center point.										
Read Address +2	The value of the <u>Read Address+2</u> can be used only when <u>Variable Radius</u> option is set to Yes. It is used to represent the horizontal radius of the element.										
Read Address +3	The value of the <u>Read Address+3</u> can be used only when <u>Variable Radius</u> option is set to Yes. It is used to represent the vertical radius of the element.										
Read Address +4	The value of the <u>Read Address+4</u> can be used only when <u>Variable Color</u> option is set to Yes. It is used to represent the ellipse foreground color and the range is within 0 ~ 255.										
Line Color	It is used to set the display color of the dynamic ellipse element.										

Property Description of Dynamic Ellipse Element	
Twinkle	When Yes is selected, it indicates that the element will twinkle to remind the users.
Foreground Color	It is used to set the foreground color of the dynamic ellipse element.
Line Size	The unit is Pixel and the range is within 1 ~ 8.
Data Format	It provides BCD, Signed Decimal, Unsigned Decimal and Hex four kinds of data format to define the read memory content.
Transparent	When this option is selected, the element will display only with the border and there is no color in the element. The Foreground Color option will be disabled also.
Variable Central Point	(Please refer to the description of Read Address above)
Variable Radius	(Please refer to the description of Read Address above)
Variable Color	(Please refer to the description of Read Address above)

3.10 Input Element

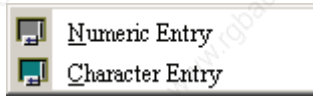




Fig. 3.10.1 Input element options





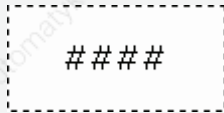
Set write and read address for the users to input and display address value. Write and read address can be the same or different.


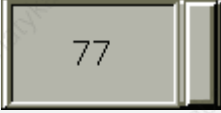
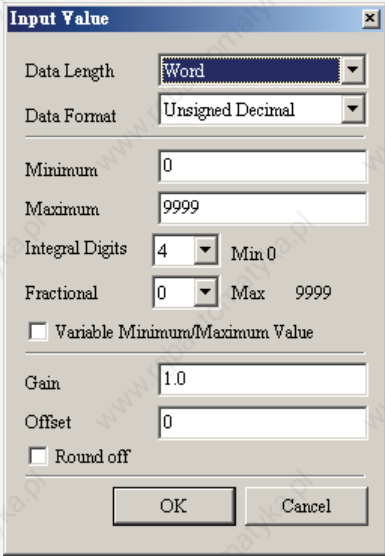
Table 3.10.1 Function of Input elements


Element Type	Icon	Function
Numeric Entry		It is used to input and display the numeric value of specific PLC address.
Character Entry		It is used to input and display the characters of specific PLC address.

■ Numeric Entry

Table 3.10.2 Property Description of Numeric Entry Element

Property Description of Numeric Entry Element				
After pressing this numeric entry element on the screen, a system built-in numeric keypad (TEN-KEY) will show up and the users can use it to input the setting value directly. When pressing ENTER key, HMI will send the input setting value to PLC corresponding register. The maximum and minimum input setting values are all user-defined. The users can also specify the trigger mode to trigger the designated PLC address before or after writing the setting value.				
Write Address Read Address	It is used to set the read and write address. The link type can be Base Port or Internal Memory. (Please refer to Table 3.2.2 Property Description of General Buttons.) Please note that if the users set the write address only, after press “Compile” key, HMI will copy the write address data into the read address automatically.			
Text Size Text Color	The users can set the text size and text color that provided by HMI to determine the text display on the element. HMI provides 8~64 kinds of default text font for the users to use.			
Border Color Background Color	Border Color option can be set only when the style of the numeric entry element is selected as Raised and Sunken. The style of the element below is selected as “Rasied”. Its background color is set to blue and its border color is set to red.  (If the style of the element is set to Transparent, the Border Color and Background Color these two options are disabled.)			
Style	Standard	Raised	Sunken	Transparent
				

Property Description of Numeric Entry Element																														
Leading Zero	<p>The following figures show the difference if the users select the Leading Zero option. (Please note that the integral digits is set to 4.)</p> <div style="display: flex; align-items: center;">  <div style="margin-left: 10px;">(If YES is selected, the numeric value will show as this one.)</div> </div> <div style="display: flex; align-items: center; margin-top: 10px;">  <div style="margin-left: 10px;">(If NO is selected, the numeric value will show as this one.)</div> </div>																													
Trigger Trigger Mode	<p>The users can use this setting to trigger the designated PLC address to be ON before or after writing the setting value. Note: this function can only trigger PLC address to be ON. If the PLC address needs to be triggered again, the users should set the address to be OFF by themselves.</p>																													
Detail	<div style="text-align: center;">  </div> <table border="1" style="width: 100%; border-collapse: collapse;"> <tr> <td style="width: 20%;">Date Length</td> <td>There are 16bits Word and 32bits Double Word two options.</td> </tr> <tr> <td rowspan="2">Data Format</td> <td>There are following data format provided:</td> </tr> <tr> <td> <table border="1" style="width: 100%; border-collapse: collapse;"> <thead> <tr> <th style="width: 50%;">Word</th> <th style="width: 50%;">Double Word</th> </tr> </thead> <tbody> <tr> <td>1. BCD</td> <td>1. BCD</td> </tr> <tr> <td>2. Signed BCD</td> <td>2. Signed BCD</td> </tr> <tr> <td>3. Signed Decimal</td> <td>3. Signed Decimal</td> </tr> <tr> <td>4. Unsigned Decimal</td> <td>4. Unsigned Decimal</td> </tr> <tr> <td>5. Hex</td> <td>5. Hex</td> </tr> <tr> <td>6. Binary</td> <td>6. Binary</td> </tr> <tr> <td></td> <td>7. Floating</td> </tr> </tbody> </table> </td> </tr> <tr> <td>Minimum</td> <td rowspan="2">The users can set the minimum and maximum of input setting value to determine the range of input setting value.</td> </tr> <tr> <td>Maximum</td> </tr> <tr> <td>Integral Digits</td> <td rowspan="2">Use this option to determine the digit number of integer and decimal fraction. The digit number is not a real digit number value. It is only the display format. The digit number will be a real decimal number only when the data format is selected as "Floating".</td> </tr> <tr> <td>Fractional Digits</td> </tr> <tr> <td colspan="2"> <p>When <u>Variable Minimum/Maximum Value</u> option is selected, it indicates that the minimum value is determined by <u>Read Address+1</u> and the maximum value is determined by <u>Read Address+2</u>.</p> </td> </tr> </table>	Date Length	There are 16bits Word and 32bits Double Word two options.	Data Format	There are following data format provided:	<table border="1" style="width: 100%; border-collapse: collapse;"> <thead> <tr> <th style="width: 50%;">Word</th> <th style="width: 50%;">Double Word</th> </tr> </thead> <tbody> <tr> <td>1. BCD</td> <td>1. BCD</td> </tr> <tr> <td>2. Signed BCD</td> <td>2. Signed BCD</td> </tr> <tr> <td>3. Signed Decimal</td> <td>3. Signed Decimal</td> </tr> <tr> <td>4. Unsigned Decimal</td> <td>4. Unsigned Decimal</td> </tr> <tr> <td>5. Hex</td> <td>5. Hex</td> </tr> <tr> <td>6. Binary</td> <td>6. Binary</td> </tr> <tr> <td></td> <td>7. Floating</td> </tr> </tbody> </table>	Word	Double Word	1. BCD	1. BCD	2. Signed BCD	2. Signed BCD	3. Signed Decimal	3. Signed Decimal	4. Unsigned Decimal	4. Unsigned Decimal	5. Hex	5. Hex	6. Binary	6. Binary		7. Floating	Minimum	The users can set the minimum and maximum of input setting value to determine the range of input setting value.	Maximum	Integral Digits	Use this option to determine the digit number of integer and decimal fraction. The digit number is not a real digit number value. It is only the display format. The digit number will be a real decimal number only when the data format is selected as "Floating".	Fractional Digits	<p>When <u>Variable Minimum/Maximum Value</u> option is selected, it indicates that the minimum value is determined by <u>Read Address+1</u> and the maximum value is determined by <u>Read Address+2</u>.</p>	
Date Length	There are 16bits Word and 32bits Double Word two options.																													
Data Format	There are following data format provided:																													
	<table border="1" style="width: 100%; border-collapse: collapse;"> <thead> <tr> <th style="width: 50%;">Word</th> <th style="width: 50%;">Double Word</th> </tr> </thead> <tbody> <tr> <td>1. BCD</td> <td>1. BCD</td> </tr> <tr> <td>2. Signed BCD</td> <td>2. Signed BCD</td> </tr> <tr> <td>3. Signed Decimal</td> <td>3. Signed Decimal</td> </tr> <tr> <td>4. Unsigned Decimal</td> <td>4. Unsigned Decimal</td> </tr> <tr> <td>5. Hex</td> <td>5. Hex</td> </tr> <tr> <td>6. Binary</td> <td>6. Binary</td> </tr> <tr> <td></td> <td>7. Floating</td> </tr> </tbody> </table>	Word	Double Word	1. BCD	1. BCD	2. Signed BCD	2. Signed BCD	3. Signed Decimal	3. Signed Decimal	4. Unsigned Decimal	4. Unsigned Decimal	5. Hex	5. Hex	6. Binary	6. Binary		7. Floating													
Word	Double Word																													
1. BCD	1. BCD																													
2. Signed BCD	2. Signed BCD																													
3. Signed Decimal	3. Signed Decimal																													
4. Unsigned Decimal	4. Unsigned Decimal																													
5. Hex	5. Hex																													
6. Binary	6. Binary																													
	7. Floating																													
Minimum	The users can set the minimum and maximum of input setting value to determine the range of input setting value.																													
Maximum																														
Integral Digits	Use this option to determine the digit number of integer and decimal fraction. The digit number is not a real digit number value. It is only the display format. The digit number will be a real decimal number only when the data format is selected as "Floating".																													
Fractional Digits																														
<p>When <u>Variable Minimum/Maximum Value</u> option is selected, it indicates that the minimum value is determined by <u>Read Address+1</u> and the maximum value is determined by <u>Read Address+2</u>.</p>																														

Property Description of Numeric Entry Element		
	Gain (a)	The users can use $y = (a) \times (\text{read address value}) + (b)$ this equation to determine the display numeric value (y). For example, if Gain value (a) is 2 and Offset value (b) is 3, when the read address value is 3, then the display numeric value will be equal to $(2) \times 3 + (3) = 9$.
	Offset (b)	
	Round off	
	When the users have input the minimum and maximum value, after pressing OK button, HMI will examine the value by referring to the selected data length, data format, integral and fractional digits.	
Input Mode	There are Touch Popup, Active Non-Popup and Touch Non-Popup three options. The default setting is Touch Popup. For the description of Active input mode, please refer to section 3.15 Keypad Element.	
User Security Level	Use this option to set the user priority for pressing this element. Only the priority that is higher than the current setting can use this element.	
Display Asterisk (*)	If YES is selected, the screen will show as the following figure when inputting the setting value.	
		
Fast Refresh	If this option is selected, the element can be displayed immediately when switching the screen. <u>Please note that only 4 elements (including display element and input element) can be fast refreshed on one screen.</u> The users can set the Fast Refresh Rate by clicking Screen > Screen Properties command. There are three levels of the Fast Refresh Rate and they are High, Medium and Low.	
Set Low Security	Use this option to force the current priority to be the lowest after the button is pressed. This can prevent the misoperation made by the users (operators).	
InterLock Address InterLock Level	It is similar to the Latch function. When read address is changed from Low to High (or from High to Low, this is determined by the property of "InterLock Level"), this button can be enabled.	
Before Execute Macro	When this option is set, the input macro will be enabled and executed before this button is pressed.	
After Execute Macro	When this option is set, the input macro will be enabled and executed after this button is pressed.	

Example of Numeric Entry element:


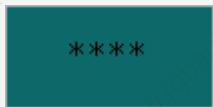
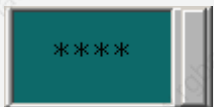
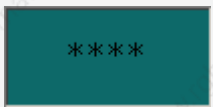

After pressing the numeric entry element, a system built-in numeric keypad (TEN-KEY) will display on the screen as shown as the figure below. The example here is to input numeric value 99 into PLC corresponding register, D100.




Fig. 3.10.2 TEN-KEY input dialog box

■ Character Entry

Table 3.10.3 Property Description of Character Entry Element

Property Description of Character Entry Element				
The users can set write and read address to input the data of the specific address by text or character and display them on the screen. The input and display text or character must be in ASCII format. Write and read address can be the same or different. (The max. string length is 28words.)				
Write Address Read Address	It is used to set the read and write address. The link type can be Base Port or Internal Memory. (Please refer to Table 3.2.2 Property Description of General Buttons.) Please note that if the users set the write address only, after press “Compile” key, HMI will copy the write address data into the read address automatically.			
Text Size Text Color	The users can set the text size and text color that provided by HMI to determine the text display on the element. HMI provides 8~64 kinds of default text font for the users to use.			
Border Color Background Color	Border Color option can be set only when the style of the character entry element is selected as Raised and Sunken. The style of the element below is selected as “Raised”. Its background color is set to blue and its border color is set to gray.  (If the style of the element is set to Transparent, the Border Color and Background Color these two options are disabled.)			
Style	Standard	Raised	Sunken	Transparent
				
Character Length	The range is with 1 ~ 28 words. The default setting is 4words.			
Trigger Trigger Mode	The users can use this setting to trigger the designated PLC address to be ON before or after writing the setting value. Note: this function can only trigger PLC address to be ON. If the PLC address needs to be triggered again, the users should set the address to be OFF by themselves.			

Property Description of Character Entry Element	
Input Mode	There are Touch Popup, Active Non-Popup and Touch Non-Popup three options. The default setting is Touch Popup. For the description of Active input mode, please refer to section 3.15 Keypad Element.
User Security Level	Use this option to set the user priority for pressing this element. Only the priority that is higher than the current setting can use this element.
Display Asterisk (*)	If YES is selected, the screen will show as the following figure when inputting the text or character. 
Fast Refresh	If this option is selected, the element can be displayed immediately when switching the screen. Please note that only 4 elements (including display element and input element) can be fast refreshed on one screen. The users can set the Fast Refresh Rate by clicking Screen > Screen Properties command. There are three levels of the Fast Refresh Rate and they are High, Medium and Low.
Set Low Security	Use this option to force the current priority to be the lowest after the button is pressed. This can prevent the misoperation made by the users (operators).
InterLock Address InterLock Level	It is similar to the Latch function. When read address is changed from Low to High (or from High to Low, this is determined by the property of "InterLock Level"), this button can be enabled.
Before Execute Macro	When this option is set, the input macro will be enabled and executed before this button is pressed.
After Execute Macro	When this option is set, the input macro will be enabled and executed after this button is pressed.

Example of Character Entry element:

After pressing the character entry element, a system built-in character keypad (ASCII-KEY) will display on the screen as shown as the figure below. The users can input the text or character in ASCII format into PLC corresponding register, (D1000~Dn). n represents the character length.

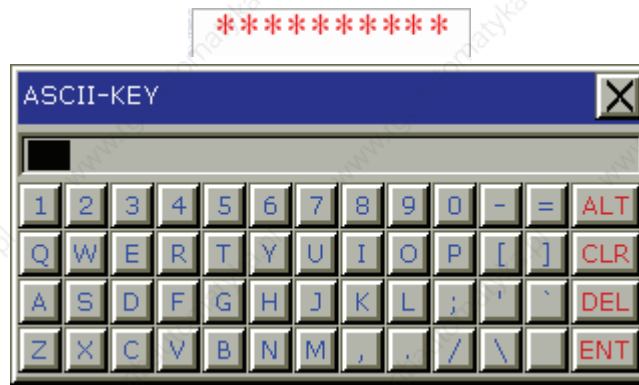


Fig. 3.10.3 ASCII-KEY input dialog box

3.11 Curve Element



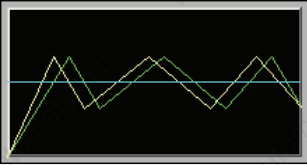
Fig. 3.11.1 Curve element options

Table 3.11.1 Function of Curve elements

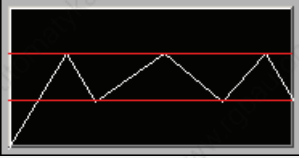
Element Type	Icon	Function
Trend Graph		It is used to display the value change of the read address by trend graph. The trend graph can only display and set the change of Y-axis.
X-Y Chart		It is used to display the value change of the read address by trend graph. The trend graph can display and set the change of X-axis and Y-axis.

■ Trend Graph

Table 3.11.2 Property Description of Trend Graph Element

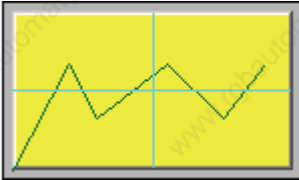
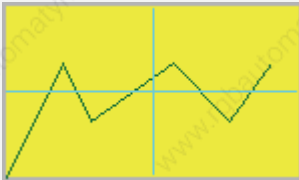
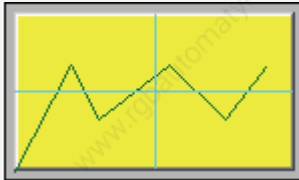
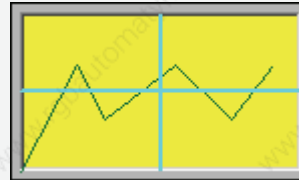
Property Description of Trend Graph Element			
<p>The first step for setting trend graph is to set the curve number in “Curve Field Total” option (range is 1~4) in property table. Then, setting the read address, read format, curve width and color in “Detail Setup” option to complete the setup.</p> <p>HMI will convert a series value of setting address to a trend graph on the screen. For example, if there are 100 sampling points and four curves, there will be 100 X 4 = 400 points. If HMI is connected to Delta PLC, suppose that the read address is D0, it will read 400 words (D0~D399) after the address is triggered. Setting Y-axis of curve 1 is D0~D99, Y-axis of curve 2 is D100~D199, Y-axis of curve 3 is D200~D299 and Y-axis of curve 4 is D300~D399. If the value exceeds maximum value, it will be displayed with maximum value. If the value is less than minimum value, it will be displayed with minimum value. After setting, the users should set the address of the control block to trigger read data of trend graph, trend graph drawing and clear the curve. Please refer to Chapter 5 for the settings of the control block.</p>			
Border Color Background Color	<p>Border Color option can be set only when the style of the trend graph element is selected as Raised and Sunken. The style of the element below is selected as “Raised”. Its background color is set to black and its border color is set to gray.</p> 		
Style	Standard	Raised	Sunken
Curve Field Total	1~4 curves can be set and displayed.		

Property Description of Trend Graph Element	
Detail Setup	
Sample Number	<p>When Sample Number is a constant: The max. sample number is defined as the following:</p> <ol style="list-style-type: none"> 1. When the element style is selected as “Standard”, the max. sample number is the element width and the unit is pixels. 2. When the element style is selected as “Raised” or “Sunken”, the max. sample number is the element width minus the border width (the value of the border width is 14 pixels). The border width is shown as the place where the arrow sign ends. <p>Please note that when the sample number is a constant, the Max. Sample Number option is disabled.</p> <p>When Sample Number is a variable value: the system will refer to the value of Read Address+1 and regard the value as the max. sample number. Then, the Max. Sample Number option will be enabled. If the read value is more than the set Max. Sample Number, the system will take the set Max. Sample Number as the actual max. sample number.</p>
Max. Sample Number	
Read Format	<p style="text-align: center;">Word</p> <ol style="list-style-type: none"> 1. BCD 2. Signed BCD 3. Signed Decimal 4. Unsigned Decimal 5. Hex
Read Address	It is used to set the read address. The link type can be Base Port or Internal Memory.
Sample Flag	It is used to set trigger and clear flag. When sample flag is triggered, it will start to read data and draw the graph. This sample flag is located within the control block. Please refer to Chapter 5 for the settings of the control block.
Minimum	It is used to set the minimum and maximum value of the display data, i.e. the minimum and maximum value of Y-axis. If the read value is more the maximum or less than the minimum, the system will display the minimum and maximum value still.
Maximum	

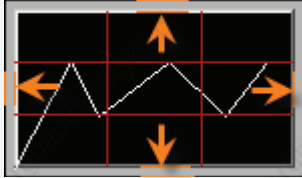
Property Description of Trend Graph Element	
Curve Width	It is used to the display curve width. The range is within 1 ~ 8 and the unit is pixel.
Curve Color	It is used to the display curve color.
Grid Color	Please refer to the figure below. The grid color is set to red and the grid number in horizontal direction is set to 3. 
Grid Number in Horiz.	

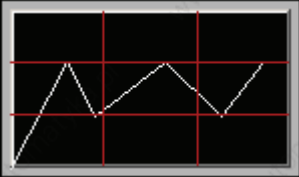
■ X-Y Chart

Table 3.11.3 Property Description of X-Y Chart Element

Property Description of X-Y Chart Element			
<p>HMI will convert a series value of setting address to a X-Y chart on the screen. For example, if there are 100 sampling points and four curves, there will be $100 \times 4 \times 2 = 800$ points. If HMI is connected to Delta PLC, suppose that the read address of X-axis is D0 and the read address of Y-axis is D500, it will read 800 words (D0~D399 and D500~D899) after the address is triggered. Setting X-axis of curve 1 is D0~D99, Y-axis of curve 1 is D500~D599, X-axis of curve 2 is D100~D199 and Y-axis of curve 2 is D600~D699, X-axis of curve 3 is D200~D299 and Y-axis of curve 3 is D700~D799, X-axis of curve 4 is D300~D399 and Y-axis of curve 4 is D800~D899. If the value exceeds maximum value, it will be displayed with maximum value. If the value is less than minimum value, it will be displayed with minimum value. After setting, the users should set the address of the control block to trigger read data and the drawings of the X-Y chart. Please refer to Chapter 5 for the settings of the control block.</p>			
Border Color Background Color	<p>Border Color option can be set only when the style of the X-Y chart element is selected as Raised and Sunken. The style of the element below is selected as "Raised". Its background color is set to yellow and its border color is set to gray.</p> 		
Style	<p>Standard</p> 	<p>Raised</p> 	<p>Sunken</p> 
Connect Two Points	<p>If Yes option is selected, when drawing the X-Y chart on the screen, the space between two points on the X-Y chart will be connected by lines.</p>		
Curve Field Total	<p>1~4 curves can be set and displayed.</p>		

Property Description of X-Y Chart Element	
Detail Setup	
Sample Number	<p><u>When Sample Number is a constant:</u> The max. sample number is defined as the following:</p> <ol style="list-style-type: none"> 1. When the element style is selected as “Standard”, the max. sample number is the element width and the unit is pixels. 2. When the element style is selected as “Raised” or “Sunken”, the max. sample number is the element width minus the border width (the value of the border width is 14 pixels). The border width is shown as the place where the arrow sign ends.
Max. Sample Number	<p><u>When Sample Number is a variable value:</u> the system will refer to the value of <u>Read Address+1</u> and regard the value as the max. sample number. Then, the <u>Max. Sample Number</u> option will be enabled. If the read value is more than the set <u>Max. Sample Number</u>, the system will take the set <u>Max. Sample Number</u> as the actual max. sample number.</p>
Read Format	<p style="text-align: center;">Word</p> <ol style="list-style-type: none"> 1. BCD 2. Signed BCD 3. Signed Decimal 4. Unsigned Decimal 5. Hex
Horiz. Read Address	It is used to set the read address of the horizontal data. The link type can be Base Port or Internal Memory.
Vert. Read Address	It is used to set the read address of the vertical data. The link type can be Base Port or Internal Memory.



Property Description of X-Y Chart Element													
	<table border="1"> <tr> <td>Sample Flag</td> <td>It is used to set trigger and clear flag. When sample flag is triggered, it will start to read data and draw the X-Y chart. This sample flag is located within the control block. Please refer to Chapter 5 for the settings of the control block.</td> </tr> <tr> <td>Horiz. Minimum</td> <td rowspan="2">It is used to set the minimum and maximum value of the horizontal display data, i.e. the minimum and maximum value of X-axis. If the read value is more the maximum or less than the minimum, the system will display the minimum and maximum value still.</td> </tr> <tr> <td>Horiz. Maximum</td> </tr> <tr> <td>Horiz. Minimum</td> <td rowspan="2">It is used to set the minimum and maximum value of the vertical display data, i.e. the minimum and maximum value of Y-axis. If the read value is more the maximum or less than the minimum, the system will display the minimum and maximum value still.</td> </tr> <tr> <td>Horiz. Maximum</td> </tr> <tr> <td>Curve Width</td> <td>It is used to the display curve width. The range is within 1 ~ 8 and the unit is pixel.</td> </tr> <tr> <td>Curve Color</td> <td>It is used to the display curve color.</td> </tr> </table>	Sample Flag	It is used to set trigger and clear flag. When sample flag is triggered, it will start to read data and draw the X-Y chart. This sample flag is located within the control block. Please refer to Chapter 5 for the settings of the control block.	Horiz. Minimum	It is used to set the minimum and maximum value of the horizontal display data, i.e. the minimum and maximum value of X-axis. If the read value is more the maximum or less than the minimum, the system will display the minimum and maximum value still.	Horiz. Maximum	Horiz. Minimum	It is used to set the minimum and maximum value of the vertical display data, i.e. the minimum and maximum value of Y-axis. If the read value is more the maximum or less than the minimum, the system will display the minimum and maximum value still.	Horiz. Maximum	Curve Width	It is used to the display curve width. The range is within 1 ~ 8 and the unit is pixel.	Curve Color	It is used to the display curve color.
Sample Flag	It is used to set trigger and clear flag. When sample flag is triggered, it will start to read data and draw the X-Y chart. This sample flag is located within the control block. Please refer to Chapter 5 for the settings of the control block.												
Horiz. Minimum	It is used to set the minimum and maximum value of the horizontal display data, i.e. the minimum and maximum value of X-axis. If the read value is more the maximum or less than the minimum, the system will display the minimum and maximum value still.												
Horiz. Maximum													
Horiz. Minimum	It is used to set the minimum and maximum value of the vertical display data, i.e. the minimum and maximum value of Y-axis. If the read value is more the maximum or less than the minimum, the system will display the minimum and maximum value still.												
Horiz. Maximum													
Curve Width	It is used to the display curve width. The range is within 1 ~ 8 and the unit is pixel.												
Curve Color	It is used to the display curve color.												
Grid Color	Please refer to the figure below. The grid color is set to red and the grid number in horizontal and vertical direction are both set to 2.												
Horiz. Line Number													
Vert. Line Number													

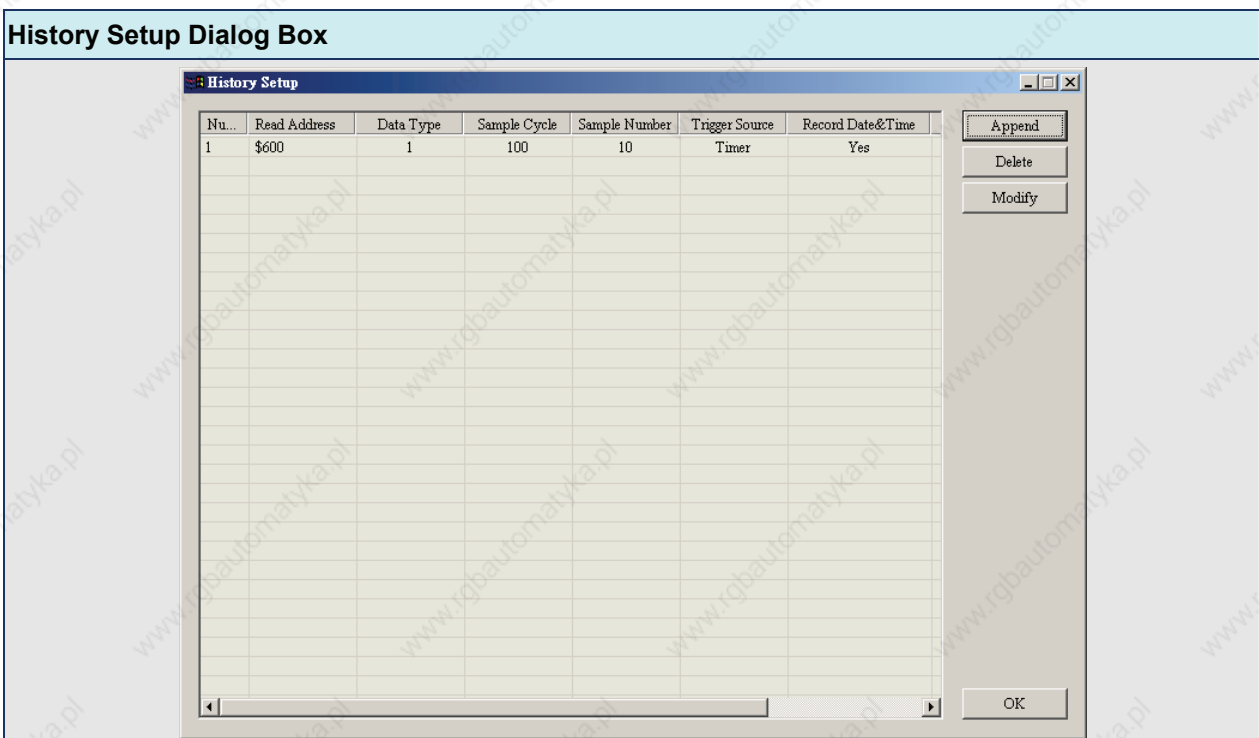
3.12 Sampling Element



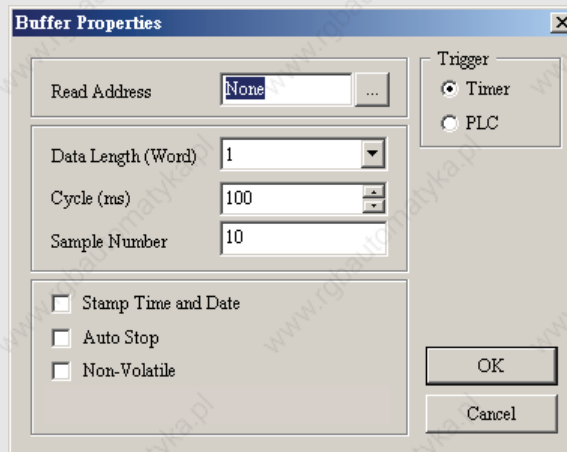
Fig. 3.12.1 Sampling element options

The sampling element is designed to display the history data by history graph or table and can be updated immediately for the users to use and read more easily. Let us review the History Setup function (see page 2-132) again. History Setup should be used with sampling elements. The users can click "Option" > "History Setup" (Choosing History Setup command from menu bar) to execute this function.

Table 3.12.1 History Setup Dialog Box



Append Pressing Append button can add a history data. After the Append button is pressed, the following Buffer Properties dialog box will display.

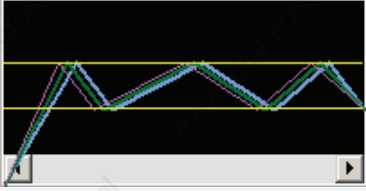
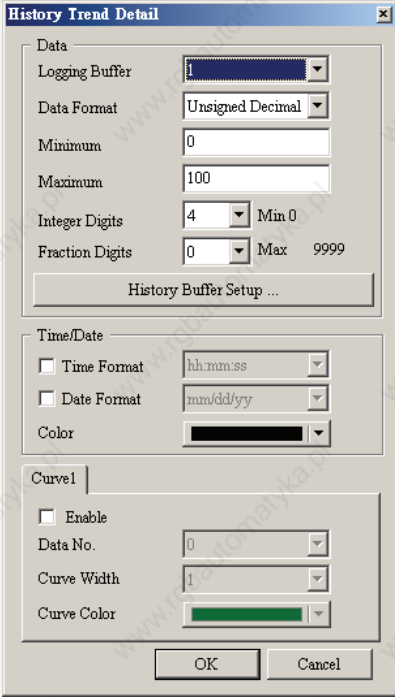



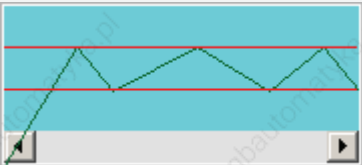
Read Address It is used to set the starting address for sampling the history data.

History Setup Dialog Box	
Data Length (Word)	<p>It is used to set how much Word the users want to sample? The range is within 1 ~ 13 continuous Words. It indicates that max. 13 continuous words can be sampled.</p> <p>For example: If the setting value of Data Length is set to 6, it indicates that there are 6 continuous Words (M100, M101, ..., M105) can be sampled. The <u>Sample Number</u> option is used to set the max. sample number. If the <u>Sample Number</u> option is set to 100, the system will sample 6words x 100 = 600 numbers of data each time.</p>
Cycle (ms)	<p>It is used to set the sampling cycle time for reading address (how long is it to read address one time). If the Trigger option is PLC, this option will be ineffective. The range of the sampling cycle time is within 0 ~ 86400000 ms.</p>
Sample Number	<p>This option is used with the Auto Stop option. If the Auto Stop option is selected, HMI will stop recording the data after the numbers of records have reached the setting value of Sample Number option. If the Auto Stop option is not selected, when record number of data exceeds the setting value of Sample Number option, it will delete the first record and insert the new record into the last address. For example, if the setting value is set to 100 and the number of records in history exceeds 100, the first record will be deleted and the second record will become to the third record, the third record will become to the forth record...and the 100th record will become to 99th record. Therefore, the new record (101st record) will become to 100th record.</p>
Stamp Time and Date	<p>Use this option to determine if the time and date are also recorded during sampling operation.</p>
Auto Stop	<p>Use this option to determine if HMI stop recording when the max. number of record data is reached.</p>
Non-Volatile	<p>Using this option can enable to save sampling data in SRAM when the power is turned off. The capacity for saving history data of DOP-A series is 240MBytes and DOP-AE series is 360MBytes. (The power of SRAM is battery when the power is turned off.) (In some HMI models, the users can save data in USB Disk or SMC card when the power is turned off and the capacity for saving history data depends on the capacity of USB Disk or SMC card.)</p>
Trigger	<p>There are Timer and PLC two options. It means that the sampling action is controlled by the Timer of the HMI or the external controller, i.e. PLC. When PLC option is selected, it indicates that the trigger bit designated by the register for sampling history buffer in the control block control the sampling action.</p>
OK / Cancel	<p>Press OK button to save the data and exit. Press Cancel to exit without saving data.</p>
Delete	<p>Pressing Delete button can delete a history data.</p>
Modify	<p>Pressing Modify button can modify a history data.</p>

■ Historical Trend Graph

Table 3.12.2 Property Description of Historical Trend Graph Element

Property Description of Historical Trend Graph Element	
Convert the history data to trend graph with continuous curves and display on HMI screen.	
Border Color Background Color	The below element background color is set to black and its border color is set to gray. 
Curve Number	1~8 curves can be set and displayed.
Detail	
Logging Buffer	Use this option to set the number (No.1 ~ No.X) of history buffer for reading the data of PLC corresponding address. The users can press the History Buffer Setup button or click "Option" > "History Setup" (Choosing History Setup command from menu bar) to set the PLC corresponding address.
Data Format	<p style="text-align: center;">Word</p> <ol style="list-style-type: none"> 1. BCD 2. Signed BCD 3. Signed Decimal 4. Unsigned Decimal 5. Hex 6. Floating

Property Description of Historical Trend Graph Element	
	<p>Please note that if the data format is selected as “Floating”, the Data Length option in the History Setup dialog box must be greater than or equal to 2words or the following warning message dialog box will display on the screen.</p> 
Minimum	It is used to set the minimum and maximum value of the display data, i.e. the minimum and maximum value of Y-axis. If the read value is more the maximum or less than the minimum, the system will display the minimum and maximum value still.
Maximum	
Integral Digits	Use this option to determine the digit number of integer and decimal fraction. The digit number is not a real digit number value. It is only the display format. The digit number will be a real decimal number only when the data format is selected as “Floating”.
Fractional Digits	
Time/Date	
Time Format	Provide HH:MM:SS , HH:MM two kinds of formats.
Date Format	Provide MM/DD/YY , DD/MM/YY and DD.MM.YY three kinds of formats.
Color	When time or date format is selected, the users can use this option to designate the display color.
Curve (No.1 ~ 8)	
Enable	If this option is selected, the following curve options are enabled and can be set.
Data No.	<p>It is used to set the reading Word data when triggering every time. For example, if the Data Length option in the History Setup dialog box is set to 3words, there are 0 ~ 2 data numbers can be selected in this option. When selecting 1, it indicates that this Curve 1 reads the data of the Read Address+1 set in History Setup dialog box.</p> <p>Please note that if the data format is selected as “Floating”, and the Data Length option in the History Setup dialog box is an odd numbers of words, ensure to set the Data No. as an even number.</p>
Curve Width	It is used to the display curve width. The range is within 1 ~ 8 and the unit is pixel.
Curve Color	It is used to the display curve color.
Grid Color	Please refer to the figure below. The grid color is set to red and the grid number in horizontal direction is set to 3.
Grid Number	
	

Example of Historical Trend Graph element:

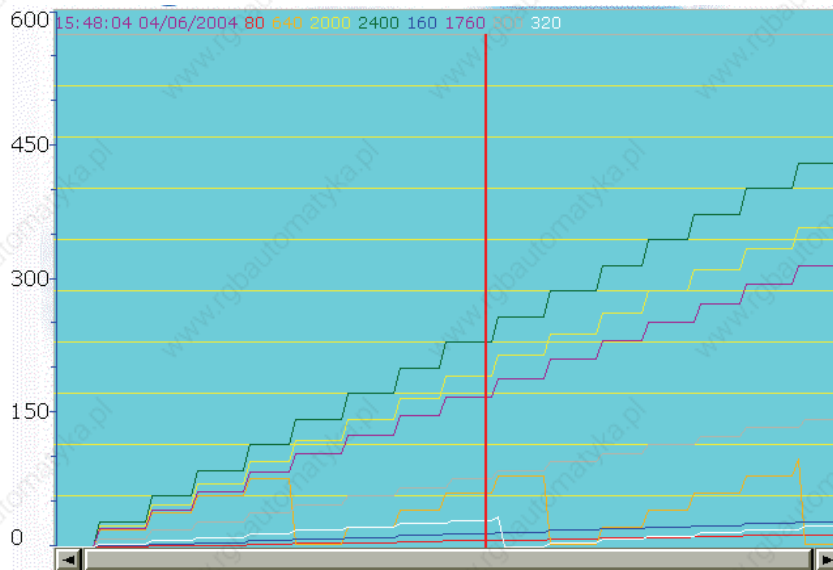


Fig. 3.12.2 Historical Trend Graph

■ Historical Data Table

Table 3.12.3 Property Description of Historical Data Table Element

Property Description of Historical Data Table Element	
Convert the history data to numeric data and display on HMI screen by a data table. The read address in the History Setup dialog box needs to be set and its data length should be in several words. The range of data length is within 1 ~ 8words. The Data No. in History Data Detail dialog will also correspond to the selected Data Length. For example, if the value of Data Length is set to 5, the Data No. selection will be 5 also. The maximum of Data Field Number is 8. This number will also be related to Data No.	
Border Color	The below element background color is set to green and its border color is set to gray.
Background Color	hh:mm:ss mm/dd/yy #####
Data Field Number	1~8 data fields can be set.

Property Description of Historical Data Table Element																	
Detail																	
Logging Buffer	Use this option to set the number (No.1 ~ No.X) of history buffer for reading the data of PLC corresponding address. The users can press the History Buffer Setup button or click "Option" > "History Setup" (Choosing History Setup command from menu bar) to set the PLC corresponding address.																
Time/Date																	
Time Format	Provide HH:MM:SS , HH:MM two kinds of formats.																
Date Format	Provide MM/DD/YY , DD/MM/YY and DD.MM.YY three kinds of formats.																
Color	When time or date format is selected, the users can use this option to designate the display color.																
Data No. (No. 1~8)																	
Data Length	There are 16bits Word and 32bits Double Word two options.																
Data Format	There are following data format provided:																
	<table border="1" style="width: 100%; border-collapse: collapse;"> <thead> <tr> <th style="width: 50%; text-align: center;">Word</th> <th style="width: 50%; text-align: center;">Double Word</th> </tr> </thead> <tbody> <tr> <td>1. BCD</td> <td>1. BCD</td> </tr> <tr> <td>2. Signed BCD</td> <td>2. Signed BCD</td> </tr> <tr> <td>3. Signed Decimal</td> <td>3. Signed Decimal</td> </tr> <tr> <td>4. Unsigned Decimal</td> <td>4. Unsigned Decimal</td> </tr> <tr> <td>5. Hex</td> <td>5. Hex</td> </tr> <tr> <td>6. Binary</td> <td>6. Binary</td> </tr> <tr> <td></td> <td>7. Floating</td> </tr> </tbody> </table>	Word	Double Word	1. BCD	1. BCD	2. Signed BCD	2. Signed BCD	3. Signed Decimal	3. Signed Decimal	4. Unsigned Decimal	4. Unsigned Decimal	5. Hex	5. Hex	6. Binary	6. Binary		7. Floating
Word	Double Word																
1. BCD	1. BCD																
2. Signed BCD	2. Signed BCD																
3. Signed Decimal	3. Signed Decimal																
4. Unsigned Decimal	4. Unsigned Decimal																
5. Hex	5. Hex																
6. Binary	6. Binary																
	7. Floating																
Data No.	<p>It is used to set the reading Word data when triggering every time. For example, if the Data Length option in the History Setup dialog box is set to 3words, there are 0 ~ 2 data numbers can be selected in this option. When selecting 1, it indicates that this Curve 1 reads the data of the <u>Read Address+1</u> set in History Setup dialog box.</p> <p>Please note that if the data format is selected as "Floating", and the Data Length option in the History Setup dialog box is an odd numbers of words, ensure to set the Data No. as an even number.</p>																

Property Description of Historical Data Table Element		
	Display Color	It is used to the display data color.
	Integral Digits	Use this option to determine the digit number of integer and decimal fraction. The digit number is not a real digit number value. It is only the display format. The digit number will be a real decimal number only when the data format is selected as "Floating".
	Fractional Digits	

Example of Historical Data Table element:

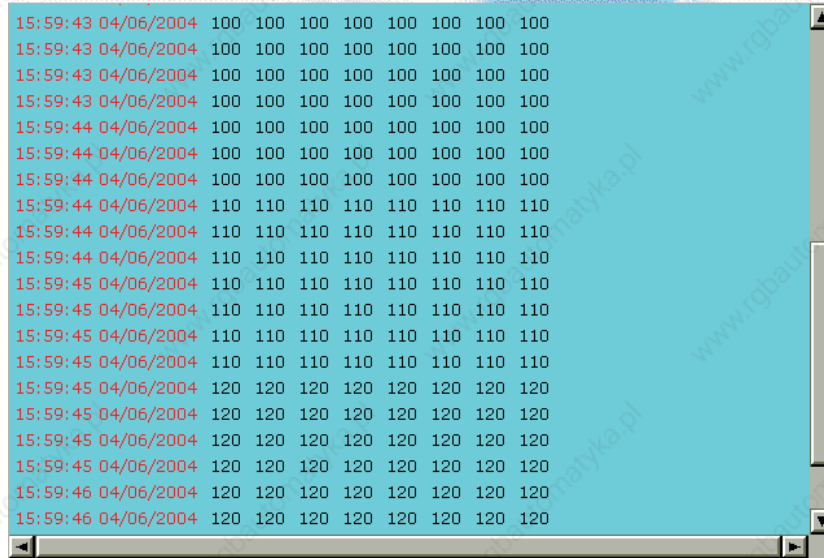

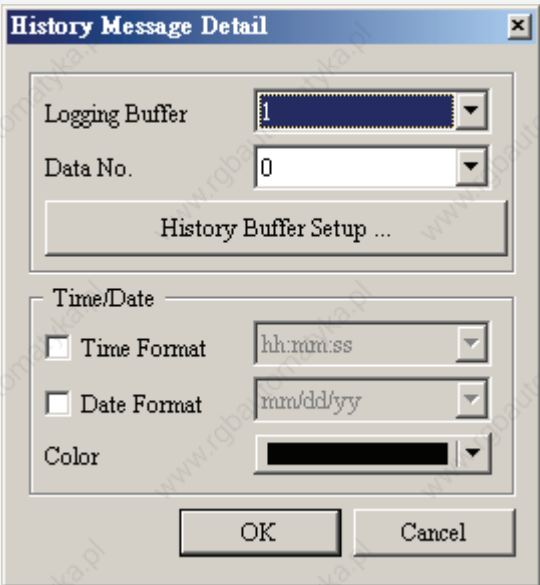


Fig. 3.12.3 Historical Data Table

■ Historical Event Table

Table 3.12.4 Property Description of Historical Event Table Element

Property Description of Historical Event Table Element		
Convert the read history data to text or character and display on HMI screen by an event table. The users can set display message, color and HMI will display message on screen after reading data.		
Text / Text Size Font / Text Color	The users can set the text, text size, font and text color that provided by Windows® to determine the text display on the element. (Please refer to Table 3.2.2 Property Description of General Buttons.) Every input message in each state will be converted to a state value. The system will list all input message in the event table.	
Border Color Background Color	The below element background color is set to light yellow and its border color is set to black. 	
Data Length	Word	It can have 256 states.
	LSB	It can have 16 states.
Data Format	This option can be set only when the data length is selected as Word. It provides BCD, Signed Decimal, Unsigned Decimal and Hex four kinds of data format to define the read memory content.	

Property Description of Historical Event Table Element	
Add/Remove State	It is used to set the state numbers of historical event table element. If the data length of the value is in Word, 1~256 states can be set. If the data length of the value is in LSB, 16 states can be set. If the data length of the value is in Bit, only 2 states can be set.
Detail	
Logging Buffer	Use this option to set the number (No.1 ~ No.X) of history buffer for reading the data of PLC corresponding address. The users can press the History Buffer Setup button or click "Option" > "History Setup" (Choosing History Setup command from menu bar) to set the PLC corresponding address.
Data No.	It is used to set the reading Word data when triggering every time. For example, if the Data Length option in the History Setup dialog box is set to 3words, there are 0 ~ 2 data numbers can be selected in this option. When selecting 1, it indicates that this Curve 1 reads the data of the <u>Read Address+1</u> set in History Setup dialog box.
Time/Date	
Time Format	Provide HH:MM:SS , HH:MM two kinds of formats.
Date Format	Provide MM/DD/YY , DD/MM/YY and DD.MM.YY three kinds of formats.
Color	When time or date format is selected, the users can use this option to designate the display color.

Example of Historical Event Table element:

1. D1000=0 X Axis servo position ready
2. D1000=1 Y Axis servo position ready
3. D1000=2 Z Axis servo position ready
4. D1000=3 Rotation Inverter Position ready
5. D1000=4 Motion controller home ready

- 6. D1000=5 Water motor over load
- 7. D1000=6 Oil pump over load

hh:mm:ss	mm/dd/yy	X Axis servo position ready
hh:mm:ss	mm/dd/yy	Y Axis servo position ready
hh:mm:ss	mm/dd/yy	Z Axis servo position ready
hh:mm:ss	mm/dd/yy	Rotation Inverter Position ready
hh:mm:ss	mm/dd/yy	Motion controller home ready
hh:mm:ss	mm/dd/yy	Water motor over load
hh:mm:ss	mm/dd/yy	Oil pump over load
hh:mm:ss	mm/dd/yy	
hh:mm:ss	mm/dd/yy	
hh:mm:ss	mm/dd/yy	
hh:mm:ss	mm/dd/yy	

Fig. 3.12.4 Historical Event Table

3.13 Alarm Element





Fig. 3.13.1 Alarm element options

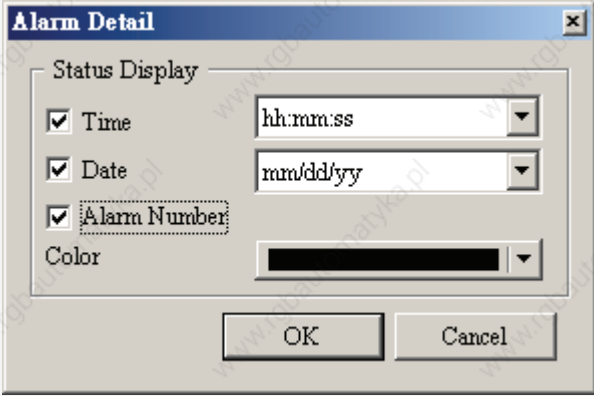
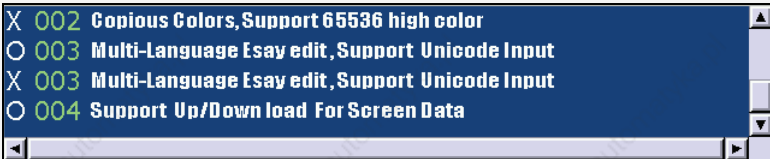
Table 3.13.1 Function of Alarm elements

Element Type	Icon	Function
Alarm History Table		HMI will monitor and read the read address in a fixed time automatically. If one Bit contact of the address is ON, the alarm message will be converted to Alarm History Table element and display on the screen.
Active Alarm List		HMI will only display the current alarm message by using Active Alarm List element on the screen if some certain Bit contact of the corresponding address is ON.
Alarm Frequency Table		HMI will monitor and read the read address set. If some certain Bit contact of the address is ON, the ON frequency of the contact will be converted to Alarm Frequency Table element and display on the screen.
Alarm Moving Sign		HMI will only display the current alarm message by using Alarm Moving Sign element on the screen if some certain Bit contact of the corresponding address is ON.

■ Alarm History Table


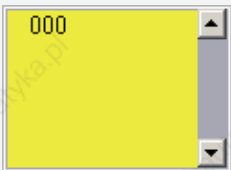
Table 3.13.2 Property Description of Alarm History Table Element

Property Description of Alarm History Table Element	
HMI will monitor and read the read address in a fixed time automatically. If one Bit contact of the address is ON, the alarm message will be converted to Alarm History Table element and display on the screen.	
Background Color	<p>The background color of the following two elements is set to white and blackish green respectively.</p> <div style="display: flex; flex-direction: column; align-items: center;"> <div style="display: flex; align-items: center; margin-bottom: 10px;">  <div style="margin-left: 10px;">The background color is set to white.</div> </div> <div style="display: flex; align-items: center;">  <div style="margin-left: 10px;">The background color is set to blackish green.</div> </div> </div>

Property Description of Alarm History Table Element																																																													
Detail																																																													
Time Format	Provide HH:MM:SS , HH:MM two kinds of formats.																																																												
Date Format	Provide MM/DD/YY , DD/MM/YY and DD.MM.YY three kinds of formats.																																																												
Alarm Number	<p>If this option is selected, when the alarm occurs, the alarm number that is designated in Alarm Setup dialog box will also be shown in front of the alarm message. Please refer to the figures below:</p> <table border="1" data-bbox="590 817 1212 1108"> <thead> <tr> <th>Number</th> <th>Message Contents</th> <th>Attribu_</th> <th>Goto Scree</th> </tr> </thead> <tbody> <tr><td>1</td><td>Delta Human Interface - DOP A Series & D_</td><td>On</td><td>None</td></tr> <tr><td>2</td><td>Copious Colors, Support 65536 high color</td><td>On</td><td>None</td></tr> <tr><td>3</td><td>Multi-Language Esay edit, Support Unicode_</td><td>On</td><td>None</td></tr> <tr><td>4</td><td>Support Up/Down load For Screen Data</td><td>On</td><td>None</td></tr> <tr><td>5</td><td>Provide Hard Copy and Typesetting Print</td><td>On</td><td>None</td></tr> <tr><td>6</td><td></td><td></td><td></td></tr> <tr><td>7</td><td></td><td></td><td></td></tr> <tr><td>8</td><td></td><td></td><td></td></tr> <tr><td>9</td><td></td><td></td><td></td></tr> <tr><td>10</td><td></td><td></td><td></td></tr> <tr><td>11</td><td></td><td></td><td></td></tr> <tr><td>12</td><td></td><td></td><td></td></tr> <tr><td>13</td><td></td><td></td><td></td></tr> <tr><td>14</td><td></td><td></td><td></td></tr> </tbody> </table> 	Number	Message Contents	Attribu_	Goto Scree	1	Delta Human Interface - DOP A Series & D_	On	None	2	Copious Colors, Support 65536 high color	On	None	3	Multi-Language Esay edit, Support Unicode_	On	None	4	Support Up/Down load For Screen Data	On	None	5	Provide Hard Copy and Typesetting Print	On	None	6				7				8				9				10				11				12				13				14			
Number	Message Contents	Attribu_	Goto Scree																																																										
1	Delta Human Interface - DOP A Series & D_	On	None																																																										
2	Copious Colors, Support 65536 high color	On	None																																																										
3	Multi-Language Esay edit, Support Unicode_	On	None																																																										
4	Support Up/Down load For Screen Data	On	None																																																										
5	Provide Hard Copy and Typesetting Print	On	None																																																										
6																																																													
7																																																													
8																																																													
9																																																													
10																																																													
11																																																													
12																																																													
13																																																													
14																																																													
Color	When time or date format is selected, the users can use this option to designate the display color.																																																												

■ Active Alarm List

Table 3.13.3 Property Description of Active Alarm List Element

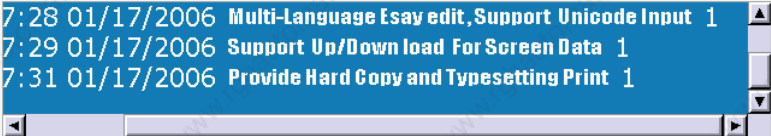
Property Description of Active Alarm List Element	
HMI will only display the current alarm message by using Active Alarm List element on the screen if some certain Bit contact of the corresponding address is ON.	
Background	<p>The background color of the following two elements is set to white and yellow respectively.</p>  <p>The background color is set to white.</p>  <p>The background color is set to yellow.</p>

Property Description of Active Alarm List Element	
Detail	
Time Format	Provide HH:MM:SS , HH:MM two kinds of formats.
Date Format	Provide MM/DD/YY , DD/MM/YY and DD.MM.YY three kinds of formats.
Alarm Number	<p>If this option is selected, when the alarm occurs, the alarm number for the alarm message will always be shown ahead. Please refer to the figures below:</p>
Color	When Time and Date these two options are selected, the users can designate the display color by using this option.

■ Alarm Frequency Table














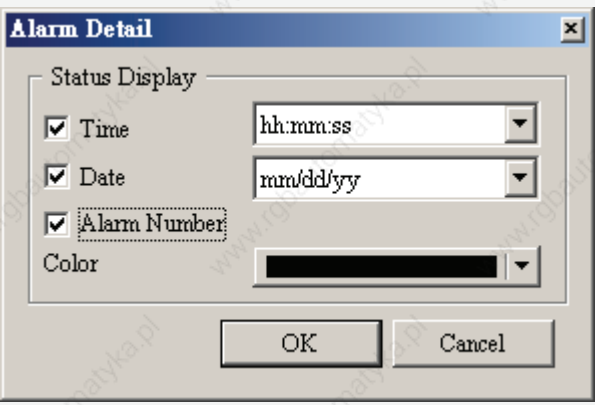
Table 3.13.4 Property Description of Alarm Frequency Table Element

Property Description of Alarm Frequency Table Element	
<p>HMI will monitor and read the read address set. If some certain Bit contact of the address is ON, the ON frequency of the contact will be converted to Alarm Frequency Table element and display on the screen.</p>	
Background Color	<p>The background color of the following two elements is set to white and yellow respectively.</p> <div style="display: flex; flex-direction: column; align-items: center;"> <div style="display: flex; align-items: center; margin-bottom: 10px;"> <div style="border: 1px solid gray; padding: 5px; margin-right: 10px;">000</div> <div style="text-align: center;">The background color is set to white.</div> </div> <div style="display: flex; align-items: center;"> <div style="border: 1px solid gray; padding: 5px; margin-right: 10px;">000</div> <div style="text-align: center;">The background color is set to yellow.</div> </div> </div>
Detail	

Property Description of Alarm Frequency Table Element	
Time Format	Provide HH:MM:SS , HH:MM two kinds of formats.
Date Format	Provide MM/DD/YY , DD/MM/YY and DD.MM.YY three kinds of formats.
Alarm Number	<p>If this option is selected, when the alarm occurs, the time and date when the alarm occurred will also be shown in front of the alarm message. Please refer to the figure below:</p>  <p>The screenshot shows a list of three alarm messages. Each message is preceded by its time and date: 7:28 01/17/2006, 7:29 01/17/2006, and 7:31 01/17/2006. The messages are: 'Multi-Language Esay edit, Support Unicode Input 1', 'Support Up/Down load For Screen Data 1', and 'Provide Hard Copy and Typesetting Print 1'.</p>
Display for Counting Zero	Use this option to decide if show the message on the Alarm Frequency Table element or not when the occurring times of the alarm message is zero.
Color	When Time and Date these two options are selected, the users can designate the display color by using this option.

■ Alarm Moving Sign

Table 3.13.5 Property Description of Alarm Moving Sign Element

Property Description of Alarm Moving Sign Element									
HMI will only display the current alarm message by using Alarm Moving Sign element on the screen if some certain Bit contact of the corresponding address is ON.									
Border Color Background Color	<p>The background color of the element below is set to blue green and its border color is set to red.</p> 								
Style	<table border="1"> <thead> <tr> <th>Standard</th> <th>Raised</th> <th>Sunken</th> <th>Transparent</th> </tr> </thead> <tbody> <tr> <td></td> <td></td> <td></td> <td></td> </tr> </tbody> </table>	Standard	Raised	Sunken	Transparent				
Standard	Raised	Sunken	Transparent						
									
Moving Points	It is used to set the movement of the moving sign. The unit is Pixel and the range is within 1 ~ 50 Pixels.								
Interval(ms)	It is used to set the interval time between two movements. The unit is ms and the range is within 50 ~ 3000 ms.								
Detail									
Time	Provide HH:MM:SS and HH:MM two kinds of display format.								

Property Description of Alarm Moving Sign Element	
Date	Provide MM/DD/YY, DD/MM/YY and DD.MM.YY three kinds of display format.
Alarm Number	<p>If this option is selected, when the alarm occurs, the alarm number that is designated in Alarm Setup dialog box will also be shown in front of the alarm message. Please refer to the figures below:</p> <div style="border: 1px solid black; background-color: #003366; color: white; padding: 2px; text-align: center; margin: 5px 0;"> 004 Support Up/Down load For Screen Data </div>
Color	When Time and Date these two options are selected, the users can designate the display color by using this option.

3.14 Graphic Element

Maybe the users need some graphics that are not provided. Therefore, the following basic graphic elements are for the users to create their own graphs or drawings.

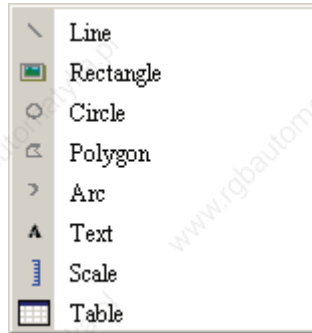


Fig. 3.14.1 Graphic element options


■ Line

Table 3.14.1 Property Description of Line Graphic Element

Property Description of Line Graphic Element	
<p>Left-click the mouse to draw and edit the line graphic element. The users can click where the users want to start the line and drag across the work place on the screen. Then, release the mouse to finish the line. When selecting this line graphic element, the users can see a rectangle range and this is designed for the users to move and adjust the line more quickly and conveniently. The users can set line color, size and style in property table freely. The range out of the line graphic element itself will be displayed in transparent color.</p>	
Line Color	It is used to set the display color of the line element.
Line Size	The unit is Pixel and the range is within 1 ~ 8.
Line Style	<p>There are following line styles can be selected.</p>


■ Rectangle


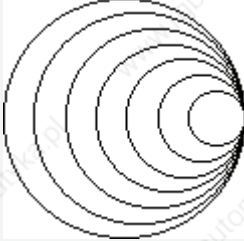
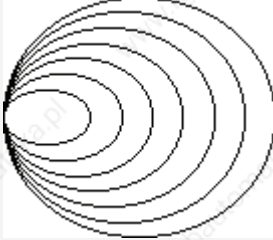
Table 3.14.2 Property Description of Rectangle Graphic Element

Property Description of Rectangle Graphic Element	
Left-click the mouse to draw and edit the rectangle graphic element. The users can drag the mouse across work place on the screen until the rectangle is the size that the users want. Then, release the mouse to finish. The users can import the picture into the rectangle from picture bank and set rectangle color, size and style in property table. This option is a good choice for the users who just need to import some certain picture on the screen simply.	
Line Color	It is used to set the display color of the rectangle element.
Picture Bank Name Picture Name	(Please refer to Table 3.2.2 Property Description of General Buttons.)
Transparent Effect Transparent Color	(Please refer to Table 3.2.2 Property Description of General Buttons.)
Foreground Color	It is used to set the display color of the rectangle graphic element.
Line Size	The unit is Pixel and the range is within 1 ~ 8.
Transparent	When this option is selected, the element will display only with the border and there is no color in the element. The Foreground Color option will be disabled also.
Round Radius	0~38 pixels round radius are provided for selection. 

■ Circle

Table 3.14.3 Property Description of Circle Graphic Element




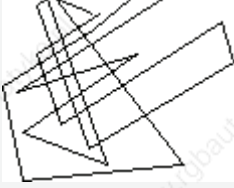
Property Description of Circle Graphic Element	
The users can draw an ellipse or circle by using this option. The users can drag the mouse across work place on the screen until the ellipse or circle is the size that the users want. Then, release the mouse to finish. If the width and height of the circle graphic element are the same size, the circle graphic element will be a round shape circle. If the width and height of the circle graphic element are not the same size, it will be an ellipse element. When selecting this circle graphic element, the users can see a rectangle range and this is designed for the users to move and adjust the circle more quickly and conveniently. Changing the size of the rectangle range is changing the size of circle graphic element directly. The range out of the circle graphic element itself will be displayed in transparent color. There is a “Transparent” option in the element property table. Once Yes is selected, the element will display only with the border and there is no color in the element. If there is any other element under this circle graphic element, it will show up and can be viewed on the screen.	
	An ellipse that its “Transparent” setting in the property table is set to “No”.

Property Description of Circle Graphic Element	
	An circle that its "Transparent" setting in the property table is set to "No".
	An circle that its "Transparent" setting in the property table is set to "Yes".
	An ellipse that its "Transparent" setting in the property table is set to "Yes".
Line Color	It is used to set the line color of the circle graphic element.
Foreground Color	It is used to set the display color of the circle graphic element.
Line Size	The unit is Pixel and the range is within 1 ~ 8.
Transparent	When this option is selected, the element will display only with the border and there is no color in the element. The Foreground Color option will be disabled also.

■ Polygon

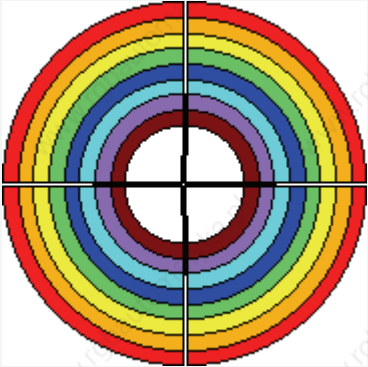
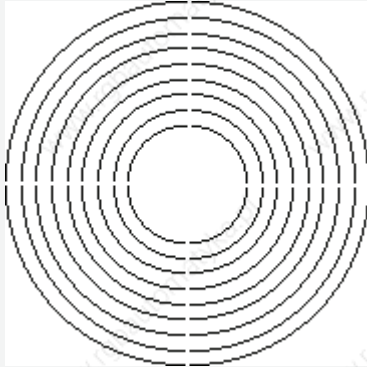
Table 3.14.4 Property Description of Polygon Graphic Element

Property Description of Polygon Graphic Element	
<p>Left-click the mouse to determine each node of the polygon graphic element. The users can click where the users want to place the first node and drag the mouse across work place on the screen until the next node is decided and left-click the mouse again to determine the position of the next node. Repeat the above action until the polygon is the size that the users want. Then, right-click the mouse the mouse to finish. When selecting this polygon graphic element, the users can see a rectangle range and this is designed for the users to move and adjust the polygon more quickly and conveniently. Changing the size of the rectangle range is changing the size of circle graphic element directly. The range out of the circle graphic element itself will be displayed in transparent color. There is a "Transparent" option in the element property table. Once Yes is selected, the element will display only with the border and there is no color in the element. If there is any other element under this circle graphic element, it will show up and can be viewed on the screen.</p>	
Line Color	It is used to set the line color of the polygon graphic element.

Property Description of Polygon Graphic Element	
Foreground	<p>It is used to set the display color of the polygon graphic element. Please refer to the figures below:</p> <div style="display: flex; justify-content: space-around; align-items: center;">   </div> <p>The foreground color is set to blue. The foreground color is set to turquoise.</p>
Line Size	<p>The unit is Pixel and the range is within 1 ~ 8.</p>
Transparent	<p>When this option is selected, the element will display only with the border and there is no color in the element. The Foreground Color option will be disabled also. Please refer to the figures below:</p> <div style="display: flex; justify-content: space-around; align-items: center;">  <div style="text-align: center;"> <p>A polygon that its "Transparent" setting in the property table is set to "No".</p> </div> </div> <div style="display: flex; justify-content: space-around; align-items: center; margin-top: 20px;">  <div style="text-align: center;"> <p>A polygon that its "Transparent" setting in the property table is set to "Yes".</p> </div> </div>

■ Arc

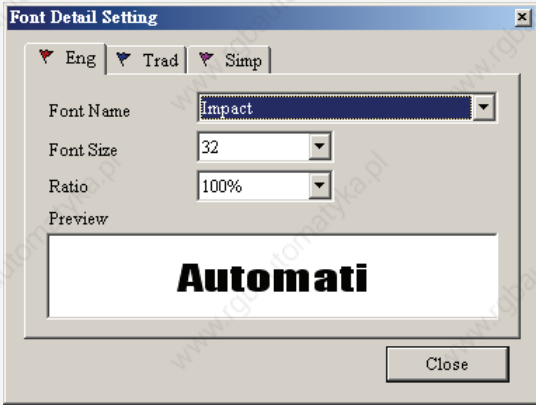

Table 3.14.5 Property Description of Arc Graphic Element

Property Description of Arc Graphic Element	
<p>Left-click the mouse to draw and edit the arc graphic element. The users can click where the users want to start the arc and drag across the work place on the screen. Then, release the mouse to finish the arc. There is a "Transparent" option in the element property table. If this option is set to Yes, it indicates that this element is an arc. If this option is set to No, it indicates that this element is a sector. The range out of the circle graphic element itself will be displayed in transparent color.</p>	
<div style="display: flex; justify-content: space-around; align-items: center;">   </div> <p>When "Transparent" is set to "No" When "Transparent" is set to "Yes".</p>	
Line Color	<p>It is used to set the line color of the arc graphic element.</p>
Foreground Color	<p>It is used to set the display color of the arc graphic element.</p>
Line Size	<p>The unit is Pixel and the range is within 1 ~ 8.</p>

Property Description of Arc Graphic Element	
Transparent	When this option is selected, the element will display only with the border and there is no color in the element. The Foreground Color option will be disabled also.

■ Text

Table 3.14.6 Property Description of Text Graphic Element



Property Description of Text Graphic Element	
<p>This text graphic element is used to create a text frame, and add and edit the text on the screen. The users can drag the mouse across work place on the screen until the text frame is the size that the users want and release the mouse to finish. Then, add and edit the text in the text frame. The foreground color is the color of the text frame (“Transparent” should be set to “No”).</p>	
<p>Text Text Size Font Text Color</p>	<p>The users can set the text, text size, font and text color that provided by Windows® to determine the text display on the element. When the users press ... button next to “Font”, the following “Font Detail Setting” dialog box will display.</p>  <p>In “Font Detail Setting” dialog box, the users can select Font Name, Font Size and Ratio of the text and view the text format from the Preview window in advance. If the multi-language function is used, the users can see different language tabs and edit different language font setting in “Font Detail Setting” dialog box. Please refer to the example figure above.</p>
Foreground Color	<p>It is used to set the text frame color. Please refer to the figure below. The foreground color of this text graphic element is set to blue.</p> 
Transparent	When this option is selected, the element will display the text only and there is no color in the element. The Foreground Color option will be disabled also.

■ Scale

Table 3.14.7 Property Description of Scale Graphic Element

Property Description of Scale Graphic Element	
<p>The users can change the scale direction, main and sub scale number, and grid color in the property table to create a special and unique scale graphic element. The “Display Mark” option can be used to determine if the scale value display next to the scale or not. The minimum and maximum of the scale value can be set in “Detail Setup” option.</p>	

Property Description of Scale Graphic Element													
Text Size Text Color	The users can set the text size and text color that provided by HMI to determine the text display on the element. HMI provides 8~70 kinds of default text font for the users to use.												
Style	<table border="1"> <thead> <tr> <th>Standard</th> <th>Rotation 90</th> <th>Rotation 180</th> <th>Rotation 270</th> </tr> </thead> <tbody> <tr> <td></td> <td></td> <td></td> <td></td> </tr> </tbody> </table>	Standard	Rotation 90	Rotation 180	Rotation 270								
Standard	Rotation 90	Rotation 180	Rotation 270										
Main Scale	<p>Please refer to the figures below:</p> <div style="display: flex; justify-content: space-around;"> <div style="text-align: center;"> When main scale number is set to 2 </div> <div style="text-align: center;"> When main scale number is set to 3 </div> </div>												
Display Mark	It is used to determine if the scale value display next to the scale or not.												
Detail Setup	<div style="text-align: center;"> </div> <table border="1"> <tr> <td>Date Length</td> <td>There are 16bits Word and 32bits Double Word two options.</td> </tr> <tr> <td>Data Format</td> <td>There are following data format provided: Word/Double Word 1. BCD 2. Signed Decimal 3. Unsigned Decimal</td> </tr> <tr> <td>Minimum</td> <td rowspan="2">The users can set the minimum and maximum of input setting value to determine the range of input setting value.</td> </tr> <tr> <td>Maximum</td> </tr> <tr> <td>Integral Digits</td> <td rowspan="2">Use this option to determine the digit number of integer and decimal fraction. The digit number is not a real digit number value. It is only the display format. The digit number will be a real decimal number only when the data format is selected as "Floating".</td> </tr> <tr> <td>Fractional Digits</td> </tr> <tr> <td colspan="2">When the users have input the minimum and maximum value, after pressing OK button, HMI will examine the value by referring to the selected data length, data format, integral and fractional digits.</td> </tr> </table>	Date Length	There are 16bits Word and 32bits Double Word two options.	Data Format	There are following data format provided: Word/Double Word 1. BCD 2. Signed Decimal 3. Unsigned Decimal	Minimum	The users can set the minimum and maximum of input setting value to determine the range of input setting value.	Maximum	Integral Digits	Use this option to determine the digit number of integer and decimal fraction. The digit number is not a real digit number value. It is only the display format. The digit number will be a real decimal number only when the data format is selected as "Floating".	Fractional Digits	When the users have input the minimum and maximum value, after pressing OK button, HMI will examine the value by referring to the selected data length, data format, integral and fractional digits.	
Date Length	There are 16bits Word and 32bits Double Word two options.												
Data Format	There are following data format provided: Word/Double Word 1. BCD 2. Signed Decimal 3. Unsigned Decimal												
Minimum	The users can set the minimum and maximum of input setting value to determine the range of input setting value.												
Maximum													
Integral Digits	Use this option to determine the digit number of integer and decimal fraction. The digit number is not a real digit number value. It is only the display format. The digit number will be a real decimal number only when the data format is selected as "Floating".												
Fractional Digits													
When the users have input the minimum and maximum value, after pressing OK button, HMI will examine the value by referring to the selected data length, data format, integral and fractional digits.													
Grid Color	It is used to set the grid color of the scale graphic element.												

Property Description of Scale Graphic Element	
SubScale Number	<p>When the main scale number is set to 3 and the subscale number is also used, the scale graphic element will display as the figures below:</p> <div style="display: flex; justify-content: space-around; align-items: flex-end;"> <div style="text-align: center;">  <p>When subscale number is set to 1</p> </div> <div style="text-align: center;">  <p>When main scale number is set to 2</p> </div> </div>

■ Table

Table 3.14.8 Property Description of Table Graphic Element


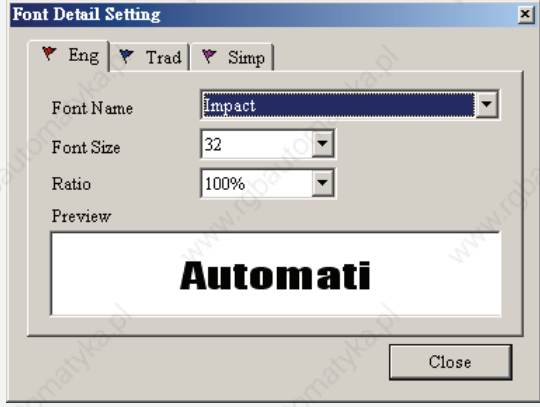


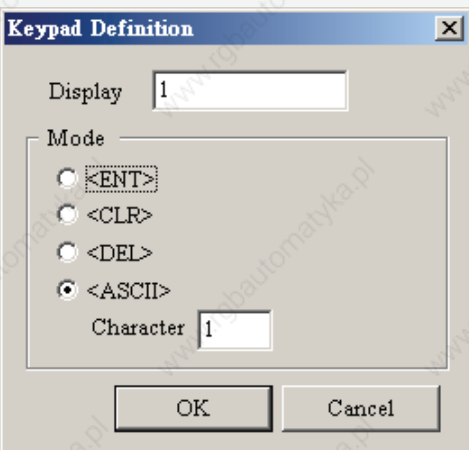
Property Description of Table Graphic Element						
<p>The users can change the cell numbers of the table, appearance and color in the property table to create a special and unique table graphic element. If it is used with other elements, each element will display more completely on the screen.</p>						
Background Color	It is used to set the display color of the table scale element.					
Detail Setup						
	Header	<table border="1"> <tr> <td>Row Header</td> <td>It is used to the color of the first row of the table. The users can enable or disable this option by checking the check box next to "Row Header".</td> </tr> <tr> <td>Col Header</td> <td>It is used to the color of the first column of the table. The users can enable or disable this option by checking the check box next to "Col Header".</td> </tr> </table>	Row Header	It is used to the color of the first row of the table. The users can enable or disable this option by checking the check box next to "Row Header".	Col Header	It is used to the color of the first column of the table. The users can enable or disable this option by checking the check box next to "Col Header".
	Row Header	It is used to the color of the first row of the table. The users can enable or disable this option by checking the check box next to "Row Header".				
	Col Header	It is used to the color of the first column of the table. The users can enable or disable this option by checking the check box next to "Col Header".				
	Interlacing	Rows	It is used to the color of the interlacing rows of the table. The users can enable or disable this option by checking the check box next to "Rows".			
		Columns	It is used to the color of the interlacing rows of the table. The users can enable or disable this option by checking the check box next to "Rows".			
Row Header		It is used to the color of the interlacing row header of the table. The users can enable or disable this option by checking the check box next to "Row Header".				
Columns Header		It is used to the color of the interlacing column header of the table. The users can enable or disable this option by checking the check box next to "Columns Header".				

Property Description of Table Graphic Element			
	Cell Setting	Sep. Rows Evenly	It is used to distribute rows of the table evenly.
		Sep. Col Evenly	It is used to distribute columns of the table evenly.
Border Color	It is used to set the border color of the table.		
Grid Color	It is used to set the grid color of the table.		
Number of Rows	The range is within 1 ~ 99.		
Number of Columns	The range is within 1 ~ 99.		

3.15 Keypad Element

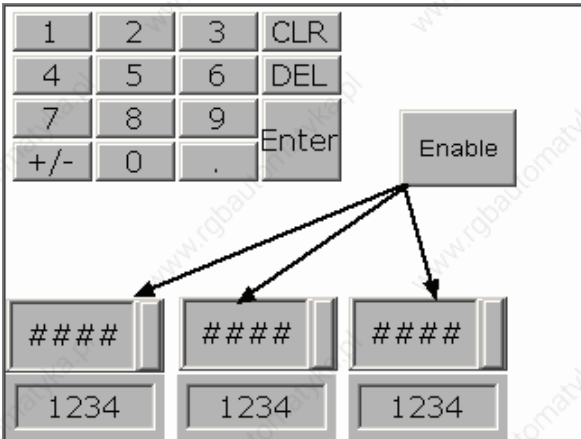
Table 3.15.1 Property Description of Keypad Element

Property Description of Keypad (1) / (2) / (3) Element																																																																
Provide three kinds of default keypad elements for selection. The users can select decimal, hexadecimal or character these three kinds of keypad according to difference application requirement.																																																																
<table border="1"> <tr><td>1</td><td>2</td><td>3</td><td>CLR</td></tr> <tr><td>4</td><td>5</td><td>6</td><td>DEL</td></tr> <tr><td>7</td><td>8</td><td>9</td><td>Enter</td></tr> <tr><td>+/-</td><td>0</td><td>.</td><td></td></tr> </table>				1	2	3	CLR	4	5	6	DEL	7	8	9	Enter	+/-	0	.						<table border="1"> <tr><td>0</td><td>1</td><td>2</td><td>3</td><td>CLR</td></tr> <tr><td>4</td><td>5</td><td>6</td><td>7</td><td>DEL</td></tr> <tr><td>8</td><td>9</td><td>A</td><td>B</td><td>Enter</td></tr> <tr><td>C</td><td>D</td><td>E</td><td>F</td><td></td></tr> </table>					0	1	2	3	CLR	4	5	6	7	DEL	8	9	A	B	Enter	C	D	E	F																	
1	2	3	CLR																																																													
4	5	6	DEL																																																													
7	8	9	Enter																																																													
+/-	0	.																																																														
0	1	2	3	CLR																																																												
4	5	6	7	DEL																																																												
8	9	A	B	Enter																																																												
C	D	E	F																																																													
Keypad (1) Decimal Keypad				Keypad (2) Hexadecimal Keypad																																																												
<table border="1"> <tr><td>1</td><td>2</td><td>3</td><td>4</td><td>5</td><td>6</td><td>7</td><td>8</td><td>9</td><td>0</td><td>-</td><td>=</td><td>CLR</td></tr> <tr><td>Q</td><td>W</td><td>E</td><td>R</td><td>T</td><td>Y</td><td>U</td><td>I</td><td>O</td><td>P</td><td>[</td><td>]</td><td>DEL</td></tr> <tr><td>A</td><td>S</td><td>D</td><td>F</td><td>G</td><td>H</td><td>J</td><td>K</td><td>L</td><td>;</td><td>,</td><td>`</td><td>Enter</td></tr> <tr><td>Z</td><td>X</td><td>C</td><td>V</td><td>B</td><td>N</td><td>M</td><td>,</td><td>.</td><td>/</td><td>\</td><td></td><td></td></tr> </table>													1	2	3	4	5	6	7	8	9	0	-	=	CLR	Q	W	E	R	T	Y	U	I	O	P	[]	DEL	A	S	D	F	G	H	J	K	L	;	,	`	Enter	Z	X	C	V	B	N	M	,	.	/	\		
1	2	3	4	5	6	7	8	9	0	-	=	CLR																																																				
Q	W	E	R	T	Y	U	I	O	P	[]	DEL																																																				
A	S	D	F	G	H	J	K	L	;	,	`	Enter																																																				
Z	X	C	V	B	N	M	,	.	/	\																																																						
Keypad (3) Character Keypad																																																																
The users can redefine the display text of each button shown on the keypad. The other buttons, such as <ENT> (Enter), <CLR> (Clear), (Delete) and <ASCII> (Input Character) can also be renamed flexibly. Please refer to the following figure below:																																																																
The keypad is displayed in a "Group" on the screen. The users can use "Ungroup" command from "Edit" menu bar to ungroup all the buttons. Then, the users move and change the button size freely. At this time, the users can redefine the display text shown on the button in the property table. When the "Text" option is inputted as number "1", the display text on the button will be "1". If the users refine it as number "2", the display text will be changed to "2". If it is refined as character "A", the display text will be changed to "A". If it is changed to character "%", the display text will be changed to "%" and vice versa.																																																																
The input character will be sent to <u>Active Numeric Entry</u> element or <u>Active Character Entry</u> element. For these two kinds of elements, the users have to set the <u>Input Mode</u> as "Active" option and set <u>InterLock Address</u> . Please refer to Table 3.10.2 & Table 3.10.3 for the property description of Numeric / Character Entry elements.																																																																

Property Description of Keypad (1) / (2) / (3) Element					
Text Text Size Font Text Color	<p>The users can set the text, text size, font and text color that provided by Windows® to determine the text display on the element. When the users press  button next to "Font", the following "Font Detail Setting" dialog box will display.</p>  <p>In "Font Detail Setting" dialog box, the users can select Font Name, Font Size and Ratio of the text and view the text format from the Preview window in advance. If the multi-language function is used, the users can see different language tabs and edit different language font setting in "Font Detail Setting" dialog box. Please refer to the example figure above.</p>				
Picture Bank Name Picture Name	(Please refer to Table 3.2.2 Property Description of General Buttons.)				
Transparent Effect Transparent Color	(Please refer to Table 3.2.2 Property Description of General Buttons.)				
Foreground Color Style	<p>There are Standard and Raised these two options.</p>  <p>(When the style is selected as Standard and the foreground color is set to green.)</p>  <p>(When the style is selected as Raised and the foreground color is set to red.)</p>				
Detail Setup	<p>The users can redefine the buttons of the keypad</p>  <table border="1"> <thead> <tr> <th>Display</th> <th>Display text or character</th> </tr> </thead> <tbody> <tr> <td>Mode</td> <td> <p>The are following modes provided::</p> <ol style="list-style-type: none"> 1. <ENT> Enter 2. <CLR> Clear 3. Delete 4. <ASCII> Character </td> </tr> </tbody> </table>	Display	Display text or character	Mode	<p>The are following modes provided::</p> <ol style="list-style-type: none"> 1. <ENT> Enter 2. <CLR> Clear 3. Delete 4. <ASCII> Character
Display	Display text or character				
Mode	<p>The are following modes provided::</p> <ol style="list-style-type: none"> 1. <ENT> Enter 2. <CLR> Clear 3. Delete 4. <ASCII> Character 				

Example for Creating a Keypad Element:

1. Create the following elements first



The created elements are: one Keypad (1) element, one Momentary button, three numeric entry elements and three numeric display elements.

2. Related Element Property Description

Element	Property Description
Keypad (1)	Reserve the default value. The users can also change the display text.
Momentary button	The write address is set to Internal memory \$10.1. The main function is used to enable the following numeric entry elements and let them receive the input value.
Numeric Entry (Left)	<p>The write address is set to Internal memory \$0, Input Mode is set to Active and the InterLock Address is set to \$10.1. When the Momentary button is pressed, the numeric entry element will prepare to receive the input value. After the users press the Enter button, the numeric entry element will blink and it indicates that the numeric entry element is receiving the input value. When the value is received completely, the numeric entry element will stop blinking. In the figure below, the Numeric Entry (Left) will blink first. When the input value is transferred to the next element, the next element will blink next and vise versa.</p> <p>Please refer to the following figure:</p> <p>The element blinking order is determined by the order of creating elements.</p>
Numeric Entry (Middle)	The write address is set to Internal memory \$1, Input Mode is set to Active and the InterLock Address is set to \$10.1.
Numeric Entry (Right)	The write address is set to Internal memory \$2, Input Mode is set to Active and the InterLock Address is set to \$10.1.
Numeric Display (Left)	The read address is set to Internal memory \$0.
Numeric Display (Middle)	The read address is set to Internal memory \$1.
Numeric Display (Right)	The read address is set to Internal memory \$2.

This page intentionally left blank.

Chapter 4 Macro Function

Macro editing is a function in which allows the users to perform programming like programming in BASIC language. It provides the same language syntax as BASIC. It can also reduce the PLC program editing. Therefore, Macro is a very convenient function for the HMI users to use. After editing Macro, the users can test the Macro validity via either on-line simulation or off-line simulation on PC before downloading to HMI. The lines number for each macro is 512 lines and 128 words (max.) for writing comments or strings in a line. The sub-macro number is 512 sub-macros (number is 1-512). See Fig. 4.1 and Fig. 4.2.

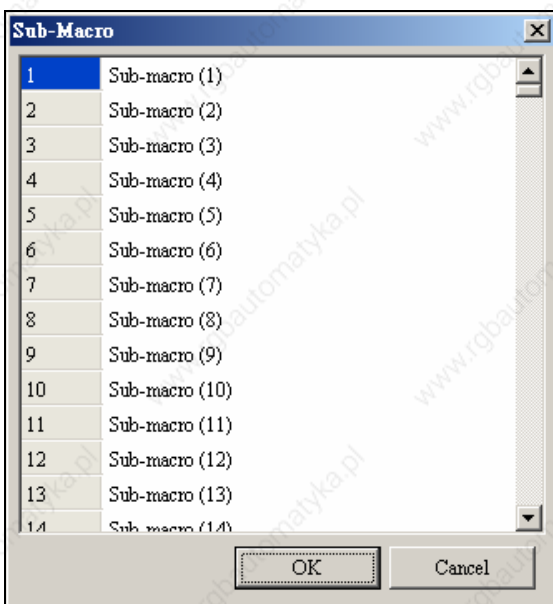


Fig. 4.1

The users can comment each macro by sub-macro function for the convenience of management, maintain and operation. The initial name of all sub-macro is Sub-macro (n) (n is from 1 to 512).

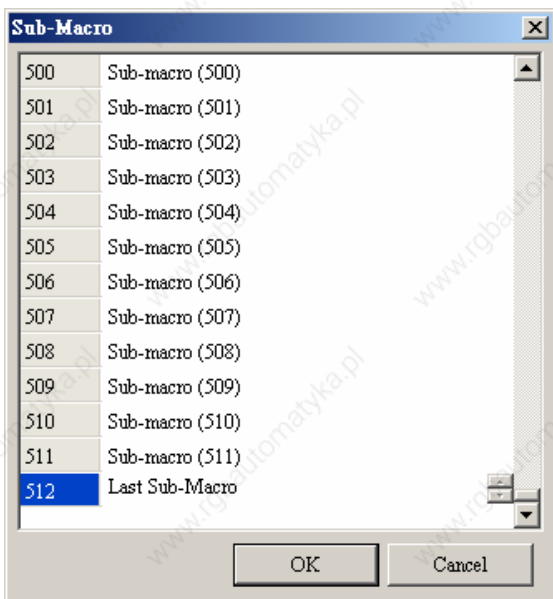


Fig. 4.2

The left-most field in the left window is sub-macro number. There are 512 sub-macros for editing. The users can write "CALL n (n is from 1 to 512)" to use sub-macro.

4.1 Macro Type

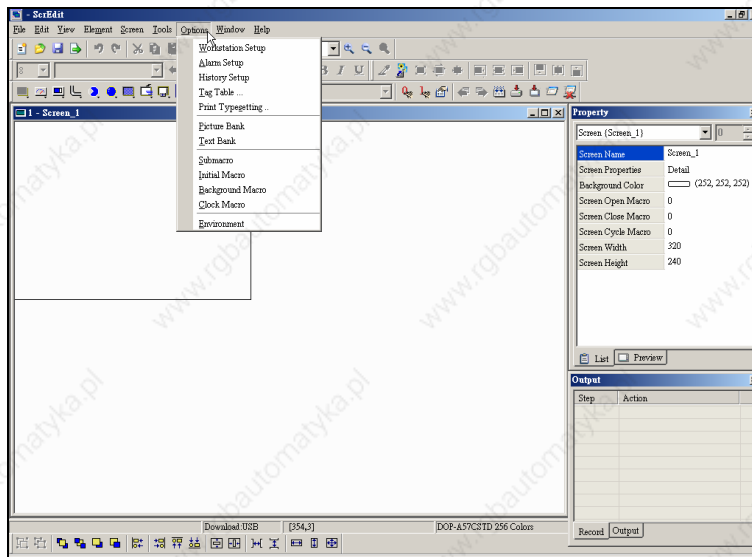


Fig. 4.1.1 Choosing Macro command from menu bar

Macro Name	Numbers	Remark
Screen open Macro	1	There is a screen open macro for each screen. Therefore, there are n screen open macros for n screen.
Screen close Macro	1	There is a screen close macro for each screen. Therefore, there are n screen close macros for n screen.
Screen Cycle Macro	1	There is a screen cycle macro for each screen. Therefore, there are n screen cycle macros for n screen
Initial Macro	1	There is only an initial Macro in a program.
Background Macro	1	There is only an background Macro in a program.
Clock Macro	1	There is only an clock Macro in a program.
On Macro	1	The users can have an ON Macro for each specific button.
Off Macro	1	The users can have an OFF Macro for each specific button.
Sub-macro	512	There are only 512 sub-macros for a program.

Table 4.1.1 Macro command table

■ **Screen Open Macro**

The users can use open Macro to open each screen. Screen Open Macro will only be executed ONCE when you open screen (or switch to new screen) and finish execution ONCE. The screen element will be displayed after finishing executing Screen Open Macro. Therefore, the users need to pay close attention on designing Screen Open Macro to avoid infinite loop (program cannot be ended) as it may cause system delay or even cannot execute screen's elements permanently. It is not recommended to write too long macro unless necessary. Please pay close attention on loop usage and test Macro with on-line/off-line simulation before downloading to HMI.

■ **Screen Close Macro**

The users can use close Macro to close each screen. Screen Close Macro will only be executed ONCE when you close screen and finish execution ONCE. The Screen Open Macro of new screen will be only executed after finishing Screen Close Macro. Therefore, the users should also be careful for infinite loop (program cannot be ended) to avoid unexpected error.

■ **Screen Cycle Macro**

The users can use cycle Macro to cycle each screen. Screen Cycle Macro will only be executed ONCE when you change screen and the macro will be executed continuously until the screen is changed, program or machine is stopped. Therefore, it is not recommended to write too long macro unless necessary.

■ **Initial Macro**

There is only one initial Macro in a program or a machine. It is executed in the beginning of program. The users can preset value to omit step-by-step settings and also control initial setting to avoid unexpected problem by unknown initial value. If the users need to setup any special setting in PLC special address, the users can use initial macro to set it. It saves much time with well-designed initial macro.

■ **Background Macro**

There is only one initial Macro in a program or a machine. It will be executed continuously like background. But the execution of Background Macro is to execute one or more commands at a time, not finish the execution ONCE. If there is other executed Macro, such as cycle macro, it won't have any influences. They are executed almost simultaneously (In fact, it is executed one by one physically. Since the execution time is so quick, it makes people feel that is executed simultaneously). The users do not need to write loop for continuous execution. Even the users writes END command for Macro it will still execute Macro again.

■ **Clock Macro**

There is only an initial Macro in a program or a machine. It will be executed continuously, finish the execution ONCE and be executed again like cycle macro. Therefore, the same, it is not recommended to write too long macro unless necessary.

■ **On Macro**

The users can use ON Macro for each specific button (Bit). It is called ON Macro because this start Macro is set to ON via setting the button (Bit). This Macro is also executed ONCE and finished executing ONCE. It will be started again when this button (Bit) is set to be ON again. The ON Macro will be only started when the button (Bit) is set to be ON and pressed button to be ON.

■ Off Macro

The users can use OFF Macro for each specific button (Bit). Same as ON Macro, OFF Macro is started via setting this button (Bit). This Macro is also executed ONCE and finished executing ONCE. It will be started again when this button (Bit) is set to be OFF again. The OFF Macro will be only started when the button (Bit) is set to be OFF and pressed button to be OFF.

■ Sub-macro

There are 512 sub-macros for editing. Sub-macro is similar to the subroutine in the in program. The users can write repeated action or function in sub-macro to save macro editing time and easy maintain. That means the users can write a sub-macro to make it functions as a specific 10 sub-macros. For example, a function is written named sub-macro 1, the users only need to write "CALL 1" in Macro whenever it is used. In this case, the users need only modify this sub-macro instead of modifying 10 macros if necessary. The sub-macro can be named by its function for easy management.

4.2 Macro Editing

After choosing the desired Macro command from menu bar, the users can start editing Macro by clicking any line shown as Fig. 4.2.1 below. The Macro command dialog box will pop up when any line is clicked. The Macro editing window will be different by clicking position. For the users' convenience, the most left number is line number.

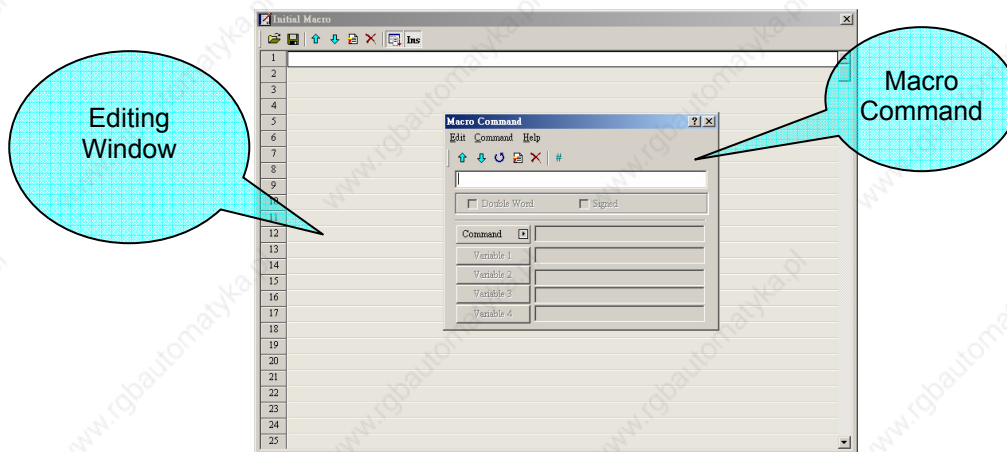


Fig. 4.2.1 Start editing Macro

The users can also use the icons on the toolbars (Fig. 4.2.2) for Macro editing.

Refer to Fig. 4.2.3, 512 lines (from 1 to 512) are available for editing Macro. Blank line in the program means that line will be set to comment line after updating as shown in Fig. 4-2-4.

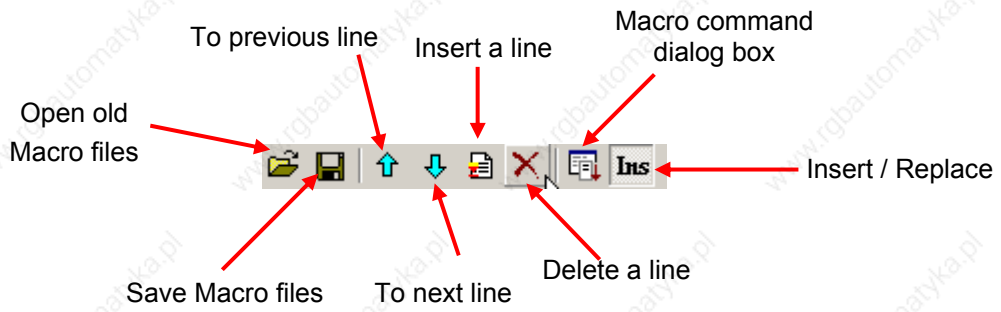


Fig. 4.2.2 Toolbar

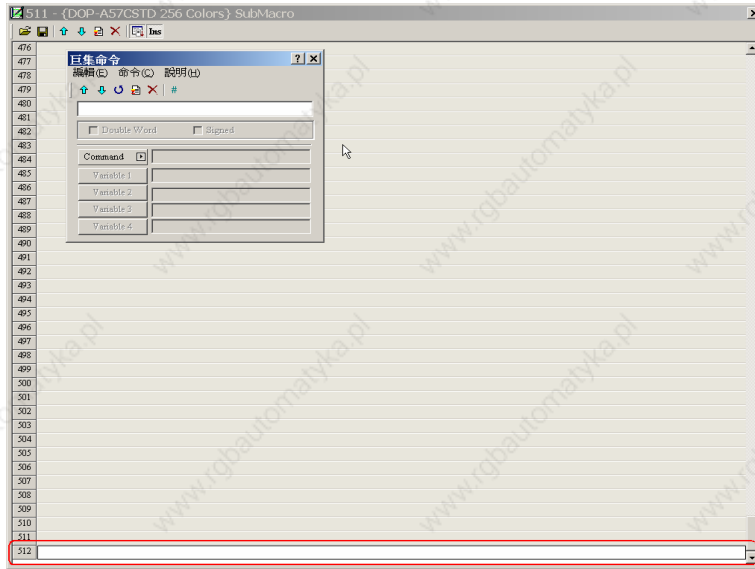


Fig. 4.2.3 Last line of Macro

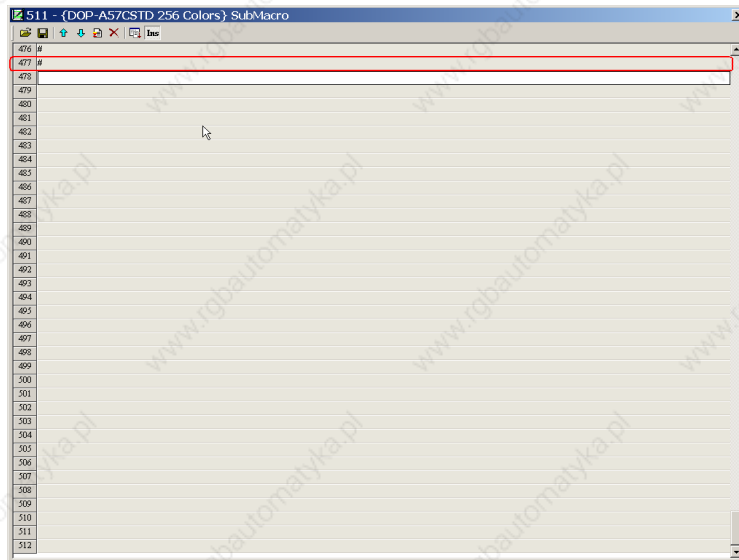


Fig. 4.2.4 Blank line becomes comment line

Once the editing Macro starts, the Macro command editing window will pop up (Fig. 4.2.5) by clicking any lines in the Macro. The users can determine the command that the users need by pressing the command button or clicking command from menu bar. Then, the users only need to move the mouse cursor to the position of the command and all the commands will display. At this time, the users can start to edit Macro. Refer to the following sections for Macro editing methods.

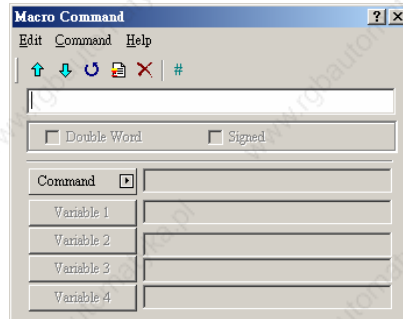


Fig. 4.2.5 Macro command editing window

- **File**

- **Open Macro**

ScrEdit provides open old macro function for the convenience of editing macro. The users can open old Macro files when using any PLC brand to save Macro editing time without re-input. Refer to Fig. 4.2.6 for Open Macro window.

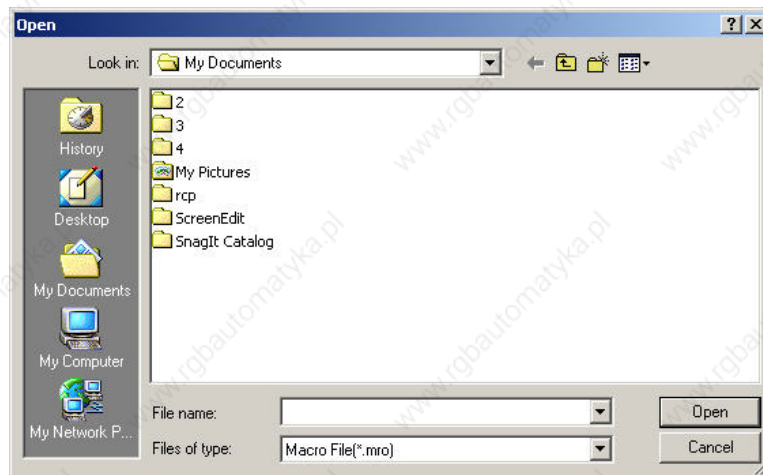


Fig. 4.2.6 Open Macro

- **Save As Macro**

ScrEdit also provides “Save As” function for the users to modify old macro and save macro as other macro to backup or save re-input time of other macro commands.

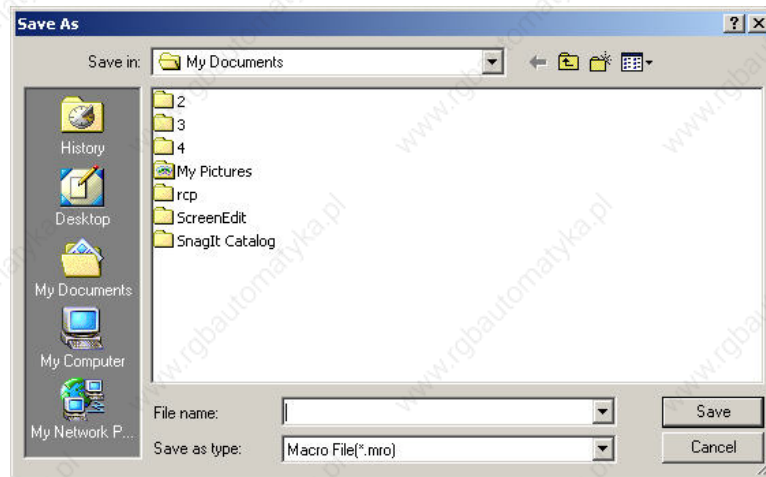


Fig. 4.2.7 Save As Macro

■ **Edit**

The users can edit Macro via edit option in Macro Command dialog box. If it is PLC address, it will be in bracket to distinguish with internal memory.

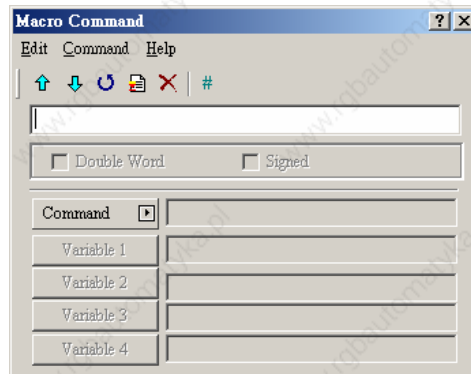


Fig. 4.2.8 Edit

■ **Previous**

Previous

Move the selected line to the upper line of macro and the upper line of macro will move backward a line.

■ **Next**

Next

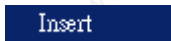
Move the selected line to the lower line of macro and the lower line of macro will move forward a line.

■ **Update**



Update the current line of macro. The modification will not be updated if “update” is not pressed after editing. This gives user a second chance to decide to modify or not. Therefore, if the users forget to update after editing, the users should re-do again.

■ **Insert**



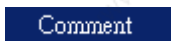
Insert the editing macro between two lines of macro. After inserting a new line, the existing line of macro will move backward a line.

■ **Delete**



Delete the selected line. Lines after the delete line will be pushed upward after delete.

■ **Comment**



Any comments or equations can be given for any lines to read/modify macro easily. The users can choose the desired text, characters or any symbols from menu bar or toolbar.

■ **Command**

The users can use commands to edit the macro. No matter the command and equation all can be typed directly, or chosen from menu bar, or be selected by clicking button “Command”. For the detailed options of Command, please see Fig. 4.2.9 to Fig. 4.2.18.



Fig. 4.2.9
Commands options

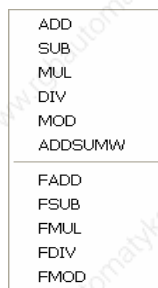


Fig. 4.2.10
Arithmetic

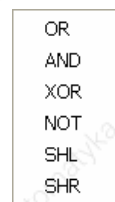


Fig. 4.2.11
Logical



Fig. 4.2.12
Data transfer

BCD	XCHG
BIN	MAX
W2D	MIN
B2W	A2H
W2B	H2A
SWAP	FCNV
	ICNV

Fig. 4.2.13
Data conversion

IF ... THEN GOTO ▶
IF ... ▶
ELSEIF ... ▶
ELSE
ENDIF
FCMP

Fig. 4.2.14
Comparison

GOTO
LABEL
CALL
RET
FOR
NEXT
END

Fig. 4.2.15
Flow control

SETB
CLRB
INVB
GETB

Fig. 4.2.16
Bit setting

INITCOM
ADDSUM
XORSUM
PUTCHARS
GETCHARS
SELECTCOM
CLEARCOMBUFFER
CHRCHKSUM

Fig. 4.2.17
Communication

Time Tick
GETLASTERROR
註解
Delay
GETSYSTEMTIME
SETSYSTEMTIME
GETHISTORY

Fig. 4.2.18
Others

■ Keypad

For the convenience of editing macro, ScrEdit allows the users to edit Macro by using keypad (key in manually). ScrEdit will check the validity automatically. If there are any errors, a warning dialog box will pop up to remind the users. There are no limit spaces between operand and operation symbol for the users to key in. After finishing inputting, ScrEdit will convert the macro to the best format automatically after updating the macro or pressing Enter key. But please notice that ScrEdit has not verified the macro yet at this time.

4.3 Macro Operation

■ Definition

WORD	16 Bit data (It is made up of continuous 2 bytes, i.e. 16 bits, b15~b0. It can be used to represent 0000~FFFF of hexadecimal system.)
DWORD, DW	32 Bit data (It is made up of continuous 2 words, i.e. 32 bits, b31~b0. It can be used to represent 00000000~FFFFFFFF of hexadecimal.)
BYTE	8 Bit data (It is made up of continuous 2 nibbles, i.e. 8 bits, b7~b0. It can be used to represent 00~FF of hexadecimal system.)
Signed	A signed value is a numeric value with polarity. It means that the value is interpreted as essentially the 'plus' sign that can be found in front of a positive number and the 'minus' sign that can be found in front of a negative number.

■ **Arithmetic Operation**

Arithmetic Operation divides into two parts: Integer Operation and Floating Point Operation.

Each operand can be internal memory or constant. But it shall be internal memory only when outputting.

Please refer to following table 4.3.1 and examples below for more information.

Command	Equation	Description	Remark	
Integer Operation	+	$V1=V2 + V2$	Addition	The calculation result can be stored as signed or unsigned WORD and DWORD. When the data exceeds the length of designated unit, the data out of range will be discarded.
	-	$V1=V2 - V3$	Subtraction	
	*	$V1 = V2 * V3$	Multiplication	
	/	$V1 = V2 / V3$	Division	
	%	$V1 = V2 \% V3$	Get Remainder	
Floating Point Operation	FADD	$V1=FADD(V2, V3)$	Addition	Floating Point Operation is the operation of signed 32 Bit data.
	FSUB	$V1=FSUB(V2, V3)$	Subtraction	
	FMUL	$V1=FMUL(V2, V3)$	Multiplication	
	FDIV	$V1=FDIV(V2, V3)$	Division	
	FMOD	$V1=FMOD(V2, V3)$	Get Remainder	

Table 4.3.1 Arithmetic command table

■ **+, FADD**

Addition

Equation: $V1 = V2 + V3[(Signed | DW)]$

$V1 = FADD(V2, V3) (Signed DW)$

Perform the addition on V2 and V3, and store the addition result in V1.

Example:

The value contained within the internal memory address #2 plus 1

$$\$2 = \$2 + 1$$

The values contained within the internal memory address #1 and #2 are combined and the total is stored in the address #3.

$$\$3 = \$2 + \$1$$

The value contained within the internal memory address #4 plus 1.9

$$\$4 = FADD(\$4, 1.9)$$

The floating point values contained within the internal memory address #4 and #5 are combined and the total is stored in the address #6.

$$\$6 = FADD(\$5, \$4)$$

■ -, FSUB

Subtraction

Equation: $V1 = V2 - V3[(Signed | DW)]$

$V1 = FSUB(V2, V3) (Signed DW)$

Perform the subtraction of V2 and V3, and store the subtraction result in V1.

Example :

Subtract 1 from the value contained within the internal memory address #2

$\$2 = \$2 - 1$

The value contained within the internal memory address #1 is subtracted from the value contained within the internal memory address #2 and the result of this calculation is stored in the internal memory address #3.

$\$3 = \$2 - \$1$

Subtract 1.9 from the value contained within the internal memory address #4

$\$4 = FSUB(\$4, 1.9)$

The floating point value contained within the internal memory address #4 is subtracted from the floating point value contained within the internal memory address #5 and the result of this calculation is stored in the internal memory address #6.

$\$6 = FSUB(\$5, \$4)$

■ *, FMUL

Multiplication

Equation: $V1 = V2 * V3[(Signed | DW)]$

$V1 = FMUL(V2, V3) (Signed DW)$

Perform the multiplication of V2 and V3, and store the multiplication result in V1.

Example:

The value contained within the internal memory address #2 multiplied by 2

$\$2 = \$2 * 2$

The value contained within the internal memory address #2 multiplied by #1 and the result of this calculation is stored in the address #3.

$\$3 = \$2 * \$1$

The value contained within the internal memory address #4 multiplied by 1.5

$\$4 = FMUL(\$4, 1.5)$

The floating point value contained within the internal memory address #4 multiplied by #5 and the result of this calculation is stored in the address #6.

$\$6 = FMUL(\$5, \$4)$

■ /, FDIV

Division

Equation: $V1 = V2 / V3[(Signed | DW)]$

$V1 = FDIV(V2, V3) (Signed DW)$

Perform the division of V2 and V3, and store the division result in V1. The value contained within V3 cannot be equal to 0(zero).

Example:

Subtract 1 form the value contained within the internal memory address #2

$\$2 = \$2 - 1$

The value contained within the internal memory address #2 divided by 5 and the result of this calculation is stored in the address #3.

$\$3 = \$2 / 5$

Subtract 1.9 form the value contained within the internal memory address #4

$\$4 = FSUB(\$4, 1.9)$

The value contained within the internal memory address #4 divided by 4.3 and the result of this calculation is stored in the address #6.

$\$6 = FDIV(\$4, 4.3)$

■ %, FMOD

Get Remainder

Equation: $V1 = V2 \% V3[(Signed | DW)]$

$V1 = FMOD(V2, V3) (Signed DW)$

Perform the division of V2 and V3, and store the remainder in V1. The value contained within V3 cannot be equal to 0(zero).

Example:

Subtract 1 form the value contained within the internal memory address #2

$\$2 = \$2 - 1$

The value contained within the internal memory address #2 divided by 5 and the remainder of the result of this calculation is stored in the address #3.

$\$3 = \$2 \% 5$

Subtract 1.9 form the value contained within the internal memory address #4

$\$4 = FSUB(\$4, 1.9)$

The value contained within the internal memory address #4 divided by 4 and the remainder of the result of this calculation is stored in the address #6.

$\$6 = FMOD(\$4, 4)$

■ ADDSUMW

Repeated Addition

Equation: $V1 = \text{ADDSUMW}(V2, V3)[(DW)]$

Perform the addition on V2, V2+1, V2+2, ..., V2+V3, and store the repeated addition result in V1.

Example:

\$2 = 1

\$3 = 2

\$4 = 3

\$5 = 3

\$0 = ADDSUMW(\$2, \$5)

Add up the values contained within the internal memory address #2, #3, #4 and #5 (3 Words started from address #2) and the grand total is stored in the address #0. The value of the grand total is equal to 6.

■ Logical Operation

Six logical operations includes OR, AND, XOR, NOT, Shift-left and Shift-right. SHR. There are three operands for each operation. Each operand can be internal memory or constant. But it shall be internal memory only when outputting. The unit can be Word and Double Word. Please refer to following table 4.3.2 and examples below for more information.

Command	Equation	Description	Remark
	$V1 = V2 V3$	Logical OR operation	The calculation result can be stored as WORD and DWORD.
&&	$V1 = V2 \&\& V3$	Logical AND operation	
^	$V1 = V2 \wedge V3$	Logical XOR operation	
NOT	$V1 = \text{NOT } V2$	Logical NOT operation	
<<	$V1 = V2 \ll V3$	Logical Shift-left operation	
>>	$V1 = V2 \gg V3$	Logical Shift-right operation	

Table 4.3.2 Logical operation command table

■ | Operand

Logical OR operation

Equation: $V1 = V2 | V3[(DW)]$

Perform the logical OR operation on V2 and V3 and save the result of this calculation in V1.

Example:

\$2 = F000H

\$4 = 0F00H

\$2 = \$2 | \$4

Store the result of \$2 in FF00H

■ **&& Operand**

Logical AND operation

Equation: $V1 = V2 \&\& V3[(DW)]$

Perform the logical AND operation on V2 and V3 and save the result of this calculation in V1.

Example:

\$2 = F000H

\$4 = 0F00H

\$2 = \$2 && \$4

Store the result of \$2 in 0000H

■ **^ Operand**

Logical XOR operation

Equation: $V1 = V2 \wedge V3[(DW)]$

Perform the logical XOR operation on V2 and V3 and save the result of this calculation in V1.

Example:

\$2 = F100H

\$4 = 0F00H

\$2 = \$2 ^ \$4

Store the result of \$2 in FE00H

■ **NOT**

Logical NOT operation

Equation: $V1 = \text{NOT } V2 [(Signed | DW)]$

Perform the logical NOT operation on V2 and V3 and save the result of this calculation in V1.

Example:

\$2 = F100H

\$4 = NOT \$2

Store the result of \$\$ in 0EFFH

■ **<< Operand**

Logical Shift-left operation

Equation: $V1 = V2 \ll V3[(DW)]$

Shift V2 (WORD/DWORD) data to left (number of bit is V3). The result of this calculation is stored in V1.

Example:

\$2 = F100H

\$2 = \$2 << 4

\$2 shift-left 4 bits and becomes 1000H

■ >> Operand

Logical Shift-right operation

Equation: V1 = V2 >> V3[(DW)]

Shift V2 (WORD/DWORD) data to right (number of bit is V3). The result of this calculation is stored in V1.

Example:

\$2 = F100H

\$2 = \$2 >> 4

\$2 shift-right 4 bits and becomes 0F10H

■ Data Transfer

There are five commands for data transfer, including =, BMOV, FILL, CHR and FMOV. Please refer to following table 4.3.3 and examples below for more information.

Command	Equation:	Description	Remark
=	V1 = V2	Transfer data	Data type for V1 only can be P, M
BMOV	BMOV(V1, V2, V3)	Block move	Data type for A1 and A2 only can be P, M
FILL	FILL(V1, V2, V3)	Fill the memory	
CHR	CHR(V1, "V2")	Convert text to ASCII code	V2 is a input string of texts
FMOV	V1 = FMOV(V2)	Transfer floating point data	

P- PLC address, M- Internal memory, C- Constant

Table 4.3.3 Data transfer command table

■ = Operand

Transfer data

Equation: V1 = V2[(Signed DW | DW)]

Transfer data from V2 to V1. No data change within A2 after executing MOV command.

Example:

The data within the internal memory address \$0 is designated the constant 4.

\$0 = 4

The data within the internal memory address #4 is designated the same as the data within the internal memory address \$2.

\$4 = \$2

■ BMOV

Block move Copy Block

Equation: BMOV(V1, V2, V3)

BMOV (V1, V2, V3) means to move data (number of word is A3) of data from address V2 to address V1 in block. Data format is word. If the block length is more than internal memory or max number of PLC register, there will be error when compiling.

Example:

Move the data in \$0, \$1, \$2, \$3, \$4 to \$10, \$11, \$12, \$13 in order. Total the same 4 Words.

\$0 = 1

\$1 = 2

\$2 = 3

\$3 = 4

BMOV(\$10, \$1, 4)

After executing BMOV command, \$10=1, \$11=2, \$12=3, \$13=4.

■ FILL

Fill the Memory

Equation: FILL(V1, V2, V3) [(Signed)]

FILL(V1, V2, V3) means to fill address V1 with data in address V2 and the data number is V3. If the block length is more than internal memory or max number of PLC register, there will be error when compiling.

Example:

\$5 = 10

FILL(\$0, \$5, 4)

Executing FILL command to fill \$0, \$1, \$2, \$3 with constant 10.

■ CHR

Convert Text to ASCII code

Equation: CHR(V1, "V2")

CHR(V1, "V2") means to convert text in address V2 to ASCII code and store in V1. The max length is 128 words.

Example:

CHR(\$1, "AB12")

After executing CHR command, 4241H will be stored in \$1 and 3130H will be stored in \$2.

■ FMOV

Transfer Floating Point Data

Equation: $V1 = \text{FMOV}(V2)$ (Signed DW)

Transfer floating point data from V2 to V1. No data change within V2 after executing FMOV command.

Example:

Transfer constant 44.3 to the internal memory address \$0.

$\$0 = \text{FMOV}(44.3)$ (Signed DW)

Transfer the same data of PLC 1@X0 to the internal memory address \$0.

$\$0 = \text{FMOV}(1@X0)$ (Signed DW)

■ Data Conversion

Command	Equation	Description
BCD	$V1 = \text{BCD}(V2)$	Converts BIN Data into BCD
BIN	$V1 = \text{BIN}(V2)$	Decimal value conversion
W2D	$V1 = \text{W2D}(V2)$	Convert WORD to DWORD
B2W	$V1 = \text{B2W}(V2, V3)$	Convert BYTE to WORD
W2B	$V1 = \text{W2B}(V2, V3)$	Convert WORD to BYTE
SWAP	$\text{SWAP}(V1, V2, V3)$	Swap BYTE data
XCHG	$\text{XCHG}(V1, V2, V3)$	Exchange data
MAX	$V1 = \text{MAX}(V2, V3)$	Get Maximum value
MIN	$V1 = \text{MIN}(V2, V3)$	Get Minimum value
A2H	$V1 = \text{A2H}(V2)$	Convert ASCII code to 4-digit integer
H2A	$V1 = \text{H2A}(V2)$	Convert hexadecimal integer to ASCII code
FCNV	$V1 = \text{FCNV}(V2)$	Convert integer to floating point value
ICNV	$V1 = \text{ICNV}(V2)$	Convert floating point value to integer

Table 4.3.4 Data conversion command table

■ BCD

Convert BIN Data into BCD value

Equation: $V1 = \text{BCD}(V2)$ [(DW)]

The binary data in V2 is converted into BCD value, and stored in V1.

Example:

The binary data in \$4 is 5564. After executing BCD command, the binary data in \$4 is converted to 5564H.

$\$4 = 5564$

$\$4 = \text{BCD}(\$4)$

■ **BIN**

Converts BCD Data into BIN value

Equation: $V1 = \text{BIN}(V2) [(DW)]$

The BCD data in V2 is converted into BCD value, and stored in V1.

Example:

The BCD (hexadecimal) data in \$4 is 5564H. After executing BIN command, the BCD data in \$4 is converted to 5564.

\$4 = 5564H

\$4 = BIN(\$4)

■ **W2D**

Convert WORD to DWORD

Equation: $V1 = \text{W2D}(V2) [\text{Signed}]$

The WORD value in V2 is converted into DWORD value, and stored in V1.

Example:

The WORD value in decimal format in \$4 is -7. After executing W2D command, the value in \$7 is converted to -7.

\$4 = -7

\$7 = W2D(\$4)(Signed)

■ **B2W**

Convert BYTE to WORD

Equation: $V1 = \text{B2W}(V2, V3)$

Convert BYTE data (number of byte is V3) from V2 to WORD value and store the result in V1.

The high byte will be filled with 0. In other words, that each word of V2 is two bytes. These two bytes will be converted to two words and stored in V1.

Example:

Assume that the value of \$65534 is 12. That means converting 12 BYTES (6 WORDS) to 12 WORDS from \$785 and store the result in \$10 to \$21.

\$10=B2W(\$785, \$65534)

■ **W2B**

Convert WORD to BYTE

Equation: $V1 = \text{W2B}(V2, V3)$

Convert WORD data (number of word is V3) from low-byte of V2 to BYTE format (discard high-byte of V2) and store the result in V1.

Assume that the value of \$985 is 12. It means to read 12 WORDS from low-byte of \$986 and convert these 12 WORDS to 12 BYTES (6 WORDS) and store the result in \$65 to \$70.

\$65= W2B(\$986, \$985)

■ SWAP

Swap BYTE Data

Equation: **SWAP (V1, V2, V3)**

Swap high-byte and low-byte of V2, V2+1, V2+2...V2+V3 (WORD) and store the result in the starting position of V1, V1+1, V1+2...V1+V3 in order.

Example:

Swap the high-byte and low-byte of \$10, \$11, ..., \$14 and store the result in \$1, \$2, ..., \$5 in order.

SWAP(\$1, \$10, 5)

If \$11 = 1234H, after executing SWAP command, \$2 = 3412H.

■ XCHG

Exchange Data

Equation: **XCHG (V1, V2, V3)[(DW)]**

Exchange the data of V2, V2+1, V2+2...V2+V3 and the data of V1, V1+1, V1+2..., V1+V3. The data of V1 and V2 will be exchanged after executing XCHG command.

Example:

Exchange the data of \$10, \$11, ..., \$14 and the data of \$1, \$2, ..., \$5 in order.

XCHG(\$1, \$10, 5)

If \$11 = 1234H and \$2 = 5678H, \$2 = 1234H and \$1 = 5678H after executing XCHG command.

■ MAX

Get Maximum Value

Equation: **V1 = MAX(V2, V3)[(Signed DW | DW)]**

Get the maximum value from V2 and V3 and store the result in V1.

Example:

\$0 = 0

\$1 = 2

\$2 = 10

\$0 = MAX(\$1, \$2)

The result → \$0 = 10

■ **MIN**

Get Minimum Value

Equation: $V1 = \text{MIN}(V2, V3)[(\text{Signed DW} | \text{DW})]$

Get the minimum value from V2 and V3 and store the result in V1.

Example:

\$0 = 0

\$1 = 2

\$2 = 10

\$0 = MIN(\$1, \$2)

The result → \$0 = 2

■ **A2H**

Converts 4 ASCII code to a four digits integer in hexadecimal format

Equation: $V1 = \text{A2H}(V2)$

Convert the ASCII code of V2 (4 WORDS) to integer and store the result in V1.

Example:

\$10 = 0034H

\$11 = 0033H

\$12 = 0036H

\$13 = 0038H

\$1 = A2H(\$10)

After executing A2H command, the data in \$1 will be converted to 4368H.

■ **H2A**

Converts four digits integer in hexadecimal format to 4 ASCII code

Equation: $V1 = \text{H2A}(V2)$

Convert V2 (1 WORD in hexadecimal format) to the ASCII (4 WORDS) code and store the result in V1.

Example:

\$2 = 1234H

\$10 = H2A(\$2)

After executing H2A command, \$10=0031H, \$11=0032H, \$12=0033H and \$13=0034H.

■ **FCNV**

Convert integer to floating point value

Equation: V1= FCNV (V2)(Signed DW)

Convert floating point value or integer in V2 to floating point value and store in V1.

Example:

\$2 = 100

\$1 = FCNV(\$2)(Signed DW)

The result → \$1 = 100.0

■ **ICNV**

Convert floating point value to integer

Equation: V1= ICNV (V2)

Convert floating point value or integer in V2 to integer and store in V1.

Example:

FMOV(\$2, 100.5)

\$1 = ICNV (\$2)(Signed DW)

The result → \$1 = 100

■ **Comparison**

■ **IF...THEN GOTO LABEL ...**

Equation: IF expression THEN GOTO LABEL identifier

If the command of expression is true, then it will go to LABEL identifier perform the program.

Please refer to the following table for the command of expression.

Command	Description	Remark
V1 == V2	V1 is equal to V2	V1 and V2 should be internal memory or constant.
V1 != V2	V1 is not equal to V2	
V1 > V2	V1 is greater than V2	
V1 >= V2	V1 is greater than or equal to V2	
V1 < V2	V1 is smaller than V2	
V1 <= V2	V1 is smaller than or equal to V2	
V1 && V2 == 0	Perform AND command on V1 andV2 and the result of AND operation is equal to 0	
V1 && V2 != 0	Perform AND command on V1 andV2 and the result of AND operation is not equal to 0	
V1== ON	V1 is ON	
V1== OFF	V1 is OFF	

Table 4.3.5 Comparison command table

Example:

When \$2 is greater than or equal to 10, it will go to LABEL 1 and continue to perform the program.

```
IF $2 >= 10 THEN GOTO LABEL 1
```

```
.....
```

```
LABEL 1
```

```
.....
```

Equation: IFB V1 == {ON | OFF} THEN GOTO LABEL identifier

If V1 is ON or OFF, it will go to LABEL identifier to perform the program. V1 is PLC address.

Example:

```
IFB 1@X0 == ON THEN GOTO LABEL 1
```

■ IF...THEN CALL ...

Equation: IF V1 == V2 THEN CALL macro

If V1 is equal to V2, it will call macro. V1 and V2 should be internal memory or constant.

Example

If \$2 is equal to 10, then it will call sub-macro 1.

```
IF 10 = $2 THEN CALL 1
```

■ IF...ELSE...ENDIF

Equation:

```
IF expression1
```

```
Statement1
```

```
ELSEIF expression2
```

```
Statement2
```

```
ELSE
```

```
Statement3
```

```
ENDIF
```

This is logical determination from multiple conditions. If expression1 is true, Statement1 will be executed. If expression1 is false, it will run expression2. If expression 2 is true, Statement2 will be executed. If both expression 1 and expression 2 are false, Statement3 will be executed.

For the command of expression, please refer to table 4.3.5 (Comparison command table).

Example

If \$1 is smaller than 100, \$1 = \$1 + 1 is executed. Otherwise \$1 = \$1 + 10 is executed.

IF \$1 < 100

\$1 = \$1 + 1

ELSE

\$1 = \$1 + 10

ENDIF

■ Flow Control

There are five types for flow control: GOTO, LABEL, CALL..RET, FOR...NEXT and END.

■ GOTO

Unconditionally go to a specific Label. GOTO command will jump to designated label like Label V1 unconditionally.

Equation: GOTO LABEL V1

Go to the internal designated Label V1 in the program unconditionally.

Example:

Go to the position of designated Label 2 and continue to execute the program unconditionally.

GOTO LABEL 2

.....

LABEL 2

■ LABEL

Label such as Label V1

Equation: LABEL V1

Please notice that the label cannot be repeated in a Macro.

Example:

Go to the position of designated Label 2 and continue to execute the program unconditionally.

GOTO LABEL 2

.....

LABEL 2

.....

The Label 2 is repeated. An error will occur at this time to warn the users to indicate it is illegal.

LABEL 2

.....

■ **CALL..RET**

Call Sub-macro program

Equation: CALL V1

V1 represents the sub-macro number. The sub-macro number could be 001 ~ 512 and V1 should be internal memory address or constant.

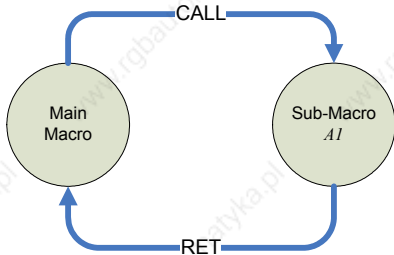


Fig. 4.3.1

The rights of macro control will be transferred to sub-macro after CALL V1 command is executed. V1 needs to return through RET command. RET command will transfer the rights of macro control to the next command of CALL command. The sub-macro number could be 001 ~ 512 and the users also can name it freely. In the sub-macro program, the users also can CALL another sub-macro but the levels for CALL sub-macro should be less than 6 levels due to memory limit and also for avoiding unexpected error.

■ **FOR...NEXT**

Program Loop

Equation:

FOR V1

Statement

NEXT

It is for nested loops. "FOR" is the start of loop and "NEXT" is the end of loop. The nested loop can up to 5 levels max. V1 can be the internal memory or constant. When this command is executed, the number of V1 Statement will be executed continuously. Statement is the combination of a section of macro commands and also can be within the nested loop. The users can change V1 value through command, but the number of times cannot be changed.

Example:

\$10 = 10

\$1 = 0

FOR \$10

\$1 = \$1 + 1

\$10 = 2

NEXT

After the operation, the result is \$1 = 10, \$10 = 2.

Please notice that the loop times will not change even the users reset the value within \$10.

■ **END**

End the macro

Equation:

Statements1

END

Statements2

End command is used to end the macro program. Statements2 will not be executed after Statements1 is executed. The program will execute from the command of the first line next time. Please notice that END means finishing executing macro. If END command is used in sub-macro, it indicates the program is end here.

Example:

\$1 = 10

\$1 = \$1 + 1

END

\$1 = \$1 + 1

After the operation, the result is \$1 = 11, not \$1 = 12 as the END command has ended the macro program.

■ **Bit Setting**

There are four settings for BIT settings: SETB, CLRBL, INVB and GETB.

Command	Equation	Description
SETB	SETB V1	Set V1 Bit to be ON
CLRBL	CLRB V1	Set V1 Bit to be OFF
INVB	INVB V1	Set V1 Bit to be inversed
GETB	V1 = GETB V2	Get V2 Bit value and store in V1

Table 4.3.6 Bit setting command table

■ **SETB**

Sets specific bit to be ON.

Equation: SETB V1

Set V1 Bit to be ON

Example:

Set a value of 0 to the 0 number of bit within the internal memory \$0.

\$0 = FFFEh

SETB \$0.0

The result → \$0 = FFFFh

■ **CLRB**

Sets specific bit to be OFF.

Equation: CLRB V1

Set V1 Bit to be OFF

Example:

Set a value of 0 to the 0 number of bit within the internal memory \$0.

\$0 = FFFFH

CLRB \$0.0

The result → \$0 = FFFE H

■ **INVB**

Sets specific bit to be inversed. ON → OFF, OFF → ON

Equation: INVB V1

Set V1 Bit to be inversed. ON → OFF, OFF → ON

Example:

Set a value of 0 to the 0 number of bit within the inversed internal memory \$0.

\$0 = FFFE H

INVB \$0.0

The result → \$0 = FFFF H

■ **GETB**

Get bit value

Equation: V1 = GETB V2

Get V2 Bit value and store in V1

Example:

Get the 3rd Bit value within \$0 and store it to the 5th Bit within \$10.

\$2 = FFFE H

\$10 = 0

\$10.5 = GETB \$0.3

The result → \$10 = 4

■ Communication

Command	Equation	Description
INITCOM	V1= INITCOM (V2)	Initial setup COM port
ADDSUM	V1=ADDSUM(V2, V3)	Use addition to calculate checksum
XORSUM	V1 = XORSUM(V2, V3)	Use XOR to calculate checksum
PUTCHARS	V1 = PUTCHARS(V2, V3, V4)	Output characters by COM port
GETCHARS	V1 = GETCHARS(V2, V3, V4)	Get characters by COM port
SELECTCOM	SELECTCOM(V1)	Select COM port
CLEARCOMBUFFER	CLEARCOMBUFFER(V1, V2)	Clear COM port buffer
CHRCHKSUM	V1 = CHRCHKSUM(V2, V3, V4)	Calculate the length of texts and checksum

Table 4.3.7 Communication command table

■ INITCOM

INITCOM → Initial setup COM port to start communication and set communication protocol.

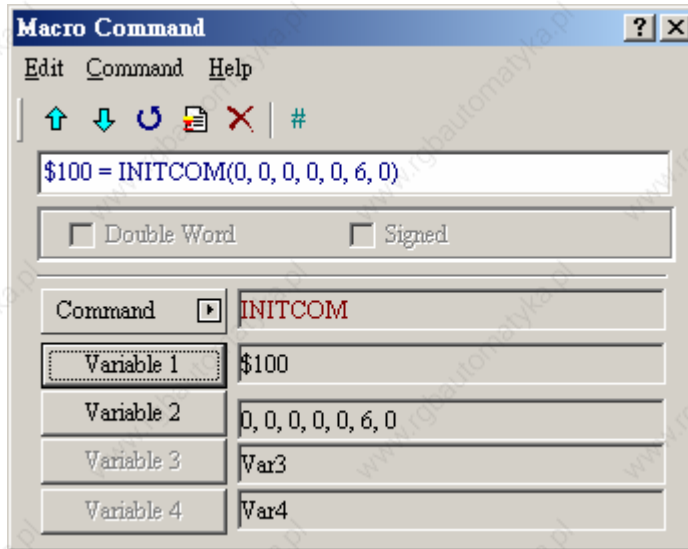


Fig. 4.3.2 INITCOM

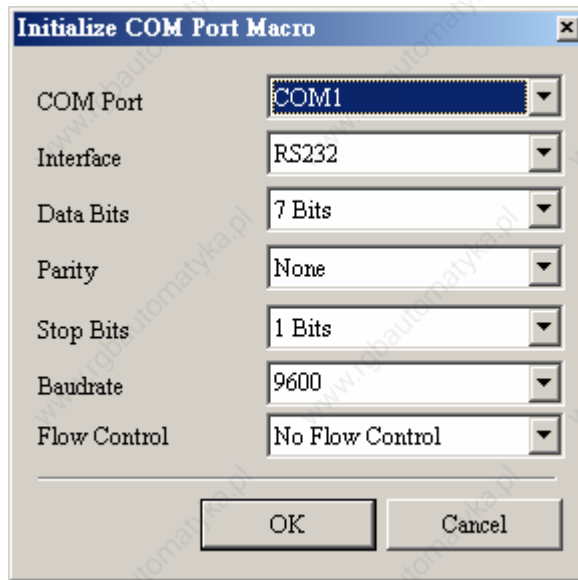


Fig. 4.3.3 Variable2 settings in INITCOM (communication protocol)



Fig. 4.3.4 COM port



Fig. 4.3.5 Communication interface



Fig. 4.3.6 Data Bit



Fig. 4.3.7 Parity bit



Fig. 4.3.8 Stop bit



Fig. 4.3.9 Baud rate

Flow Control: The transmission speed and communication validity are enhanced during communication due to new transmission technology, such as compress immediately, debug,... etc. But the new technology also makes the transmission speed between HMI and PC will longer than the actual transmission speed. Therefore, ensure the data security and transmit complete data between computer and HMI, the flow control is necessary.

No Flow Control: Flow control function is disabled.

CTS/RTS: It is flow control for hardware. It uses handshaking signal to control receiving and sending data. The control is achieved via internal modem or external modem that connect to HMI by connecting cable.

DSR/DTR: It is flow control for hardware also. It is used when PC and HMI is connected by cable directly.

XON/XOFF: It is flow control for software. It is only used for 2400bps modem. The control method is to generate control code by software and add it in the transmission data.



Fig. 4.3.10 Flow control

■ **ADDSUM**

ADDSUM → It uses addition to calculate checksum. $V1=ADDSUM(V2, V3)$. V1 is the value after calculation, V2 is the starting address for calculation and V3 is data length.

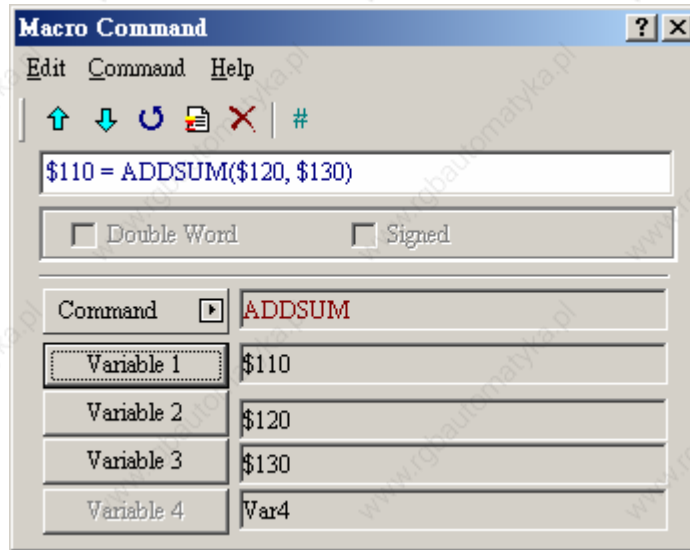


Fig. 4.3.11 ADDSUM

■ **XORSUM**

XORSUM → It uses XOR to calculate checksum. $V1=XORSUM(V2, V3)$. V1 is the value after calculation, V2 is the starting address for calculation and V3 is data length.

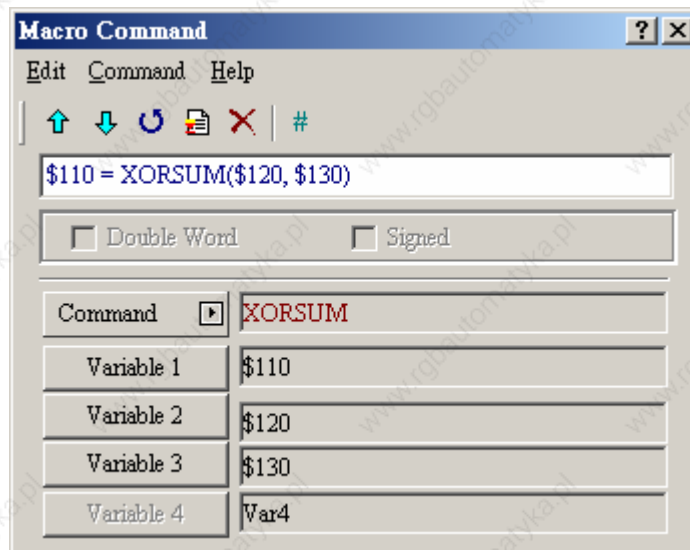


Fig. 4.3.12 XORSUM

■ **PUTCHARS**

PUTCHARS → Output characters by COM port. V1= PUTCHARS (V2, V3, V4). V1 is the response value after communication, V2 is the starting address of transmission data, V3 is data length, and V4 is the allowance communication time (unit is ms). The result will be stored in V1.

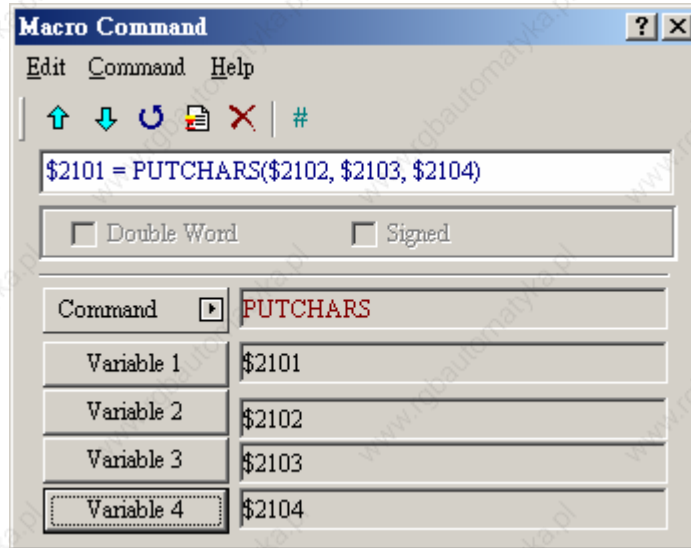


Fig. 4.3.13 PUTCHARS

■ **GETCHARS**

GETCHARS → Get characters by COM port. V1= GETCHARS (V2, V3, V4). V1 is the response value after communication, V2 is the starting address of transmission data, V3 is data length, and V4 is the allowance communication time (unit is ms). The result will be stored in V1.

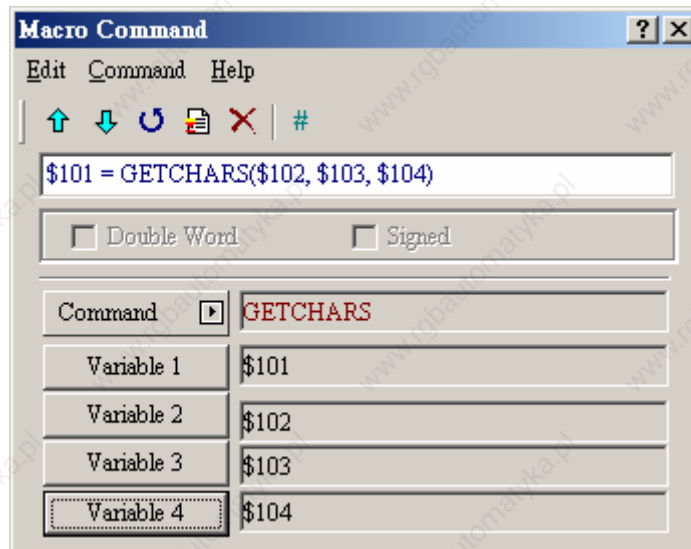


Fig. 4.3.14 GETCHARS

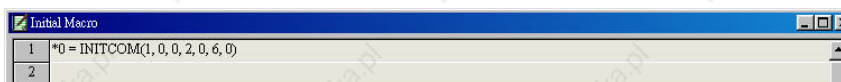


Fig. 4.3.15 Example 1 of Delta PLC

In example 1 of Delta PLC shows the initial setup operation of Delta PLC. The users can see the INITCOM command example in Fig. 4.3.15.

```

1 CHR(*10, "01030300FF00F")
2 *17 = 0D36H
3 *18 = AH
4 CHR(*30, "010303000000F")
5 *37 = 0D35H
6 *38 = AH
7 CHR(*30, "010203000010E")
8 *57 = 0D38H
9 *38 = AH
10 INVB I@S0
11 LABEL 99
12 *20 = PUTCHARS(*10, 17, 500)
13 *21 = GETCHARS(*100, 17, 500)
14 *20 = PUTCHARS(*30, 17, 500)
15 *21 = GETCHARS(*100, 17, 500)
16 GOTO LABEL 99
    
```

Fig. 4.3.16 Example 2 of Delta PLC

Example 2 of Delta PLC in Fig. 4.3.16 shows the communication macro for background macro. From Line 1 to line 3, the users can see that Y0 is set to be ON and written into internal memory *10. From Line 4 to line 6, the users can see that Y0 is set to be OFF and written into internal memory *30. Then, output ON data in line 12 and output OFF data in line 14. Therefore, when HMI execute these commands, the users can see Y0 LED will be ON and OFF alternately. From this example, the users can know that communication Macro let the users have the rights of PLC control simultaneously when you have PLC communication data. Even if Delta DOP series HMI does not support the types of PLCs or any new PLCs, the users still can control those PLCs by using communication Macro with communication protocol.

■ **SELECTCOM**

SELECTCOM → It is used to select COM port. When not select connecting PLC (set PLC to NULL) in Options > Configuration in ScrEdit, the users can use two COM ports (0:COM1, 1:COM2) at the same time. (All communication commands will be processed via the COM port the users select after executing this command. Different macros will not support each other or have any interference.)

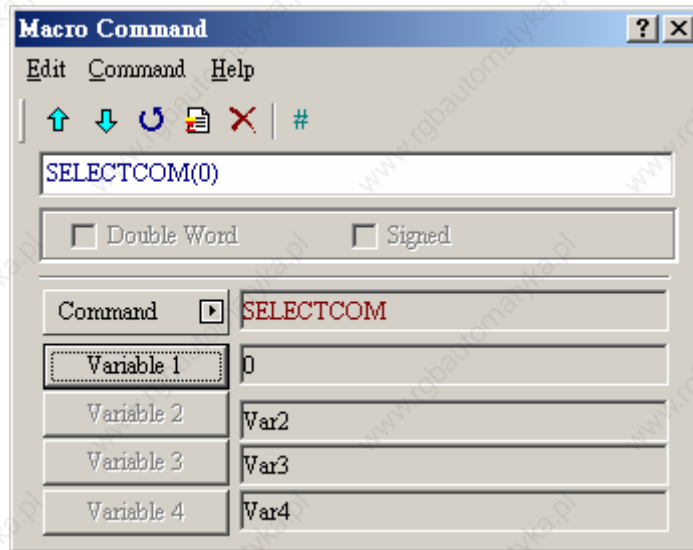


Fig. 4.3.17 SELECTCOM

■ CLEARCOMBUFFER

Clear COM port buffer.

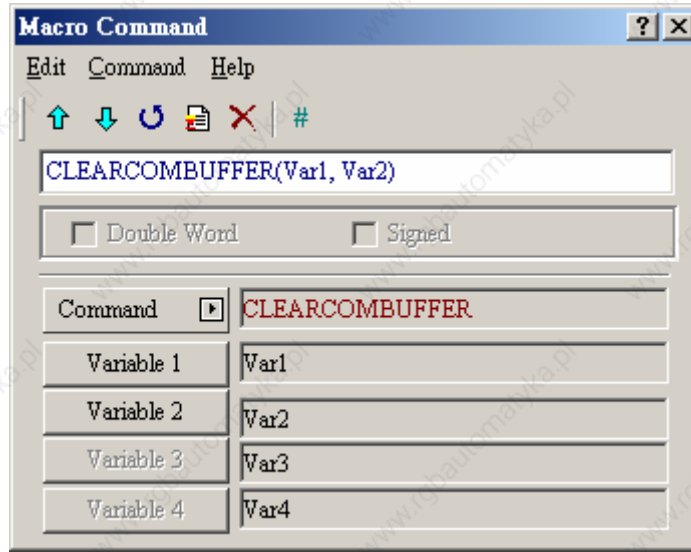


Fig. 4.3.18 CLEARCOMBUFFER

Equation: CLEARCOMBUFFER(V1, V2)

V1 is the number of communication port. It represents as constant 0(COM1) or 1(COM2).

V2 is the type of buffer area. It represents as constant 0 (receiving buffer area) or 1(sending buffer area)

Example:

Clear sending buffer area of COM2

CLEARCOMBUFFER(1, 0)

■ CHRCHKSUM

Calculate the data length of texts or characters and checksum.

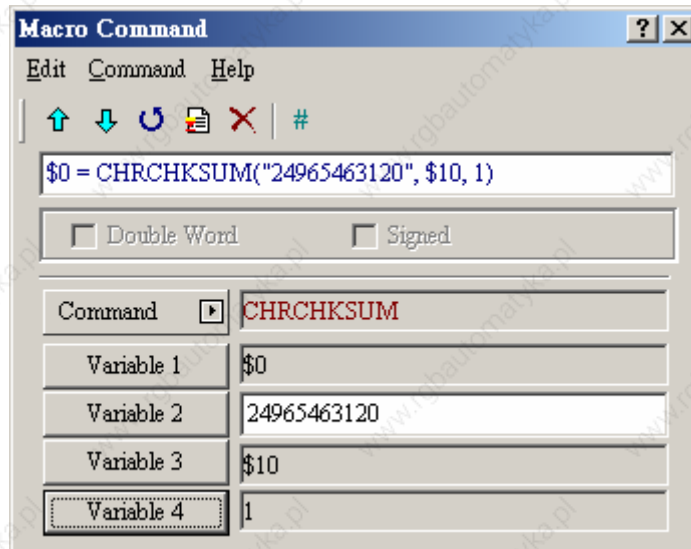


Fig. 4.3.19 CHRCHKSUM

Equation: V1 = CHRCHKSUM(V2, V3, V4)

V1 is the internal memory address where stores the text length of V2.

V2 is the string of text.

V3 is the internal memory address where stores the checksum of V2.

V4 is the data length of the checksum that stores in V3. 0 represents Byte and 1 represents Word.

Operation of checksum:

Convert format of each data characters to ASCII code and add up them. For example, convert '2' to ASCII code '31H', convert '4' to ASCII code '34H' and the checksum is 31H + 34H = 65H.

Example:

Calculate the data length of "24" and checksum

\$0 = CHRCHKSUM("24", \$10, 2)

After the above operation, 2 is stored in \$0 and 2 represents the data length is 2 bytes. The checksum stored in \$10 is 65H.

■ **Others**

Command	Equation	Description
TIMETICK	V1 = TIMETICK	Get the time from system startup to present
GETLASSERROR	V1 = GETLASTERROR	Get last error value
#	#V1	Comment
delay	delay V1	System delay
GETSYSTEMTIME	V1 = GETSYSTEMTIME	Get system time
SETSYSTEMTIME	SETSYSTEMTIME(V1)	Set system time
GETHISTORY	V1 = GETHISTORY (V2, V3, V4, V5, V6)	Get history data

■ **TIMETICK**

TIMETICK → Get the time from system startup to present and put into the specific address. An increment of 1 means 100ms is added.

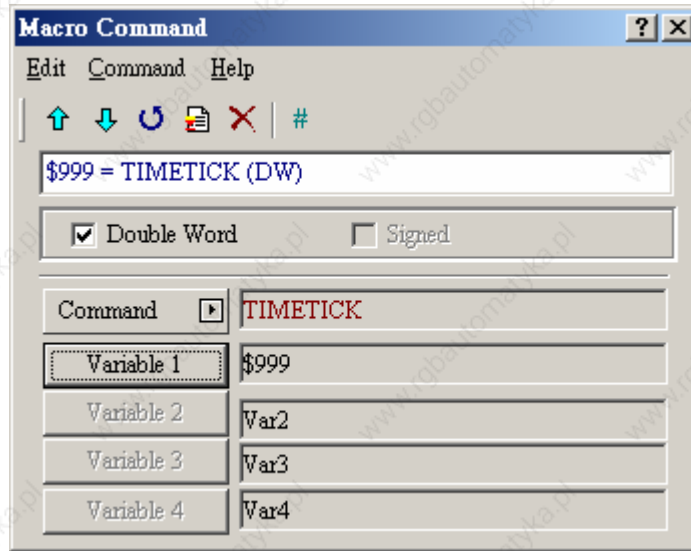


Fig. 4.3.20 TIMETICK

■ **GETLASTERROR**

GETLASTERROR → Get last error value. If there is no error occurred, the result of GETLASTERROR will be 0. Even if each Macro is executed simultaneously, the error message will not interfere one another. For error code information, please refer to section 4.4.

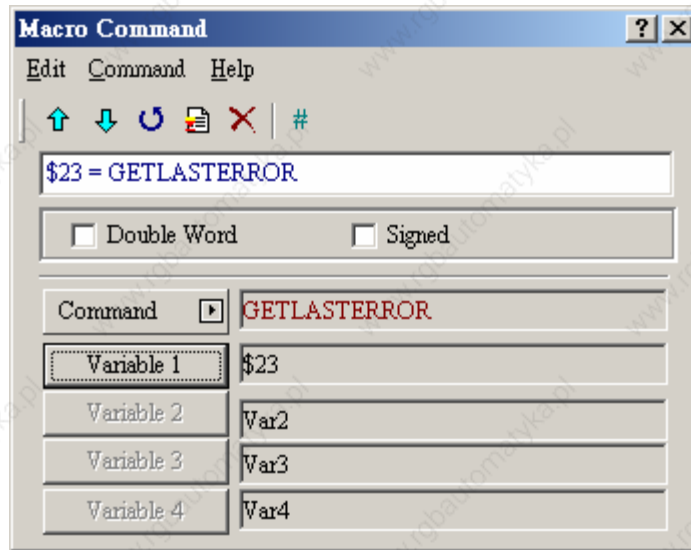


Fig. 4.3.21 GETLASTERROR

■ **COMMENT**

COMMENT → It lets Macro to be readable. Using this command will not affect macro function. The users only need to put “#” in front of the equation and the macro will become readable. If the users want to change the comment to be back to equation, just remove the “#” symbol.

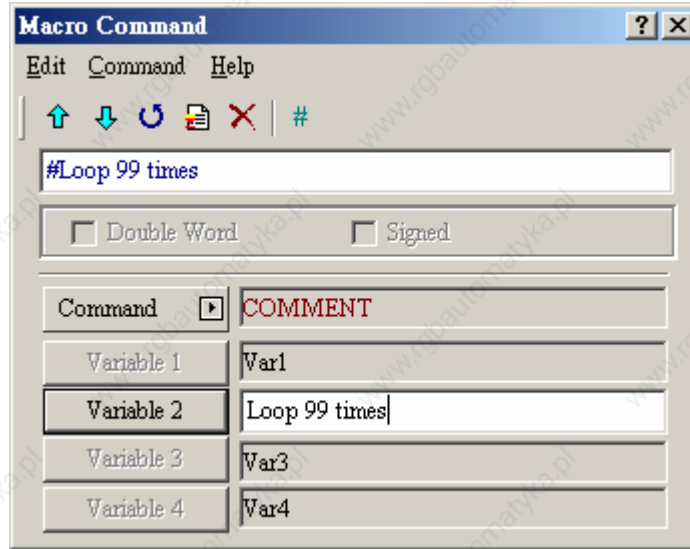


Fig. 4.3.22 COMMENT

■ **Delay**

Delay → Delays the user setting time by system. As HMI system is a multiplexer system, the system delay problem may occur. Therefore, setting time will be increased due to “system busy” and the condition that the setting time move forward will not happen. The unit of delay time is ms.

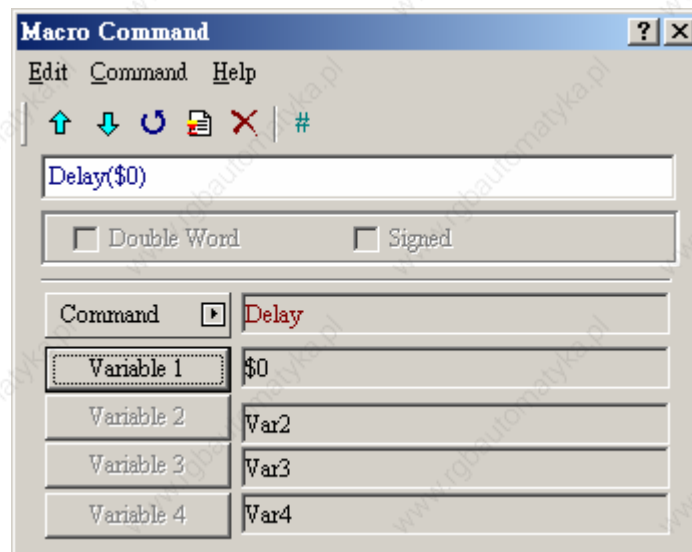


Fig. 4.3.23 Delay

■ **GETSYSTEMTIME**

Get system time

Equation: V1 = GETSYSTEMTIME

V1 is the starting address of continuous 7Words within the internal memory address.

- V1 Year
- V1 + 1 Month
- V1 + 2 Date
- V1 + 3 Week
- V1 + 4 Hour
- V1 + 5 Minute
- V1 + 6 Second

Example:

Now the system time is 2006/01/04 Wed 09:26:25. Using this command to get the current system time and store in \$1~\$7.

\$1 = GETSYSTEMTIME

Get \$1 = 2006, \$2 = 01, \$3 = 4, \$4 = 3, \$5 = 9, \$6 = 26, \$7 = 25

■ **SETSYSTEMTIME**

Set system time

Equation: SETSYSTEMTIME(V1)

V1 is the starting address of continuous 7Words within the internal memory address.

- V1 Year
- V1 + 1 Month
- V1 + 2 Date
- V1 + 3 Week
- V1 + 4 Hour
- V1 + 5 Minute
- V1 + 6 Second

Example:

Set the current system time as 2006/01/04 Wed 09:26:25.

\$1 = 2006

\$2 = 1

\$3 = 4

\$4 = 3

\$5 = 9

\$6 = 26

\$7 = 25

SETSYSTEMTIME(\$1)

■ GETHISTORY

Get history data

Equation: V1 = GETHISTORY (V2, V3, V4, V5, V6)

V1 is the internal memory address where store the data length.

V2 is the internal memory, constant, the buffer number of history buffer area.

V3 is the internal memory, constant, the starting address for sampling.

V4 is the internal memory, constant, the points for reading

V5 is the internal memory, PLC address, the address where store the data

V6 is the internal memory, constant, the data type for reading

0: Data, 1: Time, 2: Time and Data

4.4 Error Messages

When compiling, it will shows errors in output window for user to find out easily. Some errors occur because of the users' carelessness, sometimes just because the users miss to input some commands. Some errors will be found out easily in short program. But that will be difficulty in long Macro. To help the users to debug, ScrEdit provides error messages to show what the error is. But for those logic errors, the users should be aware of it and avoid making this kind of mistake.

■ Error messages when editing

■ Code – 100: LABEL cannot be found

There is no such LABEL that GOTO designates.

■ Code – 101: Recursion occurs

This error message is usually occurred in sub-macro. The ability of a sub-macro to CALL itself is called recursion. No matter it is called directly or indirectly. Basically, recursion cannot be adopted for sub-macro. The users can use GOTO or FOR (infinite times) to replace it.

■ Code – 102: More than 3 nested FOR is used

This error message is to warn the users not to use more than 3 nested FOR commands. The purpose is to avoid insufficient memory. The users can use GOTO or IF to replace it.

■ Code – 103: Sub-macro does not exist

This error message means that there is no sub-macro in the program. For example, CALL 5 means CALL sub-macro 5. If the users do not edit sub-macro 5 in the program, this error message will display to warn the users. The purpose is to warn the users to be more careful when editing (reduce input error or avoid forgetting editing the corresponding sub-macro) and prevent unexpected error.

■ **Code – 104: Number of NEXT is less than the number of FOR**

Number of NEXT and FOR should match. This error code is used to remind the users finding out the missing NEXT.

■ **Code –105: Number of FOR is less than the number of NEXT**

Number of FOR and NEXT should match. This error code is used to remind the user if there is any missing FOR.

■ **Code–106: Repeated LABEL**

This error message means that there are repeated LABEL in the same Macro. The program will be confusing with that. That may be caused by carelessness (input error or forget to edit the corresponding sub-macro) and the users will get error message during editing to avoid unexpected error.

■ **Code–107: There is RET in Macro**

This error message means that there is RET command in Macro. RET command should be used for sub-macro to return program. But in Macro, it should use END not RET.

■ **HMI Macro Error Messages**

The users can read error messages by macro. Once there is an error and the users execute a correct command before reading error message, the error message will be overwritten. When executing each macro, each Macro error message will not be influenced by other macro.

■ **Code–10: GOTO Error**

This message means that there is GOTO error in macro.

■ **Code–11: Stack Overflow**

This message means that stack in macro is full. That may be cause by using too many sub-macros or execute different macros at the same time. This is to avoid insufficient memory.

■ **Code–12: CALL Empty Sub-macro**

This is CALL sub-macro error. The sub-macro that is called should not be an empty sub-macro. This message is to avoid unexpected error.

■ **Code–13: Data Read Error**

This is data read error. Sometimes this may be caused by memory data error but most of the time is PLC data read error.

■ **Code–14: Data Write Error**

This is data write error. Sometimes this may be caused by memory data error but most of the time is PLC data write error.

- **Code-15: Divisor is 0**

This error message means that the divisor is 0 when performing division operation.

- **HMI Communication Error Messages**



Fig. 4.4.1 Example of n HMI Communication Error Message

- **Communication Busy**

Error Message: Com ? Station ?: Communication Busy ...

- **Unknown Code**

Error Message: Com ? Station ?: Receive Unknow Code ...

- **No Response from Controller**

Error Message: Com ? Station ?: Controller No Response ...

- **HMI CheckSum Error**

Error Message: Com ? Station ?: Check Sum Error in HMI Message ...

- **Controller CheckSum Error**

Error Message: Com ? Station ?: Check Sum Error in Controller Message ...

- **Incorrect Command**

Error Message: Com %d Station %d: Command Can Not be Executed ...

- **Incorrect Address**

Error Message: Com ? Station ?: Address Fault ...

- **Incorrect Value**

Error Message: Com ? Station ?: Value is Incorrect ...

- **Controller is Busy**

Error Message: Com ? Station ?: Controller is Busy ...

- **CTS Signal Fail**

Error Message: Com ? Station ?: CTS Signal Fail ...

■ **No Such Resource in Controller**

Error Message: Com ? Station ? : No Such Resource ...

■ **No Such Service in Controller**

Error Message: Com ? Station ? : No Such Service ...

■ **Must Retry**

Error Message: Com ? Station ? : Must Retry ...

■ **HMI Station Number Error**

Error Message: Com ? Station ? : HMI Station Number Error ...

■ **Controller Station Number Error**

Error Message: Com ? Station ? : Controller Station Number Error ...

■ **UART Communication Error**

Error Message: Com ? Station ? : UART Communication Error ...

■ **Other Communication Error**

Error Message: Com? Station ? : Other Communication Error ...

Chapter 5 Control Block and Status Block

For two-way communication and display screen between DOP series and all brands' PLC, it needs to define the address of HMI control block and status block in Standard tab. Please choose Options > Configuration to find the Standard tab in Configuration dialog box (Fig. 5.1 and Fig. 5.2).

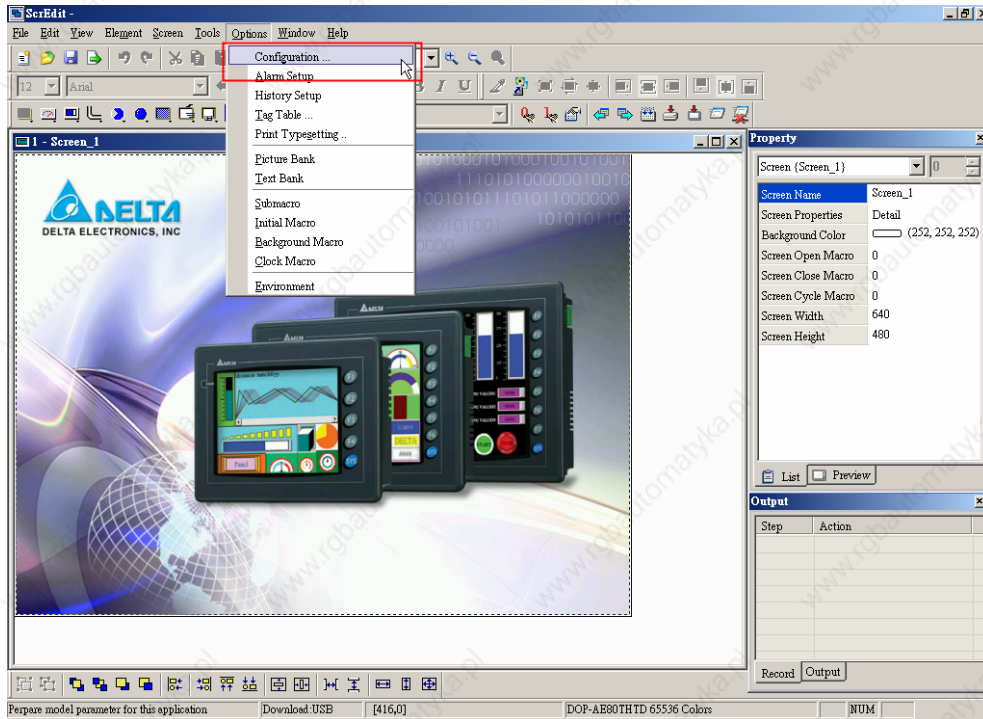


Fig. 5.1 Configuration settings

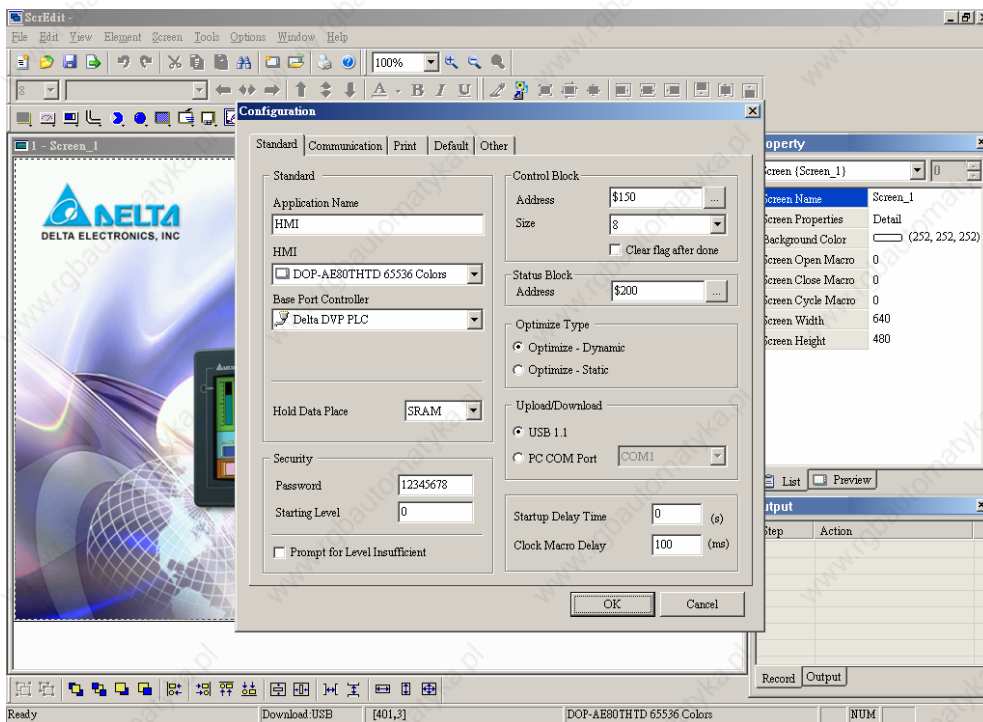


Fig. 5.2 Standard tab

5.1 Control Block

HMI can be controlled via PLC by designating the register from control block settings. The register is a continuous data block and its length is from 0 to 8 WORDs. The length is different depends on function. For example, it needs at least 7 WORDs for recipe function. When the control block size is set to 0, the control block function is disabled. If the control block function is enabled, HMI can judge the operation that commanded by the external controller by reading the setting in control block rapidly and continuously.

The function and explanation of each WORD are listed below. (In the following table, we assume that the users use Delta PLC, so the available starting addresses in control block are Dn ~ Dn+7 (D0 ~ D7).)

Word Number	Register Number	Example
0	Register for designating Screen Number (SNIR)	Dn (D0)
1	Control Flag Register (CFR)	Dn+1 (D1)
2	Curve Control Register (CUCR)	Dn+2 (D2)
3	Register for Sampling History Buffer (HBSR)	Dn+3 (D3)
4	Register for Clearing History Buffer (HBCR)	Dn+4 (D4)
5	Recipe Control Register (RECR)	Dn+5 (D5)
6	Register for designating Recipe Group Number (RBIR)	Dn+6 (D6)
7	System Control Flag Register (SCFR)	Dn+7 (D7)

■ Register for Designating Screen Number (SNIR)

Word	Function
0	Designate screen number

This register SNIR (Dn) is used to designate HMI screen by setting PLC (D0). HMI screen can be switched automatically by changing D0.

■ Control Flag Register (CFR)

Bit Number	Function
0	Enable / disable communication
1	Enable / disable back light
2	Enable / disable buzzer
3	Clear alarm buffer
4	Clear alarm counter
5~7	Reserved
8	Setting user level bit0
9	Setting user level bit1
10	Setting user level bit2
11~15	Reserved

■ **Enable / Disable Communication**

Control the HMI communication. When Bit 1 is set to ON, it will disable HMI communication. When Bit 1 is set to OFF, it will enable HMI communication.

■ **Enable / Disable Back Light**

Control HMI back light. When Bit 1 is set to ON, it will turn off HMI back light. When Bit 1 is set to OFF, it will turn on HMI back light.

■ **Enable / Disable Buzzer**

Control HMI buzzer. When Bit 2 is set to ON, it will turn off HMI buzzer. When Bit 1 is set to OFF, it will turn on HMI buzzer.

■ **Clear Control Flag for Alarm Buffer**

It is used to clear alarm buffer. Set Bit 3 to be ON to trigger this control flag. It clears alarm buffer when this flag is triggered to ON. This flag needs be set to OFF and then ON if the users want to trigger again.

■ **Clear Control Flag for Alarm Counter**

It is used to clear alarm counter. Set Bit 4 to be ON to trigger this control flag. It clears alarm buffer when this flag is triggered. This flag needs be set to OFF and then ON if the users want to trigger again.

■ **Setting User Level**

PLC can set the user level of using HMI from Bit 8, Bit 9 and Bit 10. The setting level is from level 0 to level 7. MSB: Bit 10 and LSB: Bit 8.

■ **Curve Control Register (CUCR)**

Bit Number	Function
0	Curve sampling flag 1
1	Curve sampling flag 2
2	Curve sampling flag 3
3	Curve sampling flag 4
4~7	Reserved
8	Curve clear flag 1
9	Curve clear flag 2
10	Curve clear flag 3
11	Curve clear flag 4
12~15	Reserved

■ **Curve Sampling Control Flag (1-4)**

HMI curve (general curve or X-Y curve) sampling is controlled by PLC. When this control flag is triggered to ON (Bit 0 ~ Bit 3 is set to ON), HMI will sample ONCE by reading continuous data of curve on HMI screen and convert the data to graph and show on HMI screen. This flag needs be set to OFF and then ON if the users want to trigger again.

■ **Curve Clear Control Flag (1-4)**

Clear HMI curve (general curve or X-Y curve) when this control flag is triggered (Bit 8 ~ Bit 11 is set to ON). This flag needs be set to OFF and then ON if the users want to trigger again.

■ **Register for Sampling History Buffer (HBSR)**

For the settings of sampling history buffer, the users can refer to the description of “History Setup” in Chapter 2. HMI provides 12 records for tracking sampling register of history buffer. Besides, HMI time interval settings, sampling or clearing history buffer can be controlled via PLC.

Bit Number	Function
0	Control flag for Sampling History Buffer 1
1	Control flag for Sampling History Buffer 2
2	Control flag for Sampling History Buffer 3
3	Control flag for Sampling History Buffer 4
4	Control flag for Sampling History Buffer 5
5	Control flag for Sampling History Buffer 6
6	Control flag for Sampling History Buffer 7
7	Control flag for Sampling History Buffer 8
8	Control flag for Sampling History Buffer 9
9	Control flag for Sampling History Buffer 10
10	Control flag for Sampling History Buffer 11
11	Control flag for Sampling History Buffer 12
12~15	Reserved

■ **Control Flag Register for Sampling History Buffer**

Controls sampling history buffer operation of HMI by the external controller, i.e. PLC. It will sample 1 time once the control flag is triggered to ON (Bit 1 ~ Bit 12 is set to ON). This flag needs be set to OFF and then ON if the users want to trigger again.

■ Register for Clearing History Buffer (HBCR)

Bit Number	Function
0	Clear flag of history buffer 1
1	Clear flag of history buffer 2
2	Clear flag of history buffer 3
3	Clear flag of history buffer 4
4	Clear flag of history buffer 5
5	Clear flag of history buffer 6
6	Clear flag of history buffer 7
7	Clear flag of history buffer 8
8	Clear flag of history buffer 9
9	Clear flag of history buffer 10
10	Clear flag of history buffer 11
11	Clear flag of history buffer 12
12~15	Reserved

■ Clear flag of history buffer

HMI history buffer can be cleared by the external controller, i.e. PLC. Once the control flag is triggered to ON (Bit 1 ~ Bit 12 is set to ON), it will clear HMI history buffer ONCE. This flag needs be set to OFF and then ON if the users want to trigger again.

■ Recipe Control Register (RECR)

Bit Number	Function
0	Change recipe group number
1	Read recipe (PLC → HMI)
2	Write recipe (HMI → PLC)
3~15	Reserved

■ Control flag for changing recipe group number

RCPNo is the internal system register used for designating recipe group number. RCPNo value can be changed by writing recipe group number (N) into Designated Recipe Group Number Register (RBIR) Dn+6 and trigger this control flag to ON (Bit 0 is set to ON). After setting, RCPNo will be changed to N automatically. This flag needs be set to OFF and then ON if the users want to trigger again.

■ Control flag for reading recipe

Before reading a recipe from PLC, the users should designate the recipe group number (N) first (Please refer to the section “Control flag for changing recipe group number”). Then, trigger this control flag to ON (Bit 1 is set to ON). After setting, the recipe will be read from PLC and stored in designating area of HMI. This flag needs be set to OFF and then ON if the users want to trigger again.

■ **Control flag for writing recipe**

Before writing a recipe to PLC, the users should designate the recipe group number (N) first (Please refer to the section “Control flag for changing recipe group number”). Then, trigger this control flag to ON (Bit 2 is set to ON). After setting, the recipe will be written to PLC. This flag needs be set to OFF and then ON if the users want to trigger again.

■ **Register for designating Recipe Group Number (RBIR)**

Word	Function
0	Designate receipt group number which

By writing recipe group number (N) into Designated Recipe Group Number Register (RBIR), RCPNo value can be changed. The users can use the control flag for changing recipe group number of Recipe Control Register (RECR) to write recipe group number (N) into Designated Recipe Group Number Register (RBIR) and change RCPNo value.

■ **System Control Flag Register (SCFR)**

Bit Number	Function
0	Multi-language setting value Bit 0
1	Multi-language setting value Bit 1
2	Multi-language setting value Bit 2
3	Multi-language setting value Bit 3
4	Multi-language setting value Bit 4
5	Multi-language setting value Bit 5
6	Multi-language setting value Bit 6
7	Multi-language setting value Bit 7
8	Printer flag
9	Printer form feed flag
10~15	Reserved

■ **Multi-language Setting Value**

Store the designating multi-language setting value into this register and command HMI to switch to the designating language according to the settings in this register.

■ **Printer Flag**

When this flag is triggered to ON, the current display or editing screen can be printed out. When this flag is set to OFF, the printer function is disabled.

■ **Printer Form Feed Flag**

When this flag is triggered to ON, the printer will retract the paper and align the paper for the next run automatically. When this flag is set to OFF, the printing form feed function is disabled.

5.2 Status Block

For two-way communication and display screen between DOP series and all brands' PLC, it needs to input starting address of response register in status block. The status block in DOP series is a continuous data block, such as Dm=D10 (length is 8 WORDs = D10-D17). When the control block size is set to 0, the control block function is disabled. If the control block function is disabled, the status block function is also disabled. When the status block function is enabled, the external controller, i.e. PLC can know the status of HMI by writing the setting in status block. The function and explanation of each WORD are listed below. (In the following table, we assume that the users use Delta PLC, so the available starting addresses in control block are Dm ~ Dm+7 (D10 ~ D17).)

Word Number	Register	
0	Status Register for General Control (GCSR)	Dm (D10)
1	Status Register for Screen Number (SNSR)	Dm+1 (D11)
2	Status Register for Curve Control (CCSR)	Dm+2 (D12)
3	Status Register for Sampling History Buffer (HSSR)	Dm+3 (D13)
4	Status Register for Clearing History Buffer (HCSR)	Dm+4 (D14)
5	Recipe Status Register (RESR)	Dm+5 (D15)
6	Status Register for Recipe Number (RBSR)	Dm+6 (D16)
7	Status Register 2 for General Control (GCSR2)	Dm+7 (D17)

■ Status Register for General Control (GCSR)

Bit Number	Function
0	Screen Switch Status
1~2	Reserved
3	Clear Status of Alarm Buffer
4	Clear Status of Alarm Counter
5-7	Reserved
8	User Level (Bit0)
9	User Level (Bit1)
10	User Level (Bit2)
11	User Level (Bit3)
12~15	Reserved

■ Screen Switch Status

When the screen is switched, the Bit will be set to ON. After screen switch is completed, the Bit will be OFF.

■ Clear Status of Alarm Buffer

When HMI clear the alarm buffer (clear status of alarm buffer function is enabled), the Bit will be set to ON. After this function is completed, the Bit will be OFF.

■ **Clear Status of Alarm Counter**

When HMI clear the alarm counter (clear status of alarm counter function is enabled), the Bit will be set to ON. After this function is completed, the Bit will be OFF.

■ **User Level Status**

Bit 8 ~ Bit 11 are used to record the users level when HMI is in communication.

User Level \ Bit	Bit 8	Bit 9	Bit 10	Bit 11
0	OFF	OFF	OFF	OFF
1	ON	OFF	OFF	OFF
2	OFF	ON	OFF	OFF
3	ON	ON	OFF	OFF
4	OFF	OFF	ON	OFF
5	ON	OFF	ON	OFF
6	OFF	ON	ON	OFF
7	ON	ON	ON	OFF
8	OFF	OFF	OFF	ON

■ **Status Register for Screen Number (SNSR)**

Word	Function
0	The last open screen number

■ **The last open screen number**

The register SNSR (Dm+1) is used to store the last screen number you opened. Every time the screen is switched, the last screen that the users open (including sub-screen) will be memorized and stored in this status register (D11).

■ **Status Register of Curve Control (CCSR)**

Bit Number	Function
0	Sampling status of curve 1
1	Sampling status of curve 2
2	Sampling status of curve 3
3	Sampling status of curve 4
8	Clear status of curve 1
9	Clear status of curve 2
10	Clear status of curve 3
11	Clear status of curve 4
4~7;12~15	Reserved

■ **Curve Sampling Status Flag**

When sampling general curve or X-Y curve, the curve sampling status flag will be set to be ON (Bit 0 ~ Bit 3 is set to ON). After sampling operation is completed, the curve sampling status flag will be OFF.

■ **Curve Clear Status Flag**

When clearing general curve or X-Y curve, the curve clear status flag will be set to be ON (Bit 8 ~ Bit 11 is set to ON). After clear operation is completed, the curve clear status flag will be OFF.

■ **Status Register for Sampling History Buffer (HSSR)**

Bit Number	Function
0	Sampling Status of History Buffer 1
1	Sampling Status of History Buffer 2
2	Sampling Status of History Buffer 3
3	Sampling Status of History Buffer 4
4	Sampling Status of History Buffer 5
5	Sampling Status of History Buffer 6
6	Sampling Status of History Buffer 7
7	Sampling Status of History Buffer 8
8	Sampling Status of History Buffer 9
9	Sampling Status of History Buffer 10
10	Sampling Status of History Buffer 11
11	Sampling Status of History Buffer 12
12-15	Reserved

■ **Sampling History Buffer Flag**

When sampling history buffer, the sampling history buffer flag will be set to be ON (Bit 0 ~ Bit 11 is set to ON). After sampling operation is completed, the sampling history buffer flag will be OFF.

■ **Status Register for Clearing History Buffer (HCSR)**

Bit Number	Function
0	Clear Status of History Buffer 1
1	Clear Status of History Buffer 2
2	Clear Status of History Buffer 3
3	Clear Status of History Buffer 4
4	Clear Status of History Buffer 5
5	Clear Status of History Buffer 6
6	Clear Status of History Buffer 7
7	Clear Status of History Buffer 8
8	Clear Status of History Buffer 9

Bit Number	Function
9	Clear Status of History Buffer 10
10	Clear Status of History Buffer 11
11	Clear Status of History Buffer 12
12~15	Reserved

■ **Clear History Buffer Flag**

When clearing history buffer, the clear history buffer flag will be set to be ON (Bit 0 ~ Bit 11 is set to ON). After sampling operation is completed, the clear history buffer flag will be OFF.

■ **Recipe Status Register (RESR)**

Bit Number	Function
0	Change Status of Recipe Number
1	Recipe Read Status (PLC → HMI)
2	Recipe Write Status (HMI → PLC)
3~15	Reserved

■ **Change Status of Recipe Number Flag**

When change status of recipe number is controlled by PLC, the change status of recipe number flag (Bit 0) is set to ON. After HMI change the status of recipe number and update the RCPNo value, the change status of recipe number flag will be OFF.

■ **Recipe Read Status Flag**

When HMI read one recipe data from PLC, the recipe read status flag (Bit 1) is set to ON. When the recipe data is read and saved in HMI completely, the recipe read status flag will be OFF.

■ **Recipe Write Status Flag**

When HMI send one recipe data to PLC, the recipe write status flag (Bit 2) is set to ON. When the recipe data is sent and written to PLC completely, the recipe write status flag will be OFF.

■ **Status Register for Recipe Number (RBSR)**

Word	Function
0	Current recipe number

When recipe number register RCPNo is changed (no matter it is changed by PLC or HMI), the status register for recipe number (RBSR) (Dm+6) will be updated also. Monitoring this status register for recipe number (RBSR) can know the current recipe number.

■ Status Register 2 for General Control (GCSR2)

Bit Number	Function
0	Multi-language status value Bit 0
1	Multi-language status value Bit 1
2	Multi-language status value Bit 2
3	Multi-language status value Bit 3
4	Multi-language status value Bit 4
5	Multi-language status value Bit 5
6	Multi-language status value Bit 6
7	Multi-language status value Bit 7
8	Printer status flag
9	Printer form feed status flag
10~15	Reserved

■ Multi-language Status Value

The users can know the current multi-language shown on HMI from the multi-language status value.

■ Printer Status Flag

When this flag is triggered to ON, it indicates that the printer is printing current display or editing screen.

When this flag is set to OFF, the printer function is disabled.

■ Printer Form Feed Status Flag

When this flag is triggered to ON, it indicates that the printer is retracting the paper and aligning the paper for the next run automatically. When this flag is set to OFF, the printing form feed function is disabled.

This page intentionally left blank.

Chapter 6 Internal Memory

■ Internal Register (R/W): \$

Word access: \$n (n: 0~65535)

Bit access: \$n.b (n: 0~65535, b: 0~15)

Delta DOP series HMI provides 65536 16-bit internal registers (\$0 ~ \$65535).

■ Non-volatile Internal Register (R/W): \$M

Word access: \$Mn (n: 0~1023)

Bit access: \$Mn.b (n: 0~1023, b: 0~15)

Delta DOP series HMI provides 1024 16-bit non-volatile internal registers (\$M0 ~ \$M1023).

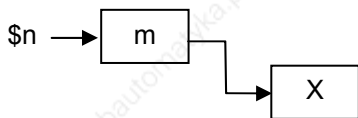
■ Indirect Address Register (R/W): *\$

Word access: *\$n (n: 0~65535)

Indirect addressing register is the register stored in the range from the address to the internal register.

The users need to get the address from \$n and then get the value stored in this address.

*\$n =



For example, if \$n = m; \$m = X; then *\$n = X. (the value of m cannot exceed 65535)

■ Receipt Number Register (R/W): RCPNO

It is 16-bit register that is used to designate the receipt group number. The minimum receipt group number should be 1 and the maximum group number is determined when editing the receipts.

PLC upload/download will read/write a group of recipe according to the setting of recipe number register. The length of each group of receipt is determined when editing the receipts.

Delta DOP series HMI provides a space of 64K Words max. for the users to store the receipts.

■ Receipt Register (R/W): RCP

The receipt length is L and the receipt group number is N.

Word access: RCPn (n: 0~NxL+(L-1))

Bit access: RCPn.b (n: 0~NxL+(L-1), b: 0~15)

The recipe register is used to save the recipe that download from HMI after finishing ScrEdit.

There are two methods to read/write these registers:

Assume that the users set the receipt length is L and the receipt group number is N:

Group Address Access:

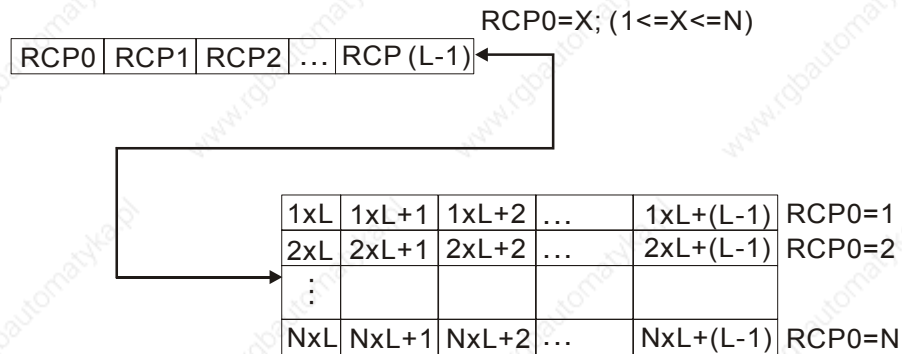
This method is accessed by RCPNO and RCP0~RCP (L-1).

For example: if RCPNO=3, HMI will read RCPNO 3 data out and save it in RCP0~RCP (L-1). Then PLC can read RCPNO 3 data from this area. RCP0~RCP (L-1) can be regarded as a common area.

Absolute Address Access:

This method is used to access the data that data address is greater than RCP (L-1). At this time, the starting address of 1st recipe is RCP (1xL), the starting address of 2nd recipe is RCP (2xL) and vise versa. Therefore, if the users want to access the mth word of nth recipe, the users can use the equation:

RCP(nxL+m) to achieve the purpose.



Appendix A Specifications and Installation

A.1 Specifications

Model	A(E)57BSTD	A(E)57GSTD	A(E)57CSTD	A75CSTD	AE80THTD	A10TCTD / AE10THTD	Note
Display Type	STN	FSTN	STN	STN	TFT-LCD		
Display Color	8 Grays	16 Grays	256 Colors	256 Colors	256 Colors (AE series: 65536 Colors)		
Screen Pixels	320 x 240 pixels			640 x 480 pixels			
Back-light Life	About 50 thousand hour at 25°C			About 20 thousand hour at 25°C	About 30 thousand hour at 25°C	About 30 thousand hour at 25°C	
Display Size	5.7" (118.2 x 89.4mm)			7.5" (158.0 x 118.0mm)	8.0" (162.2 x 121.7mm)	10.4" (215.2 x 162.4mm)	
Operation System	Windows Base Real Time OS						
MCU	32-bit RISC Micro-controller / 202.8MHz						
ROM	3M Bytes			7M Bytes			
Backup Memory (SRAM)	256K Bytes (AE : 512K Bytes) (non-volatile internal memory)						
EXT. Memory Card	Smart Media Card / USB Host Ver 1.1 (AE series only except 5.7")						※
USB for download	USB CLIENT Ver 1.1 & COM1, COM2						
Serial communication (UART)	COM1(RS-232), COM2&COM3(RS-232C/422/485) (AE series: COM3 (RS-232C/422/485))						
Function Keys	User-defined keys*4			User-defined keys*6		User-defined keys*7	
RTC	Built-in						
Lithium Battery	3V Lithium CR2032 x 1						
Buzzer	85dB						
Operation Voltage	DC +24V (-10%~+20%)						
Power Consumption	7.2W max			10W max	14W max	15W max	
Cooling Method	Natural air circulation						
Water Proof & Agency Approval	IP65 / NEMA4 & CE, UL, C-tick (except AE series)						
Operating Temp.	0°C to 50°C						
Storage Temp.	-20°C to +60°C						
Ambient Humidity	10% ~ 90% RH (0°C~40°C), 10%~55% RH (41°C~50°C)						
Vibration Resistance	IEC61131-2 compliant When vibration is NOT continuous: 5Hz-9Hz 3.5mm, 9Hz-150Hz 1G X, Y, Z directions for 10 times						

Appendix A Specifications and Installation | ScrEdit Software User Manual

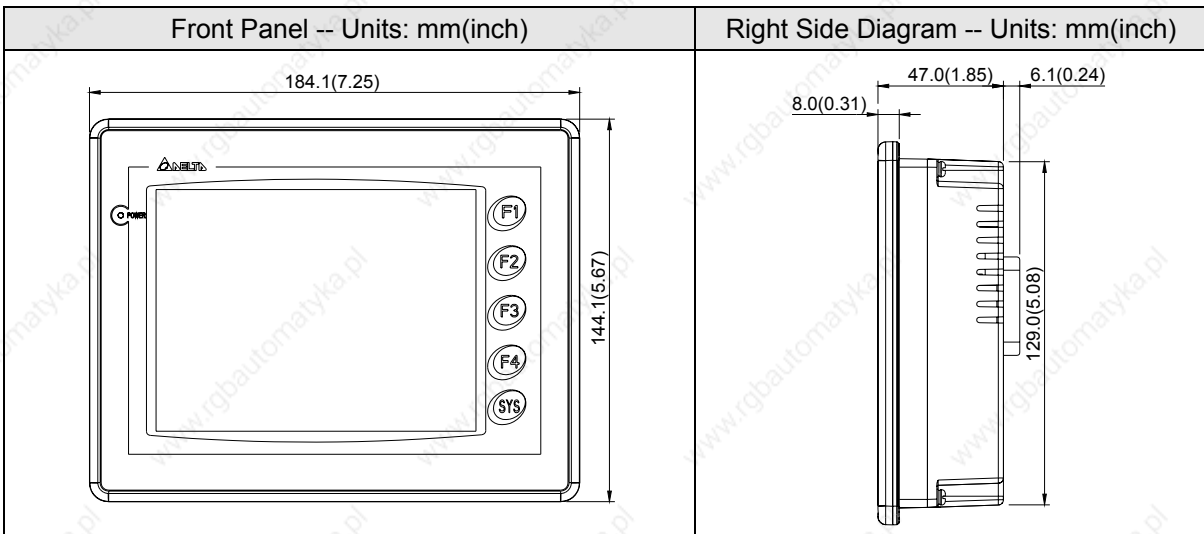
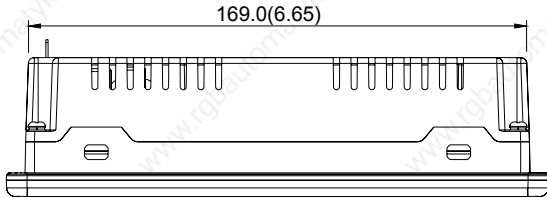
Model	A(E)57BSTD	A(E)57GSTD	A(E)57CSTD	A75CSTD	AE80THTD	A10TCTD / AE10THTD	Note
(W) x (H) x (D) mm Dimensions / Panel Cutout	184.1 x 144.1 x 47mm / 172.4 x 132.4mm			243.1 x178.1 x 47mm / 231.4 x 166.4mm	243.1x 178.1 x 52.4mm / 231.4 x 166.4mm	297.1 x 222.1 x 51.1mm / 285.2 x 210.2mm	
Weight	768g			942g	1147g	1721g	

※ Compatible with general Expansion Memory Card (4M~128M) on the market

A.2 Dimensions

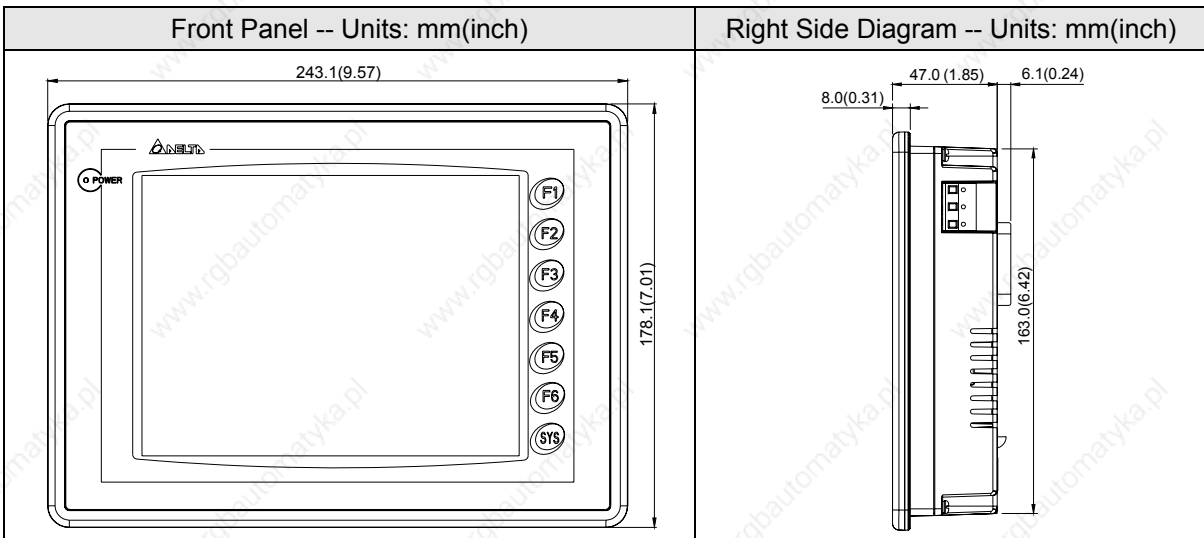
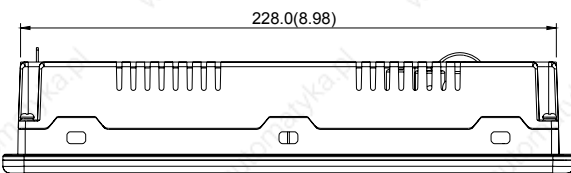
■ DOPA(E)57G(C)(B)STD

Vertical View -- Units: mm (inch)



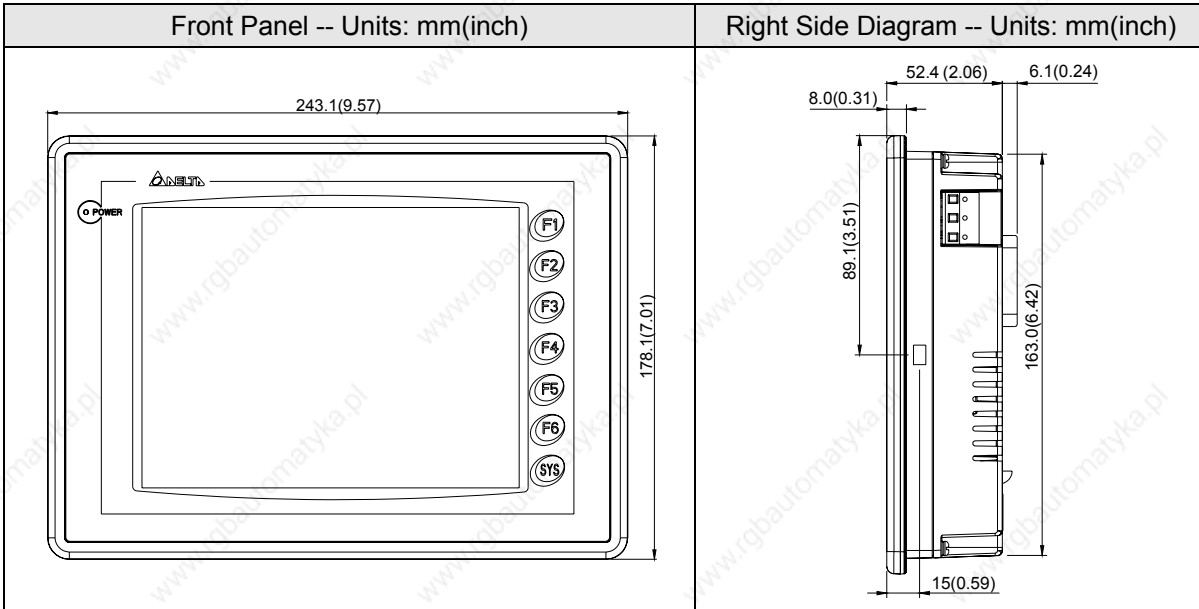
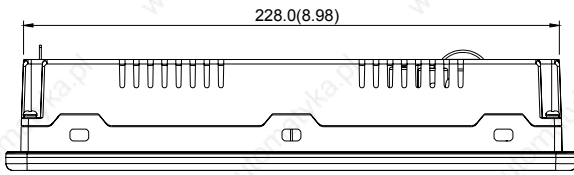
■ DOPA75CSTD

Vertical View -- Units: mm (inch)



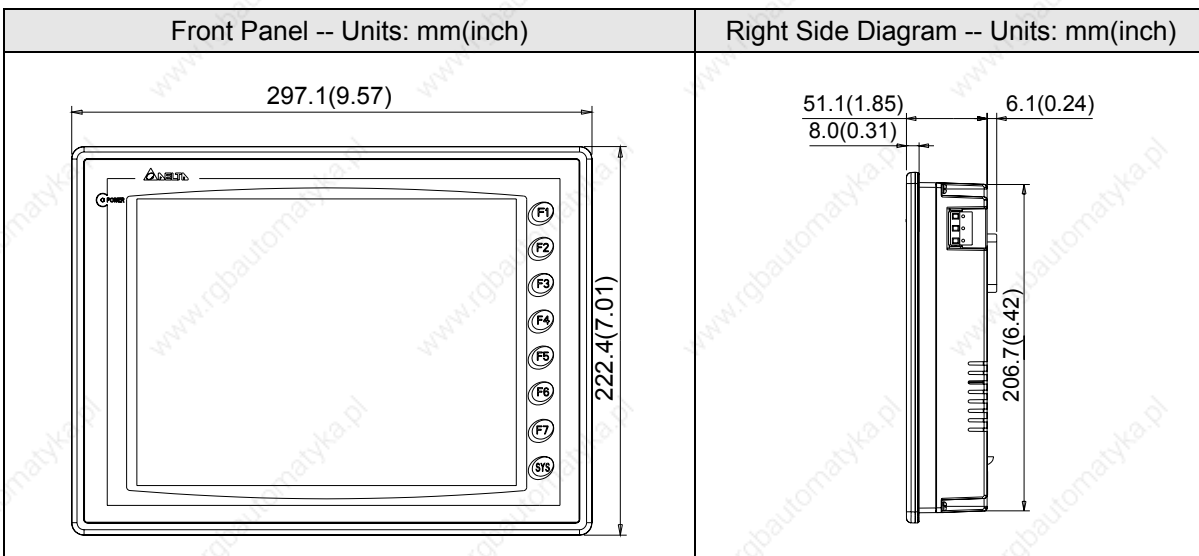
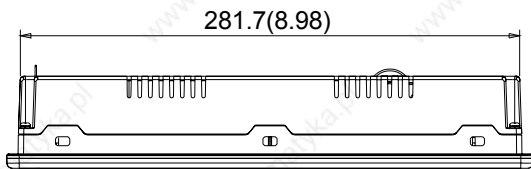
■ DOP-AE80THTD

Vertical View -- Units: mm (inch)



■ DOP-A10TCTD/DOP-AE10THTD

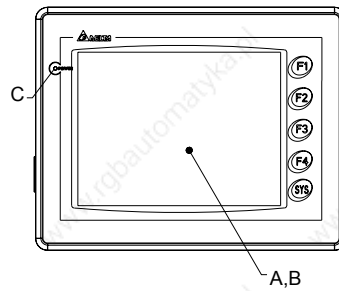
Vertical View -- Units: mm (inch)



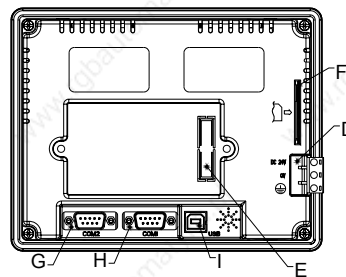
A.3 Profile

■ DOPA(E)57G(C)(B)STD

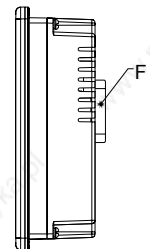
A	Display area
B	Touch screen
C	Power LED state
	Dark LED: power is off. Green LED: normal operation
D	Power input terminal
E	Expansion slot
F	Memory card
G	COM 2
H	COM 1
I	USB



Front View



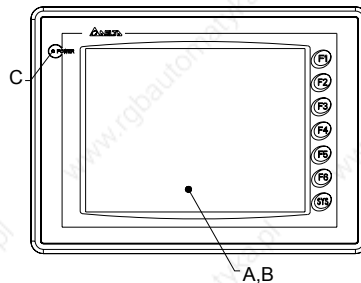
Rear View



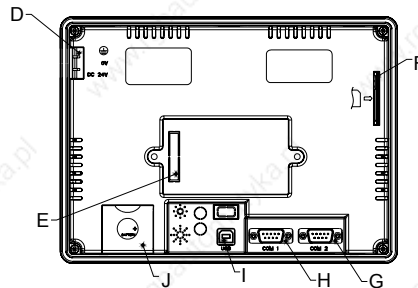
Side View

■ DOP-A75CSTD

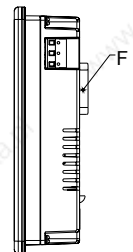
A	Display area
B	Touch screen
C	Power LED State
	Dark LED: power is off Green LED: normal operation
D	Power input terminal
E	Expansion slot
F	Memory card
G	COM 2
H	COM 1
I	USB



Front View



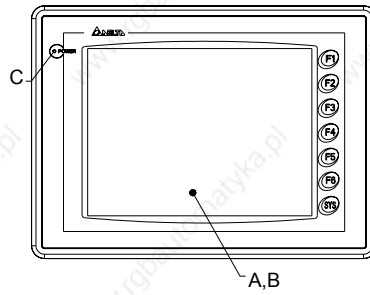
Rear View



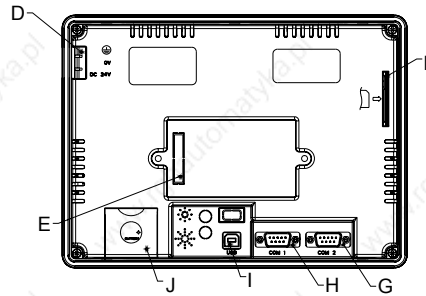
Side View

■ DOP-AE80THTD

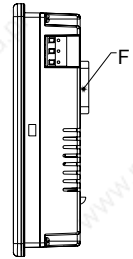
A	Display area
B	Touch screen
C	Power LED State
	Dark LED: power is off Green LED: normal operation
D	Power input terminal
E	Expansion slot
F	Memory card
G	COM 2
H	COM 1
I	USB



Front View



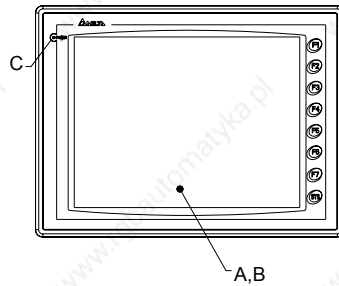
Rear View



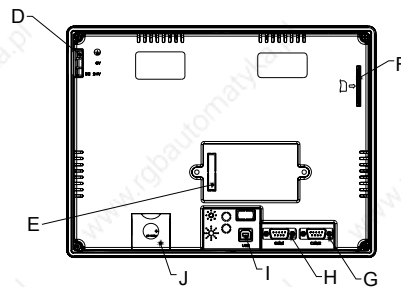
Side View

■ DOP-A10TCTD/DOP-AE10THTD

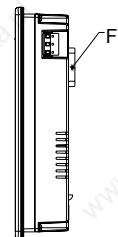
A	Display area
B	Touch screen
C	Power LED State
	Dark LED: power is off. Green LED: normal operation
D	Power input terminal
E	Expansion slot
F	Memory card
G	COM 2
H	COM 1
I	USB
J	Battery cover



Front View



Rear View

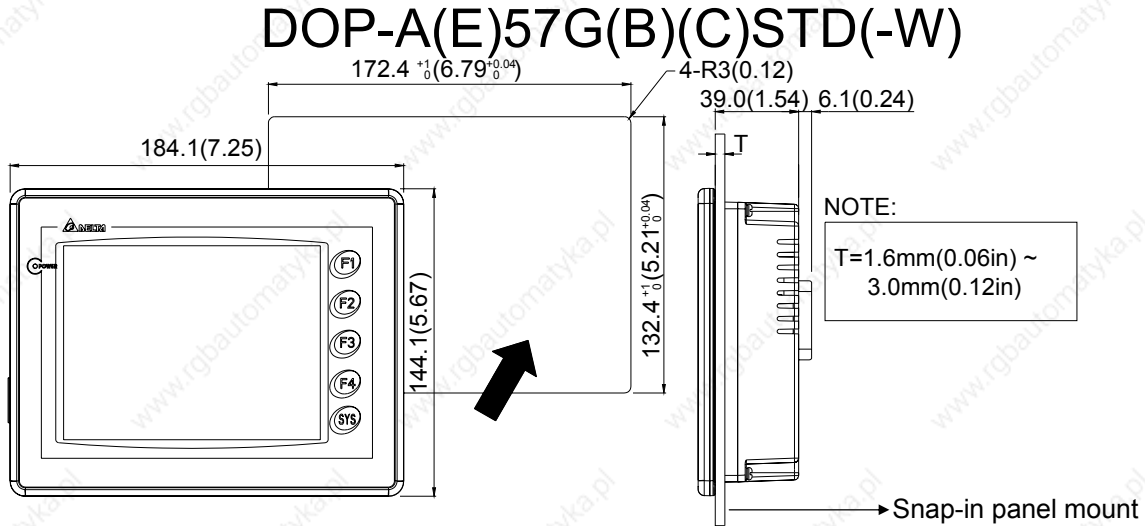


Side View

A.4 Cutout Dimension

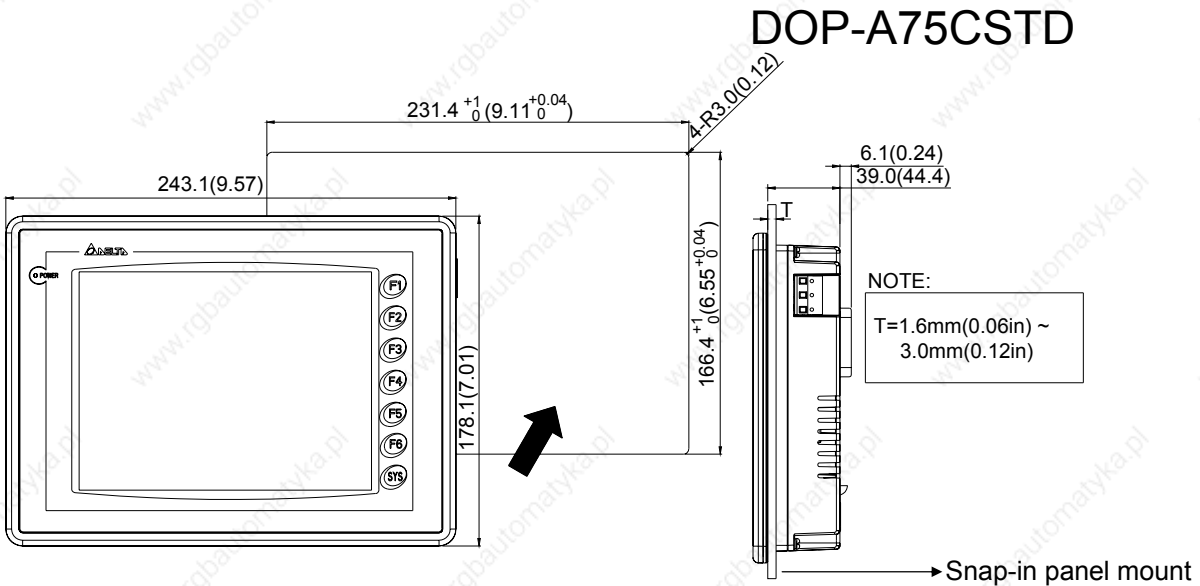
5.7": 172.4mm (6.79") +1mm (0.04") and 132.4mm (5.21") +1mm (0.04") Units: mm (inch)

Panel thickness: 1.6mm (0.06in)~3.0mm (0.12in)



7.5": 231.4mm (9.11") +1mm (0.04") and 166.4mm (6.55") +1mm (0.04") Units: mm (in.)

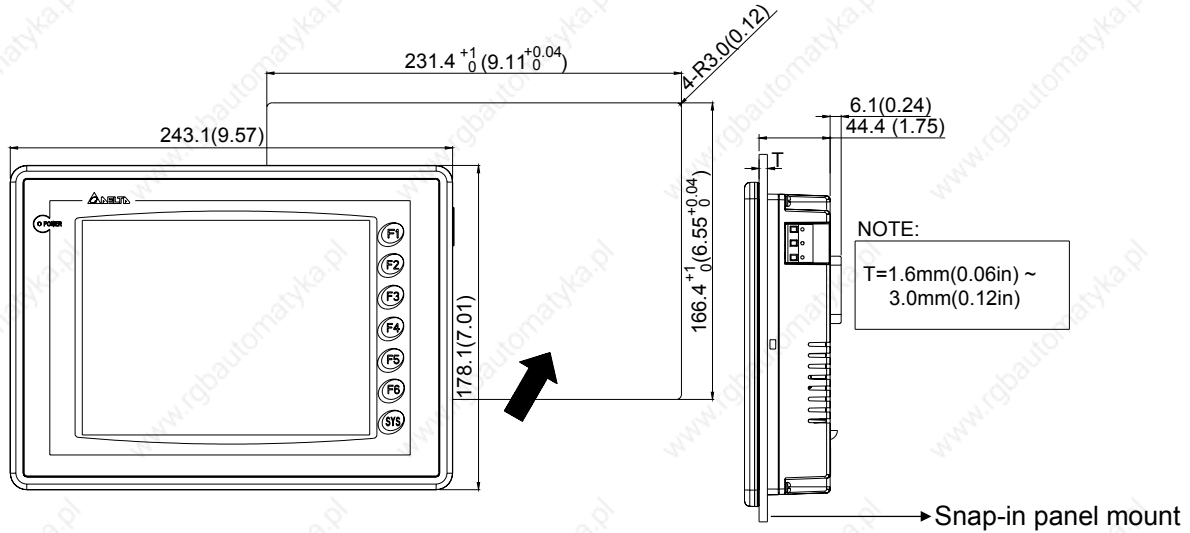
Panel thickness: 1.6mm (0.06in)~3.0mm (0.12in)



8.0": 231.4mm (9.11")+1mm (0.04") and 166.4mm (6.55")+1mm (0.04") Units: mm (in.)

Panel thickness: 1.6mm (0.06in)~3.0mm (0.12in)

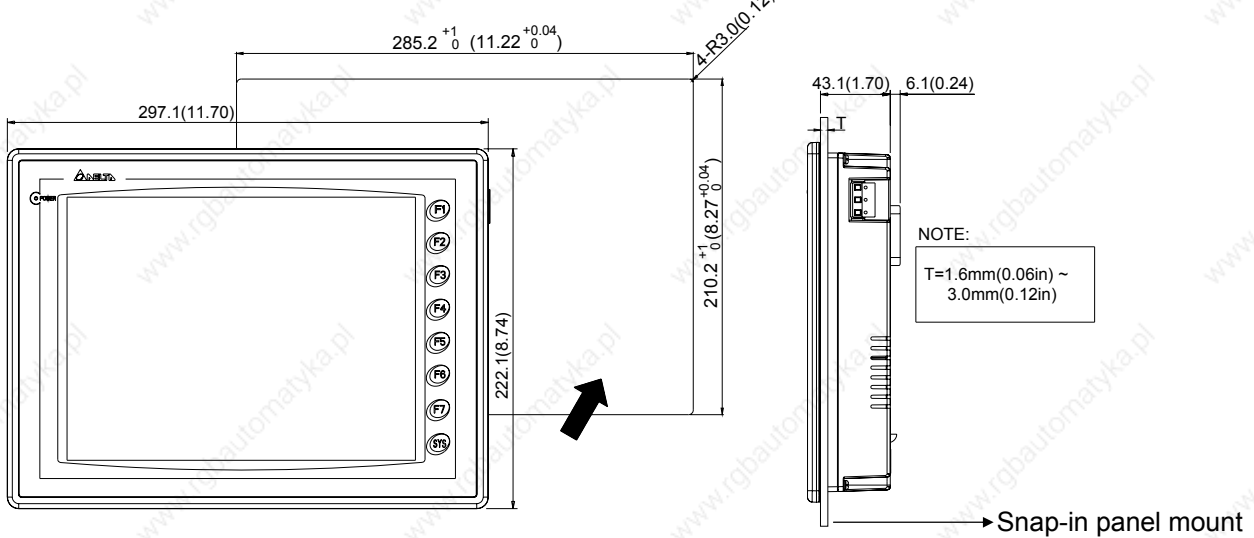
DOP-A(E)80TC(H)TD



10.4": 285.2mm (11.22")+1mm (0.04") and 210.2mm (8.27")+1mm (0.04") Units: mm (in.)

Panel thickness: 1.6mm (0.06in)~3.0mm (0.12in)

DOP-A(E)10TC(H)TD

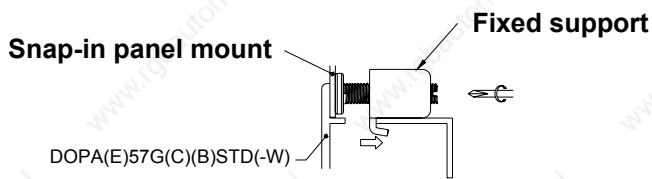
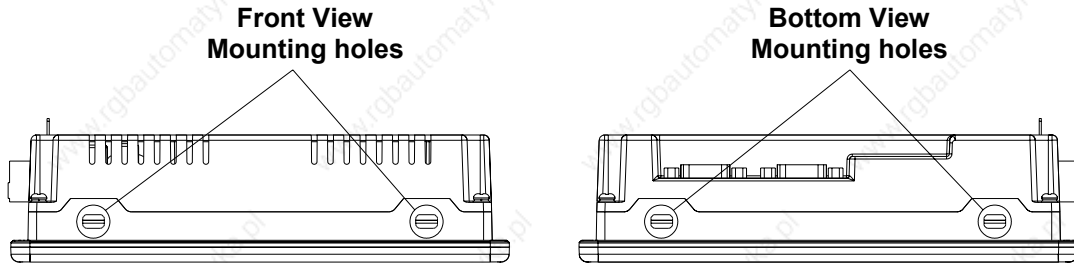


A.5 Installation

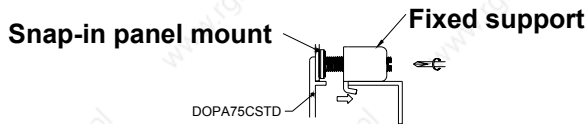
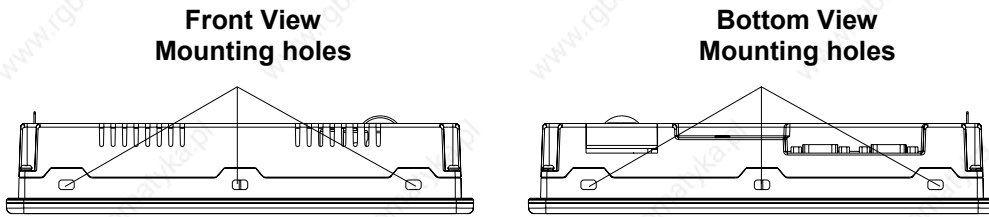


➤ If the users turn the screw exceeds torque: 0.5N.M, plastic box may be damaged.

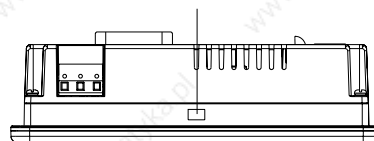
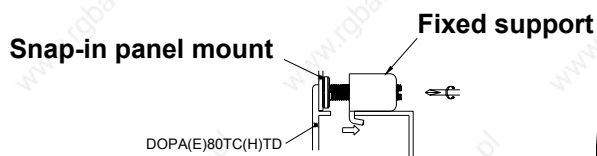
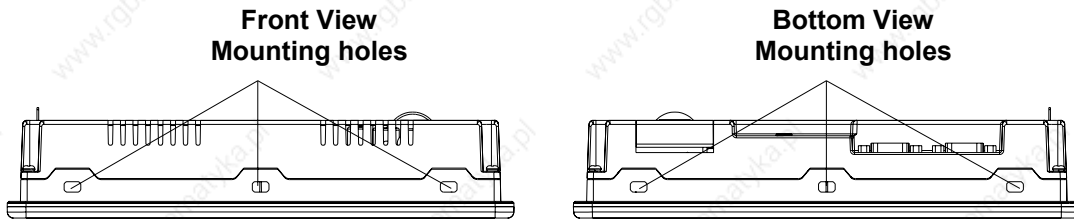
5.7" Panel (DOP-A(E)57GSTD, DOP-A(E)57CSTD, DOP-A(E)57BSTD)



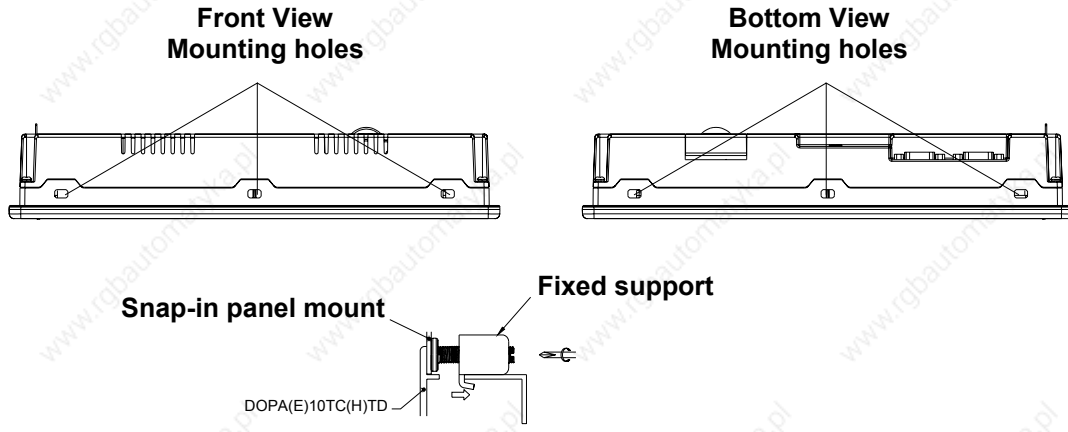
7.5" Panel (DOP-A75CSTD)



8.0" Panel (DOP-AE80THTD)



10.4" Panel (DOP-A(E)10TCTD)



Appendix B Communication

B.1 Pin Definition of Serial Communication

■ COM1

Pin	Contact
1	N.C.
2	RXD
3	TXD
4	N.C.
5	GND
6	N.C.
7	RTS
8	CTS
9	N.C.

■ COM2

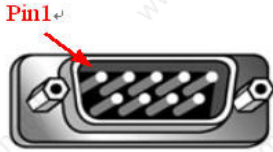
Pin	MODE1	MODE2	MODE3
	RS-232	RS-422	RS-485
1	N.C.	RXD-	D-
2	RXD	RXD+	D+
3	TXD	TXD+	D+
4	N.C.	TXD-	D-
5	GND	GND	GND
6	N.C.	RTS-	N.C.
7	RTS	RTS+	N.C.
8	CTS	CTS+	N.C.
9	N.C.	CTS-	N.C.

NOTE

- 1) Mode 3 is for RS-485. Pin 2 & 3 are D+ and pin 1 & 4 are D-.
- 2) Well-grounded is highly recommended if RS-485 & RS-422 are used for long transmission.
- 3) DO NOT connect Frame Ground (FGND) to GND. Please connect FGND to the outer covering of connector.
- 4) There are relations among transfer rate, distance and baud rate.

B.2 Cable for Download

The cable header used to connect DOP series is 9-pin D-SUB male.



Refer to the following tables for the connection to each device.

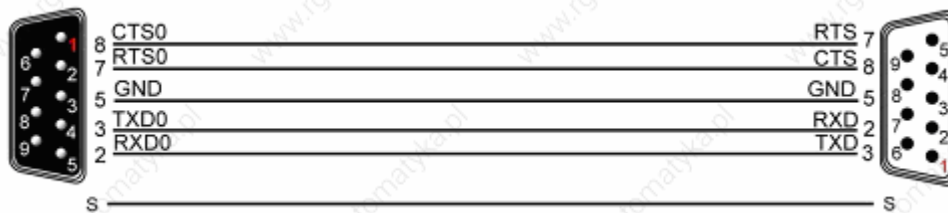
RS-232 Connection

DOP series 9 pin D-SUB male (RS-232)	PC 9 pin D-SUB female (RS-232)	PC 9 pin D-SUB female (RS-232)
RXD (2)	—————(3) TXD	<p>A diagram of a 9-pin D-SUB female connector. A red arrow points to the top-right pin, which is labeled "Pin1".</p>
TXD (3)	—————(2) RXD	
GND (5)	—————(5) GND	
RTS (7)	—————(8) CTS	
CTS (8)	—————(7) RTS	



D-SUB 9pin to DOP series (male)

D-SUB 9pin to PC (female)



Grounding + Shielding

Fig. RS-232 TO PC

USB Connection



USB TYPE B to DOP series

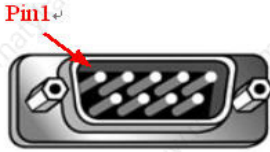
USB TYPE A to PC



Fig. USB TO PC

B.3 Communication Settings and Connections between HMI and Connectable Controllers

The cable header used to connect DOP series is 9-pin D-SUB male.



Brand	Controller Name / Series Name
Delta	<u>Delta Controller</u> For Servo/AC drive/Temperature Controller/PLC (984 RTU mode / ASCII mode)
	<u>Delta DVP PLC</u>
Allen Bradley	<u>MicroLogix PLC</u>
	<u>SLC5 PLC</u>
Danfoss	<u>VLТ 2800 (FC Protocol)</u>
Facon	<u>Facon PLC</u>
Festo	<u>Festo PLC</u>
GE Fanuc	<u>90 Series SNP PLC</u>
Hust	<u>Hust CNC Controller</u>
Jetter	<u>Nano Series PLC</u>
	<u>JC Series PLC</u>
Keyence	<u>KV/KZ Series</u>
Koyo	<u>SU/DL Series</u>
	<u>K-Sequence</u>
Lenze	<u>LECOM-A/B Protocol</u>
LG	<u>Master K120S/200S</u>
	<u>Glofa GM6 CNET</u>
	<u>Master-K CNET</u>
LI YAN	<u>LYPLC EX</u>
M2i	<u>M2i Master</u>
	<u>M2i Slave</u>
Matsushita	<u>FP Series</u>
Mirle	<u>FAMA SC</u>
Mitsubishi	<u>FX / FX2N</u>

Brand	Controller Name / Series Name
	<u>A Series/J71UC24</u>
	<u>Mitsubish A2A/A2AS/A2USH A1SH/A3N/A2ASH CPU Port</u>
	<u>Q Series CPU Port</u>
MKS	<u>CT150</u>
Modbus	<u>Modbus (Master) --- 984 RTU / ASCII mode</u>
	<u>Hexadecimal Address (Master) --- RTU / ASCII mode</u>
	<u>nW (Master) --- RTU / ASCII mode</u>
	<u>Modbus (Slave) --- RTU / ASCII mode</u>
Modicon	<u>TSX Micro (Uni-Telway)</u>
	<u>TWIDO</u>
NIKKI DENSO	<u>NCS-FI/FS Series</u>
Omron	<u>C Series</u>
	<u>CJ1/CS1 Series</u>
Siemens	<u>S7 200</u>
	<u>S7-300 (with PC Adaptor)</u>
	<u>S7-300 (without PC Adaptor)</u>
Taian	<u>TP02 PLC</u>
Vigor	<u>M Series</u>
Yokogawa	<u>ACE PLC</u>

Delta (Servo/AC Drive/PLC/Temperature) Controller

DELTA

A. HMI factory setting

Baud rate: ASCII: 9600, 7, None, 2.

RTU: 9600, 8, None, 2

Controller station number: 1.

Control area/state area: None.



1) This driver can support Delta all products, i.e. AC drive, PLC, Servo, Temperature Controller and Modbus standard connection. The users can easily set and communicate with these devices via using this driver.

2) For the people who are used to use Modbus standard connection:

Modbus / ASCII (Master), Modbus / 984 RTU (Master), Modbus / ASCII Hex Address (Master) and Modbus / RTU Hex Address (Master) can be compatible with the new Delta controller ASCII and Delta controller RTU. If desiring to change the driver settings, the users only need to change the “Controller” Option which is used to set the controller that the users use, and then the new driver can be used immediately.

B. Definition of controller Read/Write address

Registers

Register Type	Format	Read/Write range		Data length
		Word No.	Bit No.	
Servo communication address	SERVO-n	n: 0 ~ 0700h	N/A	Word
AC drive communication address	INVERTER-n	n: 0 ~ 2299h	N/A	Word
TCntrl communication address	TEMP_CTRL-n	n: 0 ~ 6000h	N/A	Word
WORD_DEVICE_X	PLC_Xn	n: 0 ~ 360(octal)	N/A	Word
WORD_DEVICE_Y	PLC_Yn	n: 0 ~ 360(octal)	N/A	Word
WORD_DEVICE_M	PLC_Mn	n: 0 ~ 1520, 1536 ~ 4080	N/A N/A	Word Word
WORD_DEVICE_S	PLC_Sn	n: 0 ~ 1008	N/A	Word
WORD_DEVICE_T	PLC_Tn	n: 0 ~ 255	N/A	Word
WORD_DEVICE_C	PLC_Cn	n: 0 ~ 199	N/A	Word
WORD_DEVICE_D	PLC_Dn	n: 0 ~ 4095, 4096 ~ 9999	N/A N/A	Word Word
WORD_DEVICE_HC	PLC_HCn	n: 200 ~ 255	N/A	Double Word

Register Type	Format	Read/Write range		Data length
		Word No.	Bit No.	
PLC communication address Module	PLC_Modulen	n: 4000 ~ 4499h	N/A	Word
Output Registers	RW-n	n: 0 ~ FFFFh	N/A	Word
Input Registers	R-n	n: 0 ~ FFFFh	N/A	Word
Output Registers	Wn	n: 40001 ~ 50000	N/A	Word
Input Registers	Wn	n: 30001 ~ 40000	N/A	Word

 **NOTE**

- 1) The above addresses of Servo, AC drive, TCNTRL (Temperature controller) and PLC Module are in hexadecimal format. PLC Word Device X and Y are in octal format. Other PLC Word Device M, S, T, C, D and HC are in decimal format.
- 2) WORD_DEVICE_X / WORD_DEVICE_Y / WORD_DEVICE_M / WORD_DEVICE_S: Address must be 0 or the multiple of 16.

Contacts

Contact type	Format	Read/Write range	
		Word No.	Bit No.
Servo communication address	SERVO-n.b	n: 0 ~ 0700h	b: 0 ~ f
AC drive communication address	INVERTER-n.b	n: 0 ~ 2299h	b: 0 ~ f
TCntrl communication address	TEMP_CTRL-n.b	n: 0 ~ 6000h	b: 0 ~ f
Servo Digital Input	SERVO_DI-n	N/A	n: 1 ~ 8
Servo Digital Output	SERVO_DO-n	N/A	n: 1 ~ 5
WORD_DEVICE_X	PLC_Xn	N/A	n: 0 ~ 377(octal)
WORD_DEVICE_Y	PLC_Yn	N/A	n: 0 ~ 377(octal)
WORD_DEVICE_M	PLC_Mn	N/A	n: 0 ~ 1535 1536 ~ 4095
WORD_DEVICE_S	PLC_Sn	N/A	n: 0 ~ 1023
WORD_DEVICE_T	PLC_Tn	N/A	n: 0 ~ 255
WORD_DEVICE_C	PLC_Cn	N/A	n: 0 ~ 255
TCntrl Bit communication address	TEMP_CTRLB-n	N/A	n: 800 ~ 8FFh
Discrete Outputs	RWB-n	N/A	n: 0 ~ FFFFh
Discrete Inputs	RB-n	N/A	n: 0 ~ FFFFh
Discrete Outputs	Bn	N/A	n: 1 ~ 10000
Discrete Inputs	Bn	N/A	n: 10001 ~ 20000

 **NOTE**

- 1) The above addresses of Servo, AC drive, TCNTRL (Temperature controller) and PLC Module are in hexadecimal format.

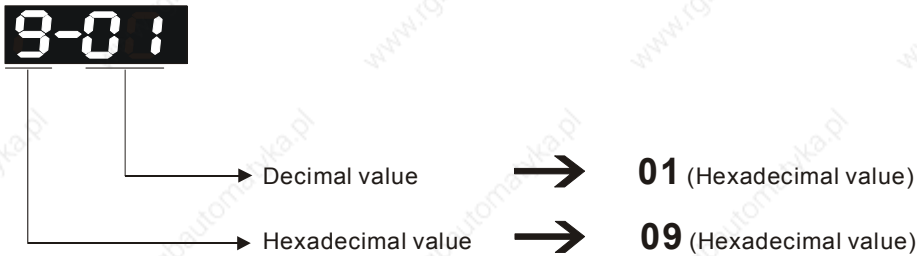
- 2) PLC Word Device X and Y are in octal format. Other PLC Word Device M, S, T, C, D and HC are in decimal format.
- 3) Servo Digital Input and Servo Digital Output are only for Servo.

Pay close attention on the following important notes:

- 4) For Delta AC drive:

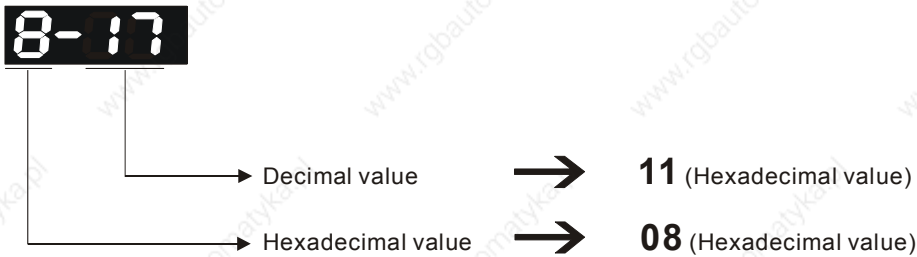
It needs to set communication address for HMI read/write address setting. (hexadecimal format for HMI). For detail information about communication address of Delta AC drive, please refer to Delta AC drive each series "User Manual".

Example 1: Parameter 9-01 of Delta VFD-S drive Transmission Speed needs set to INVERTER901 in HMI. (Decimal 9 is converted to 09 in hexadecimal and 01 is converted to 01 in hexadecimal. Therefore, setting INVERTER901 to HMI will discard the first 0)



The communication address of parameter 9-01 is 0901H.

Example 2: if set parameter 8-17 (Lower Bound of DC Braking Start-up Frequency) of Delta VFD-S drive is desired, user needs set INVERTER811 in HMI. (8 is converted to 08 in hexadecimal and 17 is converted to 11 in hexadecimal. Therefore, setting the INVERTER811 to HMI will discard the first 0)



The communication address of parameter 8-17 is 0811H.

- 5) For Delta Servo drive:

- HMI Read/Write address setting needs to input the communication address listed in SERVO "User Manual".
- Servo Digital Input and Servo Digital Output are only for Servo.

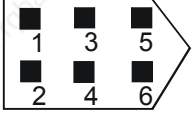
- 6) For Delta Temperature Controller (DTA series):

HMI can be set up to connect to several Delta A series temperature controllers on standard Modbus networks by using RTU transmission mode. However, the communication delay time may need to increase. Therefore, 5ms or longer is highly recommended.

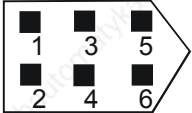
C. Connections (Connector Pinouts)

Delta Servo

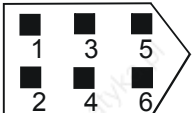
RS-232 Connection

DOP Series 9 pin D-SUB male (RS-232)	Controller CN3 cable connector (RS-232)	Controller CN3 cable connector (RS-232)
RXD (2) ————— (2) TX TXD (3) ————— (4) RX GND (5) ————— (1) GND		 <p>Top View</p>

RS-422 Connection


DOP Series 9 pin D-SUB male (RS-422)	Controller CN3 cable connector (RS-422)	Controller CN3 cable connector (RS-422)
RXD+ (2) ————— (5) TX+ RXD- (1) ————— (6) TX- TXD+ (3) ————— (3) RX+ TXD- (4) ————— (4) RX-		 <p>Top View</p>

RS-485 Connection

DOP Series 9 pin D-SUB male (RS-485)	Controller CN3 cable connector (RS-485)	Controller CN3 cable connector (RS-485)
RXD+ (2) ————┐ TXD+ (3) ————┘ ————┐ RXD- (1) ————┐ TXD- (4) ————┘ ————┐ ┌──────────┐ ┌──────────┘ └──────────┐ └──────────┘	(3) 485+ (5) 485+ (4) 485- (6) 485-	 <p>Top View</p>

Delta AC drive

RS-485 Connection

DOP Series 9 pin D-SUB male (RS-485)	Controller RJ-11 cable connector (RS-485)	Controller RJ-11 cable connector (RS-485)
RXD+ (2) ———— (4) SG+ TXD+ (3) ———— RXD- (1) ———— TXD- (4) ———— (3) SG- GND (5) ———— (2) GND	 <p>2: GND 3: SG- 4: SG+</p> <p>1 → 6 Top View</p> <p>DO NOT use Pin 1, 5 and 6 while using RS-485 communication.</p>	

- When connecting to Delta VFD-M series AC drives, please connect Pin 5 (GND) of a Delta HMI and Pin 2 (GND) of a Delta VFD-M AC drive.

Temperature Controller

RS-485 Connection

DOP Series 9 pin D-SUB male (RS-485)	Controller RS-485 cable connector
RXD+ (2) ———— D+ TXD+ (3) ———— RXD- (1) ———— TXD- (4) ———— D-	

Delta DVP PLC

DELTA

A. HMI factory settings

Baud rate: 9600, 7, Even, 2.

Controller station number: 1.

Control area/state area: D0 / D10.

B. Definition of controller Read/Write address

Registers

Register Type	Format	Read/Write Range	
		Word No.	Bit No.
X_Data	Xn	n: 0 ~ 360(octal)	N/A
Y_Data	Yn	n: 0 ~ 360(octal)	N/A
M_Data	Mn	n: 0 ~ 1520, 1536 ~ 4080	N/A
S_Data	Sn	n: 0 ~ 1008	N/A
T_Register	Tn	n: 0 ~ 255	N/A
C_Register	Cn	n: 0 ~ 199	N/A
D_Register	Dn	n: 0 ~ 4095, 4096 ~ 9999	N/A
HC_Register	Cn	n: 200 ~ 255	N/A

 **NOTE**

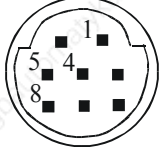
- 1) (W) is "Word".
- 2) (DW) is "Double Word".
- 3) X_Data / Y_Data / M_Data / S_Data: Address must be 0 or the multiple of 16.

Contacts

Contact type	Format	Read/Write Range	
		Word No.	Bit No.
X_Data	Xn	N/A	n: 0 ~ 377(octal)
Y_Data	Yn	N/A	n: 0 ~ 377(octal)
M_Data	Mn	N/A	n: 0 ~ 1520, 1536 ~ 4080
S_Data	Sn	N/A	n: 0 ~ 1023
T_Coil	Tn	N/A	n: 0 ~ 255
C_Coil	Cn	N/A	n: 0 ~ 255

C. Connections (Connector Pinouts)

RS-232 Connection

DOP Series 9 pin D-SUB male (RS-232)	Controller 8 pin Mini DIN male (RS-232)	Controller 8 pin Mini DIN male (RS-232)
RXD (2) ————— (5) TXD	TXD (3) ————— (4) RXD	 <p>Top View</p>
GND (5) ————— (8) GND		

RS-485 Connection

DOP Series 9 pin D-SUB male (RS-485)	Controller RS-485 cable connector
RXD+ (2) ———— D+ TXD+ (3) ———— D+	
RXD- (1) ———— D- TXD- (4) ———— D-	

AllenBradley MicroLogix PLC

DELTA

A. HMI factory setting

Baud rate: 19200, 8, None, 1.

PLC station number: 1.

Control area/state area: B3:0/B3:10.

B. Definition of controller Read/Write address

Registers

Register Type	Format	Read/Write Range		
		Word No.	Bit No.	
			Low Byte	High Byte File No.
Output file	O:n	n: 0 ~ 3	N/A	0
Input file	I:n	n: 0 ~ 3	N/A	1
Status file	S2:n	n: 0 ~ 65	N/A	2
Bit file	B3:n	n: 0 ~ 255	N/A	3
Timer flag	T4:n	n: 0 ~ 255	N/A	4
Timer Preset Value	T4:n.PRE	n: 0 ~ 255	N/A	4
Timer Accumulator Value	T4:n.ACC	n: 0 ~ 255	N/A	4
Counter flag	C5:n	n: 0 ~ 255	N/A	5
Counter Preset Value	C5:n.PRE	n: 0 ~ 255	N/A	5
Counter Accumulator Value	C5:n.ACC	n: 0 ~ 255	N/A	5
Control file	R6:n	n: 0 ~ 255	N/A	6
Control Size of Bit Array	R6:n.LEN	n: 0 ~ 255	N/A	6
Control Reserved file	R6:n.POS	n: 0 ~ 255	N/A	6
Integer file	N7:n	n: 0 ~ 255	N/A	7

- Bit No : Low byte is not used, so the value is 0. High byte stores file number.
- Data Size : Word.
- T4, C5 and R6 only read 1 Word once.
- If reading multiple Words once, the communication speed of PLC will be slow.

 **NOTE**

- 1) If last communication data has been memorized by PLC (PLC will send 0x10 0x05 consecutively), communication may be fail. At this time, power off and power up HMI or power off and power up PLC once.

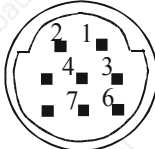
Contacts

Contact Type	Format	Read/Write Range		
		<u>Word No.</u>	<u>Bit No.</u>	
			Low Byte	High Byte
			Bits	File No.
Output	O:n/b	n: 0 ~ 3	b: 0 ~ 15	0
Input	I:n/b	n: 0 ~ 3	b: 0 ~ 15	1
Status	S2:n/b	n: 0 ~ 65	b: 0 ~ 15	2
Bit	B3:n/b	n: 0 ~ 255	b: 0 ~ 15	3
Timer	T4:n/b	n: 0 ~ 255	b: 0 ~ 15	4
	T4:n/EN	n: 0 ~ 255	15	
	T4:n/TT	n: 0 ~ 255	14	
	T4:n/DN	n: 0 ~ 255	13	
Timer Preset Value	T4:n.PRE/b	n: 0 ~ 255	b: 0 ~ 15	4
Timer Accumulator Value	T4:n.ACC/b	n: 0 ~ 255	b: 0 ~ 15	4
Counter flag	C5:n/b	n: 0 ~ 255	b: 0 ~ 15	5
	C5:n/CU	n: 0 ~ 255	15	
	C5:n/CD	n: 0 ~ 255	14	
	C5:n/DN	n: 0 ~ 255	13	
	C5:n/OV	n: 0 ~ 255	12	
	C5:n/UN	n: 0 ~ 255	11	
	C5:n/UA	n: 0 ~ 255	10	
Counter Preset Value	C5:n.PRE/b	n: 0 ~ 255	b: 0 ~ 15	5
Counter Accumulator Value	C5:n.ACC/b	n: 0 ~ 255	b: 0 ~ 15	5
Control	R6:n/b	n: 0 ~ 255	b: 0 ~ 15	6
	R6:n/EN	n: 0 ~ 255	15	
	R6:n/DN	n: 0 ~ 255	13	
	R6:n/ER	n: 0 ~ 255	11	
	R6:n/UL	n: 0 ~ 255	10	
	R6:n/IN	n: 0 ~ 255	9	
	R6:n/FD	n: 0 ~ 255	8	
Control Size of Bit Array	R6:n.LEN/b	n: 0 ~ 255	b: 0 ~ 15	6
Control Reserved	R6:n.POS/b	n: 0 ~ 255	b: 0 ~ 15	6
Integer	N7:n/b	n: 0 ~ 255	b: 0 ~ 15	7

➤ Bit No : Low byte stores Bit address. High byte stores file number.

C. Connections (Connector Pinouts)

RS-232 Connection

DOP Series 9 pin D-SUB male (RS-232)	Controller 8 pin Mini DIN male (RS-232)	Controller 8 pin Mini DIN male (RS-232)
<p>RXD (2) ————— (7) TXD</p> <p>TXD (3) ————— (4) RXD</p> <p>GND (5) ————— (2) GND</p> <p> (3) RTS</p> <p> (6) CTS</p>		 <p>Top View</p>

AllenBradley SLC5 PLC

DELTA

A. HMI factory setting

Baud rate: 19200, 8, None, 1.

PLC station number: 1.

Control area/state area: B3:0/B3:10.



1) Error Check uses CRC (Cyclical Redundancy Check).

B. Definition of controller Read/Write address

Registers

Register Type	Format	Read/Write Range		
		Word No.	Bit No.	
		Element No.	Low Byte	High Byte
			Slot or File No.	
Output file	O:n O:s.n	n: 0 ~ 30	N/A	Slot No. s = 0 s: 0 ~ 255 File No. = 0
Input file	I:n I:s.n	n: 0 ~ 30	N/A	Slot No. s = 0 s: 0 ~ 255 File No. = 1
Status file	S2:n	n: 0 ~ 255	N/A	File No. = 2
Bit file	Bf:n	n: 0 ~ 255	N/A	f: 10 ~ 255 If f is ignored, file no. will be default setting 3.
Timer flag	Tf:n	n: 0 ~ 255	N/A	f: 10 ~ 255 If f is ignored, file no. will be default setting 4.
Timer Preset Value	Tf:n.PRE	n: 0 ~ 255	N/A	f: 10 ~ 255 If f is ignored, file no. will be default setting 4.
Timer Accumulator Value	Tf:n.ACC	n: 0 ~ 255	N/A	f: 10 ~ 255 If f is ignored, file no. will be default setting 4.
Counter flag	Cf:n	n: 0 ~ 255	N/A	f: 10 ~ 255 If f is ignored, file no. will be default setting 5.
Counter Preset Value	Cf:n.PRE	n: 0 ~ 255	N/A	f: 10 ~ 255 If f is ignored, file no. will be default setting 5.

Register Type	Format	Read/Write Range		
		Word No.	Bit No.	
		Element No.	Low Byte	High Byte
			Slot or File No.	
Counter Accumulator Value	Cf:n.ACC	n: 0 ~ 255	N/A	f: 10 ~ 255 If f is ignored, file no. will be default setting 5.
Control file	Rf:n	n: 0 ~ 255	N/A	f: 10 ~ 255 If f is ignored, file no. will be default setting 6.
Control Size of Bit Array	Rf:n.LEN	n: 0 ~ 255	N/A	f: 10 ~ 255 If f is ignored, file no. will be default setting 6.
Control Reserved file	Rf:n.POS	n: 0 ~ 255	N/A	f: 10 ~ 255 If f is ignored, file no. will be default setting 6.
Integer file	Nf:n	n: 0 ~ 255	N/A	f: 10 ~ 255 If f is ignored, file no. will be default setting 7.

➤ **Bit No** : Low byte is not used, so the value is 0. High byte stores file number.

Contacts

Contact Type	Format	Read/Write Range		
		Word No.	Bit No.	
		Element No.	Low Byte	High Byte
			Bits	Slot or File No.
Output	O:n/b O:s.n/b	n: 0 ~ 30	b: 0 ~ 15	Slot No. s = 0 s: 0 ~ 255 File No. = 0
Input	I:n/b I:s.n/b	n: 0 ~ 30	b: 0 ~ 15	Slot No. s = 0 s: 0 ~ 255 File No. = 1
Status	S2:n/b	n: 0 ~ 31	b: 0 ~ 15	2
Bit	Bf:n/b	n: 0 ~ 255	b: 0 ~ 15	f: 10 ~ 255 If f is ignored, file no. will be default setting 3.
Timer	Tf:n/b Tf:n/EN Tf:n/TT Tf:n/DN	n: 0 ~ 255 n: 0 ~ 255 n: 0 ~ 255 n: 0 ~ 255	b: 0 ~ 15 15 14 13	f: 10 ~ 255 If f is ignored, file no. will be default setting 4.
Timer Preset Value	Tf:n.PRE/b	n: 0 ~ 255	b: 0 ~ 15	f: 10 ~ 255 If f is ignored, file no. will be default setting 4.

Contact Type	Format	Read/Write Range		
		Word No.	Bit No.	
		Element No.	Low Byte	High Byte
			Bits	Slot or File No.
Timer Accumulator Value	Tf:n.ACC/b	n: 0 ~ 255	b: 0 ~ 15	f: 10 ~ 255 If f is ignored, file no. will be default setting 4.
Counter flag	Cf:n/b	n: 0 ~ 255	b: 0 ~ 15	f: 10 ~ 255 If f is ignored, file no. will be default setting 5.
	Cf:n/CU	n: 0 ~ 255	15	
	Cf:n/CD	n: 0 ~ 255	14	
	Cf:n/DN	n: 0 ~ 255	13	
	Cf:n/OV	n: 0 ~ 255	12	
	Cf:n/UN	n: 0 ~ 255	11	
	Cf:n/UA	n: 0 ~ 255	10	
Counter Preset Value	Cf:n.PRE/b	n: 0 ~ 255	b: 0 ~ 15	f: 10 ~ 255 If f is ignored, file no. will be default setting 5.
Counter Accumulator Value	Cf:n.ACC/b	n: 0 ~ 255	b: 0 ~ 15	f: 10 ~ 255 If f is ignored, file no. will be default setting 5.
Control	Rf:n/b	n: 0 ~ 255	b: 0 ~ 15	f: 10 ~ 255 If f is ignored, file no. will be default setting 6.
	Rf:n/EN	n: 0 ~ 255	15	
	Rf:n/DN	n: 0 ~ 255	13	
	Rf:n/ER	n: 0 ~ 255	11	
	Rf:n/UL	n: 0 ~ 255	10	
	Rf:n/IN	n: 0 ~ 255	9	
	Rf:n/FD	n: 0 ~ 255	8	
Control Size of Bit Array	Rf:n.LEN/b	n: 0 ~ 255	b: 0 ~ 15	f: 10 ~ 255 If f is ignored, file no. will be default setting 6.
Control Reserved	Rf:n.POS/b	n: 0 ~ 255	b: 0 ~ 15	f: 10 ~ 255 If f is ignored, file no. will be default setting 6.
Integer	Nf:n/b	n: 0 ~ 255	b: 0 ~ 15	f: 10 ~ 255 If f is ignored, file no. will be default setting 7.

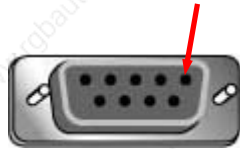
➤ **Bit No** : Low byte stores Bit address. High byte stores file number.



1) Device O and I need to assign Slot No. (s). If not assign Slot No., it will use default setting 0.

C. Connections (Connector Pinouts)

RS-232 Connection

DOP series 9 pin D-SUB male (RS-232)	Controller 9 pin D-SUB female (RS-232)	Controller 9 pin D-SUB female (RS-232)
RXD (2) ————— (3) TXD TXD (3) ————— (2) RXD GND (5) ————— (5) SG (7) RTS (8) CTS		 <p>Pin1</p> <p>Top View</p>

Danfoss VLT 2800 (FC Protocol)

DELTA

A. HMI factory setting

Baud rate: 9600, 8, Even, 1, RS-485.

PLC station number: 1.

Control area/state area: None / None.



- 1) Delta HMI can be connected to for VLT-2800, 5000, 6000, 7000 controllers.
- 2) Each data length format of Danfoss AC drive parameter is not fixed, therefore, "Multiple Duplicate" function is not provided.
- 3) Max. supported alarm number is 16. If the alarm number is over 16, a fault will occur.
- 4) Not support "optimum read/write" characteristic.
- 5) If the selected element is a string, the minimum data length should be more than 2.

B. Definition of controller Read/Write address

Registers

Register Type	Format	Read/Write Range		
		Word No.	Bit No.	
			Low Byte	High Byte
			Index No.	
Parameter	Pn:l	n: 0 ~ 999	0	l: 0 ~ 31
Control Word	CTRWD	0	N/A	N/A
Status Word	STAWD	0	N/A	N/A

- Index No : If the index No. is not used, its default setting will be 0. The default setting of index No. for parameter P606 ~ P617 is 1.
- Please notice that it is necessary to input the index No. when using some parameters of Danfoss controllers. At this time, please pay close attention on the setting range of index number. If the setting range is not started from 0, the parameter read & write failure will occur. For example, the index No. setting range of the parameter P615 is from 1 to 20, if the users do not input the index No., the system will assume the index number is 0 (default setting) and the a fault will occur when the users read or write the parameter.
- CTRWD: Write-only. (Can not be used on the devices which can display the value or input value. It is recommended to be used on the setting value/setting constant (button), or marco function.)
- STAWD: Read-only.
- Control & Status Word: Please refer to the explanation on the next page (page B-20).

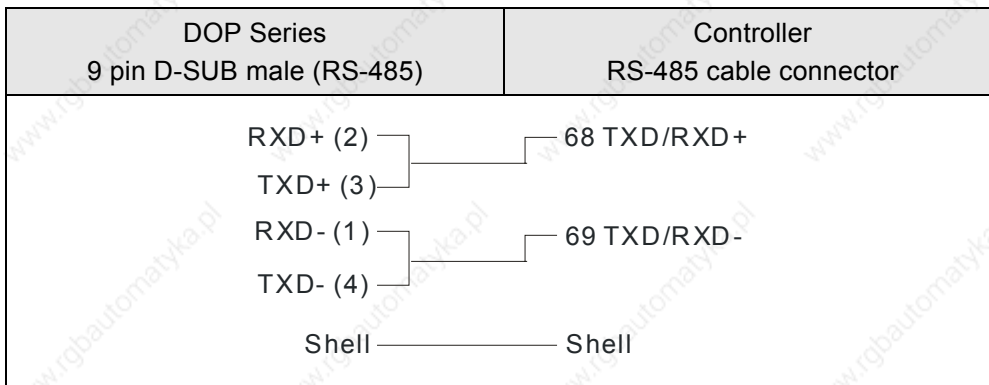
Contacts

Contact Type	Format	Read/Write Range		
		Word No.	Bit No.	
		Element No.	Low Byte	High Byte
			Bits	Index No.
Parameter	Pn:l.b	n: 0 ~ 999	b: 0 ~ 31	l: 0 ~ 31

➤ Bit No : Low byte stores Bit address. High byte stores index number.

C. Connections (Connector Pinouts)

RS-485 Connection



Explanation of Control Word & Status Word

Control Word

Bit	Bit = 0	Bit = 1
15	No Function	Reversing
14	Choice of Setup 2 (msb)	
13	Choice of Setup 1 (lsb)	
12	No Function	Relay 04 activated
11	No Function	Relay 01 activated
10	Data Not Valid	Valid
9	Ramp 1	Ramp2
8	Jog 1 OFF	ON
7	No Function	Reset
6	Ramp Stop	Start
5	Hold	Ramp Enable
4	Quick-Stop	Ramp
3	Coasting	Enable
2	DC Brake	Ramp
1	Preset reference choice msb	
0	Preset reference choice msb	

➤ When Bit 10 = 1 (Data Valid), the Control Word is valid.

Status Word

Bit	Bit = 0	Bit = 1
15	Timer OK	Above limit
14	Torque OK	Above limit
13	Voltage OK	Above limit
12	Temperature OK	Over-Temp, auto-start pending
11	Not Running	Running
10	Out of Range	Frequency OK
9	Local Control	Bus Control
8	Speed \neq reference	Speed = reference
7	No Warning	Warning
6	Reserved	
5	Reserved	
4	Reserved	
3	No Fault	Trip
2	Coasting	Enabled
1	VLT not ready	Ready
0	Control not ready	Ready

Facon FB Series PLC

DELTA

A. HMI factory settings

Baud rate: 9600, 7, Even, 1.

Controller Station number: 1.

Control area/state area: R0 / R10.

B. Definition of controller Read/Write address

Registers

Register Type	Format	Read/Write range		Data length
		Word No.	Bit No.	
Input Relay	WXn	n: 0 ~ 9992	N/A	Byte
Output Relay	WYn	n: 0 ~ 9992	N/A	Byte
Internal Relay	WMn	n: 0 ~ 9992	N/A	Byte
Step Relay	WSn	n: 0 ~ 9992	N/A	Byte
Data Register	Rn	n: 0 ~ 65534	N/A	Word
Data Register	Dn	n: 0 ~ 65534	N/A	Word
Timer Present Value	RTn	n: 0 ~ 9999	N/A	Word
Counter Present Value	RCn	n: 0 ~ 9999	N/A	Word
Data Register	DRCn	n: 200 ~ 255	N/A	Double Word

➤ Input Relay / Output Relay / Internal Relay / Special Relay: Address must be the multiple of 8.

Contacts

Contact type	Format	Read/Write range	
		Word No.	Bit No.
Input Relay	Xn	N/A	n: 0 ~ 9999
Output Relay	Yn	N/A	n: 0 ~ 9999
Internal Relay	Mn	N/A	n: 0 ~ 9999
Step Relay	Sn	N/A	n: 0 ~ 9999
Timer Flag	Tn	N/A	n: 0 ~ 9999
Counter Flag	Cn	N/A	n: 0 ~ 9999

Festo PLC

DELTA

A. HMI factory settings

Baud rate: 9600, 8, None, 1.

Controller Station number: 0. (no PLC station number in protocol)

Control area/state area: R0 / R10.



1) Connectable PLC: FEC-FC Model

B. Definition of controller Read/Write address

Registers

Register Type	Format	Word No.	Bit No.	Data Size
WORD_DEVICE_IW	lwn	n: 0 ~ 255	N/A	Word
WORD_DEVICE_OW	Own	n: 0 ~ 255	N/A	Word
WORD_DEVICE_FW	FWn	n: 0 ~ 9999	N/A	Word
WORD_DEVICE_TW	TWn	n: 0 ~ 255	N/A	Word
WORD_DEVICE_CW	CWn	n: 0 ~ 255	N/A	Word
WORD_DEVICE_R	Rn	n: 0 ~ 255	N/A	Word
WORD_DEVICE_TP	TPn	n: 0 ~ 255	N/A	Word
WORD_DEVICE_CP	CPn	n: 0 ~ 255	N/A	Word

Contacts

Register Type	Format	Word No.	Bit No.
BIT_DEVICE_I	ln.b	n: 0 ~ 255	b: 0 ~ 15
BIT_DEVICE_O	On.b	n: 0 ~ 255	b: 0 ~ 15
BIT_DEVICE_F	Fn.b	n: 0 ~ 9999	b: 0 ~ 15
BIT_DEVICE_T	Tn	N/A	n: 0 ~ 255
BIT_DEVICE_C	Cn	N/A	n: 0 ~ 255
BIT_DEVICE_TON	TONn	N/A	n: 0 ~ 255
BIT_DEVICE_TOFF	TOFFn	N/A	n: 0 ~ 255

- BIT_DEVICE_T / BIT_DEVICE_C / BIT_DEVICE_TON / BIT_DEVICE_TOFF: Only 1 Bit can be transferred for each communication.
- Only 1 Bit or 1 Word can be transferred for each write command.

C. Connections



-
- 1) Communication port of PLC: COM port
 - 2) It needs to use the dedicated cable for FESTO controllers → Cable for transferring TTL to RS-232 and it is 6 pin RJ-12 connector at PLC side.

GE Fanuc 90 Series SNP PLC

DELTA

A. HMI factory settings

Baud rate: 19200, 8, ODD, 1.

Controller Station number: 0. (no PLC station number in protocol, therefore, only 1(HMI) to 1 (PLC) communication is allowed.)

Control area/state area: %R1 / %R10.



- 1) Please notice that no PLC station number in protocol, therefore, only 1(HMI) to 1 (PLC) communication is allowed.
- 2) If the PLC enabled "Check Password" function, the user needs to set the password by clicking Option > Configuration > Communication. The user can find Controller Settings and set PLC password on Communication Tab in the Configuration dialog box. Please enter a 4-digit password (If entering a password that exceeds 4-digit number, only the first 4-digit number is valid).

B. Definition of controller Read/Write address

Registers

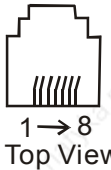
Register Type	Format	Read/Write range		Data length
		Word No.	Bit No.	
Discrete Inputs	%In	n: 1 ~ 12288	N/A	Word (the multiple of 16 + 1)
Discrete Outputs	%Qn	n: 1 ~ 12288	N/A	Word (the multiple of 16 + 1)
Discrete Temporaries	%Tn	n: 1 ~ 256	N/A	Word (the multiple of 16 + 1)
Discrete Internals	%Mn	n: 1 ~ 12288	N/A	Word (the multiple of 16 + 1)
%SA Discretes	%SAn	n: 1 ~ 128	N/A	Word (the multiple of 16 + 1)
%SB Discretes	%SBn	n: 1 ~ 128	N/A	Word (the multiple of 16 + 1)
%SC Discretes	%SCn	n: 1 ~ 128	N/A	Word (the multiple of 16 + 1)
%S Discretes	%S-n	n: 1 ~ 128	N/A	Word (the multiple of 16 + 1)
Genius Global Data	%Gn	n: 1 ~ 7680	N/A	Word (the multiple of 16 + 1)
Registers	%Rn	n: 1 ~ 16384	N/A	Word
Analog Inputs	%AI n	n: 1 ~ 8192	N/A	Word
Analog Outputs	%AQn	n: 1 ~ 8192	N/A	Word

Contacts

Contact Type	Format	Read/Write range	
		Word No.	Bit No.
Discrete Inputs	%In	N/A	n: 1 ~ 12288
Discrete Outputs	%Qn	N/A	n: 1 ~ 12288
Discrete Temporaries	%Tn	N/A	n: 1 ~ 256
Discrete Internals	%Mn	N/A	n: 1 ~ 12288
%SA Discrettes	%SAn	N/A	n: 1 ~ 128
%SB Discrettes	%SBn	N/A	n: 1 ~ 128
%SC Discrettes	%SCn	N/A	n: 1 ~ 128
%S Discrettes	%-Sn	N/A	n: 1 ~ 128
Genius Global Data	%Gn	N/A	n: 1 ~ 7680

C. Connections (Connector Pinouts)

RS-232

DOP 9 pin D-SUB male (RS-232)	Controller RJ-45 cable connector (RS-232)	Controller RJ-45 cable connector (RS-232)
RXD (2) ————— (5) TXD TXD (3) ————— (6) RXD GND (5) ————— (4) GND	 <p>1 → 8 Top View</p>	

HUST CNC Controller

DELTA

A. HMI factory settings

Baud rate: 9600, 7, EVEN, 2.

Controller station number: 0.

Control area/state area: W0 / W10.

B. Definition of controller Read/Write address

Registers

Register Type	Format	Read/Write Range		Data Length
		Word No.	Bit No.	
Word Register	Wn	n: 0 ~ 13500	N/A	Word
Double Word Register	Dn	n: 0 ~ 13500	N/A	Double Word




1) The unit for Hust CNC controller is D Word and Wn is the low word of Dn.

Contacts

Contact Type	Format	Read/Write range	
		Word No.	Bit No.
BIT_DEVICE_B	Bm.n	m: 0 ~ 13500	n: 0 ~ 31
BIT_DEVICE_I	In	N/A	n: 0 ~ 255 (8 DW)
BIT_DEVICE_O	On	N/A	n: 0 ~ 255 (8 DW)
BIT_DEVICE_C	Cn	N/A	n: 0 ~ 255 (8 DW)
BIT_DEVICE_S	Sn	N/A	n: 0 ~ 255 (8 DW)
BIT_DEVICE_A	An	N/A	n: 0 ~ 1023 (32 DW)

C. Connections (Connector Pinouts)

RS-232

DOP Series 9 pin D-SUB male (RS-232)	Controller 9 pin D-SUB male (RS-232)	Controller 9 pin D-SUB male (RS-232)
	RXD (2) ————— (2) TXD TXD (3) ————— (3) RXD GND (5) ————— (5) SG (8) RTS (7) CTS	 Top View

Jetter Nano Series PLC

DELTA

A. HMI factory settings

Baud rate: 9600, 8, EVEN, 1 (RS-232).

Controller station number: 0. (no PLC station number in protocol, therefore, only 1(HMI) to 1 (PLC) communication is allowed.)

Control area/state area: WR0 / WR10.



- 1) Please notice that no PLC station number in protocol, therefore, only 1(HMI) to 1 (PLC) communication is allowed.
- 2) Only 1 Bit or 1 Word can be transferred for each communication.
- 3) In general, each register occupies max. 24 Bits. However, some registers occupies 8 Bits only.
- 4) Because the initial time of this controller is longer, it is recommended to set HMI startup delay time (Recommended time is 10 seconds).
- 5) When the register R is used for Double Word device, please set its format as signed format. (The default format in Screen Editor is signed format)

B. Definition of controller Read/Write address

Registers

Register Type	Format	Read/Write Range		Data Length
		Word No.	Bit No.	
16 Bits Register	WRn	n: 0 ~ 32767	N/A	16 Bits
32 Bits Register	Rn	n: 0 ~ 32767	N/A	24 Bits

Only the first 16 bits are used for WRn registers.

Only the first 24 bits are used for Rn registers, the highest 8 bits (Bit 24 ~ 31) are set to 0 by default setting. (24-bit Integer : If in decimal format, the range is -8388608 ~ +8388607. If in hexadecimal format, the range is 0x000000 ~ 0xFFFFFFFF.)



- 1) The difference between WRn and Rn:
 - When using devices that the data length is in Word, only Bit 0 ~ 15 are valid for both of WRn and Rn registers.
 - When using devices that the data length is in Double Word, if the read/write address format is set to WRn, the Bit 0 ~ 15 of WRn register is the low word of a read/write value, the Bit 0 ~ 15 of WRn+1 register is the high word of a read/write value.

if the read/write address format is set to Rn, only Bit 0 ~ 23 are valid for Rn registers.

(Notice: As the Jetter controller is a 24-bit format controller, the valid setting range is 24 Bits. If exceeds this range, HMI will stop read/write operation and show “...Value is Incorrect” on the screen. So, please do not set any bit on Bit24 ~ Bit31 (Bit24 ~ Bit31 cannot be written).


- When using devices that the data length is in m Words,
 if the read/write address format is set to WRn, the Bit 0 ~ 15 of WRn register is the lowest word of a read/write value and the Bit 0 ~ 15 of WRn+m-1 register is the highest word of a read/write value.
 if the read/write address format is set to Rn, the Bit 0 ~ 23 of Rn register is the lowest word of a read/write value and the Bit 0 ~ 23 of Rn+1 register is the highest word of a read/write value.
 Each register is regards as a “Double Word”. The value of Bit24 ~ Bit31 is 0.

Contacts

Contact type	Format	Read/Write Range	
		Word No.	Bit No.
Input Relay	Inbb	n: 1 ~ 32	bb: 01 ~ 08
Output Relay	Onbb	n: 1 ~ 32	bb: 01 ~ 08
Flag Relay	Fn	N/A	n: 0 ~ 32767

C. Connections (Connector Pinouts)

RS-232

DOP Series 9 pin D-SUB male (RS-232)	Controller 9 pin D-SUB male (RS-232)	Controller 9 pin D-SUB male (RS-232)
RXD (2) ————— (2) TXD	TXD (3) ————— (3) RXD	 Top View
GND (5) ————— (7) GND		

- The pin definition of the cable of Jetter controller is different than the general cable. Please pay close attention on it and do not mistake.

Jetter JC Series PLC

DELTA**A. HMI factory settings**

Baud rate: 9600, 8, EVEN, 1 (RS-232).

Controller station number: 0. (no PLC station number in protocol, therefore, only 1(HMI) to 1 (PLC) communication is allowed.)

Control area/state area: WR0 / WR10.



- 1) Please notice that no PLC station number in protocol, therefore, only 1(HMI) to 1 (PLC) communication is allowed.
- 2) Only 1 Bit or 1 Word / 2 Words can be transferred for each read and write command.

B. Definition of controller Read/Write address**Registers**

Register Type	Format	Read/Write Range		Data Length
		Word No.	Bit No.	
16 Bits Register	WRn	n: 0 ~ 32767	N/A	16 Bits
32 Bits Register	Rn	n: 0 ~ 32767	N/A	24 Bits

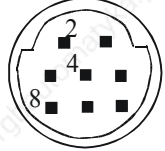
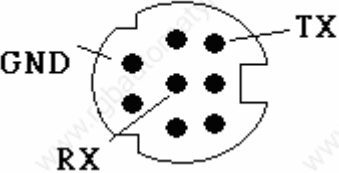
The characteristics of WRn and Rn of JC series are the same as the Nano series. Please refer to page B-29 and B-30.

Contacts

Contact type	Format	Read/Write Range	
		Word No.	Bit No.
Input Relay	Inbb	n: 1 ~ 32	bb: 01 ~ 16
Output Relay	Onbb	n: 1 ~ 32	bb: 01 ~ 16
Flag Relay	Fn	N/A	n: 0 ~ 32767

C. Connections (Connector Pinouts)

RS-232

DOP Series 9 pin D-SUB male (RS-232)	Controller 8 pin Mini DIN male (RS-232)	Controller 8 pin Mini DIN male (RS-232)
<p style="text-align: center;"> RXD (2) ————— (8) TXD TXD (3) ————— (4) RXD GND (5) ————— (2) GND </p>		<p style="text-align: center;">  Top View Jetter JC-246  Controller side (Comm. Port) </p>

Keyence KV/KZ Series

DELTA

A. HMI factory settings

Baud rate: 9600, 8, EVEN, 1 (RS-232).

Controller station number: 0. (no PLC station number in protocol, therefore, only 1(HMI) to 1 (PLC) communication is allowed.)

Control area/state area: DM-0 / DM-10.



- 1) Please notice that no PLC station number in protocol, therefore, only 1(HMI) to 1 (PLC) communication is allowed.
- 2) Only 1 Bit or 1 Word can be transferred for each communication. (Communication speed is slow.)

B. Definition of controller Read/Write address

Registers

Register Type	Format	Read/Write Range		Data Length
		Word No.	Bit No.	
Timer	T-nnn	nnn: 0 ~ 199	N/A	Word
Counter	C-nnn	nnn: 0 ~ 199	N/A	Word
High-speed counter	CTH-n	n: 0 ~ 1	N/A	Word
High-speed counter comparator	CTC-n	n: 0 ~ 3	N/A	Word
Data memory	DM-nnnn	nnnn: 0 ~ 1999	N/A	Word
Temporary data memory	TM-nn	nn: 0 ~ 31	N/A	Word
Timer preset value	PT-nnn	nnn: 0 ~ 199	N/A	Word
Counter preset value	PC-nnn	nnn: 0 ~ 199	N/A	Word
CTC preset value	PCTC-n	n: 0 ~ 3	N/A	Word

Contacts

Contact type	Format	Read/Write Range	
		Word No.	Bit No.
Relay	R-nnnbb	nnn: 0 ~ 69	bb: 00 ~ 15
Timer	T-nnn	N/A	nnn: 0 ~ 199
Counter	C-nnn	N/A	nnn: 0 ~ 199
High-speed counter comparator	CTC-n	N/A	n: 0 ~ 3

NOTE


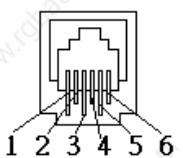
When using the protocol format of KV series and connecting to KZ-80T PLC, some errors occur. Please refer to the following description:

- 1) Readable Timer address is not continuous. For example, T-0 ~ T-9 can be read, T10 cannot be read, T11 ~ T20 can be read, T21 ~ T50 cannot be read, ...etc.
- 2) Counter cannot be read. For example,
 Registers: C- (Counter), CTH- (High-speed counter), CTC- (High-speed counter comparator), PC- (Counter preset value), PCTC- (CTC preset value) they all cannot be read.
 Contacts: C- (Counter), CTC- (High-speed counter comparator) they all cannot be read also.


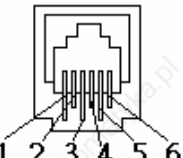
C. Connections (Connector Pinouts)

RS-232

KV Series

DOP 9 pin D-SUB male (RS-232)	Controller RJ-11 cable connector (RS-232)	Controller RJ-11 cable connector (RS-232)
RXD (2) ————— (3) SD TXD (3) ————— (5) RD GND (5) ————— (4) SG		 6 - 1 Top View  1 2 3 4 5 6 PLC side (Comm. Port)

KZ Series

DOP 9 pin D-SUB male (RS-232)	Controller RJ-11 cable connector (RS-232)	Controller RJ-11 cable connector (RS-232)
RXD (2) ————— (5) SD TXD (3) ————— (3) RD GND (5) ————— (4) SG		 6 - 1 Top View  1 2 3 4 5 6 PLC side (Comm. Port)



-
- 1) Communication Cable: The pins of SD and RD of KZ-80T and KV Series are reverse.

Koyo SU/DL Series

DELTA

A. HMI factory settings

Baud rate: 9600, 8, ODD, 1 (RS-232).

Controller station number: 1.

Control area/state area: V1400 / V1410.

B. Definition of controller Read/Write address

Registers


Register Type	Format	Read/Write Range		Data Length
		Word No.	Bit No.	
Timer Accumulated	Vn	n: 0 ~ 177 (octal)	N/A	Word
Counter Accumulated	Vn	n: 1000 ~ 1177 (octal)	N/A	Word
V Memory	Vn	n: 1400 ~ 7777 (octal)	N/A	Word
Linker Relays	Vn	n: 40000 ~ 40037 (octal)	N/A	Word
Input Status	Vn	n: 40400 ~ 40423 (octal)	N/A	Word
Output Status	Vn	n: 40500 ~ 40523 (octal)	N/A	Word
Control Relays	Vn	n: 40600 ~ 40635 (octal)	N/A	Word
Stage	Vn	n: 41000 ~ 41027 (octal)	N/A	Word
Timer Status	Vn	n: 41100 ~ 41107 (octal)	N/A	Word
Counter Status	Vn	n: 41140 ~ 41147 (octal)	N/A	Word
Spec. Relay 1	Vn	n: 41200 ~ 41205 (octal)	N/A	Word
Spec. Relay 2	Vn	n: 41216 ~ 41230 (octal)	N/A	Word

Contacts

Contact type	Format	Read/Write Range	
		Word No.	Bit No.
Linker Relays	GXn	N/A	n: 0 ~ 777 (octal)
Input Status	Xn	N/A	n: 0 ~ 477 (octal)
Output Status	Yn	N/A	n: 0 ~ 477 (octal)
Control Relays	Cn	N/A	n: 0 ~ 737 (octal)
Stage	Sn	N/A	n: 0 ~ 577 (octal)
Timer Status	Tn	N/A	n: 0 ~ 177 (octal)
Counter Status	CTn	N/A	n: 0 ~ 177 (octal)
Spec. Relay 1	SPn	N/A	n: 0 ~ 137 (octal)
Spec. Relay 2	SPn	N/A	n: 320 ~ 617 (octal)

C. Connections (Connector Pinouts)

RS-232

DOP 9 pin D-SUB male (RS-232)	Controller RJ-11 cable connector (RS-232)	Controller RJ-11 cable connector (RS-232)
RXD(2) ————— (4)TXD TXD(3) ————— (3)RXD GND(5) ————┐ └—————┬── (1)GND └—————┬── (6)GND		 <p>1 - 6 Top View</p>

Koyo K-Sequence

DELTA

A. HMI factory settings

Baud rate: 9600, 8, ODD, 1 (RS-232).

Controller station number: 1.

Control area/state area: R1400 / R1420.



- 1) If read / write the address that exceeds the valid range, HMI will stop read/write operation and show “...Error 6..... Command Can Not be Executed....” on the screen.

B. Definition of controller Read/Write address

Registers

Register Type	Format	Read/Write Range		Data Length
		Word No.	Bit No.	
Input Status	Xnnnn	nnnn: 0 ~ 1760 (octal)	N/A	Word
Output Status	Ynnnn	nnnn: 0 ~ 1760 (octal)	N/A	Word
Link Relays	GXnnnn	nnnn: 0 ~ 3760 (octal)	N/A	Word
Relays	GQnnnn	nnnn: 0 ~ 3760 (octal)	N/A	Word
Relays	Mnnnn	nnnn: 0 ~ 3760 (octal)	N/A	Word
Stage	Snnnn	nnnn: 0 ~ 1760 (octal)	N/A	Word
Timer Status	Tnnn	nnn: 0 ~ 360 (octal)	N/A	Word
Control Relays	Cnnn	nnn: 0 ~ 360 (octal)	N/A	Word
Special Relay 1	SPnnn	nnn: 0 ~ 760 (octal)	N/A	Word
Register	Rnnnnn	nnnnn: 0 ~ 41237 (octal)	N/A	Word
Register	Pnnnnn	nnnnn: 0 ~ 37777 (octal)	N/A	Word

- nnnn: It is in octal format and it must be the multiple of 16 except for R and P.

Contacts


Contact type	Format	Read/Write Range	
		Word No.	Bit No.
Input Status	Xnnnn	N/A	nnnn: 0 ~ 1777 (octal)
Output Status	Ynnnn	N/A	nnnn: 0 ~ 1777 (octal)
Linker Relays	GXnnnn	N/A	nnnn: 0 ~ 3777 (octal)
Relays	GQnnnn	N/A	nnnn: 0 ~ 3777 (octal)
Control Relays	Mnnnn	N/A	nnnn: 0 ~ 3777 (octal)
Stage	Snnnn	N/A	nnnn: 0 ~ 1777 (octal)
Timer Status	Tnnn	N/A	nnn: 0 ~ 377 (octal)

Contact type	Format	Read/Write Range	
		Word No.	Bit No.
Counter Status	Cnnn	N/A	nnn: 0 ~ 377 (octal)
Spec. Relay 1	SPnnn	N/A	nnn: 0 ~ 777 (octal)

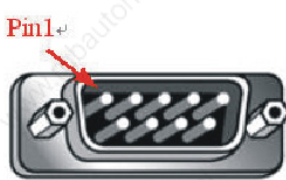
C. Connections (Connector Pinouts)

RS-232

Port 0 Communication Cable

DOP 9 pin D-SUB male (RS-232)	Controller RJ-11 cable connector (RS-232)	Controller RJ-11 cable connector (RS-232)
RXD (2) ————— (4)TXD TXD (3) ————— (3)RXD GND (5) ————— (1)GND (6)GND (Note 1)	 1 - 6 Top View	

- If pin 6 is not grounded, a communication error may occur when connecting to a CKD SM 24R controller. Ensure that pin 6 is well grounded. There is no problem when connecting to SN32DRA controller no matter pin6 is grounded or not.

DOP Series 9 pin D-SUB male (RS-232)	Controller 9 pin D-SUB male (RS-232)	Controller 9 pin D-SUB male (RS-232)
RXD (2) ————— (3) TXD TXD (3) ————— (2) RXD GND (5) ————— (5) SG	 Top View	

RS-485

Port 1 Communication Cable

DOP 9 pin D-SUB male (RS-485)	DOP 9 pin D-SUB male (RS-485)
D- (1) ————— D- D- (4) ————— D+ (2) ————— D+ D+ (3) —————	

The corresponding registers of CCM2 and K-Sequence

Address Corresponding Relationship:

CCM2	K sequence	SN32DRA
V	R	R
X	X	I
Y	Y	Q
C	M	M
S	S	S
T	T	T
CT	C	C
SP	SP	SP

Lenze LECOM-A/B Protocol

DELTA

A. HMI factory settings

Baud rate: 9600, 7, EVEN, 1 (Baudrate: 1200/2400/4800/9600/19200).

Controller station number: 1 (1~99).

Control area/state area: None / None.

 **NOTE**

- 1) Please pay close attention to each pin definition of cable connectors.
- 2) Ensure not to use the general RS-232 5-pin cable. This is because if pin 2, 3, 5, 7, 8 are all connected to the drive, the drive can not recognize the communication signal and can not identify what kind of communication it is.
- 3) For more detailed information of pin definition of cable connectors, please refer to the C. Connections (Connector Pinouts) in page B-26 and B-27.
- 4) Ensure the HMI communication data format (The communication data written into the drive) is correct. The Word “m” in the following table is used to specify the HMI communication data format.
- 5) Ensure the HMI display data format (Property table/Setting value...etc.) is correct.
- 6) When using broadcast function, please check if the using device is available. This is because the broadcast function can be activated only when the user choose “write only” device for broadcast station number (only choose setting value/setting constant (button) and then the broadcast function can be used). If choosing other devices, the system will ask you to read back the drive setting value, so please ensure to choose the correct device. If choosing the incorrect devices, a “Controller Station Number Error...” fault message will display on HMI screen.
- 7) Support 82XX frequency AC drives and 93XX servo drives.

B. Definition of controller Read/Write address

Registers (n, m, y are in decimal)

Register Type	Format	Read/Write Range			Data Length
		Word No.	Bit No.		
			LowByte	HighByte subcode	
Parameter without subcode	CWn	n: 1 ~ 10000	N/A	N/A	Word
	CWn.m	n: 1 ~ 10000	m: 0 ~ 23	N/A	Word
Parameter with subcode	CWn/y	n: 1 ~ 10000	N/A	y:1 ~ 255	Word
	CWn/y.m	n: 1 ~ 10000	m: 0 ~ 23	y:1 ~ 255	Word

Register Type	Format	Read/Write Range			Data Length
		<u>Word No.</u>	<u>Bit No.</u>		
			LowByte	HighByte subcode	
Parameter without subcode	CDn	n: 1 ~ 10000	N/A	N/A	DoubleWord
	CDn.m	n: 1 ~ 10000	m: 0 ~ 23	N/A	DoubleWord
Parameter with subcode	CDn/y	n: 1 ~ 10000	N/A	y:1 ~ 255	DoubleWord
	CDn/y.m	n: 1 ~ 10000	m: 0 ~ 23	y:1 ~ 255	DoubleWord

 **NOTE**

- 1) m : HMI communication data format
- 2) The value of m represents the different communication data format:
 - If m value is undefined: ASCII hexadecimal format (VH). (4 or 8 numbers.)
 - m >= 23 : ASCII hexadecimal format (VH). (4 or 8 numbers.)
 - m = 0 ~10 : unsigned, ASCII decimal format (VD).
 m represents decimal place, For example:
 m=0 → no decimal place
 m=1 → one decimal place (tenth)
 m=2 → two decimal place (hundredth)
 - m = 11 ~20 : signed, ASCII decimal format (VD).
 m represents decimal place, For example:
 m=11 → one decimal place (tenth)
 m=12 → two decimal place (hundredth)
 - m = 21 : signed, ASCII decimal format (VD).
 without decimal place
 - m = 22 : ASCII hexadecimal format (VH). 2 numbers.
 when using this format, the write value will be limited within the range of 0~0xFF (low byte).
 For example: when entering 0x1234 during communication, the actual write value is 0x34, not 0x1234.

Contacts (n, b, y are in decimal)

Register Type	Format	Read/Write Range		
		<u>Word No.</u>	<u>Bit No.</u>	
			LowByte	HighByte subcode
Parameter without subcode	CBn.b	n: 1 ~ 10000	b: 0 ~ 31	N/A
Parameter with subcode	CBn/y.b	n: 1 ~ 10000	b: 0 ~ 31	1 ~ 255

Only VH type parameter can provide Bit read/write function (it is convenient for the user to read/write Bit No. of parameters).

CBn.b, CWn (CWn.m), CDn (CDn.m): read/write address is the same (address n).



- 1) Since the data format of this controller is complicated (a. VS (String format), b. VO (Octet string format data blocks), c. VH (ASCII hexadecimal format)(1, 2, 4 bytes), d. VD (ASCII decimal format)(positive, negative, decimal,...)) and the communication format is not compatible, therefore, it is needed to ensure the HMI communication data format is correct, or the error may occur.
- 2) Registers: only can read/write the data of ASCII hexadecimal format (VH), ASCII decimal format (VD) (i.e. Either VH or VD data format can be set via communication.)

Contacts: only can read/write the data of ASCII hexadecimal format (VH)

HMI display data format (Property table/Setting value...etc.) should also be correct.

Explanation:

- Registers: only can read/write the data of VH, VD. HMI needs to set communication data format (please refer to 4), 5) and 6)). String format (VS), and Octet string format for data blocks (VO) can not be used. If the controller returns the data in VS or VO format, HMI will show “.....Value Is Incorrect” on the screen.
- Contacts: only can read/write the data of ASCII hexadecimal format (VH). Only VH type parameter can provide Bit read/write function. If the controller returns the data in other format, HMI will show “.....Value Is Incorrect” on the screen.
- Do not write the inexistent Bit address, or HMI will show “....Write Command Can Not be Executed” on the screen.

For example: CW470/1. The valid value of CW470/1 is within the range of 0 ~ 0xFF. Therefore, Bit 8 ~31 is not existed. Although HMI will show the value of Bit 8 ~31 is 0, the user can not write or set the value.

- The settings of ASCII hexadecimal format (VH) and ASCII decimal format (VD) should be correct. If the VD data is set in VH format in HMI (m value is undefined, or m=22 or 23) or the VH data is set in VD format in HMI (m=0 ~ 21), when HMI write the data, HMI will show “....Write Command Can Not be Executed” on the screen or tell the user the write value is incorrect.
- The decimal place of ASCII decimal format (VD) should be set correctly, or the write value will not be correct. The decimal place displayed on HMI should also be correct, or the display value will be incorrect.
- ASCII hexadecimal format (VH), 2 numbers (m = 22). The value is limited to 2 numbers. Using this format the write value will be limited within the range of 0 ~ 0xFF (low byte) automatically.

3) Station Number and Broadcast

- The valid station number is from 0 to 99. If exceeds this range, HMI will stop read/write operation and show “Controller Station Number Error ...”on the screen.

- 00 indicates the global broadcasting number (1~99).
- 10, 20, 30, 40, 50, 60, 70, 80, 90 are local broadcasting number.

The affected ranges are: 11~19, 21~29, 31~39, 41~49, 51~59, 61~69, 71~79, 81~89 and 91~99 respectively. Only choose setting value/setting constant (button), and then the broadcast function can be used. If choosing other devices, the system will be confused while reading back the drive setting value via broadcast function, so please ensure to choose the correct device. If choosing the incorrect devices, a "Controller Station Number Error..." fault message will display on HMI screen.

- Use in LECOM-A/B protocol. 82XX frequency AC drives and 93XX servo drives all use this protocol.

4) Explanation of communication error address

- Registers: display CW n, CWy n, CD n, CDy n in order
- Contacts: display CB n, CByn in order (n: address value)

5) HMI data format explanation

- Some controller parameters are in Word and some are in Double Word. Therefore, there are two kinds of data format: Word (CWn (CWn.m), CWn/y(CWn/y.m)) and Double Word (CDn (CDn.m), CDn/y(CDn/y.m)).
- Furthermore, regarding to Bit No., HMI only read/write 32Bit (Bit0 ~ Bit31) of parameters in VH format.
- CWn(CWn.m), CDn(CDn.m), or CBn.b: read/write address is the same (address n), but
When symbol is set to CW, read/write value is the low word of parameters (n) only,
When symbol is set to CD, read/write value is the Double Word of whole parameters (n),
When symbol is set to CB, read/write value is the Bit (b) No. of parameters (n).
(m : HMI communication data format)
- (CWn/y(CWn/y.m), CDn/y(CDn/y.m), CBn/y.b: read/write address, which y subcode is the same(address n), but
When symbol is set to CW, read/write value is the low word of parameters (n) only,
When symbol is set to CD, read/write value is the Double Word of whole parameters (n),
When symbol is set to CB, read/write value is the Bit (b) No. of parameters (n).
(m : HMI communication data format)
- Actually when using HMI,
 - i) When using devices that the unit is in Word (e.g. numeric devices (numeric value display, numeric value input...)...), the read/write value will be the same no matter the read/write address format is set to CWn or CDn as read/write value is the low word of parameters (n) only.
 - ii) When using devices that the unit is in Double Word (e.g. numeric devices (numeric value display, numeric value input...)...), if the read/write address format is set to CWn, read/write value is coming from the low word of CWn and CWn+1 these two addresses. (The low word of CWn is regarded as "low word" and the low word of CWn+1 is regarded as "high word", and then combining "low word" and "high word" to a Double Word.)

If the read/write address format is set to CDn, read/write value is the whole Double Word of CDn (1 address).

- iii) When using character device (e.g. character display, character input...), if the read/write address format is set to CWn, the read/write value is coming from the low word of CWn, CWn+1, CWn+2, ...every address.

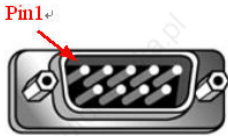
If the read/write address format is set to CDn, read/write value is the whole Double Word of CDn, CDn+1, CDn+2,...every address.

- iv) When using "Multiple Duplicate" function, if the Word and Bit addresses exceed the valid range, the Word and Bit addresses will be set to 0 automatically. Sometime error will occur to remind the user when compiling.
- v) CBn.b, CBn/y.b are added for the user to read and write Bit No. of parameters in VH format more easily.
- vi) Only can read or write 1 parameter for each communication.

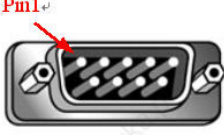
C. Connections (Connector Pinouts)

Pin 2, 3, 5 are for RS-232 communication. Pin 7, 8 are for RS-485 communication.

RS-232

DOP 9 pin D-SUB male (RS-232)	Controller 9 pin D-SUB male (RS-232)	Controller 9 pin D-SUB male (RS-232)
RXD (2) ————— (3) TXD TXD (3) ————— (2) RXD GND (5) ————— (5) GND		 Top View

RS-485

DOP 9 pin D-SUB male (RS-485)	Controller 9 pin D-SUB male (RS-485)	Controller 9 pin D-SUB male (RS-485)
D- (1) ————— (7) T/R (A) D- (4) ————— D+ (2) ————— (8) T/R (B) D+ (3) —————		 Top View

LG Master K120S/200S

DELTA

A. HMI factory settings

Baud rate: 38400, 8, None, 1. (RS-232)

Controller station number: 0. (no PLC station number in protocol, therefore, only 1(HMI) to 1 (PLC) communication is allowed.)

Control area/state area: DW0 / DW10.

B. Definition of controller Read/Write address

Registers


Register Type	Format	Word No.	Bit No.	Data Size
WORD_DEVICE_PW	PWn	n: 0 ~ 15	N/A	Word
WORD_DEVICE_MW	MWn	n: 0 ~ 191	N/A	Word
WORD_DEVICE_KW	KWn	n: 0 ~ 31	N/A	Word
WORD_DEVICE_LW	LWn	n: 0 ~ 63	N/A	Word
WORD_DEVICE_FW	FWn	n: 0 ~ 63	N/A	Word
WORD_DEVICE_TW	TWn	n: 0 ~ 255	N/A	Word
WORD_DEVICE_CW	CWn	n: 0 ~ 255	N/A	Word
WORD_DEVICE_DW	DWn	n: 0 ~ 9999	N/A	Word

Contacts

Contact type	Format	Word No.	Bit No.
BIT_DEVICE_P	Pnb	n: 0 ~ 15	b: 0 ~ f
BIT_DEVICE_M	Mnb	n: 0 ~ 191	b: 0 ~ f
BIT_DEVICE_K	Kn	n: 0 ~ 31	b: 0 ~ f
BIT_DEVICE_L	Ln	n: 0 ~ 63	b: 0 ~ f
BIT_DEVICE_F	Fnb	n: 0 ~ 63	b: 0 ~ f
BIT_DEVICE_T	Tn	N/A	n: 0 ~ 255
BIT_DEVICE_C	Cn	N/A	n: 0 ~ 255

C. Connections (Connector Pinouts)

RS-232

DOP 9 pin D-SUB male (RS-232)	Controller 9 pin D-SUB male (RS-232 for LG K120S/200S)	Controller 9 pin D-SUB male (RS-232 for LG K120S/200S)
RXD (2) ————— (3) TXD TXD (3) ————— (2) RXD GND (5) ————— (5) GND		 <p>Pin 1</p> <p>Top View</p>

 **NOTE**

- 1) If connecting to Pin 4 (RXD), Pin 7 (TXD) and Pin5 (SG), it indicates that CNet protocol is used (Please refer to the section “LG Master-K CNET” on page B-50. 120S/200S protocol and CNet protocol cannot be used simultaneously. The users only can select either 120S/200S protocol or CNet protocol.

LG Glofa GM6 CNET

DELTA

A. HMI factory settings

Baud rate: 19200, 8, None, 1. (RS-232)

Controller station number: 0.

Control area/state area: %MW0 / %MW10.



- 1) HMI default setting is predefined for CPU Port. If the user want to connect to CNET communication module, the baud rate should be changed to 38400, 8, None, 1. (RS-422 / RS-485).

B. Definition of controller Read/Write address

Registers

Register Type	Format	Word No.	Bit No.	Data Size
Input Image	IWb.s.w	w(word):0 ~ 3 s(slot): 0 ~ 7	b(base): 0 ~ 1	Word
Input Image	IDb.s.w	w(word):0 ~ 1 s(slot): 0 ~ 7	b(base): 0 ~ 1	DWord
Output Image	QWb.s.w	w(word):0 ~ 3 s(slot): 0 ~ 7	b(base): 0 ~ 1	Word
Output Image	QDb.s.w	w(word):0 ~ 1 s(slot): 0 ~ 7	b(base): 0 ~ 1	DWord
Internal Memory	MWn	n: 0 ~ 4095	N/A	Word
Internal Memory	MDn	n: 0 ~ 2047	N/A	DWord


Contacts

Contact type	Format	Word No.	Bit No.
Input Image	IXb.s.n	s(slot): 0 ~ 7	n(bit): 0 ~ 63 b(base): 0 ~ 1
Output Image	QXb.s.n	s(slot): 0 ~ 7	n(bit): 0 ~ 63 b(base): 0 ~ 1
Internal Memory	MXn	N/A	n: 0 ~ 65535

C. Connections (Connector Pinouts)

RS-232

via CPU Port

DOP 9 pin D-SUB male (RS-232)	Controller 9 pin D-SUB male (RS-232)	Controller 9 pin D-SUB male (RS-232)
RXD (2) ————— (7) TXD	TXD (3) ————— (4) RXD	 <p>Top View</p>
GND (5) ————— (5) GND		

RS-422

via G6L-CUEC CNET communication module

DOP 9 pin D-SUB male (RS-422)	Controller Cable Connector (RS-422)
RXD+ (2) ————— SDA	
RXD- (1) ————— SDB	
TXD- (4) ————— RDA	
TXD+ (3) ————— RDB	
GND (5) ————— SG	

LG Master-K CNET

DELTA

A. HMI factory settings

Baud rate: 38400, 8, None, 1. (RS-422)

Controller station number: 0.

Control area/state area: DW0 / DW10.



1) HMI default setting is predefined for G6L-CUEC CNET communication module.

B. Definition of controller Read/Write address

Registers

Register Type	Format	Word No.	Bit No.	Data Size
I/O relay	PWn	n: 0 ~ 31	N/A	Word
Auxiliary relay	MWn	n: 0 ~ 191	N/A	Word
Keep relay	KWn	n: 0 ~ 31	N/A	Word
Link relay	LWn	n: 0 ~ 63	N/A	Word
Special relay	FWn	n: 0 ~ 63	N/A	Word (Read Only)
Timer elapsed value	TWn	n: 0 ~ 255	N/A	Word
Counter elapsed value	CWn	n: 0 ~ 255	N/A	Word
Data register	DWn	n: 0 ~ 9999	N/A	Word

Contacts

Contact type	Format	Word No.	Bit No.
I/O relay	PXnb	n: 0 ~ 31	b: 0 ~ F
Auxiliary relay	MXnb	n: 0 ~ 191	b: 0 ~ F
Keep relay	KXnb	n: 0 ~ 31	b: 0 ~ F
Link relay	LXnb	n: 0 ~ 63	b: 0 ~ F
Special relay	FXnb	n: 0 ~ 63	b: 0 ~ F
Timer contact relay	TXb	N/A	b: 0 ~ 255
Counter contact relay	CXb	N/A	b: 0 ~ 255

C. Connections (Connector Pinouts)

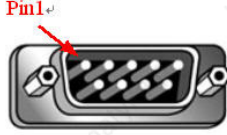
RS-422

via G6L-CUEC CNET communication module

DOP 9 pin D-SUB male (RS-422)	Controller Cable Connector (RS-422)
RXD+ (2)	SDA
RXD- (1)	SDB
TXD- (4)	RDA
TXD+ (3)	RDB
GND (5)	SG

RS-232

via LG-120S PLC (Master K)

DOP 9 pin D-SUB male (RS-232)	Controller 9 pin D-SUB male (RS-232)	Controller 9 pin D-SUB male (RS-232)
RXD (2)	(7) TXD	 <p>Pin 1</p> <p>Top View</p>
TXD (3)	(4) RXD	
GND (5)	(5) GND	

LIYAN LYPLC EX

DELTA

A. HMI factory settings

Baud rate: 9600, 7, EVEN, 1.

Controller station number: 0.

Control area/state area: D0 / D10.

B. Definition of controller Read/Write address

Registers

Register Type	Format	Read/Write Range		Data length
		Word No.	Bit No.	
Auxiliary Relay	Mn	n: 0 ~ 3064	N/A	Byte
Special Auxiliary Relay	Mn	n: 8000 ~ 8248	N/A	Byte
Status Relay	Sn	n: 0 ~ 992	N/A	Byte
Input Relay	Xn	n: 0 ~ 360(octal)	N/A	Byte
Output Relay	Yn	n: 0 ~ 360(octal)	N/A	Byte
Timer PV	Tn	n: 0 ~ 255	N/A	Word
16-bit Counter PV	Cn	n: 0 ~ 199	N/A	Word
32-bit Counter PV	Cn	n: 200 ~ 255	N/A	Double Word
Data Register	Dn	n: 0 ~ 7999	N/A	Word
Special Data Register	Dn	n: 8000 ~ 8255	N/A	Word

Auxiliary Relay / Special Auxiliary Relay / Status Relay / Input Relay / Output Relay: Address must be the multiple of 8.

Contacts

Contact type	Format	Read/Write Range	
		Word No.	Bit No.
Auxiliary Relay	Mn	N/A	n: 0 ~ 3071
Special Auxiliary Relay	Mn	N/A	n: 8000 ~ 8255
Status Relay	Sn	N/A	n: 0 ~ 999
Input Relay	Xn	N/A	n: 0 ~ 377(octal)
Output Relay	Yn	N/A	n: 0 ~ 377(octal)
Timer Flag	Tn	N/A	n: 0 ~ 255
Counter Flag	Cn	N/A	n: 0 ~ 255

M2i Master

DELTA

A. HMI factory settings

Baud rate: 38400, 8, None, 1.

Controller station number: 1.

Control area/state area: SB0 / SB10.

B. Definition of controller Read/Write address

Registers

Register Type	Format	Read/Write Range		Data length
		<u>Word No.</u>	<u>Bit No.</u>	
Word Address	SBn	n: 0000 ~ FFFF	N/A	Word

Contacts

Contact type	Format	Read/Write Range	
		<u>Word No.</u>	<u>Bit No.</u>
Bit Address	SBn.b	n: 0000 ~ FFFF	b: 0 ~ F

M2i Slave

DELTA

A. HMI factory settings

Baud rate: 38400, 8, None, 1.

Controller station number: 1 (no function)

Control area/state area: SB0 / SB10.



- 1) HMI station number is Slave station number. (default setting is 0)
- 2) The relation between M2i communication address and HMI internal registers.

Modbus address		Data definition in HMI
SB0000 ~ SB7FFF	→	\$0 ~ \$32767
SB8000 ~ SB83FF	→	\$M0 ~ \$M1023
SB8400	→	RCPNO
SB8500 ~ SBFFFF	→	RCP0 ~ RCP31487

B. Definition of controller Read/Write address

Registers

Register Type	Format	Word No.	Bit No.	Data Size
Word Address	SBn	n: 0000 ~ FFFF	N/A	Word

Contacts

Contact type	Format	Read/Write Range	
		Word No.	Bit No.
Bit Address	SBn.b	n:0000 ~ FFFF	b: 0 ~ F

C. Connections (Connector Pinouts):

Please refer to B-1 Pin Definition of Serial Communication for detail.

Matsushita FP PLC

DELTA

A. HMI factory settings

Baud rate: 9600, 8, ODD, 1.

Controller station number: 238.

Control area/state area: DT0 / DT10.

B. Definition of controller Read/Write address

Registers

Register Type	Format	Read/Write Range		Data length
		Word No.	Bit No.	
Internal Relay Special Internal Relay	WRn	n: 0 ~ 886, 900 ~ 910	N/A	Word
Link Relay	WLn	n: 0 ~ 639	N/A	Word
External Input Relay	WXn	n: 0 ~ 511	N/A	Word
External Output Relay	WYn	n: 0 ~ 511	N/A	Word
Timer/Counter P.V.	EVn	n: 0 ~ 3071	N/A	Word
Timer/Counter S.V.	SVn	n: 0 ~ 3071	N/A	Word
Data Register	DTn	n: 0 ~ 32764	N/A	Word
Link Data Register	LDn	n: 0 ~ 8447	N/A	Word
File Register	FLn	n: 0 ~ 32764	N/A	Word
Special Data Register	DT9_n	n: 0 ~ 511	N/A	Word

- DT9_0 ~ DT9_511 are applicable for FP0 T32C, FP2, FP2SH, FP10SH controllers. (Special data registers are all within the range of DT90000 ~ DT9XXXX).
- The actual transmitted address of DT9_n is 90000 + n (for DT). For example, the actual transmitted address of DT9_1 is 90001 (for DT), the actual transmitted address of DT9_2 is 90002 (for DT) and vice versa.

Contacts

Contact type	Format	Read/Write Range	
		Word No.	Bit No.
Internal Relay Special Internal Relay	Rnb	n: 0 ~ 886 n: 900 ~ 910	b: 0 ~ f b: 0 ~ f
Link Relay	Lnb	n: 0 ~ 639	b: 0 ~ f
External Input Relay	Xnb	n: 0 ~ 511	b: 0 ~ f
External Output Relay	Ynb	n: 0 ~ 511	b: 0 ~ f
Timer Flag Contact	Tn	N/A	n: 0 ~ 3071
Counter Flag Contact	Cn	N/A	n: 0 ~ 3071

Mirle FAMA SC

DELTA

A. HMI factory settings

Baud rate: 9600, 7, EVEN, 1.

Controller station number: 0.

Control area/state area: 40100 / 40200.

B. Definition of controller Read/Write address

Registers

Register Type	Format	Read/Write Range		Data Length
		Word No.	Bit No.	
Output Registers	Wn	n: 40001 ~ 50000	N/A	Word
Input Registers	Wn	n: 30001 ~ 40000	N/A	Word

➤ Input Registers is “read only”.

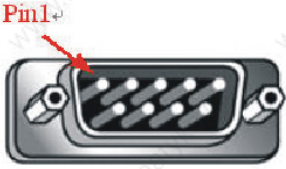
Contacts

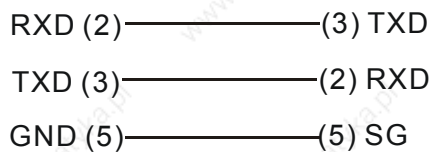
Contact type	Format	Read/Write Range	
		Word No.	Bit No.
Discrete Outputs	Bn	N/A	n: 1 ~ 10000
Discrete Inputs	Bn	N/A	n: 10001 ~ 20000

➤ Discrete Inputs is “read only”.

C. Connections (Connector Pinouts)

RS-232

DOP Series 9 pin D-SUB male (RS-232)	Controller 9 pin D-SUB male (RS-232)	Controller 9 pin D-SUB male (RS-232)
		 <p>Top View</p>



Mitsubishi FX/FX2N PLC

DELTA

A. HMI factory settings

Baud rate: 9600, 7, EVEN, 1.

Controller Station number: 0. (no PLC station number in protocol, therefore, only 1(HMI) to 1 (PLC) communication is allowed.)

Control area/state area: D0 / D10.



- 1) If connecting to Mitsubishi FXxN series PLC, the user can use FX2N and FX series both communication protocol.
- 2) If connecting to Mitsubishi FX series PLC, the user can only use FX series communication protocol.
- 3) Some registers of Mitsubishi PLCs are “read only”, however, when you write these “read only” registers, PLCs will not report any communication error to HMI and this will cause that HMI may misjudge. Please aware of this when editing PLC program (this kind of case easily occurs when the user use FX series protocol when connecting to a FXxN series PLC).
- 4) If connecting to Mitsubishi FXxN series PLC, it is recommended for the user to use FX2N protocol.

B. Definition of controller Read/Write address

Registers

Register Type	Format	Read/Write Range		Data length
		Word No.	Bit No.	
Auxiliary Relay	Mn	n: 0 ~ 3064	N/A	Byte
Special Auxiliary Relay	Mn	n: 8000 ~ 8248	N/A	Byte
Status Relay	Sn	n: 0 ~ 992	N/A	Byte
Input Relay	Xn	n: 0 ~ 360(octal)	N/A	Byte
Output Relay	Yn	n: 0 ~ 360(octal)	N/A	Byte
Timer PV	Tn	n: 0 ~ 255	N/A	Word
16-bit Counter PV	Cn	n: 0 ~ 199	N/A	Word
32-bit Counter PV	Cn	n: 200 ~ 255	N/A	Double Word
Data Register	Dn	n: 0 ~ 7999	N/A	Word
Special Data Register	Dn	n: 8000 ~ 8255	N/A	Word

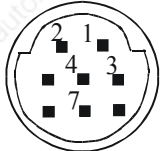
- Auxiliary Relay/ Special Auxiliary Relay/ Status Relay/ Input Relay /Output Relay: Address must be the multiple of 8.

Contacts

Contact type	Format	Read/Write Range	
		Word No.	Bit No.
Auxiliary Relay	Mn	N/A	n: 0 ~ 3071
Special Auxiliary Relay	Mn	N/A	n: 8000 ~ 8255
Status Relay	Sn	N/A	n: 0 ~ 999
Input Relay	Xn	N/A	n: 0 ~ 377(octal)
Output Relay	Yn	N/A	n: 0 ~ 377(octal)
Timer Flag	Tn	N/A	n: 0 ~ 255
Counter Flag	Cn	N/A	n: 0 ~ 255

C. Connections (Connector Pinouts)

RS-422

DOP Series 9 pin D-SUB male (RS-422)	Controller 8pin Mini DIN male (RS-422)	Controller 8pin Mini DIN male (RS-422)
RXD+ (2) ————— (7) TXD+ RXD- (1) ————— (4) TXD- TXD+ (3) ————— (2) RXD+ TXD- (4) ————— (1) RXD- GND (5) ————— (3) SG	 <p>Top View</p>	

RS-422

DOP 9 pin D-SUB male (RS-422)	Controller 25 pin D-SUB male (RS-422)
Pin 2 (RXD+) ————— Pin3 (TXD+) Pin 1 (RXD-) ————— Pin16 (TXD-) Pin 4 (TXD-) ————— Pin 15 (RXD-) Pin 3 (TXD+) ————— Pin 2 (RXD+)	

Mitsubishi A Series AJ71UC24 Communication Module

DELTA**A. HMI factory settings**

Baud rate: 9600, 8, ODD, 1.

Controller Station number: 0.

Control area/state area: D0 / D10.

**NOTE**

- 1) This driver use CheckSum.
- 2) Please set "PLC Mode" switch to position 5.
- 3) If some OUTPUT Replay (Y) and Special Data Relay (SM) are set to 1, PLC will stop communication and the communication will not recover automatically. At this time, it is needed to reset PLC.

B. Definition of controller Read/Write address**Registers**

Register Type	Format	Read/Write Range		Data length
		Word No.	Bit No.	
Input	Xn	n: 0 ~ 7FF	N/A	Word (multiple of 16)
Output	Yn	n: 0 ~ 7FF	N/A	Word (multiple of 16)
Link Relay	Bn	n: 0 ~ FFF	N/A	Word (multiple of 16)
Internal Relay	Mn	n: 0 ~ 8191	N/A	Word (multiple of 16)
Special Internal Relay	SMn	n: 9000 ~ 9255	N/A	Word (9000 + multiple of 16)
Latch Relay	Ln	n: 0 ~ 2047	N/A	Word (multiple of 16)
Annunciator	Fn	n: 0 ~ 2047	N/A	Word (multiple of 16)
Timer Value	TNn	n: 0 ~ 999	N/A	Word
Counter Value	CNn	n: 0 ~ 999	N/A	Word
Data Register	Dn	n: 0 ~ 8191	N/A	Word
Special Data Register	SDn	n: 9000 ~ 9255	N/A	Word
File Register	Rn	n: 0 ~ 8191	N/A	Word
Link Register	Wn	n: 0 ~ FFF	N/A	Word

Contacts

Contact type	Format	Read/Write Range	
		Word No.	Bit No.
Input	Xn	N/A	n: 0 ~ 7FF
Output	Yn	N/A	n: 0 ~ 7FF
Link Relay	Bn	N/A	n: 0 ~ FFF
Internal Relay	Mn	N/A	n: 0 ~ 8191
Special Internal Relay	SMn	N/A	n: 9000 ~ 9255
Latch Relay	Ln	N/A	n: 0 ~ 2047
Annunciator	Fn	N/A	n: 0 ~ 2047
Timer Contact	TSn	N/A	n: 0 ~ 999
Timer Coil	TCn	N/A	n: 0 ~ 999
Counter Contact	CSn	N/A	n: 0 ~ 999
Counter Coil	CCn	N/A	n: 0 ~ 999

C. Connections (Connector Pinouts)

RS-422

DOP 9 pin D-SUB male (RS-422)	Controller Cable Connector (RS-422)
RXD+ (2)	SDA
RXD- (1)	SDB
TXD+ (3)	RDA
TXD- (4)	RDB

Mitsubishi A2A/A2AS/A2USH A1SH/A3N/A2ASH (CPU-S1) CPU Port

DELTA**A. HMI factory settings**

Baud rate: 9600, 8, ODD, 1.

Controller Station number: 0. (no PLC station number in protocol, therefore, only 1(HMI) to 1 (PLC) communication is allowed.)

Control area/state area: D0 / D10.

 **NOTE**

1) This driver support all Mitsubishi A series CPU port. Mitsubishi A series CPU port can be divided into the following five categories according the used CPU code (used during communication):

- A0J2...
- A1N...
- A1S (/ A2S / A2N ...)
- A3N (/ A1SH / A2SH ...)
- A2A (/ A2AS / A2USH ...)

Delta HMI can support A2USH CPU port (same as A2A, A2AS CPU port.) and A1SH CPU port (same as A3N, A2ASH CPU port.).

2) L and M: The communication address of L is the same as communication address of M.

3) PX and X:

In Mitsubishi A2A PLC, the communication address of PX and X are the same.

In other Mitsubishi A series PLCs, X is from odd address and PX is from even address. That is one place where PX and X differ.

4) X, Y, B, M, SM, L, F, PX ----(Word),

X, Y, B, M, SM, L, F, PX ----(Bit),

When PLC station number is set to 255, only the value of even addresses will be read/written.

When PLC station number is set to other number (not 255), all value of all addresses will be read/written.

5) R address: R address will be different according to the size of File Register responded from PLC.

For example, A2USH:

1K:	3800 ~ 4000H
2K:	3000 ~ 4000H
3K:	2800 ~ 4000H
4K:	2000 ~ 4000H
5K:	4000 ~ 6800H(cy)
6K:	4000 ~ 7000H(cy)

File Register: PLC must be started correctly or the read / write value will be incorrect.

6) Max. read/write registers & relays for communication once

128 Words (256 bytes) Registers

64 Words (128 bytes) Relays

B. Definition of controller Read/Write address

Registers

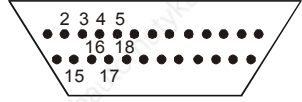
Register Type	Format	Read/Write Range		Data length
		Word No.	Bit No.	
Input	Xn	n: 0 ~ 7FF	N/A	Word (multiple of 16)
Output	Yn	n: 0 ~ 7FF	N/A	Word (multiple of 16)
Link Relay	Bn	n: 0 ~ FFF	N/A	Word (multiple of 16)
Internal Relay	Mn	n: 0 ~ 8191	N/A	Word (multiple of 16)
Special Internal Relay	SMn	n: 9000 ~ 9255	N/A	Word (9000 + multiple of 16)
Latch Relay	Ln	n: 0 ~ 8191	N/A	Word (multiple of 16)
Annunciator	Fn	n: 0 ~ 2047	N/A	Word (multiple of 16)
Timer Value	TNn	n: 0 ~ 2047	N/A	Word
Counter Value	CNn	n: 0 ~ 1023	N/A	Word
Data Register	Dn	n: 0 ~ 8191	N/A	Word
Special Data Register	SDn	n: 9000 ~ 9255	N/A	Word
File Register	Rn	n: 0 ~ 8191	N/A	Word
Link Register	Wn	n: 0 ~ FFF	N/A	Word
Input Card Register	PXn	n: 0 ~ 7FF	N/A	Word (multiple of 16)

Contacts

Contact type	Format	Read/Write Range	
		Word No.	Bit No.
Input	Xn	N/A	n: 0 ~ 7FF
Output	Yn	N/A	n: 0 ~ 7FF
Link Relay	Bn	N/A	n: 0 ~ FFF
Internal Relay	Mn	N/A	n: 0 ~ 8191
Special Internal Relay	SMn	N/A	n: 9000 ~ 9255
Latch Relay	Ln	N/A	n: 0 ~ 2047
Annunciator	Fn	N/A	n: 0 ~ 2047
Timer Contact	TSn	N/A	n: 0 ~ 2047
Timer Coil	TCn	N/A	n: 0 ~ 2047
Counter Contact	CSn	N/A	n: 0 ~ 1023
Counter Coil	CCn	N/A	n: 0 ~ 1023
Input Card Register	PXn	N/A	n: 0 ~ 7FF

C. Connections (Connector Pinouts)

RS-422

DOP Series 9 pin D-SUB male (RS-422)	Controller 25 pin D-SUB male(RS-422)	Controller 25 pin D-SUB male(RS-422)
Pin 2 (RXD+) —————	Pin 3 SDB (TXD+)	
Pin1 (RXD-) —————	Pin 16 SDA (TXD-)	
Pin 4 (TXD-) —————	Pin 15 RDA (RXD-)	
Pin 3 (TXD+) —————	Pin 2 RDB (RXD+)	
Pin 7 (RTS+) —————	Pin 4 CTS+	
Pin 8 (CTS+) —————	Pin 5 RTS+	
Pin 6 (RTS-) —————	Pin 17 CTS-	
Pin 9 (CTS-) —————	Pin 18 RTS-	

Explanation

How to set File Register (R) for Mitsubishi A serial PLC:

1. Startup MELSOFT series GX Developer.
2. Open "Project Data List" windows. ("View" Option)
3. Double click Parameter \ PLC Parameter, and open "Setting" window.
4. Set Memory Capacity \ File Register (0 ~8).
5. Press "End" button on the bottom and complete the setting.
6. Execute OnLine\Write to PLC.
7. Enable the "Parameter \ PLC/Network" and "File register \ Main" option (check the check box next to "Parameter \ PLC/Network" and "File register \ Main").
8. Press "Execute" button.
9. Complete

Mitsubishi Q Series CPU Port

DELTA**A. HMI factory settings**

Baud rate: 19200, 8, ODD, 1.

Controller Station number: 0. (no PLC station number in protocol, therefore, only 1(HMI) to 1 (PLC) communication is allowed.)

Control area/state area: D-0 / D-10.



- 1) Please notice that no PLC station number in protocol, therefore, only 1(HMI) to 1 (PLC) communication is allowed.
- 2) If communication baud rate is not correct, HMI will set PLC baud rate as HMI baud rate automatically. Therefore, do not worry if the baud rate is set incorrectly.
- 3) This driver support Mitsubishi Q00 and Q00J series with password protection models.

B. Definition of controller Read/Write address**Registers**

Register Type	Format	Read/Write Range		Data length
		Word No.	Bit No.	
Input	X-n	n: 0 ~ 1FFF	N/A	Word (multiple of 16)
Output	Y-n	n: 0 ~ 1FFF	N/A	Word (multiple of 16)
Direct Input	DX-n	n: 0 ~ 1FFF	N/A	Word (multiple of 16)
Direct Output	DY-n	n: 0 ~ 15	N/A	Word (multiple of 16)
Latch Relay	L-n	n: 0 ~ 8191	N/A	Word (multiple of 16)
Annunciator	F-n	n: 0 ~ 2047	N/A	Word (multiple of 16)
Edge Relay	V-n	n: 0 ~ 2047	N/A	Word (multiple of 16)
Step Relay	S-n	n: 0 ~ 8191	N/A	Word (multiple of 16)
Link Relay	B-n	n: 0 ~ 1FFF	N/A	Word (multiple of 16)
Special Link Relay	SB-n	n: 0 ~ 7FF	N/A	Word (multiple of 16)
Internal Relay	M-n	n: 0 ~ 8191	N/A	Word (multiple of 16)
Special Internal Relay	SM-n	n: 0 ~ 2047	N/A	Word (multiple of 16)
Timer Value	TN-n	n: 0 ~ 2047	N/A	Word
Retentive Timer Value	SN-n	n: 0 ~ 2047	N/A	Word
Counter Value	CN-n	n: 0 ~ 1023	N/A	Word
Data Register	D-n	n: 0 ~ 12287	N/A	Word
Special Data Register	SD-n	n: 0 ~ 2047	N/A	Word
Index Register	Z-n	n: 0 ~ 15	N/A	Word
File Register	R-n	n: 0 ~ 32767	N/A	Word

Register Type	Format	Read/Write Range		Data length
		Word No.	Bit No.	
File Register	ZR-n	n: 0 ~ 32767	N/A	Word
Link Register	W-n	n: 0 ~ 1FFF	N/A	Word
Special Link Register	SW-n	n: 0 ~ 7FF	N/A	Word

➤ Xn, Yn, DXn, Bn, SBn, Wn, SWn : n is in hexadecimal.

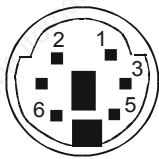

Contacts

Contact type	Format	Read/Write Range	
		Word No.	Bit No.
Input	X-n	N/A	n: 0 ~ 1FFF
Output	Y-n	N/A	n: 0 ~ 1FFF
Direct input	DX-n	N/A	n: 0 ~ 1FFF
Direct output	DY-n	N/A	n: 0 ~ 15
Latch Relay	L-n	N/A	n: 0 ~ 8191
Annunciator	F-n	N/A	n: 0 ~ 2047
Edge Relay	V-n	N/A	n: 0 ~ 2047
Step Relay	S-n	N/A	n: 0 ~ 8191
Link Relay	B-n	N/A	n: 0 ~ 1FFF
Special Link Relay	SB-n	N/A	n: 0 ~ 7FF
Internal Relay	M-n	N/A	n: 0 ~ 8191
Special Internal Relay	SM-n	N/A	n: 0 ~ 2047
Timer Contact	TS-n	N/A	n: 0 ~ 2047
Timer Coil	TC-n	N/A	n: 0 ~ 2047
Retentive timer Contact	SS-n	N/A	n: 0 ~ 2047
Retentive timer Coil	SC-n	N/A	n: 0 ~ 2047
Counter Contact	CS-n	N/A	n: 0 ~ 1023
Counter Coil	CC-n	N/A	n: 0 ~ 1023

➤ Xn, Yn, DXn, Bn, SBn : n is in hexadecimal.

C. Connections (Connector Pinouts)

RS-232

DOP 9 pin D-SUB male (RS-232)	Controller 6 pin Mini DIN male (RS-232)	Controller 6 pin Mini DIN male (RS-232)
RXD (2)	————— (2) SD (TXD)	 <p data-bbox="1204 600 1316 631">Top View</p>
TXD (3)	————— (1) RD (RXD)	
GND (5)	————— (3) GND	
		
	(5) DSR (DR)	
	(6) DTR (ER)	

MKS CT150

DELTA

A. HMI factory settings

Baud rate: 9600, 7, E, 1. (RS-232)

Controller Station number: 11.

Control area/state area: None / None.

B. Definition of controller Read/Write address

Registers

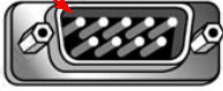
Register Type	Format	Read/Write Range	
		Word No.	Bit No.
Data In Register	Cn	n: 0 ~ 25	N/A
Setup Register	Cn	n: 40 ~ 43 45 ~ 50 90 ~ 97	N/A
Error Count	Err_CNT	0	N/A
LV Value	LV_VAL	0	N/A
Printmark Error	PRTMARK_ERR	0	N/A
Batch Counter	BAT_CNT	0	N/A
Waste Counter	WASTE_CNT	0	N/A
Line Speed	LINE_SPD	0	N/A
Actual Cutting Length	ACT_CUT_LEN	0	N/A

Contacts

Contact type	Format	Read/Write Range	
		Word No.	Bit No.
	Cn.b	n: 0 ~ 50	B: 0 ~ 15
Reset	RST	N/A	0
Jog Trim+	JOGTRIM_INC	N/A	0
Jog Trim-	JOGTRIM_DEC	N/A	0
Read PI	READ_PI	N/A	0
Activate Data	ACT_DATA	N/A	0
Store Eeprom	STR_EEPROM	N/A	0
Start/Stop	START_STOP	N/A	0
Reset Mark Counter	RSTMARK_CNT	N/A	0

C. Connections (Connector Pinouts)

RS-232

DOP 9 pin D-SUB male (RS-232)	Controller 9 pin D-SUB male (RS-232)	Controller 9 pin D-SUB male (RS-232)
RXD (2)	————— (3) TXD	 <p>Top View</p>
TXD (3)	————— (2) RXD	
GND (5)	————— (5) SG	

Modbus(Master) --- 984 RTU / ASCII mode

DELTA

A. HMI factory settings

Baud rate: 9600, 7, EVEN, 1. (ASCII)

9600, 8, EVEN, 1. (RTU)

Controller station number: 0.

Control area/state area: W40100 / W40200.

B. Definition of controller Read/Write address

Registers

Register Type	Format	Read/Write Range		Data length
		Word No.	Bit No.	
Output Registers	Wn	n: 40001 ~ 50000	N/A	Word
Input Registers	Wn	n: 30001 ~ 40000	N/A	Word

➤ Input Registers is “read only”.

Contacts

Contact type	Format	Read/Write Range	
		Word No.	Bit No.
Discrete Outputs	Bn	N/A	n: 1 ~ 10000
Discrete Inputs	Bn	N/A	n: 10001 ~ 20000

➤ Discrete Inputs is “read only”.

C. Connections (Connector Pinouts)

Please refer to B-1 Pin Definition of Serial Communication for detail.

Modbus Hexadecimal Address (Master) --- RTU / ASCII mode

DELTA

A. HMI factory settings

Baud rate: 9600, 7, EVEN, 1. (ASCII)

9600, 8, EVEN, 1. (RTU)

Controller station number: 0.

Control area/state area: RW-0 / RW-10.



1) The valid communication address starts from 0 and the format is hexadecimal system. So the settable range are 0 to 65535 (i.e. 0 ~ FFFF in hexadecimal format).

2) The difference than “Standard Modbus” communication: (Protocol is the same)

The usage of setting communication address is different.

The range of communication address is different

The “Standard Modbus” communication is in decimal format. The start addresses are 40001, 30001, 1, 10001 and contains 10000 addresses respectively (40001 ~ 50000, 30001 ~ 40000, 1 ~ 10000, 10001 ~ 20000).

The Modbus Hexadecimal Address (Master) is in hexadecimal format. The starting addresses are all from 0 and there is 65536 addressing space (from 0 to FFFF) in each PDU (protocol data unit).

B. Definition of controller Read/Write address

Registers

Register Type	Format	Read/Write Range		Data length
		Word No.	Bit No.	
Output Registers	RW-n	n: 0 ~ FFFF	N/A	Word
Input Registers	R-n	n: 0 ~ FFFF	N/A	Word

➤ RW- : can Read and Write.

Converting the address to decimal format and plus 40001, it will immediately become the corresponding “Standard Modbus” communication address.

➤ R- (Input Registers) : Read only.

Converting the address to decimal format and plus 30001, it will immediately become the corresponding “Standard Modbus” communication address.

Contacts

Contact type	Format	Read/Write Range	
		Word No.	Bit No.
Discrete Outputs	RWB-n	N/A	n: 0 ~ FFFF
Discrete Inputs	RB-n	N/A	n: 0 ~ FFFF

- RWB- : can Read and Write.

Converting the address to decimal format and plus 1, it will immediately become the corresponding "Standard Modbus" communication address.

- RB- (Discrete Inputs) : Read only.

Converting the address to decimal format and plus 10001, it will immediately become the corresponding "Standard Modbus" communication address.

 **NOTE**

- 1) Only first 10000 addresses can be converted to "Standard Modbus" communication address.

Modbus nW (Master) --- RTU / ASCII mode

DELTA

A. HMI factory settings

Baud rate: 9600, 7, EVEN, 1. (ASCII)

9600, 8, EVEN, 1. (RTU)

Controller station number: 1.

Control area/state area: W40100 / W40200.



- 1) This driver can read consecutive communication address on the screen via one Modbus command. For example, if there are 6 devices on the screen, and read the data of the addresses W40140, W40141, W40142, W40145, W40146, W40150, it will read three times. It will read W40140 3 Words at the first time, read W40145 2 Words at the second time and read W40150 1 Word at the third time.
- 2) Ensure to check the check box next to "Optimize" (Optimization for reading) selection in "Communication" tab in the "Configuration" dialog box in "Options" menu (Options → Configuration → Communication). If "Optimize" selection is unchecked, do not select "Data Length Limit".

B. Definition of controller Read/Write address

Registers

Register Type	Format	Read/Write Range		Data length
		Word No.	Bit No.	
Output Registers	Wn	n: 40001 ~ 50000	N/A	Word
Input Registers	Wn	n: 30001 ~ 40000	N/A	Word

➤ Input Registers is "read only".

Contacts

Contact type	Format	Read/Write Range	
		Word No.	Bit No.
Discrete Outputs	Bn	N/A	n: 1 ~ 10000
Discrete Inputs	Bn	N/A	n: 10001 ~ 20000

➤ Discrete Inputs is "read only".

C. Connections (Connector Pinouts)

Please refer to B-1 Pin Definition of Serial Communication for detail.

Modbus(Slave) --- 984 RTU / ASCII mode

DELTA

A. HMI factory settings

Baud rate: 9600, 7, EVEN, 1. (ASCII)

9600, 8, EVEN, 1. (RTU)

Controller station number: 0. (Station number is not used in the protocol.)

Control area/state area: W40100 / 40200.



- 1) HMI station number is Slave station number. (default setting is 0)
- 2) The relation between Modbus address and HMI internal registers.

Modbus address		Data definition in HMI	
W40001 ~ W41024	→	\$0 ~ \$1023	Internal register
W42001 ~ W43024	→	\$M0 ~ \$M1023	Non-volatile internal register
W44001	→	RCPNO	Receipt number register
W45001 ~ ...	→	RCP0 ~ RCPn	Receipt register
B00001 ~ B01024	→	\$2000.0 ~ \$2063.15	Internal register (Bit)
B01025 ~ B02048	→	\$M200.0 ~ \$M263.15	Non-volatile internal register (Bit)

B. Definition of controller Read/Write address

Registers

Register Type	Format	Read/Write Range		Data length
		<u>Word No.</u>	<u>Bit No.</u>	
Output Registers	Wn	n: 40001 ~ 50000	N/A	Word

Contacts

Contact type	Format	Read/Write Range	
		<u>Word No.</u>	<u>Bit No.</u>
Discrete Outputs	Bn	N/A	n: 1 ~ 2048

C. Connections (Connector Pinouts)

Please refer to B-1 Pin Definition of Serial Communication for detail.

CrossReference Table (Inter Memory of Delta HMI and Modbus Reference Address)

Inter Memory of Delta HMI	Modbus Reference Address	Supporting Modbus Function	Address of Function
\$0	40001	03H, 06H, 10H	0000H
\$1	40002	03H, 06H, 10H	0001H
.			
.			
.			
\$1023	41024	03H, 06H, 10H	03FFH

\$M0	42001	03H, 06H, 10H	07D0H
\$M1	42002	03H, 06H, 10H	07D1H
.			
.			
.			
\$M1023	43024	03H, 06H, 10H	0BCFH

RCPNO	44001	03H, 06H	0FA0H
-------	-------	----------	-------

RCP0	45001	03H, 06H, 10H	1388H
RCP1	45002	03H, 06H, 10H	1389H
.			
.			
.			

\$2000.0	00001	01H, 05H, 0FH	0000H
\$2000.1	00002	01H, 05H, 0FH	0001H
.			
.			
.			
\$2000.15	00016	01H, 05H, 0FH	000FH
\$2001.0	00017	01H, 05H, 0FH	0010H
.			
.			
.			
\$2063.0	01009	01H, 05H, 0FH	03F0H
.			
.			
.			
\$2063.15	01024	01H, 05H, 0FH	03FFH

\$M200.0	01025	01H, 05H, 0FH	0400H
----------	-------	---------------	-------

Inter Memory of Delta HMI	Modbus Reference Address	Supporting Modbus Function	Address of Function
\$M200.1	01026	01H, 05H, 0FH	0401H
.			
\$M200.15	01040	01H, 05H, 0FH	040FH
\$M201.0	01041	01H, 05H, 0FH	0410H
.			
\$M263.0	02033	01H, 05H, 0FH	07F0H
.			
\$M263.15	02048	01H, 05H, 0FH	07FFH

For example:

- Read internal memory **\$100** of Delta HMI (HMI station number: 1)
: 01 **03 00 64** 00 01 97 CR LF
Write the value of **1000** into internal memory **\$100** of Delta HMI (HMI station number: 1)
: 01 **06 00 64 03 E8 AA** CR LF
- Read internal memory **\$M100** of Delta HMI (HMI station number: 1)
: 01 **03 08 34** 00 01 BF CR LF
Write the value of **888** into internal memory **\$M100** of Delta HMI (HMI station number: 1)
: 01 **06 08 34 03 78 42** CR LF
- Read internal memory **\$2000.15** of Delta HMI (HMI station number: 1)
: 01 **01 00 0F** 00 01 EE CR LF
Set internal memory **\$2000.15** of Delta HMI to **ON** (HMI station number: 1)
: 01 **05 00 0F FF 00 EC** CR LF
Set internal memory **\$2000.15** of Delta HMI to **OFF** (HMI station number: 1)
: 01 **05 00 0F 00 00 EB** CR LF
- Read internal memory **\$M201.0** of Delta HMI (HMI station number: 1)
: 01 **01 04 10** 00 01 E9 CR LF
Set internal memory **\$M201.0** of Delta HMI to **ON** (HMI station number: 1)
: 01 **05 04 10 FF 00 E7** CR LF
Set internal memory **\$M201.0** of Delta HMI to **OFF** (HMI station number: 1)
: 01 **05 04 10 00 00 E6** CR LF

Modicon TSX Micro (Uni-Telway)

DELTA

A. HMI factory settings

Baud rate: 9600, 8, ODD, 1.

Controller station number: 2.

Control area/state area: %MW0 / %MW10.



- 1) HMI station needs to be adjusted to 1 ~ 8.
- 2) PLC station and HMI station can be the same.
- 3) The internal memory and relative parameters in PLC should be set properly first. Otherwise, it cannot communicate except %S.

B. Definition of controller Read/Write address

Registers

Register Type	Format	Word No.	Bit No.	Data Size
WORD_DEVICE_ Internal	%MWn	n: 0 ~ 65534	N/A	Word
WORD_DEVICE_ System	%SWn	n: 0 ~ 127	N/A	Word
WORD_DEVICE_ Input	%KWn	n: 0 ~ 65534	N/A	Word

➤ %KWn is “read only”.

Contacts

Contact type	Format	Word No.	Bit No.
BIT_DEVICE_ Internal	%Mn:b	n:0 ~ 65534	b:0 ~ 15
BIT_DEVICE_ System	%Sn	-	n:0 ~ 127
BIT_DEVICE_ Internal1	%Mn	-	n:0 ~ 65534

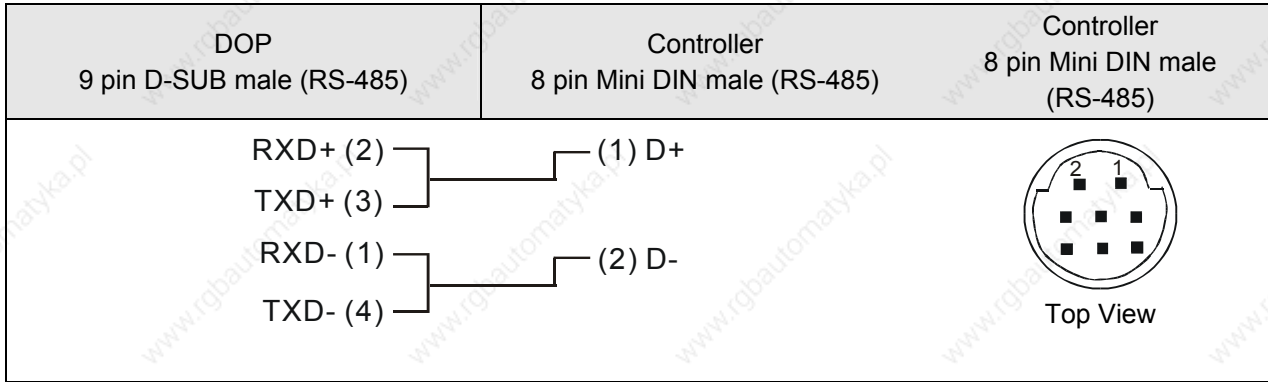
- %Mn: b is Bit address that corresponds to WORD_DEVICE_ Internal (%MWn).
- %Mn is PLC internal relay address.
- The read/write range of WORD_DEVICE_ Internal / BIT_DEVICE_ Internal depends on PLC used memory.

C. Connections (Connector Pinouts)

RS-232

It needs to use specific cable of Modicon Uni-Telway. (RS-232) --- TSX PCX 1031

RS-485



Modicon TWIDO

DELTA

Its function is the same as **Modbus (Master) --- 984 RTU** on page B-71.

NIKKI DENSO NCS-FI/FS Series

DELTA**A. HMI factory settings**

Baud rate: 9600, 8, ODD, 2.

Controller station number: 1. (valid station number: 0 ~ 99)

Control area/state area: None.



- 1) The valid station number is in the range of 0 to 99. If the station number is out of this range, it will be subtracted 100 from itself automatically until the station number is in the valid range.

B. Definition of controller Read/Write address**Registers**

Register Type	Format	Word No.	Bit No.	Data Size
WORD_DEVICE_ RRegister	RW-n	n: 0 ~ 3999	N/A	Word
WORD_DEVICE_ RRegister	RW-n	n: 8000 ~ 9999	N/A	Word
WORD_DEVICE_ DStatus	XW-n	n: 0 ~ 8	N/A	Word
WORD_DEVICE_ DStatus	DW-n	n: 0 ~ 129	N/A	Word
WORD_DEVICE_ RRegister	RD-n	n: 0-3999	N/A	Double Word
WORD_DEVICE_ RRegister	RD-n	n: 8000-9999	N/A	Double Word
WORD_DEVICE_ DStatus	DD-n	n: 0-129	N/A	Double Word



In order to let DOP series HMI be compatible with this controller, DOP series HMI provides various types of data. Please refer to the following description:

- 1) RW-n, RD-n, RB-nb all have corresponding relation (just the data format is different). They all refer to the same address n.
 DW-n, DD-n both have corresponding relation (just the data format is different). They all refer to the same address n.
 XW-n, XB-nb both have corresponding relation (just the data format is different). They all refer to the same address n.
 (In the above format name, the second alphabet represents the data format, W represents Word, D represents Double Word and B represents Bit)
- 2) The data size of RW-n, DW-n is defined as Word in DOP series HMI and each data address is regarded as an individual Word address. The data order use "Little Endian" architecture which means that the low word of the number is stored in memory at the lowest address, and the high word at the highest address. (such as Intel processors (those used in PC's) use "Little Endian" byte order)

Appendix B Communication | ScRedit Software User Manual

For example, if set the starting address as RW900 and the data size is Double Word, the read/write value will be a Double Word which contains RW900(low word) and RW901(high word).

In actual application case, if the users set the data size of RW-n, DW-n as Word, there is no data order reverse problem. However, if the users set the data size of RW-n, DW-n as Double Word, as this controller use "Big Endian" architecture which means that the high word of the number is stored in memory at the lowest address, and the low word at the highest address (such as Motorola processors (those used in Mac's) use "Big Endian" byte order), a data order reverse problem will occur.

- 3) The data size of RD-n, DD-n is defined as Double Word in DOP series HMI and every two data addresses is regarded as an individual Double Word address. The data order use "Big Endian" architecture (see the meaning above).

For example, if set the starting address as RD900 and the data size is Double Word, the read/write value will be a Double Word which contains RW900(high word) and RW901(low word).

In actual application case, if the users set the data size of RD-n, DD-n as Double Word, there is no data order reverse problem and the data display on HMI and the controller will be the same. However, if the users set the data size of RD-n, DD-n as Word, only the low word will display and the high word will be set to 0 automatically. For example, if set the starting address as RD900 and the data size is Word, only the value of RD901(low word) will display. If the write value is 100 at this time, DOP series HMI will set the value of RD901(high word) to 0 and write the value 100 into RD901(low word).

- 4) X-nb and DW-n both have corresponding relation ----- Read DW-n, Write X-nb

DW-0	—	X-0b, (b=0~F)
DW-1	—	X-1b, (b=0~F)
DW-2	—	X-2b, (b=0~F)
DW-4	—	X-3b, (b=0~F)
DW-104	—	X-4b, (b=0~F)
DW-105	—	X-5b, (b=0~F)
DW-106	—	X-6b, (b=0~F)
DW-107	—	X-7b, (b=0~F)
DW-108	—	X-8b, (b=0~F)

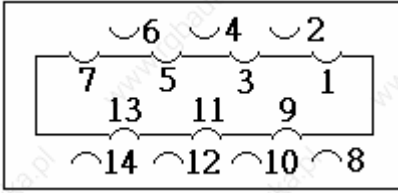
- 5) DW-n, DD-n are "read only". If the users write any value into them, HMI will show error message "Command Can Not be Executed...." on the screen.

Contacts

Contact type	Format	Word No.	Bit No.
BIT_DEVICE_ RRegister	RB-nb	n: 0 ~ 3999	b:0 ~ F
BIT_DEVICE_ RRegister	RB-nb	n: 8000 ~ 9999	b:0 ~ F
BIT_DEVICE_ BitControl	XB-nb	n:0 ~ 8	b:0 ~ F

C. Connections (Connector Pinouts)

RS-422

DOP 9 pin D-SUB male (RS-422)	Controller 14 pin special male (RS-422)	Controller 14 pin special male (RS-422)
RXD- (1) _____ RXD+ (2) _____ TXD+ (3) _____ TXD- (4) _____ GND (5) _____	(9) TXD (B) (2) TXD (A) (4) RXD (A) (11) RXD (B) (14) GND	Cable (PLC side (J1), male).  <p style="text-align: center;">Top View</p>

Omron C Series PLC

DELTA

A. HMI factory settings

Baud rate: 9600, 7, EVEN, 2.

Controller station number: 0.

Control area/state area: DM0 / DM10.

B. Definition of controller Read/Write address

Registers

Register Type	Format	Read/Write Range		Data length
		Word No.	Bit No.	
IR area	IRn	n: 0 ~ 511	N/A	Word
HR area	HRn	n: 0 ~ 99	N/A	Word
AR area	ARn	n: 0 ~ 27	N/A	Word
LR area	LRn	n: 0 ~ 63	N/A	Word
TC area	TCn	n: 0 ~ 511	N/A	Word
DM area	DMn	n: 0 ~ 6655	N/A	Word

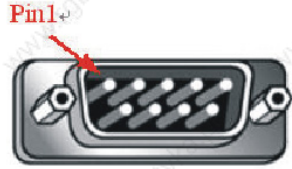
Contacts

Contact type	Format	Read/Write Range	
		Word No.	Bit No.
IR area	IRnb	n: 0 ~ 511	b: 00 ~ 15
HR area	HRnb	n: 0 ~ 99	b: 00 ~ 15
AR area	ARnb	n: 0 ~ 27	b: 00 ~ 15
LR area	LRnb	n: 0 ~ 63	b: 00 ~ 15
TC area	TCn	N/A	n: 0 ~ 511

C. Connections (Connector Pinouts)

RS-232

1:1 Host Link via RS-232C converter

DOP Series 9 pin D-SUB male (RS-232)	Controller 9 pin D-SUB male (RS-232)	Controller 9 pin D-SUB male (RS-232)
RXD (2)	(2) TXD	 <p>Pin 1</p> <p>Top View</p>
TXD (3)	(3) RXD	
GND (5)	(9) SG	
	(4) RS	
	(5) CS	

Omron CJ1/CS1 Series PLC

DELTA

A. HMI factory settings

Baud rate: 9600, 7, EVEN, 2. (RS-232)

Controller station number: 0.

Control area/state area: D0 / D10.



The meaning of Communication Error Message:

1) Word Device:

The Device Name and Address Value will display. For example, if using CIO, H, A, D, E, T, C, W, EM, IR, DR, TK, it will show CIO_n, H_n, A_n, D_n, Em._n, T_n, C_n, W_n, EM_n, IR_n, DR_n, TK_n respectively. “n” is the Address Value.

2) Bit Device:

The Device Name and Word Address Value will display, but the Bit Address Value will not. For example, if using CIO, H, A, D, E, T, C, W, EM, IR, DR, TK, it will show CIOB_n, HB_n, AB_n, DB_n, EBM._n, TB_n, CB_n, WB_n, EMB_n, IRB_n, DRB_n, TKB_n respectively. “n” is the Word Address Value.

B. Definition of controller Read/Write address

Registers

Register Type	Format	Read/Write Range		Data length
		Word No.	Bit No.	
CIO area	CIO _n	n: 0 ~ 9999	N/A	Word
Hold area	H _n	n: 0 ~ 999	N/A	Word
Auxiliary area	A _n	n: 0 ~ 999	N/A	Word
DM area	D _n	n: 0 ~ 65535	N/A	Word
EM area	Em. _n	M: 0 ~ 12 (bank no.) n: 0 ~ 65535	N/A	Word
Timer PVs	T _n	n: 0 ~ 9999	N/A	Word
Counter PVs	C _n	n: 0 ~ 9999	N/A	Word
Work area	W _n	n: 0 ~ 999	N/A	Word
EM Current Bank area	EM _n	n: 0 ~ 65535	N/A	Word
Index Register	IR _n	n: 0 ~ 99	N/A	Double Word
DR area	DR _n	n: 0 ~ 99	N/A	Word
TK area	TK _n	n: 0 ~ 1022 (Even No.)	N/A	Byte

➤ CJ1M Models: An: A0-A477 is “read only”.

Contacts

Contact type	Format	Read/Write Range	
		Word No.	Bit No.
CIO area	CIOBnbb	n: 0 ~ 9999	bb: 00 ~ 15
Hold area	HBnbb	n: 0 ~ 999	bb: 00 ~ 15
Auxiliary area	ABnbb	n: 0 ~ 999	bb: 00 ~ 15
DM area	DBnbb	n: 0 ~ 65535	bb: 00 ~ 15
EM area	EBm.nbb	n: 0 ~ 65535 m: 0 ~ 12 (bank no.)	bb: 00 ~ 15
Timer area	TBn	N/A	n: 0 ~ 9999
Counter area	CBn	N/A	n: 0 ~ 9999
Work area	WBnbb	n: 0 ~ 999	bb: 00 ~ 15
EM Current Bank area	EMBnbb	n: 0 ~ 65535	bb: 00 ~ 15
Index Register	IRBnbb	n: 0 ~ 99	bb: 00 ~ 31
DR area	DRBnbb	n: 0 ~ 99	bb: 00 ~ 15
TK area	TKBnbb	n: 0 ~ 1022 (Even No.)	bb: 00 ~ 15


 **NOTE**

- 1) The following address cannot be written:
 - IRn and DRn: It is not valid if the users write them. HMI will not show any error message if the write operation is done.
 - An and Abnbb: Some range of An and Abnbb (Auxiliary area) is “read only”.
 - TKn / TKBnbb / TBn / CBn / EMBnbb / IRBnbb / DRBnbb: Writing these address is not allowed. If the write operation is done, the error will occur and display the error message “Command Can Not be Executed...” on the screen of HMI.
- 2) The unit of IR address is “Double Word”.
- 3) The unit of TK address is “Byte” and it should be even number.

C. Connections (Connector Pinouts)

RS-232

CJ1M CPU module

DOP Series 9 pin D-SUB male (RS-232)	Controller 9 pin D-SUB male (RS-232)	Controller 9 pin D-SUB male (RS-232)
RXD (2)	(2) TXD	 <p>Pin 1+</p> <p>Top View</p>
TXD (3)	(3) RXD	
GND (5)	(9) SG	
	(4) RS	
	(5) CS	

Siemens S7 200 PLC

DELTA

A. HMI factory settings

Baud rate: 9600, 8, EVEN, 1.

Controller station number: 2.

Control area/state area: VW0 / VW10.

B. Definition of controller Read/Write address

Register

Register Type	Format	Read/Write Range	
		Word No.	Bit No.
Timer	Tn	n: 0 ~ 255	N/A
Analog Input Word	AIWn	n: 0 ~ 30	N/A
Counter	Cn	n: 0 ~ 255	N/A
Analog Output Word	AQWn	n: 0 ~ 30	N/A
Input Image	IWn	n: 0 ~ 14	N/A
Input Image	IDn	n: 0 ~ 12	N/A
Output Image	QWn	n: 0 ~ 14	N/A
Output Image	QDn	n: 0 ~ 12	N/A
Special Bits	SMWn	n: 0 ~ 199	N/A
Special Bits	SMDn	n: 0 ~ 197	N/A
Internal Bits	MWn	n: 0 ~ 98	N/A
Internal Bits	MDn	n: 0 ~ 96	N/A
Data Area	VWn (DBWn)	n: 0 ~ 9998 (n: 0 ~ 9998)	N/A
Data Area	VDn	n: 0 ~ 9996	N/A
Special S	SWn	n: 0 ~ 99	N/A
Special S	SDn	n: 0 ~ 97	N/A

Contacts

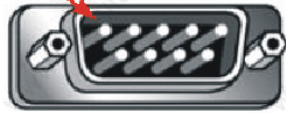
Contact type	Format	Read/Write Range	
		Word No.	Bit No.
Timer Bit	Tn	N/A	n: 0 ~ 255
Counter Bit	Cn	N/A	n: 0 ~ 255
Input Image	In.b	n: 0 ~ 15	b: 0 ~ 7
Output Image	Qn.b	n: 0 ~ 15	b: 0 ~ 7
Special Bit	SMn.b	n: 0 ~ 200	b: 0 ~ 7
Internal Bit	Mn.b	n: 0 ~ 99	b: 0 ~ 7
Data Area Bit	Vn.b	n: 0 ~ 9999	b: 0 ~ 7

Contact type	Format	Read/Write Range	
		Word No.	Bit No.
Special S Bit	Sn.b	n: 0 ~ 100	b: 0 ~ 7

C. Connections (Connector Pinouts)


RS-232

via RS-232 / PPI Multi-Master Cable (Connecting DOP series HMI and PPI cable)

DOP Series 9 pin D-SUB male (RS-232)	Controller 9 pin D-SUB male (RS-232)	Controller 9 pin D-SUB male (RS-232)
RXD (2)	(2) RD	 Top View
TXD (3)	(3) TD	
GND (5)	(5) GND	

RS-485

via PLC Program Port (RS-485)

DOP Series 9 pin D-SUB male (RS-485)	Controller 9 pin D-SUB male (RS-485)	Controller 9 pin D-SUB male (RS-485)
RXD+ (2)	(3) TXD/RXD+	 Top View
TXD+ (3)		
RXD- (1)	(8) TXD/RXD-	
TXD- (4)		
GND (5)	(5) SG	

Siemens S7 300 PLC (with PC Adapter)

DELTA

A. HMI factory settings

Baud rate: 38400, 8, ODD, 1. (RS-232).

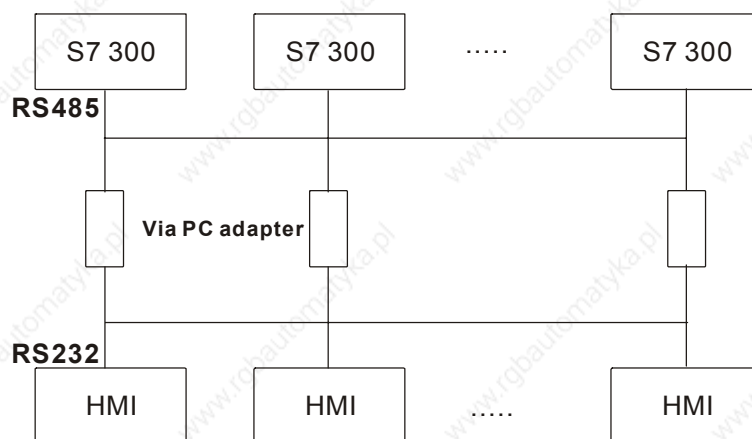
Controller station number: 2.

(As the communicate is via PC adapter, PLC station will not be used, therefore, only 1(HMI) to 1 (PLC) communication is allowed.)

Control area/state area: DBW0 / DBW20.

NOTE

- 1) PLC DB memory (DBm.DBWn, DBm.DBDn, DBm.DBXn.b) must be open so that HMI can read/write.
- 2) The reason for using PC adapter:
When communicating via PC adapter, it is profibus with **187.5 K** baudrate at PLC side. Therefore, the network structure is rapider and steadier.



When HMI communicates with PLC without PC adapter, the protocol will be complicated and it needs to lower PLC baud rate to 19200 due to HMI baudrate limit. Therefore, the efficiency of the network structure of S7 300 will be badly.

- 3) Baud rate setting
 - It needs to set PLC baud rate to 187.5 K and higher. (it cannot use 19.2K)
 - It needs to set baud rate of two sides when using PC Adapter
 - i) "PLC side": It needs to set same baudrate as PLC side (as previous item it needs to set PLC baud rate to 187.5 K and higher and cannot use 19.2K)
 - ii) "HMI side": it can select 38.4K or 19.2K by using switch on the cable. (only these two choices)
 - iii) HMI baud rate: it needs to set the baud rate of HMI side of PC adapter as previous item to 38.4K or 19.2K) (protocol setting is still 8, ODD, 1)
 - iv) There is no setting for PLC station and HMI station, so it won't have the communication problem with error station setting.

v) PC Adapter :

The power LED will be lit once connect to PLC. (power supply of PC adapter is from PLC)
If communication is OK, the communication LED will be blink. Otherwise, it will be dark.

B. Definition of controller Read/Write address

Register

Register Type	Format	Read/Write Range	
		Word No.	Bit No.
Input Image	IWn	n: 0 ~ 65534	N/A
Input Image	IDn	n: 0 ~ 65532	N/A
Output Image	QWn	n: 0 ~ 65534	N/A
Output Image	QDn	n: 0 ~ 65532	N/A
Internal Bits	MWn	n: 0 ~ 65534	N/A
Internal Bits	MDn	n: 0 ~ 65532	N/A
Data Area	DBm.DBWn	n: 0 ~ 65534	m: 1 ~ 255
	DBm.DBDn	n: 0 ~ 65532	m: 1 ~ 255
Data Area (DB10)	DBWn	n: 0 ~ 65534	N/A
	DBDn	n: 0 ~ 65532	N/A
	VWn	n: 0 ~ 65534	N/A
	VDn	n: 0 ~ 65532	N/A
Timer	Tn	n: 0-65535	N/A
Counter	Cn	n: 0-65535	N/A

NOTE

- 1) The valid digit number of the value for the T(Timer) and C(Counter) is 3-digit only. Therefore, please enter a 3-digit number. If entering a number that exceeds 3 digits, only the first 3 digits are valid (decimal format). The other digits of the value for the T(Timer) will be replaced as 0 and the other digits of the value for the C(Counter) will be abandoned. For example, assume that the users enter the value "12345", the actual write value for the T(Timer) will be "12300" and the actual write value for the C(Counter) will be "123".

Contacts

Contact type	Format	Read/Write Range	
		Word No.	Bit No.
Input Image	In.b	n: 0 ~ 65535	b: 0 ~ 7
Output Image	Qn.b	n: 0 ~ 65535	b: 0 ~ 7
Internal Bit	Mn.b	n: 0 ~ 65535	b: 0 ~ 7
Data Area Bit	DBm.DBXn.b	n: 0 ~ 65535	b: 0 ~ 7 m = 1 ~ 255

Contact type	Format	Read/Write Range	
		Word No.	Bit No.
Data Area Bit (10 DB)	DBXn.b	n: 0 ~ 65535	b: 0 ~ 7
	Vn.b	n: 0 ~ 65535	b: 0 ~ 7

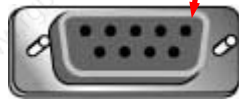
 **NOTE**

- 1) For all contacts when performing “Multiple Duplicate” function:
 - If it exceeds 65535 when increasing, it will be regarded as 0.
 - If it is less than 0, it will be regarded as 655XX.

C. Connections (Connector Pinouts)

RS-232

HMI connects to PC Adaptor

DOP 9 pin D-SUB male	Controller 9 pin D-SUB female	Controller
RXD (2)	(3) TXD	 <p>Top view</p>
TXD (3)	(2) RXD	
GND (5)	(5) GND	
RTS (7)	(8) CTS	
CTS (8)	(7) RTS	

Siemens S7 300 PLC (without PC Adaptor)

DELTA

A. HMI factory settings

Baud rate: 19200, 8, EVEN, 1. (RS-485).

Controller station number: 2.

Control area/state area: DBW0 / DBW20.



- 1) Please notice that only 1(HMI) to 1 (PLC) communication is allowed.
- 2) PLC baud rate should be changed to **19200**. (8, EVEN, 1.).
- 3) **DB** need must be open, otherwise the related addresses can not be read and write.
(The related addresses are: DB.DBW, DB.DBD, DBW, DBD, VW, VD, DB.DBX, DBX, V)
- 4) HMI station must be set to 0 ~ 15. If it is out of this range, it will be changed to 15 automatically. PLC station number must be set to 0 ~ 15.
- 5) The communication cable is the same as S7 200 series (RS-485).
- 6) If not connecting to communication cable, after 5 seconds, HMI will show error message on the screen. If connecting to communication cable, it is needed to power on HMI again, and then the communication can be found.
- 7) After power in connected to HMI, HMI must accept the notification from PLC and then connection will be established. The first time connection will take more time, but in normal condition, it should be connected in 5 seconds.
- 8) This protocol is a multi-step and recurrent communication protocol (HMI needs to communicate with PLC for many times for completing 1 command.). The communication speed of S7 300 PLC (without PC Adaptor) is usually slower than the other controllers, but it is the same as the communication speed of S7 300 PLC (without PC Adaptor).

B. Definition of controller Read/Write address

Register

Register Type	Format	Read/Write Range	
		Word No.	Bit No.
Input Image	IWn	n: 0 ~ 65534	N/A
Input Image	IDn	n: 0 ~ 65532	N/A
Output Image	QWn	n: 0 ~ 65534	N/A
Output Image	QDn	n: 0 ~ 65532	N/A
Internal Bits	MWn	n: 0 ~ 65534	N/A
Internal Bits	MDn	n: 0 ~ 65532	N/A

Register Type	Format	Read/Write Range	
		Word No.	Bit No.
Data Area	DBm.DBWn	n: 0 ~ 65534	m: 1 ~ 255 (Note 1)
	DBm.DBDn	n: 0 ~ 65532	m: 1 ~ 255 (Note 1)
Data Area (DB10)	DBWn	n: 0 ~ 65534	N/A
	DBDn	n: 0 ~ 65532	N/A
	VWn	n: 0 ~ 65534	N/A
	VDn	n: 0 ~ 65532	N/A
Timer	Tn	n: 0 ~ 65535	N/A
Counter	Cn	n: 0 ~ 65535	N/A

 **NOTE**

- 1) High Byte of Bit No.
 - The valid digit number of the value for the T(Timer) and C(Counter) is 3-digit only. Therefore, please enter a 3-digit number. If entering a number that exceeds 3 digits, only the first 3 digits are valid (decimal format). The other digits of the value for the T(Timer) will be replaced as 0 and the other digits of the value for the C(Counter) will be abandoned. For example, assume that the users enter the value "12345", the actual write value for the T(Timer) will be "12300" and the actual write value for the C(Counter) will be "123".

Contacts

Contact type	Format	Read/Write Range	
		Word No.	Bit No.
Input Image	In.b	n: 0 ~ 65535	b: 0 ~ 7 (Note 2)
Output Image	Qn.b	n: 0 ~ 65535	b: 0 ~ 7 (Note 2)
Internal Bit	Mn.b	n: 0 ~ 65535	b: 0 ~ 7 (Note 2)
Data Area Bit	DBm.DBXn.b	n: 0 ~ 65535	b: 0 ~ 7 (Note 2)
			m = 1 ~ 255 (Note 3)
Data Area Bit (DB 10)	DBXn.b	n: 0 ~ 65535	b: 0 ~ 7 (Note 2)
	Vn.b	n: 0 ~ 65535	b: 0 ~ 7 (Note 2)

 **NOTE**

- 2) Low Byte of Bit No.
- 3) High Byte of Bit No.
- 4) For all timers, counters and contacts when performing "Multiple Duplicate" function:
 - If it exceeds 65535 when increasing, it will be regarded as 0.
 - If it is less than 0, it will be regarded as 655XX.


C. Connections (Connector Pinouts)

The communication cable is the same as S7 200 series (RS-485). Please refer to the Connections of S7 200 series (RS-485).

C. Connections (Connector Pinouts)

RS-485

via PLC MPI Port (RS-485)

DOP 9 pin D-SUB male (RS-485)	Controller 9 pin D-SUB male (RS-485)	Controller 9 pin D-SUB male (RS-485)
RXD+ (2) ———— TXD+ (3) ———— RXD- (1) ———— TXD- (4) ———— GND (5) ————	(3)TXD/RXD+ (8)TXD/RXD- (5)SG	 <p>Top view</p>

Taian TP02 PLC

DELTA

A. HMI factory settings

Baud rate: 19200, 7, None, 1.

Controller station number: 1.

Control area/state area: V1 / V10.

B. Definition of controller Read/Write address

Registers

Register Type	Format	Read/Write Range		Data length
		Word No.	Bit No.	
WORD_DEVICE_X	Xn	n: 1 ~ 384	N/A	Word
WORD_DEVICE_Y	Yn	n: 1 ~ 384	N/A	Word
WORD_DEVICE_C	Cn	n: 1 ~ 2048	N/A	Word
WORD_DEVICE_V	Vn	n: 1 ~ 1024	N/A	Word
WORD_DEVICE_D	Dn	n: 1 ~ 2048	N/A	Word
WORD_DEVICE_WS	WSn	n: 1 ~ 128	N/A	Word
WORD_DEVICE_WC	WCn	n: 1 ~ 912	N/A	Word

- WORD_DEVICE_X / WORD_DEVICE_Y / WORD_DEVICE_C: Address must be 1 or the multiple of 16+1.


Contacts

Contact type	Format	Read/Write Range	
		Word No.	Bit No.
BIT_DEVICE_X	Xn	N/A	n: 1 ~ 384
BIT_DEVICE_Y	Yn	N/A	n: 1 ~ 384
BIT_DEVICE_C	Cn	N/A	n: 1 ~ 2048
BIT_DEVICE_SC	SCn	N/A	n: 1 ~ 128

- BIT_DEVICE_SC: Only 1 Bit can be transferred for each read command.

C. Connections (Connector Pinouts)

RS-422

DOP 9 pin D-SUB male (RS-422)	Controller 9 pin D-SUB male (RS-422)	Controller 9 pin D-SUB male (RS-422)
RXD+ (2) ————— (3) TXD+	RXD- (1) ————— (8) TXD-	 <p>Top View</p>
TXD+ (3) ————— (2) RXD+	TXD- (4) ————— (7) RXD-	

RS-485

DOP 9 pin D-SUB male (RS-232)	Controller RS-485 (T/R+, T/R-)
RXD+ (2) ———— T/R+	
TXD+ (3) ———— T/R+	
RXD- (1) ———— T/R-	
TXD- (4) ———— T/R-	

Vigor M Series

DELTA

A. HMI factory settings

Baud rate: 19200, 7, EVEN, 1.

Controller station number: 0.

Control area/state area: D0 / D10.



- 1) Controller station number: 0 for PROGRAMMER PORT; 1 for COM PORT
- 2) VB series also can use this driver.

B. Definition of controller Read/Write address

Registers

Register Type	Format	Read/Write Range		Data length
		Word No.	Bit No.	
Input Relay	Xn	n: 0 ~ 770 (Octal)	N/A	Word (multiple of 8)
Output Relay	Yn	n: 0 ~ 770 (Octal)	N/A	Word (multiple of 8)
Auxiliary Relay	Mn	n: 0 ~ 5112	N/A	Word (multiple of 8)
Special Relay	Mn	n: 9000 ~ 9248	N/A	Word (9000 + multiple of 8)
Step Relay	Sn	n: 0 ~ 992	N/A	Word (multiple of 8)
Timer Present Value	Tn	n: 0 ~ 255	N/A	Word
16-bit Counter Present Value	Cn	n: 0 ~ 199	N/A	Word
32-bit Counter Present Value	Cn	n: 200 ~ 255	N/A	Word
Data Register	Dn	n: 0 ~ 8191	N/A	Word
Special Data Register	Dn	n: 9000 ~ 9248	N/A	Word

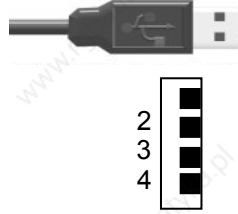
Contacts

Contact type	Format	Read/Write range	
		Word No.	Bit No.
Input Relay	Xn	N/A	n: 0 ~ 777(Octal)
Output Relay	Yn	N/A	n: 0 ~ 777(Octal)
Auxiliary Relay	Mn	N/A	n: 0 ~ 5119
Special Relay	Mn	N/A	n: 9000 ~ 9255
Step Relay	Sn	N/A	n: 0 ~ 999
Timer Contact	Tn	N/A	n: 0 ~ 255
Counter Contact	Cn	N/A	n: 0 ~ 255
Timer Coil	TCn	N/A	n: 0 ~ 255
Counter Coil	CCn	N/A	n: 0 ~ 255


C. Connections (Connector Pinouts)

RS-232

(PROGRAMMER PORT)

DOP 9 pin D-SUB male(RS-232)	Controller USB TAPE A Connector	Controller USB TAPE A Connector
RXD (2) ————— (3) TXD		 <p>Top View</p>
TXD (3) ————— (2) RXD		
GND (5) ————— (4) GND		

(COM PORT)

DOP 9 pin D-SUB male (RS-232)	Controller 9 pin D-SUB female (RS-232)	Controller 9 pin D-SUB female (RS-232)
RXD (2) ————— (3) TXD		 <p>Top View</p>
TXD (3) ————— (2) RXD		
GND (5) ————— (5) GND		

YOKOGAWA ACE PLC

DELTA**A. HMI factory settings**

Baud rate: 9600, 8, EVEN, 1. (ASCII code)

Controller station number: 1.

CPU NO. : 1.

Control area/state area: D1 / D10.



- 1) CheckSum and End character (CR, LF) are not used during communication. Therefore, the controller should be set to "Not using CheckSum and End character" also.
- 2) CPU number is used during communication, however, Screen Editor software do not have this selection. Therefore, if the user desire to set CPU number, please set HMI station number in "General" tab in the "Configuration" dialog box in "Options" menu (Options → "Configuration" → General). (HMI station number is regarded as CPU number here. The default setting of HMI station number is 0, but 0 is an illegal number, the user must set it as a legal value.

B. Definition of controller Read/Write address**Registers**

Register Type	Format	Word No.	Data Size
WORD_DEVICE_X	Xn	n: 201 ~ 65464	Word
WORD_DEVICE_Y	Yn	n: 201 ~ 65464	Word
WORD_DEVICE_I	In	n: 1 ~ 16384	Word
WORD_DEVICE_E	En	n: 1 ~ 4096	Word
WORD_DEVICE_L	Ln	n: 1 ~ 65488	Word
WORD_DEVICE_M	Mn	n: 1 ~ 9984	Word
WORD_DEVICE_TP	TPn	n: 1 ~ 3072	Word
WORD_DEVICE_CP	CPn	n: 1 ~ 3072	Word
WORD_DEVICE_D	Dn	n: 1 ~ 8192	Word
WORD_DEVICE_B	Bn	n: 1 ~ 32768	Word
WORD_DEVICE_W	Wn	n: 1 ~ 65499	Word
WORD_DEVICE_Z	Zn	n: 1 ~ 512	Word
WORD_DEVICE_V	Vn	n: 1 ~ 64	Word
WORD_DEVICE_R	Rn	n: 1 ~ 4096	Word
WORD_DEVICE_TS	TSn	n: 1 ~ 3072	Word
WORD_DEVICE_CS	CSn	n: 1 ~ 3072	Word

- WORD_DEVICE_X / WORD_DEVICE_Y: The last two digits of address must be 1 or the multiple of 16+1 and less than 65.

- WORD_DEVICE_I / WORD_DEVICE_E / WORD_DEVICE_L / WORD_DEVICE_M: Address must be 1 or the multiple of 16+1.
- WORD_DEVICE_X / WORD_DEVICE_Y / WORD_DEVICE_L / WORD_DEVICE_W: Valid address is inconsecutive.

Contacts


Contact type	Format	Bit No.
BIT_DEVICE_X	Xn	n: 201 ~ 65464
BIT_DEVICE_Y	Yn	n: 201 ~ 65464
BIT_DEVICE_I	In	n: 1 ~ 16384
BIT_DEVICE_E	En	n: 1 ~ 4096
BIT_DEVICE_L	Ln	n: 1 ~ 65488
BIT_DEVICE_M	Mn	n: 1 ~ 9984
BIT_DEVICE_TU	TUn	n: 1 ~ 3072
BIT_DEVICE_CU	CUn	n: 1 ~ 3072

- BIT_DEVICE_X / BIT_DEVICE_Y : the last two digits of address must be less than 65 (1 ~ 64).
- BIT_DEVICE_X / BIT_DEVICE_Y / BIT_DEVICE_L : valid address is inconsecutive.
- Multiple Duplicate:
 - The next Bit address of X264 is X301 (invalid addresses X265 ~ X300 are skipped)
 - The next Bit address of X364 is X401.
 - The address of Y is the same as X.
 - (The Word addresses of X and Y are also auto skip invalid addresses)

C. Connections (Connector Pinouts)

It needs to use specific cable of YOKOGAWA ACE PLC.

RS-232

DOP 9 pin D-SUB male (RS-232)	Controller (6 pin) (RS-232 for YOKOGAWA)	Controller (6 pin) (RS-232 for YOKOGAWA)
RXD (2) ————— (1) TXD TXD (3) ————— (2) RXD GND (5) ————— (5) GND		 Top View

This page intentionally left blank.