

SIEMENS

SIMATIC



Industrial PC SIMATIC Box PC 627B

Operating Instructions

<u>Introduction</u>	1
<u>Safety information</u>	2
<u>Description</u>	3
<u>Application planning</u>	4
<u>Mounting</u>	5
<u>Connecting</u>	6
<u>Commissioning</u>	7
<u>Integration</u>	8
<u>Functions</u>	9
<u>Expansions and programming</u>	10
<u>Maintenance and service</u>	11
<u>Alarm, error, and system messages</u>	12
<u>Troubleshooting/FAQs</u>	13
<u>Specifications</u>	14
<u>Dimensional drawings</u>	15
<u>Detailed descriptions</u>	16
<u>Appendix</u>	A
<u>ESD directives</u>	B
<u>List of Abbreviations/Acronyms</u>	C

Safety Guidelines

This manual contains notices you have to observe in order to ensure your personal safety, as well as to prevent damage to property. The notices referring to your personal safety are highlighted in the manual by a safety alert symbol, notices referring only to property damage have no safety alert symbol. These notices shown below are graded according to the degree of danger.

 DANGER
indicates that death or severe personal injury will result if proper precautions are not taken.
 WARNING
indicates that death or severe personal injury may result if proper precautions are not taken.
 CAUTION
with a safety alert symbol, indicates that minor personal injury can result if proper precautions are not taken.
CAUTION
without a safety alert symbol, indicates that property damage can result if proper precautions are not taken.
NOTICE
indicates that an unintended result or situation can occur if the corresponding information is not taken into account.

If more than one degree of danger is present, the warning notice representing the highest degree of danger will be used. A notice warning of injury to persons with a safety alert symbol may also include a warning relating to property damage.

Qualified Personnel

The device/system may only be set up and used in conjunction with this documentation. Commissioning and operation of a device/system may only be performed by **qualified personnel**. Within the context of the safety notes in this documentation qualified persons are defined as persons who are authorized to commission, ground and label devices, systems and circuits in accordance with established safety practices and standards.

Prescribed Usage

Note the following:

 WARNING
This device may only be used for the applications described in the catalog or the technical description and only in connection with devices or components from other manufacturers which have been approved or recommended by Siemens. Correct, reliable operation of the product requires proper transport, storage, positioning and assembly as well as careful operation and maintenance.

Trademarks

All names identified by ® are registered trademarks of the Siemens AG. The remaining trademarks in this publication may be trademarks whose use by third parties for their own purposes could violate the rights of the owner.

Disclaimer of Liability

We have reviewed the contents of this publication to ensure consistency with the hardware and software described. Since variance cannot be precluded entirely, we cannot guarantee full consistency. However, the information in this publication is reviewed regularly and any necessary corrections are included in subsequent editions.

Table of contents

1	Introduction	9
1.1	Preface.....	9
1.2	Guideline to the operating instructions	10
2	Safety information	11
2.1	General safety instructions	11
3	Description	13
3.1	Overview	13
3.2	Areas of application	14
3.3	Benefits	14
3.4	Function	15
3.5	Features	16
3.6	Windows XP Embedded	19
3.7	Design	20
3.7.1	External structure	20
3.7.2	Operator Controls	22
3.7.3	Connection elements	23
3.7.4	Status displays	26
4	Application planning	29
4.1	Transport.....	29
4.2	Unpacking and checking the delivery unit	29
4.3	Device identification data	30
4.4	Ambient and environmental conditions.....	31
4.5	Permitted mounting positions.....	32
5	Mounting	35
5.1	Installing the device	35
5.2	Installation of the device with mounting brackets	36
5.3	Installation of the device with the vertical mounting kit.....	37
6	Connecting	39
6.1	Connecting peripherals	39
6.2	Connecting the 120 V / 230 V Ac power supply	40
6.3	Connecting the (24 V) DC power supply	42
6.4	Connecting equipotential bonding.....	43
6.5	Connecting Ethernet strain relief.....	44

7	Commissioning	45
7.1	Requirements for commissioning.....	45
7.2	Basic commissioning - initial startup	45
7.3	Windows XP, Vista Security Center.....	46
7.4	Switching off the device	46
7.5	Notes on operation.....	47
7.5.1	DVD burner	47
7.5.2	2HDD system (optional)	48
7.5.3	RAID1 system (optional)	49
7.5.4	Compact Flash card (optional).....	52
8	Integration	55
8.1	Integration into an automation system	55
8.2	PROFINET	57
9	Functions	59
9.1	Overview	59
9.2	Temperature monitoring.....	59
9.3	Watchdog (WD).....	60
9.4	Fan monitoring	60
9.5	Safecard on Motherboard (SOM).....	61
9.6	Status display.....	62
9.7	SRAM buffer memory.....	63
9.8	Battery monitoring	64
10	Expansions and programming	65
10.1	Opening the Device.....	65
10.2	Memory expansion.....	67
10.2.1	Removing/Installing Memory Module.....	67
10.3	Installing PCI / PCI Express cards	70
10.3.1	Notes on the modules	70
10.3.2	Installing / removing expansion modules	70
10.4	Installing drives	72
10.4.1	Options of installing disk drives.....	72
10.4.2	Installing/removing a drive bay module.....	74
10.4.3	Removing / installing an optical drive.....	75
10.4.4	Installing / removing hard disks.....	76
10.5	Installing/removing an on-board Compact Flash card	77
10.6	Installing/removing an additional Compact Flash card	81

11	Maintenance and service	85
11.1	Removing and installing hardware components.....	85
11.1.1	Repairs.....	85
11.1.2	Preventive maintenance.....	86
11.1.3	Replacing the Backup Battery.....	86
11.1.4	Removing/Installing the Power Supply.....	89
11.1.5	Installing / removing the bus board.....	91
11.1.6	Installing / removing the motherboard.....	92
11.1.7	Installing / removing the equipment fan.....	94
11.1.8	Installing / removing the power supply fan.....	96
11.1.9	Installing / removing the processor.....	98
11.2	Reinstalling the operating system.....	101
11.2.1	Windows XP Embedded.....	101
11.2.1.1	General installation procedure.....	101
11.2.1.2	Restoring the software to factory state using the Restore CD.....	101
11.2.2	Windows XP Professional / Windows 2000 Professional.....	103
11.2.2.1	General installation procedure.....	103
11.2.2.2	Restoring the Software to Factory State Using the Restore DVD.....	103
11.2.2.3	Setting up the operating system via the Recovery CD.....	105
11.2.3	Recovery of Windows Vista.....	109
11.3	Partitioning data media.....	112
11.3.1	Setting up the partitions under Windows XP Embedded.....	112
11.3.2	Setting up partitions under Windows XP Professional / Windows 2000 MUI.....	112
11.4	Install drivers and software.....	113
11.4.1	Installing drivers and software.....	113
11.4.2	Driver installation under Windows XP Embedded.....	113
11.5	RAID1 system setup.....	114
11.5.1	Settings in the BIOS setup and RAID ROM option.....	114
11.5.2	Replacing a defective drive in the RAID system.....	115
11.5.3	Installing the RAID Controller software.....	119
11.6	Installing burner software.....	120
11.6.1	Installing the burner software.....	120
11.7	Installing updates.....	120
11.7.1	Updating the operating system.....	120
11.7.2	Installing or updating application programs and drivers.....	120
11.8	Data backup.....	121
11.8.1	Creating an image.....	121
11.9	CP 1616 onboard.....	122
12	Alarm, error, and system messages	123
12.1	Boot error messages.....	123
12.2	BIOS beep codes.....	125
13	Troubleshooting/FAQs	127
13.1	General problems.....	127
13.2	Problems when Using Modules of Third-party Manufacturers.....	128
13.3	Display a temperature fault by means of the SOM application.....	129

14	Specifications	131
14.1	General Specifications	131
14.2	Power requirements of the components	135
14.3	AC voltage supply	136
14.4	DC power supply	137
15	Dimensional drawings.....	139
15.1	Overview of the dimensional drawings	139
15.2	Dimensional Drawing of the Device	140
15.3	Dimensional drawings for the installation of expansion modules	143
16	Detailed descriptions	145
16.1	Motherboard.....	145
16.1.1	Structure and functions of the motherboard.....	145
16.1.2	Technical features of the motherboard	146
16.1.3	Position of the interfaces on the motherboard	148
16.1.4	External ports	149
16.1.5	Front ports	156
16.1.6	Internal interfaces.....	161
16.2	Bus board	165
16.2.1	Layout and principle of operation.....	165
16.2.2	PCI slot pin assignment	167
16.2.3	Pin assignment 12 V power supply connection for WinAC module.....	168
16.2.4	PCI Express slot x4 pin assignment	169
16.3	System resources	170
16.3.1	Currently allocated system resources	170
16.3.2	System resources used by the BIOS/DOS	171
16.3.2.1	I/O address allocation	171
16.3.2.2	Interrupt Assignments	173
16.3.2.3	Exclusive PCI hardware interrupt.....	176
16.3.2.4	Memory address assignments	177
16.4	BIOS Setup	178
16.4.1	Overview	178
16.4.2	Starting BIOS Setup.....	179
16.4.3	BIOS Setup menus	180
16.4.4	Main menu.....	182
16.4.5	Advanced menu	193
16.4.6	Security menu	199
16.4.7	Boot Menu	201
16.4.8	Version Menu	202
16.4.9	Exit menu	203
16.4.10	BIOS Setup default settings	204
16.5	Communication processor CP 1616 onboard.....	207
16.5.1	Introduction	207
16.5.1.1	Network connections.....	207
16.5.1.2	Typical Communication Partners	208
16.5.2	Firmware loader	210
16.5.2.1	Loading firmware.....	211
16.5.3	Further actions in STEP 7/NCM PC.....	212

A	Appendix.....	213
A.1	Guidelines and declarations.....	213
A.2	Certificates and approvals.....	215
A.3	Service and support.....	217
B	ESD directives.....	219
B.1	ESD directives.....	219
C	List of Abbreviations/Acronyms.....	221
C.1	Abbreviations.....	221
	Glossary.....	227
	Index.....	237

Introduction

1.1 Preface

Purpose of this document

These operating instructions contain all the information you need for commissioning and using the SIMATIC Box PC 627B.

It is intended both for programming and testing personnel who commission the device and connect it with other units (automation systems, additional programming devices), as well as for service and maintenance personnel who install add-ons or carry out fault/error analyses.

Scope of validity of this document

This documentation applies for all variations of the SIMATIC Box PC 627B and describes the delivery status as of June 2008.

Its place in the information landscape

These operating instructions are available on the "Documentation and Drivers" CD included with your product.

For further instructions on how to handle the software, please refer to the corresponding manuals.

Conventions

The abbreviation Box PC or device is also used within this documentation for the product name SIMATIC Box PC 627B. The abbreviations CP for CP 1616 onboard and Vista for Windows Vista Ultimate are also used.

History

Currently released versions of these operating instructions:

Edition	Comment
05/2007	First Edition
06/2008	<ul style="list-style-type: none">• Remedy• New operating system: Windows Vista Ultimate• Functionality: additional CP 1616 onboard

1.2 Guideline to the operating instructions

Organization of contents	Contents
Contents	Detailed organization of the documentation, including the index of pages and chapters
Introduction	Purpose, layout and description of the important topics.
Safety information	Covers all general safety-related aspects of statutory regulations in terms of the installation, commissioning and operation of the product/system.
Description	Fields of application, features and installation of the product/system
Application planning	Aspects of storage, transport, environmental and EMC conditions to be considered in the preparatory stage
Installing	Product installation options and installation instructions
Connecting	Options for connecting the product and wiring instructions
Commissioning	Commissioning the product/system.
Integration	Options of integrating the product into existing or planned system environments/networks.
Functions	Monitoring and display functions
Expansions / Programming	Installation of expansion devices (memory, modules, drives)
Maintenance and service	Replacement of hardware components, restoring and setup of the operating system, installation of drivers and software
Troubleshooting	Problems, cause, remedy
Specifications	General specifications in compliance with relevant standards and current/voltage values
Dimensional Drawings	Dimensions of the device and of modules
Detailed descriptions	Structure, function and features of vital components, distribution of system resources and use of the BIOS Setup routine
Appendix	Guidelines and certifications, service and support, notes on retrofitting
ESD directives	General ESD directives.

Safety information

2.1 General safety instructions

 CAUTION
--

Please observe the safety instructions on the back of the cover sheet of this documentation. You should not expand your device unless you have read the relevant safety instructions.

This device is compliant with the relevant safety measures to IEC, EN, VDE, UL, and CSA. If you have questions about the validity of the installation in the planned environment, please contact your service representative.

Repairs

Only authorized personnel are permitted to repair the device.

 WARNING
--

Unauthorized opening and improper repairs can cause considerable damage to property or danger for the user.

System expansions

Only install system expansion devices designed for this device. The installation of other expansions can damage the system and violate the radio-interference suppression regulations. Contact your technical support team or where you purchased your PC to find out which system expansion devices may safely be installed.

CAUTION

If you install or exchange system expansions and damage your device, the warranty becomes void.

2.1 General safety instructions

Battery

This device is equipped with a Lithium battery. Batteries may only be replaced by qualified personnel.

 CAUTION
There is the risk of an explosion if the battery is not replaced as directed. Replace only with the same type or with an equivalent type recommended by the manufacturer. Dispose of used batteries in accordance with local regulations.

 WARNING
Risk of explosion and release of harmful substances! For this reason, do not burn lithium batteries, do not solder on the cell body, do not open, do not short circuit, do not reverse polarity, do not heat above 100°C, dispose of correctly, and protect against direct sunlight, dampness and dew.

ESD directives

Modules containing electrostatic sensitive devices (ESDs) can be identified by the following label:



Strictly follow the guidelines mentioned below when handling modules which are sensitive to ESD:

- Always discharge your body's static electricity before handling modules that are sensitive to ESD (for example, by touching a grounded object).
- All devices and tools must be free of static charge.
- Always pull the mains connector and disconnect the battery before you install or remove modules which are sensitive to ESD.
- Handle modules fitted with ESDs by their edges only.
- Do not touch any wiring posts or conductors on modules containing ESDs.

Description

3.1 Overview

The SIMATIC Box PC 627B is especially suited for industrial PC applications and delivers high processor performance in compact space:

- Compact design
- Expandable (2 slots for expansion modules)
- Scalability
- High performance
- High degree of ruggedness



Figure 3-1 SIMATIC Box PC 627B

3.2 Areas of application

The SIMATIC Box PC 627B provides engineers building machines, plants and switch cabinets with a high performance, expandable PC platform for industrial application on the plant floor:

- Measurement, controlling and regulation of process and machine data, for example, for redundant process control systems and transport systems in production facilities
- Operating and visualization tasks with separate display / monitor solutions, for example, large-scale displays in automotive production
- Data logging and processing, for example, production data logging, distributed process control

The SIMATIC Box PC 627B has CE certification for use in the industrial sector as well as in residential and commercial areas, and small businesses. In addition to industrial applications, it can also be used in building services automation or in facilities open to the public.

3.3 Benefits

Reduction in standstill times thanks to high system availability

- Efficient self-diagnostics (SIMATIC PC DiagMonitor \geq V 3.1, optionally available)
- Solutions for data security (preventative data backups, Image Creator, optionally available)
- Service-friendly design (modifications, servicing)
- Additional hardware and software options (secondary hard disk or RAID1 configuration)

Cost reductions through high investment security

- High product continuity through long-term secure functionality in hardware and software (support for legacy interfaces)
- Secure replacement availability of the components (5 years)

Reduced costs through high industrial functionality

- High industrial capability through extremely robust design, even against strong vibration and impact loads, and with high ambient temperatures (ventilation design)
- Totally Integrated Automation (TIA) components including integrated PROFIBUS/MPI interface (optional) and Ethernet interface, system-tested SIMATIC software package
- Sufficient flexibility and expandability (2 free slots) in the most compact space

Cost minimization through time savings

- Configured, turn-key systems
- Preinstalled operating systems for fast commissioning
- Integrated interfaces for communication on the field or process control level

3.4 Function

- Integrated configurable monitoring functions (program execution (watchdog) for internal housing temperature, processor temperatures, disk drive temperatures and RPM of the two fans)
- Enhanced diagnostics / messaging via Ethernet, e-mail, SMS, and for direct input in SIMATIC software applications via OPC (optional via SIMATIC PC DiagMonitor ≥ V 3.1):
 - Operating hours counter
 - Hard disk status
 - Automatic logging of all messages to a log file
 - Options for central monitoring of networked SIMATIC PCs
- RAID1 for automatic data mirroring on two hard disk volumes

3.5 Features

Basic data	
Design	Panel mounting device, box
Processor	<ul style="list-style-type: none"> • Celeron M 440 1.86 GHz, 533 MHz Front Side Bus (FSB), 1024 KB Second Level Cache or • Core 2 Duo T5500, 1.66 GHz, 667 MHz Front Side Bus, 2048 KB Second Level Cache • Core 2 Duo T7400, 2.16 GHz, 667 MHz Front Side Bus, 4096 KB Second Level Cache
RAM	<ul style="list-style-type: none"> • 256 MB SDRAM (DDR2) • Expandable up to 4 GB SDRAM (DDR2)
Slots for add-ons	<ul style="list-style-type: none"> • 1x PCI 265 mm long and 1x PCI 175 mm long • 1x PCI 265 mm long and 1x PCI Express x4 175 mm long
Graphics	<ul style="list-style-type: none"> • Intel® GMA950 graphics controller, chip set integrated 2-D and 3-D engine, Dynamic Video Memory Technology (uses up to 128 MB RAM) • CRT: Max. 1280x1024 at 100 Hz / 32-bit color depth Max. 1600x1200 at 60 Hz / 32-bit color depth Maximum resolution: 2038x1536 at 75 Hz / 16-bit color depth • LCD via DVI-I: 1600x1200 at 60 Hz / 32-bit color depth
Power supply	<ul style="list-style-type: none"> • 120 V / 230 V AC, 190 W; varying voltage • 24 V DC, 210 W <p>Both with bridging of transient loss of voltage according to NAMUR: Max. 20 ms at 0.85 rated voltage.</p> <p>The 24V DC power supply is protected against reversed polarity.</p>
Drives and storage media	
Hard disk drives	<ul style="list-style-type: none"> • 1 x 3.5" hard disk or • 2 x 2.5" hard disk or RAID1 system Capacity see order forms
DVD drive	DVD burner
Flash drive	Slot for Compact Flash card

Basic data	
Ports	
Ethernet	2x 10/100/1000 Mbps (RJ45)
PROFIBUS/MPI	12 Mbps (isolated potential, compatible to CP 5611), optional
PROFINET	10/100 Mbps (CP 1616 onboard), three RJ45; optional
USB	<ul style="list-style-type: none"> External: 4x USB 2.0 high current (max. 2 can be simultaneously operated as high current) Internal: 1x USB 2.0 high current, 1x USB 2.0 low current Front panel ports: 1x USB 1.1, 1x USB 2.0, both high current
COM	Serial V.24 port
Monitor	1x DVI-I (VGA monitors can be connected with a DVI/VGA adapter)

Monitoring and safety functions	
Temperature	<ul style="list-style-type: none"> When permitted temperature range is exceeded Warning messages from application program that can be analyzed: local, via LAN (DiagMonitor, optionally available)
Fans	<ul style="list-style-type: none"> Failure of device and power supply fans Warning messages from application program that can be analyzed: local, via LAN (DiagMonitor, optionally available)
Watchdog	<ul style="list-style-type: none"> Monitoring function for program execution Restart can be parameterized in the event of a fault Warning messages from application program that can be analyzed: local, via LAN (DiagMonitor, optionally available)
LED display	2 LEDs for displaying system status 2 of these can be programmed by the user ¹
Transient voltage interruption	Up to 20 ms buffer time with full load
Buffer memory	2 MB battery-buffered SRAM ¹

¹Contact Customer Support for information about addressing the LEDs or the SRAM under a Windows operating system.

Optional accessories	
Book mounting bracket	For space optimizing installation in switch cabinet

Optional expansions	
SIMATIC PC DiagMonitor software ≥ V 3.1	Software tool for monitoring local and remote SIMATIC PCs: <ul style="list-style-type: none"> • Watchdog • Temperature • Fan speed • Hard disk monitoring (SMART) Communication: <ul style="list-style-type: none"> • Ethernet interface (SNMP protocol) • OPC for integration in SIMATIC software • Client server architecture • Layout of log files
SIMATIC PC Image Creator software	Software tool for saving data locally
PCI Multi-I/O module	Provides one parallel and one serial interface

Software	
Operating systems	<ul style="list-style-type: none"> • Without • Preinstalled / supplied on restore CD/DVD: <ul style="list-style-type: none"> – Windows 2000 Professional SP4 MUI* – Windows XP Professional SP2 MUI* – Windows XP embedded SP2 English on Compact Flash – Windows Vista Ultimate *MUI: Multi Language User Interface; 5 languages (English, German, French, Spanish, Italian)

3.6 Windows XP Embedded

The overview shows the most important device functions under Windows XP Embedded:

Function	Compact Flash card version
Enhanced Write Filter (EWF)	in RAM RAM(REG)
Safecard on Motherboard (SOM)	Available V 3.02
Pagefile	Not available
System Restore Core	Available
MUI	Not available
Administrator Account	Available
User Account	Available
Explorer Shell	Available
Internet Explorer (IE) 6.0	Available IE6.0 (SP 2)
Internet Information Server (IIS)	Available V 5.1
Terminal Services	Available
Bluetooth	Available
Wireless Network Support	Available
Windows Firewall	Available
Windows Security Center	Available
MSN Explorer	Not available
Outlook Express	Available
Administrative Tools	Available
SMS Advanced Client	Not available
Remote Desktop	Available
Remote Assistance	Available
.NET Framework 1.1	Not available
ASP.NET 1.1	Not available
Windows .NET Messenger	Not available
Code pages / Regional settings / Keyboard	Selection available
Disk Management Services	Available
Windows Installer Service	Available
Class Installer	Available
CoDevice Installer	Available
Windows Movie Maker	Not available
Media Player 9.0	Available
Windows Media Player Tour	Not available
DirectX	V9.0c
Accessories	Available
Help files for all components	Not available
Games	Not available
Number of fonts	120
Windows XP Tour	Not available



3.7 Design

3.7.1 External structure

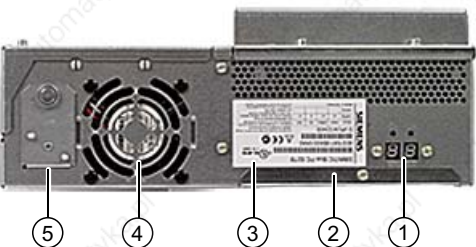
Front view		
	(1)	2 slots for expansion modules
	(2)	Cover for Compact Flash Card slot
	(3)	Front interfaces
	(4)	Power supply fan
	(5)	On / Off switch
	(6)	IEC connector for AC power supply or connection for 24 V DC power supply

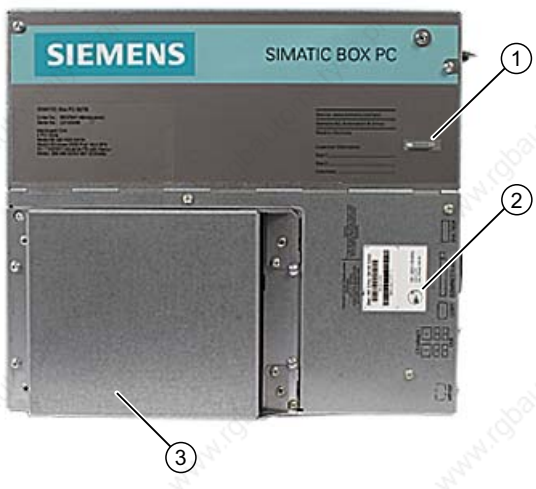
Rear view		
	(1)	Status display: Two part 7 segment display and two LEDs for POST code (optional)
	(2)	Steel cover plate for the operator panel interfaces
	(3)	Rating label with serial number
	(4)	Device fan
	(5)	Battery compartment

Side view (drive side)		
	(1)	Mounting for WinAC backup battery (please use the supplied battery mount without cover for WinAC module)
	(2)	Input data of the power supply
	(3)	Drive bay module for hard disks and DVD burner

Bottom		
	(1)	Connection for equipotential bonding 

3.7.2 Operator Controls

On / Off switch

On / Off switch	Description
 The image shows the rear panel of a SIMATIC Box PC 627B. A red circle highlights the On/Off switch, which is a small, rectangular, black component located below the network ports and above the cooling fan. Other visible components include a USB port, a COM1 port, a COM2 port, a compact flash slot, and a DVI/VGA port.	<p>The On / Off switch does not disconnect the device from mains. When the switch is in 0 position (Off), the device is still supplied with mains voltage in order to generate the internal auxiliary voltage for the power supply.</p>

! WARNING

The On/Off switch does not disconnect the device from the supply system.

NOTICE

Close the operating system before shutting down the device with the on/off switch, otherwise data may be lost.

3.7.3 Connection elements

Interfaces

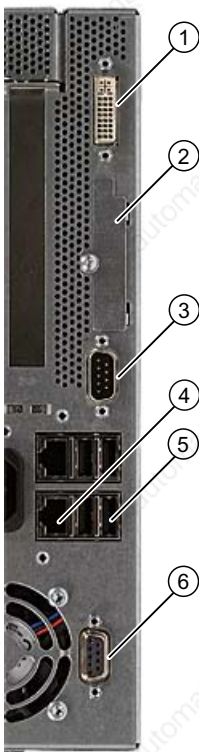
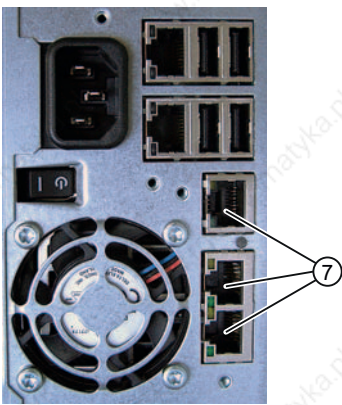
Arrangement of the ports on the front of the device			
	Pos	Description	Description
	(1)	DVI/VGA	DVI/VGA connection for CRT or LCD monitor with DVI interface, VGA via DVI/VGA adapter
	(2)	Compact Flash card	Slot for Compact Flash card
	(3)	COM	Serial V.24 port
	(4)	ETHERNET	2x RJ 45 Ethernet connection for 10/100/1000 Mbps
	(5)	USB 2.0	4 ports for USB devices (only 2 ports can be simultaneously used as high current)
	(6)	PROFIBUS/MPI	MPI interface (RS485, electrically isolated), optional 9-pin D-sub socket (optional product model)
	(7)	PROFINET	CP 1616 onboard interface, three RJ45 sockets (optional product models)

The interfaces available on the device can be uniquely identified based on their numbering. This numbering may deviate, however, from the numbering performed by the operating system.

Interfaces for connecting operator panels / displays

Arrangement of the ports	
	(1) Retaining screw for the steel cover plate that covers the interfaces described below.
	(2) I/O interface for connecting front panel components
	(3) USB 2.0 for front
	(4) LVDS display interface for TFT displays up to 1024 x 768 pixels
	(5) Access to 2nd LVDS display interface for TFT displays up to 1280 x 1024

AC power supply

Position of the IEC power connector	Description
	IEC power connector to AC power supply of the device. The maximum permitted power range is 100 V AC to 240 V AC.

DC power supply

Position of the DC power connector	Description						
 The image shows the rear panel of a SIMATIC Box PC 627B. A DC power connector is located on the left side of the panel. Three callout lines with circles containing the numbers 1, 2, and 3 point to the positive terminal, the negative terminal, and the ground terminal, respectively. To the right of the power connector are two RJ45 ports and a power switch. Below the power connector is a large cooling fan.	<p>Plug connector for DC power supply of the device</p> <table border="1"><tbody><tr><td data-bbox="804 443 895 479">(1)</td><td data-bbox="895 443 1481 479">+ (24 V DC)</td></tr><tr><td data-bbox="804 479 895 515">(2)</td><td data-bbox="895 479 1481 515">- (ground)</td></tr><tr><td data-bbox="804 515 895 551">(3)</td><td data-bbox="895 515 1481 551">PE (ground terminal)</td></tr></tbody></table>	(1)	+ (24 V DC)	(2)	- (ground)	(3)	PE (ground terminal)
(1)	+ (24 V DC)						
(2)	- (ground)						
(3)	PE (ground terminal)						

3.7.4 Status displays

PROFINET status display

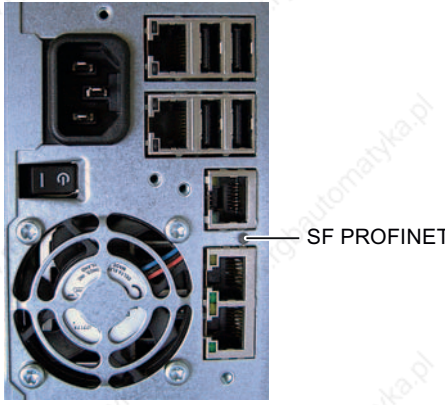
PROFINET status display			
			
Display	Meaning	LED	Description
SF PROFINET (optional)	Status display for CP 1616 onboard	OFF	<ul style="list-style-type: none"> CP not available CP disabled No error, communication established Download in progress
		Slow flashing	<ul style="list-style-type: none"> Link status error IO controller: IO device cannot be addressed IO controller: Duplicate IP address
		Fast flashing	Exception error: Diagnostics via Web or SNMP no longer possible
		AN	<ul style="list-style-type: none"> Diagnostic information available No communication established.

Virtual status displays			
The two "virtual" CP 1616 LEDs can only be seen in the SIMATIC software and can be scanned via SNMP.			
PROFINET	Virtual LEDs	RUN	CP is active
		STOP	CP is in the stop state
		Flashes	There are no "slow flashing" or "fast flashing" states.

Status display

The status display consists of two 7-segment displays with two dual-color LEDs.

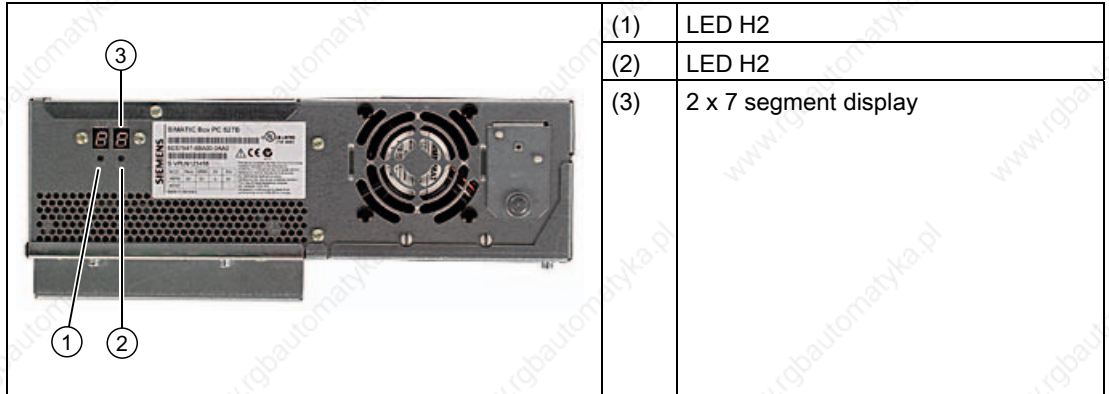

	7 segment display	LED H1	LED H2
Power On (= status display test)	88h	Orange	Orange
BIOS self-test	xxh (see BIOS post code)	Off	Off
BIOS self-test completed	00h	Off	Off
Operating system running or controlled by application	00h	Off	Off
Operating system shutting down	88h	Off	Off

Application planning

4.1 Transport

Despite the device's rugged design, its internal components are sensitive to severe vibrations or shock. You must therefore protect the PC from severe mechanical stress when transporting it.

You should always use the **original packaging** for shipping and transporting the device.

CAUTION

Risk of damage to the device!

When transporting the PC in cold weather, it may be submitted to extreme variations in temperature. In this situation, ensure that no moisture (condensation) develops on or inside the device.

If condensation has developed on the device wait at least 12 hours before you switch it on.

4.2 Unpacking and checking the delivery unit

Unpacking the device

Note the following points when you unpack the unit

- It is advisable not to dispose of the original packing material. Keep it in case you have to transport the unit again.
- Please keep the documentation in a safe place. It is required for initial commissioning and is part of the device.
- Check the delivery unit for any visible transport damage.
- Verify that the shipment contains the complete unit and your separately ordered accessories. Please inform your local dealer of any disagreements or transport damage.

4.3 Device identification data

4.3 Device identification data

The device can be clearly identified with the help of this identification data in case of repairs or theft.

Enter the following data in the table below:

- Serial number: The serial number (S VP...) is found on the rating plate.

Rating plate

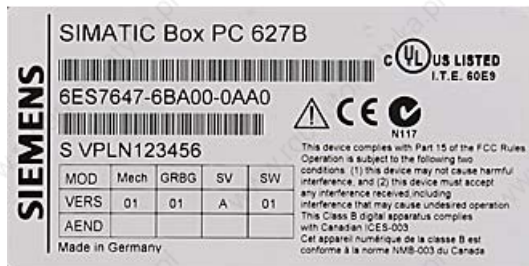

- Order number of the device
- Ethernet addresses: The Ethernet addresses of the device can be viewed in the BIOS Setup (F2) under "Main > Hardware Options > Ethernet Address".
- Microsoft Windows "Product Key" on the "Certificate of Authenticity" (COA). The COA label is bonded to the device. The Product Key is always required to reinstall the operating system.

COA label



Serial number:	S VP ...
Order No.	6ES ...
Microsoft Windows Product Key	
Ethernet address 1	
Ethernet address 2	
CP 1616 onboard layer 2	

4.4 Ambient and environmental conditions

When you plan your project, you should make allowances for:

- The climatic and mechanical environmental conditions specified in the specifications given in your operating manual.
- At least 100 mm space should be left free around the ventilation slots, in order that the PC receives sufficient ventilation.
- Do not cover the vent slots of the device.
- The device together with its AC power supply fulfils the requirements for fire protected enclosures according to EN 60950-1. Therefore it can be installed without any additional fire protective covering.
- The device with DC power supply does not fulfill the requirements according to EN 60950-1 in the power supply unit area. The device must therefore be installed in such a way as is part of an operating area with restricted access (e.g. a locked switchgear cabinet, control panel or server room).
- Always observe the mounting positions permitted for this device.
- The connected or built-in peripherals should not introduce negative field voltage in excess of 0.5 V into the device.

 WARNING
Failure to adhere to these conditions when mounting the system voids the approvals based on UL 60950-1, UL 508 and EN 60950-1!

4.5 Permitted mounting positions

PC mounting positions according to UL60950-1/UL508/EN60950-1/CSA22.2 No. 60950-1

An inclination of $\pm 20^\circ$ is permitted for all approved mounting positions.

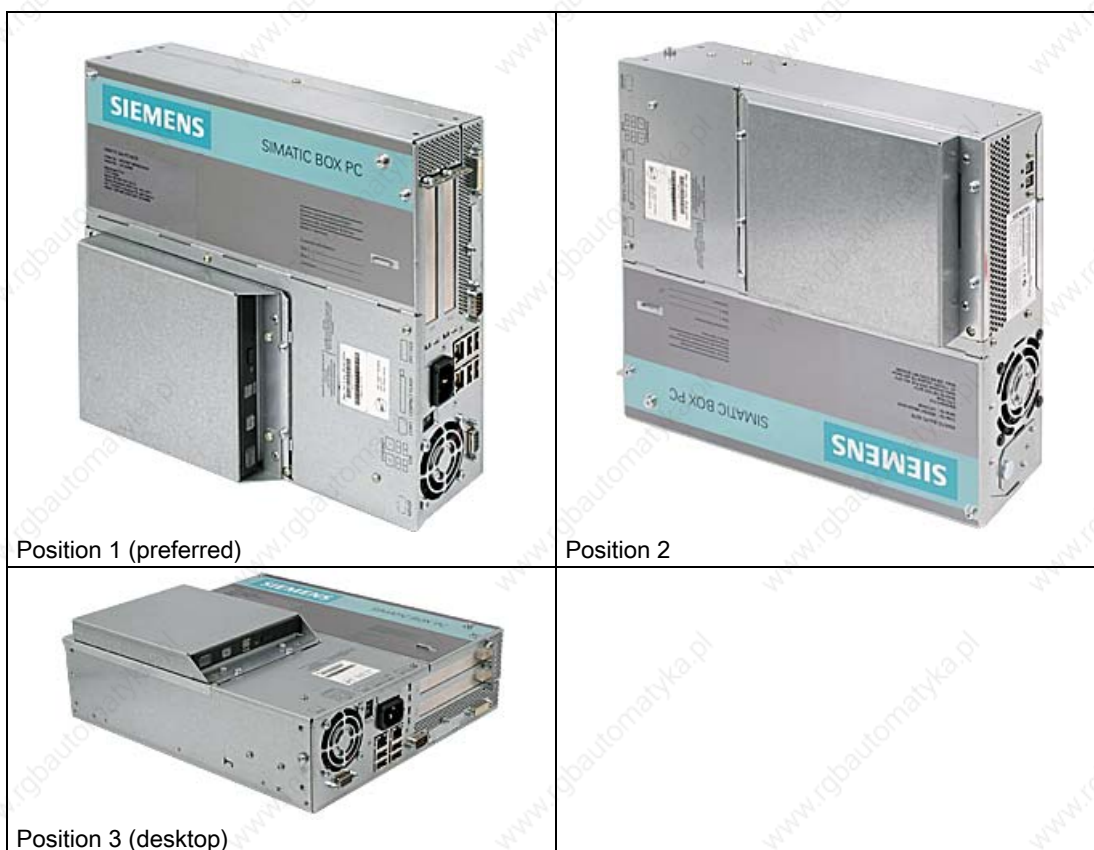

Additional PC mounting positions according to UL508/CSA 22.2 No. 142

An inclination of $\pm 15^\circ$ is allowed in this mounting position.

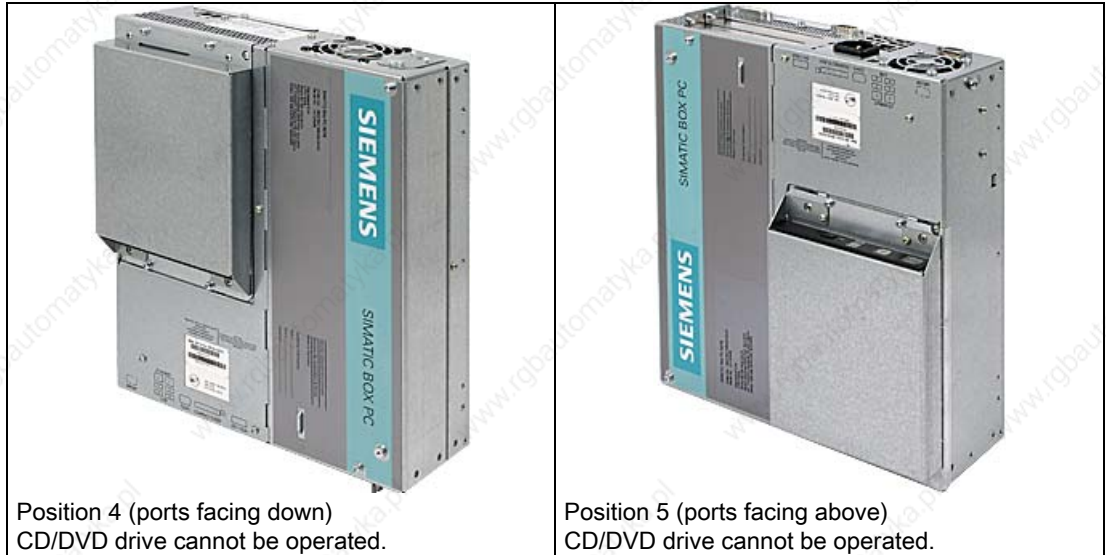

Note

CD/DVD and floppy drives cannot be operated in this position. The CD drawer opens upward or downward which can lead to mechanical damages in the drawer mechanism.

NOTICE

When using the device in the area of Industrial Control Equipment (UL 508), ensure that it is classified as "Open Type". A mandatory requirement for approval or operation according to UL 508 is therefore installation of the device in an enclosure certified for UL 508.

NOTICE

Mounting positions 4 and 5 are also permitted for the Information Technology Equipment area when the device is mounted in an enclosure that fulfills the requirements stipulated by sections 4.6 and 4.7.3 of IEC/UL/EN/DIN EN 60950-1.

Mounting

5.1 Installing the device

The device is particularly suitable for installation in consoles, switch cabinets and switchboards.

 **WARNING**

Function test while installing the device in machines or execute systems

Following the results of a risk analysis, additional protection equipment on the machine or the system is necessary to avoid endangering persons. With this, especially the programming, configuration and wiring of the inserted I/O modules have to be executed, in accordance with the necessary risk analysis identified safety performance (SIL, PL or Cat.). The intended use of the device has to be secured.

The correct use of the device has to be verified with a function test on the system. This test can detect programming, configuration and wiring errors. The test results have to be documented and if necessary inserted into the relevant inputs.

5.2 Installation of the device with mounting brackets

Screw-mounting the brackets

Two angle brackets are included in the product package. You can attach these to the PC enclosure using six M3 x 6 mm screws.

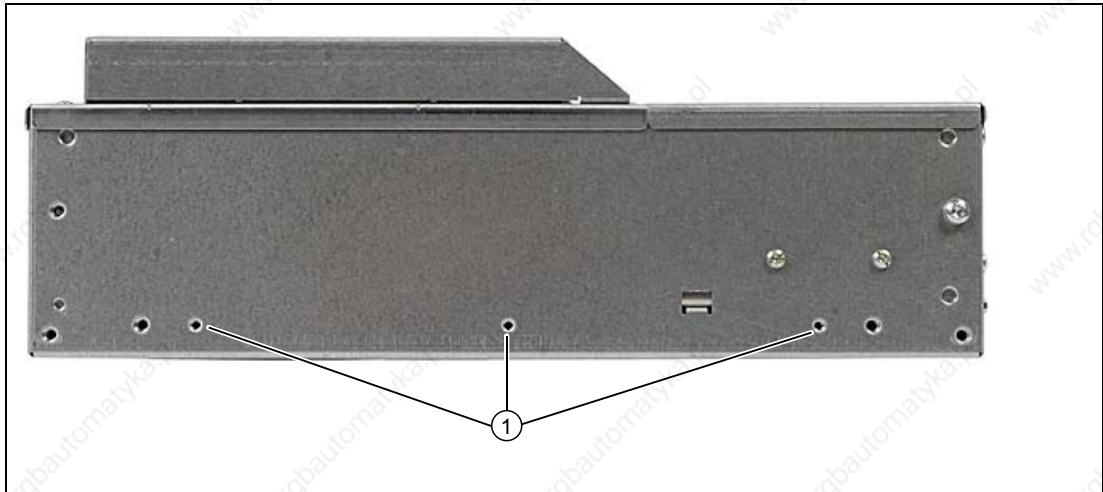

(1) Mount the brackets onto the device using the included M3 x 5 mm screws with a max. insertion depth of 5 mm (included in package).

Instructions for wall mounting

Mounting examples		
Material	Hole diameter	Mounting
Concrete	8 mm diameter, 60 mm depth	Dowel: 8 mm, 50 mm screws 4 mm, 50 mm
Plasterboard (min. 13 mm thick)	14 mm diameter	Tilting dowel diameter 4 mm min. length 50 mm
Metal (min. 2 mm thick)	5 mm diameter	Metal screws diameter 4 mm min. length 15 mm

! WARNING
Ensure that the wall is capable of carrying at least four times the total weight of the device (including the brackets and expansion modules). The total weight is approx. 7 kg.

5.3 Installation of the device with the vertical mounting kit

With the available optional vertical mounting kit you have the possibility to implement a place saving installation.

Mounting the vertical mounting plate onto the device

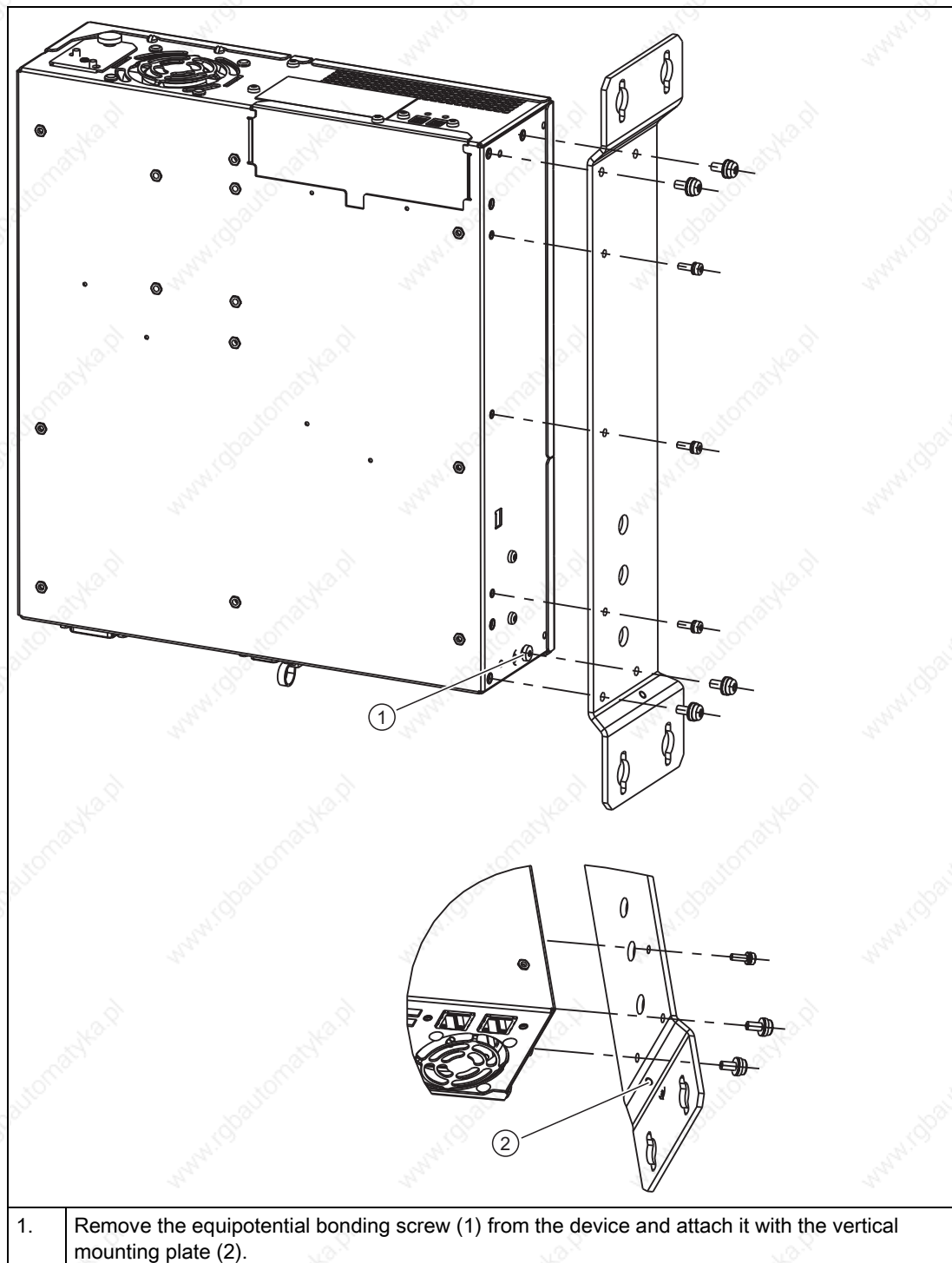

Mounting

5.3 Installation of the device with the vertical mounting kit

- | | |
|----|--|
| 2. | Attach the vertical mounting plate with four M4 screws and three M3 screws to the device |
|----|--|

Note

Following instructions in the "Permitted mounting positions" section.

Connecting

6.1 Connecting peripherals

Note before connecting

NOTICE

Connect only peripheral devices approved for industrial applications to EN 61000-6-2:2005.
--

Note

Hot-plug peripheral devices (USB) may be connected while the PC is in operation.
--

CAUTION

Peripheral devices that are incapable of hot-plugging may only be connected after the device has been disconnected from the power supply.

CAUTION

Strictly adhere to the specifications in the manuals for the peripheral devices.
--

NOTICE

The connected or built-in peripherals should not introduce a negative field voltage into the device.
--

A negative field voltage greater than 0.5 V to ground on the + 3.3 VDC / + 5 VDC / + 12 VDC power rail due to a connected or integrated component can prevent normal operation or even destroy the computer.
--

When measuring the negative field voltage, remember the following:
--

- | |
|--|
| <ul style="list-style-type: none">• The computer must be switched off and the power cable should be plugged in.• During the measurement, all cables from the plant to the computer should be connected.• All other components in the plant must be active. |
|--|

6.2 Connecting the 120 V / 230 V Ac power supply

Note before connecting the device

Note

The varying voltage power supply module is designed for operation on 120/230/240 V AC networks. The setting of the voltage range takes place automatically.

 **WARNING**

Do not connect or disconnect power and data cables during thunderstorms.

 **WARNING**

The device is designed for operation on grounded power supply networks (TN networks to VDE 0100, Part 300, or IEC 60364-3).

Operation on ungrounded or impedance-grounded power networks (IT networks) is prohibited.

 **WARNING**

The permitted nominal voltage of the device must conform with local mains voltage.

CAUTION

The mains connector must be disconnected to fully isolate the device from mains. Ensure easy access to this area.

A master mains disconnect switch must be installed if the device is mounted in a switch cabinet.

Always ensure free and easy access to the power inlet on the device or that the safety power outlet of the building installation is freely accessible and located close to the device.

Note

The power supply contains an active PFC (Power Factor Correction) circuit to conform to the EMC guidelines.

Uninterruptible AC power systems (UPS) must supply a sinusoidal output voltage in the normal and buffered mode when used with SIMATIC PCs with an active PFC.

UPS characteristics are described and classified in the standards EN 50091-3 and IEC 62040-3. Devices with sinusoidal output voltage in the normal and buffered mode are identified with the classification "VFI-SS-...." or "VI-SS-....".

Localized information

For countries other than the USA and Canada:

230 V supply voltage

This device is equipped with a safety-tested power cable which may only be connected to a grounding outlet. If you choose not to use this cable, you must use a flexible cable of the following type: Min 18 AWG conductor cross-section and 15-A / 250-V shockproof connector. The cable set must be compliant with the safety regulations and stipulated IDs of the country where the system is to be installed.

For the USA and Canada:

For the United States and Canada, a CSA or UL-listed power cord must be used.

The connector must be compliant with NEMA 5-15.

120 V AC power supply

To be used is a flexible power cord approved to UL and with CSA label, and which has the following features: Type SJT with three leads, min. 18 AWG conductor cross-section, max. 4.5 m in length and parallel ground contact connector 15 A, min. 125 V.

240 VAC power supply

Use a flexible power cord which is approved to UL and CSA, and which has the following features: Type SJT with three conductors, min. 18 AWG conductor cross-section, max. length 4.5 m, and tandem grounded connector 15 A, min. 250 V.

Connecting

How to connect the device to the 120 V AC / 230 V AC power supply	
1	Ensure that the ON/OFF switch is in "0" position (Off) when you plug in the power cord in order to avoid unintentional startup of the device.
2	Connect the IEC connector
3	Connecting the power cord to the power socket
4	Fasten the cable with the supplied power plug latch, if necessary.



6.3 Connecting the (24 V) DC power supply

Note before connecting the device

WARNING

Only connect the device to 24 V DC power supply systems which meet the requirements of a safe extra-low voltage (SELV); in addition, a protective conductor must be connected. The conductors must withstand the short-circuit current of the 24 V DC power source, so that a short-circuit will not damage the cable. Only connect cables with a minimum cross-section of 1.3 mm² (AWG16) and a maximum cross-section of 3.3 mm² (AWG12).

NOTICE

The 24 V DC power source must be adapted to the input data of the device (see specifications).

Connecting

Steps for connecting the device to the 24 V DC power supply	
1	Ensure that the ON/OFF switch is in the '0' (OFF) position to prevent unintentional startup of the device when connecting it to the 24 V power supply.
2	Switch off the 24 V DC power source.
3	Insert the DC power plug. (1) 24 V DC (2) ground (3) protective conductor



6.4 Connecting equipotential bonding

The equipotential bonding terminal (M4 thread) on the device (large surface, large-area contact) must be connected to the PE conductor on the cabinet or system in which the device is to be installed. The minimum cross-section is 5 mm².

The PE terminal is needed to protect the device and ensures that interference signals generated by external power cables, signal cables or cables to the I/O modules are safely discharged to earth.

Connecting equipotential bonding

Connect the equipotential bonding terminal on the device (large surface, large-area contact) to the central grounding busbar of the cabinet in which the device is installed. The minimum cross-section is 5 mm².



6.5 Connecting Ethernet strain relief

The Ethernet strain relief provided in the package is used to prevent accidental removal of the Ethernet cable with Industrial Ethernet FastConnect connector from the device. Two cable ties (not included in the package) are needed to use this accessory.

To fix the Ethernet strain relief with Industrial Ethernet FastConnect connector, you will need a TORX T10 screwdriver.

Steps for connecting the Ethernet strain relief	
1	Fasten the Ethernet strain relief (2) to the device enclosure with two oval-head screws (M4 thread).
2	Connect network cable and attach to the strain relief using cable ties (1) / (3)



Commissioning

7.1 Requirements for commissioning

- Connect the peripherals, such as the keyboard, mouse, monitor and the power supply, before putting the device into operation.
- The operating system of your device is preinstalled on the hard disk.

CAUTION

Risk of damage to the device!

Make sufficient allowances for the device to acquire room temperature before you put it into use. If condensation has developed on the device wait at least 12 hours before you switch it on.

7.2 Basic commissioning - initial startup

The PC operating system is automatically set up the **first** time you switch on the device.

Procedure:

1. Set the ON / Off switch to I position (On). The PC performs a POST. During the self-test, this message appears:

Press <F2> to enter SETUP or <ESC> to show the Boot menu

2. Wait until this message is cleared, then follow the instructions on the screen.
3. Type in the Product Key as required. You find this key on the "Certificate of Authentication", in the "Product Key" line.

NOTICE

The PC may not be switched off when you run setup.

Do **not** change the default BIOS settings, otherwise the operating system setup may become corrupted.

4. Automatic restart

After you have entered all necessary information and after the operating system setup is completed, the PC is automatically restarted and displays the user interface of the relevant operating system.

When you switch on the PC now, the user interface of the operating system or logon dialog of the operating system (with Windows XP Embedded) is automatically opened when the startup routine is completed.

7.3 Windows XP, Vista Security Center

Warning from the Windows Security Center

A warning from the Windows Security Center appears the first time you switch on your device. The Security Center checks the status of the device in regard to the three important security aspects listed below. If a problem is detected (an outdated antivirus program, for example), the Security Center issues a warning and makes recommendations on how you can better protect the device.

- **Firewall:** The Windows Firewall adds protection to the device by blocking network or Internet access to the device by unauthorized users. Windows checks if the device is protected by a software firewall.
The firewall is enabled in the factory state.
- **Antivirus software:** Antivirus programs add protection to the device by searching for and eliminating viruses and other security threats. Windows checks if a full-range, up-to-date antivirus program is running on the device.
No antivirus software is installed in the factory state.
- **Automatic updates:** Using the Automatic Update feature allows Windows to regularly search for the latest critical updates for the device and to install them automatically. This feature is disabled in the factory state.
- **Realtime protection (Vista only):** Windows Defender displays warnings if spyware or possibly unwanted software is installed or executed on the computer. You will also receive a warning if programs attempt to modify important Windows settings.

Configure the Security Center according to your requirements.

7.4 Switching off the device

Switch off the device

NOTICE
Close the operating system before shutting down the device with the on/off switch, otherwise data may be lost.

Set the ON / Off switch to 0 position (off.) Disconnect the mains connector to isolate the device from mains.

7.5 Notes on operation

7.5.1 DVD burner

The DVD burner drive is an optional feature. Recording methods supported by the disk drive: Disc-at-once, Track-at-once, Session-at-once, Packet writing. You can write to CD-R, CD-RW, DVD+R, DVD-R, DVD-RW, DVD+RW, DVD-RAM and dual-layer media.

Burner software

In order to utilize full functionality of the DVD burner, you need to install additional software (burning software). This software is included on the CD supplied with the device. Insert the CD in the drive, run setup and follow the instructions on the screen.

NOTICE

When first starting the burner software, no data carriers should be inserted in the drive. This is because data carriers with errors can interrupt the automatic hard drive recognition. This makes it impossible to correctly display the possible burner functions.

Notes on burning optical data carriers

CAUTION

Danger of data errors when burning data carriers!

Burning is permissible only in an undisturbed environment, i.e. shock and vibration stress must be avoided. Because of heavy fluctuation in the quality of CD-Rs, data may be corrupted in a burning session, even if no error message is initially displayed. The written data can only be verified by comparing these with the source. To be on the safe side, data should be verified after every burning session. When backing up an image, the data should be restored to the hard disk and the system should be rebooted from the hard disk.

7.5.2 2HDD system (optional)

The two hard disks are configured as follows in the factory state of the device:

Hard disk 0	Hard disk 1
Partition C: System, NTFS, 20 GB	Not configured
Partition D: Data, NTFS, remaining capacity	

The two hard disks are connected to the SATA ports 0 and 2. The hard disk on SATA port 2 is not configured. This gives you the option of backing up your data to this hard disk. For information on hard disk capacities, refer to your order documentation.

Booting from the slave hard disk

The system boots by default from the hard disk on SATA port 0. You can also configure the system to boot from the disk on SATA port 2.

In order to allow booting from the second hard disk, you need to configure it as the primary boot device. Make the following settings in your BIOS Setup:

Select Boot > Hard Drive > <Drive name> e.g. FUJITSU MHT2060BH - SATA2, then press the "+" key to move it up in the boot order.

NOTICE
The drive letters for the partitions on both drives are assigned by the operating system used. You can change these in the Control Panel as required.

7.5.3 RAID1 system (optional)

This is a RAID1 system configuration (mirroring with two hard disks). This configuration enhances system availability as the system is able to continue operation if a hard drive fails, or if there is a cable problem at a channel.

The two hard disks are configured as follows in the factory state of the device:

RAID1 system
Partition C: System, NTFS, 20 GB
Partition D: Data, NTFS, remaining capacity

Note

You can find information regarding Intel RAID controllers in the RAID documentation on the included "Documentation and Drivers" CD in the Drivers\RAID\Intel directory.

```
Intel(R) Matrix Storage Manager option ROM v5.6.2.1002 ICH7R wRAID5
Copyright(C) 2003-06 Intel Corporation. All Rights Reserved.

RAID Volumes:
ID Name Level Strip Size Status Bootable
0 Volume0 RAID1(Mirror) N/A 149.1GB Normal Yes

Physical Disks:
Port Drive Model Serial # Size Type/Status (Vol ID)
0 ST3160815AS 5RA01YJT 149.1GB Member Disk(0)
2 ST3160815AS 5RA01YHY 149.1GB Member Disk(0)

Press <CTRL-I> to enter Configuration Utility...
```

Figure 7-1 Example

RAID system management functions

The pre-installed RAID system software offers enhanced functionality for RAID system operation and management. Start the SW by selecting the "Start > Programs > Intel Matrix Storage Manager" command.

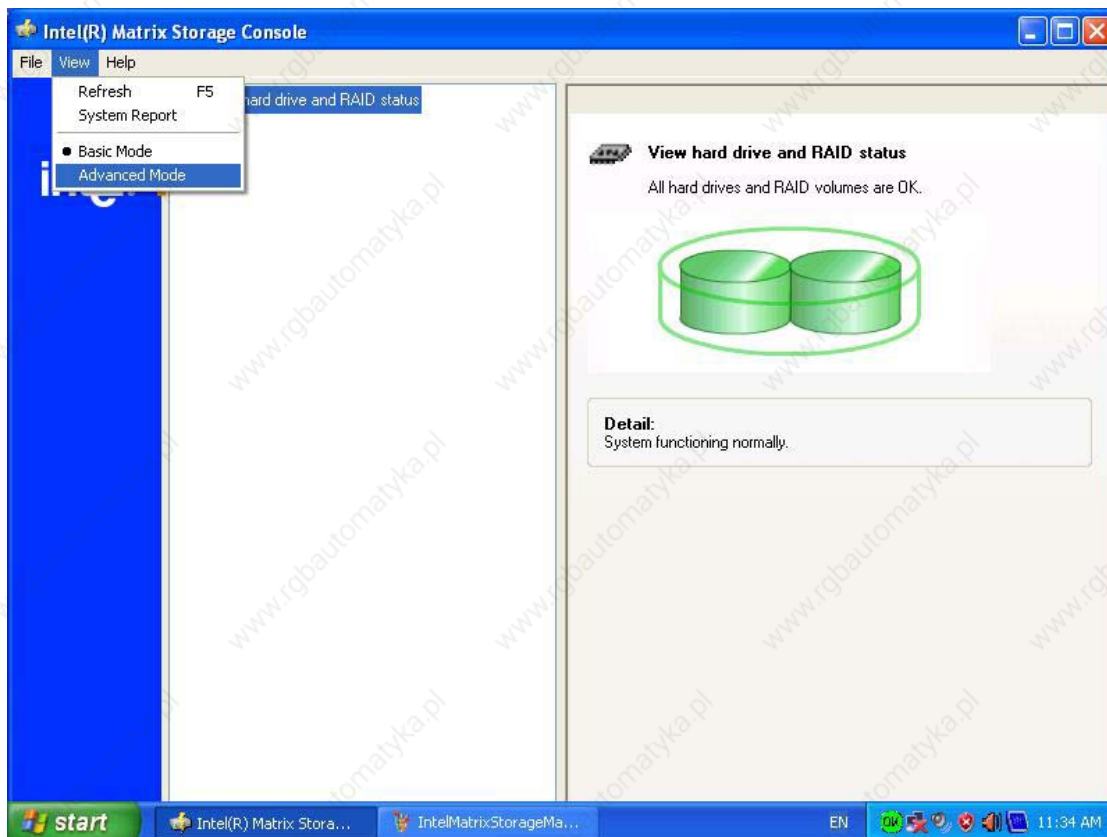

Figure 7-2 Example

The "View -> Advanced Mode" command returns details of the RAID volumes.

The command "View -> System Report" can be used to create a report with details of the RAID volumes.

NOTICE

The RAID status entries are returned by default in the Windows event view and in the log file of the program.

A hard drive can be synchronized at operating system level if a fault is detected. It may take up to several hours to synchronize a new disk in the background, depending on the size of the hard disk and on the system load.

The redundant system state RAID 1 is reached again only after synchronization is completed.

Comments about faults

NOTICE

Input delay

System load may briefly increase due to synchronization when a hard disk has failed, depending on processor load and current hard disk activity.

In extreme cases, input from the keyboard and touch screen may be delayed for a brief period.

7.5.4 Compact Flash card (optional)

NOTICE

We highly recommend that use approved SIMATIC Compact Flash cards. Siemens disclaims any liability for impairment of functions caused by the use of third-party cards.
--

Setup

A Compact Flash card can be used on-board and in an extra mount. This mount replaces the otherwise usual hard disk mount and uses the same connector as the optical drive.

Features

The Flash drive with Compact Flash card reacts identically as a standard IDE hard disk preset as a master. No special driver software is required to operate the Flash drive.

Although the Flash drive reacts like a hard disk superficially, there are restrictions due to the limited number of write cycles on Flash memory. The service life of a Compact Flash card depends on the number of write access to the medium - read accesses have no effect.

To maximize the service life of Compact Flash cards, take care that the writing to the cards is kept to a minimum.

For example, you can do this by ensuring that:

- Swap files of the operating system and application are not located on the Compact Flash card.
- Cyclic writing is avoided.

Operating systems such as MS-DOS and Windows XP Embedded allow this, for example. The Enhanced Write Filter (EWF) can be used with XP Embedded, for example. This minimized the number of write accesses to the Flash drive or avoids it entirely.

Flash drive functions

A Flash drive or a Compact Flash card consists of Flash memory chips.

An intelligent controller integrated in the Flash drive manages the Flash memory. This optimizes the use of the Flash memory to achieve a maximum service life.

The service life of a Flash drive depends in part on the following factors:

- Type of file
Executable files (*.EXE) are usually only written once and stays at the same storage location.
- The number of writes within a given time (the less the better)

Comparison of Flash drive and hard disk drive service life

Examples of the service life for a Flash drive:

With a "Data logger function", a 4 KB file is written to a 1 GB Compact Flash card every 5 seconds. The cluster size is 4 KB in this case. Due to the file segmentation, the file is always written to another location on the Compact Flash card.

With this example, the Compact Flash card has a theoretical service of 79.3 years.

Example of the service life for a hard disk drive

The service life of a hard disk drive depends on the following factors:

- Temperature (operating & storage / transport)
- Shock (operating & storage / transport)
- Vibration (operating & storage / transport)
- Humidity (operating & storage / transport)
- Voltage supply
- Power on hours (POH)
- Duty cycle (% workload, i.e. write/read/positioning)

The service life for a hard disk is between 2,5 and 5 years, depending on the factors listed above.

Booting from the Flash drive

A operating system must be installed before you can boot from the Flash drive. You can read about the procedure required for installation of an operating system in the section "Installing an operating system".

Integration

8.1 Integration into an automation system

The following options are available for the integration in existing or planned system environments or networks:

Ethernet

Wake on LAN and Remote Boot are supported.

The integrated Ethernet port (10/100/1000 Mbps) can also be used for communication and for data exchange with automation devices such as SIMATIC S7. You will need the "SOFTNET S7" software package for this.

PROFIBUS/MPI

The optional electrically isolated PROFIBUS interface (12 Mbps) can be used to interconnect distributed field devices or for coupling to SIMATIC S7.

The "SOFTNET for PROFIBUS" software package is required for coupling to S7 automation systems.

PROFINET

The CP 1616 onboard allows the connection of industrial PCs to Industrial Ethernet. Only one CP 1616 can be installed in a PG/PC. You can find detailed information in the next section or in the section "Detailed Description > CP 1616 onboard".

Device driver CP 16xx.sys

The device driver allow integration of the Windows network protocol in the optional "CP 1616 onboard" Ethernet PROFINET controller on SIMATIC PCs. The PROFINET interface will act like a regular 100 Mbit Ethernet interface with a MAC address when you use this driver. The three RJ45 sockets are connected with each other via switch.

The driver and documentation are available on the supplied Documentation and Drivers CD.

PROFINET IO application

You can create, operate and configure PROFINET IO applications using the "Development Kit DK-16xx PN IO. It must be installed in addition to the CP 16xx.sys device driver. This kit and the documentation are available free of charge at the following Internet address:
http://www.automation.siemens.com/net/html_00/produkte/040_cp_1616_devlopkit.htm

SIMATIC NET

You can create, operate and configure SIMATIC installations using this software package. You will find information on this on the SIMATIC NET Manual Collection CD. This software package and the documentation are not part of the product package.

Additional information

For further information, refer to the catalog and to the online ordering system of Siemens A&D.

<http://www.mall.automation.siemens.com>

8.2 PROFINET

CP 1616 onboard

The basic characteristics of the PCS 1616 onboard are:

- Optimized for PROFINET IO
- With Ethernet realtime ASIC ERTEC 400
- Three RJ45 sockets for connecting terminal devices or addition network components
- Integrated 3-port real-time switch
- Automatic hardware detection

CAUTION

Only one CP 1616 can be installed in a PG/PC. If you want to use an additional CP 1616 module, the "CP 1616 onboard" option must be disabled in the BIOS Setup.

Additional documentation on PROFINET

Get an overview of the information available on the topic of PROFINET.

Document designation	What is contained in this document?
This documentation is not included in the product package:	
Getting Started PROFINET IO Getting Started: Manual Collection	The documents use concrete examples to provide step-by-step instructions on how to commission a fully functional application.
Manual PROFINET System Description	This gives you the basic knowledge about the PROFINET IO topics: Network components, data exchange and communication, PROFINET IO, component-based automation, application example of PROFINET IO and component-based automation.
Manual From PROFIBUS DP to PROFINET IO	Read this document if you want to convert an installed PROFIBUS system to a PROFINET system.
Readme file for CP 1616/CP 1604 and DK-16xx PN IO	This provides the latest information about the SIMATIC NET products CP 1616/CP 1604, CP 1616 onboard, the developer kit.
Configuration Manual Commissioning PC Stations	This provides you will all the information necessary for commissioning and configuring a PC as a PROFINET IO controller or IO device.
Manual SIMATIC NET Industrial Communication with PG/PC: Volume 1 - Basics SIMATIC NET Industrial Communication with PG/PC: Volume 2 - Interfaces	This manual introduces you to industrial communication and explains the available communication protocols. It also describes the OPC interface as an alternative to the IO-based user programming interface.
S7 CPs for Industrial Ethernet Configuring and Commissioning	This provides the following support: - For commissioning S7 stations - For establishing effective communication

Document designation	What is contained in this document?
Manual SIMATIC NET - Twisted Pair and Fiber-Optic Networks	Configure and build your Industrial Ethernet networks based on this document.
This documentation is part of the supplied Documentation and Drivers CD:	
Operating instructions CP 1616/CP 1604/CP 1616 onboard	This provides you with all information required for operation.
Installation guide Device Driver CP16xx.sys	Read this guide if you want to install the NDIS device driver, CP16xx.sys.

Further information

You can find the information on specific products in the Internet at the address:
<http://www.siemens.de/simatic-net>

Functions

9.1 Overview

Functions implemented:

- Temperature monitoring and over/under-temperature display
- Watchdog
- Fan monitoring

Messages of the monitoring modules can be transferred to applications.

The SOM software (Safecard On Motherboard) and DiagMonitor software on CD (optional) can be used to handle this functionality.

The DiagMonitor software CD contains the monitoring software, the software for the stations to be monitored, and a library for creating user-specific applications.

The descriptions of drivers and of the SOM program are available on the CD "Documentation and Drivers" under **Drivers & Updates\<device>\...**

9.2 Temperature monitoring

Temperature monitoring

The temperature is recorded by means of three thermocouples. One thermocouple monitors the processor temperature, another the temperature in the area near the power supply, and a third the air intake temperature next to the DVI port.

The following fault reactions are triggered if one of the temperature values exceeds the set temperature threshold:

Response	Option
Device and CPU fans accelerate to maximum speed.	None
SOM or DiagMonitor software is activated	None

The temperature error is retained in memory until temperatures have fallen below the thresholds and are reset by one of the following measures:

- Error acknowledgement in the SOM program (manually by means of the broom icon)
- Restart of the device

9.3 Watchdog (WD)

Function

The watchdog monitors program execution and reports a program crash to the user by means of various reactions.

The watchdog is idle when the PC is switched on or after a HW-RESET (cold restart), i.e., no reaction of the WD is triggered.

WD reactions

If the WD is not retriggered within the set time (by the driver or in the SOM program), the following reactions are triggered:

Response	Option
WD acknowledgement	None
Trigger a PC reset	Selectable
SOM or DiagMonitor software is activated	None

WD monitoring times (TWD)

The monitoring times can be set in increments of one second within a range from 3 to 255 seconds.

Note

The watchdog is retriggered if the monitoring time is changed at the active watchdog (that is while the watchdog is running)!

9.4 Fan monitoring

The function monitors operation of the enclosure and power supply fans. When a fan fails, the following reactions are triggered:

Response	Option
SOM or DiagMonitor software is activated	None

The temperature error is retained until the cause of the fan failure has been rectified and the error is reset in one of the following ways:

- Acknowledgement of the error message by means of the SOM program
- Restart of the device

9.5 Safecard on Motherboard (SOM)

Safecard on Motherboard (SOM)

This application is used to monitor PC hardware (temperature, watchdog and fans) and to display the current measured values. You can also configure the temperature and fan monitoring functions, and the watchdog function.

Your device is equipped with three temperature sensors, which are automatically detected by the application.

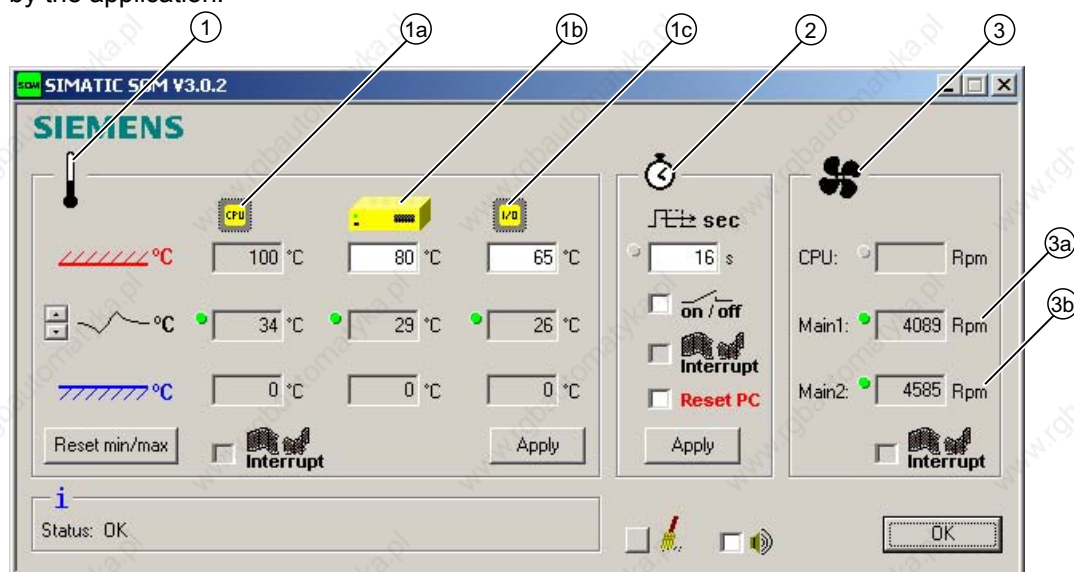

(1)	Temperature range	Here the current temperature and limit values are shown. You can toggle the temperature display mode to indicate either the current temperature, or the min./max. values measured since the start of the application.
		(1a) Internal processor temperature
		(1b) Device temperature beneath the power supply: upper threshold can be set from 40°C to 80°C
		(1c) Cooling air temperature surrounding the DVI connector: - depending on device 3°C to 5°C higher than the ambient temperature - upper threshold can be set from 25°C to 65°C
(2)	Watchdog range	Here, you can configure the watchdog function in your monitoring application. You can specify the watchdog time, activate a PC reset and activate / deactivate the watchdog.
(3)	Fan area	You can read the current fan speed in this area.
		(3a) Fan speed in the area close to the processor
		(3b) Fan speed on the power supply

The description of the SOM software and the drivers for Windows are available on the "Documentation and Drivers" DVD under "Drivers & Updates\<device>\...".

From the CD, run "Install.bat" and follow the instructions on your screen.

9.6 Status display

The status display consists of two 7-segment displays with two dual-color LEDs.

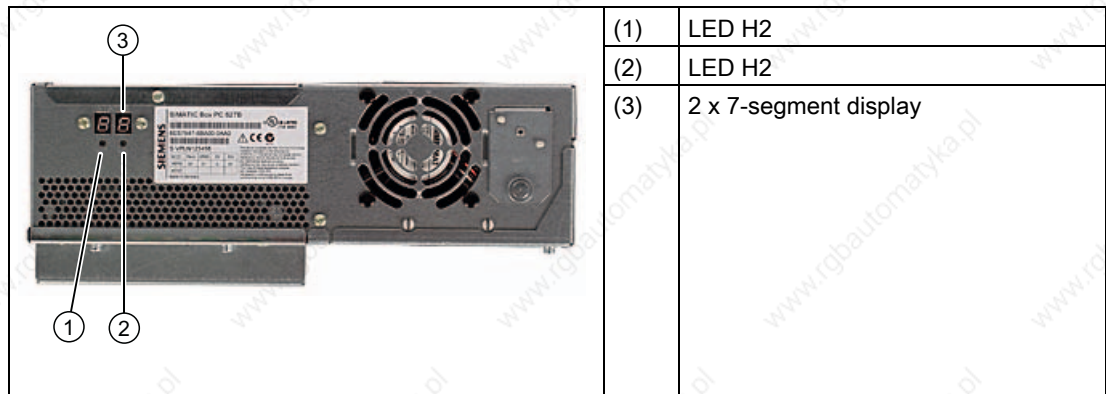

Function of the 7-segment displays

The POST codes of the respective test step are displayed during the startup of the BIOS. The POST code of the most recently started test step is displayed should an error occur. Code 00 is displayed when the startup is completed without error.

Application codes can also be displayed if required.

Function of the LED H1, H2

During the BIOS startup, the two LEDs light up in two colors (red and green) in order to test their operation. The two LEDs switch off when the startup is completed without errors.

Applications can trigger the two LEDs if required.

Note

You can find the documentation for the SIMATIC LED status monitor on the "Documentation & Drivers" DVD under Documentation > SIMATIC Box PC 627B.

9.7 SRAM buffer memory

In order for applications to store data following a power failure, the motherboard features battery-buffered SRAM. If the supply voltage fails longer than 5 ms, this is indicated with the DC-fail signal.

At least 10 ms is available to copy the data to the buffered RAM. During this time, 128 Kb can be saved with a full load and even more with a smaller configuration, in other words, a lesser load. A maximum 2 MB memory window is displayed via a PCI address register. The base address is initialized by the BIOS.

A corresponding function is implemented there for using the CMOS-RAM under WinAC RTX.

NOTICE
If replacement of the battery takes longer than 30 seconds, the data saved in the CMOS RAM and in the buffered SRAM is lost.

9.8 Battery monitoring

The installed buffer battery has a service life of at least 5 years. The status can be checked with two-tier battery monitoring. The information can be read from an I/O register and evaluated.

When the first warning level is reached, the remaining service life of the battery for buffering CMOS data and buffered SRAM is at least 1 month.

Expansions and programming

10.1 Opening the Device

CAUTION

Work on the open device may only be carried out by authorized and qualified personnel. Within the warranty time, you are only allowed to install expansions for memory and expansion card modules.

**CAUTION**

The device contains electronic components which may be destroyed by electrostatic charge.

You therefore need to take precautionary measures before you open the device. Refer to the ESD directives on handling components which are sensitive to electrostatic charge.

Tools

All mechanical installation tasks on the device can be carried out with Torx T6, T10 and T15 screwdrivers.

Preparation

Disconnect the device from the mains.

Disclaimer of liability

All technical data and approvals apply only to expansion units which are released by SIEMENS.

Siemens disclaims any liability for impairment of functions caused by the use of third-party devices or components.

Observe the installation instructions for the components. UL approval of the device only applies when the UL-approved components are used according to their "Conditions of Acceptability".

Open the device up

Steps for opening the device	
1 Loosen the screws (1).	
2 Swing the cover up and remove it.	

10.2 Memory expansion

10.2.1 Removing/Installing Memory Module

Memory expansion options

The motherboard is equipped with 2 slots for memory modules. For 184-pin DDR2 RAM chips, unbuffered, no ECC. This allows you to expand device memory up to 4 GB, of which you can use approx. 3.2 GB for the operating system and applications. You can install one or two modules.

Combination	Slot X1	Slot X2	Maximum expansion
1	256/512 MB / 1 GB / 2 GB		2 GB
2	256/512 MB / 1GB / 2 GB	256/512 MB / 1 GB / 2 GB	4 GB

Note

The modules can be installed in any slot.

Preparation

Disconnect the device from mains and unplug all cables.

CAUTION

The electronic components on the PCBs are highly sensitive to electrostatic discharge. Always take appropriate precautionary measures when handling these components. Refer to the ESD directives on handling electrostatic sensitive components.

NOTICE

We highly recommend using memory modules approved by Siemens. Siemens disclaims any liability for impairment of functions caused by the use of third-party memory modules.

Installing a memory module

How to install a memory module	
1	Open the device.
2	Note where the (polarized) cutout is on the pin side of the RAM chip before inserting it.
3	Insert the module downwards, applying slight pressure and press it until the locking snaps into place.
4	Close the device.

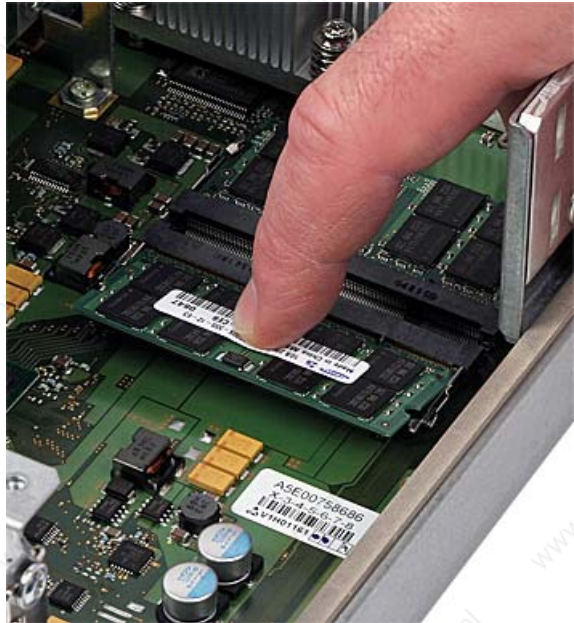

Removing a memory module

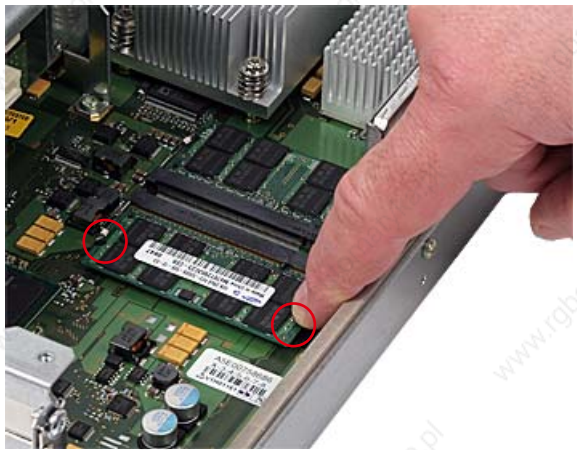
How to remove a memory module	
1	Open the device.
2	Release the locking mechanism on the left and right.
	
3	Pull the memory module out of the slot.
4	Close the device.

Display of the current memory configuration

A new memory module is automatically detected. The allocation of the "base memory and extended memory" is automatically displayed when you switch on the device.

10.3 Installing PCI / PCI Express cards

10.3.1 Notes on the modules

The device is designed for use with modules conforming to PCI specifications V 2.2. PCI modules with 5 V and 3.3 V supply voltage and PCI Express x4 modules can be used. The permissible module dimensions are specified in the "Dimensional drawings" section.

10.3.2 Installing / removing expansion modules

Preparation

Disconnect the device from the mains.

Installing expansion modules

How to install an expansion module (PCI / PCI express card):	
1	Open the device.
2	Remove the fastening screw (1) and remove the module bracket (2).
3	Remove the slot cover (5) from the intended slot.
4	Insert expansion module (4) into the slot provided. Observe the guide rail (6) with long PCI modules.
5	Mount the module bracket and insert the slider (3).
6	Screw down the steel slot cover (5) for the expansion module.
7	Close the device.

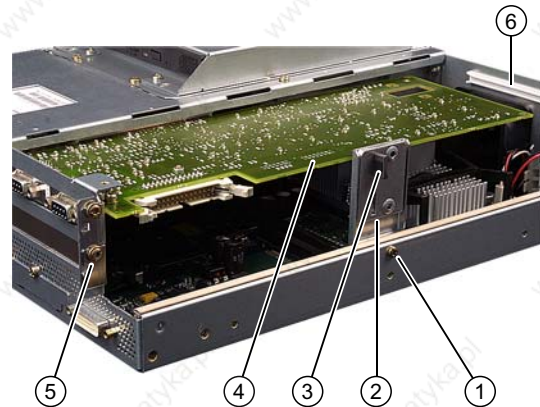

Inserting the slider

Proceed as follows when using the slider:

How to install a slider	
1	<p>Push the slider through the guide slot until it is seated firmly on the module. Insert the module into the slot.</p>

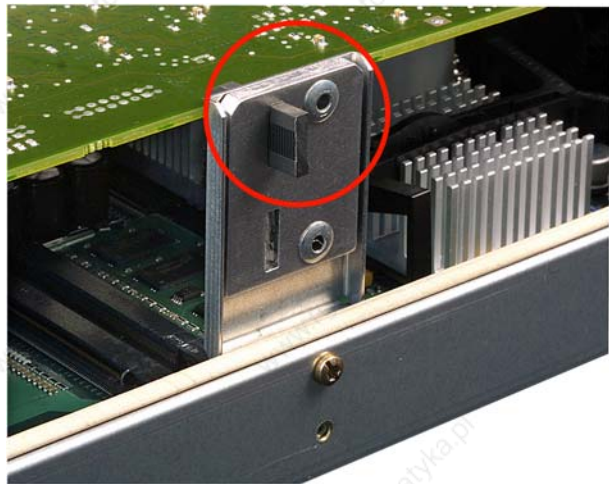

CAUTION

Do not put pressure on the module! Do not apply excessive force on the slider when you push it onto the module.

2	<p>Cut off the rest of the slider element: Use a knife to apply a cut on the slider at the upper edge of the bracket and then break this section off. Cut off the residual element using a side cutter.</p>
---	---

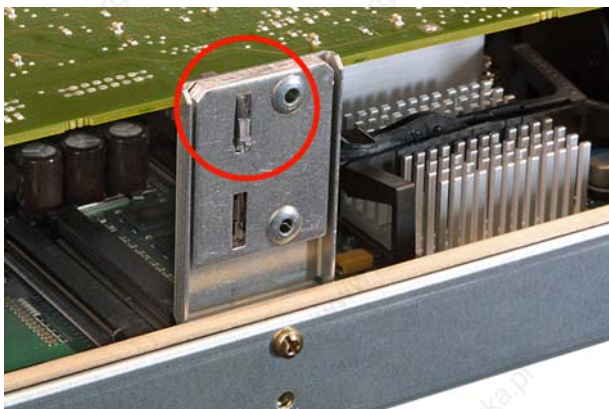

Notes on the allocation of resources

The two slots for the PCI cards each have an exclusive interrupt. Information on the assignment of PCI IRQs to the PCI slots is available in the "Advanced menu" or "Bus board" section.

10.4 Installing drives

10.4.1 Options of installing disk drives

Drive bay module for hard disk drives and optical drives

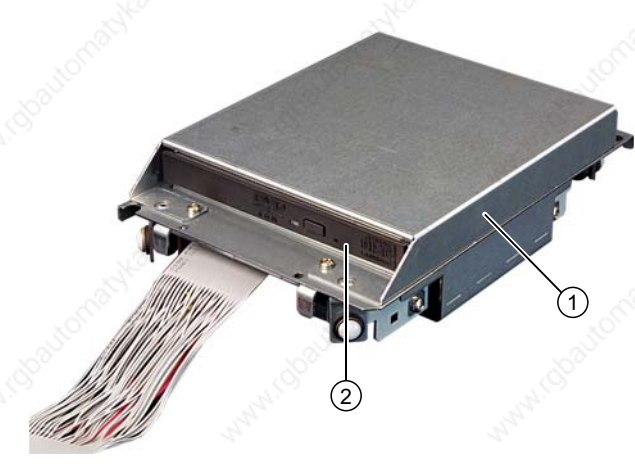
DVD burner drive bay mount	Item	Description
	(1)	DVD burner drive bay mount
	(2)	Slot for DVD burner drive

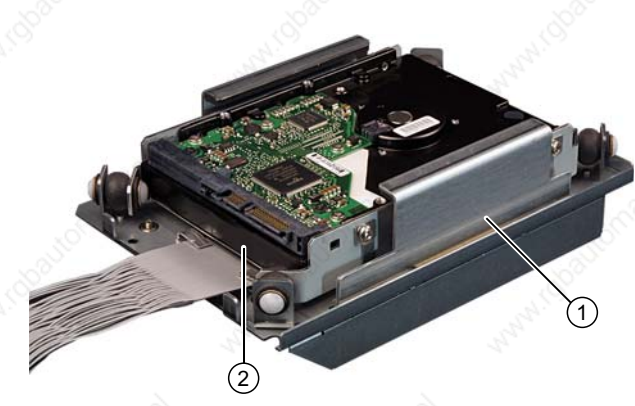
A 3.5" hard disk drive	Item	Description
	(1)	Hard disk drive bay for one 3.5" drive
	(2)	Slot for one 3.5" drive

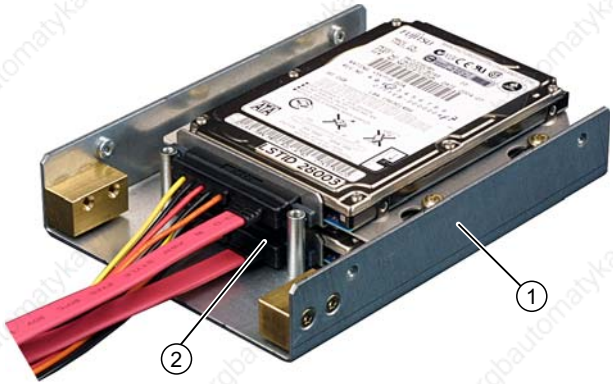

Two 2.5" hard disks	Item	Description
	(1)	Hard disk drive bay for 2.5" hard disks
	(2)	Two slots for 2.5" hard disks

10.4.2 Installing/removing a drive bay module

Preparations

Isolate the device from mains and disconnect all connection cables.

Removing a drive bay module for hard disks and optical drives

Steps for removing the drive bay	
1 Loosen the four screws (1).	
2 Lift out the drive bay module for hard disks and the optical drive.	

10.4.3 Removing / installing an optical drive

Preparations

Isolate the device from mains and disconnect all connection cables.

Required tools

You need a Torx 6 screwdriver to remove the the DVD burner.

Removing the DVD burner drive

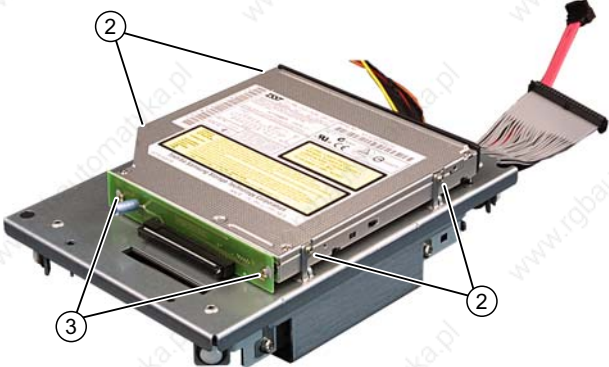
How to remove a DVD burner drive		
1	Remove the drive bay module.	
2	Loosen the screws (1) on the DVD burner drive bay.	
3	Loosen the screws (2) on the drive.	
4	Loosen the screws (3) of the adapter board.	
5	Disconnect the adapter board.	
6	Lift the drive out.	

10.4.4 Installing / removing hard disks

Removing 2.5" drives

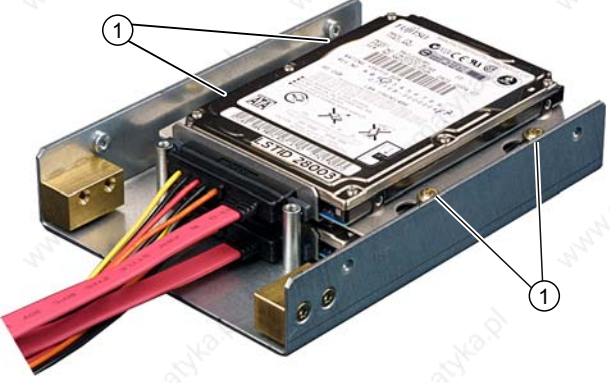
How to remove a 2.5" drive		
1	Remove the drive bay module.	
2	Loosen the screw (1) of the drive.	
3	Remove the hard disk drive and the steel mounting bracket from the bay.	
4	Disconnect the power supply and the data cable from the drive.	

Removing a 3.5" drive

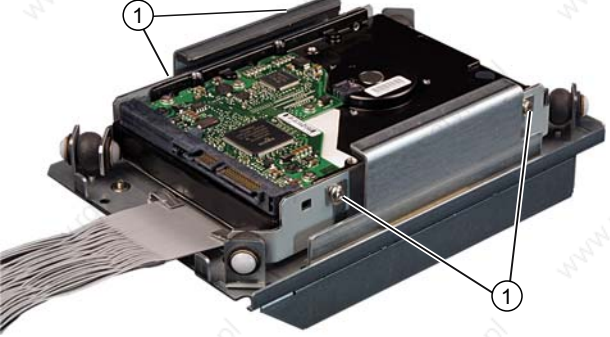
How to remove a 3,5" drive		
1	Remove the drive bay module.	
2	Disconnect the power supply and the data cable from the drive.	
3	Loosen the screws (1) on the drive.	
4	Remove the hard disk drive from the bay.	

Note

Note that special screws with inch threads (6-32 x 3/16" St G3E) are used!

10.5 Installing/removing an on-board Compact Flash card

NOTICE

We highly recommend that use use approved SIMATIC Compact Flash cards. Siemens disclaims any liability for impairment of functions caused by the use of third-party cards.

Memory expansion options

The device features a slot for Compact Flash cards types I / II.

NOTICE

This slot is not hot-plug capable. The Compact Flash card must be installed before the PC is switched on and should only be removed when the device is switched off.

Preparation

Disconnect the device from the mains.

 **CAUTION**

The electronic components on the PCBs are highly sensitive to electrostatic discharge. Always take appropriate precautionary measures when handling these components. Refer to the ESD directives on handling electrostatic sensitive components.

Opening the board slot

How to install a Compact Flash card	
<p>1 Remove the screws.</p>	
<p>2 Slide the cover plate of the module slot towards the DVI connection and lift it out.</p>	

Installing the Compact Flash card

How to install a Compact Flash card	
1	Open the board slot.
2	Insert the Compact Flash card in the slot with the connector facing in until it locks into place.
	
3	Open the module slot.

Note

The Compact Flash slot is coded against reversed insertion. Insert the Compact Flash card so that its label side is facing the front panel of the PC.

CAUTION

If the Compact Flash card meets resistance, flip it over. Never insert the Compact Flash card with force.

Removing the Compact Flash card

How to remove a Compact Flash card	
1	Open the board slot.
2	Press the eject button, for example with the cover of the module slot, and remove the Compact Flash card.
	
3	Open the module slot.

10.6 Installing/removing an additional Compact Flash card

NOTICE

We highly recommend that use use approved SIMATIC Compact Flash cards. Siemens disclaims any liability for impairment of functions caused by the use of third-party cards.

Preparation

Disconnect the device from the mains.

Note

The use of the Compact Flash adapter excludes the simultaneous use of a hard disk.



Installing the additional Compact Flash card

How to install the Compact Flash card in the Compact Flash adapter

- 1 Remove the hard disk cover.

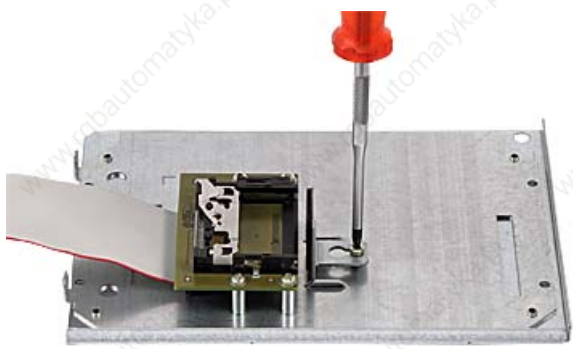

10.6 Installing/removing an additional Compact Flash card

How to install the Compact Flash card in the Compact Flash adapter	
<p>2 Lift out the Compact Flash adapter module and lay it on the device.</p>	
<p>3 Insert the connector on the pin connector of the adapter.</p>	
<p>4 Insert the Compact Flash card in the adapter with the connector facing in until it locks into place.</p>	

How to install the Compact Flash card in the Compact Flash adapter	
<p>5 Close the Compact Flash latch.</p>	
<p>6 Mount the hard disk cover.</p>	

Maintenance and service

11.1 Removing and installing hardware components

11.1.1 Repairs

Repairing components

Only authorized personnel are permitted to repair the device.

 WARNING

Unauthorized opening and improper repairs may lead to material damage and hazards to users.

- Always disconnect the power connector before you open the device.
- Install only system expansions which are designed for this computer. The installation of other expansions can damage the system and violate the radio-interference suppression regulations. Contact Technical Support or your local sales department to find out which system expansions are suitable for installation.

If you install or exchange system expansions and damage your device, the warranty becomes void.

NOTICE

Observe the ESD instructions.

Disclaimer of liability

All technical data and approvals apply only to expansion units which are released by SIEMENS.

Siemens disclaims any liability for impairment of functions caused by the use of third-party devices or components.

Tools

You can perform all installation tasks on the device using Torx T6, T10, and T15 screwdrivers and a Philips screwdriver.

11.1 Removing and installing hardware components

11.1.2 Preventive maintenance

To maintain high system availability, we recommend the preventative replacement of those PC components that are subject to wear. The table below indicates the intervals for this replacement.

Component	Replacement interval:
HDD	3 years
Fan	3 years
CMOS backup battery	5 years

11.1.3 Replacing the Backup Battery

Note

Batteries are wearing parts and should be replaced every five years in order to ensure proper functioning of the PC.

To be noted before you replace the battery

CAUTION
Risk of damage! The lithium battery may only be replaced with an identical battery or with a type recommended by the manufacturer (Order No.: A5E00331143).

 WARNING
Risk of explosion and release of harmful substances! For this reason, do not burn lithium batteries, do not solder on the cell body, do not open, do not short circuit, do not reverse polarity, do not heat above 100°C, dispose of correctly, and protect against direct sunlight, dampness and dew.

Disposal

CAUTION
Batteries must be disposed of in accordance with local regulations.

Preparation

Note

For the BIOS setting "Profile: Standard" the configuration data of the device is deleted when the battery replacement takes more than 30 seconds.

For the BIOS setting "Profile: User" the configuration data of the device is retained; only the date and time has to be reconfigured.

The content of the SRAM is lost if the battery replacement takes more than 30 seconds.

1. Note down the current settings of the BIOS Setup.
A list in which you can note down this information is found in the BIOS manual.
2. Isolate the device from mains and disconnect all connection cables.

NOTICE



You can also replace the battery while the device is running; do not touch anything with the device in this case. We recommend switching off the device beforehand.

Replacing the battery

Follow the steps outlined below:

Steps for replacing the battery	
1	Open the battery compartment.
	

11.1 Removing and installing hardware components

Steps for replacing the battery		
2	Remove the battery holder.	
3	Detach the cable.	
4	Remove the old battery.	
5	Fasten the new battery and reinsert the battery holder.	
6	Close the battery compartment.	

Reconfiguring the BIOS setup

If the battery replacement took longer than 30 seconds, the configuration data of the device have been deleted and you need to reconfigure these in the BIOS Setup.

11.1.4 Removing/Installing the Power Supply



WARNING

Only authorized trained personnel are allowed to replace the power supply unit.

Preparations

1. Isolate the device from mains and disconnect all connection cables.
2. Open the device.

Removing the power supply unit

How to remove the power supply module	
1	Remove the drive bay module for the hard disk and DVD burner.
2	Loosen the screws (1) and remove the power supply cover.
3	Remove the screws (1) (Torx T10).

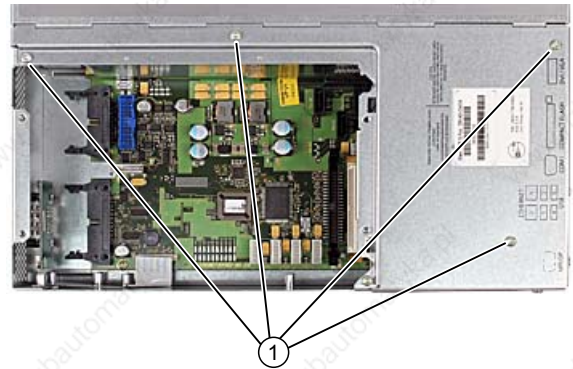

11.1 Removing and installing hardware components



How to remove the power supply module	
4	<p>Detach the power plug (1) from the power supply module.</p> 
6	<p>Lift out the power supply module.</p>

11.1.5 Installing / removing the bus board

Preparation

1. Isolate the device from mains and disconnect all connection cables.
2. Open the device.

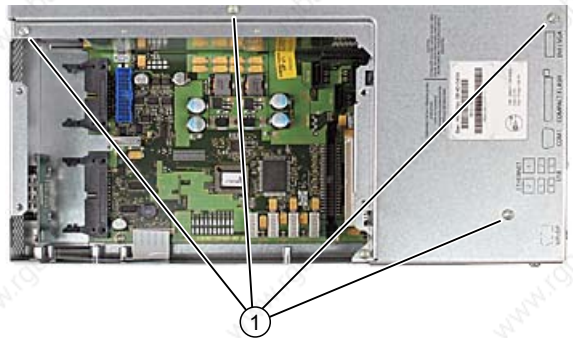
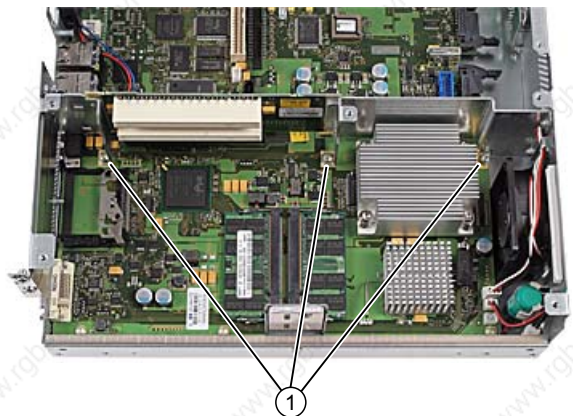
Removing the bus board

How to remove the bus board		
1	Remove all modules from the slots.	
2	Lift out the drive bay module for hard disks and the DVD burner.	
3	Loosen the screws (1) and remove the power supply cover.	
4	Remove the power supply.	
5	Remove the screws (1) on the bus board.	
6	Loosen the screws (1) on the enclosure.	
7	Pull the bus board from the motherboard.	

11.1 Removing and installing hardware components

11.1.6 Installing / removing the motherboard

Preparation

1. Isolate the device from mains and disconnect all connection cables.
2. Open the device.

Removing the motherboard

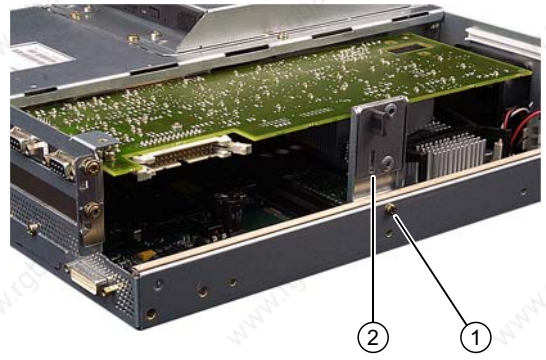
How to remove the motherboard	
1	Remove the drive bay module for the hard disk and DVD burner.
2	Loosen the screws (1). Remove the module bracket (2).
	
3	Remove the power supply cover.
4	Remove the bus board.
5	Remove the power supply.
6	Disconnect all cables from the motherboard, noting down their positions while doing so.
7	Remove the screws (1) (6 pieces) and then the screws (2) (4 pieces). Remove the processor heat sink.

How to remove the motherboard

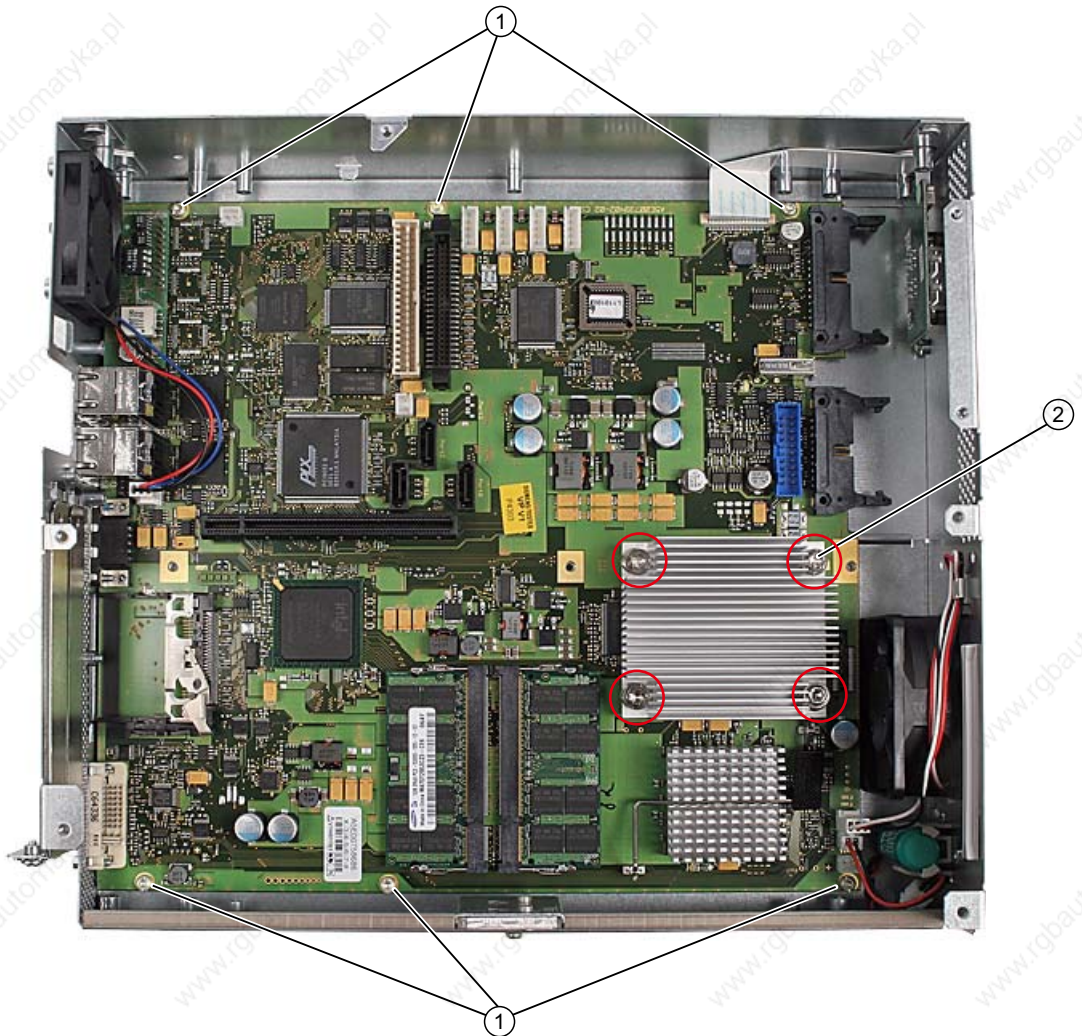

8 Remove the hexagon bolts (6 pieces) from the ports.

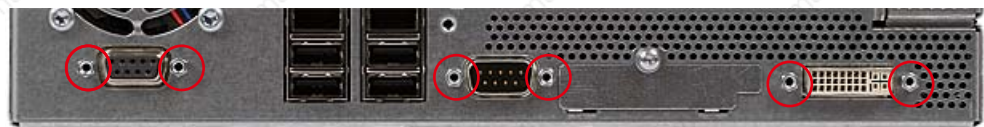

9 Remove the motherboard.

11.1.7 Installing / removing the equipment fan

Preparations

1. Disconnect the device from the mains.
2. Open the device.

Removing the fan

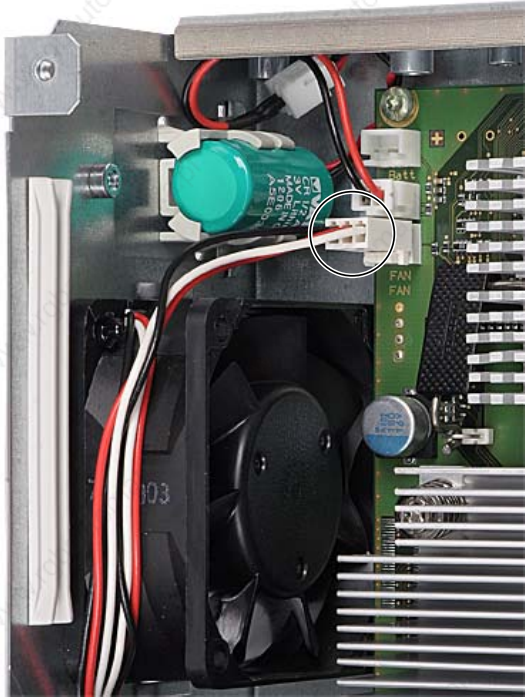
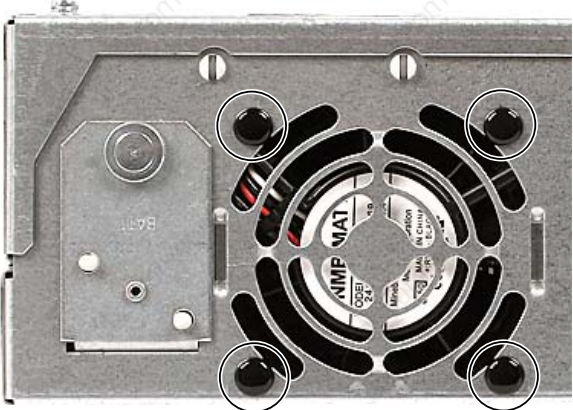
How to remove the fan	
1	<p>Pull the fan plug from the motherboard.</p> 
2	<p>Loosen the four two plastic rivets on the enclosure.</p> 
3	<p>Take the fan out of the enclosure.</p>

Installing the fan

NOTICE

Always install a fan of the same type!

Fan mounting position

The figure shows the correct fan mounting position.

Pay attention to the direction of the arrow on the fan enclosure!

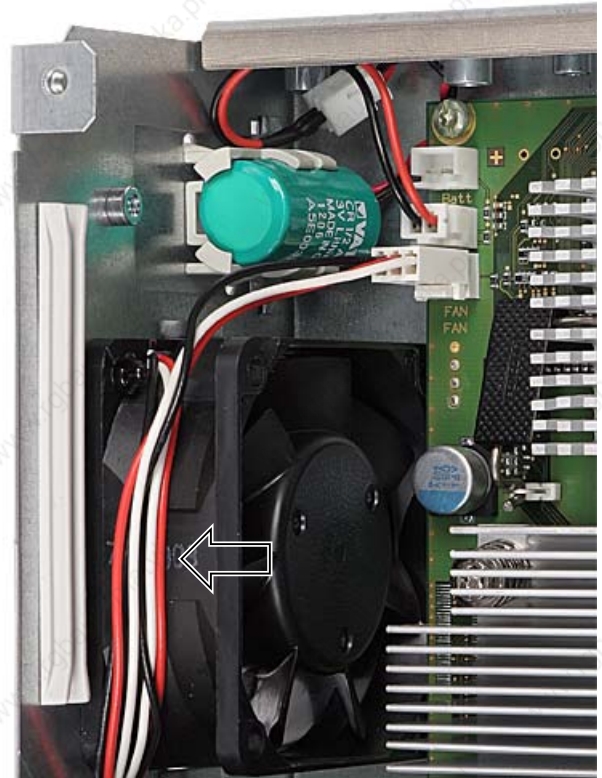



11.1.8 Installing / removing the power supply fan

Preparations

1. Disconnect the device from the mains.
2. Open the device.
3. Remove the power supply.

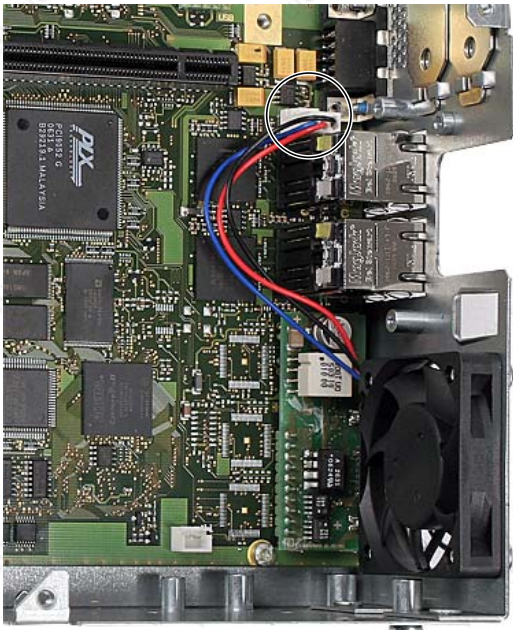
Removing the fan

How to remove the fan		
1	Pull out the fan connector.	
2	Loosen the four screws on the enclosure.	
3	Take the fan out of the enclosure.	

Installing the fan

NOTICE

Always install a fan of the same type!

Fan mounting position

The diagram shows the correct mounting position of the fan (1). Pay attention to the direction of the arrow on the fan enclosure!



11.1.9 Installing / removing the processor

CAUTION

The processor replacement may only be carried out by authorized qualified personnel.

Preparation

1. Disconnect the device from the mains.
2. Open the device.
3. Remove the drive bay module.
4. Remove the power supply cover.

Removing the processor

How to remove the processor

- 1 Remove the four screws from the processor heat sink and remove the heat sink.

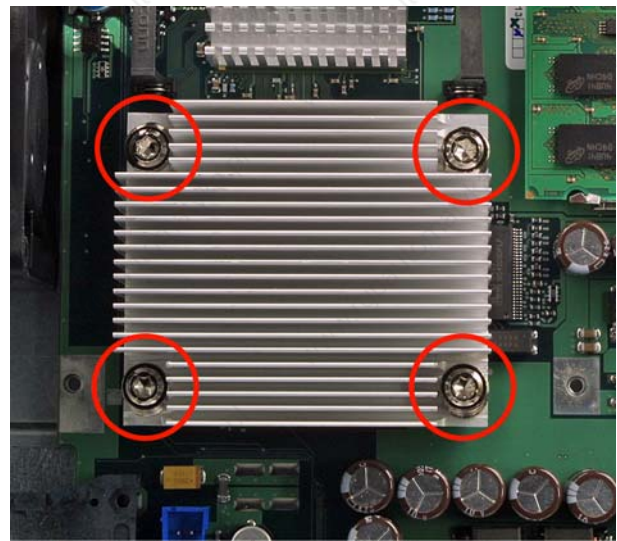

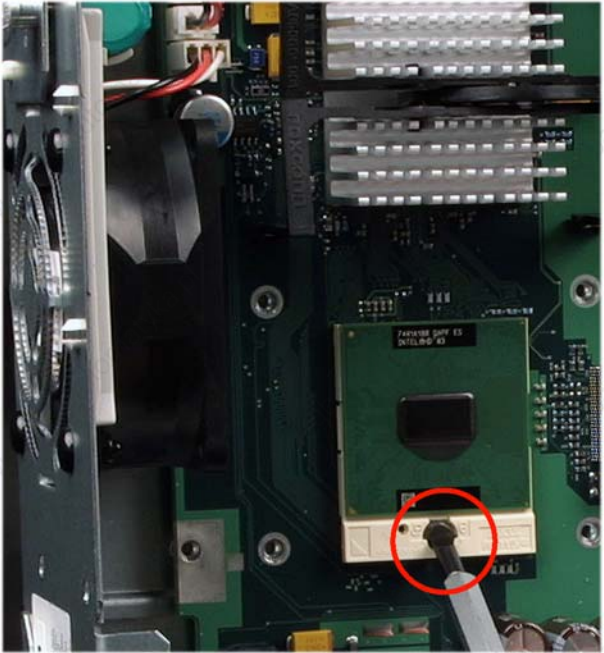
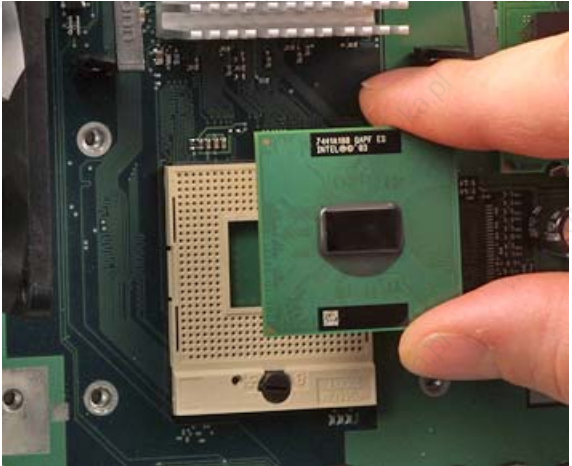
How to remove the processor	
2 Loosen the processor latch.	 A close-up photograph of the processor latch on a green PCB. A screwdriver is being used to turn the latch counter-clockwise. A red circle highlights the latch mechanism. The processor is labeled 'Z441880 D4P5 ES INTEL® QM-82'.
3 Remove the processor.	 A close-up photograph showing a person's fingers lifting the processor out of the socket. The processor is held by the top and bottom edges. The socket is labeled 'Z441880 D4P5 ES INTEL® QM-82'.

11.1 Removing and installing hardware components

Installing the processor

Note

When you insert the processor, make sure the markings on the processor and on the socket match up.

NOTICE

The processor may overheat when the system is in operation! Apply the heat-conductive paste very evenly, as a thin film!

How to install the processor

1 Insert the processor.

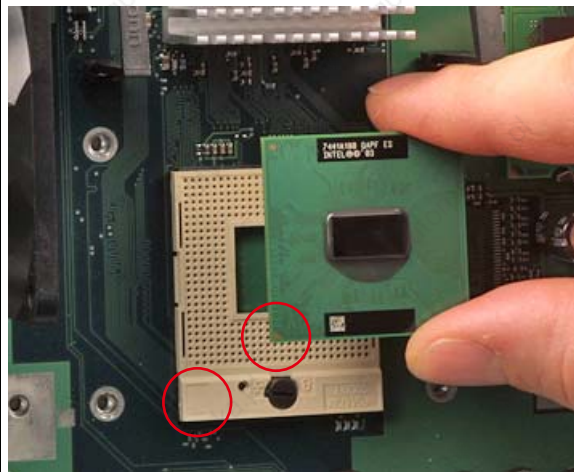

2 Close the processor latch.

3 Apply the heat-conductive paste on the processor.

4 Secure the processor heat sink with the four screws.
To do so, insert the screws diagonally and tighten them evenly, working diagonally in order to avoid tilting of the fan unit.
Tighten the screws down to the mechanical stop.

Required tools

You need a Torx 10 screw driver for removing the processor.

11.2 Reinstalling the operating system

11.2.1 Windows XP Embedded

11.2.1.1 General installation procedure

If your software becomes corrupt for any reason, you can reinstall it from the Restore CD. The Restore CD contains a image file for the hard disk or Compact Flash card with the original software (operating system with installed hardware drivers) and is included in the Windows XP Embedded package variant.

Note

You require a USB keyboard in order to reinstall the operating system and a USB CD-ROM drive.

11.2.1.2 Restoring the software to factory state using the Restore CD

You can reinstall the original factory software using the Restore CD (included in the product package). The CD contains the necessary images and tools for transferring the factory software to the hard disk or Compact Flash card of your PC. The following options are available for restoring software:

- You can restore the entire Compact Flash card with drive C: (system) and drive D:
- or only drive C:.. This allows you to retain any user data on drive D:.
- Restore the entire Compact Flash card.

CAUTION

With the option "Restore system partition only", all data on drive C: (system partition) will be deleted. All data, user settings and all authorizations or license keys on drive C: are lost! All data on drive C: of your hard disk will be deleted. Setup formats the hard disk partition and reinstalls the original factory software.

When you select the "Restore entire hard disk" option, ALL the data, user settings and authorizations or license keys will be lost on the Compact Flash card.

Restoring factory state

To restore the factory state, proceed as follows:

1. If the device does not have an optical drive, connect a USB CD-ROM drive to the device.
2. Insert the Restore CD in the drive and reboot the device. When the BIOS message

Press <F2> to enter Setup or <ESC> to show Boot menu
--

appears, press the F2 key.

3. Select the Boot menu and move the entry "CD-ROM Drive" to the first position.
4. End the BIOS setup with the "Exit Saving Changes" option.
5. Follow the on-screen instructions.

CAUTION

All existing data, programs, user settings and authorizations or license keys on the drives will be deleted and are therefore lost.

For information on the functions, refer to the README.TXT file on the Restore CD.

Note

The "Legacy USB Support" option has to be set to "Enabled" in the Advanced menu of the BIOS so that the device can address a USB CD-ROM drive.

11.2.2 Windows XP Professional / Windows 2000 Professional

11.2.2.1 General installation procedure

If your software becomes corrupt for any reason, you have two possibilities:

- **Restoring the factory state of the software with the Restore DVD**
The Restore DVD contains an image file of the original supplied software (operating system with installed drivers) and is included in the Windows XP Professional variant.
- **Setting up the operating system with the Windows 2000 Professional Recovery CD**
The recovery CD contains the tools required to set up the hard disk as well as the operating system. After the required data have been copied to the hard disk, you can run Windows XP professional Setup to install the operating system.

Note

You will need a USB keyboard in order to reinstall the operating system.

11.2.2.2 Restoring the Software to Factory State Using the Restore DVD

You can reinstall the original factory software (included in the Windows XP Professional supply variant) using the Restore DVD. The DVD contains the necessary images and tools for transferring the factory software to the hard disk of your PC. The following options are available for restoring software:

- You can restore the entire hard disk with drive C: (system) and drive D:
- or only drive C:. This allows you to retain any user data on drive D:.

CAUTION

With the option "Restore system partition only", all data on drive C: (system partition) will be deleted. All data, user settings and all authorizations or license keys on drive C: are lost! All data on drive C: of your hard disk drive will be deleted. Setup formats the hard disk partition and reinstalls the original factory software.

When you select the "Restore entire hard disk" option, ALL the data, user settings and authorizations or license keys will be lost on the hard disk.

Restoring factory state

To restore the factory state, proceed as follows:

1. If the device does not have an optical drive, connect a USB DVD-ROM drive to the device.
2. Insert the Restore DVD in the drive and reboot the device. When the BIOS message

Press <F2> to enter Setup or <ESC> to show Boot menu
--

appears, press the F2 key.

3. Select the Boot menu and move the entry "CD-ROM Drive" to the first position.
4. End the BIOS setup with the "Exit Saving Changes" entry.
5. Follow the on-screen instructions.

CAUTION

All existing data, programs, user settings, authorizations and license keys on the drives will be deleted and are therefore lost.

For information on the functions, refer to the "README.TXT" file on the Restore DVD.

Note

The "Legacy USB Support" option has to be set to "Enabled" in the Advanced menu of the BIOS so that the device can address a USB DVD-ROM drive.

Setting up the language selection for Windows XP Professional

The Multilanguage User Interface (MUI) allows you to set up the Windows XP Professional menus and dialogs for additional languages.

Default language of your Windows XP MUI installation is English and a US keyboard layout. You can change the language in the Control Panel. Select:

"Start > Control Panel > Regional and Language Options" "Languages" tab, "Language used in menus and dialogs" field.
--

For the "Regional and Language Options" set the default as "non-Unicode programs" under "Advanced" in addition to the language for menus and dialogs.

Setting up the language selection for Windows 2000 Professional

The Multilanguage User Interface (MUI) allows you to set up the Windows 2000 menus and dialogs for additional languages.

The dialog language for Windows 2000 menus and for the keyboard layout are set in the corresponding Control Panel dialog:

"Start > Settings > Control Panel > Regional Options" "General" tab, "Menus and Dialogs" field and "Language Settings" field for the system and in the "Input locales" tab, "Keyboard layout" field.

The default language setting of your Windows 2000 installation is English with US keyboard layout. To change to another language and keyboard layout, open the Control Panel and select:

Start > Settings > Control Panel > Regional Options > "General" tab, "Menus and dialogs" field and "Language settings for the system" field and the "Input language" field in the "Input Locales" tab.

In addition to the menu and dialog language settings, you also need to set the default language for the region by selecting "Set default..." from the "Regional Options" dialog box.

11.2.2.3 Setting up the operating system via the Recovery CD

Use the Recovery CD to install Windows to suit your particular requirements. The operating system used is Windows Preinstall Environment (WinPE). You also need the "Documentation and Drivers" CD supplied in the package.

Booting from the Recovery CD

1. Insert the Recovery CD in your drive and reboot the device. When the BIOS message Press <F2> to enter Setup or <ESC> to show Boot Menu appears, press the <ESC> key. The "Boot Menu" is displayed when initialization is completed.
2. Follow the on-screen instructions until the "Siemens SIMATIC Recovery" window opens.

Partition setup

Set up the hard disk partitions after having installed a new hard disk, or to repair faulty partitions, or to change the partitioning.

CAUTION

When you delete or create partitions or logical DOS partitions, you lose all data on the hard disk. All partitions on the hard disk will be deleted.

11.2 Reinstalling the operating system

With Windows XP/2000 operating systems, the factory state features two partitions with an NTFS file system on the hard disk. To restore the partitions to factory state, proceed as follows:

1. Boot from the Recovery CD and then follow the on-screen instructions until the "Recovery Functions" window is displayed.
2. Start the "DiskPart" tool in the "Siemens SIMATIC Recovery" window. Enter the following commands in the displayed command interface:

list disk	Displays all available hard disks.
select disk 0	Selects the disk where you wish to change the configuration. 0 selects the first hard disk.
list partition	Displays all partitions on the selected hard disk.
clean	Completely wipes the selected hard disk. All information stored there is lost.
create partition primary size=n	Creates a primary partition with the n MB on the selected hard disk. Factory state values: n = 10000 for Windows 2000 or XP
select partition 1	Select the primary partition
active	Activates the selected partition
exit	Closes DiskPart.

Additional DiskPart functions:

Help	Shows all available DiskPart commands. When a command is supplemented with other parameters, the command is described with additional information. Example: create partition help
------	--

Note

Once you have change the configuration of your hard disk with DiskPart, you will need to reboot the PC for the changes to go into effect.

Boot again from the Recovery CD to format the partitions.

Format primary partition

1. Boot from the Recovery CD to format the partitions. Follow the screen instructions until the Recovery functions window is displayed.
2. Select "Start command prompt" in the Recovery functions window. In the command interface that opens, enter the following command:
format DL:/FS:File System
DL = Drive letter of the partition to be formatted. Valid values: C, D, E, F etc.
File system = Specifies the type of file system. Valid values: FAT, FAT32, NTFS.

NTFS is the factory setting for all Windows operating systems.

Example:

format C:/FS:NTFS

format /? Shows all parameters of the command.

Installation of the operating system.

The recovery CD contains encrypted data that can only be transferred to this system.

1. Boot from the Recovery CD and then follow the on-screen instructions until the Recovery functions window is displayed.
2. Select "Recovery Windows ..." in the "Siemens SIMATIC Recovery" window.
3. Follow the instructions on the screen.

Note

Note that the following available space is required on the drive after transfer of the selected recovery data:

500 MB for Windows 2000

1500 MB for Windows XP

4. Select "Start command prompt" in the "Recovery Functions" window.
5. Enter the following command in the displayed command prompt interface:
Drive:
cd \I386
Winnt32.bat
Drive: Drive letter of the folder containing the I386 directory.
6. The preparation of the Windows installation is displayed.
7. When this is completed, close the command prompt with the "exit" command.
8. Close the "Siemens SIMATIC Recovery" window by clicking the "Finish" button.
9. Setup automatically restarts the system and completes the installation of Windows.
10. Follow the instructions on the screen.

Note

If you want to use Windows XP as a professional you should have the following manual (not included in the scope of delivery) available:

Microsoft Windows XP Professional, the technical reference" (MSPress Nr 934)

This manual contains special information for administrators involved in installing, managing and integrating Windows in networks or multi-user environments.

Setting up the language selection for Windows XP Professional

The Multilanguage User Interface (MUI) allows you to set up the Windows XP Professional menus and dialogs for additional languages.

To install the MUI, start the "MUISETUP.EXE" program on the "MUI-english" Recovery CD under the folder

CD_DR:\MUI

or in the root directory of the "MUI Windows XP" Recovery CD. Follow the on-screen instructions, in order to install the required languages.

Default language of your Windows XP MUI installation is English and a US keyboard layout. You can change the language in the Control Panel. Select:

"Start > Control Panel > Regional and Language Options", "Languages" tab, "Language used in menus and dialogs" field.

For the "Regional and Language Options" set the default as "non-Unicode programs" under "Advanced" in addition to the language for menus and dialogs.

Setting up the language selection for Windows 2000 Professional

The Multilanguage User Interface (MUI) allows you to set up the Windows 2000 menus and dialogs for additional languages.

To install the MUI, start the "MUISETUP.EXE" program in directory

CD_DR:\SOURCE\MUI

on the Recovery CD. Follow the on-screen instructions, in order to install the required languages.

The dialog language for Windows 2000 menus and for the keyboard layout are set in the corresponding Control Panel dialog:

"Start > Settings > Control Panel > Regional Options", "General" tab, "Menus and dialogs" field and "Language settings for the system" field and the "Keyboard layout" field in the "Input Locales" tab.

The default language setting of your Windows 2000 installation is English with US keyboard layout. To change to another language and keyboard layout, open the Control Panel and select:

Start > Settings > Control Panel > Regional Options > "General" tab, "Menus and dialogs" field and "Language settings for the system" field and the "Input language" field in the "Input Locales" tab.

In addition to the menu and dialog language settings, you also need to set the default language for the region by selecting "Set default..." from the "Regional Options" dialog box.

11.2.3 Recovery of Windows Vista

To recover Windows Vista, there is a full graphical user interface available. It may take several minutes before the first input window appears. In this window, you can set the time and currency formats and select the keyboard language.

English is the basic language and other languages can be installed later with the MUI. The MUI is on the recovery DVD.

Now follow the on-screen instructions. It may take several minutes before the next prompt for the product key is displayed.

Note

Due to the previous activation, you do not need to enter the product key (COA number). This is entered automatically during the installation.

Setting up and formatting partitions

After you have installed a new hard disk, or if partitions are faulty, or when you wish to change the partitioning on your hard disk, you need to create or reconfigure partitions on the hard disk.

In the next dialog box, you can set up the hard disk according to your requirements and add controllers that are not yet known to the system.

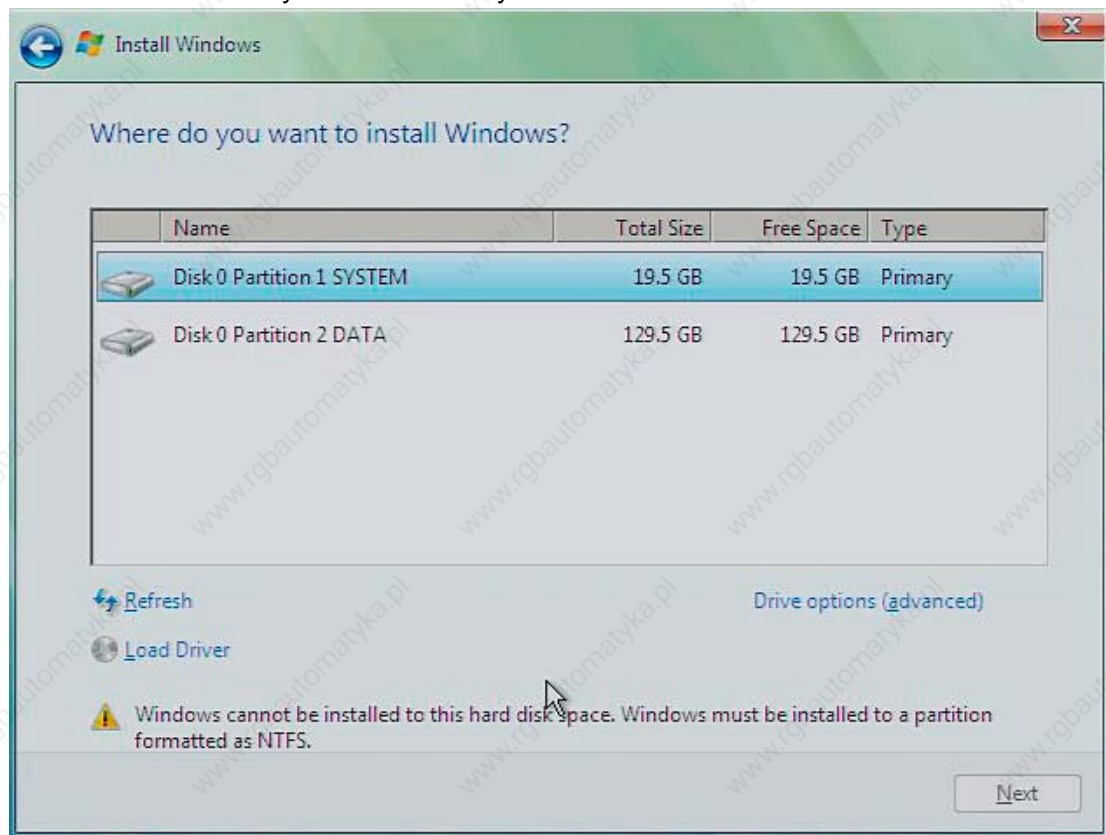

11.2 Reinstalling the operating system

Options	Meaning
Drive options (advanced)	Further functions are displayed with which you can set up the hard disk.
Load Driver	To add new drivers, for example the driver for RAID.

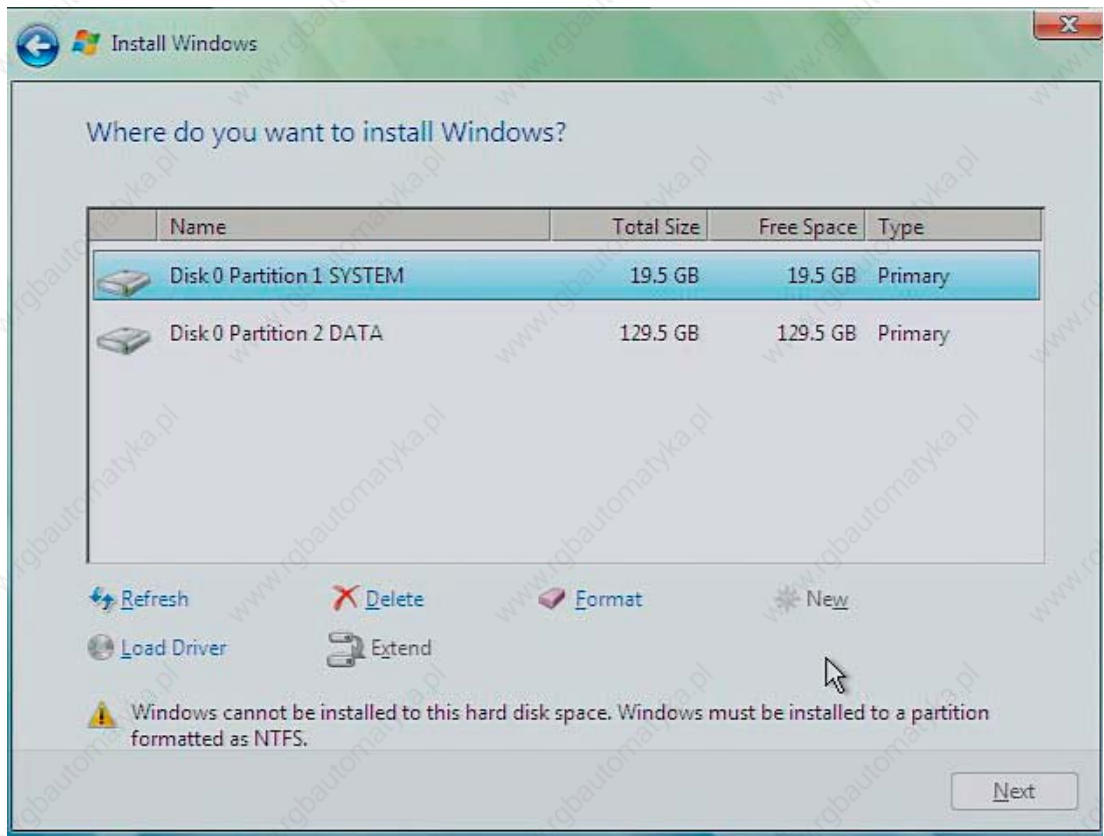

Options	Meaning
Refresh	Updating
Delete	Deleting a partition
Format	Formatting a partition
New	Creating new partitions
Load Driver	To add new drivers, for example the driver for RAID
Extend	Changing the partition size
	Any error messages that occur are displayed behind this icon, for example if the hard disk was not formatted in the required "NTFS" format.

The first partition should be at least 25 GB. The operating system must be installed on this partition. You can use the rest of the hard disk as a data partition. Both partitions must be installed as the NTFS file system.

When shipped, the partitions are set up as follows:

Partition	Operating system	Name	Size	File system
First	Windows Vista	SYSTEM	25 GB	NTFS not compressed
Second	Windows Vista	DATA	Remainder	NTFS not compressed

Following a reboot, Windows Vista is installed on the hard disk. This process takes at least 20 minutes.

Now follow the instructions on the screen.

Note

If you want to reinstall drivers from the integrated floppy disk drive, select Floppy Drive (A:).
If you want to reinstall drivers from a USB floppy disk drive, select Floppy Drive (B:).

Note

If you want to use Microsoft Windows as a professional user, you will need the following manual (not supplied):
Windows Vista Inside Out

This manual contains information specifically for administrators involved in installing, managing and integrating Windows in networks or multi-user environments.

Setting up language options in Windows Vista

With the Multilanguage User Interface (MUI), you can set up the Windows menus and dialogs for additional languages. When shipped, Windows Vista is installed with English menus and dialogs. You can change this in the Control Panel with the "Regional and Language options" or "Time and Date" dialogs.

Here, you can change all system formats:

Start > Control Panel > Clock, Language, and Region > Change display language > Regional and Language options

Here, you can only change the date and time formats:

Start > Control Panel > Clock, Language, and Region > Change display language > Time and Date

If you want to install additional languages, you can install these later in the Control Panel, as follows. You will find the necessary files on the recovery DVD in the "Languagepacks" folder.

Start > Control Panel > Clock, Language, and Region > Change display language > Regional and Language options > Keyboards and Languages

Additional languages can be integrated through Windows Update.

11.3 Partitioning data media

11.3.1 Setting up the partitions under Windows XP Embedded

You need to set up the partitions on the Compact Flash card after installed a new Compact Flash card or to repair corrupt partitions or to change the partitioning.

Partitioning the Compact Flash card

The factory state of the Compact Flash card includes the following partitions:

Partition	Name	Size of card 2 GB	File system
1. Partition	SYSTEM	867 MB	NTFS (compressed)
2. Partition	DATA	Remainder *	NTFS (compressed)

* Due to partitioning/formatting, the actual capacity of the Compact Flash card does not match the memory size specified on the Compact Flash card.

In order to revert to the original factory state partitions, we recommend using the software tool "SIMATIC PC/PG Image Creator". Detailed information about using this tool is available in the manufacturer documentation.

11.3.2 Setting up partitions under Windows XP Professional / Windows 2000 MUI

Set up the hard disk partitions after having installed a new hard disk, or to repair faulty partitions, or to change the partitioning.

Partitioning the hard disk

The factory state of the hard disk with Windows XP/2000 includes the following partitions:

Partition	Name	Size	File system
1. Partition	SYSTEM	20 GB	NTFS (not compressed)
2. Partition	DATA	Remainder	NTFS (not compressed)

In order to revert to the original factory state partitions, we recommend using the software tool "SIMATIC PC/PG Image Creator". Detailed information about using this tool is available in the manufacturer documentation.

11.4 Install drivers and software

11.4.1 Installing drivers and software

NOTICE

Before you install new drivers or updates for multilingual operating systems, (MUI versions), reset the regional settings for menus and dialogs and the default language to US English.

Install the drivers and software from the included "Documentation and Drivers" CD.
Procedure:

1. Place the CD into the drive.
2. Start the program with "START".
3. Select "Drivers & Updates" from the index.
4. Select the operating system in "Drivers & Updates".
5. Install the required driver.

NOTICE

For new Windows 2000 / XP installations, the chipset driver must be installed before you install any other drivers.

11.4.2 Driver installation under Windows XP Embedded

The driver installation under Windows XP Embedded is conducted in the same way as under XP Professional. Pay attention to the installation instructions of the driver manufacturer.

When drivers are being installed under Windows XP Embedded, you may see a message that the Windows XP Installation CD or SP2 CD is required.

In this case, insert the Restore DVD. The required files are in the \Drivers_XPE folder.

11.5 RAID1 system setup

11.5.1 Settings in the BIOS setup and RAID ROM option

1. Make the following setting in the BIOS Setup:
Menu Advanced > SATA/PATA Configuration: SATA RAID Enable
2. Reboot the device.
3. Set up the RAID system using the RAID ROM option.
To do this, press the key combination <Ctrl-I> when the message shown below appears on the screen and follow the instructions.

```
Intel(R) Matrix Storage Manager option ROM v5.6.2.1002 ICH7R wRAID5
Copyright(C) 2003-06 Intel Corporation. All Rights Reserved.

RAID Volumes:
ID Name Level Strip Size Status Bootable
0 Volume0 RAID1 (Mirror) N/A 149.1GB Normal Yes

Physical Disks:
Port Drive Model Serial # Size Type/Status (Vol ID)
0 ST3160815AS 5RA01YJT 149.1GB Member Disk(0)
2 ST3160815AS 5RA01YHY 149.1GB Member Disk(0)

Press <CTRL-I> to enter Configuration Utility...
```

Figure 11-1 RAID ROM option (example)

11.5.2 Replacing a defective drive in the RAID system

Replace defective RAID drives with a new drive in order to recover secure RAID1 state. The RAID software reports the defective drive and returns details of the operable hard drive.

The functioning hard drive is indicated in BIOS by its port number, or by the RAID software by its device port number.

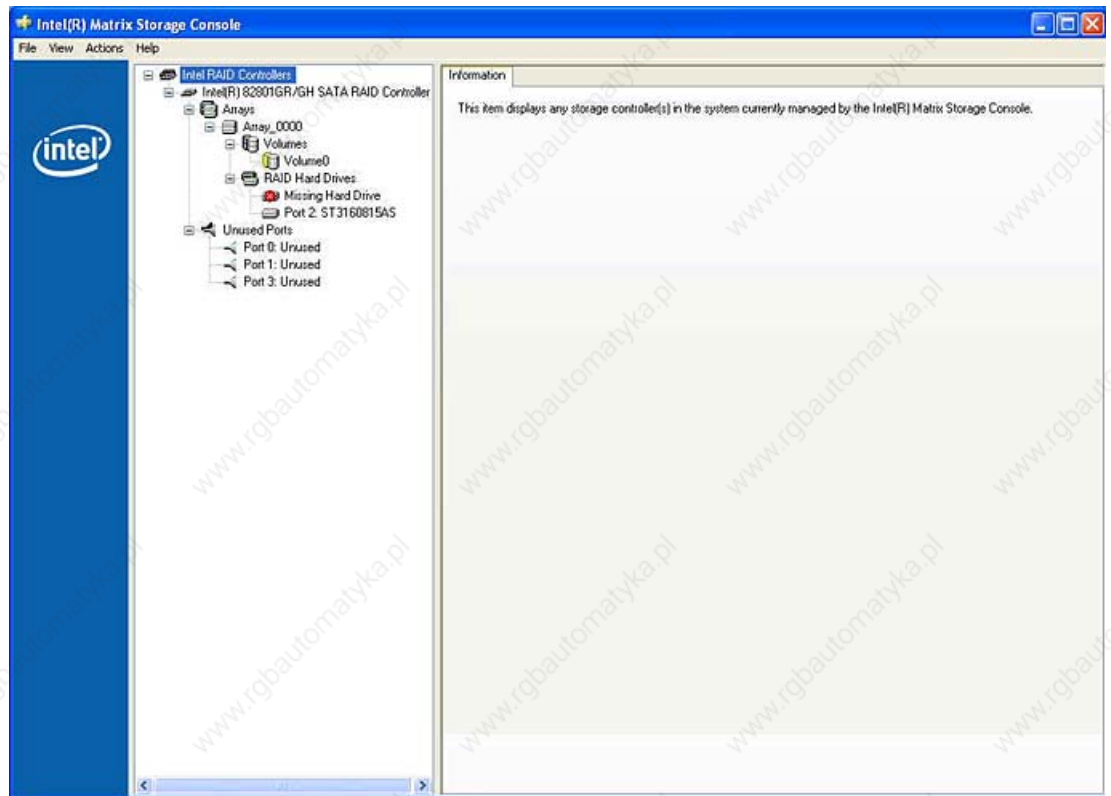

Figure 11-2 Example

Always replace the defective drive with a new one of the same type and capacity.

To be able to boot from the RAID system, you must place this first in the list of bootable sources in the BIOS "Boot" setup menu. Otherwise the system will boot from the hard disk you have just installed and the message "Operating system not found" will be displayed.

NOTICE

The new HDD can be integrated into the RAID system at operating system level by means of the RAID software. Synchronization may take several hours, depending on system load.

Integrating a new hard drive

Select the "Rescan for Plug and Play Devices" command to find and indicate the new HDD. You can also choose to reboot the device. In this case, the RAID software automatically integrates the new HDD and synchronizes the RAID system.

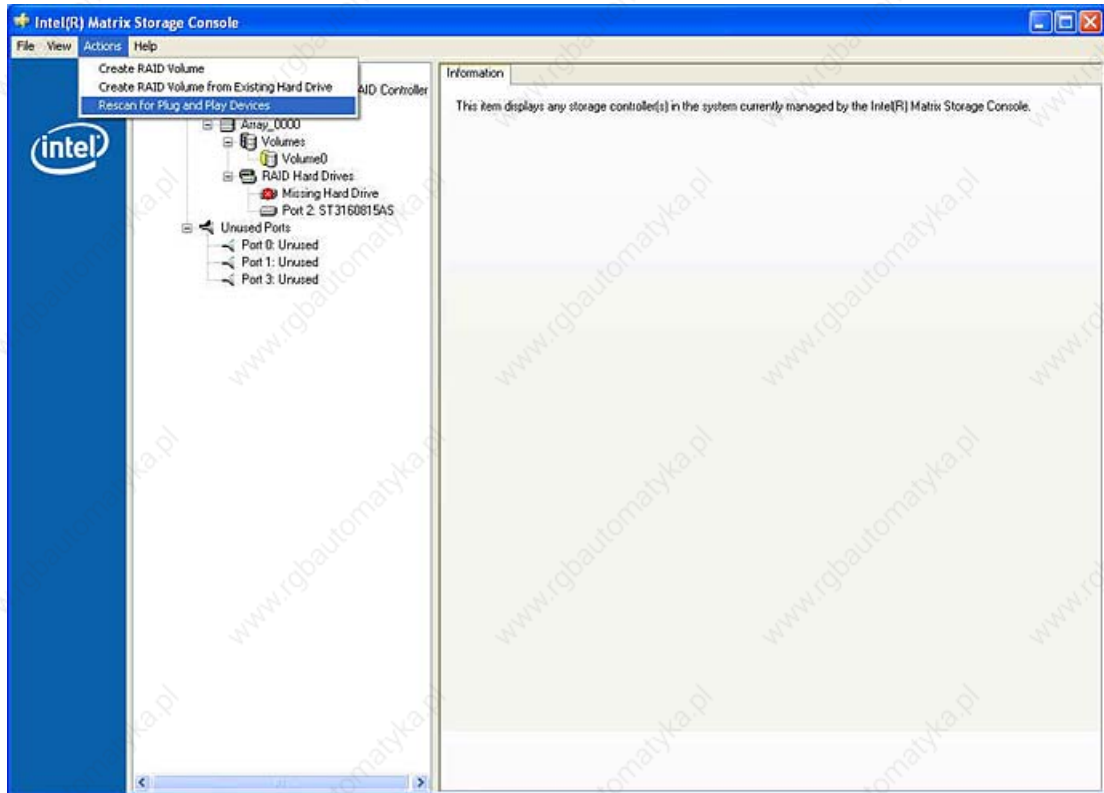

Figure 11-3 Example

NOTICE

BIOS messages during startup

At the first restart / cold start following a hard disk failure or installation of a new hard disk (servicing), the RAID BIOS reports that the RAID functionality is no longer available and offers the appropriate operator options.

The "Rebuild to this Hard drive" command initiates synchronization of the RAID1 system.

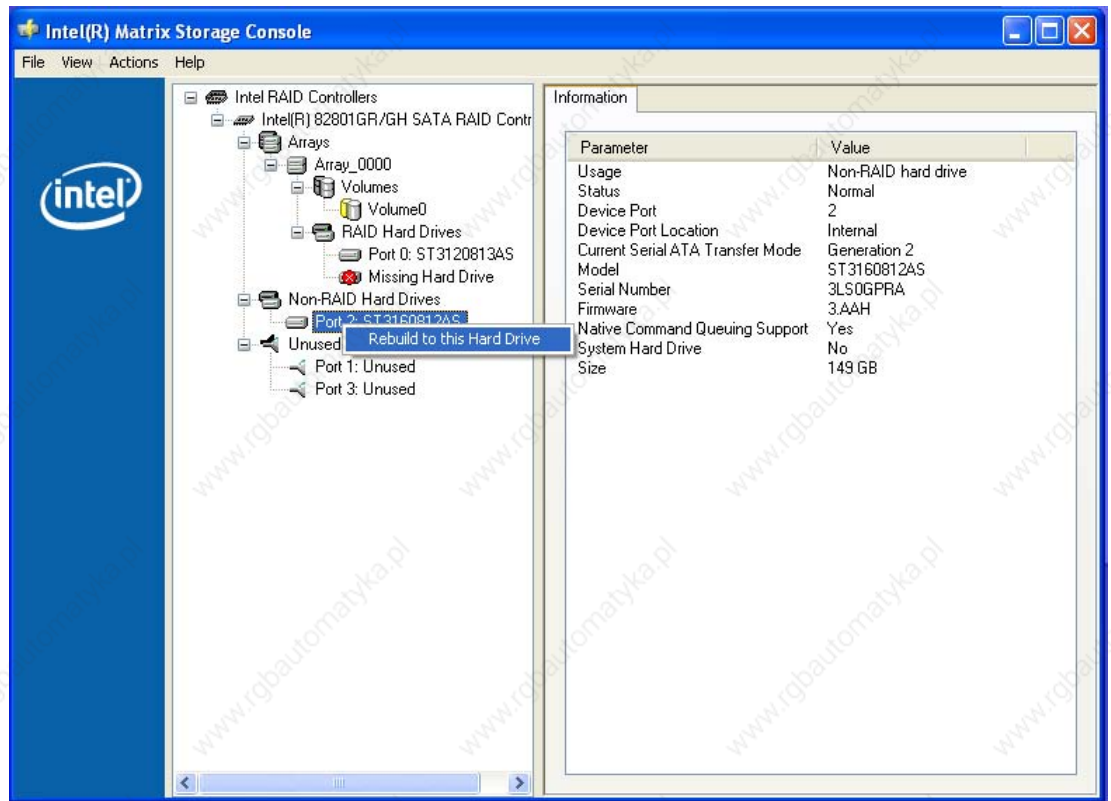

Figure 11-4 Example

NOTICE

The "SIMATIC PC DiagMonitor" diagnostics and alarm software also provides information about the RAID status. This software only needs to be installed once - logons are not required. The diagnostics and alarm software "SIMATIC DiagMonitor" is available as an accessory.

Notes for RAID configuration with installed SIMATIC PC DiagMonitor software

When creating a RAID-system where SIMATIC PC DiagMonitor software is being used, the Intel Matrix Storage Console may abort the process with the following error message:

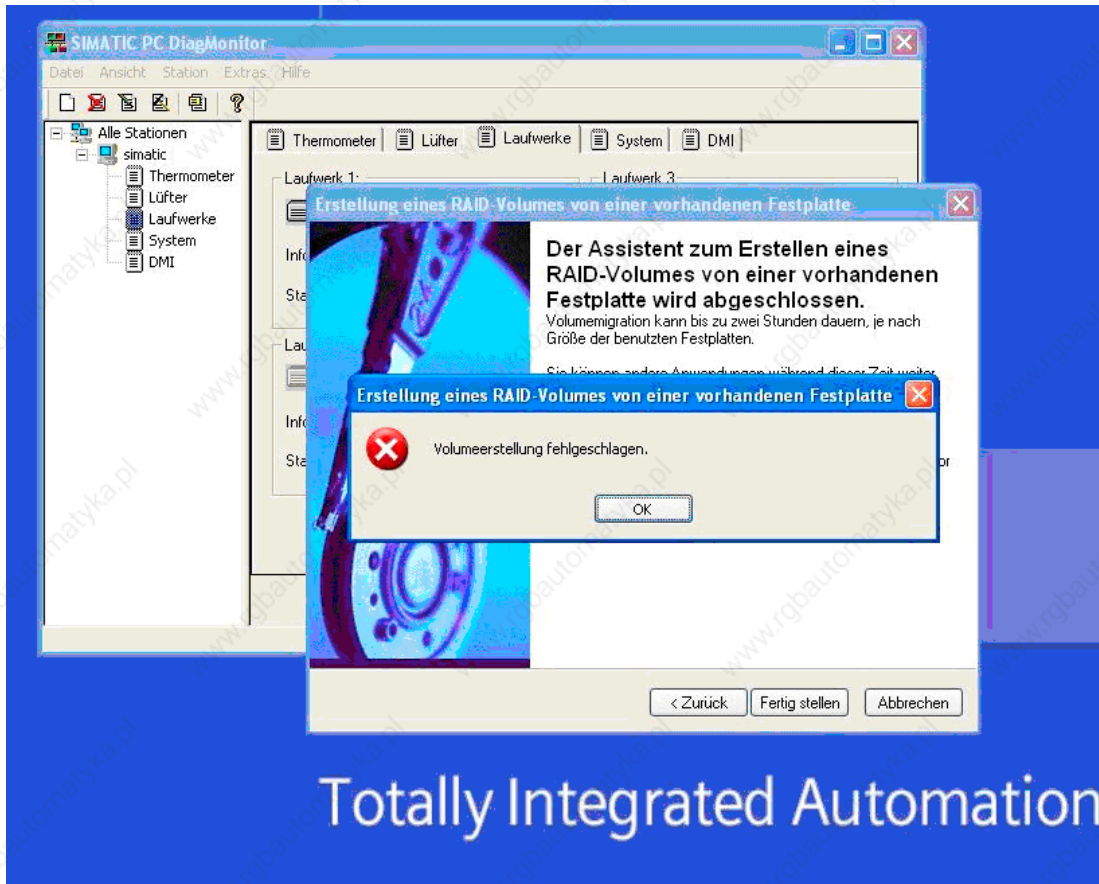

Figure 11-5 Example

Solution:

Before performing a RAID commissioning, the SIMATIC PC DiagMonitor should be deactivated. Subsequently, it can be reactivated.

Measures:

If the DiagMonitor Management Station is in operation on your device:

- Close all applications, also the Management Station.
- Afterwards, stop the DiagMonitor SNMP Agent (SOL-Agent). In order to do so, select **Start > Run** and enter `cmd` in the field.
- Afterwards, enter `Net stop snmp` and confirm with the Enter key.

If your device is remotely monitored with SIMATIC PC DiagMonitor:

In this case you need **only** stop the DiagMonitor SNMP Agent (SOL-Agent).

- In order to do so, select **Start > Run** and enter `cmd` in the field.
- Afterwards, enter `Net stop snmp` and confirm with the Enter key.

NOTICE

If you do not adhere to the procedure described above, a correct RAID configuration cannot be guaranteed.

11.5.3 Installing the RAID Controller software

You find the procedure for installing the RAID controller software in the RAID user manual on the supplied "Documentation and Drivers" CD.

Note concerning Windows 2000 Professional / XP Professional

You need to select the Intel 82801GR/GH SATA RAID Controller from the provided list when installing Windows 2000 Professional /XP Professional for the first time.

11.6 Installing burner software

11.6 Installing burner software

11.6.1 Installing the burner software

Information about installation of the burner / DVD software is available on the supplied CD.

11.7 Installing updates

11.7.1 Updating the operating system

Windows

The latest updates for Windows operating systems are available on the Internet at <http://www.microsoft.com>

NOTICE
Before you install new drivers or operating system updates for Windows MUI versions, set the default language to US English in the regional settings for menus and dialogs.

Other operating systems

Please contact the corresponding manufacturer.

11.7.2 Installing or updating application programs and drivers

In order to install software from a CD and/or floppy disc under Windows XP Embedded / Windows XP Professional, the corresponding drive must be installed or connected.

Drivers for USB floppy disk and CD-ROM drives are included in Windows XP Embedded/Windows XP Professional and do not have to be installed from other sources.

For information about installation of SIMATIC software packages, refer to the respective manufacturer documentation.

For updates of drivers and application programs from third-party manufacturers, contact the respective manufacturer.

NOTICE
Before you install new drivers or operating system updates for Windows XP Professional MUI versions, set the default language to US English in the regional settings for menus and dialogs.

11.8 Data backup

11.8.1 Creating an image

Data backup under Windows XP Embedded/Windows XP Professional

To back up data under Windows XP Embedded / Windows XP Professional, we recommend the software tool "SIMATIC PC/PG Image Creator". This tool provides comfortable and efficient functions for backup and restoring the full content of Compact Flash cards, HDDs and individual partitions (images.)

Image Creator only supports burning to DVD media.

The software can be ordered from the Siemens A&D online ordering system. For detailed information about SIMATIC PC/PG Image Creator, please refer to the corresponding product documentation.

11.9 CP 1616 onboard

NDIS device driver

Read the information in the Installation_CP16xx.pdf document on the supplied Documentation and Drivers CD.

PROFINET IO

Read the information in the "Integration" section listing the SIMATIC devices and SIMATIC NET documentation.

Alarm, error, and system messages

12.1 Boot error messages

BIOS first performs a **Power On Self Test (POST)** within the boot routine to verify proper operation of certain functional units of the PC. If an error is detected within this phase, BIOS outputs a beep code based on the current test result. The boot sequence is interrupted immediately if fatal errors occur.

If the POST does not return an error, the BIOS initializes and tests further functional units. In this startup phase, the graphics controller is initialized and any error messages are output to the screen.

The error messages output by the system BIOS are listed below. For information on error messages output by the operating system or programs, refer to the corresponding manuals.

On-screen error messages

On-screen error message	Meaning / suggestions
Address conflict	Plug and Play problem. Contact your technical support team.
Combination not supported	Plug and Play problem. Contact your technical support team.
IO device IRQ conflict	Plug and Play problem. Contact your technical support team.
Invalid System Configuration Data	Plug and Play Problem <ul style="list-style-type: none"> • Set the RESET CONFIGURATION DATA option in the "Advanced" menu of Setup. • Contact your technical support team.
Allocation Error for ...	Plug and Play problem <ul style="list-style-type: none"> • Please undo the last hardware change. • Contact your technical support team.
System battery is dead. Replace and run SETUP	The battery on the CPU module is defective or dead. Contact your technical support team.
System CMOS checksum bad Run SETUP	Call up SETUP, adjust settings and save. If this message appears during each startup, contact your technical support team.
Failure Fixed Disk	Error accessing the hard drive. Check the SETUP settings. Contact your technical support team.
Keyboard error	Check whether the keyboard is properly connected.
Key seizure	Check whether a key on the keyboard has seized.

12.1 Boot error messages

On-screen error message	Meaning / suggestions
System RAM Failed at offset:	Memory error. Contact your technical support team.
Shadow RAM Failed at offset:	Memory error. Contact your technical support team.
Extended RAM Failed at offset:	Memory error. Contact your technical support team.
Failing Bits:	Memory error. Contact your technical support team.
Operating system not found	Possible causes: <ul style="list-style-type: none"> • No operating system present • Wrong drive addressed (disk in drive A/B) • Incorrect active boot partition • Wrong boot drive settings in SETUP • Hard disk is not connected / defective
Previous boot incomplete Default configuration used	Abort of the previous BOOT procedure, for example, due to a power failure. Adjust the settings in SETUP.
System cache error Cache disabled	Error in the CPU's cache module. Contact your technical support team.
Monitor type does not match CMOS Run SETUP	The monitor does not match the SETUP entries. Adapt the SETUP entries to the monitor.
System time-out	Hardware error. Contact your technical support team.
Real-time clock error	Clock chip error. Contact your technical support team.
Keyboard controller error	Keyboard error. Contact your technical support team.

12.2 BIOS beep codes

The following section lists the POST codes relevant to users in the sequence in which they occur: Contact Customer Support for information on all other POST codes.

Display (hex)	Meaning	Description	Remedy
16H	TP_CHECKSUM	BIOS checksum test	Service event
28H	TP_SIZE_RAM	Determine DRAM size	Replace the memory modules
2AH	TP_ZERO_BASE	Set base RAM 64KB to 0	Replace the memory modules
2CH	TP_ADDR_TEST	Check address busses	Replace the memory modules
2EH	TP_BASERAML	BaseRam Low	Replace the memory modules
30H	TP_BASERAMH	BaseRam High	Replace the memory modules
38H	TP_SYS_SHADOW	BIOS is copied to DRAM	Replace the memory modules
3AH	TP_CACHE_AUTO	Determine CPU cache	Exchange CPU
22H	TP_8742-TEST	Test keyboard controller	Check if keyboard is connected or defective
3CH	TP_ADV_CS_CONFIG	Configure the advanced chipset	Test by switching off the hardware components in Setup
49H	TP_PCI_INIT	Initialize the PCI interface	Run a test by disabling the hardware components in Setup, or by removing the expansion modules installed on the bus module
55H	TP_USB_INIT	Activation of the USB hardware	Removal of USB devices
4AH	TP_VIDEO	Initialize the video interface	
5CH	TP_MEMORY_TEST	Test of the system memory	Replace the memory modules
60H	TP_EXT_MEMORY	Test of the complete memory	Replace the memory modules
62H	TP_EXT_ADDR	Test of the address busses	Replace the memory modules
90H	TP_FDISK	Initialization and test of the hard disk hardware	Disconnect hard disk, replace if necessary
95H	TP_CD	Initialization and test of the CD hardware	Disconnect CD ROM, replace if necessary
98H	TP_ROM_SCAN	Search for BIOS expansions	Run a test by disabling the hardware components in Setup, or by removing the expansion modules installed on the bus module
BCH	TP_PARITY	Test of the memory modules	Replace the memory modules
00H		BIOS Power On Self Test completed. Loading operating system	

Special codes

The following Beep codes are available in addition to the listed POST codes:

- **3 x short** INSERT key is pressed at system startup:
If an external graphics card on the bus board is not detected, you can try to activate it by pressing the INSERT key.
The "INSERT" key activates special enumerations for activating PCI VGA cards.
- **1 x long 8 x short** Error on reading the MPI system information:
Please contact Customer Support
- **4 x short** MPI firmware has been updated:
This can occur once following a BIOS update.
- **2x short** Error in checksum test of the BIOS:
This can occur following a battery replacement or when the battery is empty.

Troubleshooting/FAQs

13.1 General problems

This chapter provides you with tips on how to localize and troubleshoot frequently occurring problems.

Problem	Possible causes	Remedy
The device is not operational	There is no power supply to the device.	<ul style="list-style-type: none"> • Check the power supply, the network cable and the power plug. • Check if the On/Off switch is in the correct position.
	Device is being operated outside the specified ambient. conditions	<ul style="list-style-type: none"> • Check the ambient conditions. • After transport in cold weather, wait approximately 12 hours before switching on the device.
Windows no longer boots	Settings in the BIOS Setup are incorrect	<ul style="list-style-type: none"> • Check the setting in the BIOS Setup "SATA/PATA Configuration" submenu • Check the setting in the BIOS Setup Boot menu
The external monitor remains dark.	The monitor is switched off.	Switch on the monitor.
	The monitor is in "power save" mode.	Press any key on the keyboard.
	The brightness button has been set to dark.	Increase the screen brightness. For detailed information, refer to the monitor operating instructions.
	The power cord or the monitor cable is not connected.	<ul style="list-style-type: none"> • Check whether the power cord has been properly connected to the monitor and to the system unit or to the grounded shockproof outlet. • Check whether the monitor cable has been properly connected to the system unit and to the monitor.
		If the monitor screen still remains dark after you have performed these checks, please contact your technical support team.
The mouse pointer does not appear on the screen.	The mouse driver is not loaded.	Check if the mouse driver is correctly installed.
	The mouse is not connected.	<p>Check whether the mouse lead is connected to the system unit. If you are using an adapter or extension for the mouse lead, check the connectors.</p> <p>Should the mouse cursor still not be visible on-screen after completing these checks and measures, contact technical support.</p>
Wrong time and/or date on the PC.		<ol style="list-style-type: none"> 1. Press <F2> during the boot sequence to open BIOS Setup. 2. Set the time and date in the setup menu.

13.2 Problems when Using Modules of Third-party Manufacturers

Problem	Possible causes	Remedy
Although the BIOS setting is OK, the time and data are still wrong.	The backup battery is dead.	Replace the backup battery.
USB device not responding.	The USB ports are disabled in your BIOS.	Use a different USB port or enable the port.
	USB 2.0 device connected but USB 2.0 is disabled.	Enable USB 2.0.
	Operating system does not support the USB port.	Enable USB Legacy Support for the mouse and keyboard. For other devices you need the USB drivers for the respective operating system.
DVD: The front loader does not open.	The device is switched off or the open/close button is disabled by a software application.	Emergency removal of the data medium: <ol style="list-style-type: none"> 1. Switching off the device 2. Insert a pointed object, a pin for example, or an opened paper clip into the emergency extraction opening of the drive. Apply slight pressure to the contact until the front loader opens. 3. Pull the loader further out.

13.2 Problems when Using Modules of Third-party Manufacturers

Problem	Possible cause	Remedy
The PC crashes during startup	<ul style="list-style-type: none"> • Double allocation of I/O addresses • Double allocation of hardware interrupts and/or DMA channels • Signal frequencies or signal levels are incorrect. • Connector assignments deviate. • No "Reset Configuration" in BIOS Setup 	Check your computer configuration: <ul style="list-style-type: none"> • If the computer configuration corresponds with factory state, please contact your technical support team. • If the computer configuration has changed, restore the original factory settings. Remove all third-party modules, then restart the PC. If the error no longer occurs, the third-party module was the cause of the fault. Replace this module with a Siemens module or contact the module supplier. • Force a "Reset Configuration" using the BIOS Setup. If the PC still crashes, contact your technical support team.
	<ul style="list-style-type: none"> • If the performance of the external 24 V power supply is insufficient 	<ul style="list-style-type: none"> • use a larger power supply.

13.3 Display a temperature fault by means of the SOM application

Cause

Temperature errors do not occur during the normal approved use of the device. If the SOM application indicates a temperature error and the "SOM" symbol in the status display changing from green to red, check the following:

- Are the fan apertures covered?
- If the fan has failed (check speed display in the SOM)?
- Is the ambient temperature higher than the allowed value (see technical data)?
- Is the total output of the power supply within the specified limit?
- Are the heatsinks inside the PC covered with dust?

Remedy

The temperature fault is stored until the temperature drops back below the temperature threshold and you acknowledge the error message in the SOM application.

- Click on the button with the "small broom" icon.
When the error message has been acknowledged, the "TEMP" LED goes out, the title bar changes in the SOM application and the "SOM" symbol in the status bar changes from red to green.
- Restart the PC, if you have not installed the SOM application.

13.3 Display a temperature fault by means of the SOM application

Specifications

14.1 General Specifications

General specifications	
Order numbers	6ES7647-6B...
Dimensions	Without DVD burner: 297x267x80 (WxHxD in mm) With DVD burner: 297x267x100
Weight	approx. 7 kg
Supply voltage (AC)	Nominal 100 - 240 V AC (-15% / +10%) (autorange)
Supply voltage (DC)	Nominal 24 V DC (-15% / + 20%), SELV
Input current AC	Continuous current up to 2.3 A (on start-up, up to 50A for 1 ms)
Input current DC	Continuous current to 8 A (to 14 A for 30 ms at startup)
Line voltage frequency	50 - 60 Hz (47 to 63 Hz)
Transient current interruption according to Namur	max. 20 ms (with 93 to 264 V) (max. 10 events per hour; min. recovery time 1 s)
max. power consumption AC and DC	Effective power 190 W / 210 W Apparent power 250 VA/275 VA
max. current output	+5 V / 16.5 A * (18.5 W peak) +3.3 V / 8.5 A * * total of 90 W permitted +12 V / 6.5 A (8 A peak) -12 V / 0.3 A The total sum of all voltages is max. 150 W.
Noise emission	< 55 dB(A) according to DIN 45635-1
Degree of protection	IP 20
Safety	
Protection class	Protection class I to IEC 61140
Safety regulations	AC: EN 60950-1; UL60950-1; CAN/CSA C22.2 No 60950-1-03 DC: EN 61131-2; UL508; CSA C22.2 No 142

Specifications

14.1 General Specifications

General specifications	
Electromagnetic compatibility (EMC)	
Emitted interference	EN 55022 Class B, EN 61000-3-2 Class D EN 61000-3-3; FCC Class A
Noise immunity: Mains borne disturbance variables on supply lines	± 2 kV, (according to IEC 61000-4-4; Burst) ± 1 kV; (according to IEC 61000-4-5; Surge sym) ± 2 kV; (according to IEC 61000-4-5; Surge asym)
Noise immunity on signal lines	± 1 kV; (according to IEC 61000-4-4; Burst; Length < 3 m) ± 2 kV; (according to IEC 61000-4-4; Burst; Length > 3 m) ± 2 kV; (according to IEC 61000-4-5; Surge; Length > 30 m)
Immunity to discharges of static electricity	± 6 kV contact discharge (according to IEC 61000-4-2) ± 8 kV air discharge (according to IEC 61000-4-2)
Immunity to RF interference	10 V/m 80 to 1000 MHz and 1.4 to 2 GHz, 80% AM (according to IEC 61000-4-3) 1 V/m 2 - 2.7 GHz, 80% AM (according to IEC 61000-4-3) 10 V 10 KHz to 80 MHz; (according to IEC 61000-4-6)
Magnetic field	100 A/m, 50 Hz (to IEC 61000-4-6)
Climatic conditions	
Temperature - Operation * - Storage/transport - Gradient	Tested according to IEC 60068-2-1, IEC 60068-2-2, IEC 60068-2-14 +5° to +45° C +5° to +50° C (with a total sum of max. 20 W for the slots) +5° to +55° C (with a total sum of max. 10 W for the slot) - 20° C to +60° C max. 10° C/h in operation, 20° C/h storage, no condensation
Relative humidity - Operation - Storage/transport	tested to IEC 60068-2-78, IEC 60068-2-30 5% to 80% at 25° C (no condensation) 5% to 95 % at 25° C (no condensation)
Atmospheric pressure - Operation* ⁶ - Storage / transport	1080 to 795 hPa (corresponds to an altitude of -1000 to 2000 m) 1080 to 660 hPa (corresponds to an altitude of -1000 to 3500 m)
Mech. ambient conditions	
Vibration - in operation * ² , * ³ - storage/transport	tested to DIN IEC 60068-2-6 10 to 58 Hz: 0,075 mm, 58 to 500 Hz: 9.8 m/s ² 5 to 9 Hz: 3.5 mm, 9 to 500 Hz: 9.8 m/s ²
Shock resistance - in operation * ³ - storage / transport	Tested to IEC 60068-2-27, IEC 60068-2-29 50 m/s ² , 30 ms, 250 m/s ² , 6 ms
Special features	
Quality assurance	to ISO 9001

General specifications	
Motherboard	
Chip set	<ul style="list-style-type: none"> • Intel® 945GM • Intel® 82801 FR SATA RAID Controller
Processor	<ul style="list-style-type: none"> • Celeron M 440 1.86 GHz, 533 MHz Front Side Bus (FSB), 1024 KB Second Level Cache or • Pentium M T5500 / T7400 1.66 or 2.16 GHz, Dual Core, 667 MHz Front Side Bus, 2048/4096 KB Second Level Cache
RAM	2 sockets maximum 4 GB SDRAM DDR2 533 MHz See order documentation for expansion memory
Backup memory	2 MB SRAM, 128 KB can be backed up in the buffer time
Free expansion slots	1 x PCI 265 mm long and 1x PCI 175 mm long 1 x PCI 265 mm long and 1x PCI Express x4 175 mm long
Max. permissible power consumption per PCI/PCIexpress slot	5 V/ 2 A or 3.3 V/ 2A, 12 V/ 0.3 A, -12 V/ 0.05 A The accumulated power consumption (all slots) may not exceed 30 W
Disk drives	
Hard disk	3.5" / 2.5" serial ATA, see order documentation for the hard disk capacity - 3 Gbps data transmission rate - supports NCQ (Native Command Queuing; SATA II property)
DVD burner *2	ATA 33, See order documentation for features
Graphics	
Graphic controller	Intel® GMA950 Graphics Controller, 2-D and 3-D engine integrated in chipset
Graphics memory	Dynamic Video Memory Technology (uses up to 128 MB of RAM)
Resolutions/frequencies/colors	CRT: Max. 1280x1024 at 100 Hz / 32-bit color depth Max. 1600x1200 at 60 Hz / 32-bit color depth Maximum resolution: 2038x1536 at 75 Hz / 16-bit color depth LCD via DVI-I: Max. 1600x1200 at 60 Hz / 32-bit color depth

Specifications

14.1 General Specifications

General specifications	
Ports	
DVI-I	Port for external CRT / LCD monitor
USB	External: 4x USB 2.0 on the port side (max. 2 can be simultaneously operated as high current) Internal: 2x USB 2.0 (1x high current, 1x low current) Front panel ports: 1x USB 2.0 high current 1x USB 1.1 high current
PROFIBUS / MPI interface ^{*4} - Transmission speed - Operating mode - Physical interface - Memory address space - Interrupts	9-pin Cannon socket 9.6 Kbps to 12 Mbps, software-selectable potential isolation: - Data lines A, B - Control lines RTS AS, RTS_PG - 5 V supply voltage (max. 90 mA) ground connection: - DP12 connector cable shield RS485, isolated ^{*5} automatically configured automatically configured
PROFINET ^{*7}	3x RJ45 connection, CP 1616 compatible onboard interface based on ERTEC 400, 10/100 Mbps electrically isolated *
Ethernet	2x Ethernet interface (RJ45), 10/100/1000 Mbps, Intel 82573 L
COM1	Serial port 1 9-pin Cannon socket
Compact Flash	Slot for Compact Flash Card
Status displays on the device	
	DVD/CD access (to CD drive if installed) 2 x7 segment display (for BIOS post codes) 2x two-color alarm LEDs

^{*1} Restrictions for DVD burner: Burner is only permitted with ambient temperatures of +5 °C to +40 °C

^{*2} Limitation with DVD burner drives:
10 to 58 Hz: 0.019 mm / 58 to 500 Hz: 2.5 m/s²
Burner can only be operated in an interference-free environment

^{*3} Restriction for installation with vertical mounting kit
Vibration: 10-58 Hz: 0.0375 mm / 58-500 Hz: 4.9 m/s²
Shock resistance: 25 m/s², 30 ms

^{*4} Optional product variant

^{*5} Electrical isolation within the safety extra-low voltage circuit (SELV)

^{*6} For operation at higher altitudes, derating is required according to the altitude compensation factors specified in EN 60664-1 Table A.2 or the maximum permissible ambient temperature must be reduced by 3.5 K / 500 m

^{*7} For unique labeling, the LAN interfaces are numbered on the enclosure. The operating system numbering may deviate from this.

14.2 Power requirements of the components

Basic device

Components	Voltage			
	+5 V	+3.3 V	+12 V	-12 V
Motherboard	3 A	5.8 A	0.01 A	0.02 A
Core 2 Duo or Celeron M processor	7 A			
Hard diskdrive; 1x 3.5" or Hard disk-drive; 2x 2.5" ¹⁾	0.6 A		0.8 A	
DVD burner drive ¹⁾	0.8 A			
Device fan			0,4 A	
Power supply fan			0,15 A	
Total (base device)	11.4 A	5.8 A	1.36 A	0.02 A
PCI / PCIexpress slots (total)	4 A	²⁾	0.6 A	0.20 A
Front panel port	1.05 A	0.1 A	3.5 A	
Single lines of current (max. permissible)	16.5 A ³⁾	8.5 A ³⁾	6.5 A	0.3 A

Total power (max. permissible)	150 W
---------------------------------------	-------

¹⁾ Depends on the selected device configuration

²⁾ The PCI slots can be operated both 5 V and on 3.3 V at the same power loss.

³⁾ The max. permitted accumulated power of the +5 V and + 3.3 V is 90 W

14.3 AC voltage supply

Specifications

Degree of protection	IP20 (in installed state)
Protection class	VDE 0106

Note

The power supply contains an active PFC (Power Factor Correction) circuit to conform to the EMC guidelines.

Uninterruptible AC power systems (UPS) must supply a sinusoidal output voltage in the normal and buffered mode when used with SIMATIC PCs with an active PFC.

UPS characteristics are described and classified in the standards EN 50091-3 and IEC 62040-3. Devices with sinusoidal output voltage in the normal and buffered mode are identified with the classification "VFI-SS-...." or "VI-SS-....".

Output voltages

Voltage	Max. current
+ 12 V	6,5 A peak 8 A
- 12 V	0.3 A
+ 5 V	16.5 A ¹⁾ Peak 18.5 A
+ 3.3 V	8.5 A ²⁾

1) The max. permitted accumulated power of the +5 V and + 3.3 V is 90 W.

Power Good signal of the AC power supply

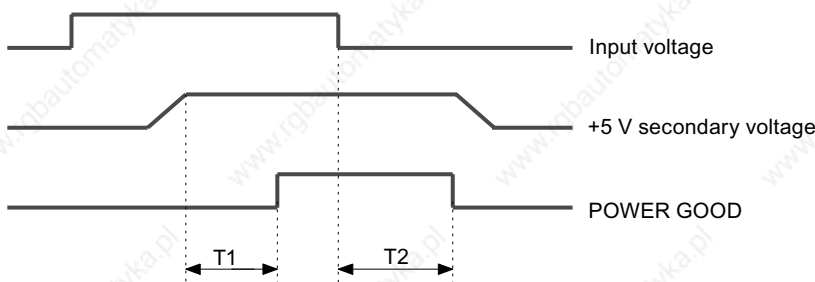

T1: preset time 50 ... 500 ms
 T2: hold-up time 20 ms minimum

14.4 DC power supply

Specifications

Degree of protection	IP20 (in installed state)
Protection class	VDE 0106

¹⁾ 15 W per PCI slot included

Output voltages

Voltage	Max. current
+ 12 V	6.5 A peak 8 A
- 12 V	0.3 A
+ 5 V	16.5 A ¹⁾ Peak 18.5 A
+ 3.3 V	8.5 A ¹⁾

¹ The max. permitted accumulated power of the +5 V and + 3.3 V is 90 W.

Power Good signal of the DC power supply

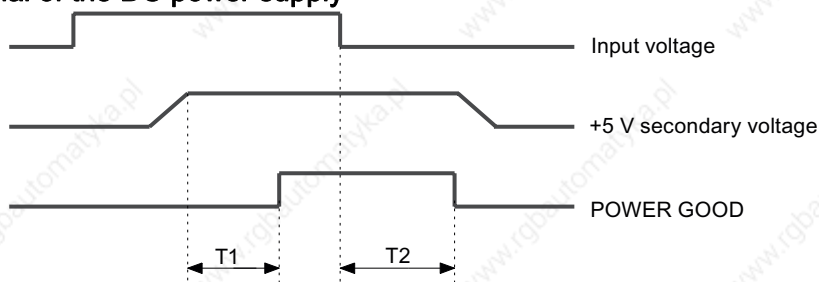

T1: preset time 50 ... 500 ms
T2: hold-up time 20 ms minimum

Specifications

14.4 DC power supply

Dimensional drawings

15.1 Overview of the dimensional drawings

This section contains the following dimension drawings:

- Dimensional drawing of device for mounting with angle bracket
- Dimensional drawing of device for mounting without angle bracket
- Dimensional drawing of device for mounting with the vertical mounting kit
- Dimensional drawings for the installation of expansion modules

Note

The dimensions are always given in in mm and inch (above: Millimeter, below: Inch).

15.2 Dimensional Drawing of the Device

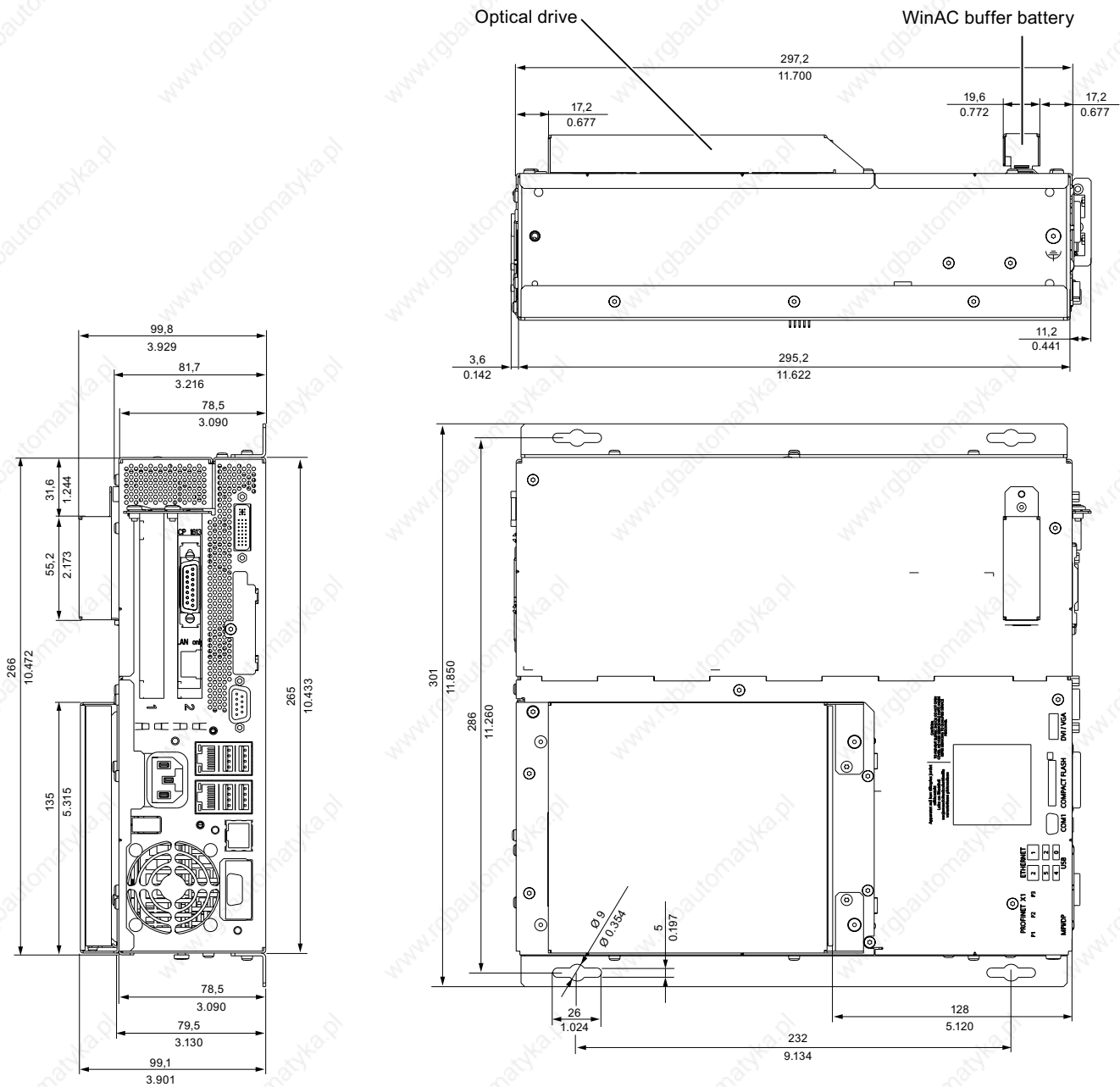

Figure 15-1 Dimensional drawing for mounting with angle bracket

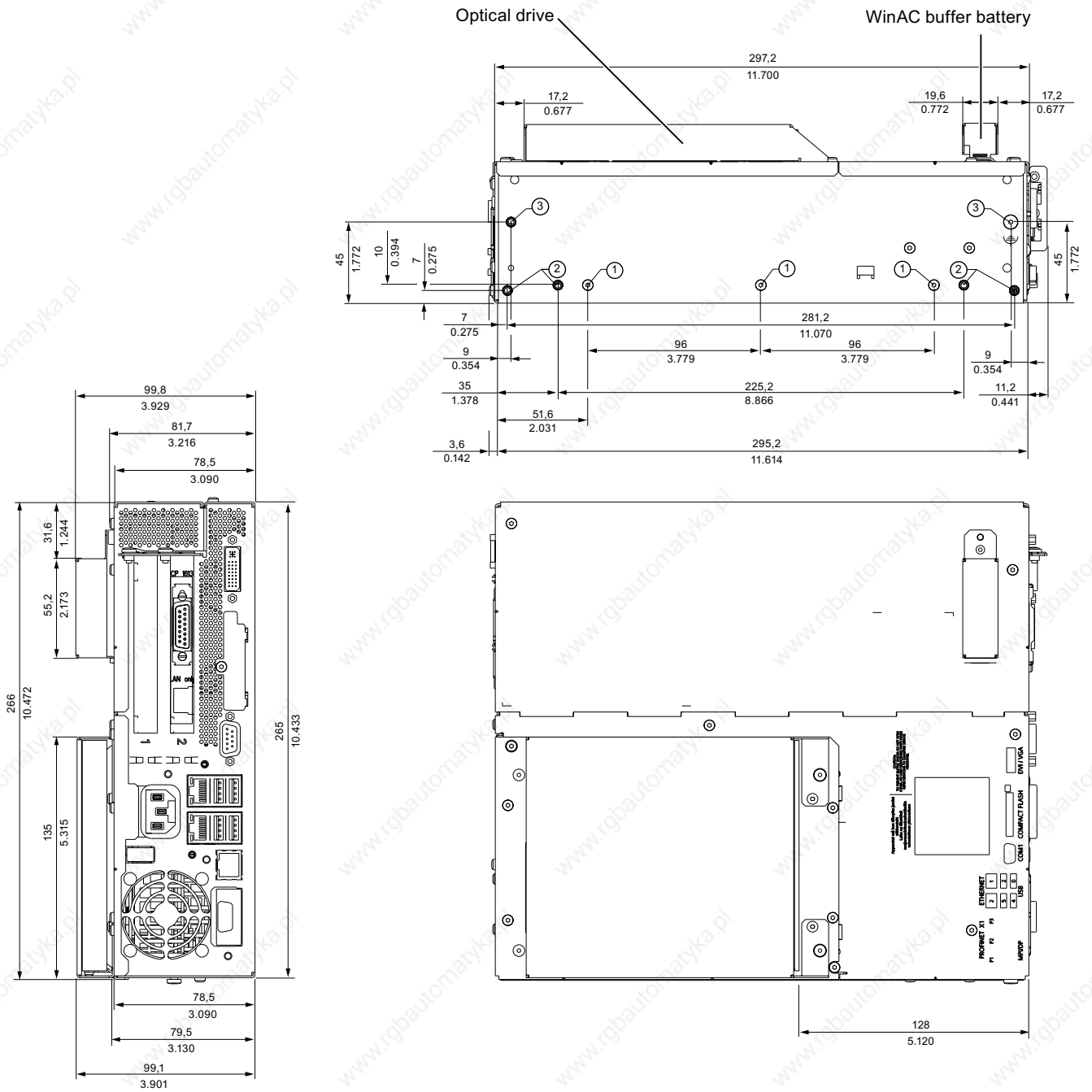

Figure 15-2 Dimensional drawing for mounting without angle bracket

NOTICE
When mounting devices with optical drives or WinAC backup batteries change the fitting depth.

Dimensional drawings

15.2 Dimensional Drawing of the Device

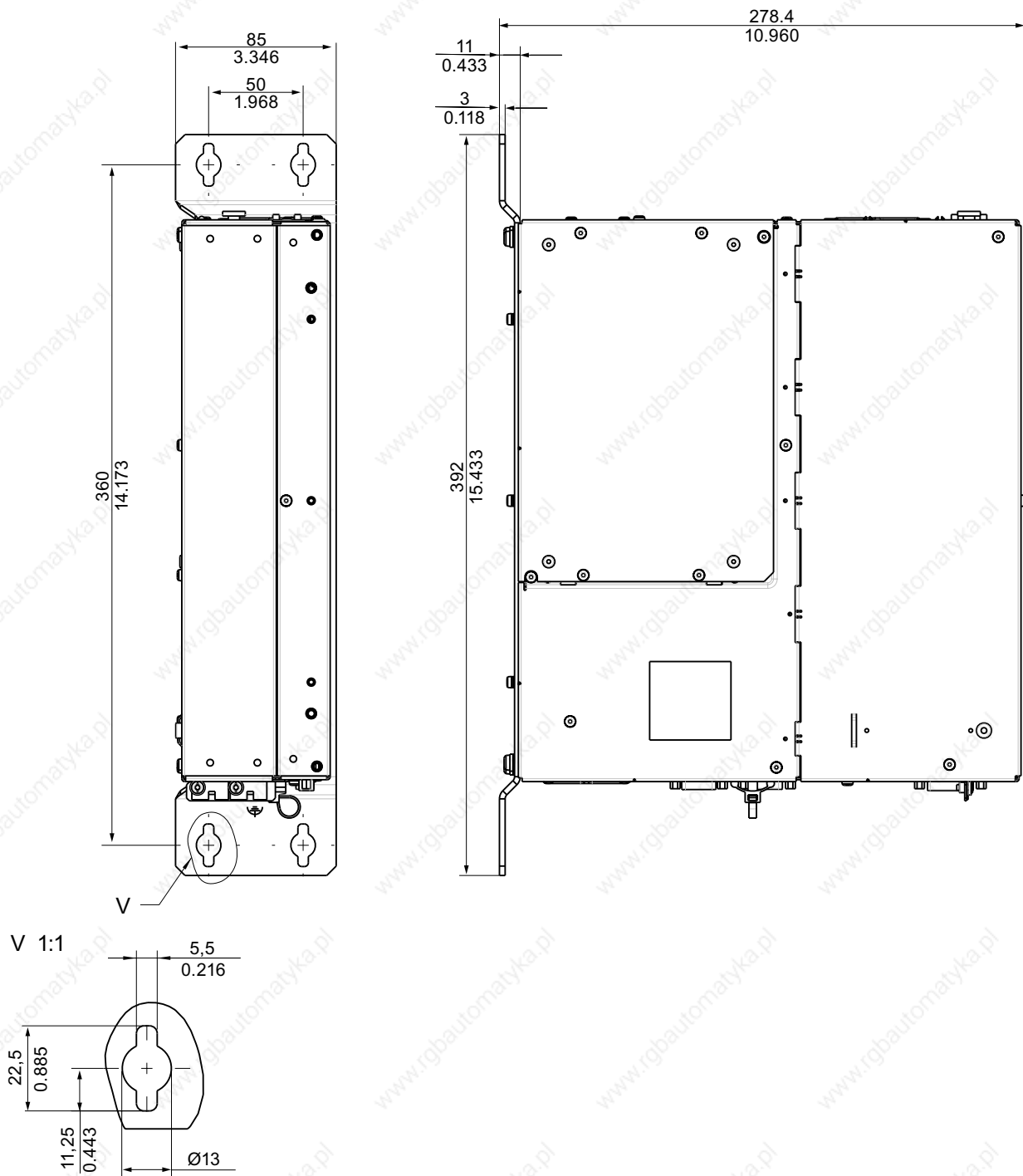

Figure 15-3 Dimensional drawings for vertical mounting (model without DVD burner and without WinAC backup battery)

NOTICE

When mounting devices with optical drives or WinAC backup batteries change the fitting depth.

15.3 Dimensional drawings for the installation of expansion modules

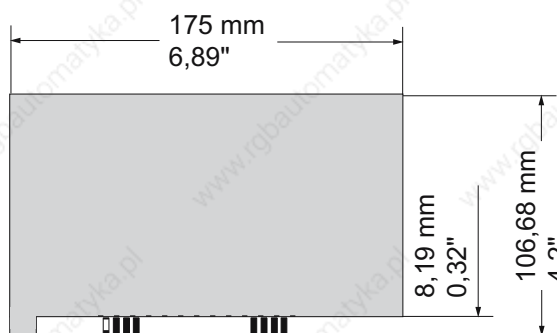

Figure 15-4 Short PCI or PCI Express modules

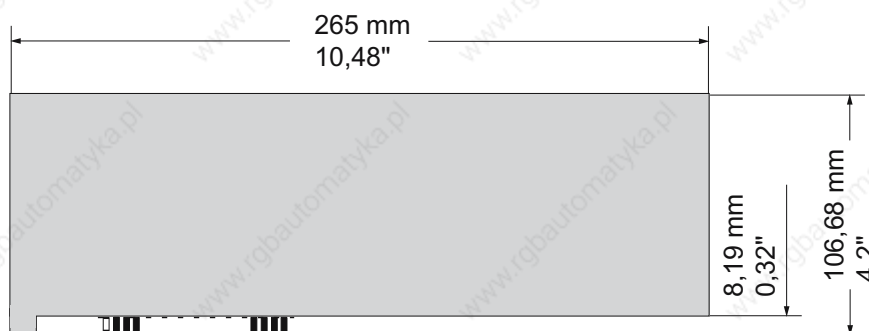

Figure 15-5 Maximum size of PCI module

Detailed descriptions

16.1 Motherboard

16.1.1 Structure and functions of the motherboard

The essential components of the motherboard are the processor and the chip set, two slots for memory modules, internal and external interfaces and the Flash BIOS.

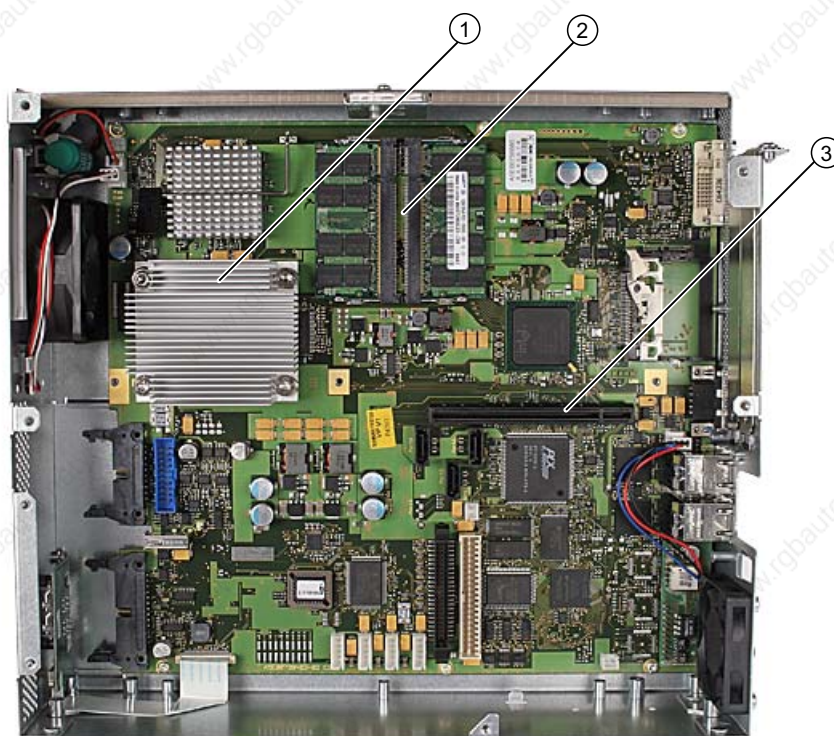

(1)	Processor heat sink
(2)	Two memory module slots
(3)	Slot for the bus board

16.1.2 Technical features of the motherboard

Component / interface	Description	Characteristics
Chip set	Single chip set	<ul style="list-style-type: none"> Intel 945 GM and ICH7R
BIOS	Update by means of software	<ul style="list-style-type: none"> Phoenix BIOS V05.01.xx (with Profibus)
CPU	Intel © Core 2 Duo / Intel © Celeron M	<ul style="list-style-type: none"> Upgradeable Multimedia support Onboard L2 cache with 4096/2048/1024 KB
Memory	2 DIMM module slots, max. 2 GB/DIMM	<ul style="list-style-type: none"> 64-bit data bus width 3.3 V SDRAM DDR2 Up to 2048 Mbit chip size on the module 533/667 MHz bus clock ³ 256 MB to 2 GB/DIMM variable
Graphics	integrated in chip set	<ul style="list-style-type: none"> Mobile Intel 945GM Express Chipset Family, compatible with Graphics Media Accelerator 950 VGA: 1600x1200/32-bit color depth/85 Hz DVI-I: 1600x1200/32-bit color depth/60 Hz LCD: 1280x1024/18 bit colors Graphics memory: 8-128 MB, assigned in system memory, 8 Mbytes are reserved. For system memory 128 MB: Additional dynamic assignment of up to 32 MB; for system memory 256 MB - 2 GB: additional dynamic assignment up to 128 MB
Hard disk	2 channels, Serial ATA	<ul style="list-style-type: none"> Serial ATA 3 Mbps
RAID	Onboard Serial ATA	<ul style="list-style-type: none"> Intel 82801 FR SATA RAID controller RAID 0, 1, 0+1
DVD Burner ⁴	Master on parallel ATA interface or connection, Serial ATA	<ul style="list-style-type: none"> UDMA-capable, ATA33
PROFIBUS/MPI ²	Communication port SIMATIC S7	<ul style="list-style-type: none"> Potential isolated ¹ CP 5611 compatible 12 Mbps
PROFINET ²	Communication interface for PROFINET IO applications and SIMATIC installations	<ul style="list-style-type: none"> 10/100 Mbps, electrically isolated ¹ CP 1616 compatible 3 port interface

Component / interface	Description	Characteristics
USB	Universal Serial Bus	<ul style="list-style-type: none">• External: 4x USB 2.0 on the port side (max. 2 can be simultaneously operated as high current)• Internal: 2x USB 2.0 (1x high current, 1x low current)• Front panel ports: 1x USB 2.0 high current, 1x USB 1.1 high current
Ethernet	2x 10BaseT/100Base-TX	<ul style="list-style-type: none">• 10/100/1000 Mbps, electrically isolated¹

¹ Electrically isolated within the safety extra-low voltage circuit (SELV)

² Optional product feature

³ Depends on the CPU type

⁴ Depends on the selected device configuration

16.1.3 Position of the interfaces on the motherboard

Ports

The motherboard of the device features the following interfaces:

- Interfaces for the connection of external devices
- Interfaces for internal components (drives, bus boards etc.)

The figure below shows the location of the internal and external interfaces on the motherboard.

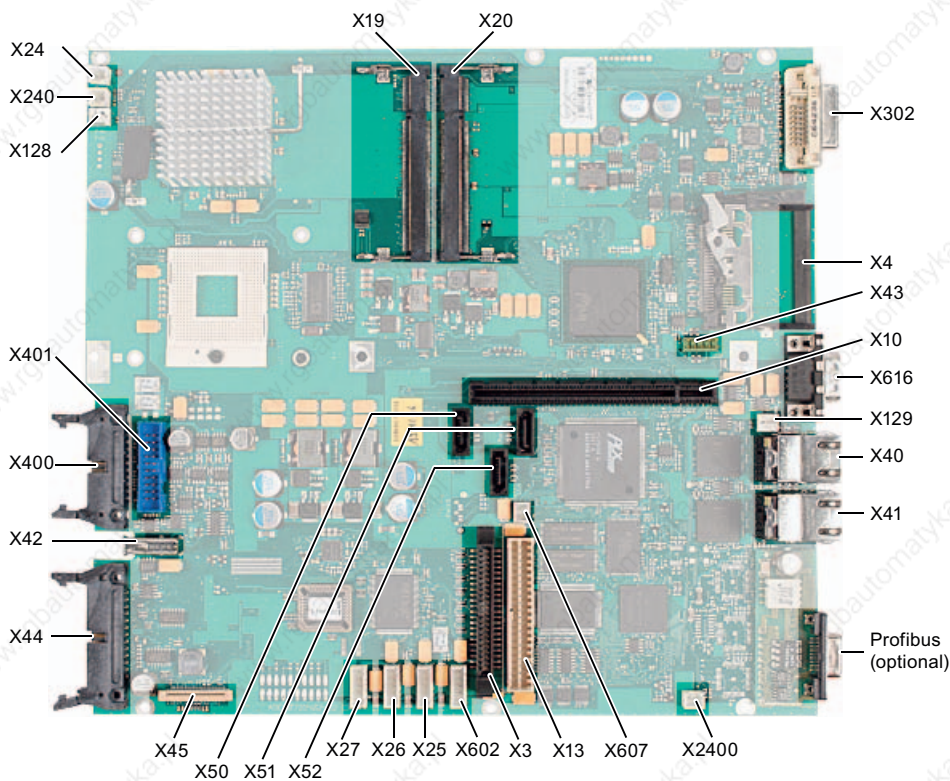

Figure 16-1 Interfaces on the motherboard

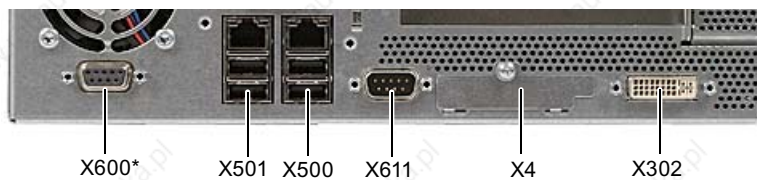

Figure 16-2 Connector pin assignment on the port

* Optional product variant

16.1.4 External ports

Interface	Position	Connector	Description
USB 2.0	external	X40 X41	Lower USB channel 0, upper USB channel 2 Lower USB channel 4, upper USB channel 5
PROFIBUS/MPI	external		9-pin, standard socket, electrically isolated interface
PROFINET	External		Three RJ45 ports
Ethernet	external	X40 X41	First RJ45 port Second RJ45 port
DVI-I	external	X302	26-pin socket
Compact Flash	external	X4	50-pin CF socket, types I / II
COM1	external	X616	Serial port

USB ports, X40, X41

The Universal Serial Bus interfaces have the following pinout:

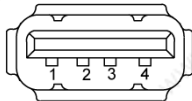
USB interface			
			
Pin no.	Short description	Meaning	Input / output
1	VCC	+ 5 V (fused)	Output
2	- Data	Data channel	Input / output
3	+ Data	Data channel	Input / output
4	GND	Ground	-

The connectors are of type A.

All ports are designed as high current USB (500 mA), you can only use a maximum of 2 simultaneously as high current, however.

CAUTION
No USB devices can be connected which feed back voltage to the Box PC.

PROFIBUS/MPI interface

PROFIBUS/MPI interface ¹			
			
Pinno.	Short description	Meaning	Input / output
1	–	Unassigned	–
2	–	Unassigned	–
3	LTG_B	Signal line B of MPI module	Input/output
4	RTS_AS	RTSAS, control signal for received data stream. The signal is "1" when the directly connected AS is sending.	Input
5	M5EXT	M5EXT return line (GND) of 5 V supply. The current load of an external consumer connected between P5EXT and M5EXT may not exceed the 90 mA.	Output
6	P5 EXT	P5EXT power supply (+5 V) of the 5 V power supply. The current load of an external consumer connected between P5EXT and M5EXT may not exceed the 90 mA.	Output
7	–	Unassigned	–
8	LTG_A	Signal line A of the MPI module	Input/output
9	RTS_PG	RTS output signal of the MPI module. The control signal is "1" when the programming device is sending.	Output
Shield		on connector casing	

¹ Optional product variant

PROFINET LAN X1 Port P1, P2, P3

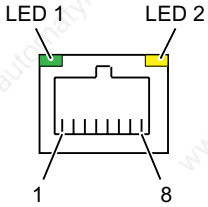
PROFINET interface			
			
Pinno.	Short description	Meaning	Input / output
1	RD+	Receive data *	Input
2	RD-	Receive data *	Input
3	TD+	Transmit data *	Output
4, 5 ¹⁾	SYMR	Internal with 75 Ohm terminating resistor	–
6	TD-	Receive data *	Output
7, 8 ¹⁾	SYMT-	Internal with 75 Ohm terminating resistor	–
S		Shield	
	LED 1	Lit green: link	
	LED 2	Lights up yellow: activity	
* Auto negotiation and auto crossover supported			

Ethernet RJ45 connection, X40, X41

Ethernet RJ45 connection			
<p>The diagram shows a top-down view of an RJ45 connector. It has two LEDs at the top: LED 1 on the left (green) and LED 2 on the right (orange). Below the LEDs are eight pins, with pin 1 on the left and pin 8 on the right. A shield is located at the bottom of the connector.</p>			
Pinno.	Short description	Meaning	Input / output
1	BI_DA+	Bi-directional data A+	Input / output
2	BI_DA-	Bi-directional data A-	Input / output
3	BI_DB+	Bi-directional data B+	Input / output
4	BI_DC+	Bi-directional data C+	Input / output
5	BI_DC-	Bi-directional data C-	Input / output
6	BI_DB-	Bi-directional data B-	Input / output
7	BI_DD+	Bi-directional data D+	Input / output
8	BI_DD-	Bi-directional data D-	Input / output
S		Shield	-
	LED 1	Off: 10 Mbps Lit in green color: 100 Mbps Lit in orange color: 1000 Mbps	-
	LED 2	Lit: Active connection (to a hub, for example) Flashing: Activity	-

DVI-I port, X302

DVI-I port			
Pinno.	Short description	Meaning	Input / output
S	GND	Ground	–
S1	GND	Ground	–
C1	R	Red	Output
C2	G	Green	Output
C3	B	Blue	Output
C4	HSYNC	Horizontal synchronizing pulse	Output
C5	GND	Ground	–
CSA	GND	Ground	–
1	TX2N	TDMS data 2-	Output
2	TX2P	TDMS data 2+	Output
3	GND	Ground	–
4	NC	Unassigned	–
5	NC	Unassigned	–
6	DDC CLK	DDC clock	Input / output
7	DDC CLK	DDC data	Input / output
8	VSYNC	Vertical synchronizing pulse	Output
9	TX1N	TDMS data 1-	Output
10	TX1P	TDMS data 1+	Output
11	GND	Ground	–
12	NC	Unassigned	–
13	NC	Unassigned	–
14	+5 V	+5 V	Output
15	GND	Ground	–
16	MONDET	Hotplug detect	Input
17	TX0N	TDMS data 0-	Output
18	TX0P	TDMS data 0+	Output
19	GND	Ground	–
20	NC	Unassigned	–
21	NC	Unassigned	–
22	GND	Ground	–
23	TXCP	TDMS clock +	Output
24	TXCN	TDMS clock -	Output

Compact Flash card, X4

Compact Flash card port		
Pin no.	Short description	Meaning
41	RESET#	Reset (output)
7	CS0#	Chip select 0(output)
32	CS1#	Chip select 1(output)
34	IORD#	I/O read (output)
35	IOWR#	I/O write (output)
20, 19, 18,	A0-A2	Address bit 0-2 (output)
17, 16, 15, 14, 12, 11, 10, 8	A3-A10	Address bit 3-10 (output) to ground
21, 22, 23, 2, 3, 4, 5, 6, 47, 48, 49, 27, 28, 29, 30, 31	D0-D15	Data bits 0-15 (in/out)
37	INTRQ	Interrupt request (input)
9	OE# /ATA SEL#	Enables True IDE mode
24	IOCS16#	I/O-chip select 16 (input)
39	CSEL#	Cable select (output)
42	IORDY	I/O ready (input)
46	PDIAG#	Passed diagnostic
45	DASP#	Drive active/slave present (not connected)
26, 25	CD1#, CD2#	Card detect (not connected)
33, 40	VS1#, VS2#	Voltage sense (not connected)
43	DMARQ	DMA request (input)
44	DMACK#	DMA acknowledge (output)
36	WE#	Write enable
1, 50	GND	Ground
13, 38	VCC	+ 3.3V power

Serial port COM 1, X616

The COM1 serial port has the following pin assignment:

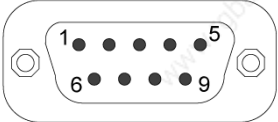
Serial interface COM1			
			
Pinno.	Short description	Meaning	Input / output
1	DCD (M5)	Receive signal (carrier)	Input
2	RxD (D2)	Receive data	Input
3	TxD (D1)	Transmit data	Output
4	DTR (S1)	Data terminal ready	Output
5	GND (E2)	Functional ground (reference potential)	–
6	DSR (M1)	Ready for operation	Input
7	RTS (S2)	Request to send	Output
8	CTS (M2)	Clear to send	Input
9	RI (M3)	Incoming call	Input

16.1.5 Front ports

Overview

Port	Position	Connector	Description
Display (LVDS)	Internal	X400	Connection of LCD displays with LVDS interface (channel 1)
Display (LVDS)	Internal	X401	Connection of LCD displays with LVDS interface (channel 2)
I/O front	Internal	X44	Ports for front I/O, including USB channel 1
USB	Internal	X42	Internal USB 2.0 interface (USB channel 3)

Display interfaces

TFT displays with an LVDS interface can be connected to this interface. You can connect 18-bit displays with a resolution up to 1024 x 768 pixels on X400 only (single-channel LVDS), and of 1280 x 1024 pixels on X400 and X401 (dual-channel LVDS). On the X401, there is also +12 V as supply voltage for the backlight inverter (max. 4.2 A) for 19" / Dual Channel LVDS displays. The permitted display clock rate is 20 MHz to 66 MHz. The display is selected automatically based on the code of the display select inputs.

The display power supply voltages 3.3 V and 5 V are switched via the graphic controller depending on the requirements of the connected display units. The maximum cable length is 50 cm at a transmission rate of 455 MHz. Special cable properties are required for the differential cable pairs specified by the LVDS specification.

Display interface (1st LVDS channel), X400

Pin no.	Short description	Meaning	Input / output
1	P5V_D_fused	+5V (fused) display VCC	Output
2	P5V_D_fused	+5V (fused) display VCC	Output
3	RXIN0-	LVDS output signal bit 0 (-)	Output
4	RXIN0+	LVDS output signal bit 0 (+)	Output
5	P3V3_D_fused	+3.3V (fused) display VCC	Output
6	P3V3_D_fused	+3.3V (fused) display VCC	Output
7	RXIN1-	LVDS output signal bit 1 (-)	Output
8	RXIN1+	LVDS output signal bit 1 (+)	Output
9	GND	Ground	-
10	GND	Ground	-
11	RXIN2-	LVDS output signal bit 2 (-)	Output
12	RXIN2+	LVDS output signal bit 2 (+)	Output
13	GND	Ground	-
14	GND	Ground	-
15	RXCLKIN-	LVDS clock signal (-)	Output

Pin no.	Short description	Meaning	Input / output
16	RXCLKIN+	LVDS clock signal (+)	Output
17	GND	Ground	-
18	GND	Ground	-
19	NC	Unassigned	-
20	NC	Unassigned	-

Display interface (2nd LVDS channel), X401

Pin no.	Short description	Meaning	Input / output
1	GND	Ground	-
2	GND	Ground	-
3	RXIN10-	LVDS input signal bit 0 (-)	Output
4	RXIN10+	LVDS input signal bit 0 (+)	Output
5	GND	Ground	Output
6	GND	Ground	Output
7	RXIN11-	LVDS input signal bit 1 (-)	Output
8	RXIN11+	LVDS input signal bit 1 (+)	Output
9	GND	Ground	-
10	GND	Ground	-
11	RXIN12-	LVDS input signal bit 2 (-)	Output
12	RXIN12+	LVDS input signal bit 2 (+)	Output
13	GND	Ground	-
14	GND	Ground	-
15	RXCLKIN1-	LVDS clock signal (-)	Output
16	RXCLKIN1+	LVDS clock signal (+)	Output
17	GND	Ground	-
18	P12VF	+12V fused	Output
19	P12VF	+12 V fused	Output
20	P12VF	+12 V fused	Output

Assignment of the display to the display select pins

One of the 15 available displays is configured automatically via the display select inputs. The display select inputs are connected to pull-up resistors, i.e. if these inputs are not interconnected, they are high level. The input must be connected to ground to generate a low level.

Pin no.	LCD_SEL3	LCD_SEL2	LCD_SEL1	LCD_SEL0	Display type
0	low	low	low	low	reserved
1	low	low	low	high	1280 x 1024 (SXGA), TFT, 2 x 18-bit, LVDS channel 1 and 2
2	low	low	high	low	DVI LCD 640 x 480
3	low	low	high	high	DVI LCD 800 x 600
4	low	high	low	low	640 x 480 (VGA), TFT, 18 bits, LVDS channel 1
5	low	high	low	high	reserved
6	low	high	high	low	1024 x 768 (XGA), TFT, 18 bits, LVDS channel 1
7	low	high	high	high	800 x 600 (SVGA), TFT, 18 bits, LVDS channel 1
8	high	low	low	low	reserved
9	high	low	low	high	reserved
10	high	low	high	low	reserved
11	high	low	high	high	reserved
12	high	high	low	low	1024 x 768 (XGA), TFT, 2 x 18-bit, LVDS channel 1 and 2
13	high	high	low	high	DVI LCD 1024 x 768
14	high	high	high	low	DVI LCD 1280 x 1024
15	high	high	high	high	No LVDS display or DVI LCD with automatic DDC ID

I/O front port for operator panels, X44

This port carries all signals required for connecting operator panels in addition to the display interface. The maximum cable length is 50 cm at a USB data rate of 12 Mbps.

Pin no.	Short description	Meaning	Input / output
1	GND	Ground	-
2	P12V	Inverter voltage supply	Output
3	BL_ON	Backlight on (5 V = On)	Output
4	P5V_fused	+5 V (fused)	Output
5	GND	Ground	-
6	P3V3_fused	+3.3 V VCC (fused)	Output
7	Reserved	Reserved	-
8	Reserved	Reserved	-
9	Reserved	Reserved	-
10	Reserved	Reserved	-
11	P5V_fused	+5 V (fused)	Output
12	USB_D1M	USB data channel 1	Input / output
13	USB_D1P	USB data+, channel 1	Input / output
14	GND	Ground	-
15	LCD_SEL0	Display Type-Select Signal 0	Input
16	LCD_SEL1	Display Type-Select Signal 1	Input
17	LCD_SEL2	Display Type-Select Signal 2	Input
18	LCD_SEL3	Display Type-Select Signal 3	Input
19	RESET_N	Reset signal (active low)	Input
20	reserved	Reserved	-
21	HD_LED	HD LED, anode with 1 kOhm in series on the motherboard	Output
22	DP_LED	MPI/DP LED, anode via 1 kOhm in series on the motherboard	Output
23	Ethernet_LED	Ethernet LED, anode with 1 kOhm in series on the motherboard	Output
24	TEMP_ERR	Temperature error LED, anode with 1 kOhm in series on the motherboard	Output
25	RUN_R	Watchdog error LED, anode with 1 kOhm in series on the motherboard	Output
26	RUN_G	Watchdog OK LED, anode with 1 kOhm in series on the motherboard	Output

Detailed descriptions

16.1 Motherboard

Pin Assignment of the USB 2.0 interface, X42

Pin no.	Short description	Meaning	Input / output
1	VCC	+ 5 V, fused	Output
2	USB5	USB5_M	Input / output
3	USB5	USB5_P	Input / output
4	GND	Ground	-
S1	S	Shield	-
S2	S1	Shield	-

Note

For detailed information on the pin assignments of the interfaces, please contact Customer Support or the Repair Center.

16.1.6 Internal interfaces

Pin assignment of the internal ports

Interface	Position	Connector	Description
Memory	Internal	X19, X20	2 DIMM sockets, 64-bit
Processor	Internal	X1	Socket for FCPGA processor
Bus expansion	Internal	X10	Socket for bus expansion, assigned PCI bus signals
Power supply	Internal	X13	20-pin connector plug for power supply
Hard disk drive Serial ATA	Internal	X50, X51	Serial ATA, max. 2 drives operable
Optical drive Serial ATA	Internal	X52	Serial ATA, max. 1 drive operable
Connection for PS serial ATA	Internal	X25, X26, X27, X602	Voltage supply for serial ATA
Optical drive Parallel ATA	Internal	X3	44-pin, 2 mm male connector
Connection for PS fan	Internal	X129	Voltage supply for CPU fan, 3-pin male connector
Connection for equipment fan	Internal	X128	Voltage supply for equipment fan, 3-pin male connector
Backup battery	Internal	X24	Voltage supply for backup battery, 2-pin male connector
Tap for backup battery	Internal	X240, X2400	Voltage tap (= 3V) of the backup battery, 2-pin, male connector
USB interface	Internal	X43	USB channel 6 and 7

Connection for optical drive, X3

Pin no.	Short description	Meaning	Input / Output
1	Reserved	Reserved	-
2	Reserved	Reserved	-
3	Reserved	Reserved	-
4	GND	Ground	-
5	Reset	Reset signal	Input / Output
6	D8	Data signal D8	Input / Output
7	D7	Data signal D7	Input / Output
8	D9	Data signal D9	Input / Output
9	D6	Data signal D6	Input / Output
10	D10	Data signal D10	Input / Output
11	D5	Data signal D5	Input / Output
12	D11	Data signal D11	Input / Output
13	D4	Data signal D4	Input / Output
14	D12	Data signal D12	Input / Output

Detailed descriptions

16.1 Motherboard

Pin no.	Short description	Meaning	Input / Output
15	D3	Data signal D3	Input / Output
16	D13	Data signal D13	Input / Output
17	D2	Data signal D2	Input / Output
18	D14	Data signal D14	Input / Output
19	D1	Data signal D1	Input / Output
20	D15	Data signal D15	Input / Output
21	D0	Data signal D0	Input / Output
22	DREQ	DMA request	Input
23	GND	Ground	-
24	IOR_N	Read signal	Output
25	IOW_N	Write signal	Output
26	GND	Ground	-
27	IORDY	Ready signal	Input
28	DACK_N	DMA acknowledgment	Output
29	IRQ15	Interrupt signal	Input
30	AD_1	Address 1	Output
31	AD_0	Address 0	Output
32	AD_2	Address 2	Output
33	CS_N	Chip select signal	Output
34	HDACT_N	Activity	Input
35	CS1_N	Chip select 1	-
36	CSEL	Chip select signal	-
37	GND	Ground	-
38	P5V	+5 V voltage supply	Output
39	P5V	+5 V voltage supply	Output
40	P5V	+5 V voltage supply	Output
41	P5V	+5 V voltage supply	Output

Pin assignment of the equipment fan, X128

Pin no.	Short description	Meaning	Input / output
1	GND	Ground	-
2	+12 V	Switched voltage supply	Output
3	CPU FAN_CLK	Clock signal	Input

Pin assignment of the supply for the power supply fan, X129

Pin no.	Short description	Meaning	Input / output
1	GND	Ground	-
2	+12 V	Switched voltage supply	Output
3	PG1 FAN_CLK	Clock signal	Input

Connection for backup battery, X24 (BATT)

A battery for buffering the CMOS RAM is connected to this connector. This is a 3 V Lithium battery with a capacity of 750 mAh.

Pin no.	Short description	Meaning	Input / output
1	+	Plus pole	Input
2	-	Minus pole	-

Tap of the backup battery, X240, X2400 (OUT)

This connection is intended for expansion modules with on-board CMOS-RAM. The voltage of the backup battery can be tapped here to backup the CMOS RAM data of the expansion module.

Pin no.	Short description	Meaning	Input / output
1	+	Plus pole	Output
2	-	Minus pole	-

NOTICE

No battery should be connected to this connection.

Pin assignment of the supply for the serial ATA drives X25, X26, X27, X602

Pin no.	Short description	Meaning	Input / output
1	+12 V	Voltage supply	Output
2	GND	Ground	-
3	GND	Ground	-
4	+5 V	Voltage supply	Output
5	+3.3 V	Voltage supply	Output

Pin assignment of the internal USB interface connector, X43

Pin no.	Short description	Meaning	Input / output
1	VCC 3.3V	+3.3V, fused	Output
2	VCC 5V	+ 5 V, fused	Output
3	USB3	USB3_M	Input / output
4	USB5	USB5_M	Input / output
5	USB3	USB3_P	Input / output
6	USB5	USB5_P	Input / output
7	GND	Ground	–
8	GND	Ground	–
9	GND	Ground	–
10	GND	Ground	–

16.2 Bus board

16.2.1 Layout and principle of operation

The bus board is designed as a link between the motherboard and the expansion modules. It is secured with two screws.

Two models of the bus board are available:

Variant 1 has two PCI slots (1x short, 1x long). It can host expansion modules conforming to PCI specification (Rev. 2.2) for 5 V and 3.3 V modules. All PCI slots are master compatible. The expansion modules are supplied with power via the bus board to motherboard connection.

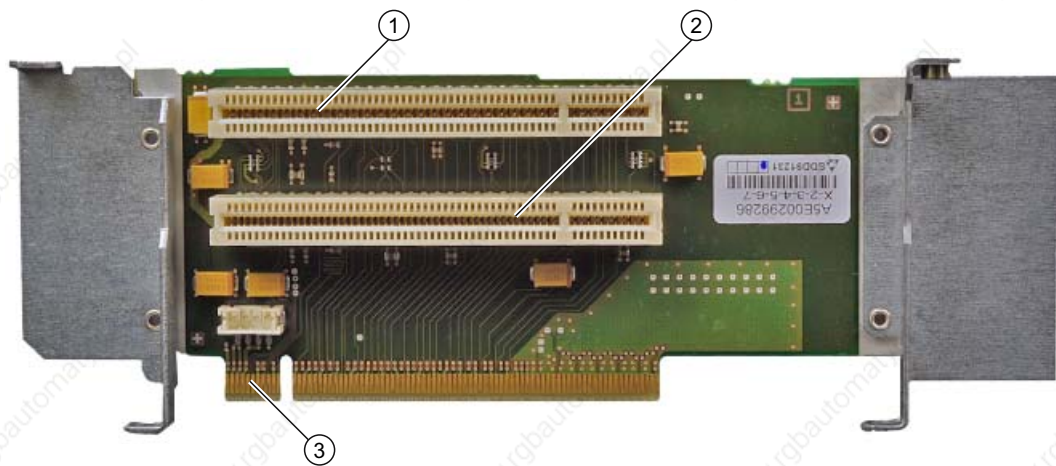

(1)	Slot 1
(2)	Slot 2
(3)	12V power supply connection for WinAC module

Variant 2 has one PCI and one PCI Express slot.

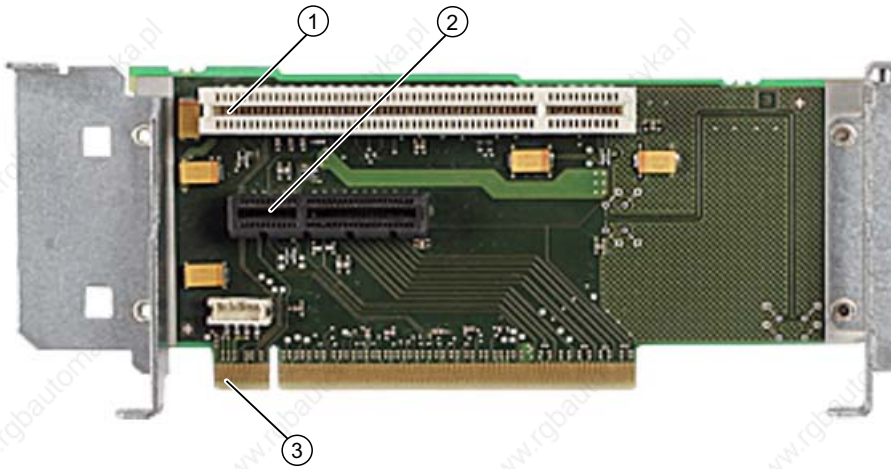

(1)	Slot 1 PCI
(2)	Slot 2 PCI Express x4
(3)	12V power supply connection for WinAC module

16.2.2 PCI slot pin assignment

	5V System Environment	
	Side B	Side A
1	-12V	TRST#
2	TCK	+12V
3	Ground	TMS
4	TDO	TDI
5	+5V	+5V
6	+5V	INTA#
7	INTB#	INTC#
8	INTD#	+5V
9	PRSNT1#	Reserved
10	Reserved	+5 V (I/O)
11	PRSNT2#	Reserved
12	Ground	Ground
13	Ground	Ground
14	Reserved	Reserved
15	Ground	RST#
16	CLK	+5 V (I/O)
17	Ground	GNT#
18	REQ#	Ground
19	+5 V (I/O)	Reserved
20	AD[31]	AD[30]
21	AD[29]	+3.3V
22	Ground	AD[28]
23	AD[27]	AD[26]
24	AD[25]	Ground
25	+3.3V	AD[24]
26	C/BE[3]#	IDSEL
27	AD[23]	+3.3V
28	Ground	AD[22]
29	AD[21]	AD[20]
30	AD[19]	Ground
31	+3.3V	AD[18]
32	AD[17]	AD[16]
33	C/BE[2]#	+3.3V
34	Ground	FRAME#
35	IRDY#	Ground
36	+3.3V	TRDY#
37	DEVSEL#	Ground

	5V System Environment	
38	Ground	STOP#
39	LOCK#	+3.3V
40	PERR#	SDONE
41	+3.3V	SBO#
42	SERR#	Ground
43	+3.3V	PAR
44	C/BE[1]#	AD[15]
45	AD[14]	+3.3V
46	Ground	AD[13]
47	AD[12]	AD[11]
48	AD[10]	Ground
49	Ground	AD[09]
50	CONNECTOR KEY	
51	CONNECTOR KEY	
52	AD[08]	C/BE[0]#
53	AD[07]	+3.3V
54	+3.3V	AD[06]
55	AD[05]	AD[04]
56	AD[03]	Ground
57	Ground	AD[02]
58	AD[01]	AD[00]
59	+5 V (I/O)	+5 V (I/O)
60	ACK64#	REQ64#
61	+5V	+5V
62	+5V	+5V

16.2.3 Pin assignment 12 V power supply connection for WinAC module

Pin	Short description	Meaning	Input /Output
1	+12 V ¹	12 V voltage	Output
2	GND	Ground	-
3	GND	Ground	-
4	+5 V ¹	5 V voltage	Output

1) max. permissible current: 1 A; with this power demand the total power demand for the PCI slots are not allowed to be exceeded.

16.2.4 PCI Express slot x4 pin assignment

	5V System Environment	
	Side B	Side A
1	P12V	PRSNT1_N
2	P12V	GND
3	P12V	P12V
4	GND	GND
5	SMBCLK	PTCK
6	SMBDAT	PTDI
7	GND	PTDO
8	P3V3	PTMS
9	PTRST_N	P3V3
10	Aux_3V3	P3V3
11	PCIE_Wake_N	PCI RST_N
12	Reserved	GND
13	GND	GND
14	PCIE_TX_P(1)	GND
15	PCIE_TX_N(1)	GND
16	M	PCIE_RX_P(1)
17	PRSNT2_N	PCIE_RX_N(1)
18	GND	GND
19	PCIE_TX_P(2)	Reserved
20	PCIE_TX_N(2)	GND
21	GND	PCIE_RX_P(2)
22	GND	PCIE_RX_N(2)
23	PCIE_TX_P(3)	GND
24	PCIE_TX_N(3)	GND
25	GND	PCIE_RX_P(3)
26	GND	PCIE_RX_N(3)
27	PCIE_TX_P(4)	GND
28	PCIE_TX_N(4)	GND
29	GND	PCIE_RX_P(4)
30	GND	PCIE_RX_N(4)
31	PRSNT2_N	GND
32	GND	Reserved

16.3 System resources

16.3.1 Currently allocated system resources

All system resources (hardware addresses, memory configuration, allocation of interrupts, DMA channels) are assigned dynamically by the Windows OS, depending on the hardware configuration, drivers and connected external devices. You can view the current configuration of system resources or possible conflicts with the following operating systems:

Windows 2000/XP	Start > Run : In the Open dialog, enter <i>msinfo32</i> and confirm with OK
Windows Vista	Start > Enter "cmd" in the search function, then enter "msinfo32" in the input box

16.3.2 System resources used by the BIOS/DOS

The following table describes the system resources for the factory state of the device.

16.3.2.1 I/O address allocation

I/O address (hex)		Size (bytes)	Description of the basic function	Possible alternative function
from	to			
0000	000F	16	DMA controller	
0010	001F	16	Motherboard resources	
0020	0021	2	Programmable interrupt controller	
0022	003F	30	Motherboard resources	
0040	0043	4	System timer	
0044	005F	28	Motherboard resources	
0060	0060	1	Keyboard controller	
0061	0061	1	System loudspeaker	
0062	0063	2	Motherboard resources	
0064	0064	1	Keyboard controller	
0067	006F	9	Motherboard resources	
0070	0075	6	System CMOS/real-time clock	
0076	0080	11	Motherboard resources	
0081	008F	15	DMA controller	
0090	009F	16	Motherboard resources	
00A0	00A1	2	Programmable interrupt controller	
00A2	00BF	30	Motherboard resources	
00C0	00DF	32	DMA controller	
00E0	00EF	16	Motherboard resources	
00F0	00FE	15	Numeric data processor	
0110	016F	96	Not used	
0170	0177	8	Secondary EIDE channel	
0178	01EF	120	Not used	
01F0	01F7	8	Primary EIDE channel	Switchable in Setup, then free
01F8	01FF	8	Not used	
0200	0207	8	Reserved for game port	
0208	02E7	224	Not used	
02E8	02EF	8	Reserved	
02F8	02FF	8	COM2	Switchable in Setup, then free
0300	031F	32	Not used	
0320	032F	16	Not used	

Detailed descriptions

16.3 System resources

I/O address (hex)				
0330	033F	16	Not used	
0340	035F	32	Not used	
0360	0367	8	Not used	
0370	0371	2	SOM	
0372	0375	4	Not used	
0376	0376	1	Secondary EIDE channel	
0378	037F	8	LPT 1	Switchable in Setup, then free
0380	03AF	48	Not used	
03B0	03BB	12	Graphics	
03BC	03BF	4	Reserved	
03C0	03DF	16	Graphics	
03E0	03E7	8	Not used	
03E8	03EF	6	Reserved	
03F0	03F5	6	Standard floppy disk controller	
03F6	03F6	1	Primary EIDE channel	
03F7	03F7	1	Standard floppy disk controller	
03F8	03FF	8	COM1	Switchable in Setup, then free
Dynamic range; resources are managed by means of Plug and Play functionality				
0400	0777	888	Not used	
0778	077F	8	ECP LPT 1	
0780	07FF	128	Not used	
0800	080F	16	ACPI communications range	Fixed
0810	0CFB	1260	PCI configuration index	Fixed
0CFC	0CFF	4	PCI configuration data	Fixed
0D00	0EFF	512	Not used	
0F00	0F4F	80	Super IO	
0F50	0FFF	176	Not used	
1000	10FF	256	Used internally	
1180	11FF	128	Used internally	
1800	187F	128	Used internally	
8800	8BFF	1023	SATA RAID Controller	
8C00	FEFF	29288	Not used for SATA RAID	
8870	8897	39	PATA RAID Controller	
8898	FEFF	30311	Not used for PATA RAID	
1880	886F	28655	Not used	
FF00	FF0F	16	EIDE bus master register	

16.3.2.2 Interrupt Assignments

The functions are assigned different interrupts, depending on the operating system. A distinction is made between the PIC and APIC modes.

X = Interrupt in PIC and APIC mode, Y = Interrupt in APIC mode, Z = BIOS default interrupt in PIC mode (e.g. DOS)

Function	IRQ number																							Comment	
	0	1	2	3	4	5	6	7	8	9	10	11	12	13	14	15	16	17	18	19	20	21	22		23
IRQ (APIC mode)	0	1	2	3	4	5	6	7	8	9	10	11	12	13	14	15	16	17	18	19	20	21	22	23	
IRQ (PIC mode)	0	1	2	3	4	5	6	7	8	9	10	11	12	13	14	15	16	17	18	19	20	21	22	23	
Host PCI IRQ line																	A	B	C	D	E	F	G	H	1)
Function	X																								
Timer output 0		X																							Fixed
Keyboard			X																						Fixed
Cascaded (IRQ9)				X																					Fixed
Serial port 2																									Unassigned
Serial port 1				X																					Can be switched off
FD controller					X																				Only free in ACPI-PIC mode
Parallel port 1																									Unassigned
Real-time clock (RTC)								X																	Fixed
PS/2 mouse											X														Used by mouse emulation
Numeric processor												X													Fixed
HD controller 1 (primary)													X												Can be switched off
HD controller 2 (secondary)															X										Can be switched off
SATA																									Can be switched off
USB PORT 0/1							Z																	Y	Can be switched off
USB Port 2/3							Z																	Y	Cannot be disabled
USB Port 4/5							Z																Y		Cannot be disabled
USB 2.0 Controller							Z																Y		Cannot be disabled
Ethernet 1				Z													Y								Can be switched off
Ethernet 2																	Y		Y						Can be switched off
VGA																									Can be switched off
Profibus or Profinet						Z														Y					Can be switched off

1) Host PCI IRQs A to H are assigned fixed IRQs 16-23 in APIC mode.
 Host PCI IRQs A to H are automatically assigned IRQs 0-15 in PIC mode by BIOS; a specified order cannot be forced.

Figure 16-3 Interrupt assignment in PIC mode

Y= Interrupt in APIC mode, Z= BIOS default interrupt in PIC mode (e.g. DOS)

Function	IRQ number																							Comment									
	0	1	2	3	4	5	6	7	8	9	10	10	11	11	12	12	13	13	14	14	15	15	16		17	18	19	20	21	22	23		
ACPI IRQ	0	1	2	3	4	5	6	7	8	9	10	10	11	11	12	12	13	13	14	14	15	15	A	B	C	D	E	F	G	H			
Host PCI IRQ line	0	1	2	3	4	5	6	7	8	9	10	10	11	11	12	12	13	13	14	14	15	15	A	B	C	D	E	F	G	H	1)		
Slot 1 PCI																																	
PCI IRQ line A												Z														Y							
PCI IRQ line B											Z																	Y					
PCI IRQ line C											Z																		Y				
PCI IRQ line D											Z																			Y			
Slot 2 PCI																																	
PCI IRQ line A												Z															Y						
PCI IRQ line B											Z																	Y					
PCI IRQ line C								Z																							Y		
PCI IRQ line D								Z																				Y					
Slot 2 PCIexpress																																	
PCI IRQ line A																											Y						
PCI IRQ line B												Z																Y					
PCI IRQ line C											Z																						
PCI IRQ line D											Z																						

1) Host PCI IRQs A to H are assigned fixed IRQs 16-23 in APIC mode.
Host PCI IRQs A to H are automatically assigned IRQs 0-15 in PIC mode by BIOS; a specified order cannot be forced.

Figure 16-4 Interrupt assignment of the slot connectors on the bus board

16.3.2.3 Exclusive PCI hardware interrupt

Applications demanding a high-performance interrupt require a high-speed hardware interrupt reaction. The PCI hardware interrupt should be used only by one resource in order to ensure high-speed reaction of the hardware.

Exclusive interrupt in APIC mode

	IRQ assignments for Windows XP Professional, Windows XP Embedded and Windows 2000 Professional (APIC mode)
Ethernet 1	16 ¹⁾²⁾
Ethernet 2	17 ¹⁾
Profibus/MPI	19 ¹⁾
PCI slot 1	20 ¹⁾
PCI slot 2	21 ¹⁾
PCI Express slot	16 ¹⁾³⁾

¹⁾ Requirement: The modules in the PCI slots each require only one interrupt

²⁾ Requirement: VGA and PCI Express do not require an interrupt

³⁾ Requirement: VGA does not require an interrupt and Ethernet1 is disabled

Exclusive interrupt in PIC mode

The interrupts are automatically assigned to the slots at system startup due to the default settings in system BIOS.

Several slots may share the same interrupt, depending on the system configuration. This functionality is known as interrupt sharing. Exclusive interrupts are not available in PIC mode. Disable specific system resources in order to obtain exclusive interrupts. BIOS assigns the PIC interrupts at random during restart of the system.

16.3.2.4 Memory address assignments

PCI VGA modules can be operated with expansion ROM up to 48K.

Address		Size	Description of the basic function	Possible alternative function
from	to			
0000 0000	0007 FFFF	512K	Conventional system memory	
0008 0000	0009 F7FF	127K	Conventional system memory extended	
0009 F800	0009 FFFF	2K	XBDA, extended Bios Data Area	
000A 0000	000A FFFF	64K	VGA graphics refresh memory	Shared SMM for power management
000B 0000	000B 7FFF	32K	Software graphics / text refresh memory	Not used
000B 8000	000B FFFF	32K	VGA graphics/text refresh memory	
000C 0000	000C BFFF	48K	VGA BIOS expansion	
000C 0000	000C E9FF	59K ¹⁾	VGA BIOS	Always occupied
000C F000	000D FFFF	68K ¹⁾	Not used (no RAID, no PXE)	via EMM High DOS Memory
000C F000	000C FFFF	4K ¹⁾	PXE	
000D 0000	000D FFFF	64K ¹⁾	Not used (no RAID, with PXE)	via EMM High DOS Memory
000C F000	000D 37FF	18K ¹⁾	RAID	
000D 3800	000D FFFF	50K ¹⁾	Not used (RAID, no PXE)	via EMM High DOS Memory
000C F000	000D 47FF	22K ¹⁾	RAID and PXE	
000D 4800	000D FFFF	46K ¹⁾	Not used	
000E 0000	000E 1FFF	8K	USB	
000E 2000	000E 3FFF	8K	DMI data	
000E 4000	000F FFFF	112K	System BIOS	
0010 0000	CFFF FFFF	3,2GB	System memory 4 GB memory configuration	Depends on memory configuration
D000 0000	FFE FFFF	767 MB	Configuration space	
FFF0 0000	FFFF FFFF	1 MB	Firmware HUB	

¹⁾ Optional memory allocation, depending on settings in BIOS Setup

16.4 BIOS Setup

16.4.1 Overview

BIOS Setup program

BIOS Setup program is stored in ROM BIOS. Information about the system configuration is stored in the battery-backed memory of the device.

SETUP can be used to define the hardware configuration (for example, the hard disk type) and system properties. SETUP is also used to set the time and date of the realtime clock.

Changing the device configuration

Your device configuration is preset for operating with the included software. You should only change the default values if you have modified the technical configuration your device, or if a fault occurs when the unit is powered up.

16.4.2 Starting BIOS Setup

Starting BIOS Setup

1. Start the setup program as follows:
2. Reset the device (warm or cold restart).

In the figures shown, the default settings differ based on the device versions. With the default setting of the Box PC, the display shown below appears following power-on, for example:

```
PhoenixBIOS 4.0 Release 6.0 cME FirstBIOS Desktop Pro -A5E00929013-ES004

Copyright 1985-2004 Phoenix Technologies Ltd.
All Rights Reserved

SIMATIC BOX PC 627B/PANEL PC 677B Profibus Version V11.02.04

CPU = 1 Processors Detected, Cores per Processor = 2
Intel(R) Core(TM)2 CPU          T5500 @ 1.66GHz
2039M System RAM Passed
2048K Cache SRAM Passed
System BIOS shadowed
Video BIOS shadowed
Fixed Disk 0: ST3160815AS
USB: SIEMENS USB-FD 4
Mouse initialized
```

On completion of the POST, the BIOS gives you the opportunity of starting the SETUP program. The following message appears on the screen:

```
Press < F2 > to enter SETUP or <ESC> to show boot menu
```

3. Press the F2 key as long as the BIOS prompt appears on the screen.

16.4.3 BIOS Setup menus

The various menus and submenus are listed on the next pages. You can obtain information on the selected SETUP item from the "item-specific help" part of the respective menu.

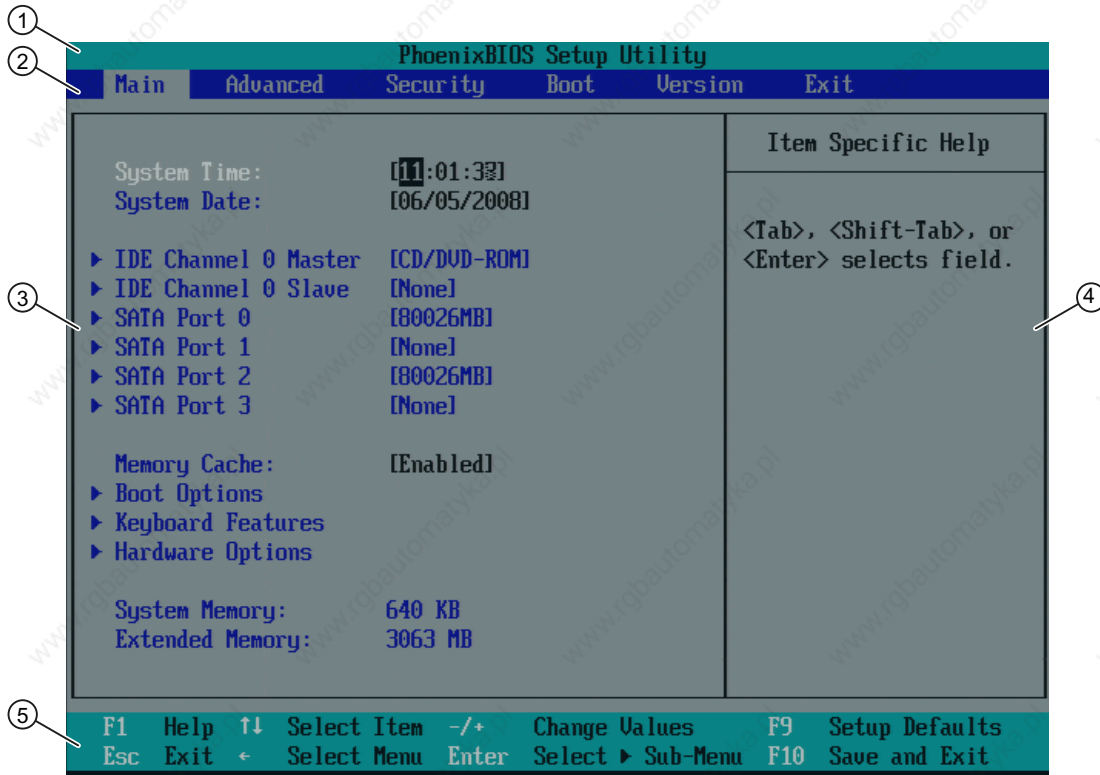

Figure 16-5 SETUP Main menu (example)

(1) Header	(4) Help view
(2) Menu line	(5) Input line
(3) Selectable submenu	

Menu layout

The screen is divided into four sections. In the top part (2), you can select the menu forms [Main], [Advanced], [Security], [Boot], [Version], [Exit]. In the left of the center section (3) you can select various settings or submenus. Brief help texts appear on the right (4) for the currently selected menu entry. The bottom section contains information for operator input.

The figures below represent examples of specific device configurations. The screen content changes based on the supplied equipment configuration.

Yellow stars to the left of the interface designation (for example, Internal COM 1) indicate a resource conflict between the interfaces managed by the BIOS. In this case you should select the default settings (F9) or eliminate the conflict.

You can move between the menu forms using the cursor keys [←] left and [→] right.

Menu	Meaning
Main	System functions are set here
Advanced	An extended system configuration can be set here
Security	This is where setting security functions such as the password are set.
Boot	This is where the boot priority is specified.
Version	This shows device-specific information (such as the release version).
Exit	Used for terminating and saving.

16.4.4 Main menu

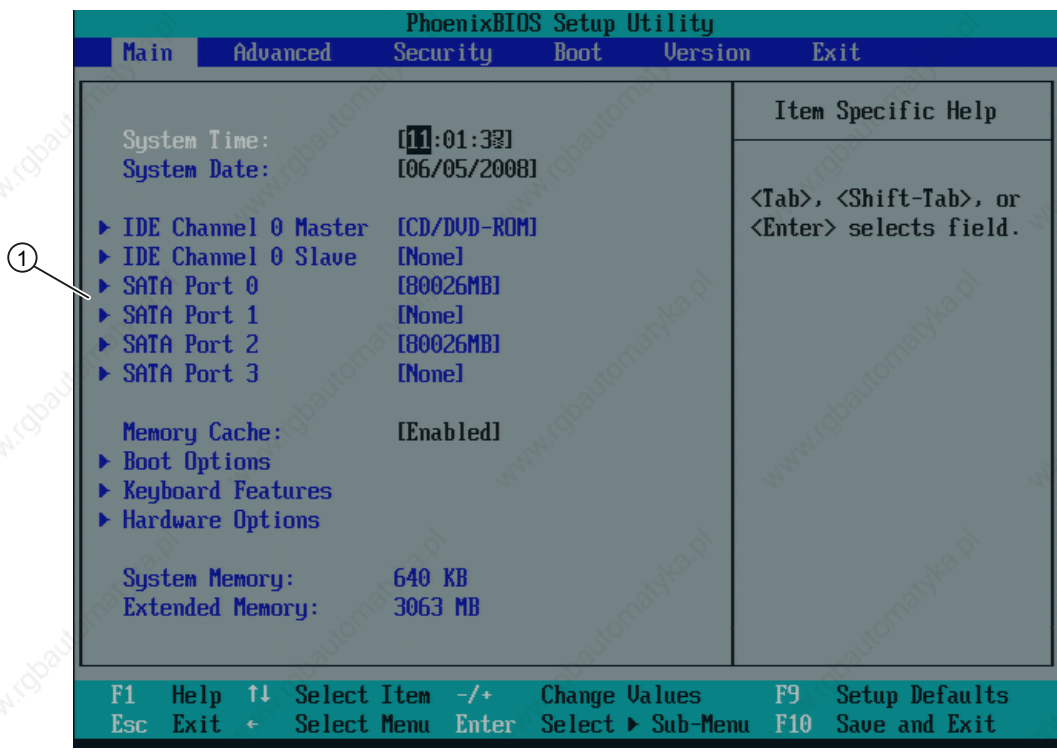

Figure 16-6 Main menu (example)

(1) Selectable submenu

Settings in the main menu

In the main menu, you can move up and down to select the following system configuration boxes by means of the [↑] up and [↓] down cursor keys:

Field	Meaning
System Time	For viewing and setting the current time
System Date	For viewing and setting the current date
Memory Cache	Used for setting the cache options
by submenus	
IDE Channel 0 Master	Type of installed disk drives
IDE Channel 0 Slave	Type of installed disk drives
SATA Port 0	Type of installed disk drives
SATA Port 1	Type of installed disk drives
SATA Port 2	Type of installed disk drives
SATA Port 3	Type of installed disk drives
Boot options	Used for setting the boot options
Keyboard Features	Used for setting of keyboard interface (for instance, NUM-LOCK, typematic rate)
Hardware Options	Used for setting the hardware options

System time and date

System Time and System Date indicate the current values. Once you have selected the appropriate option, you can use the [+] and [-] keys to modify the time setting

Hour: Minute: Second

and for the date

Month/Day/Year

You can navigate between the entries in the date and time fields (for example, from hour to minute) using the tab key.

IDE Channel 0 Master, IDE Channel 0 Slave

The system jumps to the following submenu when you select this type of menu field:

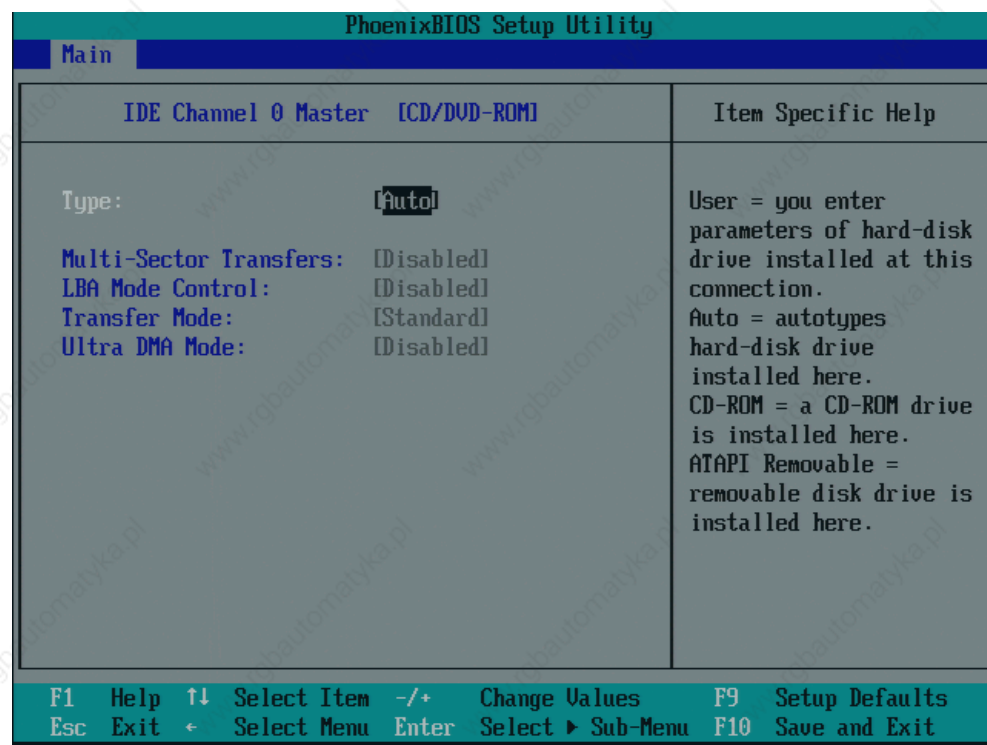

Figure 16-7 IDE Channel 0 Master (example)

Type	[User]	Select "User" to enter a user-specific definition of the hard disk type. Configure all the other options, for example, Cylinder, Heads, Sectors/Track, or other properties of the hard disk drive.
	[Auto]	The parameters which you can select in this dialog are usually saved to the respective IDE drive. The "Auto" setting in the "Type" field means that these values are automatically read from the drive and written to memory. If Type is selected for a drive that does not exist, a timeout is triggered within approximately 1 minute and the entries remain unchanged. It makes sense only to set "Auto" for interfaces to which a drive is connected.
	[CD/DVD-ROM]	CD/DVD-ROM is connected
	ATAPI Removable	A removable data volume is connected
	None	Select "None" if you have not connected a disk drive. This setting reduces system waiting time.
Multi-Sector Transfer	The number of blocks (sectors) transferred per interrupt are defined at the "Multi-Sector Transfer" option. The value depends on the drive and should only be set by way of "Auto" setting at the "Type" field.	
	Disabled	2, 4, 8, 16 sectors
LBA Mode Control	The "Enabled" setting at the "LBA Mode Control" (enabled, disabled) option means that hard disk capacities greater than 528 MB are supported. The value depends on the drive and should only be set by way of "Auto" setting at the "Type" field.	
32-bit I/O	The type of access to the drive is determined in the 32-bit I/O field	
	Disabled	16-bit access
	Enabled	32-bit access (default)
Transfer Mode or Ultra DMA Mode	Define the data transmission rate of the interface in these fields. The value depends on the drive and should only be set by way of "Auto" setting at the "Type" field. Exit the submenu by pressing ESC.	

SATA Port 0, SATA Port 1, SATA Port 2, SATA Port 3

The system jumps to the following submenu when you select this type of menu field:

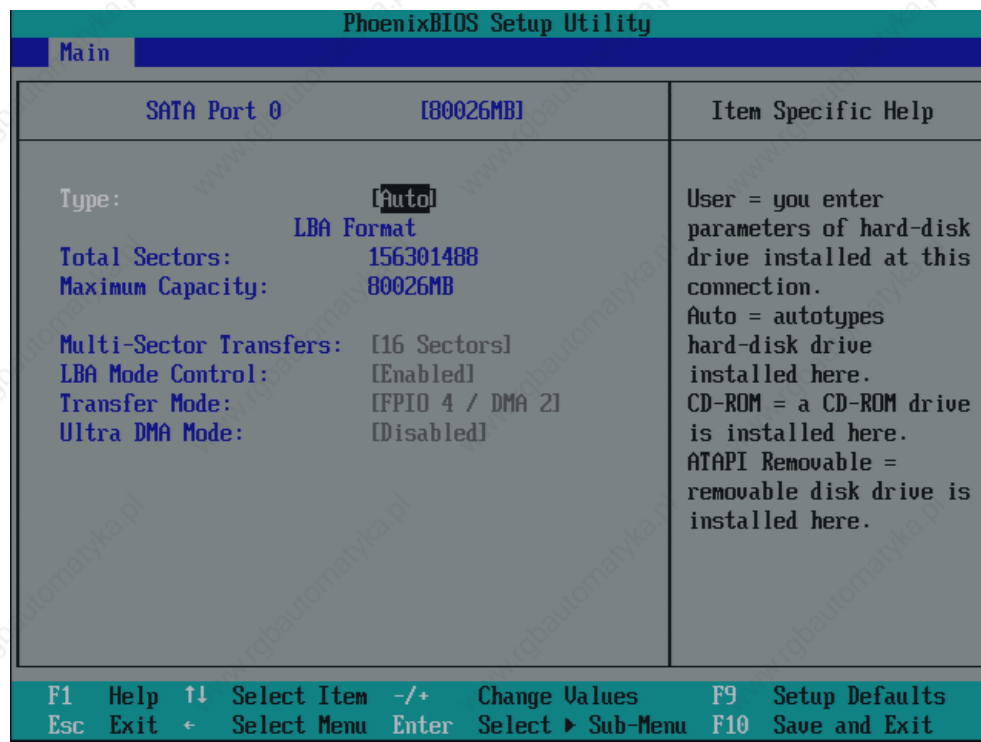

Figure 16-8 SATA Port 0 (example)

Type	[User]	Select "User" to enter a user-specific definition of the hard disk type. Configure all the other options, for example, Cylinder, Heads, Sectors/Track, or other properties of the hard disk drive.
	[Auto]	The parameters which you can select in this dialog are usually saved to the respective IDE drive. The "Auto" setting in the "Type" field means that these values are automatically read from the drive and written to memory. If Type is selected for a drive that does not exist, a timeout is triggered within approximately 1 minute and the entries remain unchanged. It makes sense only to set "Auto" for interfaces to which a drive is connected.
	[CD/DVD-ROM]	CD/DVD-ROM is connected
	[ATAPI Removable]	A removable data volume is connected
	[None]	Select "None" if you have not connected a disk drive. This setting reduces system waiting time.
Multi-Sector Transfer		The number of blocks (sectors) transferred per interrupt are defined at the "Multi-Sector Transfer" option. The value depends on the drive and should only be set by way of "Auto" setting at the "Type" field.
	Disabled	2, 4, 8, 16 sectors

16.4 BIOS Setup

LBA Mode Control	The "Enabled" setting at the "LBA Mode Control" (enabled, disabled) option means that hard disk capacities greater than 528 MB are supported. The value depends on the drive and should only be set by way of "Auto" setting at the "Type" field.	
32-bit I/O	The type of access to the drive is determined in the 32-bit I/O field	
	Disabled	16-bit access (default)
	Enabled	32-bit access
Transfer Mode or Ultra DMA Mode	Define the data transmission rate of the interface in these fields. The value depends on the drive and should only be set by way of "Auto" setting at the "Type" field. Exit the submenu by pressing ESC.	

"Memory Cache" field

The following shortcut menu appears when you select the option "Memory cache" in the main menu:

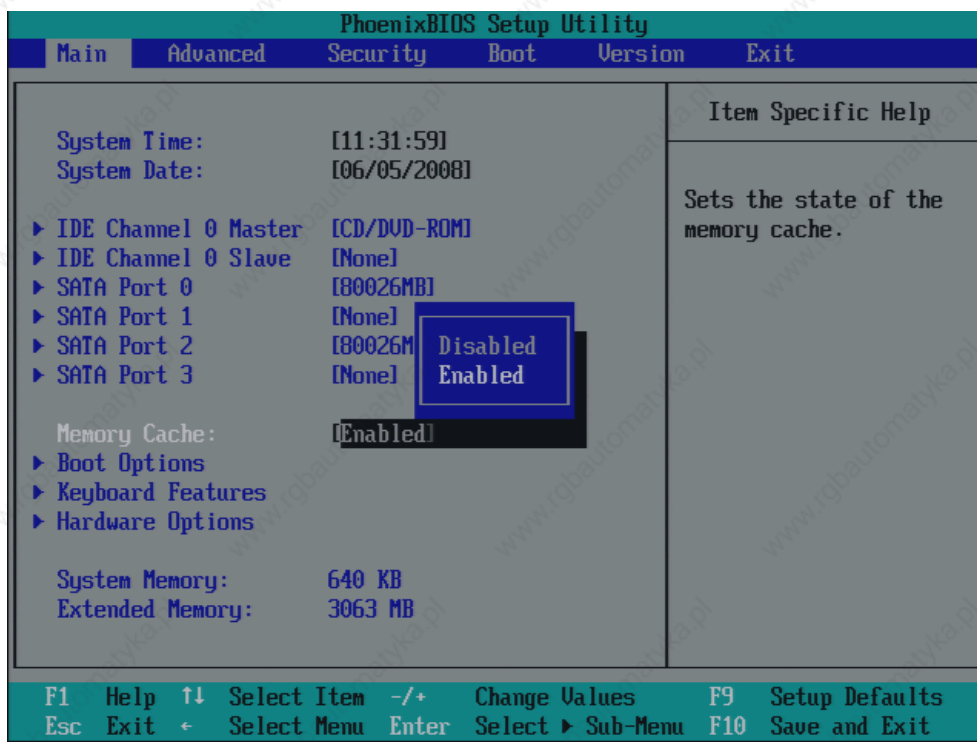

Figure 16-9 "Memory Cache" field

The cache is a high-speed memory buffer between the CPU and memory (DRAM). Repeated memory access operations are executed in the faster cache, and not in the main memory, provided the feature is enabled. In some cases it may be necessary to disable the cache for certain types of hardware and software because intentional program runtimes or delay times may be prevented by the fast cache.

[Disabled]	Cache is disabled
[Enabled]	Cache is enabled

"Boot Options" field

The following shortcut menu appears when you select the option "Boot Options" in the main menu:

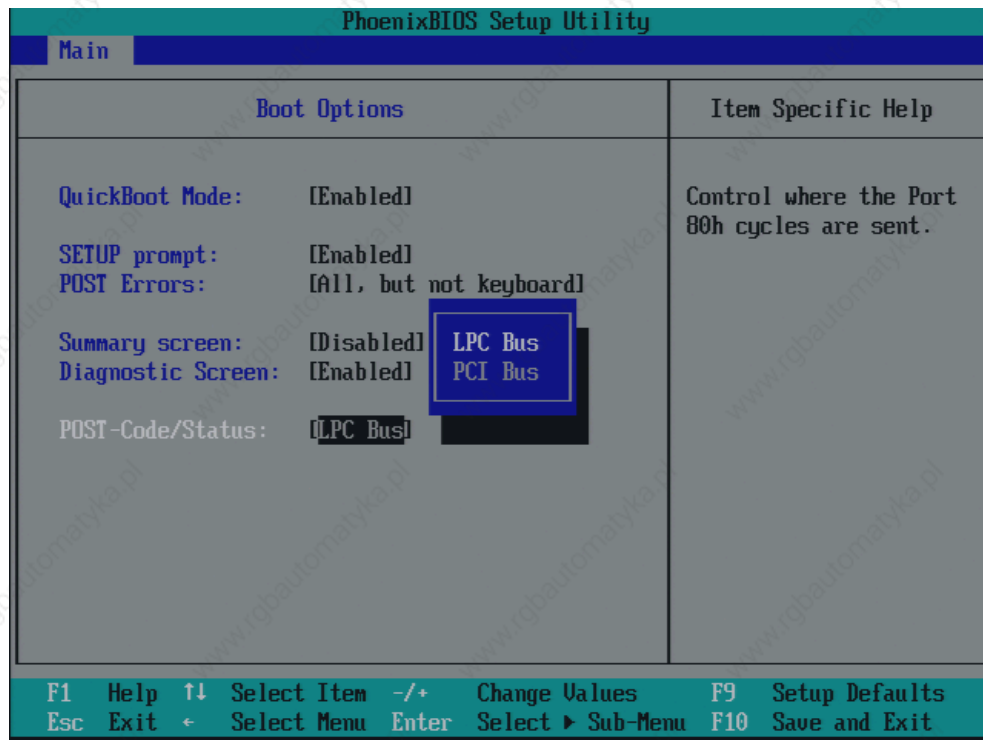

Figure 16-10 "Boot Options" field

Quick Boot Mode	Some hardware tests are skipped to speed up the boot sequence.	
SETUP prompt	During the system load phase, the message "Press <F2> to enter Setup or <Esc> to show boot menu" is output on the bottom of the screen.	
POST errors	If the boot sequence is interrupted due to an error detected within the system startup phase, press <F1> to acknowledge this error.	
	[Disabled]	Error acknowledgment is not required, for example, if a keyboard is not found.
	[All, but not keyboard]	Show all errors except for keyboard errors.
Summary screen	The most important system parameters are displayed when the system run-up phase completes.	
Diagnostic screen	Shows the diagnostics messages on the monitor during booting.	
Port 80h Cycles	Specifies where the POST codes are output.	
	LPC Bus	Output of the status display for the device
	PCI bus	Output to PCI bus

'Enabled' means that the feature is active. 'Disabled' means that the feature is inactive.

Example of a summary screen:

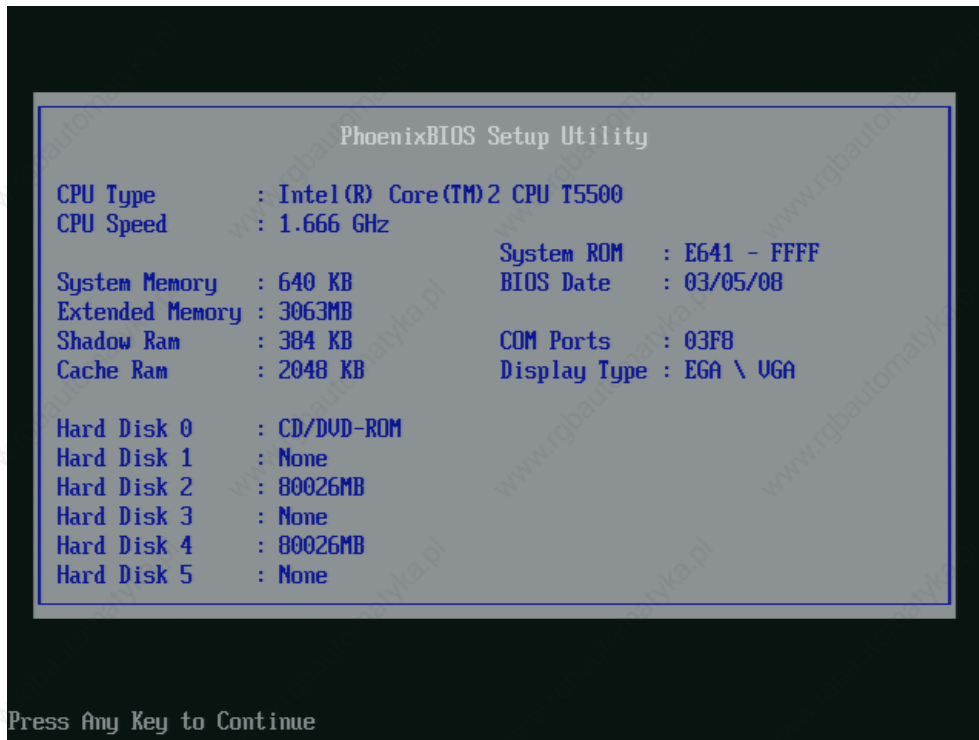

Figure 16-11 Summary screen (example)

The Summary screen appears when the system run-up phase completes.

"Keyboard Features" field

The following shortcut menu appears when you select the option "Keyboard Features" in the main menu:

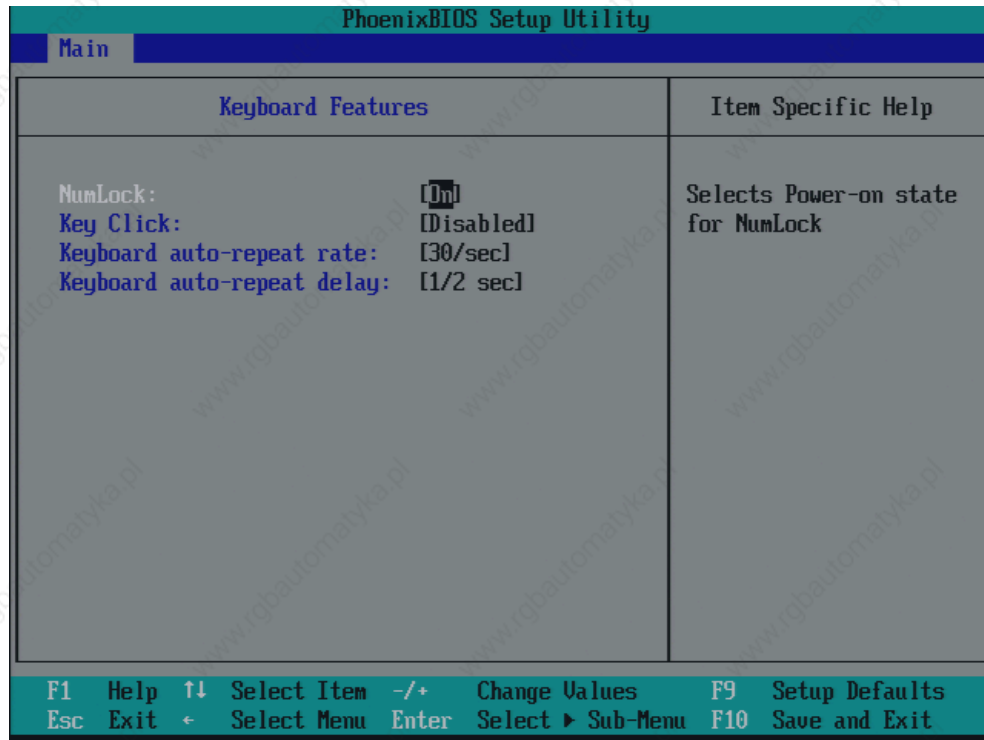

Figure 16-12 "Keyboard Features" field

Numlock	Switches Numlock on or off following power on. This status is saved to non-volatile memory if "Auto" is set.
Key Click	The program outputs an audible "CLICK" for keystrokes.
Keyboard auto-repeat rate	Increase in automatic key repeat rate
Keyboard auto-repeat delay	On-delay of automatic keyboard repeat

"Hardware Options" field

If you select the "Hardware Options" field in the Main menu, one of these submenus is displayed (depending on the product model):

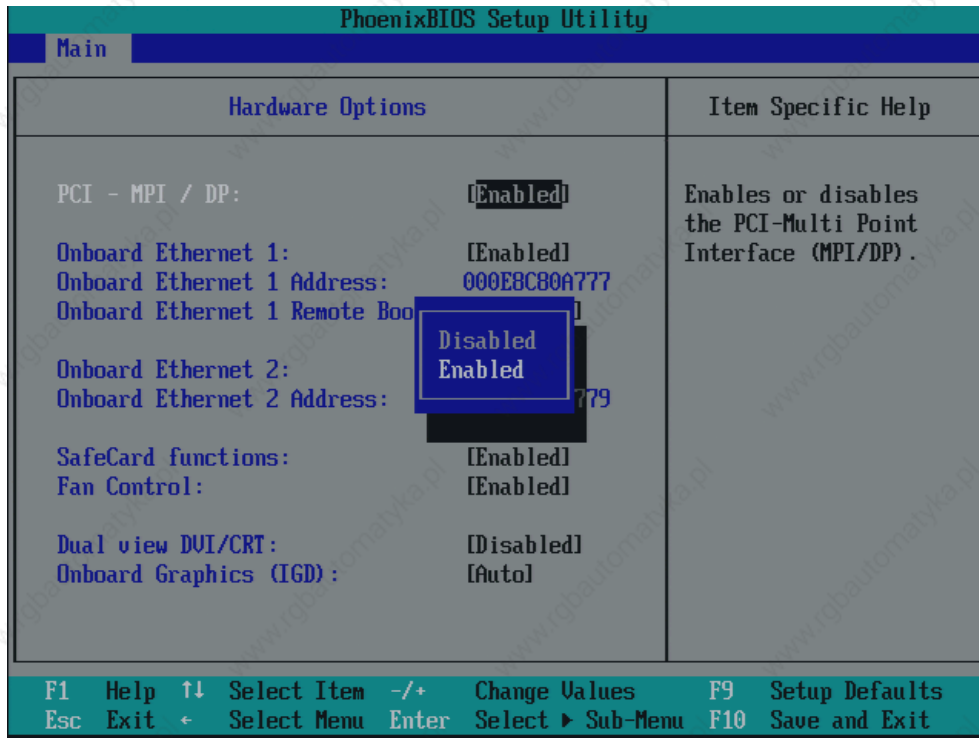

Figure 16-13 "Hardware Options" field (example for PROFIBUS)

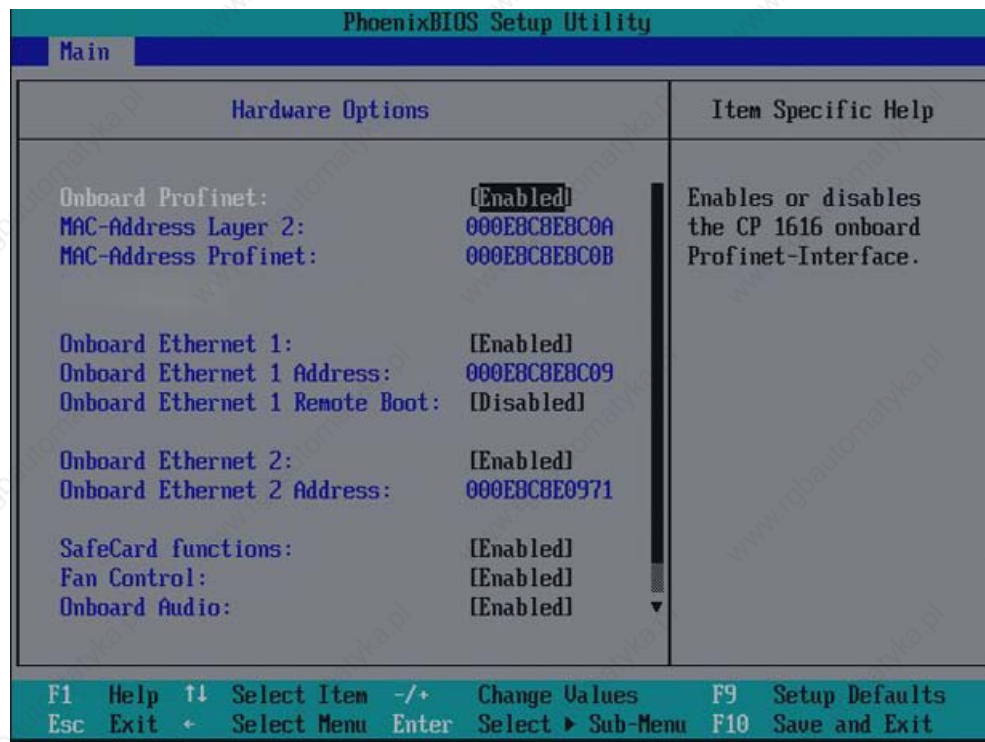

Figure 16-14 "Hardware Options" field (example for PROFINET)

The parameters of the interfaces present on the motherboard are set here.

Entry	Meaning	
PCI-MPI/DP *	[Enabled]	Enables the CP5611-compatible MPI/DP interface. The resources are managed by the BIOS PCI Plug and Play mechanism.
	[Disabled]	The CP5611 compatible MPI/DP interface is disabled.
Onboard Profinet *	[Enabled]	CP 1616 onboard is enabled
	[Disabled]	CP 1616 onboard is disabled
MAC Address Layer 2 *		This address is for NDIS applications. Example: 000E8C8E8C0A
MAC Address Profinet		This is the main address for PROFINET applications Example: 000E8C8E8C0B. The MAC addresses of the individual ports are derived from "MAC Address Profinet". These are not shown in the BIOS setup. Example: P1=000E8C8E8C0B+1, P2=000E8C8E8C0B+2, P3=000E8C8E8C0B+3
Onboard Ethernet	[Enabled]	The Ethernet port on the motherboard is enabled.
	[Disabled]	The Ethernet port on the motherboard is disabled.
Onboard Ethernet Address		Shows the individual Ethernet address.
Onboard Ethernet 1 Remote Boot *	[Enabled]	Booting via a connected LAN is possible.
	[Disabled]	Booting via LAN is not possible.

16.4 BIOS Setup

Entry	Meaning	
SafeCard functions	[Enabled]	Onboard monitoring functions are enabled.
	[Disabled]	No monitoring functions.
	The relevant driver and the application must be started for operation of the monitoring functions.	
Fan Control	[Enabled]	The fan speed is controlled based on the temperature.
	[Disabled]	The fan always runs at full speed.
Dual view DVI/CRT	[Disabled]	Only one CRT or DVI monitor is driven.
	[Enabled]	When a CRT and a DVI monitor are connected, both are activated.
Onboard Graphics (IGD)	Auto	BIOS detects whether another graphics module is inserted and switches over depending on the "Default Primary Video Adapter" setting.
	Disabled	The integrated graphics is disabled in the chipset. This setting should only be selected if another graphics card is installed.

* This menu item depends on the device features

Note

The second Ethernet interface support is OS dependent. For DOS based applications (e.g. Image Creator) please use the first Ethernet interface.

Note

For or operation without a monitor (= headless operation), Dual view DVI/CRT should be set to "Disabled".

16.4.5 Advanced menu

Menu layout

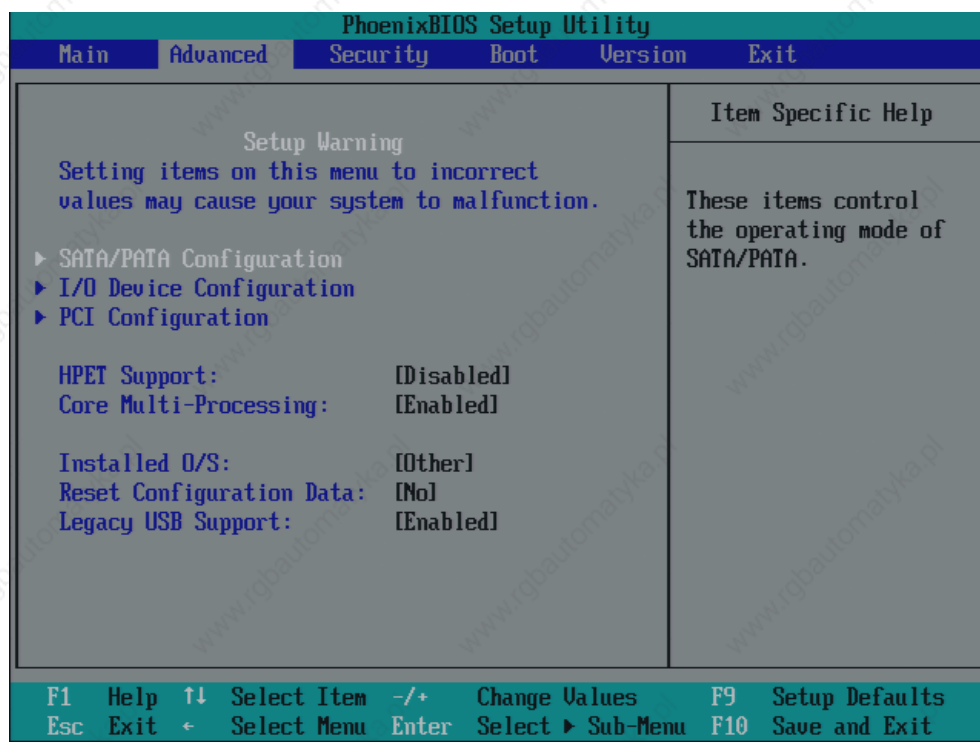

Figure 16-15 "Advanced" menu (example)

Settings in the Advanced Menu

HPET Support	[Disabled]	High-resolution timer for multimedia disabled
	[Enabled]	High-resolution timer for multimedia enabled
Core Multi-Processing ¹⁾	[Disabled]	Core Multi-Processor is disabled Default setting for operating systems that do not support Core Multi-Processing (for example: Windows 2000)
	[Enabled]	Core Multi-Processor enabled
VT Feature *	[Enabled]	VT support of the CPU can be used
	[Disabled]	VT support of the CPU is disabled
Installed O/S	Plug&Play means that all modules are automatically detected and installed, providing they support the Plug&Play functionality.	
	[Other]	BIOS handles the entire Plug&Play capability, default setting.
	[WinXP/2000]	The operating system handles the Plug&Play functions.

16.4 BIOS Setup

Reset Configuration Data	[Yes]	All installations under Plug&Play are deleted and the configuration is retriggered the next time the system boots. The entry is then reset to [No]. System components that do not support Plug&Play have to be entered manually.
	[No]	The Plug&Play system components are initialized after the next system start.
Legacy USB support	[Disabled]	Disables Legacy Universal Serial Bus support
	[Enabled]	Enables Legacy Universal Serial Bus support The USB Boot function must be enabled to allow booting from a USB device, or if the system is to be operated without USB support with a USB keyboard or mouse.
USB controller restart	[Enabled]	The USB controller restart function has to be activated before you can install an operating system or if you experience problems with a user interface (Human Interface Device).

¹⁾ Optional product feature

"SATA/PATA Configuration" submenu

Figure 16-16 "SATA/PATA Configuration" submenu

PATA Controller:	[Enabled] [Disabled]	Disables or enables the PATA controller
SATA Controller mode	[Enhanced]	SATA drive = Primary on the SATA controller in native mode. PATA drive = Primary on the PATA controller in legacy mode.
	[Compatible]	SATA drive = Primary on the SATA controller, in legacy mode PATA drive = drive on the SATA controller in legacy mode
AHCI Configuration	[Disabled] [Enabled]	Disables or enables AHCI support (must be enabled for RAID systems).
SATA RAID Enable	[Disabled] [Enabled]	Disables or enables RAID support

"I/O Device Configuration" submenu

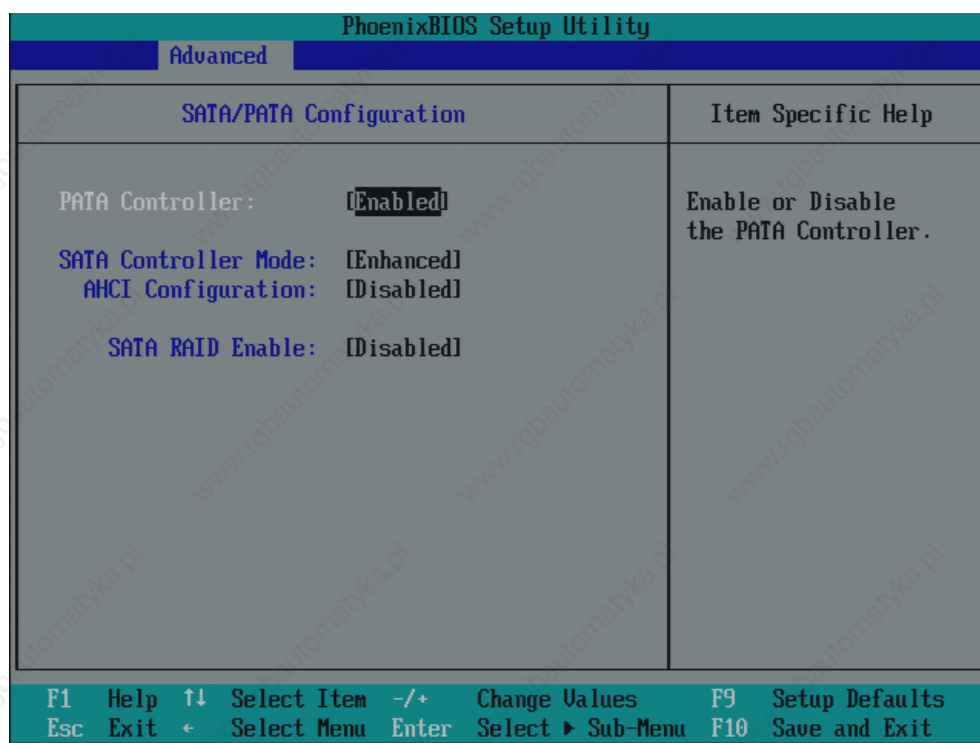
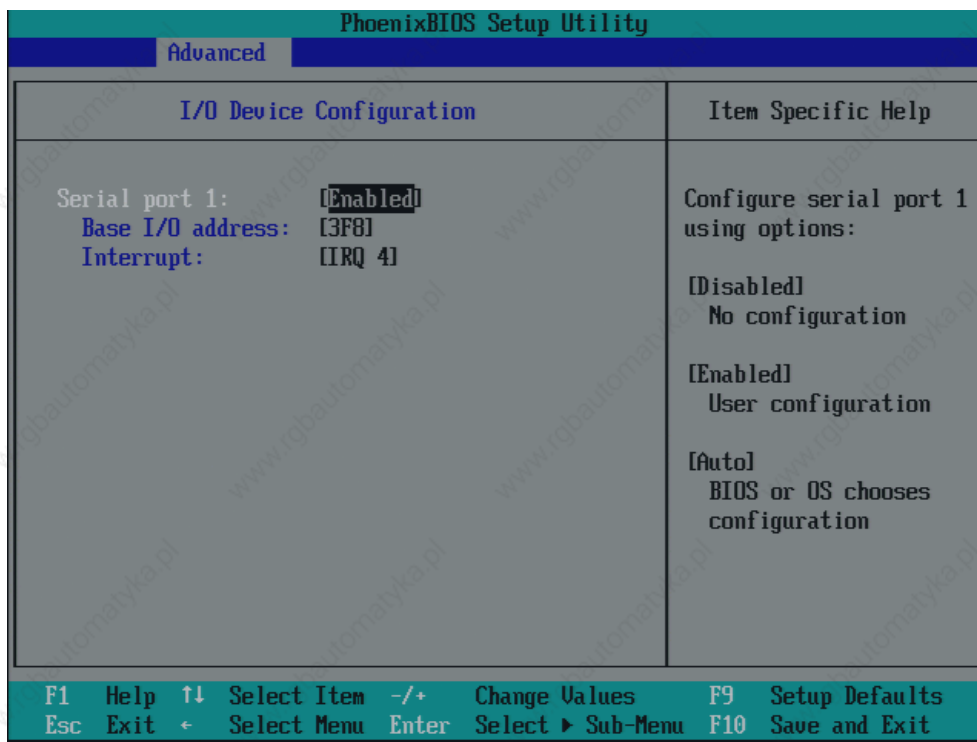

Figure 16-17 "I/O Device Configuration" submenu

The resources used by an interface are released when you disable the interface in question. The I/O addresses and interrupts are pre-assigned; it is advisable not to change these default assignments.

"PCI Configuration" submenu

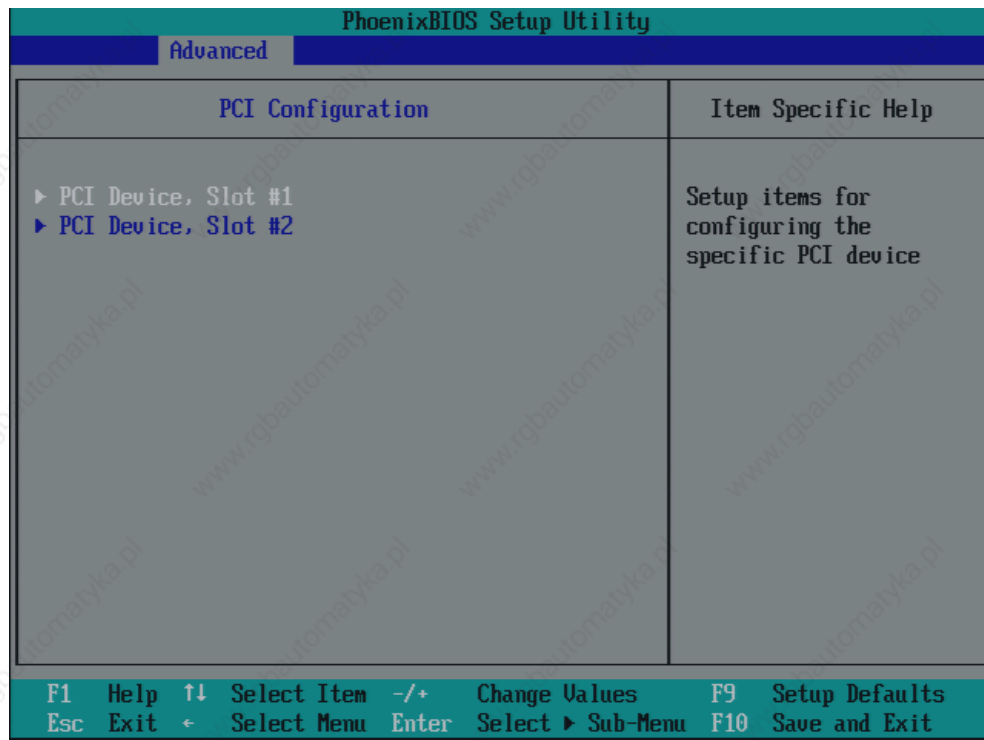

Figure 16-18 "PCI Configuration" submenu (Example)

Note

The submenu for slot 2 is not displayed for the "1 PCI Slot and 1 PCI Express Slot" product models.

"PCI Devices" field

If the PCI devices field is selected, the following submenu appears:

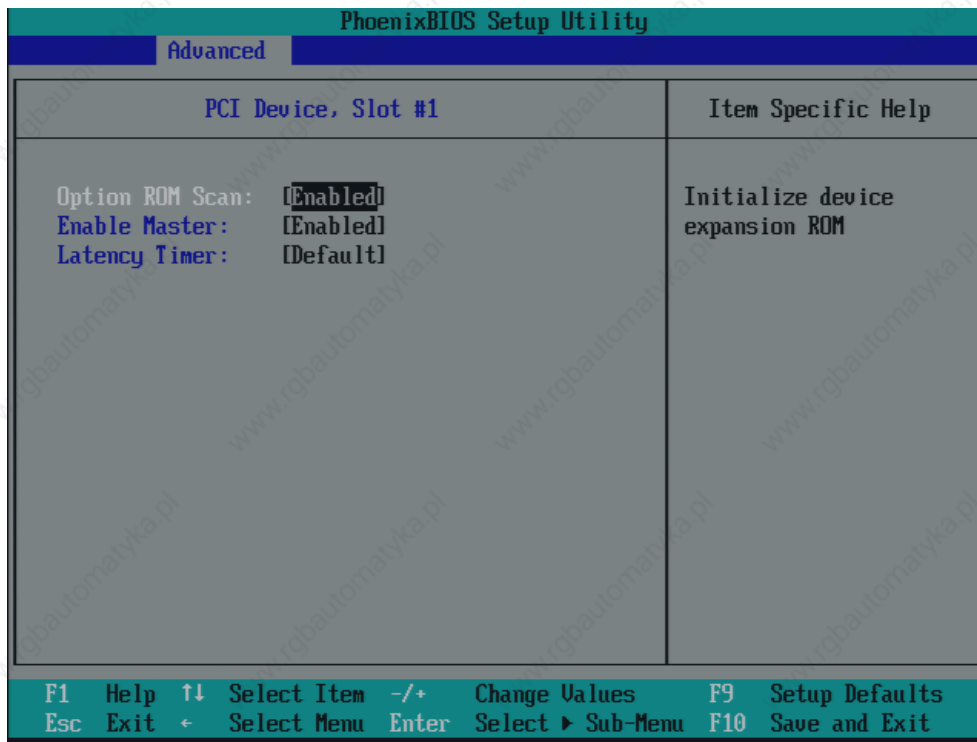

Figure 16-19 "PCI Devices, slot #1" submenu (example)

ROM scan option:	[Enabled]	The ROM option of the PCI module (if present) is enabled
	[Disabled]	The ROM option of a PCI module is disabled.
Enable Master	[Enabled]	This slot can be assigned PCI master functions
	[Disabled]	This slot can only operate as a PCI slave.
Latency Timer	[Default]	The number of active PCI clock cycles of the master modules is determined by this module
	[0020H to 00E0H]	These settings define the maximum number of active PCI clock cycles according to the set value.
	You should only use a value different from the default if the module or its application requires it.	

16.4.6 Security menu

You can only edit the fields enclosed in square brackets. Two passwords can be assigned to protect your PC from unauthorized use. The Supervisor password can be used to restrict access to the hard disks.

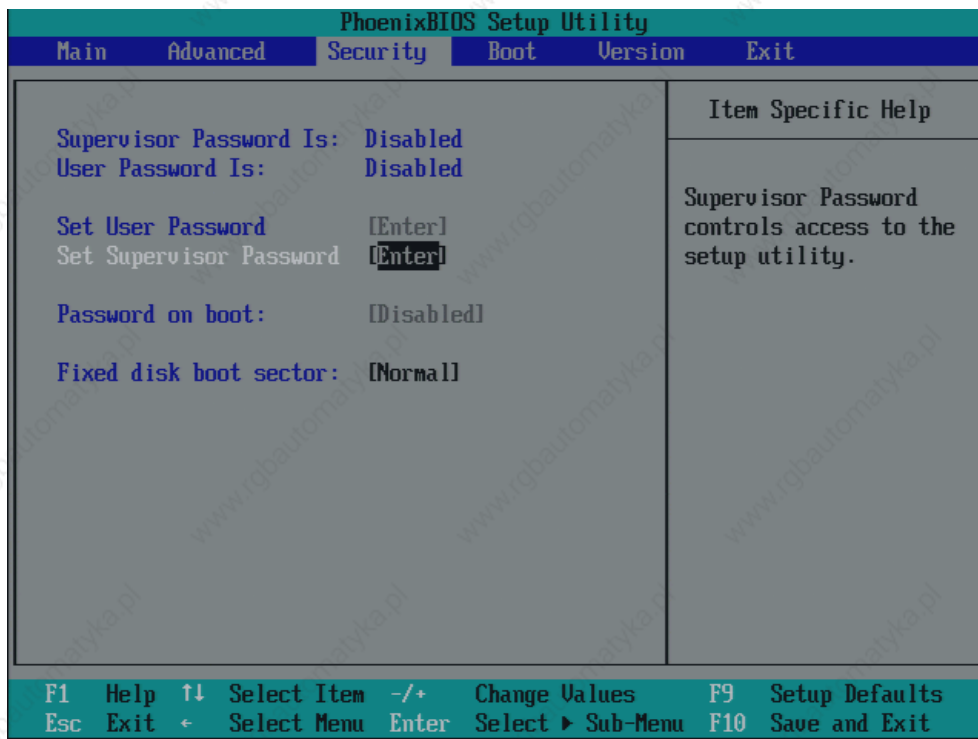

Figure 16-20 Security menu

User password is	Disabled	The password is disabled.
	Enabled	Certain Setup fields are configurable by the user, including the user password.
	The field resets automatically from [Disabled] to [Enabled] when the password is entered.	
Set User Password	This field opens the password input dialog. Logged on users can change the password, or clear and deactivate it by pressing "Return."	
Set Supervisor Password	This field opens the password input dialog. Authorized logged on users can change the supervisor password, or delete and deactivate it by pressing "Return."	
Password on boot	[Disabled]	No password prompt for booting.
	[Enabled]	Supervisor or user password must be entered for system boot.
Fixed disk boot sector	[Normal]	All types of hard-disk access are permitted.
	[Write protect]	the user cannot install an operating system. This is a way of protecting against boot viruses.

Detailed descriptions

16.4 BIOS Setup

Diskette access	This mode of protection is not enabled unless "Password on boot " is [enabled].	
	[Supervisor]	Diskette access is not possible unless the supervisor password was entered during booting.
	[User]	Diskette access is not possible unless the user password was entered during booting. Notice! This function cannot be used under Windows NT/2000 Professional/XP Professional, since these operating systems do not access the diskette via BIOS routines. Use the system programs in Windows 2000/XP Professional system programs to set up this function.

16.4.7 Boot Menu

This menu allows you to assign a priority for the boot devices.

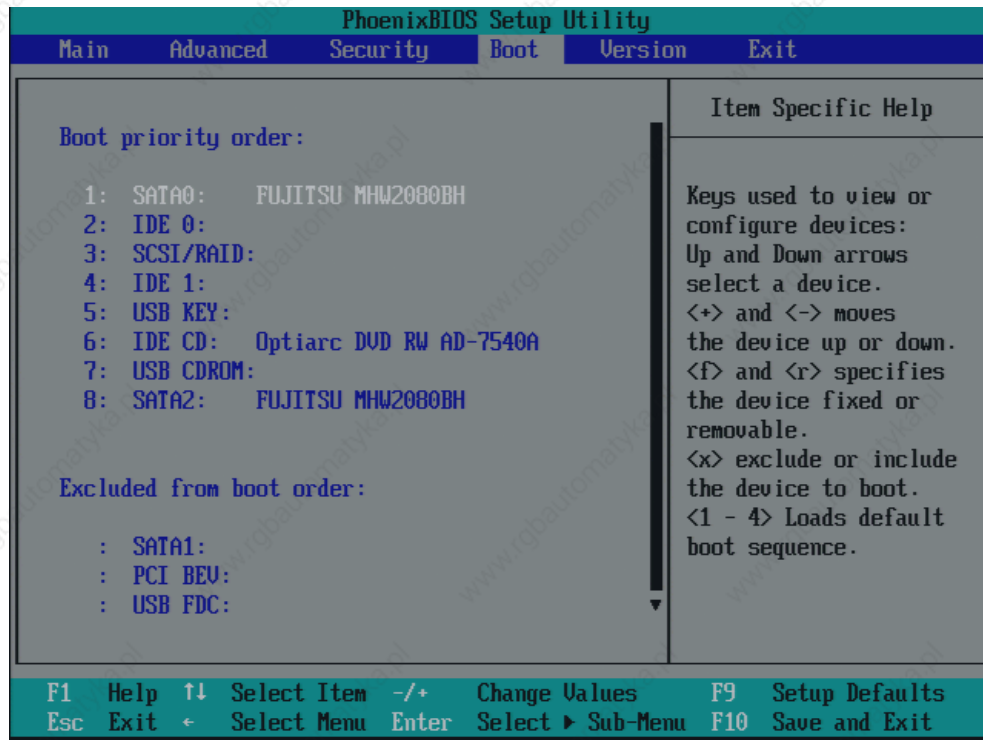

Figure 16-21 Boot Menu

This screen shows all possible boot devices. The boot source with the highest boot priority is at the top. To change the sequence:

Select the boot source with the ↑↓ keys, move to the desired position with + or -.

Note

During startup the boot drive can be selected using the ESC key.

If a boot device is not available, the next device in the sequence is automatically checked to ascertain whether or not it is bootable.

16.4.8 Version Menu

This menu contains system information which should be made available to Technical Support.

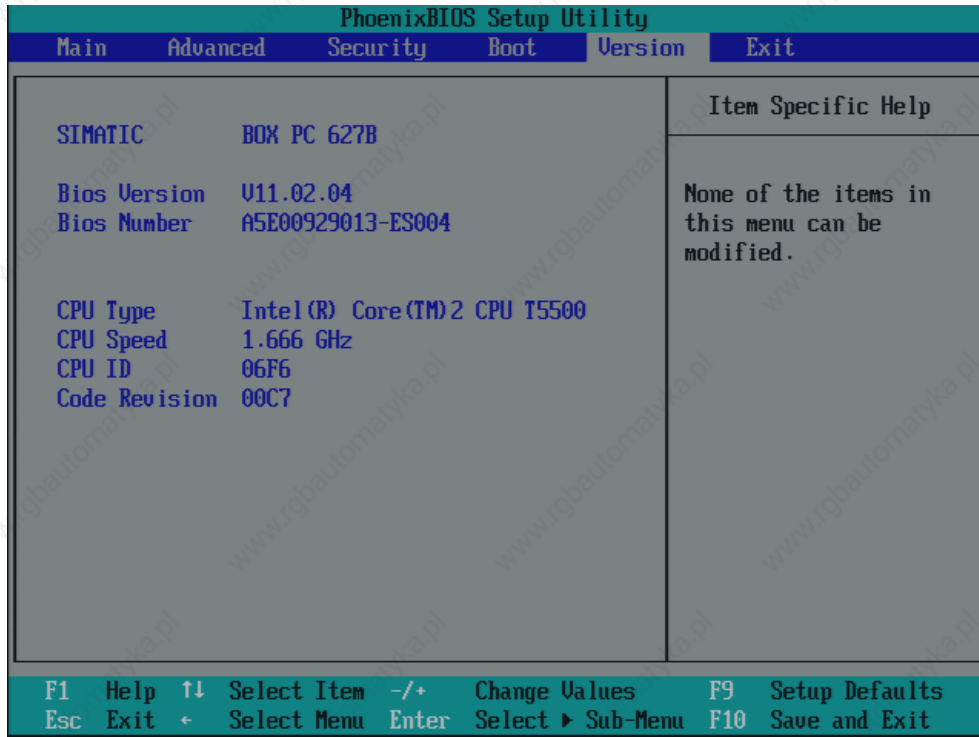

Figure 16-22 Version menu (example)

16.4.9 Exit menu

You always exit BIOS Setup in this menu.



Figure 16-23 The "Exit" menu (example)

Save Changes & Exit	All changes are saved and the system is restarted with the new parameters.	
Exit Without Saving Changes	All changes are discarded and the system is restarted with the old parameters.	
Get Default Values	All parameters are set to safe values.	
Load Previous Values	The last saved values are reloaded.	
Save Changes	Save all Setup settings.	
Profiles	Standard	The BIOS settings are backed up to buffered CMOS
	User	The BIOS settings are saved in the non-volatile Flash memory.
	Manufacturer	This setting is only used for production purposes. Do not use.

16.4.10 BIOS Setup default settings

Documenting your device configuration

If you have changed any default settings in Setup, you can enter them in the following table. You can then refer to these entries for any future hardware modifications.

Note

Print out the table below and keep the pages in a safe place once you made your entries.

Note

The default setup settings vary depending on the ordered device configuration.

BIOS Setup default settings

System parameters	Defaults	Custom entries
Main		
System Time	hh:mm:ss	
System Date	MM/DD/YYYY	
IDE Channel 0 Master	None *	
IDE Channel 0 Slave	None	
SATA Port 0	120GB SATA1 *	
SATA Port 1	None *	
SATA Port 2	None	
SATA Port 3	None	
Memory Cache	Write Back	

Boot options		
Quick Boot Mode	Enabled	
SETUP prompt	Enabled	
POST errors	All, but not keyboard	
Summary screen	Enabled	
Diagnostic screen	Enabled	
Post Code/Status	LPC Bus	

Keyboard Features		
Numlock	On	
Key Click	Disabled	
Keyboard auto-repeat rate	30/sec	
Keyboard auto-repeat delay	½ sec	

Hardware Options		
PCI-MPI/DP ¹⁾	Enabled	
PROFINET ¹⁾	Enabled	
MAC Address Layer 1	000E8C80A63E (example)	
MAC Address Profinet	000E8C80A63F (example)	
Onboard Ethernet 1	Enabled	
Onboard Ethernet 1 Address	08000624xxxx	
Onboard Ethernet 1 Remote Boot	Disabled	
Onboard Ethernet 2	Enabled	
Onboard Ethernet 2 Address	08000624xxxx	
Onboard Ethernet 2 Remote Boot	Disabled	
SafeCard functions	Enabled	
Fan Control	Enabled	
Dual view DVI/CRT	Disabled	
Onboard Graphics (IGD)	Auto	

Advanced		
HPET Support	Disabled	
Core Multi-Processing	Enabled (for WinXP, Win Vista)	
	Disabled (for Win2000 and other operating systems)	
VT	Disabled	
Installed O/S	Other	
Reset Configuration Data	No	
Legacy USB support	Enabled	

I/O Device Configuration		
Internal COM 1	Enabled	
Base I/O address	3F8	
Interrupt	IRQ 4	

PCI Configuration		
PCI Device Slot 1		
ROM scan option:	Enabled	
Enable Master	Enabled	
Latency timer	Default	
PCI Device Slot 2		
ROM scan option:	Enabled	
Enable Master	Enabled	
Latency timer	Default	

16.4 BIOS Setup

SATA/PATA Configuration		
PATA Controller:	Enabled	
SATA Controller mode	Enhanced ¹⁾	
AHCI Configuration	Enabled (for RAID systems)	
	Disabled (for non-RAID systems)	
SATA RAID Enable	Enabled (for RAID systems)	
	Disabled (for non-RAID systems)	

Security		
Supervisor password is	Disabled	
User password is	Disabled	
Set User Password	Enter	
Set Supervisor Password	Enter	
Password on boot	Disabled	
Fixed disk boot sector	Standard	

Boot		
Boot priority order:		
Excluded from boot order:		

Version		
SIMATIC PC	SIMATIC BoxPC627	
BIOS Version	V11.02.04	
BIOS Number	A5E00929013-ES004	
CPU Type	Intel® Core™2 CPU T5500	
CPU Speed	1.666 GHz	
CPU ID	06F6	
Code Revision	00C7	

¹⁾ Depends on the ordered device configuration

16.5 Communication processor CP 1616 onboard

16.5.1 Introduction

The CP 1616 onboard allows the connection of industrial PCs to Industrial Ethernet.

The basic characteristics of the PCS 1616 onboard are:

- Optimized for PROFINET IO
- With Ethernet realtime ASIC ERTEC 400
- Three RJ45 sockets for connecting terminal devices or addition network components
- Integrated 3-port real-time switch
- Automatic hardware detection

16.5.1.1 Network connections

Ethernet

The CP 1616 is designed for operation in Ethernet networks. Additional features are:

- The connectors are designed for 10BaseT and 100BaseTX.
- Data transfer rates of 10 and 100 Mbps in full/half duplex mode are supported.
- The handshake is performed automatically (auto negotiation).
- A 3-port realtime switch is located in the module.
- Autocrossing

Three RJ45 connectors

The CP 1616 is connected to the LAN (Local Area Network) via one of the three RJ45 sockets of the PC.

These three sockets lead to the integrated realtime switch.

16.5.1.2 Typical Communication Partners

CP 1616 onboard as an IO controller

The following diagram shows a typical application: CP 1616 onboard as PROFINET IO controller on the IO controller layer.

The IO base controller user program runs on the PC. This program accesses the functions of the IO base user program interface.

Data traffic is routed via the communication processor to several SIMATIC S7 PROFINET IO devices, ET 200S over Industrial Ethernet.

PROFINET IO Controller

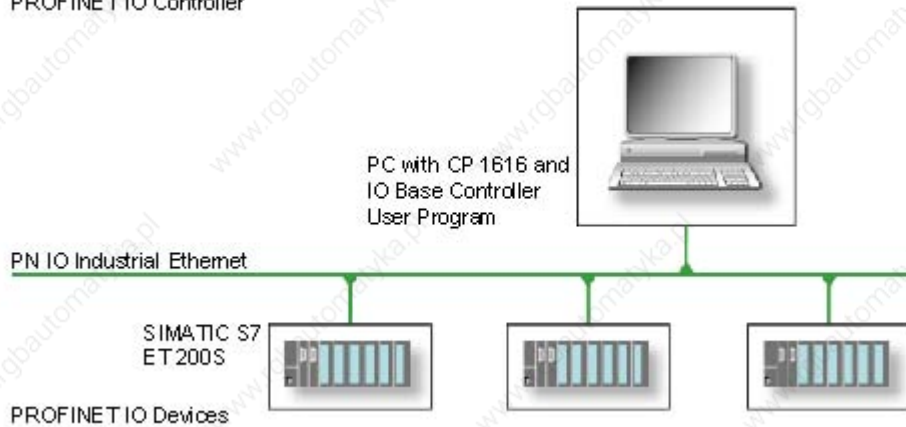

CP 1616 onboard as IO device

The following diagram shows a typical application: Two PCs each with a CP as a PROFINET IO device on the IO device layer.

A PC with a CP as PROFINET IO controller, a SIMATIC S7-400 with a CP 443-1 as PROFINET IO controller and two SIMATIC S7 ET 200S PROFINET IO devices are also connected in the network.

The IO base device user program runs on the IO device PC. This program accesses the functions of the IO base program interface. Data traffic is routed via the CP 1616 onboard communication processor to a PC as PROFINET IO controller or an S7-400 automation system with CP 443-1 over Industrial Ethernet.

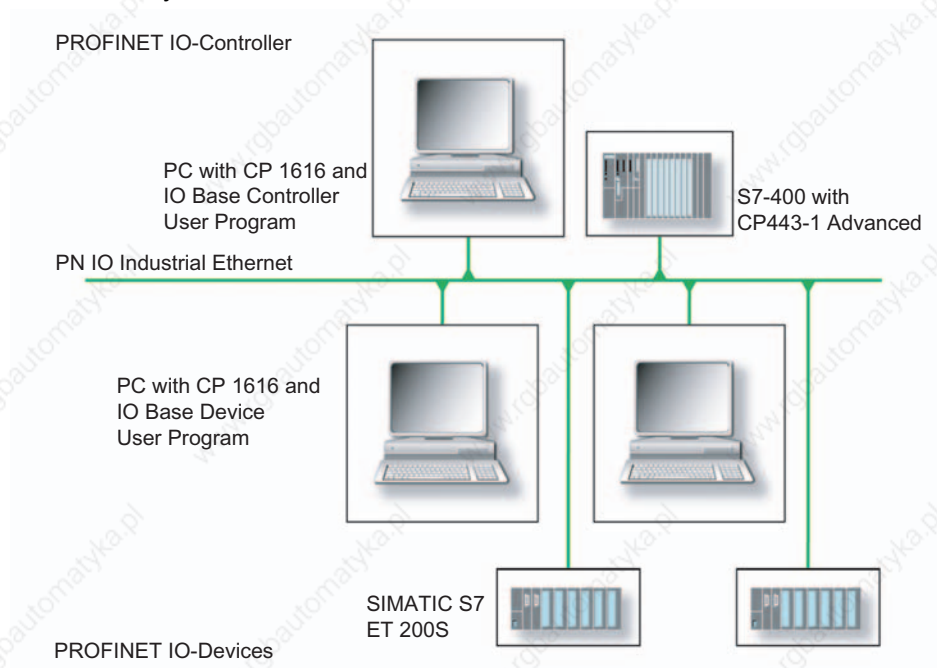

16.5.2 Firmware loader

Scenario for using the firmware loader

The CP 1616 onboard is supplied with the latest version of the firmware. If new functions become available due to product development, you can make them available by performing a firmware download.

Description

This section will familiarize you with the application area and use of the firmware loader. You can find additional, detailed information about the individual loader variants in the integrated help of the program.

Firmware

This refers to the system program in the SIMATIC NET modules.

Application area for the firmware loader

The firmware loader enables you to reload new firmware releases to SIMATIC NET modules. It is used for:

- PROFIBUS modules
- Industrial Ethernet modules
- Modules for gateways, for example IE/PB link

Installation

The firmware loader is available on your PG/PC under Windows following the installation of STEP 7/NCM PC.

Loader files

The firmware loader supports the following file types:

- <File>.FWL
A file format that contains information in addition to the LAD file format, which is displayed by the firmware loader. The firmware loader can use this information to check if the firmware is compatible to the device.
- <File>.LAD
A file format that only contains the system program to be loaded into the module.

Read the information provided along with the loader file, for example, in the readme file. This information is also displayed in the firmware loader when the FWL file is loaded.

16.5.2.1 Loading firmware

Start downloading procedure

1. In the Windows Start menu, select the menu command SIMATIC > STEP 7 > NCM S7 > Firmware Loader.

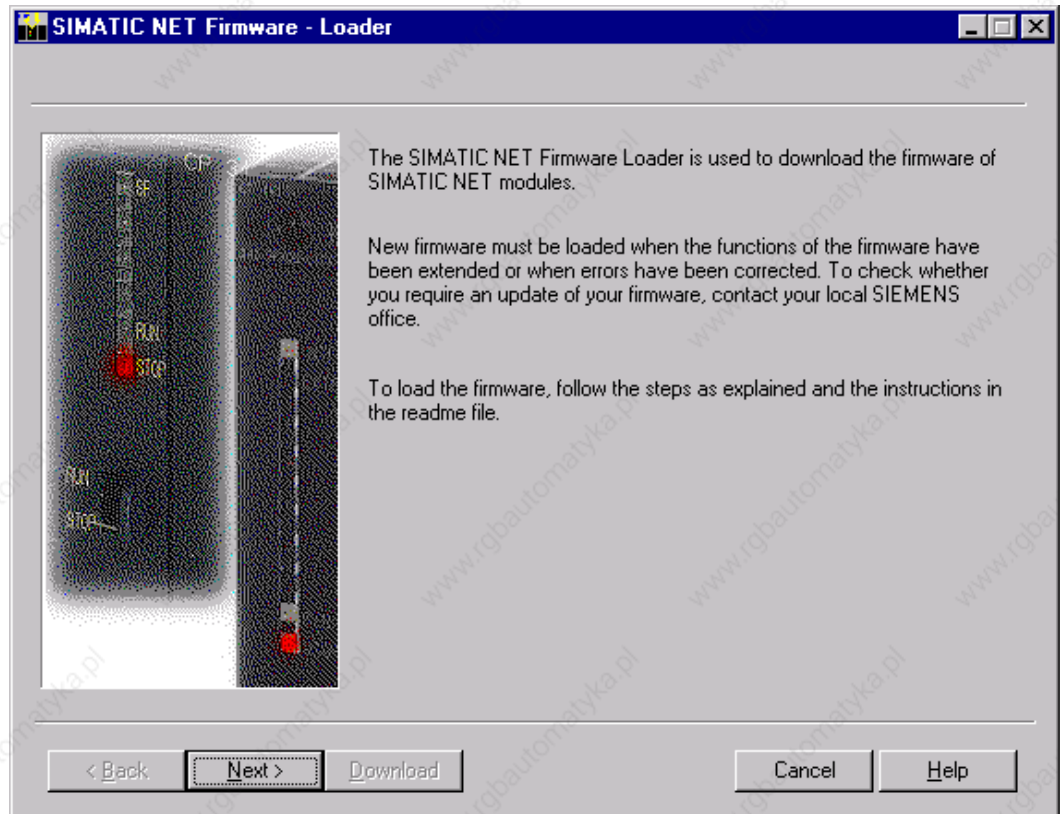

2. Click "Next" and follow the instructions in the dialog fields that follow. A help function is integrated in the software as support.

CAUTION

Ensure that the loader file you are using for the update is suitable for the version of firmware on your module. If you have any doubts, contact your local Siemens consultant.

CAUTION

Be aware that aborting the loading process may result in an inconsistent state in your module.

You can find additional, detailed information about the individual loader variants in the integrated help.

16.5 Communication processor CP 1616 onboard

NOTICE

When loading the firmware or commissioning the module, be aware that the CP 1616 onboard takes five MAC addresses (always in direct sequence). The first two are shown in the BIOS.

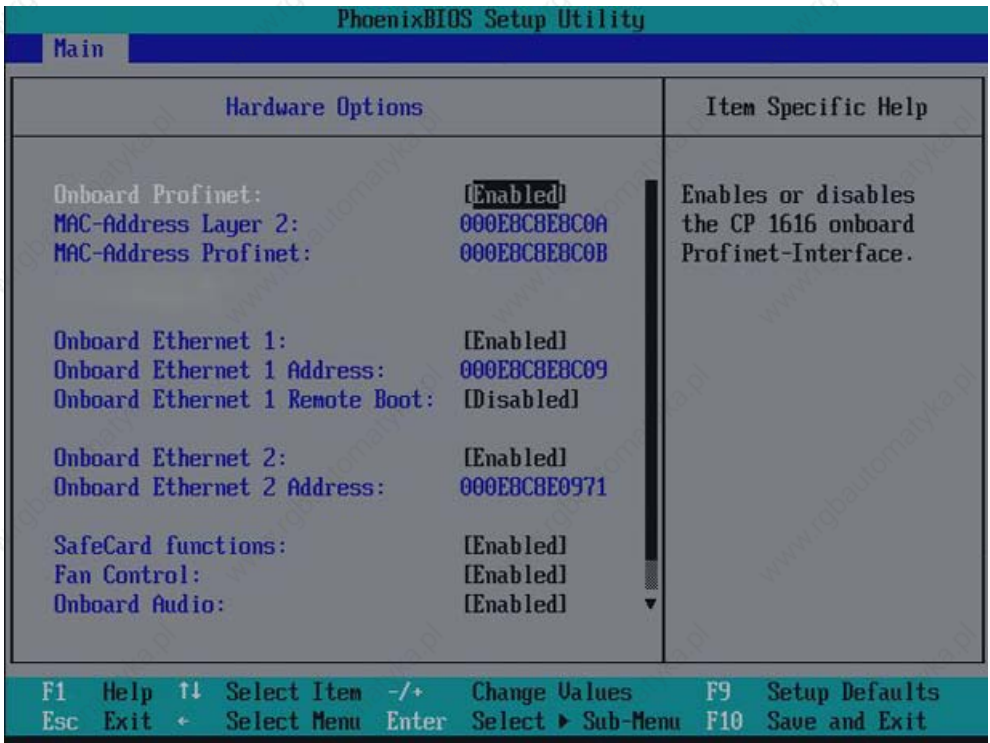

Example

The lowest address is for the layer 2 communication. The second is for Ethernet/PROFINET communication.

16.5.3 Further actions in STEP 7/NCM PC

Configuring

Your PC is now ready, although you still have to configure the SIMATIC NET communication software. The rest of the procedure is described in the "Commissioning PC Stations" manual (on the Windows PC that also contains STEP 7/NCM PC: Start > Simatic > Documentation > English > Commissioning PC Stations).

A

Appendix

A.1 Guidelines and declarations

Notes on the CE Label

CE The following applies to the SIMATIC product described in this documentation:

EMC Directive

The devices fulfill the requirements for the EC directive "2004/108/EEC Electromagnetic Compatibility", and the following fields of application applies according to this CE label:

Fields of application	Requirement for	
	Emitted interference	Immunity to interferences
Residential, business and trade areas and small businesses.	EN 61000-6-3: 2007	EN 61000-6-1: 2007
Industry	EN 61000-6-4: 2007	EN 61000-6-2: 2005

The device is also compliant with EN 61000-3-2:2006 (harmonic currents) and EN 61000-3-3:1995 +A1:2001 +A2:2005 (voltage fluctuation and flicker.)

Low-voltage directive

The devices with AC and DC power supply are compliant with the requirements of the EC Directive 2006/95/EEC "Low-Voltage Directive." Conformance with this directive has been verified according to EN60950-1:2001 +A11:2004.

Declaration of conformity

The EC declaration of conformity and the corresponding documentation are made available to authorities in accordance with the EC directives stated above. Your sales representative can provide these on request.

Note the installation guidelines

The installation guidelines and safety instructions given in this documentation have to be noted during commissioning and operation.

Connecting peripherals

Noise immunity requirements to EN 61000-6-2 are met if connected peripherals are suitable for industrial applications. Peripheral devices are only be connected via shielded cables.

A.2 Certificates and approvals

ISO 9001 certificate

The Siemens quality management system for all production processes (development, production and sales) meets DIN ISO 9001:2000 requirements.

This has been certified by DQS (the German society for the certification of quality management systems).

Q-Net certificate no.: DE-001108 QM

Software License Agreement

The device is shipped with preinstalled software. Please observe the respective license agreements.

Approvals for the USA, Canada and Australia

Product safety

The following approval is available for the device:	
	Underwriters Laboratories (UL) to Standard UL 60950-1, Report E11 5352 and Canadian Standard C22.2 no. 60950-1 (I.T.E), or to UL508 and C22.2 no. 142 (IND.CONT.EQ)

EMC

USA	
Federal Communications Commission Radio Frequency Interference Statement	This equipment has been tested and found to comply with the limits for a Class A digital device, pursuant to Part 15 of the FCC Rules. These limits are designed to provide reasonable protection against harmful interference when the equipment is operated in a commercial environment. This equipment generates, uses, and can radiate radio frequency energy and, if not installed and used in accordance with the instruction manual, may cause harmful interference to radio communications. Operation of this equipment in a residential area is likely to cause harmful interference in which case the user will be required to correct the interference at his own expense.
Shielded Cables	Shielded cables must be used with this equipment to maintain compliance with FCC regulations.
Modifications	Changes or modifications not expressly approved by the manufacturer could void the user's authority to operate the equipment.
Conditions of Operations	This device complies with Part 15 of the FCC Rules. Operation is subject to the following two conditions: (1) this device may not cause harmful interference, and (2) this device must accept any interference received, including interference that may cause undesired operation.

Appendix

A.2 Certificates and approvals

CANADA	
Canadian Notice	This Class A digital apparatus complies with Canadian ICES-003.
Avis Canadian	Cet appareil numérique de la classe B est conforme à la norme NMB-003 du Canada.

AUSTRALIA	
	This product meets the requirements of the AS/NZS CISPR22.

A.3 Service and support

Local information

If you have questions about the products described in this document, you can find help at:
<http://www.siemens.com/automation/partner>

Technical documentation for SIMATIC products

Further documentation for SIMATIC products and systems can be found at:
<http://www.siemens.de/simatic-tech-doku-portal>

Easy Shopping at the Mall

Catalog & online ordering system <http://www.siemens.com/automation/mall>

Training

All the training options are listed at: <http://www.siemens.com/sitrain>

Find a contact at: Phone: +49(911) 895-3200

Technical support

Tel +49 180 5050 222

Fax +49 180 5050 223

<http://www.siemens.com/automation/service>

You will find support request web form at:

<http://www.siemens.de/automation/support-request>

When you contact the customer support, please have the following information for the technician on hand:

- BIOS version
- Order No. (MLFB) of the device
- Installed additional software
- Installed additional hardware

Online support

Information about the product, Support and Service, right through to the Technical Forum, can be found at: <http://www.automation.siemens.com>

After-sales information system for SIMATIC PC / PG

Information about contacts, drivers, and BIOS updates, FAQs and Customer Support can be found at: <http://www.siemens.com/asis>

ESD directives

B.1 ESD directives

Definition of ESD

All electronic modules are equipped with large-scale integrated ICs or components. Due to their design, these electronic elements are highly sensitive to overvoltage, and thus to any electrostatic discharge.

The electrostatic sensitive components/modules are commonly referred to as ESD devices. This is also the international abbreviation for such devices.

ESD modules are identified by the following symbol:



CAUTION

ESD devices can be destroyed by voltages well below the threshold of human perception. These static voltages develop when you touch a component or electrical connection of a device without having drained the static charges present on your body. The electrostatic discharge current may lead to latent failure of a module, that is, this damage may not be significant immediately, but in operation may cause malfunction.

Electrostatic charging

Anyone who is not connected to the electrical potential of their surroundings can be electrostatically charged.

The figure below shows the maximum electrostatic voltage which may build up on a person coming into contact with the materials indicated. These values correspond to IEC 801-2 specifications.

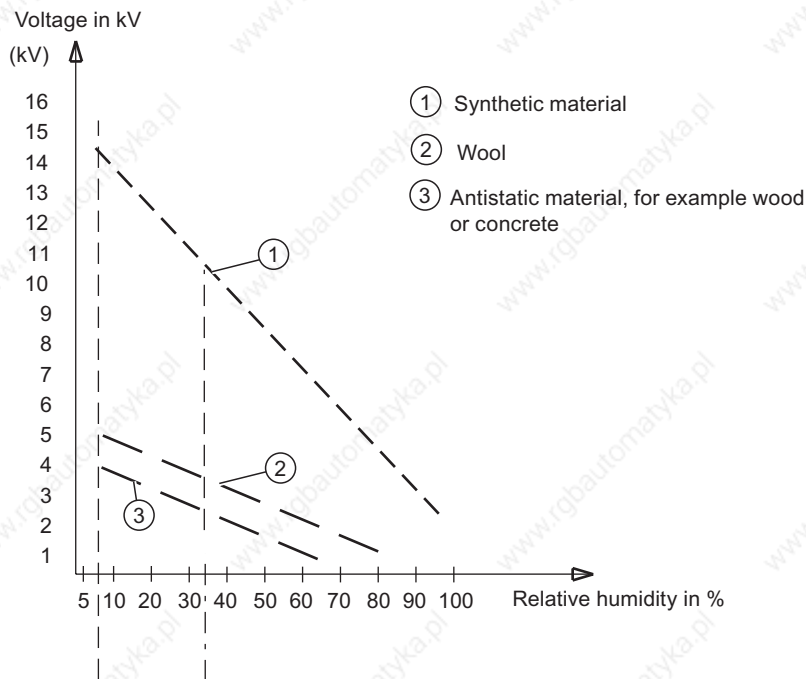

Figure B-1 Electrostatic voltages on an operator

Basic protective measures against electrostatic discharge

- **Ensure good equipotential bonding:**
When handling electrostatic sensitive devices, ensure that your body, the workplace and packaging are grounded. This prevents electrostatic charge.
- **Avoid direct contact:**
As a general rule, only touch electrostatic sensitive devices when this is unavoidable (e.g. during maintenance work). Handle the modules without touching any chip pins or PCB traces. In this way, the discharged energy can not affect the sensitive devices.

Discharge your body before you start taking any measurements on a module. Do so by touching grounded metallic parts. Always use grounded measuring instruments.

C

List of Abbreviations/Acronyms

C.1 Abbreviations

Abbreviation	Term	Meaning
AC	Alternating current	Alternating current
ACPI	Advanced Configuration and Power Interface	
PLC	Programmable controller	
AGP	Accelerated Graphics Port	High speed bus system
AHCI	Advanced Host Controller Interface	Standardized controller interface for SATA devices. This is supported in Microsoft Windows XP as of SP1 and IAA driver.
APIC	Advanced Programmable Interrupt Controller	Extended programmable interrupt controller
APM	Advanced Power Management	Tool for monitoring and reducing power consumption of the PC
AS	Automation system	
ASIS	After Sales Information System	
AT	Advanced Technology	
ATA	Advanced Technology Attachment	
ATX	AT-Bus-Extended	
AWG	American Wire Gauge	US standard for the cable diameter
BIOS	Basic Input Output System	Basic Input Output System
CAN	Controller Area Network	
CD-ROM	Compact Disc – Read Only Memory	Removable storage medium for large data volumes
CD-RW	Compact Disc – Rewritable	Rewritable CD
CE	Communauté Européenne (CE symbol)	The product is in conformance with all applicable EC directives
CF	Compact Flash	
CGA	Color Graphics Adapter	Standard monitor interface
CLK	Clock pulse	Clock signal for controllers
CMOS	Complementary Metal Oxide Semiconductors	Complementary metal oxide semiconductors
COA	Certificate of authentication	Microsoft Windows Product Key

List of Abbreviations/Acronyms

C.1 Abbreviations

Abbreviation	Term	Meaning
CoL	Certificate of License	License authorization
COM	Communications Port	Term for the serial interface
CP	Communication Processor	Communication computer
CPU	Central Processing Unit	CPU
CRT	Cathode Ray Tube	
CSA	Canadian Standards Association	Canadian organization for tests and certifications according to own or binational standards (with UL / USA) standards
CTS	Clear To Send	Clear to send
DRAM	Dynamic Random Access Memory	
DC	Direct Current	DC current
DCD	Data Carrier Detect	Data carrier signal detection
DMA	Direct Memory Access	Direct memory access
DOS	Disk Operating System	Operating system without GUI
DP	Distributed I/Os	
DQS	Deutsche Gesellschaft zur Zertifizierung von Qualitätsmanagement mBH	
DDRAM	Double Data Random Access Memory	Memory chip with high-speed interface
DSR	Data Set Ready	Ready for operation
DTR	Data Terminal Ready	Data terminal is ready
DVD	Digital Versatile Disk	Digital versatile disk
DVI	Digital Visual Interface	Digital display interface
DVI-I	Digital Visual Interface	Digital display interface with digital and VGA signals
ECC	Error Correction Code	Error correction code
ECP	Extended capability port	Extended parallel port
EGA	Enhanced Graphics Adapter	PC to monitor interface
ESD	Components sensitive to electrostatic charge	
EM	Electronic Manual	
EIDE	Enhanced Integrated Drive Electronics	An enhancement of the IDE standard
EISA	Extended Industry Standard Architecture	Extended ISA standard
EMM	Expanded Memory Manager	Manages memory expansions
EM64T	Extended Memory 64 technology	
EN	European standard	
EPROM / EEPROM	Erasable Programmable Read-Only Memory / Electrically Erasable Programmable Read-Only Memory	Plug-in submodules with EPROM/EEPROM chips
EPP	Enhanced Parallel Port	Bi-directional Centronics interface
ESC	Escape character	Control character
EWf	Enhanced Write Filter	
FAQ	Frequently Asked Questions	FAQs
FAT 32	File Allocation Table 32-bit	32-bit file allocation table
FD	Floppy disk	Disk drive, 3.5"

Abbreviation	Term	Meaning
FSB	Front Side Bus	
GND	Ground	Chassis ground
HD	Hard disk	Hard disk
HDA	High Definition Audio	
HDD	Hard Disk Drive	HDD
HU	Height unit	
HMI	Human Machine Interface	User interface
HT	Hyper-Threading	
HTML	Hyper Text Markup Language	Script language for creating Internet pages.
HTTP	Hypertext Transfer Protocol	Protocol for data transfer on the Internet
Hardware	Hardware	
I/O	Input/Output	Data input/output on computers
IAA	Intel Application Accelerator	
IDE	Integrated Device Electronics	
IEC	International Electrotechnical Commission	
IGD	Integrated Graphics Device	
IP	Ingress Protection	Degree of protection
IR	Infrared	Infrared
IRDA	Infrared Data Association	Standard for data transfer via IR module
IRQ	Interrupt Request	Interrupt request
ISA	Industry Standard Architecture	Bus for expansion modules
ITE	Information Technology Equipment	
L2C	Level 2 cache	
LAN	Local Area Network	Computer network that is limited to a local area.
LCD	Liquid Crystal Display	Liquid crystal display
LEDs	Light Emitting Diode	Light emitting diode
LPT	Line Printer	Printer port
LVDS	Low Voltage Differential Signaling	
LW	Drive	
MAC	Media access control	Media access control
MC	Memory Card	Memory card in credit card format
MLFB	Machine-readable product designation	
MMC	Micro Memory Card	Memory card of the format 32 mm x 24.5 mm
MPI	Multipoint-capable interface for programming devices	
MS-DOS	Microsoft Disc Operating System	
MTBF	Mean Time Between Failures	
MUI	Multilanguage User Interface	Language localization in Windows
NA	Not Applicable	

List of Abbreviations/Acronyms

C.1 Abbreviations

Abbreviation	Term	Meaning
NAMUR	Normenarbeitsgemeinschaft for Mess- und Regelungstechnik in der chemischen Industrie (standardization body for instrumentation and control technology in the chemicals industry)	
NC	Not Connected	Not connected
NCQ	Native Command Queuing	Automatic re-sorting of the file and disk access, for increased performance
NEMA	National Electrical Manufacturers Association	Syndicate of manufacturers of electrical components in the USA
NMI	Non Maskable Interrupt	Interrupt the processor can not reject
NTFS	New Techniques File System	Secure file system for Windows versions (2000, XP, Vista)
ODD	Optical Disk Drive	
OPC	OLE for Process Control	Standardized interface for industrial processes
PATA	Parallel ATA	
PC	Personal computer	
PCI	Peripheral Component Interconnect	High-speed expansion bus
PCIe	Peripheral Component Interconnect express	High-speed serial, differential full-duplex PtP interface with high data rate.
PCMCIA	Personal Computer Memory Card International Association	
PE	Protective Earth	Protective conductor
PEG	PCI Express Graphics	
PG	Programming device	
PIC	Programmable Interrupt Controller	Programmable interrupt controller
POST	Power On Self Test	
PXE	Preboot Execution Environment	Software for running new PCs without hard disk data via the network
RAID	Redundant Array of Independent Disks	Redundant hard disk array
RAL	Restricted Access Location	Installation of device in operating facilities with restricted access - for example, a locked switchgear cabinet
RAM	Random Access Memory	
RI	Ring Input	Incoming call
ROM	Read-Only Memory	
RS 485	Reconciliation Sublayer 485	Bi-directional bus system designed for up to 32 nodes
RTC	Real Time Clock	Real-time clock
RTS	Reliable Transfer Service	Request to send
RxD	Receive Data	Data transfer signal
SATA	Serial Advanced Technology Attachment	
SCSI	Small Computer System Interface	
SDRAM	Synchronous DRAM	
SELV	Safety Extra Low Voltage	Safety extra low voltage

Abbreviation	Term	Meaning
SLC	Second Level Cache	
SMART	Self Monitoring Analysis and Reporting Technology	Hard disk error diagnostics program
SMS	Short Message Service	Short message via telecommunication network
SNMP	Simple Network Management Protocol	Network protocol
SO-DIMM	Small Outline Dual Inline Memory Module	
SOM	SafeCard on Motherboard (SOM)	
SPP	Standard Parallel Port	Synonym for parallel port
SVGA	Super Video Graphics Array	Enhanced VGA standard with at least 256 colors
SVP	Serial number of the device	
SW	Software	
TCO	Total Cost of Ownership	
TFT	Thin-Film-Transistor	Type of LCD flat-screen
TTY	Tele Type	Asynchronous data transfer
TxD	Transmit Data	Data transfer signal
TWD	Watchdog Time	Watchdog monitoring time
UL	Underwriters Laboratories Inc.	US organization for tests and certifications according to own or binational standards (with CSA / Canada) standards
UMA	Unified Memory Architecture	Video memory
URL	Uniform Resource Locator	Designation of the full address of an Internet page
USB	Universal Serial Bus	
UXGA	Ultra Extended Graphics Array	Graphic standard, maximum resolution 1600x1200 pixels.
V.24		ITU-T standardized recommendation for data transfer via serial ports
VDE	Verein deutscher Elektrotechniker (Union of German Electrical Engineers)	
VGA	Video Graphics Array	Video adapter which meets industrial standard
VRM	Voltage Regulator Module	
VT	Virtualization Technology	Intel technology with which a virtually closed environment can be made available.
W2k	Windows 2000	
WAV	Wave Length Encoding	Loss-free file format for audio data
WD	Watchdog	Program monitoring with error detection and alarming.
WLAN	Wireless LAN	Wireless local area network
WoL	Wake on Local Area Network	
WWW	World Wide Web	
XGA	Extended Graphics Array	Graphic standard, maximum resolution 1024x768 pixels.

List of Abbreviations/Acronyms

C.1 Abbreviations

Glossary

AHCI mode

AHCI is a standardized method to address the SATA controller. AHCI describes a structure in the RAM, which contains a general area for control and status, as well as a command list.

APIC mode

Advanced peripheral interrupt controller. 24 interrupt lines are available.

ATAPI CD-ROM Drive

AT Bus Attachment Packet Interface (connected to AT bus) CD-ROM drive

Automation system (AS)

A programmable controller (PLC) of the SIMATIC S7 system consist of a central controller, one or several CPUs, and various I/O modules.

Backup

Duplicate of a program, data medium or database, used either for archiving purposes or for the protection of vital and non-replaceable data against loss when the working copy is corrupted. Certain applications automatically generate backup copies of data files, and manage both the current and the previous versions on the hard disk.

Baud

Physical unit for the step speed in signal transmission. Defines the number of transferred signal states per second. With only two states, one baud is equivalent to a transmission rate of 1 bps.

BEEP code

If the BIOS detects a boot error, it outputs an audible warning based on the current test result

Boot disk

A boot disk is a bootstrap disk with "Boot" sector. This can be used to load the operating system from the disk.

Booting

Start or restart of the computer. During booting the operating system is transferred from the system data medium to the work memory.

Cache

High-speed access buffer for interim storage (buffering) of requested data.

CE label

Communauté Européene The CE mark confirms compliance of the product with corresponding EC Directives, for example, with the EMC Directive.

Chipset

Located on the motherboard, connects the processor with the RAM, the graphics controller, the PCI bus, and the external interfaces.

Cold restart

A start sequence, starting when the computer is switched on. The system usually performs some basic hardware checks within the cold start sequence, and then loads the operating system from the hard disk to work memory -> boot

COM interface

The COM interface is a serial V.24 interface. The interface is suitable for asynchronous data transfer.

Compact Flash cards (CF)

Compact Flash is a digital storage medium in card format and without moving parts. The CF card contains the non-volatile memory and the controller. The interface of the CF card corresponds with the IDE interface. CF cards can be operated without additional electronics on PCMCIA or IDE hard disk controllers using a plug and socket adapter. There are two design forms: CF-I (42.6 x 36.4 x 3.3 mm) and CF-II (42.8 x 36.4 x 5 mm).

Configuration files

These are files containing data which define the configuration after restart. Examples of such files are CONFIG.SYS, AUTOEXEC.BAT and the registry files .

Configuration software

The configuration software updates the device configuration when new modules are installed . This is done either by copying the configuration files supplied with the module or by manual configuration using the configuration utility.

Controller

Integrated hardware and software controllers that control the functions of certain internal or peripheral devices (for example, the keyboard controller).

Device configuration

The configuration of a PC or programming device contains information on hardware and device options, such as memory configuration, drive types, monitor, network address, etc. The data are stored in a configuration file and enable the operating system to load the correct device drivers and configure the correct device parameters. . If changes are made to the hardware configuration, the user can change entries in the configuration file using the SETUP program. .

Disc-at-once

With this burning technique, data are written to a CD in a single session, and the CD is then closed. Further write access is then no longer possible.

Drivers

Program parts of the operating system. They adapt user program data to the specific formats required by I/O devices such as hard disk, printers, and monitors.

Dual Core CPU

Dual-core processors significantly increase the speed of computing and program execution compared to the previous generation of single-core processors with hyperthreading technology.

EMC directive

Directive concerning **Electromagnetic Compatibility**. Compliance is confirmed by the CE symbol and the EC certificate of conformity.

Energy management

The energy management functions of a modern PC allow individual control over the current consumption of vital computer components (e.g. of the monitor, hard disk and CPU), by restricting their activity based on the current system or component load. Energy management is of particular importance for mobile PCs.

Energy options

The energy options can be used to reduce energy consumption of the computer, while keeping it ready for immediate use. This can be configured in Windows by selecting Settings > Control Panel > Energy options.

Enhanced Write Filter (EWF)

Configurable write filter that allows you, for example, to boot Windows XP Embedded from write-protected media (such as CD-ROM), to write protect individual partitions and adapt the performance of the file system to your needs (when using Compact Flash cards).

ESD directive

Directive for using electrostatic sensitive components.

Ethernet

Local network (bus structure) for text and data communication with a transfer rate of 10/100/1000 Mbps.

Formatting

Basic partitioning of memory space on a magnetic data medium into tracks and segments. Formatting deletes all data on a data medium. All data media must be formatted prior to their first use.

Gender changer

Using the gender changer (25-pin / 25-pin), the COM1/V24/AG interface of the SIMATIC PC family can be converted to the usual 25-pin male connector.

Hard disk drives

Hard disks represent a form of magnetic disk storage medium (Winchester drives, hard disks) with integrated magnetic disks.

Hot swapping

The SATA interface gives the device's hard drive system hot-swap capability. Prerequisite for this configuration is a RAID1 system with SATA RAID controller (onboard, or slot module), and at least two SATA removable cartridges. The advantage of hot swapping is that defective hard disks can be replaced without having to reboot the computer.

Hub

A term in network technology. In a network, a device joining communication lines at a central location, providing a common connection to all devices on the network.

Hyper Threading

HT technology (multi-threading) enables the parallel computing of processes. HT is only effective when all relevant system components, such as processors, operating systems and applications are supported.

IGD

Integrated Graphics Device. Graphics interface integrated in the chipset.

Image

This refers to the image, for example, of hard disk partitions saved to a file in order to restore them when necessary.

Intel VT

The Intel Virtualization Technology (IVT) is the implementation of a secure closed environment for applications. Special (visualization) software and a VT-capable processor is required for its use.

Interface

See Interface

- Physical interconnection (cable) of hardware elements such as PLCs, PCs, programming devices, printers or monitors.
- Interface for interactive software applications.

Interface, multi-point

MPI is the programming interface of SIMATIC S7/M7. Allows remote access to programmable modules, text-based displays and OPs from central locations. The MPI nodes can intercommunicate.

LAN

Local Area Network: LAN is a local network that consists of a group of computers and other devices that are distributed across a relatively restricted range and are linked with communication cables. The devices connected to a LAN are called nodes. The purpose of networks is the mutual use of files, printers or other resources.

Legacy USB support

Support of USB devices (e.g. mouse, keyboard) on the USB ports without driver.

License key

The license key represents the electronic license stamp of a license. Siemens provides the license keys for protected software.

License key disk

The license key disk contains the authorizations or license keys required to enable protected SIMATIC software.

Low-voltage directive

EC Product Safety Directive relating to the safety of products which are operated on low voltage (50 VAC to 1000 VAC, 70 VDC to 1500 VDC) and not specified in other directives. Compliance is confirmed by the CE symbol and the EC certificate of conformity.

LPT interface

The LPT interface (Centronics interface) is a parallel interface that can be used to connect a printer.

Memory card

Memory cards in credit card format. Memory for user programs and parameters, for example, for programmable modules and CPs.

Module

Modules are plug-in units for PLCs, programming devices or PCs. They are available as local modules, expansion modules, interfaces or mass storage (Mass storage module).

Module retainer

The module retainer is used to fasten modules and ensure safe contact and transport. Shocks and vibrations especially affect large, heavy modules. It is therefore recommended to use the module retainer for this type of module. There are also short, compact and light modules on the market. The module retainer was not designed for these modules because the standard fastening is sufficient for them.

Motherboard

The motherboard is the core of the computer. Here, data are processed and stored, and interfaces and device I/Os are controlled and managed.

NEC Class 2

The "NEC", National Electrical Code, is the USA collection of regulations that generally correspond to German VDE 0100 standards. All USA standards governing the safety of electrical equipment and corresponding "deviations" in IEC standards are based on NEC in terms of their country-specific requirements.

NEC Class 2 specifies higher safety requirements for protection against electric shock and National Fire Protection Association (NFPA) requirements for fire protection. Power supplies operating within the range from 20 VDC to 30 VDC must be equipped with an internal current limiting circuit which safely prevents output power higher than 100 VA.

Operating system

Generic term which describes all functions for controlling and monitoring user program execution, distribution of system resources to the user programs and the operating mode in cooperation with the hardware (for example Windows XP Professional).

Packet writing

The CD-RW is used as a disk medium. The CD can then be read only by packet-writing compatible software or has to be finalized. Finalization of a CD closes the CD within an ISO9660 shell. You can still write to the CD-RW several times in spite of finalization. Not all CD drives can read packet-written CDs. There are restrictions to using this method in general data transfer.

PATA

Interface for hard disk drives and optical drives, with parallel data transmission rate up to 100 Mbps.

PC card

Trademark of the Personal Computer Memory Card International Association (PCMCIA). Designation for auxiliary cards that conform with PCMCIA specifications. A PC card that has roughly the size of a credit card can be plugged into a PCMCIA slot. Version 1 specifies cards of Type I with a thickness of 3.3 millimeters, which are designed mainly for use as external memory. Version 2 of the PCMCIA specification also defines cards of Type II with a thickness of 5 mm and cards of Type III with a thickness of 10.5 mm. Type II cards can realize devices such as modems, fax cards and network interface cards. Type III cards are equipped with devices that require more space, for example wireless communication modules, or rotary storage media such as hard disk drives, for example.

PC/104 / PC/104-Plus

Two bus architectures are especially fashionable today in the industrial world. PC/104 and PC/104-*Plus*. Both are standard in single-board computers of the PC class. The electrical and logical layout of the two bus systems is identical with ISA (PC/104) and PCI (PC/104-*Plus*). Software cannot usually detect a difference between them and normal desktop bus systems. Their advantage is the compact design and the resulting space they save.

PCMCIA

Association consisting of approx. 450 member companies of the computer industry whose focus is set on providing worldwide standards for miniaturization and flexible use of PC expansion cards in order to provide basic technologies to the market.

PEG interface

PCI Express for Graphics. Graphics interface with 16 PCIe lanes for expansions with graphics modules.

PIC mode

Peripheral interrupt controller. 15 interrupt lines are available.

Pixel

Pixel (picture point). The pixel represents the smallest element that can be reproduced on-screen or on a printer.

Plug&Play

Generally, a reference to the ability of a computer to automatically configure the system for communication with peripheral devices (for example monitors, modems or printers). The user can plug in a peripheral and "play" it at once without manually configuring the system. A Plug&Play PC requires both a BIOS that supports Plug&Play and a Plug&Play expansion card.

POST

Self-test performed by the BIOS after the computer is switched on. Performs a RAM test and a graphics controller test, for example. The system outputs audible signals (beep codes) if the BIOS detects any errors; the relevant message indicating cause of error is output on the screen.

PROFIBUS/MPI

Process Field Bus (standard bus system for process applications)

PROFINET

PROFINET is the name of the standard for Industrial Ethernet developed and maintained by the PROFIBUS user organization. PROFINET unites protocols and specifications with which Industrial Ethernet meets the requirements of industrial automation technology.

Programmable controller (PLC)

The programmable controllers (PLC) of the SIMATIC S5 system consist of a central controller, one or more CPUs, and various other modules (e.g. I/O modules).

PXE server

A **Preboot Execution Environment** server is part of a network environment and can provide software to connected computers even before they boot. This can involve operating system installations or servicing tools, for example.

RAID

Redundant Array of Independent Disks: Data storage system which is used to save data and the corresponding error correction codes (parity bits, for example) to at least two hard disk volumes in order to enhance reliability and performance. The hard disk array is controlled by management programs and a hard disk controller for error correction. The RAID system is usually implemented in network servers.

Recovery CD

Contains the tools for configuring hard disks and the Windows operating system.

Reset

Hardware reset: Reset/restart of the PC using a button/switch.

Restart

Warm restart of a computer without switching the power off (Ctrl + Alt + Del)

Restore DVD

The Restore DVD is used to restore the system partition or the entire hard disk to factory state if the system has crashed. The bootable DVD contains all the necessary image files. You can also create a boot disk allowing restoration via the network.

ROM

Read-Only Memory ROM is a read-only memory in which every memory location can be addressed individually. The programs or data are permanently stored and are not lost in the event of a power failure.

SCSI interface

Small Computer System Interface Interface for connecting SCSI devices such as hard disk drives or optical drives.

Session at once

In session at once, the CD can be written to both with an audio session and a data session. The two sessions are written to at once (as in disc at once).

SETUP (BIOS Setup)

A program in which information about the device configuration (that is the configuration of the hardware on the PC/PG) is defined. The device configuration of the PC/PG is preset with defaults. Changes must therefore be entered in the SETUP if a memory expansion, new modules or a new drive are added to the hardware configuration.

STEP 7

Programming software for the creation of user programs for SIMATIC S7 controllers.

Track-at-once

In track-at-once recording, a CD can be written to in bits in several sessions if the CD was not closed.

Troubleshooting

Error cause, cause analysis, remedy

V.24 interface

V.24 is a standardized interface for data transfer. Printers, modems, and other hardware modules can be connected to a V.24 interface.

Wake on LAN (WoL)

Wake on Local area network. This function enables the PC to be started via the LAN interface.

Warm restart

The restart of a computer after a program was aborted. The operating system is loaded and restarted again. The CTRL+ ALT+ DEL hotkey can be used to initiate a warm restart.

Windows

Microsoft Windows is a multitasking graphical user interface. Windows provides a standard graphical interface based on drop-down menus, windowed regions on the screen, and allows operation with a pointer device such as a mouse.

WLAN

Wireless LAN is a local network that transmits data via radio waves, infrared light or another wireless technology. Wireless LAN is mainly used for mobile computer applications in office or factory environments.

Index

2

- 24 V DC power supply, 25
 - Connecting, 42

A

- Abbreviations, 221, 226
- AC power supply, 24, 136
- Accessories, 17
- Allocation of resources, 71
- Antivirus software, 46
- Application areas, 14
- Approvals, 31
- Assignment
 - I/O addresses, 171
 - Memory addresses, 177

B

- Backup battery, 163
- Battery, 12
- Battery monitoring, 64
- Battery replacement, 87
- BEEP codes, 125
- Benefits, 14
- BIOS, 146
 - Beep codes, 125
- BIOS Setup, 178
 - Defaults, 204
 - Menu layout, 180
 - Menus, 180
 - Starting, 179
- BIOS Setup menus
 - Advanced, 193
 - Boot, 201
 - Main, 182
 - Security, 199
 - Version, 202
- Boot options, 187
- Boot sequence
 - Error messages, 123
- Booting

- Error messages, 123

- Bottom, 21
- Burner / DVD software, 120
- Burner software, 47
- Bus board
 - Design, 165
 - Removing, 91

C

- CE label, 213
- Certificates, 215
- Certifications and approvals, 215
- Characteristics, 16
- Chip set, 146
- Climatic conditions, 132
- COA label, 30
- COM1, 134
- Compact Flash card, 23, 77
 - Features, 52
 - Mounting, 79
 - Partitions, 112
 - Removing, 80
- Connecting
 - 24 V DC power supply, 42
 - Peripherals, 39, 214
- Connection
 - Power supply 120/230 V AC, 40
- Connection components, 23
- Connector pin assignment
 - PCI Express slot, 169
- Connector pin assignment
 - PCI slot, 167
- CPU, 146

D

- Data backup, 121
- Data exchange, 55
- Declaration of conformity, 213
- Degree of protection, 131
- Design
 - Bus board, 165
 - Motherboard, 145

Device

- Open, 66
- Switching off, 46
- Unpacking, 29
- Device configuration, 204
- Device fan, 94, 96
- Device fan supply, 162
- DiagMonitor
 - Expansion, 18
 - Temperature monitoring, 59
- Diagnostics
 - BIOS beep codes, 125
 - DiagMonitor, 59
 - Troubleshooting, 127
- Dimensional drawings
 - Device, 140
 - Expansion modules, 143
- Dimensions, 131
- Directives
 - ESD directives, 219
- Disk drives, 133
- Display
 - Ports, 156
- Display interfaces, 24
- Drive bay module, 72
 - Removing, 74
- Driver installation, 113
- DVD burner, 47, 133, 146
- DVD burner drive
 - Removing, 75
- DVI/VGA port, 23

E

- Electrostatic sensitive devices, 12, 219
- EMC, 215
- EMC directive, 213
- Equipotential bonding terminal, 43
- Error messages
 - BIOS beep codes, 125
 - Booting, 123
- ESD directives, 12, 219
- Ethernet, 134
- ETHERNET interface, 23
- Ethernet RJ45 port, 17
- Ethernet strain relief, 44
- expansion, 18
- Expansion
 - Memory, 67
- Expansion modules
 - Mounting, 70
- Expansion slots, 16, 133

F

- Factory state, 104
- Fan
 - Removing, 94, 96
- Fan monitoring, 60
- Firewall, 46
- First commissioning, 45
- Flash drive
 - Booting, 53
 - Functionality, 52
- Front ports, 159
- Front view, 20

G

- Graphic controller, 133
- Graphics, 146

H

- Hard disk
 - Removing, 76
- Hard disk drive, 133
- Hard disk drives, 16
- Hard disks
 - Partitioning, 105
 - Partitions, 48, 49
- Hardware Options, 190

I

- I/O addresses
 - Assignment, 171
 - Assignment, 171
- I/O front ports, 159
- IDE channel, 183
- Identification data, 30
- IEC power connector, 24
- Image
 - creating, 121
- Installation
 - Burner / DVD software, 120
 - Memory modules, 68
- Interfaces, 23
 - Operator panels, 24
 - PROFIBUS, 55, 134
 - PROFIBUS/MPI, 17, 23, 55, 56
 - USB, 17, 23, 134
- Interfaces assignment on the motherboard
 - COM2 (X31), 155
- Internal interfaces, 161

Interrupt reaction time, 176

K

Keyboard

Features, 189

L

Language selection

Windows 2000, 105

Windows Vista, 111

Windows XP, 108

License key, 101, 103

Lithium battery, 86

Localized information, 41

Low-voltage directive, 213

LVDS

Ports, 156

M

Main memory, 16, 133

Mech. Environmental Conditions, 132

Memory, 146

Memory addresses

Assignment, 177

Memory Cache, 186

Memory configuration, 69

Memory expansion, 67

memory modules

Removing, 69

Memory modules

Installation, 68

Messages

BIOS beep codes, 125

Modules

Module bracket, 70

Monitoring

DiagMonitor, 59

Safecard On Motherboard, 59, 61

Status displays, 26

Temperature, 59

Watchdog, 60

Monitoring functions, 15

Motherboard, 133

Design, 145

Features, 146

Internal interfaces, 161

Location of the interfaces, 148

Removal, 92

Mounting

Modules, 70

Mounting angle

Screw-mounting, 35, 36, 37

Multilanguage User Interface, 105

O

On / Off switch, 22

Onboard Ethernet, 191

Online ordering system, 56

Open

Device, 66

Operating system

First commissioning, 45

Updates, 120

Windows 2000, 106

Windows Vista, 109

Windows XP, 106

Windows XP Embedded, 112

Windows XP Professional, 104

Operating systems, 18

Operator panels, 24

Output voltages, 136, 137

P

Partitioning

Hard disks, 105

Windows XP Embedded, 112

Windows XP Professional, 112

Partitions

Hard disks, 48, 49

PCI / AT cards

Specifications, 133

PCI configuration, 197

PCI Devices, 198

PCI Express

Connector pin assignment, 169

PCI hardware interrupt, 176

PCI slot

Connector pin assignment, 167

Peripherals, 39

Connecting, 214

Permitted mounting positions, 32

Port pin assignments

CF card, 154

COM1, 155

DVI, 153

Ethernet, 152

PROFIBUS/MPI, 150

USB, 149

Ports, 134, 148
 COM, 23, 134
 Display, 156
 Ethernet, 134, 147
 Ethernet, 151
 ETHERNET, 23
 Ethernet RJ 45, 55
 LVDS, 156
 PROFIBUS/MPI, 146
 RJ45 Ethernet, 17, 191
 USB, 147
 VGA, 17, 23
POST codes
 BIOS beep codes, 125
Power consumption, 131
Power factor correction, 136
Power Good signal, 136
Power requirements, 135
Power supply, 16, 25, 40
 AC voltage supply, 136
 DC voltage supply, 137
 IEC power connector, 24
 WinAC module, 168
Power supply unit
 Removing, 89
Processor, 16, 133
 Latch, 99
 Replacement, 98
PROFIBUS, 55, 134
PROFIBUS/MPI, 55, 56
PROFIBUS/MPI interface, 17, 23

R

RAID controller software, 119
RAID Level 1, 50
RAID system
 Creation, 118
 Management functions, 50
Rating plate, 30
Rear view, 20
Recovery
 Windows Vista, 109
Recovery CD, 106, 107
Recovery functions, 107
Removing
 Bus board, 91
 Drive bay module, 74
 DVD burner drive, 75
 Fan, 94, 96
 Hard disk, 76
 memory modules, 69

Motherboard, 92
 Power supply, 89
 Processor, 98
Repairs, 11
 Tools, 85
Replacing
 Battery, 86
Restart, 45
Restore CD, 101
Restore DVD, 103
Restoring factory state, 102
RJ45 Ethernet, 55, 151, 152

S

Safecard On Motherboard
 Temperature monitoring, 61
Safety information, 11
SATA Port, 185
SATA/PATA Configuration, 195
Serial interface, 23
Side view, 21
SIMATIC S7, 55
Slot cover, 70
SOFTNET S7, 55
SOM, 61
Specifications, 131
Status display, 27, 62
Status displays, 26, 134
Strain relief
 Ethernet cable, 44
Summary Screen, 188
Supply voltage, 41, 131
Switching off
 Device, 46
System expansions, 11
System partition, 101, 103
System resources, 170
 I/O address allocation, 171

T

Temperature, 132
 Fan monitoring, 60
 Monitoring, 59
Temperature error, 129
Third-party modules, 128
Tools
 Repairs, 85
Transport, 29
Troubleshooting/FAQs, 127

U

Updates

Operating system, 120

User programs and drives, 120

USB interface, 17, 23

V

Vent slots, 31

VGA port, 17, 23

W

Warranty, 11

Watchdog

Monitoring function, 60

Monitoring times, 60

Weight, 131

WinAC module

Power supply connection, 168

Windows 2000

Partitioning the hard disk, 106

Windows Security Center, 46

Windows Vista

Recovery, 109

Windows XP

Language selection, 108

Partitioning the hard disk, 106

Windows XP Embedded, 19

Partitioning the hard disk, 112

Reinstalling the Operating System, 101

Windows XP Professional

Partitioning the hard disk, 112

Reinstalling the operating system, 103

