

TMC 66

Test Monitoring Unit with integrated muting controller





Notes on Connecting and Operating Instructions

This connecting and operating instructions manual contains information on the proper use of the test monitoring unit with integrated muting controller TMC 66 in accordance with its intended purpose.



All the information contained herein, in particular the safety notes, need to be carefully observed.

Notes regarding safety and warnings are marked by this symbol .

Notes regarding important pieces of information are marked by the symbol .

This connecting and operating instructions manual must be stored carefully. It must be available for the entire operating time of the test monitoring unit with integrated muting controller TMC 66.

The Leuze electronic GmbH + Co. KG is not liable for damages caused by improper use. Acquaintance with these instructions is an element of the knowledge required for proper use.

© Reprints and reproduction, in whole or in part, are permitted only with the explicit permission of

Leuze electronic GmbH + Co. KG
In der Braike 1
D-73277 Owen - Teck / Germany
Telefon+49 (0) 7021 / 573-0
Fax+49 (0) 7021 / 573-199
info@leuze.de
www.leuze.com

1	General Information	5
1.1	Certifications	5
1.2	General Information	5
1.3	Definition of Terms	5
1.4	Selection of Active Opto-electronic Protective Devices	6
2	Safety	8
2.1	Approved purpose and foreseeable improper operation	8
2.1.1	Proper use.....	8
2.1.2	Foreseeable misuse.....	10
2.2	Competent personnel.....	10
2.3	Responsibility for safety	10
2.4	Exemption of liability	11
2.5	Fields of Application	11
2.6	Organizing Measures.....	11
3	Function and Commissioning.....	12
3.1	Function Characteristics of the Safety System	12
3.2	Display and Operating Instruments.....	13
3.2.1	Overview - Display and Operating Elements	13
4	Mounting of the Safety System.....	15
4.1	Mounting of the Test Monitoring Unit TMC 66	15
4.2	Mounting of the Single Beam Safety Light Barrier	15
4.2.1	Multi-axis Installation	17
4.2.2	Muting Basics.....	19
5	Electrical Installation	25
5.1	Supply Wiring	25
5.2	Start Input Wiring	25
5.3	Wiring of Single-beam Single Beam Safety Light Barriers	27
5.4	Wiring of Single Beam Safety Light Barrier in Series Connection.....	28
5.5	Wiring Control Signals.....	29
5.6	Wiring of the muting light signals	29
5.7	Wiring of the Muting Signals Start 1 and Start 2	30
5.8	Wiring Safety Output.....	32
5.9	Wiring of the Signal Outputs	33
5.10	Selecting of the Operating Mode.....	35
5.11	Starting the unit when the single beam safety light barrier is interrupted.....	36
5.12	Operating Conditions without Muting Function	37
5.13	TMC 66 without muting function, with start- and restart interlock	38
5.14	Modes with muting function.....	40

6	Error Messages on the TMC 66	46
7	Technical Data.....	48
8	Appendix.....	50
8.1	Wiring diagram with Single Beam Safety Light Barrier and PLC as muting sender.....	50
8.2	Remaining risks (EN ISO 12100-1).....	50

1 General Information

1.1 Certifications

The test monitoring unit with integrated muting controller TMC 66 has been manufactured observing current European directives and international standards.

The manufacturer of the test monitoring unit TMC 66, Leuze electronic GmbH+Co. KG in D-73277 Owen/Teck, possesses a certified quality assurance system in accordance with ISO 9001.



1.2 General Information

An active optoelectronic protective device is part of the electrical equipment which has to be applied to those machines which contain the potential risk of bodily injury. They provide protection by causing the machine to move into a safe operating state before a person can get into a dangerous situation (EN 61496-1).

1.3 Definition of Terms

AOPD type 2

The EN 61496 describes two types of active active opto-electronic protective devices (AOPD) with respect to the requirements concerning safety relevant parts of control units (ISO 13849-1).

The AOPD type 2 fulfills the requirements of category 2 acc. to ISO 13849-1. A periodic function test has to detect malfunctions in the safety function. In case of a failure, the next machine cycle may not be released. A malfunction of the AOPD type 2 between the testings can cause the loss of the safety function. In normal function, at least one safety output of the AOPD type 2 has to move into the OFF-position if the sensor reacts or if the power supply of the AOPD is interrupted.

Safety output (OSSD)

The part of the AOPD which is connected to the machine control and which moves into the OFF-position as soon as the sensor part reacts during normal operation.

Start interlock

An equipment which disables the automatic machine start if the power supply of the contactless active protective device is switched on or if it had been interrupted and switched on again.

Start testing

A manual or automatic test which is performed after the contactless active protective device has been switched on. It tests the complete safety-relevant control system before the normal machine operation is induced.

Muting

The intentional bypassing of the safety function, e.g. during material transport into the hazardous area.

Muting sensors

Muting sensors differentiate between persons and transported material. If the muting sensors are activated simultaneously or in the intended order, the safety function of the AOPD is bypassed. Material can be brought into the hazardous area without taking the machine out of operation.

Contactors monitoring

The contactor monitoring checks before every release of the switching outputs if the succeeding contactors are open. Only then, a new release is possible.

Restart interlock

An equipment which disables the automatic restart of the machine after the sensor part has reacted during a dangerous part of the machine cycle, a change of the operating mode, and/or operator mode of the machine.

1.4 Selection of Active Opto-electronic Protective Devices

The following strategy is to be applied (iterative process):

1. Determination of the protected area
2. Determination of the protective function
 - Finger or hand protection
 - Access protection for persons
 - Presence detection
3. Determination of the control category
4. Calculation of the safety distance

Determination of the protected area

Through risk calculation, the following has to be observed:

- the size of the protective field
- the access points
- the hazardous areas
- Bypassing possibilities

Determination of the protective function

Finger and hand protection:	The user is close to the hazardous area.
Access protection:	Access to the hazardous area is protected.
Presence detection:	A hazardous area which is completely surrounded by permanently installed protective devices is monitored for presence of objects or access protection and presence detection are combined.

2 Safety

Before using the Test Monitoring Unit, a risk evaluation must be performed according to valid standards (e.g. EN ISO 14121, EN ISO 12100-1, ISO 13849-1, IEC 61508, EN 62061). The result of the risk assessment determines the required safety level of the Test Monitoring Unit (see Tabelle 2.1-1). For mounting, operating and testing, document "TMC 66 Test Monitoring Units with integrated muting controller" as well as all applicable national and international standards, regulations, rules and directives must be observed. Relevant and supplied documents must be observed, printed out and handed to the affected personnel.

Before working with the Test Monitoring Unit, completely read and understand the documents applicable to your task.

In particular, the following national and international legal regulations apply for the start-up, technical inspections and work with Test Monitoring Units:

- Machinery directive 2006/42/EC
- Low voltage directive 2006/95/EC
- Electromagnetic compatibility directive 2004/108/EC
- Use of Work Equipment Directive 89/655/EEC supplemented by Directive 95/63 EC
- OSHA 1910 Subpart O
- Safety regulations
- Accident-prevention regulations and safety rules
- Ordinance on Industrial Safety and Health and Labor Protection Act
- Device Safety Act

Notice!

For safety-related information you may also contact the local authorities (e.g., industrial inspectorate, employer's liability insurance association, labor inspectorate, occupational safety and health authority).

2.1 Approved purpose and foreseeable improper operation

Warning!

A running machine can cause severe injuries!

Make certain that, during all conversions, maintenance work and inspections, the system is securely shut down and protected against being restarted again.

2.1.1 Proper use

The Test Monitoring Unit must only be used after it has been selected in accordance with the respectively applicable instructions and relevant standards, rules and regulations regarding labor protection and occupational safety, and after it has been installed on the machine, connected, commissioned, and checked by a **competent person**.

When selecting the Test Monitoring Unit it must be ensured that its safety-related capability meets or exceeds the required performance level PL_r ascertained in the risk assessment.

Listed in the following table are the safety-related characteristic parameters of the TMC 66 Test Monitoring Units with integrated muting controller.

Type in accordance with IEC/ EN 61496	Type 2
Performance Level (PL) in accordance with ISO 13849-1: 2008	PL d
Category in accordance with ISO 13849-1	Cat. 2
Mean probability of a dangerous failure per hour (PFH_d) as a function of the mean number of annual switching cycles of the relay n_{op}*	n _{op} = 4,800: 1.4 x 10 ⁻⁸ 1/h n _{op} = 28,800: 3.1 x 10 ⁻⁸ 1/h n _{op} = 86,400: 7.9 x 10 ⁻⁸ 1/h
Mean time to dangerous failure (MTTF_d)	n _{op} = 4,800: 250 years n _{op} = 28,800: 100 years n _{op} = 86,400: 40 years
*n _{op} = mean number of annual actuations, see C.4.2 and C.4.3 of ISO 13849-1: 2008 Use the following formula to calculate the mean number of annual actuations: $n_{op} = (d_{op} \cdot h_{op} \cdot 3600s/h) \div t_{Zyklus}$ In doing so, make the following assumptions with regard to the use of the component: h _{op} = mean operating time in hours per day d _{op} = mean operating time in days per year t _{cycle} = mean time between the start of two successive cycles of the component (e.g switching of a valve) in seconds per cycle	

Table 2.1-1: Safety-related characteristic parameters of the TMC 66 Test Monitoring Units with integrated muting controller.

- The Test Monitoring Unit is used in combination with one or more Multiple Light Beam Safety Devices or Safety Light Curtains to safeguard danger zones or points of operation.
- The control of the machine or system that is to be safeguarded must be electrically influenceable. A switch command initiated by a TMC 66 must result in an immediate shutdown of the dangerous movement.
- The "Reset" acknowledgment button for unlocking the start/restart interlock must be mounted in such a way that the entire danger zone can be seen from its mounting location.
- Message outputs (state outputs) must not be used for switching safety-relevant signals.
- The Test Monitoring Unit is designed for installation in a cabinet or a protective housing with a protection rating of at least IP 54.
- The 24 V DC ±20% power supply must guarantee safe isolation from the mains voltage and be able to bridge a power outage period of 20 ms.

- Depending on external wiring, dangerous voltages may be present at the switching outputs. In addition to the power supply, these must be switched off and safeguarded against being switched back on prior to all work on the TMC 66.
- These operating instructions must be included with the documentation of the machine on which the protective device is installed so that they are available to the operator at all times.
- Manipulating the Test Monitoring Unit also voids all warranty claims against the manufacturer of the Test Monitoring Unit.
- The Test Monitoring Unit must be tested regularly by competent personnel.
- The safety distance between the AOPD and the point of operation is to be maintained. It is calculated according to the formulas for machine-specific C standards or given in the general B1 standard ISO 13855. The reaction time of the Test Monitoring Unit and the braking time of the machine must be taken into account.
- Two switching contacts must always be looped into the switch-off circuit of the machine. To prevent welding, relay switching contacts must be fused/protected externally according to the technical data.

The Test Monitoring Unit must be exchanged after a maximum of 20 years. Repairs or the exchange of parts subject to wear and tear do not extend the service life.

2.1.2 Foreseeable misuse

Any use other than that defined under the "intended use" or which goes beyond that use is considered improper use!

e.g.

- applications in explosive or easily flammable atmospheres

Attention!

Such instances can jeopardize the health and lives of the personnel operating the machinery and/or may cause damage to property.

2.2 Competent personnel

Prerequisites for competent personnel:

- he has a suitable technical education
 - he knows the rules and regulations for occupational safety, safety at work and safety technology and can assess the safety of the machine
 - he knows the instructions for the Test Monitoring Unit and the machine
- he has been instructed by the responsible person on the mounting and operation of the machine and of the Test Monitoring Unit

2.3 Responsibility for safety

Manufacturer and operating company must ensure that the machine and implemented Test Monitoring Unit function properly and that all affected persons are adequately informed and trained.

The type and content of all imparted information must not lead to unsafe actions by users.

The manufacturer of the machine is responsible for:

- safe machine construction
- safe implementation of the Test Monitoring Unit
- imparting all relevant information to the operating company
- adhering to all regulations and directives for the safe starting-up of the machine

The company operating the machine is responsible for:

- instructing the operating personnel
- maintaining the safe operation of the machine
- adhering to all regulations and directives for occupational safety and safety at work
- regular testing by competent personnel

2.4 Exemption of liability

Leuze electronic GmbH + Co. KG is not liable in the following cases:

- Test Monitoring Unit is not used as intended
- safety notices are not adhered to
- reasonably foreseeable misuse is not taken into account
- mounting and electrical connection are not properly performed
- proper function is not tested
- changes are made to the Test Monitoring Unit

2.5 Fields of Application

The test monitoring unit TMC 66 may be used as isolating protective device for safeguarding of hazardous areas on power driven machines.

The following areas of application are thus possible (excerpt):

- Edge, frame, star and carcass press in lumber industry acc. to prEN 691 resp. ZH 1/3.19
- Printing and paper processing machines acc. to prEN 1010
- Power driven windows, doors and portals acc. to ZH 1/494
- Storage equipment and devices acc. to ZH 1/482 and DIN 15185 part 2
- Textile machines acc. to VBG and DIN EN ISO 11 111
- Food processing equipment acc. to prEN 1672-1 resp. VBG 77
- Packaging machinery acc. to prEN 415-1 to -7 resp. VBG 76
- Meat processing equipment acc. to prEN 12463 resp. VBG 79
- Machines of the chemical, rubber and plastic industry acc. to VBG 22

2.6 Organizing Measures

Mounting, commissioning and maintenance of the device must only be carried out by qualified personnel. Electrical work must be carried out by a certified electrician.

Adjustment and change of the protective field for the protection of persons may only be carried out by an authorized person.

3 Function and Commissioning

3.1 Function Characteristics of the Safety System

The complete safety system consists of a TMC 66 and accompanying single beam safety light barriers or light barriers.

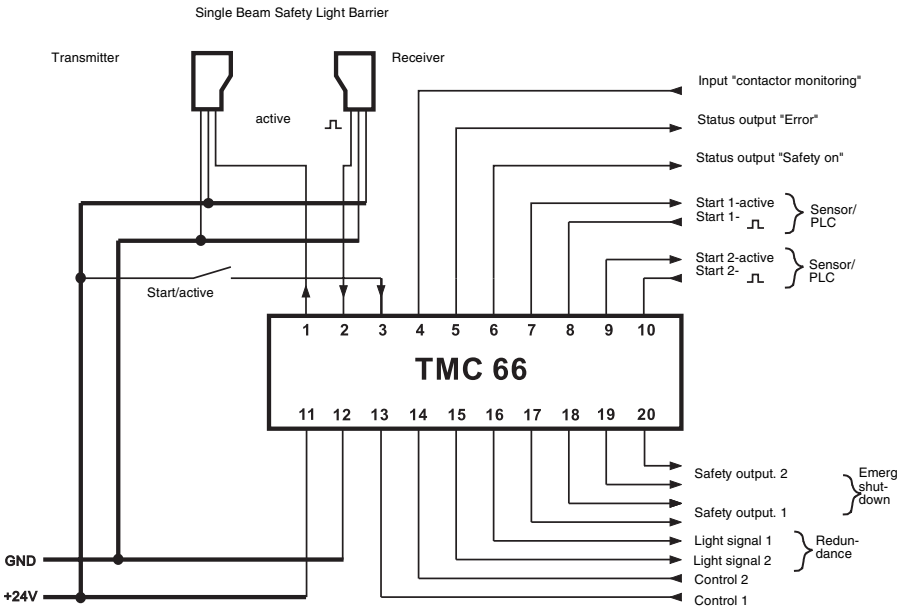

Fig. 3.1-1: Architecture of the TMC safety system

After switching on of the TMC 66 via the start input, the function of the connected single beam safety light barriers or the integrated muting controller is cyclically monitored every 2 sec.

The electrical integration into the control has to be performed acc. to the corresponding safety category acc. to ISO 13849-1. The voltage free safety relay outputs can be directly used for shut-down of the dangerous movement.

Inside the test monitoring unit TMC 66, a selectable start- and restart interlock, as well as a selectable contactor monitoring input are integrated.

3.2 Display and Operating Instruments

Inside the test monitoring unit TMC 66, LEDs and a 7-segment display for the system state are integrated.

The selection switch of the start- and restart interlock as well as the contactor monitoring are also located on the front panel under the transparent front screen.

The front screen can be removed for commissioning and for adjustment of start- and restart interlock as well as contactor monitoring (see Figure 3.2-2).

3.2.1 Overview - Display and Operating Elements

- LED 1 Status display protective field state
- LED 2 Status display start/ activation input
- LED 3 Status display start and restart interlock
- LED 4 Status display contactor monitoring
- LED 5 Status display safety circuit closed
- LED 6 Status display safety circuit open
- LED 7 Status display muting sensor Start 1
- LED 8 Status display muting sensor Start 2
- LED 9 Status display muting preparation Control 1
- LED 10 Status display muting preparation Control 2
- LED 11 Status display muting lamp

- Status 1 State of test monitoring unit - SLS
- Status 2 State of muting controller

- Switch 1 Selection with/without start-/restart interlock
- Switch 2 Selection with/without contactor monitoring

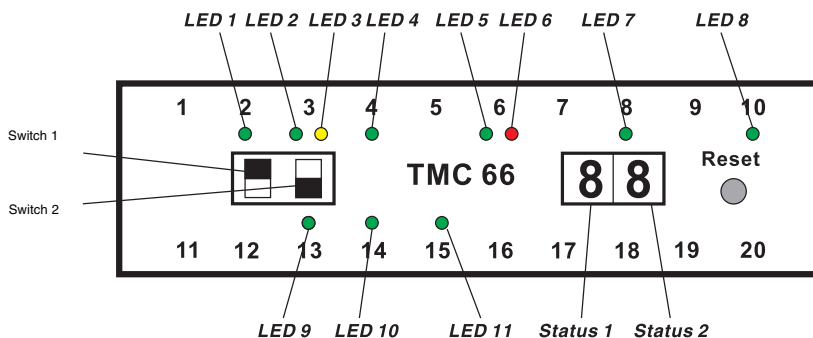

Fig. 3.2-1: Display and operating instruments

Removing and mounting the front screen

The housing has carvings on both sides of the transparent front screen. The front screen can be lifted by inserting a screw driver size 1 into these carvings.

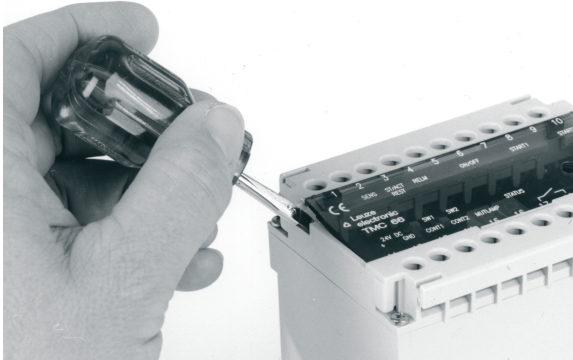

Fig. 3.2-2: Removing the front screen

To remount the front screen, simply press it into the fastening frame. Observe the correct position of the code snugs.

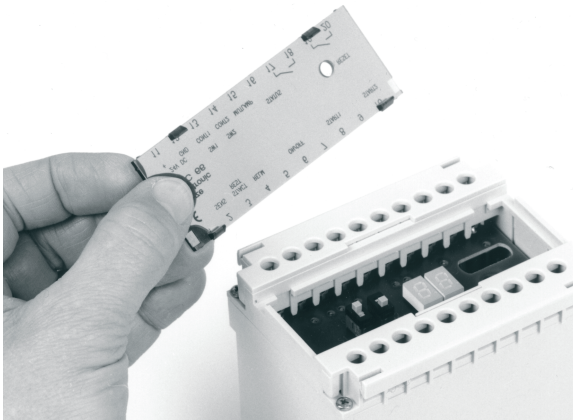

Fig. 3.2-3: Remounting the front screen

The reset button can be activated through the hole in the transparent front screen. In case of a failure, the device can be reset, the self-containing mode activated, and the switch positions can be programmed by using the reset-button.

4 Mounting of the Safety System

4.1 Mounting of the Test Monitoring Unit TMC 66

The TMC 66 has been designed for mounting on a standard rail (snap-on) in a suitable switching cabinet.



Note!

The mounting instructions in this chapter have to be heeded for fault-free functioning of the whole safety system.

4.2 Mounting of the Single Beam Safety Light Barrier

It is absolutely mandatory that the valid guidelines and standards are observed when mounting the single beam safety light barriers.

Safety distance

A certain time delay applies between the interruption of the light beam of the single beam safety light barriers and the stand-still of the machine. The photo electric sensors have to be installed in such a way that the dangerous area can not be reached within this time delay. The minimum distance for safeguarding the hazardous area is 850 mm.

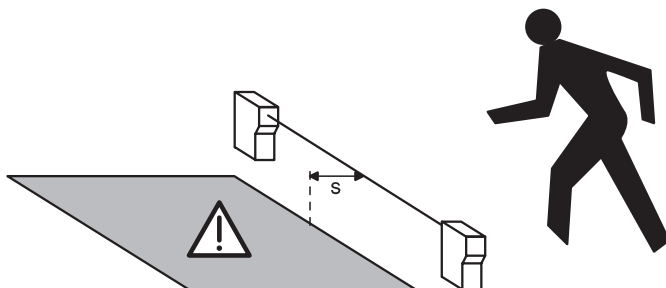

Fig. 4.2-1: Safety distance from the hazardous area

Calculation of the safety distance

The safety distance S between photo electric sensor and hazardous area is calculated acc. to EN 999 using the following formula:

$$S = K * T + C$$

S = Safety distance between photoelectric sensor and hazardous area

K = Grip and approach speed

T = Time delay between interruption of the light beam and stand-still of the machine

C = Safety constant

1200 mm with single-axis installation,

850 mm multi-axis installation

Example for the calculation of the safety distance:

A machine with a system response time of 500 ms has to be equipped with a two-beam safeguarding. The response time of the two-beam AOPD and the test monitoring unit TMC 66 is 20 ms.

Application of the formula: $S = K * T + C$

Assigned is:

S = the minimum distance of the two-beam AOPD from the hazardous area

K = approach speed 1600 mm/s (EN 999)

T = sum out of system response time of the machine and response time of the AOPD

C 850 mm multi-axis installation

Result:

$$S = (1600 \text{ mm/s} * (500 \text{ ms} + 20 \text{ ms})) + 850 \text{ mm}$$

$$S = 1682 \text{ mm}$$

4.2.1 Multi-axis Installation

The safeguarding heights and the number of light beams are determined in EN 999 or through a risk analysis acc. to ISO 13849-1 for safeguarding of hazardous areas.

With multi-axis installation, parallel light beams always have to run in opposite directions. Otherwise the light beams can cause mutual interference and disturb the safe functioning.

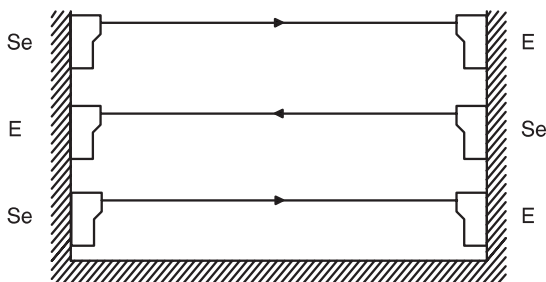

Fig. 4.2-2: Multi-axis installation

Depending on the number of photo electric sensor pairs, the single systems have to be mounted in different heights acc. to EN 999. The number of used systems results from the corresponding type C standard or risk evaluation.

Deflection mirrors

Application of deflection mirrors

A number of important factors has to be observed with application of deflection mirrors:

- With any light beam deflection, a loss of operating range occurs. Per deflection mirror, the loss is approx. 15%.
- Contamination of the deflection mirrors should be avoided.
- Environmental conditions such as steams and dust-containing air heavily limit the operating range.
- When installing deflection mirrors it has to be observed that the optical axis of the photo electric sensor runs centered to the mirror.

- A laser alignment aid made by Leuze, e.g. ARH 2 facilitates the alignment over great distances and if using deflection mirrors.

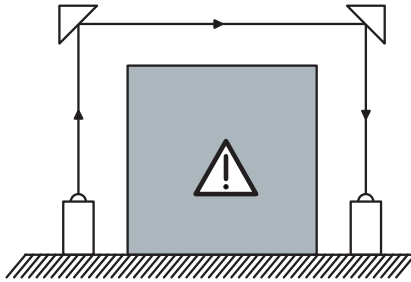

Fig. 4.2-3: Deflection mirrors

Reflection bypass

Measures connected to reflection bypass

Surfaces located parallel to the light beam can cause a reflection bypass. An object within the light path is then no longer detected.

The photo electric sensor has to be mounted with a minimum lateral distance to the reflecting surface. This distance results from the opening angle ($\pm 4^\circ$) and the distance between transmitter and receiver.

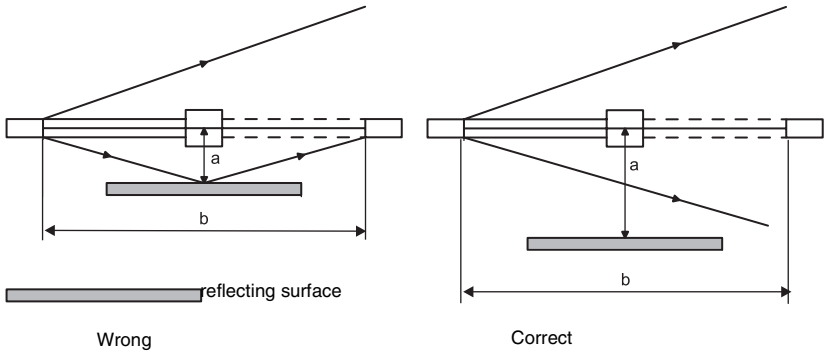

Fig. 4.2-4: Reflection bypass

Minimum distance to the reflecting surface						
To transmitter (b) in [m]	2	3	4	5	6	10
To light beam (a) approx. [m]	0.20	0.30	0.40	0.50	0.60	1.0

4.2.2 Muting Basics

It is necessary to suppress the function of the single beam safety light barrier for a certain period, if material has to be transported from or into the hazardous area. This suppression procedure is called muting.

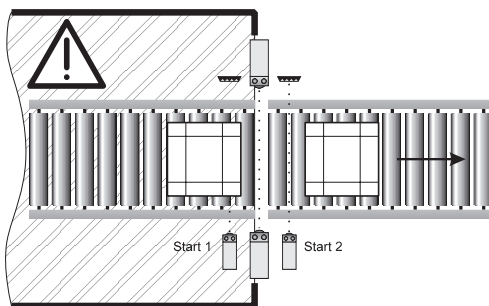

Fig. 4.2-5: Muting Basics

The TMC 66 has two muting preparation signals Control 1 and Control 2, as well as two muting signals Start 1 and Start 2 for the muting function.



Note!

The TMC 66 is equipped with a direction detection to avoid manipulation. The inputs Start 1 and Start 2 have to be activated in the correct order. During the muting procedure, both signals have to be permanently present. An interruption causes immediate abortion of the muting function (drop-off of safety relays).

The diagram illustrates the signal flows during the muting cycle.

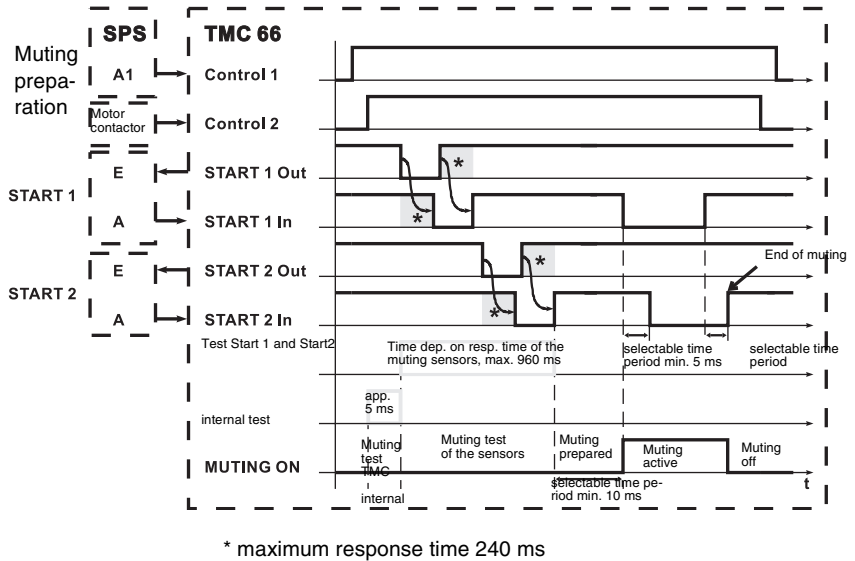

Fig. 4.2-6: Signal flows during muting

First, the two control signals on the TMC 66 are activated by the control unit. Note that the control signals must originate from different signal sources. In the example above, the Control 1 signal comes from the PLC, the Control 2 signal has to be deduced from the pallet transport (contactor or NC drive).

For the function of the TMC 66, the connection order of the control signals is without meaning. The time period between connection of the first and second control signal can be between 0 ms and an infinitely long time period. Only after both signals have been activated, the internal test of the TMC 66 starts. The control signals have to be permanently active during the whole muting procedure.

The internal circuit and the connected muting light signals are tested during a time period of 5 ms.

After a successful internal test, the connected muting sensors are tested. The TMC 66 takes over the control function. The TMC 66 "expects" a reaction on the issued signal changes from the signals of "Start 1" and "Start 2".

At every change of a pulse edge the sensors have to respond within 240 ms. After successful test completion of "Start 1" and "Start 2", the muting function is prepared - the TMC 66 hands over the controlling function to the sensors.

As soon as the first muting sensor is darkened, that means signal "Start 1" switches off, the single beam safety light barrier output signal is suppressed (muted). After a minimum time period of 5 ms, the second photo electric muting sensor can be interrupted, that means "Start 2" can be switched off. A maximum time period for this signal change is not

monitored by the device, however, this procedure must be performed before a new activation of "Start 1" (direction detection).

"Start 1" can be re-activated after switching off of signal "Start 2" (direction detection).

The next step in the procedure is the completion of the muting function. This can be done in three different ways:

Switching off of the control signals

- deactivation of Control 1 (signal change from High to Low)
- deactivation of Control 2 (signal change from High to Low)

Switching on of Start 2

- activation of Start 2 (signal change from Low to High)

As soon as the TMC 66 detects one of the mentioned signal changes, the suppression of the single beam safety light barrier signals is immediately removed.

Case 1: End of muting through switching-off of Start 2

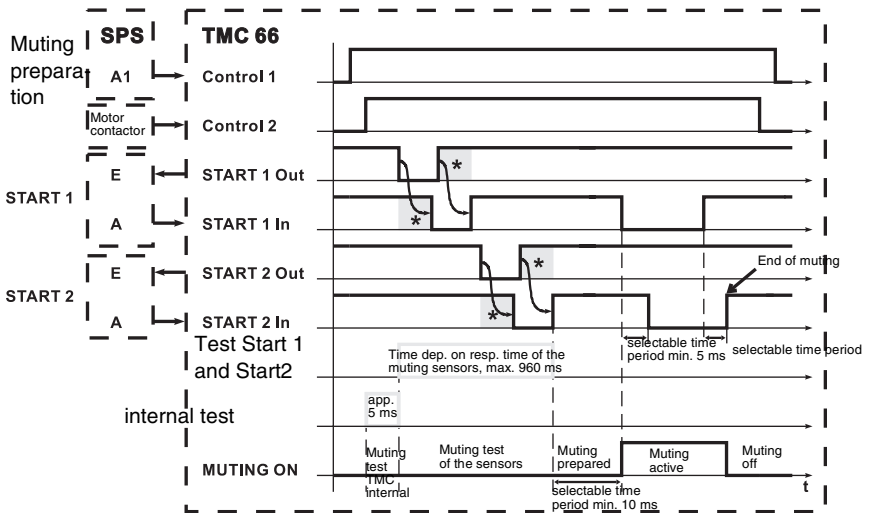

* maximum response time 240 ms

Fig. 4.2-7: End of muting through switching-off of Start 2

Case 2: End of muting through switching-off of Control 1

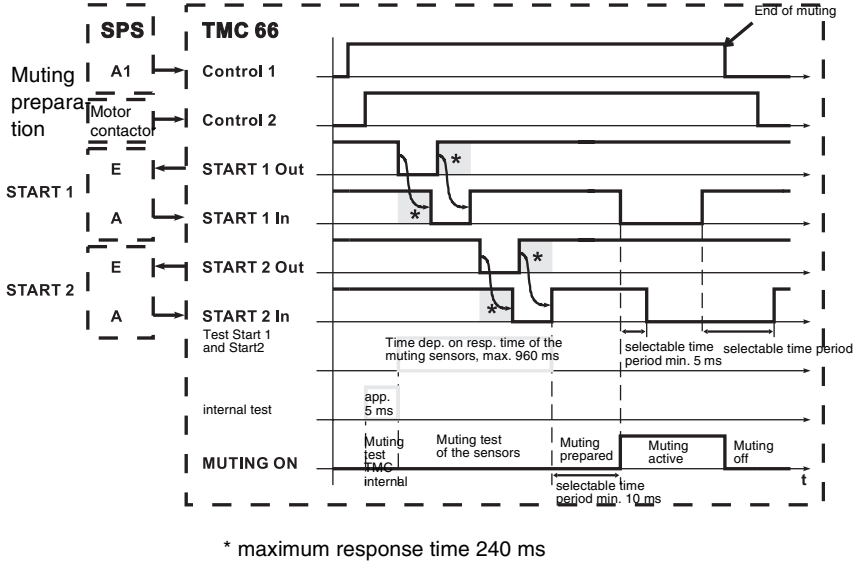
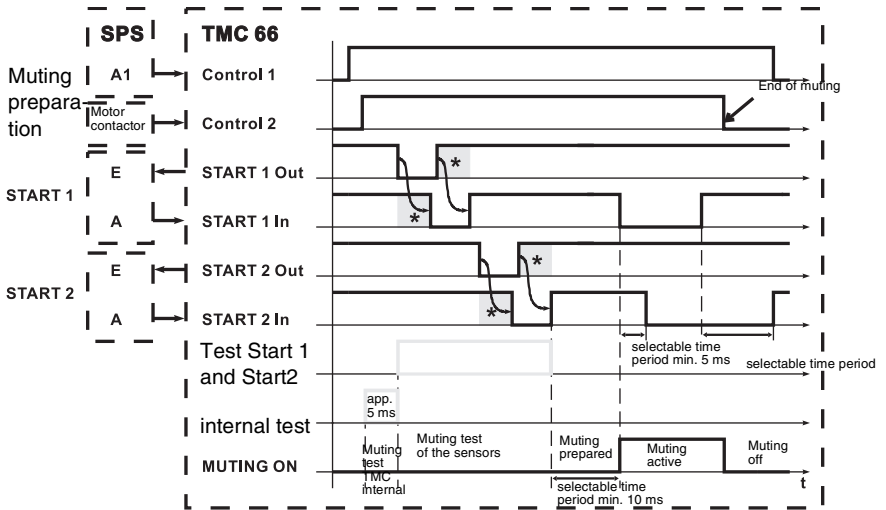

Fig. 4.2-8: End of muting through switching-off of Control 1

Case 3: End of muting through switching-off of Control 2



* maximum response time 240 ms

Fig. 4.2-9: End of muting through switching-off of Control 2

New muting

A new activation of the bypass function is only possible after completion of the basic state. The following conditions have to be fulfilled:

- Signal "Control 1" on LOW - potential
- Signal "Control 2" on LOW - potential
 - Photo electric sensor "Start 1" free
- Signal "Start 1 IN" on HIGH - potential
 - Photo electric sensor "Start 2" free
- Signal "Start 2 IN" on HIGH - potential

After that the muting can be restarted through activation of the two control signals.

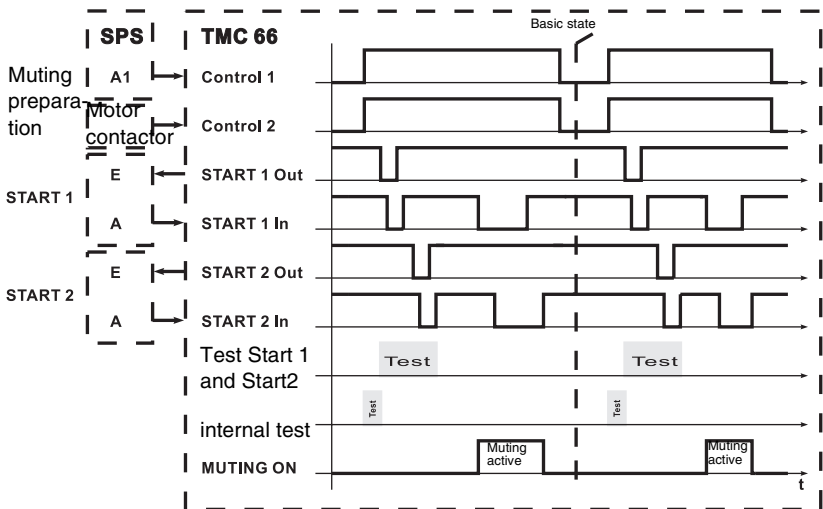

Fig. 4.2-10: New muting

5 Electrical Installation

The electrical installation is only to be performed by specialized personnel. During installation it has to be observed that supply and signal lines have to be installed separately from power lines. Inside the switching cabinet, suitable spark extinction has to be provided if using contactors. In connection with driving motors and breaks, the corresponding manuals have to be observed.

5.1 Supply Wiring

The test monitoring unit TMC 66 is supplied with 24V DC +/-15%. Current consumption is max. 200 mA (without active muting light signals).

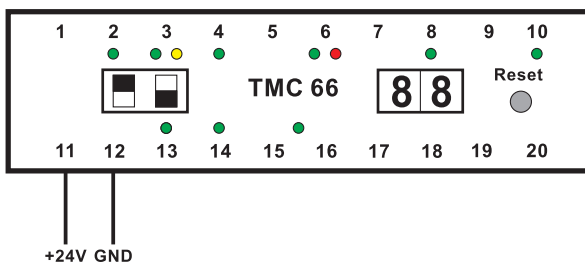

Fig. 5.1-1: Supply wiring

5.2 Start Input Wiring

Within the operating modes with/without start- and restart interlock, the start input works in two possible ways:

- In the operating mode with start- and restart interlock, the TMC 66 expects two signal changes (push-button function) as switch-on signal. A failure in the start button, e.g. due to contact malfunction is safely detected by the TMC 66.

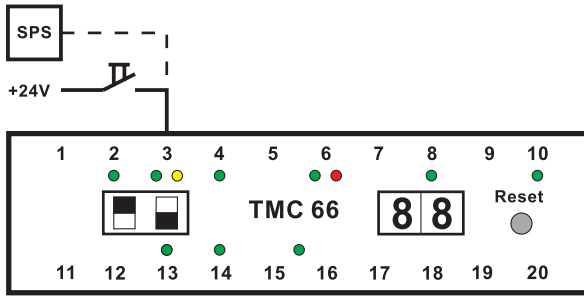

Fig. 5.2-1: Wiring of the start input with start- and restart interlock

- In the operating mode without start- and restart interlock, the start input works as activation input. As soon as a HIGH active signal is present at the start input and the protective field is free, the safety outputs are closed.

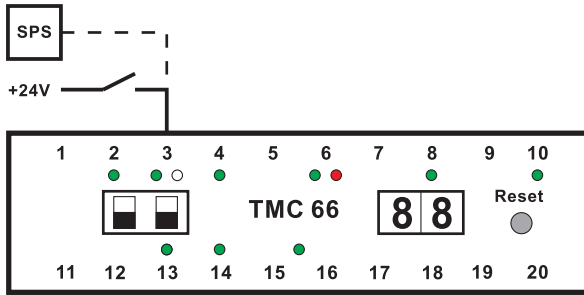

Fig. 5.2-2: Wiring of the start input without start- and restart interlock

5.3 Wiring of Single-beam Single Beam Safety Light Barriers

The activation input of the single beam safety light barrier can be directly connected to terminal 1 on the TMC 66. The switching output of the receiver can be directly connected to terminal 2. The GND potential present on terminal 12 serves as reference potential for both signals. The supply of the single beam safety light barriers comes directly from the 24V power supply unit.

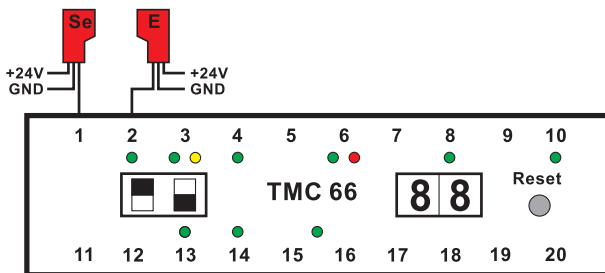

Fig. 5.3-1: Wiring of single-beam single beam safety light barriers

5.4 Wiring of Single Beam Safety Light Barrier in Series Connection

Several photo electric sensor pairs can be wired in series on the TMC 66 if multi-axis safeguarding needs to be installed on a machine or system. The figure below illustrates a three-axis photo electric sensor installation. It is possible to operate up to six photo electric sensor pairs on one TMC 66.

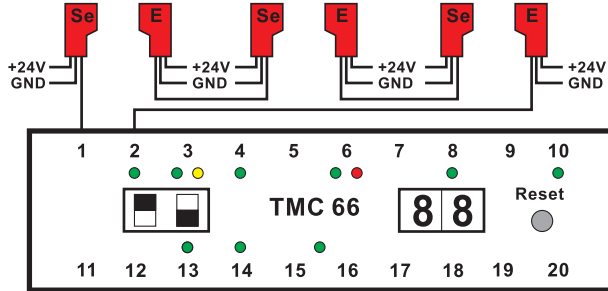

Fig. 5.4-1: Wiring of single beam safety light barriers in series connection

Function characteristics

The TMC 66 (terminal 1) activates the first photo electric sensor transmitter. The receiver is activated via the first optical path and, by using its output activates the second photo electric sensor transmitter. The supply has to be provided on each photo electric transmitter and receiver. The feed-back to the TMC 66 (terminal 2) is done by the last photo electric sensor receiver within the series connection.

Any time the light axis is interrupted, a message is issued to the TMC 66 through the series connection.

The series connection tests every transmitter and receiver for function capability while performing the testing procedure.

5.5 Wiring Control Signals

Before every muting procedure, a muting preparation signal has to be connected to the inputs Control 1 (terminal 13) and Control 2 (terminal 14). Control 1 and Control 2 are HIGH active. The control signals can be connected to the TMC 66 in any order. The test of the muting sensors is performed as soon as both signals are connected. The control signals have to be generated by two different signal sources. That means either two contactor contacts or one contactor contact and one PLC output can be used.

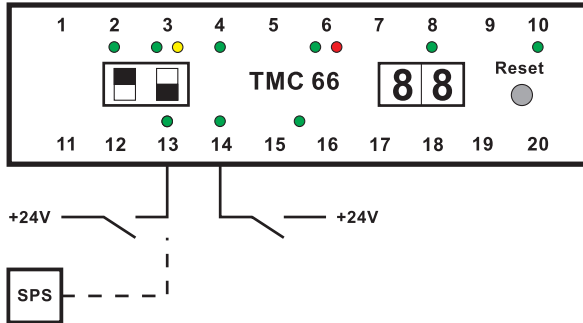

Fig. 5.5-1: Wiring control signals

5.6 Wiring of the muting light signals

Acc. to EN 61496-1, one or more monitored muting light signals with a light density of at least 200 cd/m² and an area of at least 1 cm² have to be used to display the muting state. The TMC 66 offers connection for two light signals.

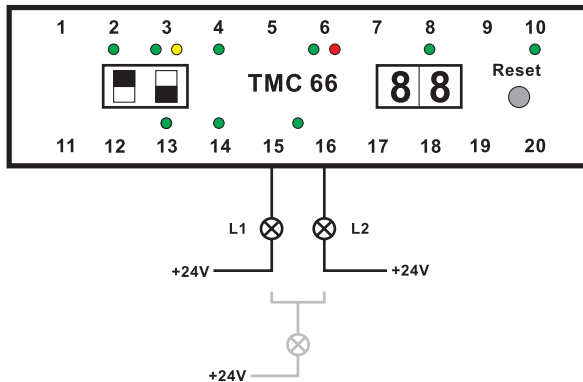

Fig. 5.6-1: Wiring of the muting light signals

Connection of the outputs can be done in two ways:

- Two light signals:
Both light signals are directly connected to the TMC 66 and supplied with 24 V. As soon as a light signal is defect, the system still works normally. The TMC 66 issues an error message. The number of the defect lamp (L1 or L2) is displayed. The failure is erased after the defect lamp has been exchanged. No muting state can be obtained if both lamps are defect or not connected.
- One light signal:
Terminals 15 and 16 of the TMC 66 can also be connected in a parallel way. An error message is generated if the lamp is defect. No muting state can be obtained until the lamp is replaced.

5.7 Wiring of the Muting Signals Start 1 and Start 2

Muting sensors

Throughbeam- or retro-reflective photo electric sensors with activation input (PNP HIGH active) can be used as muting sensors on the TMC 66.

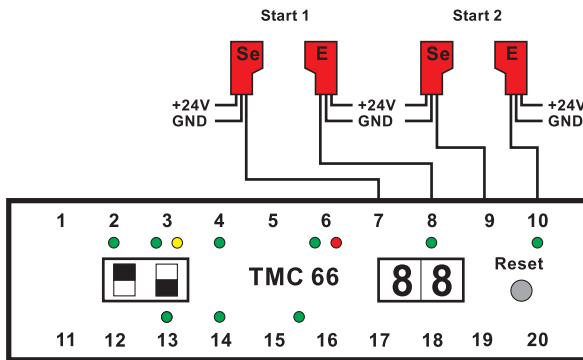

Fig. 5.7-1: Wiring of the muting signals Start 1 and Start 2 (muting sensors)

Control signals

For the bypass function of the single beam safety light barrier, PLC control signals can be used. For this purpose, inputs and outputs of the PLC are used as muting senders. The functions muting start and muting stop are then induced by the PLC. The PLC is programmed to react on the test request of the TMC 66. The test of the PLC inputs and outputs is induced before every muting procedure while connecting the control signals.

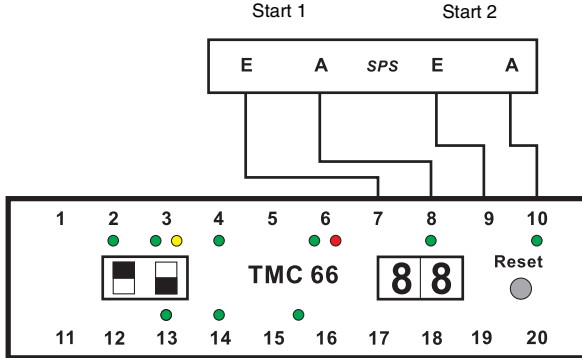

Fig. 5.7-2: Wiring of the muting signals Start 1 and Start 2 (control signals)



Note!

The control signals control 1 and control 2 have to be generated by two different signal sources if a PLC is used as muting sender. Control 1 can come from the PLC, whereas control 2 will be deduced from a contactor which switches the conveyor belt on and off.

5.8 Wiring Safety Output

Integration in a one-channel release circuit without contactor monitoring

Two safety relay outputs are connected in series. The release circuit can be connected to further components which are then wired to a common EMERGENCY STOP device.

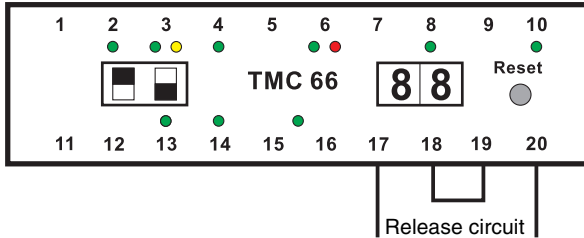

Fig. 5.8-1: Wiring safety output (one-channel release circuit)

Integration in a two-channel release circuit without contactor monitoring

Both safety relay outputs are integrated separately into the release circuits. These can be connected to further components which are wired to a common EMERGENCY STOP device.

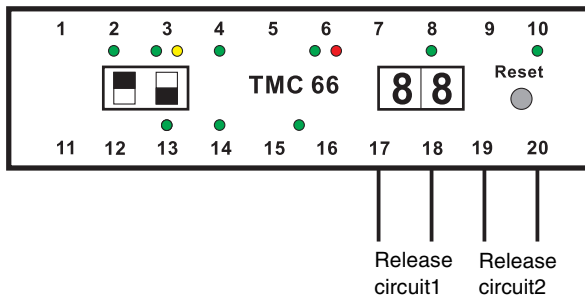

Fig. 5.8-2: Wiring safety output (two-channel release circuit)

Integration with contactor monitoring

The motor contactors for dangerous movement are connected to both safety relay outputs. For this purpose, forced contactors have to be used. In the connection diagram, no fuses are included. However, for correct function those are absolutely required. The maximum contact load of the safety relay outputs is 4 A with 24V DC.

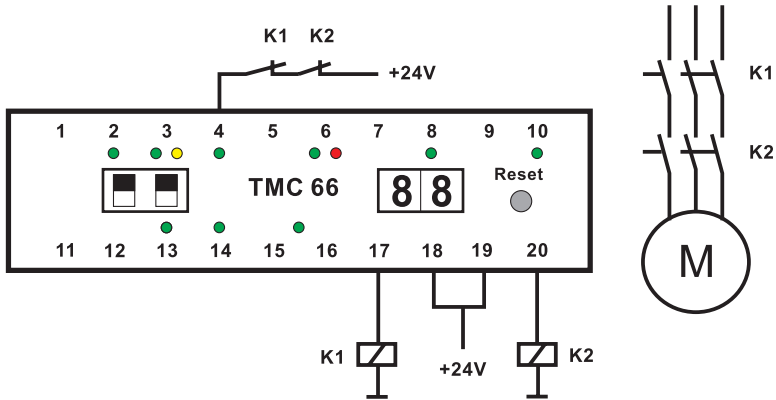

Fig. 5.8-3: Wiring safety output

Control of the motor contactors happens via K1 and K2. If a contact of K1 or K2 should weld, a message is issued to the TMC 66 through the feedback circuit. A new start of the unit is possible only after removal of the failure in the output circuit.

5.9 Wiring of the Signal Outputs

Two signal outputs are integrated in the TMC 66. Both are HIGH active, positive switching safety related transistor outputs and can be either directly connected to a PLC or control a status display of a machine.

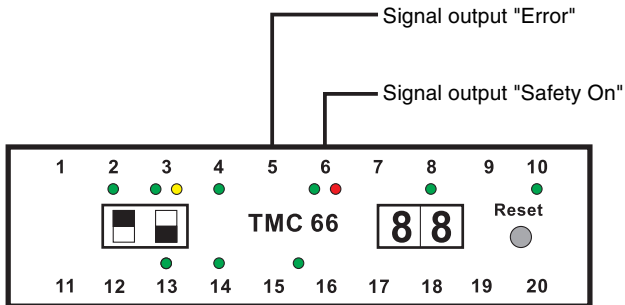

Fig. 5.9-1: Wiring of the signal outputs

The signal output "Safety on" is always active if the safety relay outputs are closed.

The signal output "Error" is always active if the TMC 66 detects an error. Those errors can be internal or external. A detailed listing of all possible errors can be found in the next chapter.

Through linking of the status outputs in the control unit, the following system states can be detected:

1. "Safety on" active, "Error" inactive Normal operation of the TMC 66, no error detected.
2. "Safety on" active, "Error" active The TMC 66 has detected an error of the muting lamps. In this case, the output "Error" only serves as warning message and is reset after removal of the failure.
3. "Safety on" inactive, "Error" active The TMC 66 detected a safety relevant failure which led to the switching off of the safety outputs.

5.10 Selecting of the Operating Mode

The function of start- and restart interlock, as well as of the contactor monitoring can be adjusted on the device.

Upon delivery, the start- and restart interlock are active, the contactor monitoring is inactive.

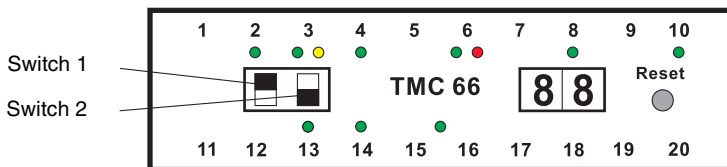

Fig. 5.10-1: Adjustment of the operating mode (start- and restart interlock active, contactor monitoring inactive)

Remove the transparent front screen in order to change the settings. The start- and restart interlock can be switched-off on the left switch (switch 1).

Start- and restart interlock active, contactor monitoring inactive

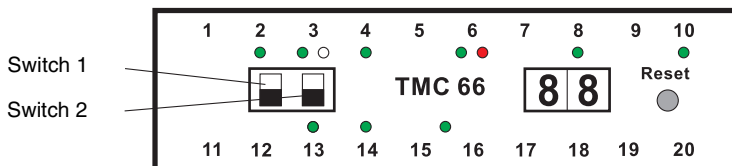

Fig. 5.10-2: Adjustment of the operating mode (start- and restart interlock inactive, contactor monitoring inactive)

The function of the contactor monitoring can be switched-off on the right switch (switch 2).

Start- and restart interlock active, contactor monitoring active

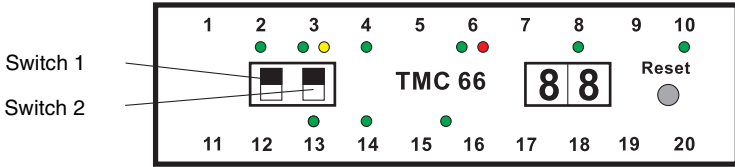

Fig. 5.10-3: Adjustment of the operating mode (start- and restart interlock active, contactor monitoring active)

Start- and restart interlock inactive, contactor monitoring active

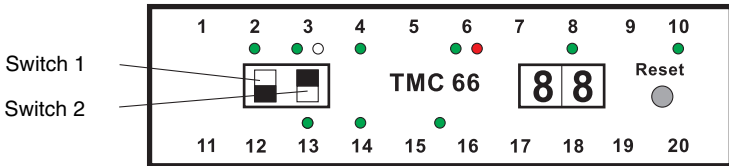

Fig. 5.10-4: Adjustment of the operating mode (start- and restart interlock inactive, contactor monitoring active)

Final steps



Note!

After changing of the switch position, the new setting has to be read in to the device. For this purpose the reset button has to be pressed for a minimum of two seconds. The new settings are stored and the device is restarted. After that, the transparent front screen has to be remounted.

5.11 Starting the unit when the single beam safety light barrier is interrupted

The test monitoring unit TMC 66 can be released also in cases where e.g. after an emergency stop of the unit the single beam safety light barrier stays interrupted by remaining goods on the conveyor belt.

To enter this so called "release-mode" first disconnect the supply voltage. The release mode can then be activated by reconnecting the supply voltage to the TMC 66.

The release mode is used for applications where the TMC 66 is connected to throughbeam or retro-reflective photo electric sensors. When connected to a PLC, the TMC 66 can be released without disconnecting the supply voltage.

How to release the TMC 66:

- | | |
|--|---|
| <ol style="list-style-type: none"> 1. Emergency stop of the unit 2. Reconnect the supply voltage, wait for 2 sec. until the unit is ready to operate 3. Activate the muting preparation 4. Press the start-button at the TMC 66 5. Switch the unit on again 6. The unit switches back to automatic operation | <p>Disconnect the supply voltage at the TMC 66</p> <p>Connect a high-potential to the Control 1 and Control 2 inputs
The TMC 66 activates the muting function internally</p> <p>The TMC 66 closes the release circuit</p> <p>The single beam safety light barrier is released, since the conveyor belt restarts</p> |
|--|---|

5.12 Operating Conditions without Muting Function

In principle, the test monitoring unit can be used in two operating modes; with and without muting function.

TMC 66 without muting function, without start- and restart interlock

Waiting mode

In the waiting mode the single beam safety light barrier is free (green LED). Activation is not used. The safety outputs are open. This state is displayed by the red LED. The waiting state is displayed through state "11" on the 7-segment display.

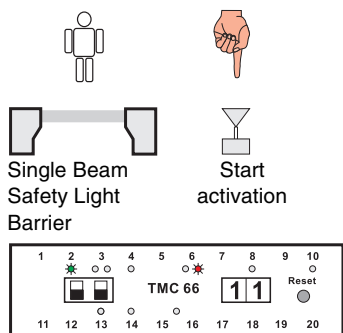

Fig. 5.12-1: Waiting mode

Protection mode

In protection mode, the function of the single beam safety light barrier is cyclically tested every two seconds. The free protective field is displayed by the green LED.

Activation is used (green LED). The safety output is closed which is displayed by a green LED.

Protection mode is displayed by state "21" on the 7-segment display.

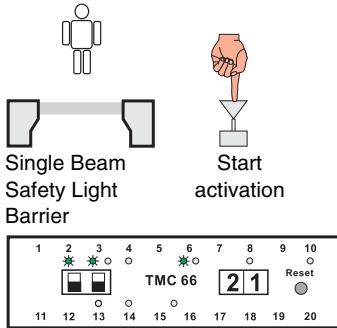

Fig. 5.12-2: Protection mode

5.13 TMC 66 without muting function, with start- and restart interlock

Waiting mode

In the waiting mode the single beam safety light barrier is free (green LED).

Activation is not used.

The safety output is open. This state is displayed by the red LED. The yellow LED displays the lock of the start- restart interlock.

The waiting state is displayed through state "11" on the 7-segment display.

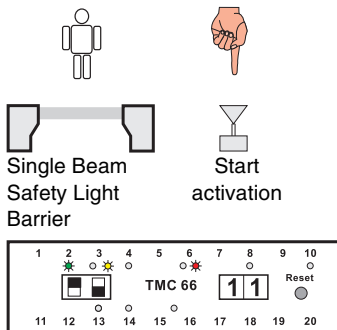

Fig. 5.13-1: Waiting mode

Test operation

The function capability of the test monitoring unit and the single beam safety light barrier are tested during test operation.

To induce the test operation, the start input is activated (green LED).

As long as the start button is pressed, the TMC 66 remains in test operation.

After release of the start button, the TMC 66 changes from test operation to protection mode.

The test operation is displayed through state "11" on the 7-segment display.

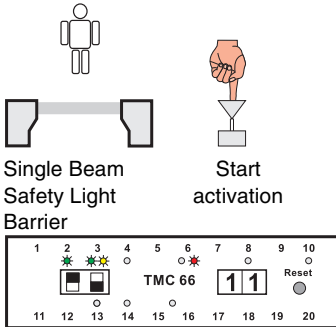

Fig. 5.13-2: Test operation

Protection mode

In protection mode, the function of the single beam safety light barrier is cyclically tested every two seconds. The free protective field is displayed by the green LED.

Activation is used (green LED).

The safety outputs are closed which is displayed by a green LED.

Protection mode is displayed through state "21" on the 7-segment display.

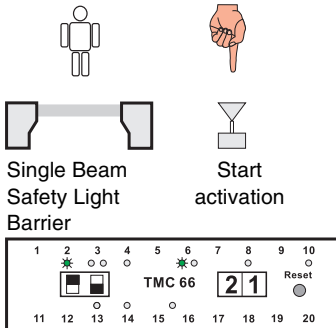

Fig. 5.13-3: Protection mode

Protective field interruption

The safety outputs of the TMC 66 are opened (green LED off, red LED on) if during protection mode the light beam of the single beam safety light barrier is interrupted.

The restart interlock inside the TMC 66 becomes active and avoids an automatic restart of the machine. The yellow LED displays the function of the restart interlock.

The TMC 66 is in waiting state and can be restarted by pressing the start button after the protective field is free.

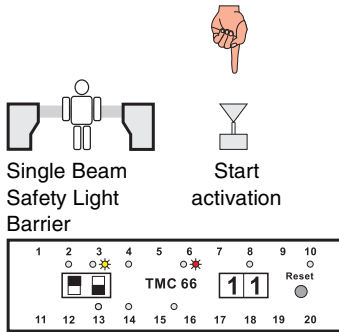

Fig. 5.13-4: Protective field interruption

5.14 Modes with muting function

Eight muting phases can be differentiated if the TMC 66 is used with muting.

Phase 1: Activation of muting preparation through connection of the control signals

Phase 2: Activation of muting through interruption of Start 1

Phase 3: Single beam safety light barrier is interrupted

Phase 4: Continuation of muting through interruption of Start 2

Phase 5: Continuation of muting through release of Start 1

Phase 6: Single beam safety light barrier is released

Phase 7: End of muting through release of Start 2

Phase 8: Basic state is again obtained through deactivation of control signals

The following figures illustrate the muting procedure by using the single muting phases and the corresponding display state.

Muting phase 1

Control signals are activated. The first muting phase is displayed through the LEDs for control 1 and control 2.

The 7-segment display changes from "21" to "22".

The muting sensors "Start 1" and "Start 2" are tested in this state. If an error occurs during the test, this is displayed on the 7-segment display.

The muting light signals are also tested. If an error occurs on the light signals, this is also displayed.

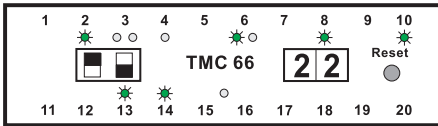
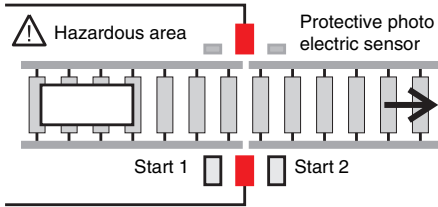

Fig. 5.14-1: Muting phase 1

Muting phase 2

Activation of muting through interruption of Start 1

The indicator diode for "Start 1" goes off, the LEDs for "Control 1" and "Control 2" remain active.

The 7-segment display changes from "22" to "23".

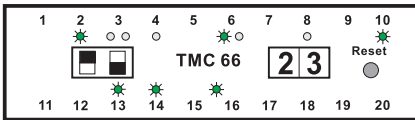
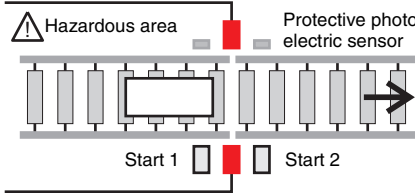

Fig. 5.14-2: Muting phase 2

Muting phase 3

The single beam safety light barrier is interrupted.

The indicator diode for "Sensor" goes off, the LEDs for "Control 1" and "Control 2" remain active.

The 7-segment display changes from "23" to "33". Through this is displayed that the safety outputs are closed although the single beam safety light barrier is interrupted.

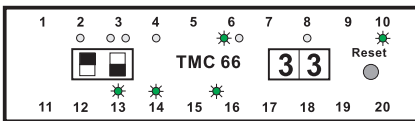
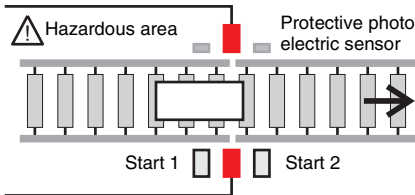

Fig. 5.14-3: Muting phase 3

Muting phase 4

Continuation of muting through interruption of Start 2

The indicator diode for "Start 2" goes off, the LEDs for "Control 1" and "Control 2" remain active.

The 7-segment display changes from "33" to "34".

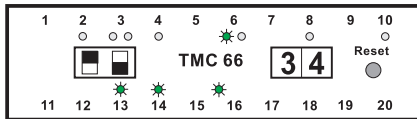
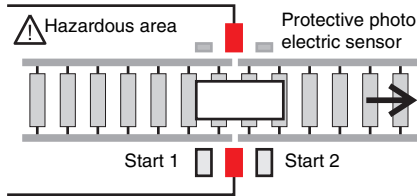

Fig. 5.14-4: Muting phase 4

Muting phase 5

Continuation of muting through release of Start 1

The indicator diode for "Start 1" lights up, the LEDs for "Control 1" and "Control 2" remain active.

The 7-segment display changes from "34" to "35".

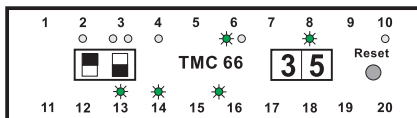
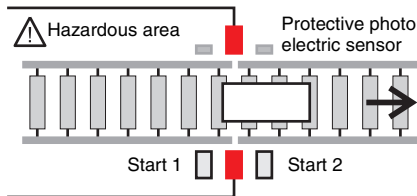

Fig. 5.14-5: Muting phase 5

Muting phase 6

Muting is continued through release of the single beam safety light barrier.

The indicator diode for "Sensor" lights up, the LEDs for "Control 1" and "Control 2" remain active.

The 7-segment display changes from "35" to "25".

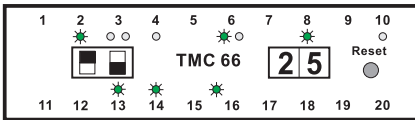
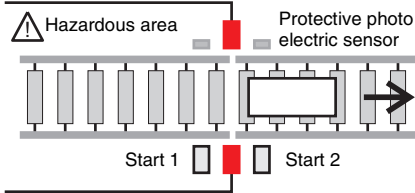

Fig. 5.14-6: Muting phase 6

Muting phase 7

End of muting through release of Start 2

The indicator diode for "Start 2" lights up, the LEDs for "Control 1" and "Control 2" remain active.

The 7-segment display changes from "25" to "26".

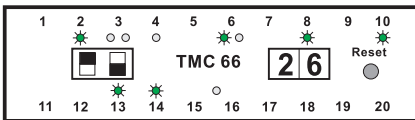
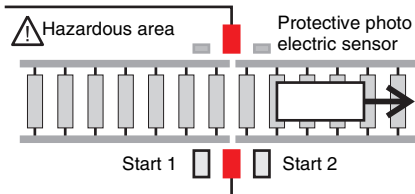

Fig. 5.14-7: Muting phase 7

Muting phase 8

Basic state is again obtained through deactivation of control signals
The indicator diodes for "Control 1" and "Control 2" go off.
The 7-segment display changes from "26" to "21".
A new muting cycle can be started by activating the control signals.

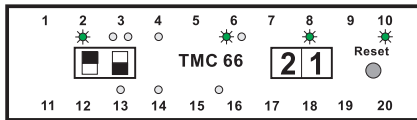
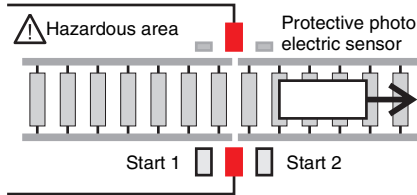

Fig. 5.14-8: Muting phase 8

6 Error Messages on the TMC 66

The test monitoring unit TMC 66 displays errors in two ways. Errors which occur on the connected signals are displayed by flashing of the LED assigned to the input. The flashing is switched off as soon as the error is removed. In addition to that, all failures are displayed on the 7-segment display.

The first digit of the 7-segment display indicates the state of the single beam safety light barrier and the test monitoring unit, the second digit represents the state of the integrated muting unit.

The following table shows all possible errors and gives hints on erasing them.

Display	Error description	Error handling
00	No error	Device in reset mode
E1	Contactors monitoring active, contactor contact of feedback circuit open	Error in the wiring of the connected contactors <ul style="list-style-type: none"> • check wiring Connected contactors defect (welded contact) <ul style="list-style-type: none"> • replace contactor
E2	Contactors monitoring deactivated, contactor contact of feedback circuit closed	Error in the wiring (input connected, though not used) <ul style="list-style-type: none"> • check wiring
E3	Contactors monitoring active, contactor contact of feedback circuit closed	Connected contactors defect (feedback contacts welded) <ul style="list-style-type: none"> • replace contactor • check wiring
E4	Output relay inactive with control	Supply voltage too low <ul style="list-style-type: none"> • check supply internal device failure <ul style="list-style-type: none"> • replace device
E6	Control of muting lamp defect	Supply voltage too low <ul style="list-style-type: none"> • check supply internal device failure <ul style="list-style-type: none"> • replace device
E7	Both muting lamps defect	supply missing on the muting lamps <ul style="list-style-type: none"> • check supply wiring failure <ul style="list-style-type: none"> • check wiring spiral-wound filament burnt <ul style="list-style-type: none"> • replace light signals
E8	Error during test of Start1	Response time on test of Start 1 is too long <ul style="list-style-type: none"> • replace sensor • review PLC program
E9	Error during test of Start2	Response time on test of Start 2 is too long <ul style="list-style-type: none"> • replace sensor • review PLC program

Display	Error description	Error handling
EA	Internal failure (RAM test)	internal device failure • replace device
EB	Internal failure (ROM test)	internal device failure • replace device
EC	Internal failure (SW1)	internal device failure • replace device
ED	Internal failure (SW2)	internal device failure • replace device
EE	Output relay active without control	internal device failure • replace device
F0 - F5	Internal hardware failure at power on	internal device failure • replace device
F8	Switch position and taught in state not identical	Switch position of switch 1 and switch 2 changed • teach-in new operating mode • readjust old operating mode Switch 1 or switch 2 defect • replace device
1A or 2A or 3A	Muting aborted	A started muting procedure has not been completed if during a muting procedure the state of 1A, 2A or 3A is displayed. This message is alternately displayed with the indication of the muting phase in which the abortion took place. This message is erased during the next muting procedure.
u2 or u3 or u4 or u5 or u6	Muting aborted	If the muting is interrupted during a muting cycle, the 7-segment display shows the phase of the muting cycle in which the interruption has occurred. You can find the explanations of the single phases of a muting cycle in the chapter "Operating states with muting function" of this manual.
1E or 2E	Errors in the muting cycle	The muting control has detected an error, when during operation the state 1E or 2E is displayed. Further muting procedures are only possible after error correction and reset of the device. Possible errors are: • Response time of start 1 is too long • Response time of start 2 is too long • Two defective muting lamps

Every failure can be erased after removing the cause by pressing the reset button.

7 Technical Data

Safety-relevant technical data	
Type in accordance with IEC/EN 61496	Type 2
Performance Level (PL) in accordance with ISO 13849-1: 2008	PL d
Category in accordance with ISO 13849-1	Cat. 2
Mean probability of a dangerous failure per hour (PFH_d) as a function of the mean number of annual switching cycles of the relay n_{op}*	n _{op} = 4,800: 1.4 x 10 ⁻⁸ 1/h n _{op} = 28,800: 3.1 x 10 ⁻⁸ 1/h n _{op} = 86,400: 7.9 x 10 ⁻⁸ 1/h
Mean time to dangerous failure (MTTF_d)	n _{op} = 4,800: 250 years n _{op} = 28,800: 100 years n _{op} = 86,400: 40 years
Degree of cover DC	98%
Number of cycles until 10 % of the components have a failure to danger (B _{10d})	Low load 20%: 20 million switching cycles DC 1: 400,000 switching cycles AC 1: 400,000 switching cycles
Service life (T _M)	20 years
*n _{op} = mean number of annual actuations, see C.4.2 and C.4.3 of ISO 13849-1: 2008 Use the following formula to calculate the mean number of annual actuations: $n_{op} = (d_{op} \cdot h_{op} \cdot 3600s/h) \div t_{Zyklus}$ In doing so, make the following assumptions with regard to the use of the component: h _{op} = mean operating time in hours per day d _{op} = mean operating time in days per year t _{cycle} = mean time between the start of two successive cycles of the component (e.g switching of a valve) in seconds per cycle	

Electrical data	
Operating voltage U_B	24V DC +/-15%
Residual ripple	< 15%
Current consumption	approx. 200 mA
Response time	< 20 ms
Delay before start-up	approx. 2 s
Sensors	
Transmitter activation	PNP (HIGH active)

Electrical data	
Operating voltage U_B	24V DC +/-15%
Receiver activation	Optical coupler input, input current approx. 10 mA
Activation start sensors	PNP (HIGH active)
Input start sensors	Optical coupler input, input current approx. 10 mA
Inputs and outputs	
Start input	Optical coupler input (HIGH active), input current approx. 10 mA
Warning output "Error"	PNP transistor output, 100 mA, short circuit- and polarity reversal protection
Warning output "Safety On"	PNP transistor output, 100 mA, short circuit- and polarity reversal protection
Muting preparation	Optical coupler inputs (HIGH active), input current approx. 10mA
Muting light signals	Make-contact, 24 V, max. 2 A, integrated spiral-wound filament monitoring
Contactormonitoring	Optical coupler input (HIGH active), input current approx. 10 mA
Safety output	voltage free make-contact, max. current load 4 A
Fuse protection	externally with max. 4 A MT
Overvoltage category acc. to VDE 0110 p 1	2 for rating voltage 300 V AC
Environmental data	
Ambient temperature	-20 °C - +60 °C
Storage temperature	-30 °C - +70 °C
Protection class	IP 40 (suitable only for application in electrical operating rooms/switching cabinet with minimum protection class IP 54)
Contact protection	acc. to VBG 4 and VDE 0106 part 100
Mechanical data	
Housing	Polycarbonate, cover ABS/v-o grey
Connection	Screw terminals, max. connection cross-section 2x 2.5 mm acc. to DIN 46288
Mounting	Snap-on mounting for standard rail
Weight	approx. 200 g
Dimensions (WxHxD)	100 mm x 78 mm x 114 mm

8 Appendix

8.1 Wiring diagram with Single Beam Safety Light Barrier and PLC as muting sender

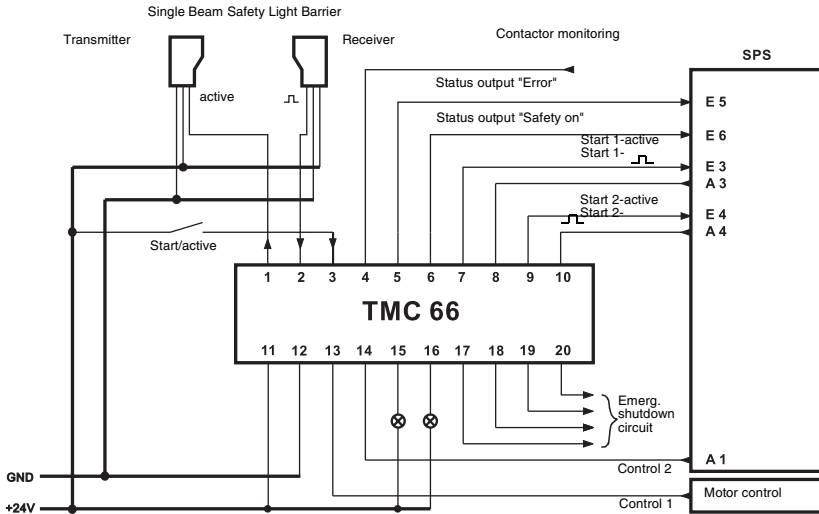

Fig. 8.1-1: Wiring diagram with single beam safety light barrier and PLC as muting sender

8.2 Remaining risks (EN ISO 12100-1)

The circuit proposals as shown in this manual have been tested and checked with the highest possible care. The current standards and guidelines are fulfilled if using the shown components and the corresponding wiring. Remaining risks are present if:

- the proposed circuit concept is changed and the connected safety-relevant components or protective devices are possibly not or insufficiently included in the safety circuit.
- the user did not comply with the current safety regulations for operation, adjustment and maintenance of the machine. Strict compliance with the intervals for checking and maintenance of the machine is mandatory.

EG-KONFORMITÄTS-ERKLÄRUNG	EC DECLARATION OF CONFORMITY	DECLARATION CE DE CONFORMITE
Der Hersteller	The Manufacturer	Le constructeur
	Leuze electronic GmbH + Co. KG In der Braike 1, PO Box 1111 73277 Owen, Germany	
erklärt, dass die nachfolgend aufgeführten Produkte den einschlägigen Anforderungen der genannten EG-Richtlinien und Normen entsprechen.	declares that the following listed products fulfil the relevant provisions of the mentioned EC Directives and standards.	déclare que les produits identifiés suivants sont conformes aux directives CE et normes mentionnées.
Produktbeschreibung:	Description of product:	Description de produit:
Test-Überwachungseinheit, Sicherheitsbauteil nach 2006/42/EG Anhang IV TMC 66 Seriennr. 10 01 50000 - 99 12 99999	Test Monitoring Unit, safety component in acc. with 2006/42/EC annex IV TMC 66 Part No. 10 01 50000 - 99 12 99999	Unité de surveillance test, Élément de sécurité selon 2006/42/CE annexe IV TMC 66 Art. n° 10 01 50000 - 99 12 99999
Angewandte EG-Richtlinie(n):	Applied EC Directive(s):	Directive(s) CE appliquées:
2006/42/EG 2004/108/EG 2006/95/EG	2006/42/EC 2004/108/EC 2006/95/EC	2006/42/CE 2004/108/CE 2006/95/CE
Angewandte Normen:	Applied standards:	Normes appliquées:
	EN 61496-1:2009; EN ISO 13849-1:2008 (Kat 2 PLd)	
Benannte Stelle / Baumusterprüfbescheinigung:	Notified Body / Certificate of Type Examination:	Organisme notifié / Attestation d'examen CE de type:
TÜV NORD CERT GmbH Zertifizierungsstelle für Produktsicherheit Benannte Stelle 0044 Langenackerstr. 20 45141 Essen	/	44 205 10 378618
Bevollmächtigter für die Zusammenstellung der technischen Unterlagen:	Authorized person to compile the technical file:	Personne autorisée à constituer le dossier technique:
Robert Sammer; Leuze electronic GmbH + Co. KG, business unit safety systems Liebigstr. 4; 82256 Fuerstenfeldbruck; Germany		

Owen, *27.4.10*
Datum / Date / Date

[Signature]
Dr. Harald Grübel, Geschäftsführer / Director / Directeur

Leuze electronic GmbH + Co. KG
In der Braike 1
D-73277 Owen
Telefon +49 (0) 7021 513-0
Telefax +49 (0) 7021 513-199
info@leuze.de
www.leuze.com
LEO-ZDM-149-01-FO

Leuze electronic GmbH + Co. KG, Sitz Owen, Registergericht Stuttgart, HRA 250712
Periodisch haftende Gesellschaft/Leuze electronic Gesellschaft/Leuze electronic GmbH
Sitz Owen, Registergericht Stuttgart, HRB 230550
Geschäftsführer: Dr. Harald Grübel (Vorstandsvorsitz), Karsten Just
USt-IdNr. DE 145912521 | Zulassnummer 2544232
Es gelten ausschließlich unsere aktuellen Verkaufs- und Lieferbedingungen
Only our current Terms and Conditions of Sale and Delivery shall apply

Nr. 609116-201004

You can also download this EC Declaration of Conformity from the Internet under:
<http://www.leuze.com/interfaces>