

be in motion be in motion



Converter

**BKD 6 / ... 7000
BKF 12 / ... 7000**

Manual

E	5.98066.07
----------	------------



BAUMÜLLER

Title	Manual
Product	Converter, BKD 6 / ... 7000 BKF 12 / ... 7000
Date of issue	2006-18-05
Software	to Software 03.20

Copyright

This product documentation may be copied by the owner without any limit as to the number of copies which may be made, provided that it is for internal use only. This product documentation may not be reproduced either in whole or in part for any other purpose.

Reuse or disclosure of the contents of this product documentation is not permitted.

Drawings and identifying corporate marks used in this documentation may be trademarks, whose use by third parties for their own purposes may infringe the rights of the holders.

Liability

This product documentation is part of the equipment / the machine. This product documentation must be available in a readable form for users to consult at any time. In the event that the device / the machine is sold or relocated, this product documentation must be handed over by the owner together with the device / the machine.

Following sale of the device / the machine this original and all copies of the documentation must be passed on to the purchaser. This original and all copies are to be destroyed following disposal or other termination of use.

This version of the product documentation supersedes any previous version of the same documentation.

Baumüller reserves the right to vary the technical data on Baumüller products and handling thereof as part of its own further development of the products.

However, no guarantee can be given as regards the absence of errors in this product documentation except where provided otherwise in the General Terms of Sale and Delivery.

Manufacturer	Baumüller Nürnberg GmbH Ostendstr. 80 - 90 90482 Nürnberg Germany Tel. + 49 9 11 54 32 - 0 Fax - 1 30 www.baumueller.de
---------------------	--

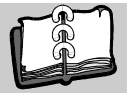

Table of contents

1 Converter description	7
1.1 General	7
1.2 Features	8
1.3 Options	10
1.4 UL listed converters	10
2 Assembly	11
2.1 Dimensions	11
2.2 Power connections	18
2.3 Weights	19
3 Installation	21
3.1 Connection instructions	21
3.2 Location diagrams	29
3.3 Connection diagrams	33
3.4 Setting the power unit identification	42
3.4.1 BKD 7000 (armature power unit)	42
3.4.2 BKF 7000 (armature power unit)	45
3.4.3 Field power unit	48
3.5 Semiconductor protection fuses	49
3.5.1 Converter size I	49
3.5.2 Converter size II	50
3.5.3 Converter size III	50
3.5.4 Converter size IV	50
3.5.5 Fuse sizes	51
3.5.6 Semiconductor fuse, field supply	51
3.6 Mains chokes	52
3.6.1 Three-phase current mains chokes U	52
3.6.2 Single-phase mains choke U	53
3.7 Additional accessories	53
4 Commissioning	55
4.1 Seven-segment display, keypad and LEDs	55
4.1.1 Changing parameter values via the keypad	56
4.1.2 LEDs	57
4.2 Data records	58
4.3 Basic settings	61
5 Operation	65
5.1 Software-Update	65
5.2 Converter control	65
5.2.1 Hardware enable signals	65
5.2.2 Converter control without field bus connection	66
5.2.2.1 Main contactor ON	67
5.2.2.2 Controller enable	68
5.2.2.3 Quick stop	69
5.2.2.4 Pulse inhibit	69
5.2.2.5 State machine for converter control for operation without field bus connection	70



Table of contents

5.2.3	Converter control via communication interface	72
5.2.3.1	State machine of the converter control	72
5.2.3.2	Converter control states	74
5.2.3.3	Description of control word commands	75
5.2.3.4	Converter control in detail	76
5.2.3.5	Converter control state transitions.	78
5.2.4	Switch ON and OFF sequence	82
5.2.4.1	Switch-on sequence	82
5.2.4.2	Switch-off sequence	84
5.3	Converter structure.	85
5.3.1	ALink	85
5.3.1.1	Selecting an ALink.	85
5.3.1.2	Interconnecting ALinks	86
5.3.1.3	Displaying an ALink value	87
5.3.2	DLink	88
5.3.2.1	Selecting a DLink	88
5.3.2.2	Influencing DLinks.	89
5.3.2.3	Displaying a DLink.	89
5.3.2.4	Digital basic functions	90
5.3.3	Digital outputs	92
5.3.4	Digital input functions DIF	94
5.3.4.1	List of digital input functions DIF	96
5.3.5	Overload function.	98
5.4	Function diagrams	100
5.5	Parameter list	133
5.6	Parameter description - Converter data	181
5.7	Parameter description - Measured values	183
5.8	Parameter description - Basic settings.	190
5.9	Parameter description - Drive manager	194
5.10	Parameter description - Communication	200
5.11	Parameter description - Data record manager	214
5.12	Parameter description - Analog inputs	219
5.13	Parameter description - Internal setpoints	223
5.14	Parameter description - Setpoint generator	225
5.15	Parameter description - Motor potentiometer	226
5.16	Parameter description - Ramp generator A	229
5.17	Parameter description - Ramp generator B	234
5.18	Parameter description - Speed controller actual values.	235
5.19	Parameter description - Speed controller setpoints	241
5.20	Parameter description - Current limit	247
5.21	Parameter description - Current controller	250
5.22	Parameter description - Field unit	252
5.23	Parameter description - Digital inputs	256
5.24	Parameter description - Digital input multipliers	258
5.25	Parameter description - Digital outputs	260
5.26	Parameter description - Analog outputs.	266
5.27	Parameter description - Monitoring functions	271
5.28	Parameter description - motor temperature monitoring (from SV 03.10).	282
5.29	Parameter description - Unassigned PI controller	285
5.30	Parameter description - Unassigned function blocks	292
5.31	Parameter description - DLink functions	313



5.32	Parameter description - Option board parameters	322
5.33	Parameter description - Error messages	323
5.34	Function description- Freely definable status word.	348
5.35	Parameter description - System parameters	349
5.36	ALink list	351
5.37	DLink list	366
5.37.1	Description of DLinks (2...23).	406
5.38	List of digital input functions DIF	414
5.38.1	Description of digital input functions DIF	415
6	Errors and warnings	423
6.1	Error display at seven-segment display	423
6.2	BKF7000 error list (P 037)	424
6.3	BKF7000 (P 039) Warning list	427
6.4	Error description	428
6.5	Warning description	452
	Appendix A - Abbreviations	455
	Appendix B - USS protocol	457
B.1	Data transmission and security.	457
B.1.1	Transmission procedure.	458
B.1.2	Net data block structure	459
B.1.3	Bus addresses	459
B.1.4	Mirror message	459
B.1.5	Broadcast message	460
B.1.6	Structure of the PCV area	460
B.1.6.1	PCV area at fixed message length	461
B.1.6.2	Description of the individual PCV elements.	461
B.1.6.3	Command and response code.	461
B.1.6.4	Significance of the IND field (index).	463
B.1.6.5	Parameter value PVA	463
B.1.6.6	Error code list.	464
B.1.6.7	Command/response processing	464
B.1.6.8	Reading parameter attribute feedback	465
B.1.6.9	Reading parameter info feedback	466
B.1.7	Structure of the PCD area	467
B.1.7.1	Description of the individual PCD elements.	467
B.2	Bus system commissioning (fixed message length).	468
	Appendix C - Declaration of Conformity/Manufacturer UL-certification	471
C.1	Declaration of conformity	472
C.2	Declaration of manufacturer	473
C.3	UL-certification	474
	Appendix D - Technical data	475
D.1	Armature converter	475



Table of contents

D.2	Field current converter	476
D.3	Converter ventilators	477
D.4	Type code	478
Appendix E -		
Option board motor temperature monitoring		479
E.1	Assumption	479
E.2	Connecting the measurement sensors (LP 3.0043)	479
E.3	Temperature sensor	480
E.3.1	Connection of the option board	481
Index		483
Table of illustrations		485

CONVERTER DESCRIPTION

1.1 General

Baumüller 7000-series converters are mains-commutated converters for variable-speed microprocessor-controlled DC drives and available in single and four-quadrant versions. Both versions differ merely in the design of the armature control power unit.

The power unit of the single-quadrant converter BKD 6/.../...-7000 is designed as a fully controlled three-phase bridge connection (B6C), and in the case of the four-quadrant converter BKF12/.../...-7000 as a circulating-current-free anti-parallel connection (B6C)2I.

A half-controlled double-pulse bridge B2HKF generally serves as field supply, and field current control is via the microprocessor.

The single-quadrant converters are designed with rated currents from 30 A to 2050 A, and the four-quadrant converters are available for rated currents from 30 A to 1650 A, allowing DC drives to be operated within an output range from approx. 5 kW to up to 800 kW at an armature voltage of 520 V in the case of the four-quadrant converter, and up to approx. 1100 kW at an armature voltage of 600 V in the case of the single-quadrant converter (operation on 500 V, 3~ industrial mains).

The converter series consists of a total of 4 power levels referred to as sizes I .. IV and differing in design and size of the power unit and control module arrangement.

In this type series, drive control, communication and general signal processing is handled by a powerful 16-bit microprocessor system located on the microprocessor board. Board and remaining electronic components such as power supply and field devices are identical for all converter sizes. The microprocessor board is a top print, allowing all relevant components to be accessible easily and from the front.

The converter operating software and the EEPROM with the machine-specific data records are located on a plug-in module designed to allow simple exchange.

Designed with the relevant analog setpoint and additional inputs and digital control inputs, the range of applications includes the replacement of existing analog converter series such as BKF 12/.../2000, BKF 12/.../3000, BKD 6/.../2000 or BKD/BKF../6000.

The converters can also be combined with PCs, PLCs, NCs or CNCs. Adaptation to different bus systems may be via additional modules (option boards), for example, that may be optionally fitted to the microprocessor board.

1.2 Features

- ▶ Signal processing controlled by a powerful 16-bit microprocessor system
- ▼ Operation
 - ▶ Via integrated keypad, LED and 7-segment displays
 - ▼ Via RS232 PC interface, optionally menu-assisted via the
 - ▶ WINBASS operating program
 - ▼ Via RS 485 field bus interface, optionally via
 - ▶ USS protocol connection
 - ▶ One of the optionally available interface cards for BM CAN interface, PROFIBUS-DP, CANopen (in preparation)
- ▶ Modular software structure with freely interconnectable function blocks (e.g. adders, multipliers, dividers, ...)
- ▼ Controller structures
 - ▶ Speed control via tachogenerator with/without field weakening
 - ▶ Speed control via incremental encoder with/without field weakening
 - ▶ Constant-field armature voltage control
 - ▶ Current control with/without field weakening
 - ▶ Freely configurable adaptive PI controller for higher-level control tasks
- ▼ 6 data records
 - ▶ Freely programmable for adaptation to different applications
 - ▶ Online change-over via serial interface or terminals even during operation
- ▼ Setpoint sources
 - ▼ 4 analog setpoint inputs
 - ▶ Differential inputs, $\pm 10\text{V}$, resolution 11 bit
 - ▶ Scaling, offset and polarity can be parameterised
 - ▶ 2 inputs variable from $\pm 10\text{ V}$ to $0\dots 20\text{ mA}$ or $4\dots 20\text{ mA}$
 - ▶ 6 internally fixed-programmable setpoints
 - ▶ Internal setpoint generator
 - ▶ Internal motorised potentiometer
 - ▶ RS 485 field bus interface at basic unit or optional plug-in interface cards

- ▼ 2 ramp generators
 - ▶ Ramp generator A with separately adjustable ramp-up and ramp-down times. Additionally with separately adjustable roundings and 2 selectable parameter sets.
 - ▶ Ramp generator B with separately adjustable ramp-up and ramp-down times.
- ▶ Adaptive speed controller with P/PI characteristic and D component for actual-value input.
- ▶ Microprocessor-controlled field supply, with or without field weakening as well as standstill field.
- ▼ 6 analog outputs.
 - ▶ 4 programmable analog outputs, ± 10 V, 10 mV resolution.
 - ▶ 2 fixed analog outputs, direct analog signal, for actual speed (tachogenerator only) and armature current.
- ▶ Mains and connection monitoring at the AC and DC side (also for tachogenerator connection).
- ▼ Control via decoupled, partially programmable switching inputs.
 - ▶ 4 fixed digital inputs for converter enables (quick stop, main contactor ON/OFF, controller enable, pulse enable)
 - ▶ 8 freely programmable digital inputs.
- ▶ 6 freely programmable digital outputs.
- ▶ 2 fixed relay outputs for ready to operate (terminal strip X2) and main contactor ON (terminal strip X5).
- ▼ Connections
 - ▶ RS485 interface at the basic unit for USS protocol connection, optional plug-in interface cards for BM-CAN interface, PROFIBUS-DP, CANopen (in preparation).
 - ▶ RS232 interface for drive parameterisation (PC).
 - ▼ Incremental encoder input for:
 - ▶ 5 V differential signal/ RS422
 - ▶ 24 V single-ended
 - ▶ Decoupled incremental encoder output / RS422 signal
 - ▶ Tachogenerator input up to max. $240 V_{DC}$
 - ▶ Adapter board for control connections
 - ▶ Custom-tailored if required (e.g. plugs instead of print terminals)
- ▶ Converters BKD and BKF completely identical except for the power unit.

1.3 Options

- ▶ Operating and service software
- ▼ Option boards
 - ▶ Field bus interface for BM-CAN interface, PROFIBUS-DP, CANopen

1.4 UL listed converters

- ▶ Up to now the following converters are UL listed
 - ▶ BK.../0030/...
 - ▶ BK.../0050/...
 - ▶ BK.../0080/...
 - ▶ BK.../0100/...
 - ▶ BK.../0140/...
 - ▶ BK.../0200/...
 - ▶ BK.../0240/...
 - ▶ BK.../0340/...
 - ▶ BK.../0450/...
 - ▶ BK.../0550/...
 - ▶ BK.../0650/...

Supplementary notes complying with UL508C:

- ▶ Connection cables:
Use only 600C/750C copper cables
- ▶ Torques for power connections of current bars:
Connection screw M8: 10 Nm
Connection screw M10: 20 Nm
- ▶ Maximum short circuit current of the feeding mains:

Unit	Short circuit current in A
BK.../0030/...	5 kA
BK.../0050/...	5 kA
BK.../0080/...	5 kA
BK.../0100/...	10 kA
BK.../0140/...	10 kA
BK.../0200/...	10 kA
BK.../0240/...	10 kA
BK.../0340/...	18 kA
BK.../0450/...	18 kA
BK.../0550/...	30 kA
BK.../0650/...	30 kA

2

ASSEMBLY

2.1 Dimensions

BKD6 and BKF12 / ... 7000, size I (30 A to 200 A)

When mounting, leave 150 mm free space for air circulation at the top and bottom of the converter

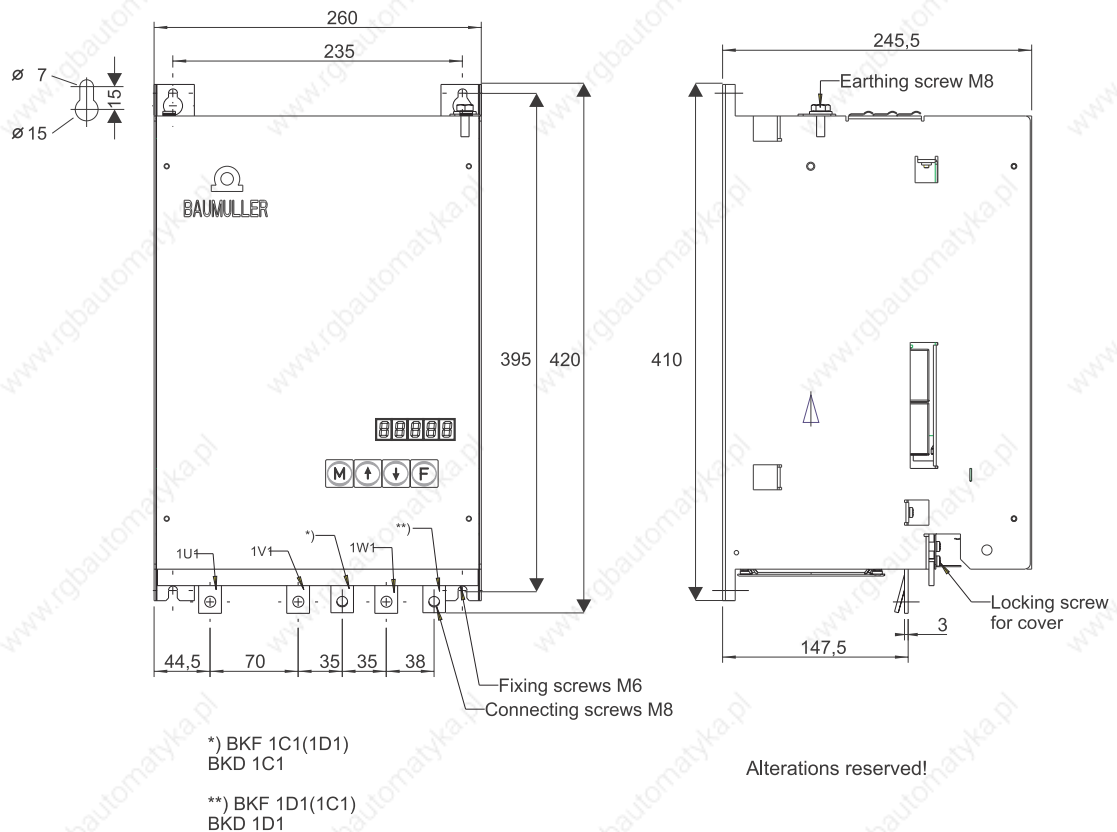
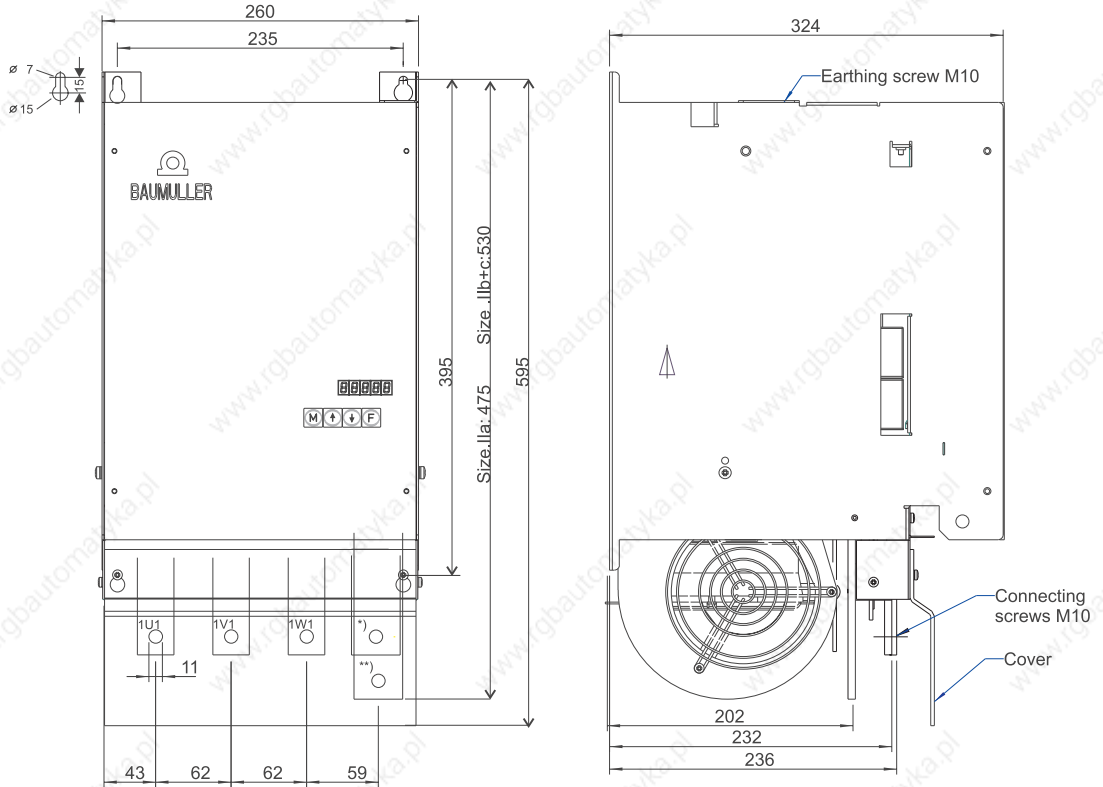

Illustration 1: Dimensions, size 1

2.1 Dimensions

BKD6 und BKF12 / ... 7000, Größe II (240 A to 700 A)

BKD6 und BKF12 / ... 7000, Größe II c (800 A + 950 A)



*) BKF: 1D1(1C1)

BKD: 1C1

**)BKF: 1C1(1D1)

BKD: 1D1

Alterations reserved!

Illustration 2: Dimensions, size 2

Controller and field supply, sizes III, IV (750 A to 2050 A)

When mounting, leave 150 mm free space for air circulation at the top and bottom of the converter

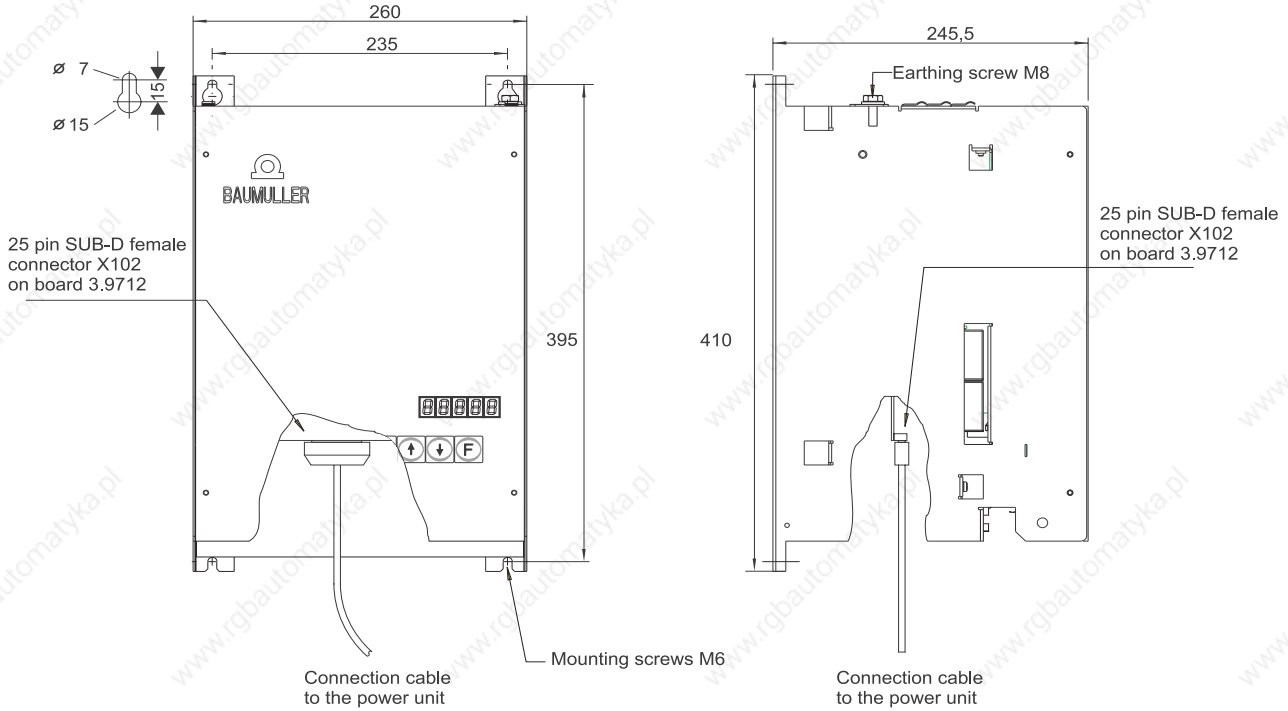

Illustration 3: Dimensions controller and field supply, sizes III, IV

2.1 Dimensions

Power unit BKD6 ... 7000, size III (750 A and 920 A)



Abbildung 4: Dimensions power supply BKD 6, size III (750 A, 920 A)

Power unit BKD 6 / ... 7000, size III (1100 A)

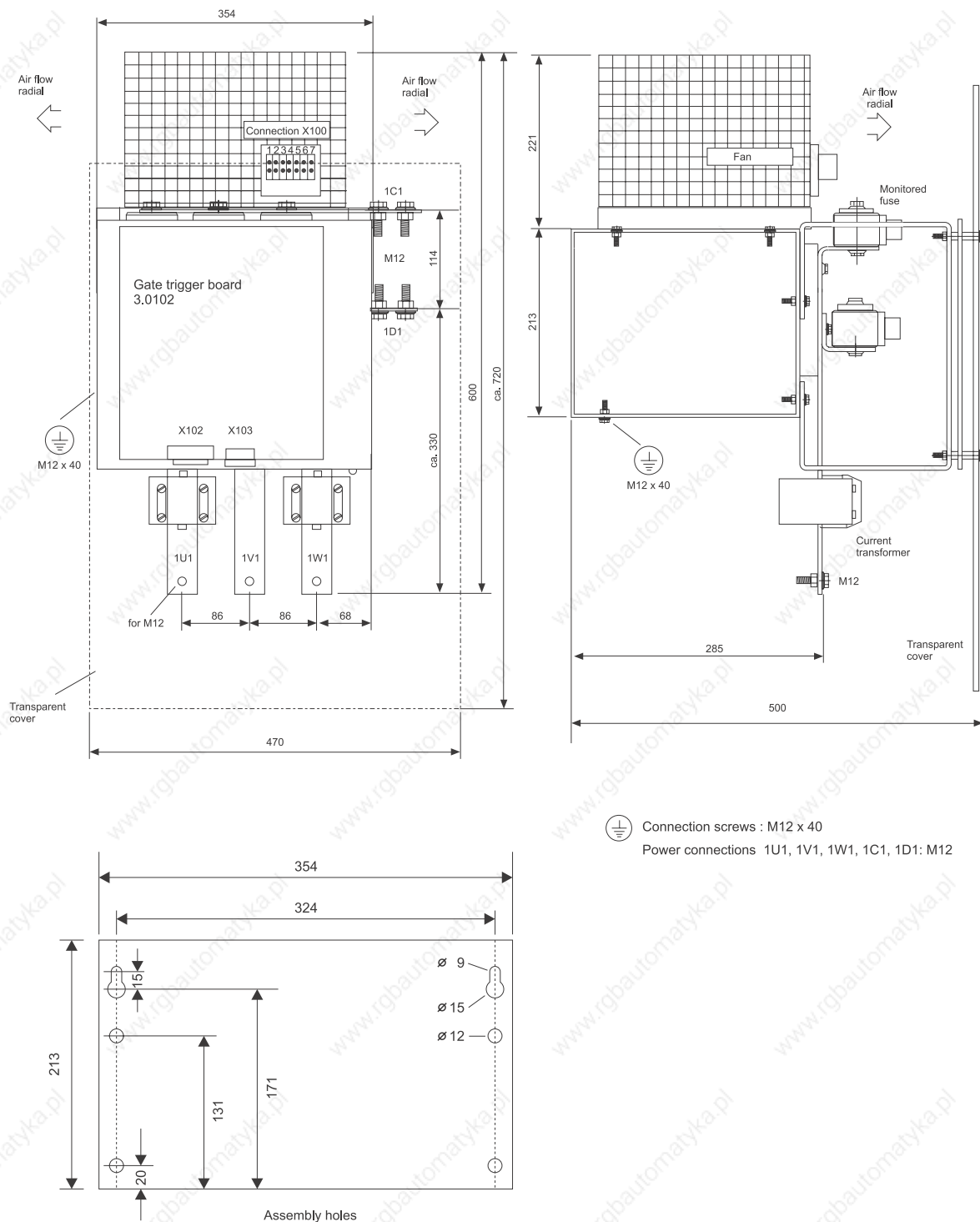
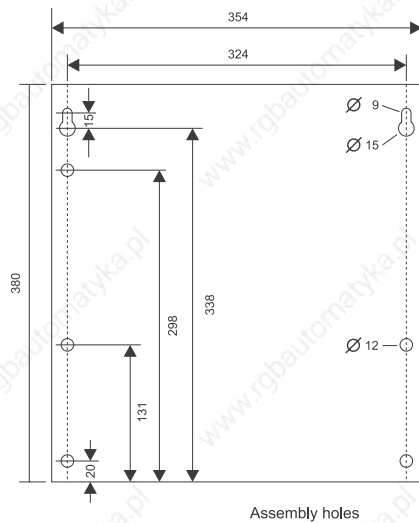
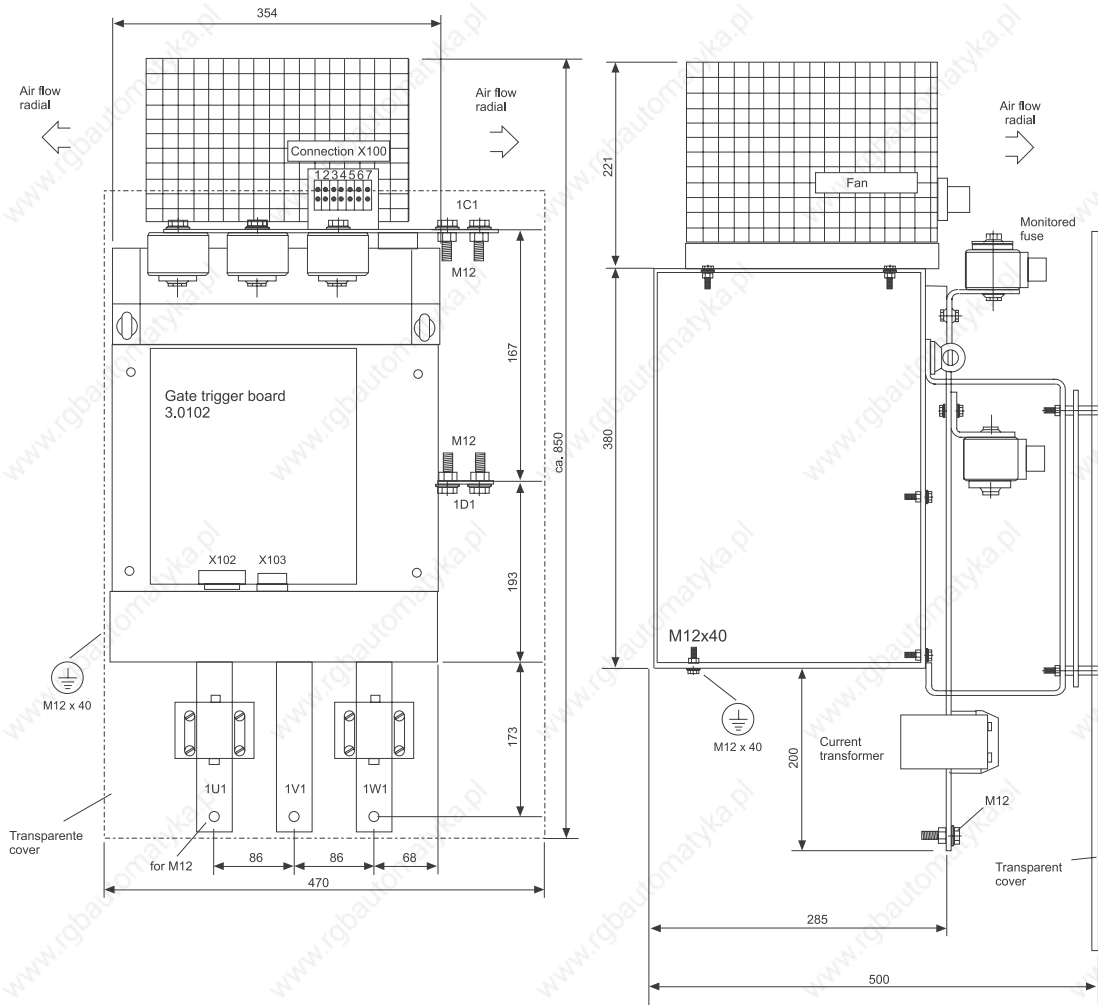

Illustration 5: Dimensions power unit BKD 6, size III (1100 A)

2.1 Dimensions

Power unit BKF 12, size III (850 A)



Abbildung 6: Dimensions power unit BKF 12, size III (850 A)

Power unit, size IV

BKD 6 / ... / 7000
BKF 12 / ... / 7000

1550 A, 1750 A, 2050 A
1250 A, 1400 A, 1650 A

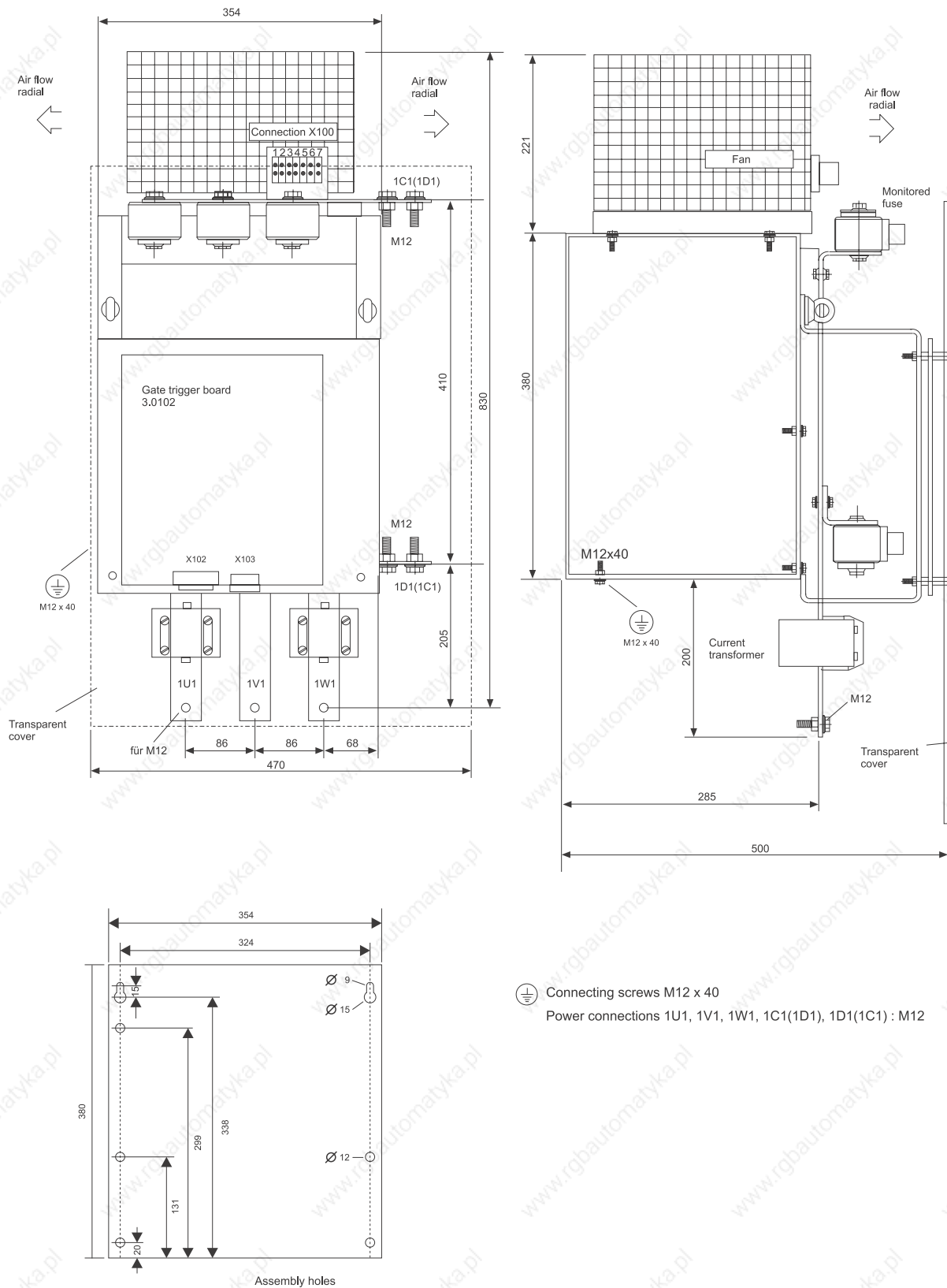
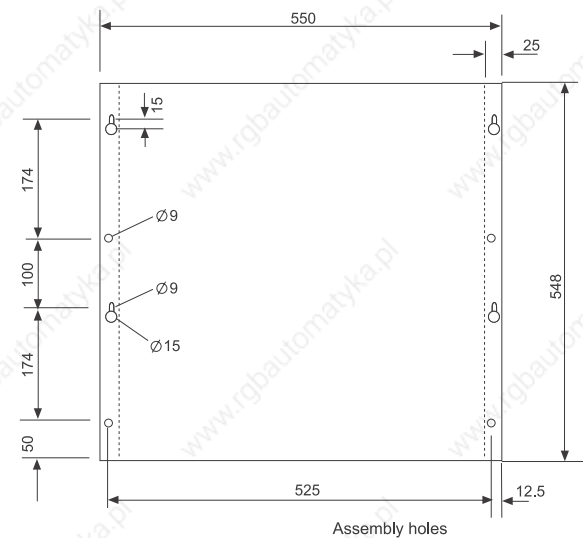
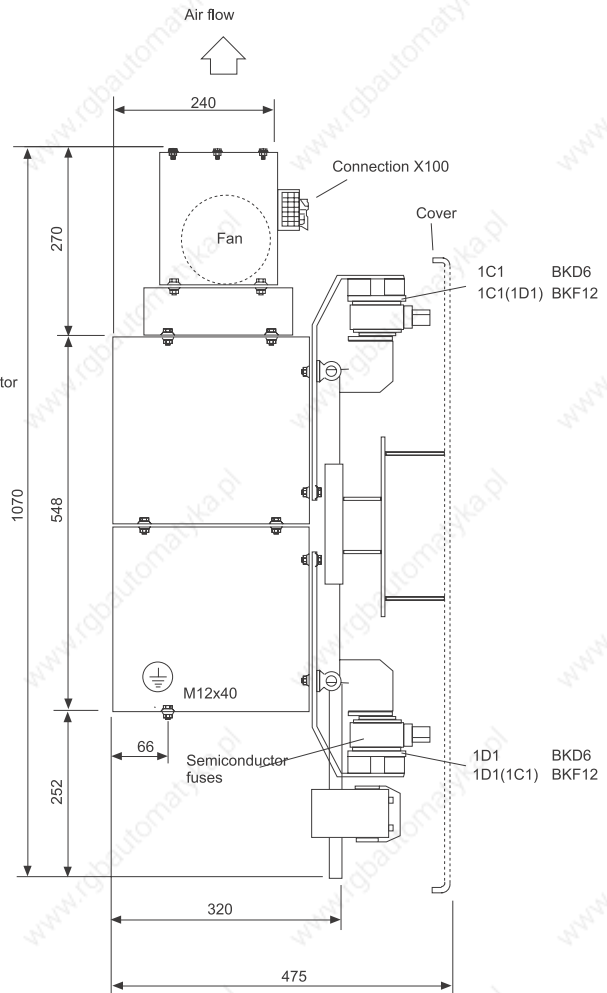
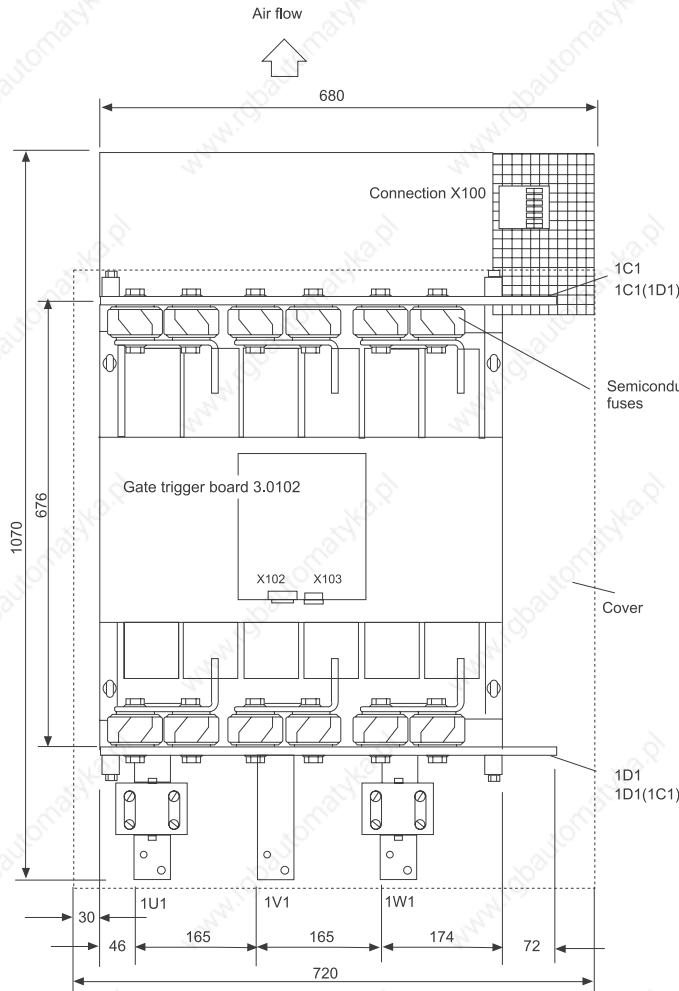

⊕ Connecting screws: M12 x 40
Power connections see next page

Abbildung 7: Dimensions power unit, size IV

2.2 Power connections

2.2 Power connections

Power connections, size IV

Contact rail 1U1,1V1 and 1W1

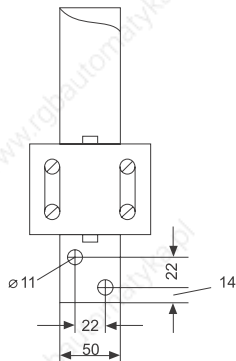

Contact rail 1C1 and 1D1 on BKD6 and 1C1(1D1) / 1D1(1C1) on BKF12

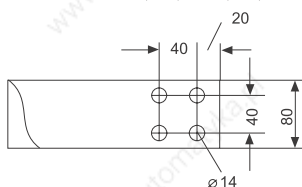

Illustration 8: Dimensions power connections, size IV

Optionally following angle bars are available connecting the DC contact rails 1C1 and 1D1:

Article no.: 1231965

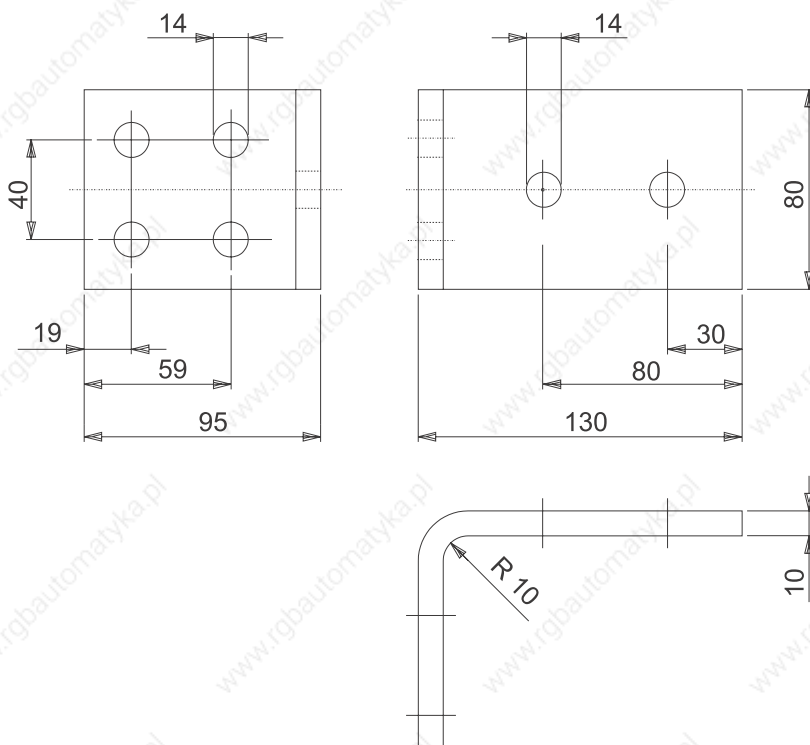

Illustration 9: Dimensions connection angle bar, size IV

Using the angle bars is independent of the kind of electrical terminal at the DC current bars:

When using a crimp connection the distance of the mounting holes at the bars 1C1 and 1D1 could be too small for the assembly.

2.3 Weights

- ▶ Size I

	17 kg
--	-------

- ▶ Size II

	28 kg ... 32 kg
--	-----------------

- ▶ Power unit, sizes III and IV:

Size III:	BKD	43 kg ... 54 kg
	BKF	55 kg
Size IV:	BKD	124 kg ... 128 kg
	BKF	124 kg ... 130 kg

- ▶ Control board, sizes III and IV:

Sizes III, IV:	13 kg
----------------	-------

2.3 Weights

3

INSTALLATION

3.1 Connection instructions

Plug-in jumpers W500 and W501

W501: Reference point for control inputs X2: 15...26

is fitted if the +24 V for the converter enables are drawn from the converter (X1: 25, 26); do not fit if the controller is directly enabled by the PLC or the control !

Reference potential in this case are terminals X2: 13, 14 (Bse); the jumper is fitted in the factory.

W500: Defining the reference point for control input X2: 18 (pulse enable).

Jumper A-B selects the reference point input with W501 for the other control inputs.

Jumper B-C fixes the reference point to the internal reference ground (M24V), allowing pulse enable connection to the 24 V of the converter even if the other enables are supplied by the higher-level control.

This approach ensures that voltage failures in the external control, which would otherwise lead to a pulse inhibit, have no adverse effect on the converter.

Uncontrolled converter disable may lead to converter damage.

The pulse enable is a pure hardware function that acts directly upon the power stage (pulse generation) independent of the converter operating state. Suppressing the firing pulses during drive deceleration may lead to fuses blowing in the mains supply line. In extreme cases, the thyristors may be damaged (shoot-through)!

3.1 Connection instructions

Terminal strip X1: Print terminals

Conductor cross-sectional area 0.14 ... 1.5 mm²

X1: 1	Setpoint supply	Speed setpoint voltage stabilised, -10 V / 10 mA
X1: 2	Setpoint supply	Speed setpoint voltage stabilised, +10 V / 10 mA
X1: 3	Actual speed	Polarity negative in clockwise motor rotation (A-side), available for tachogenerator connection only, max. 4 mA
X1: 4	Reference potential	Bsa for actual speed
X1: 5	Actual armature current	0 ... +10 V, max. 4 mA; 10 V corresponding to 200 % of the rated converter current (unsmoothed I_{actual} , observe current ripple)
X1: 6	Reference potential	Bsa for actual armature current
X1: 7	Analog output 1	programmable via parameters P 461...P 465 0 ... +/-10 V, max 4 mA; resolution 10 mV
X1: 8	Reference potential	Bsa for analog output 1
X1: 9	Analog output 2	programmable via parameters P 466...P 470 0 ... +/-10 V, max 4 mA; resolution 10 mV
X1: 10	Reference potential	Bsa for analog output 2
X1: 11	Analog output 3	programmable via parameters P 471...P 475 0 ... +/-10V, max 4 mA; resolution 10 mV
X1: 12	Reference potential	Bsa for analog output 3
X1: 13	Analog output 4	programmable via parameters P 476...P 480 0 ... +/-10 V, max 4 mA; resolution 10 mV
X1: 14	Reference potential	Bsa for analog output 4
X1: 15	Reference potential	Bsa
X1: 16	Reference potential	Bsa
X1: 17	Analog input 1	Difference amplifier input -
X1: 18		Difference amplifier input + with S800 it can be changed over from +/-10 V to 0 ... 20 mA or 4 ... 20mA
X1: 19	Analog input 2	Difference amplifier input -
X1: 20		Difference amplifier input + with S800 it can be changed over from +/-10 V to 0 ... 20 mA or 4 ... 20 mA
X1: 21	Analog input 3	Difference amplifier input -
X1: 22		Difference amplifier input + +/-10 V
X1: 23	Analog input 4	Difference amplifier input -
X1: 24		Difference amplifier input + +/-10 V
X1: 25	+24 V	Use for digital input control only !
X1: 26	+24 V	Current limitation starts at 300 mA

Terminal strip X2: Print terminals

Conductor cross-sectional area 0.14 ... 1.5 mm²

X2: 1	Ready	NO contact	} Relay picks up when ready Relay contacts can be loaded with 24 V/1 A
X2: 2		NC contact	
X2: 3		Common	

X2: 4 +24 V ext. for external digital output supply
insert jumper W600 to B-C

Programmable digital outputs (P 421...P 444)

X2: 5	Dig. output 1	} Load of digital outputs: for internal supply: max. 20 mA per output for external supply: max. 100 mA per output Signal level: H signal: 15 V...30 V L signal: 0 V...3 V
X2: 6	Dig. output 2	
X2: 7	Dig. output 3	
X2: 8	Dig. output 4	
X2: 9	Dig. output 5	
X2: 10	Dig. output 6	

X2: 11	Reference potential	Bsd for digital outputs
X2: 12	Reference potential	Bsd for digital outputs
X2: 13	Reference potential	Bse for digital inputs
X2: 14	Reference potential	Bse for digital inputs

Jumper W501 on jumper A-B must be fitted if the internal 24 V of X1: 25, 26 is used.
If the control's 24 V is used, W501 must be fitted on jumper B-C so that the control is isolated from the electronics ground (optocoupler inputs). A 50 V potential difference with regard to the electronics ground is permissible for isolation.

X2: 15	Main contactor ON	} Enable commands: Input signal level: H signal: 13 V ... 30 V L signal: 0 V ... 7.5 V
X2: 16	Controller enable	
X2: 17	Deactivate Quick stop	
X2: 18	Pulse enable	

X2: 19	Dig. input 1	} Programmable digital inputs (Parameters P 401...P 408) Signal level: H signal: 13 V ... 30 V L signal: 0 V ... 7.5 V
X2: 20	Dig. input 2	
X2: 21	Dig. input 3	
X2: 22	Dig. input 4	
X2: 23	Dig. input 5	
X2: 24	Dig. input 6	
X2: 25	Dig. input 7	
X2: 26	Dig. input 8	

3.1 Connection instructions

Terminal strip X3: Plug-in terminal

Conductor cross-sectional area 0.2 ... 2.5 mm²

- X3: 1 tachogenerator connection U_{Tacho} 60 V ... 240 V
- X3: 2 tachogenerator connection U_{Tacho} 15 V ... 75 V
- X3: 3 tachogenerator connection U_{Tacho} 4 V ... 20 V
- X3: 4 Reference potential Bsa for tachogenerator connection

RS 232 interface

SUB-D plug X23: Female connector, 9pole

Supply voltage on controller potential !

Interface cable PC power unit 3 m article no. 213846
other lengths on demand

Pin no.	Assignment
1	Not assigned
2	TxD RS232
3	RxD RS232
4	Not assigned
5	Bsd
6	+5 V
7	Not assigned
8	Not assigned
9	Not assigned

RS485 interfaces for USS protocol connection

SUB-D plug X29A: female connector, 9pole

SUB-D plug X29B: male connector, 9pole

Supply voltage isolated
(50V to controller electronics)

Pin no.	Assignment
1	-TxD RS485
2	+5 V RS485
3	Ground RS485
4	Ground RS485
5	-RxD RS485
6	+RxD RS485
7	Ground RS485
8	Ground RS485
9	+TxD RS485

Incremental encoder input

RS422 interface for incremental encoder with rectangular pulses

SUB-D plug X24: female connector, 15-pole
Supply voltage on controller potential !

Pin no.	Assignment
1	Ground
2	+5 V encoder supply
3	RS422 incremental encoder +U0
4	RS422 incremental encoder -U0
5	RS422 incremental encoder +U2
6	Not assigned
7	RS422 incremental encoder -U1
8	RS422 incremental encoder +U1
9	RS422 incremental encoder -U2
10	Not assigned
11	Not assigned
12	+5 Sensor
13	0V Sensor
14	Not assigned
15	Not assigned

Incremental encoder output

SUB-D plug X27: male connector, 15-pole
Supply voltage on controller potential !

Pin no.	Assignment
1	Ground
2	Not assigned
3	Incremental encoder +U0
4	Incremental encoder -U0
5	Incremental encoder +U2
6	Not assigned
7	Incremental encoder -U1
8	Incremental encoder +U1
9	Incremental encoder -U2
10	Not assigned
11	Not assigned
12	Not assigned
13	Not assigned
14	Not assigned
15	Not assigned

3.1 Connection instructions

Terminal strip X4: Print terminal
Conductor cross-section 0.2 ... 4.0 mm²

X4: 1	2U1	Mains connection L1
X4: 2	2W1	Mains connection L3
X4: 3	2C1	+ connection of field winding (F1)
X4: 4	2D1	- connection of field winding (F2)

Terminal strip X5: Plug-in terminal
Conductor cross-section 0.2 ... 2.5 mm²

X5: 1	4U1	Fan connection L
X5: 2	N	Fan connection N

for externally ventilated units (from 140A)

Converters	power consumption
140 A, 200 A	230 V / 0.40 A
240 A, 340 A	230 V / 0.50 A
450 A, 550 A, 650 A, 700 A	230 V / 0.85 A

X5: 3	Not assigned		
X5: 4	Main contactor	NO contact	Main contactor K1 control Relay contacts can withstand 230V _{AC} / 1A _{AC} or 24V _{DC} / 1A _{DC} (non-inductive load); The relay is activated by the control command 'Main contactor ON' at terminal X2: 15
X5: 5	ON	NC contact	
X5: 6	Relay	Common	

Power supply unit X6:

X6: 1	3U1	Power supply unit connection L1
X6: 2	Not assigned	
X6: 3	3W1	Power supply unit connection at L3

Connect L1 and L3 in phase with field and armature supply
(refer to [▶3.3 Connection diagrams◀](#) from page 33)

External +24V X7: (optional for electronics supply)

X7: 1	+24 V ext. add.		Required for converters with field bus connection
X7: 2	Reference voltage	Bsd	if, while the power section supply is switched off, communication must be maintained at X6: 1,3.

Armature and field connections

1U1	Connections	Connect via choke D1, fuses F1 and main contactor K1 to the three-phase mains L1, L2, L3.
1V1	of the	
1W1	thyristor set	Observe clockwise rotating field and in-phase condition with power supply unit and field supply! Terminal screws refer to ▶2.1 Dimensions◀ from page 11
1C1, 1D1 / 1C1(1D1), 1D1(1C1)	Motor connections	1C1 / 1C1(1D1) is positive during clockwise rotation
F1	Phase fuses	refer to ▶3.5 Semiconductor protection fuses◀ from page 49.
F2	Armature circuit fuses	For recommendations refer to ▶3.5 Semiconductor protection fuses◀ from page 49. The BKD converter has no armature circuit fuses F2
K1	Main contactor	is operated in current-free condition, isolates the power unit
D1	Three-phase current mains choke	For recommendations refer to ▶3.6 Mains chokes◀ from page 52, reduces converter disturbances of the supplying mains and protects the thyristors from impermissible rates of current rise. The specified rated currents refer to the DC side.
L1, L2, L3	Cable conductors	Cross-section as per DIN EN 60204 part 1 / VDE 0113 part 1 / 06.93, sections 14 and 15, appendix C, and VDE 0298 / part 4
1B1, 2B2	Motor connections	Cross-section as per DIN EN 60204 part 1 / VDE 0113 part 1 / 06.93, sections 14 and 15, appendix C, and VDE 0298 / part 4; connection 1B1 positive for clockwise shaft rotation
PE	PE conductor connection	Cross-section as per DIN EN 60204 part 1 / VDE 0113 part 1 / 06.93, section 8.2.2, observing pr EN 50178 / VDE 0160 / 11.94, sections 5.3.2.1 and 8.3.4.4; terminal screw refer to ▶2.1 Dimensions◀ from page 11
F3	Semiconductor fuse in field connection	2 x screw-in fuses 5SD4.. 16 A ... 30 A / 500 V~, dependent on field converter rated current, refer to ▶3.5 Semiconductor protection fuses◀ from page 49.
F4	Line protection	Fuse 0.4 A mtr / 500 V or motor protection switch 0.4 A ... 0.63 A
F5	Backup fuse	for fan

Converters	Fuse
140 A, 200 A	230 V / 0.40 A or motor protection switch
240 A, 340 A	230 V / 0.50 A or motor protection switch
450 A, 550 A, 650 A, 700 A	230 V / 0.85 A or motor protection switch

3.1 Connection instructions

F1, F2	Connection Field winding	Cross section as per DIN EN 60204 part 1 / VDE 0113 part 1 / 06.93, sections 14 and 15, appendix C, and VDE 0298 / part 4. Connection F1 positive for clockwise shaft rotation.
D2	Field mains choke	one choke in one supply line, designed in accordance with the field unit rated current, refer to section on mains chokes.

3.2 Location diagrams

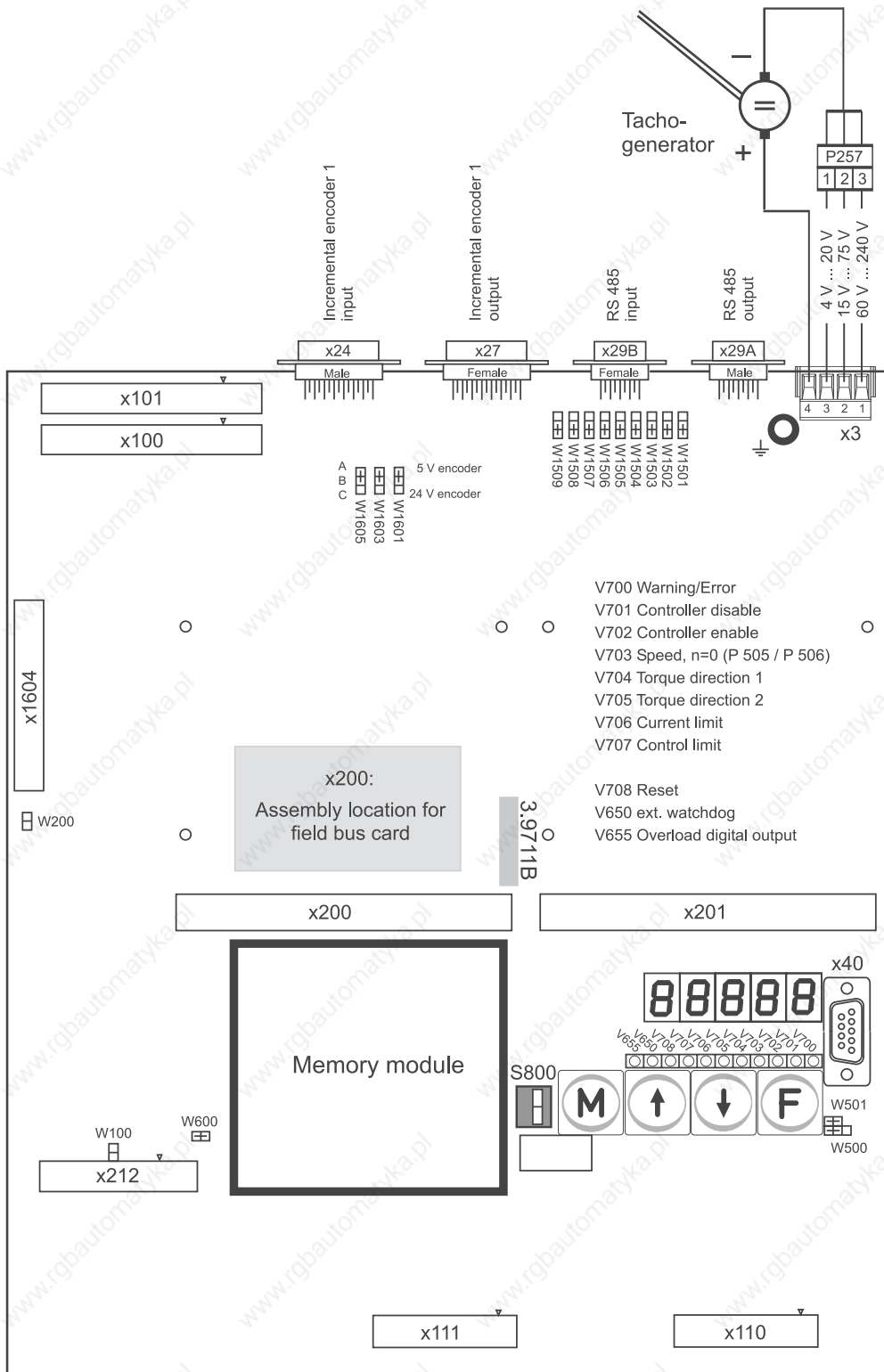
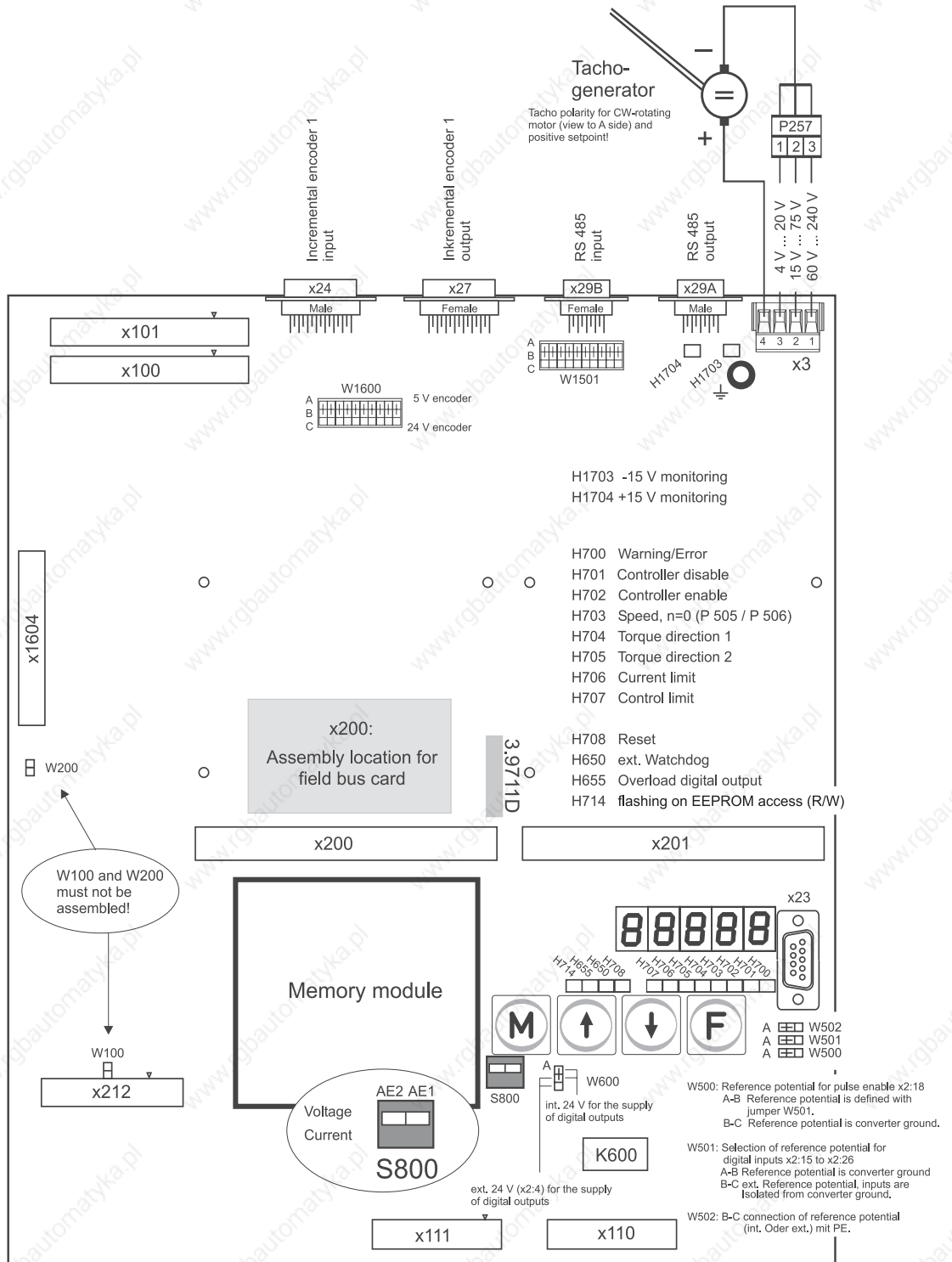

Illustration 10: Location diagram, board 3.9711B

3.2 Location diagrams



PC cable (at X23): 3 m article-no. 213846

Illustration 11: Location diagram, board 3.9711D

Plug-in jumpers board 3.9711:

W100 Not allowed to be fitted!

W200 For operation of the power unit the jumper must not be fitted!
For a software update of the power unit the plug-in jumper must be fitted before the switch-on of the power supply. Remove the plug-in jumper after software update. Fit and remove plug-in jumper only in voltage free state.

W500 Reference point for pulse enable of input X2: 18

A-B The reference point is determined by plug-in jumper W501

B-C The reference point is identical with the unit reference point, independent of W501

W501 Reference point for digital inputs X2: 15 bis X2: 26

A-B The reference point is identical with the unit reference point

B-C External reference point (X2: 13 und X2: 14), the inputs are not related to the reference point of the unit (electrically insulated, max. 50 V potential difference are permitted)

W502 Connection of X2: 13 und X2: 14 with PE

A-B No connection with PE

B-C Terminals are connected with PE

W600 Supply digital outputs X2: 5 up to X2: 10

A-B Unit internal supply of digital outputs, max. 20 mA per output

B-C External supply of digital outputs, may. 100 mA per output

When using external supply of the digital outputs the reference of the external voltage must be connected with the unit reference (X2: 11 up to X2: 14). The outputs cannot be electrically insulated from the unit reference.

W1501 not fitted

W1600 Selection of levels of incremental encoder 1 (at X24)

A-B Encoder signal 5 V (differential signal)

B-C Encoder signal 24 V (single ended)

3.2 Location diagrams

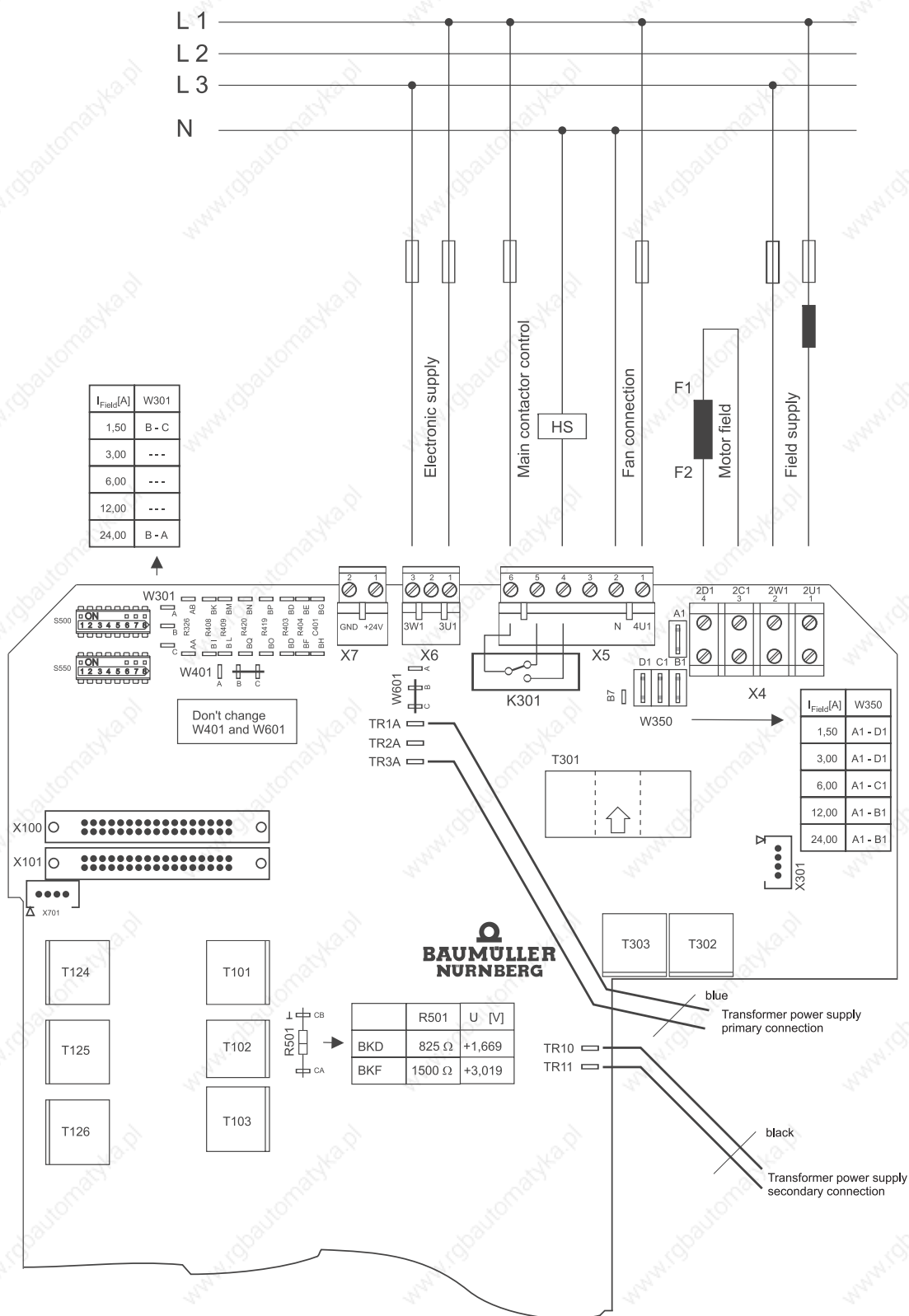

Illustration 12: Location diagram, board 3.9712B

3.3 Connection diagrams

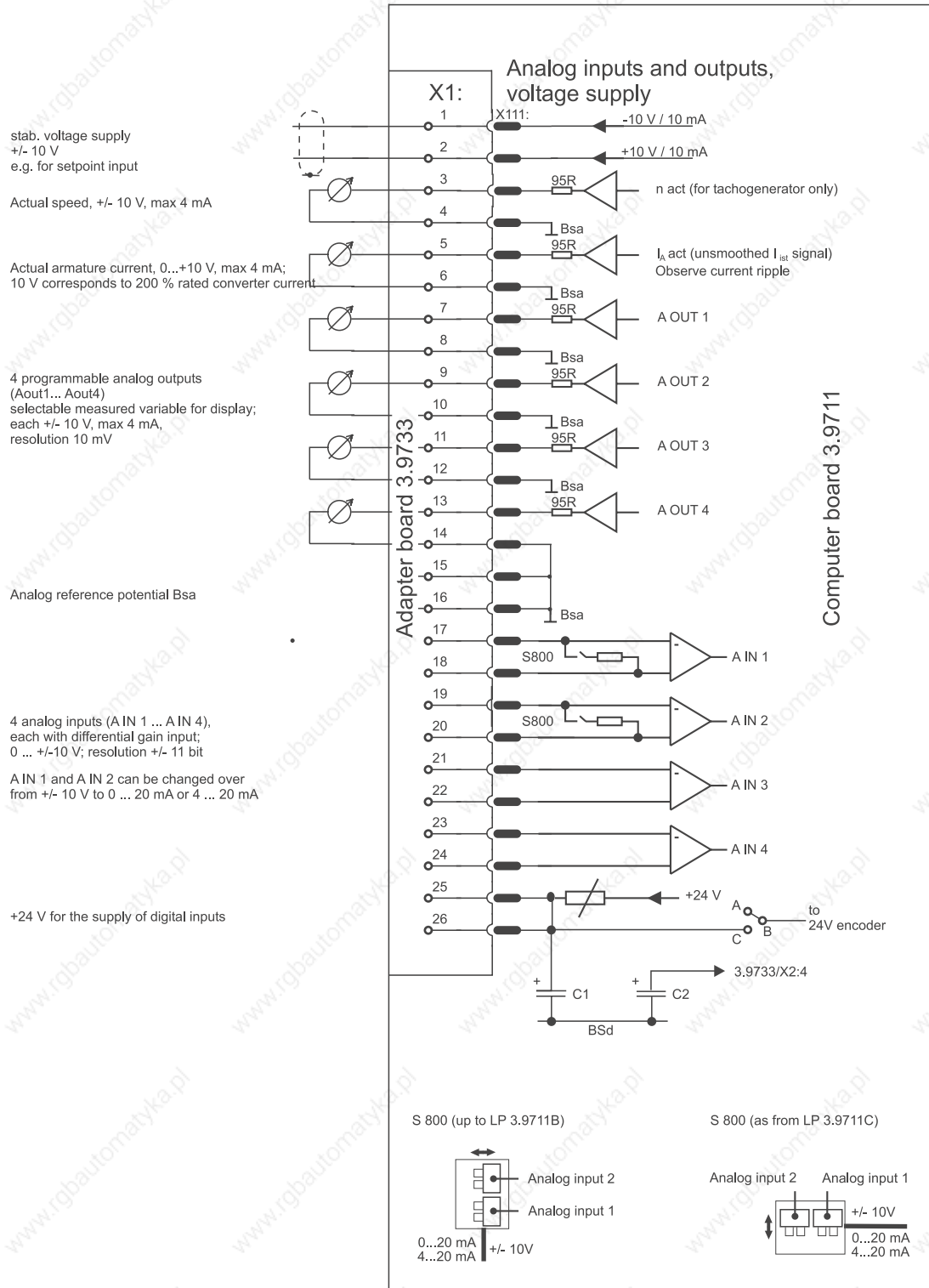

Illustration 13: Connection diagram, analog inputs and outputs

3.3 Connection diagrams

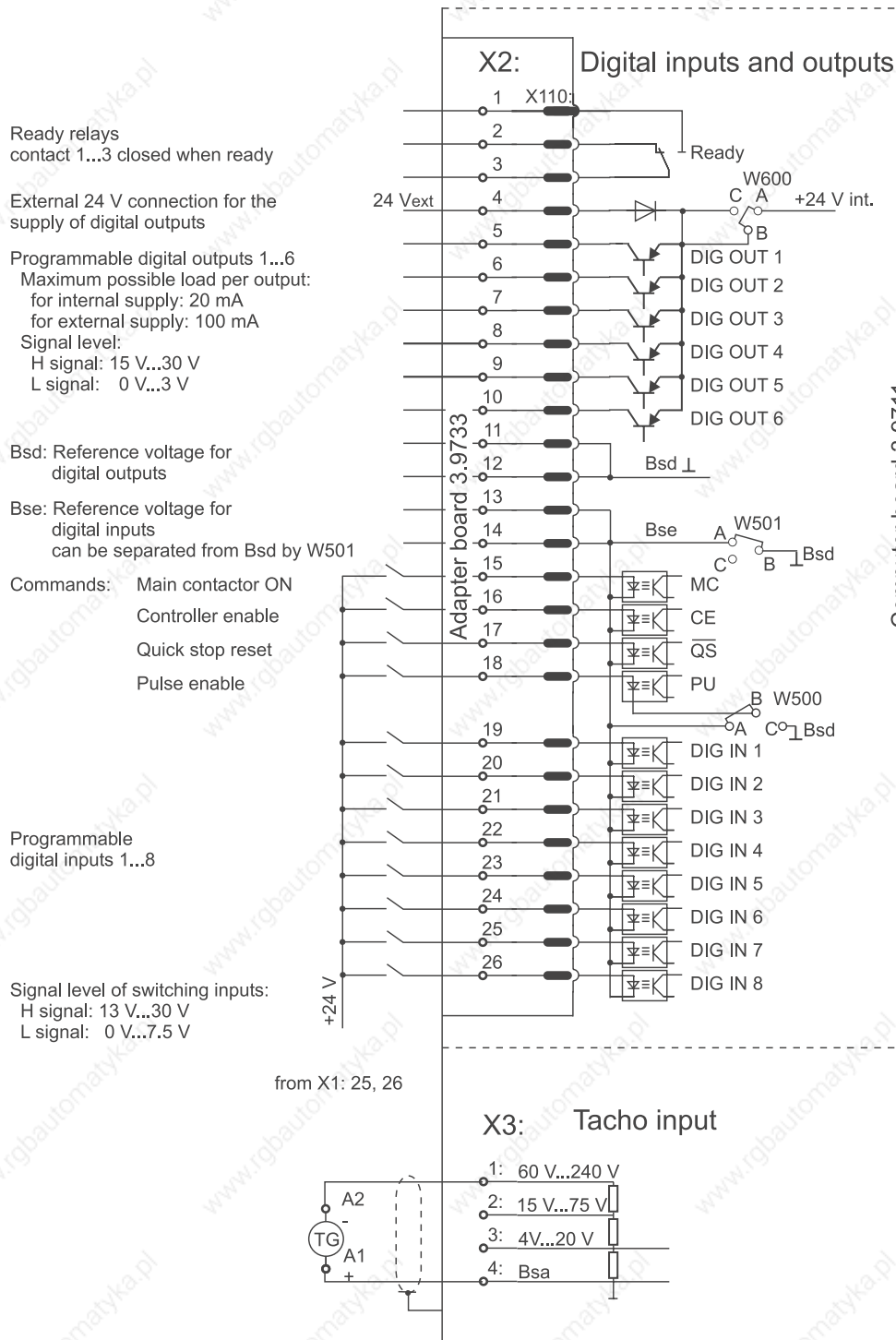
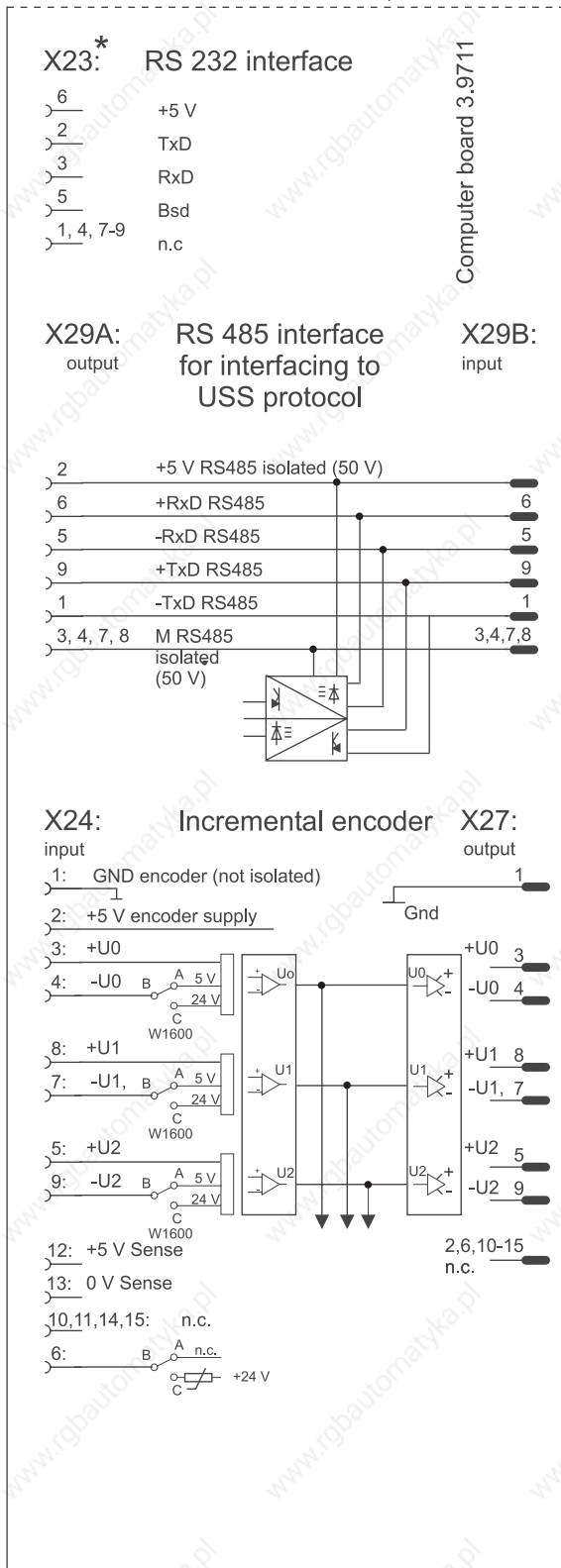

Illustration 14: Connection diagram, digital inputs and outputs

* X23 as from board 3.9711D
X40 up to board 3.9711B



3 m cable: article no.. 213846
10 m cable: article no. 213283

Illustration 15: Connection diagram, RS 232 - RS 485 - incremental encoder

3.3 Connection diagrams

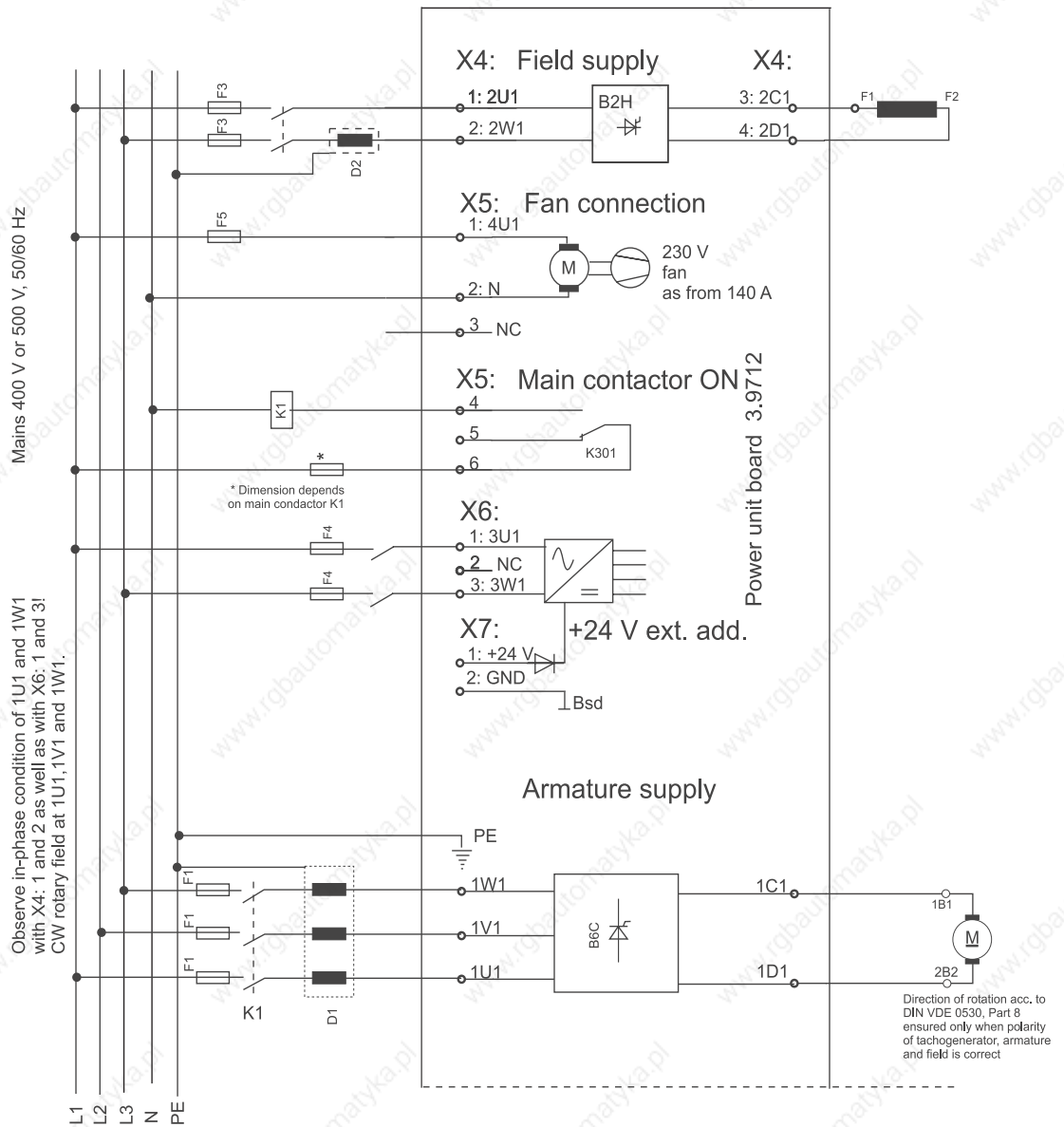

Illustration 16: Connection, power unit BKD 6/ 7000, sizes I and II

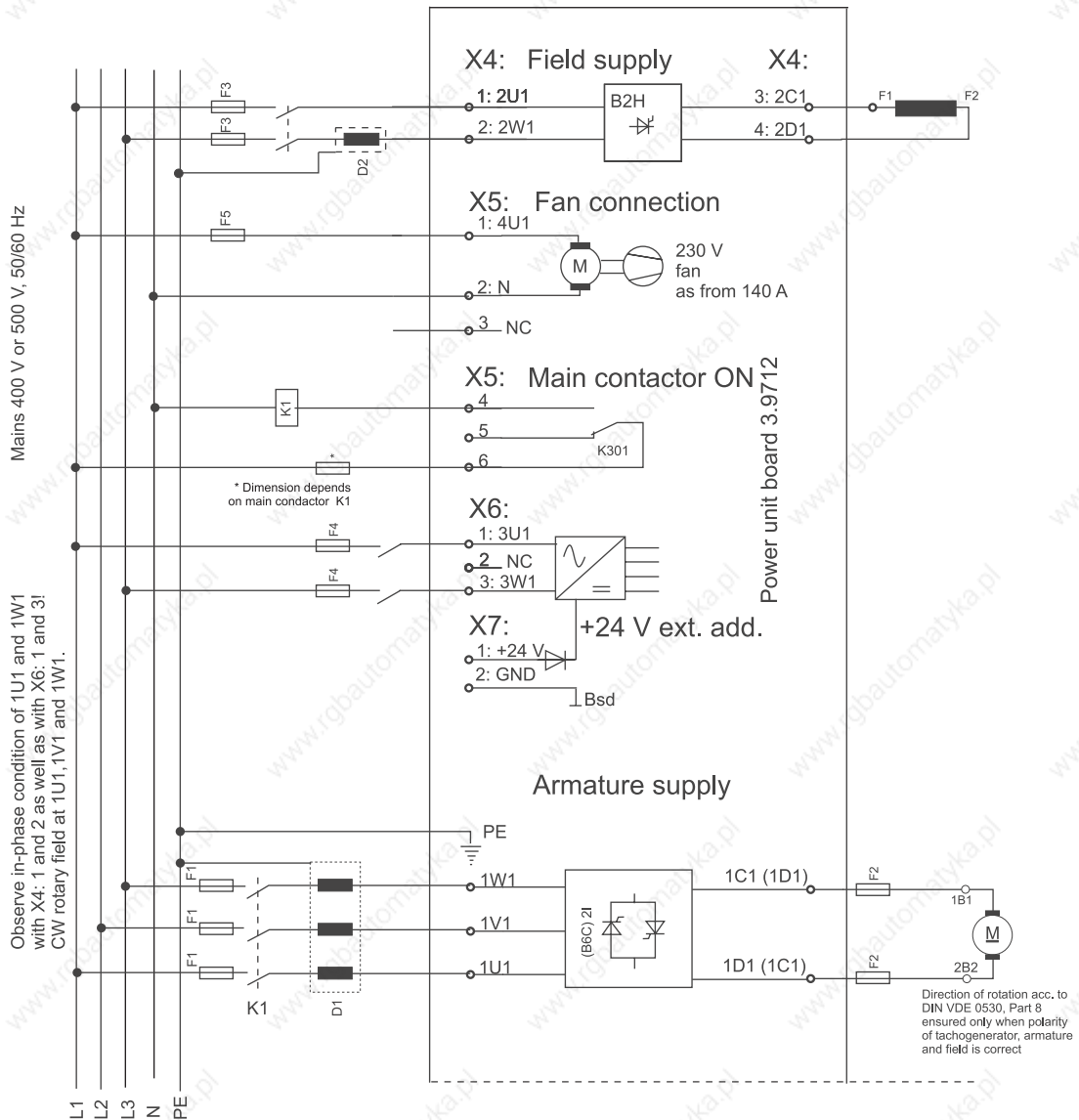

Illustration 17: Connection power unit BKF 12/ 7000, sizes I and II

3.3 Connection diagrams

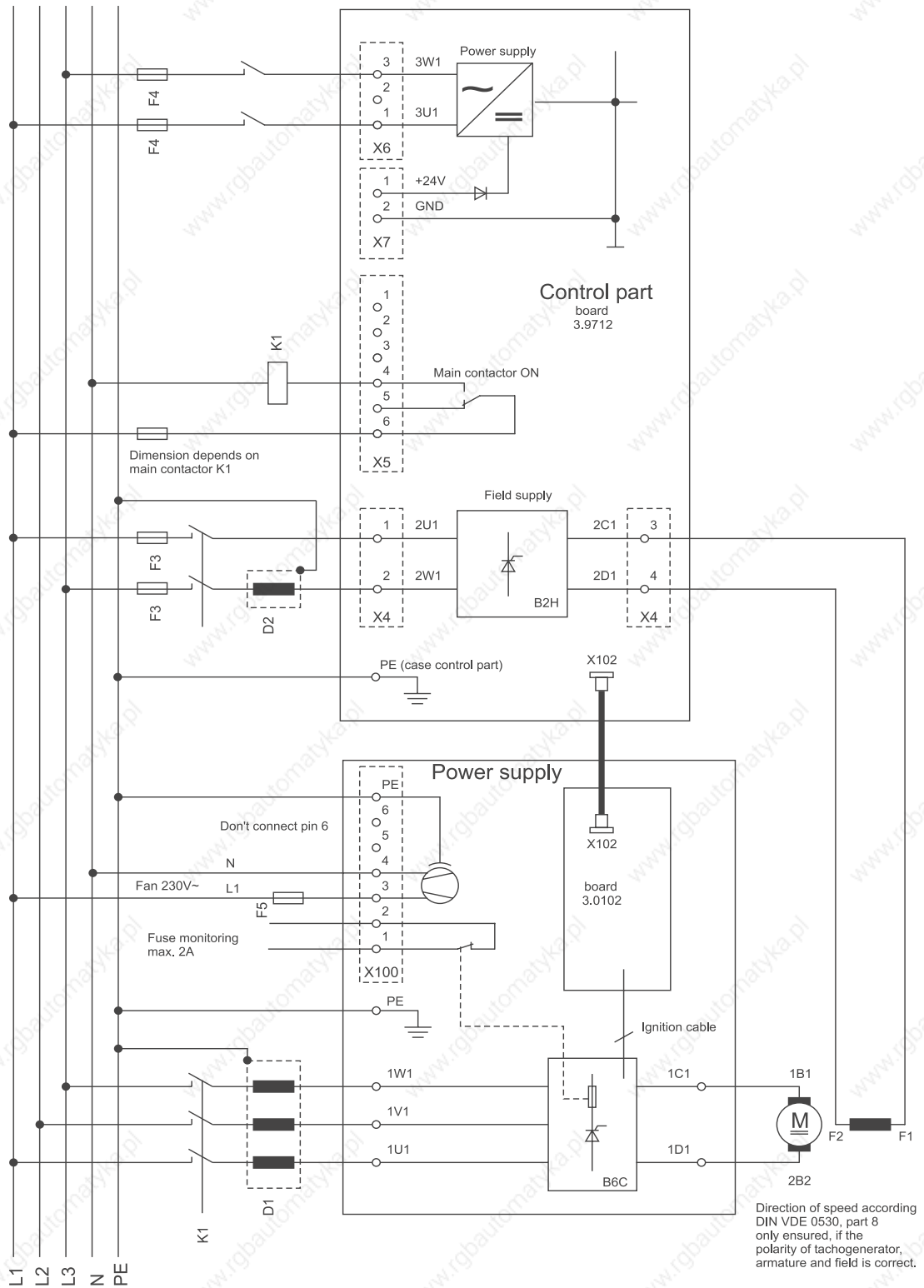

Illustration 18: Connection BKD 6 / 7000, size III (750 A, 920 A, 1100 A)

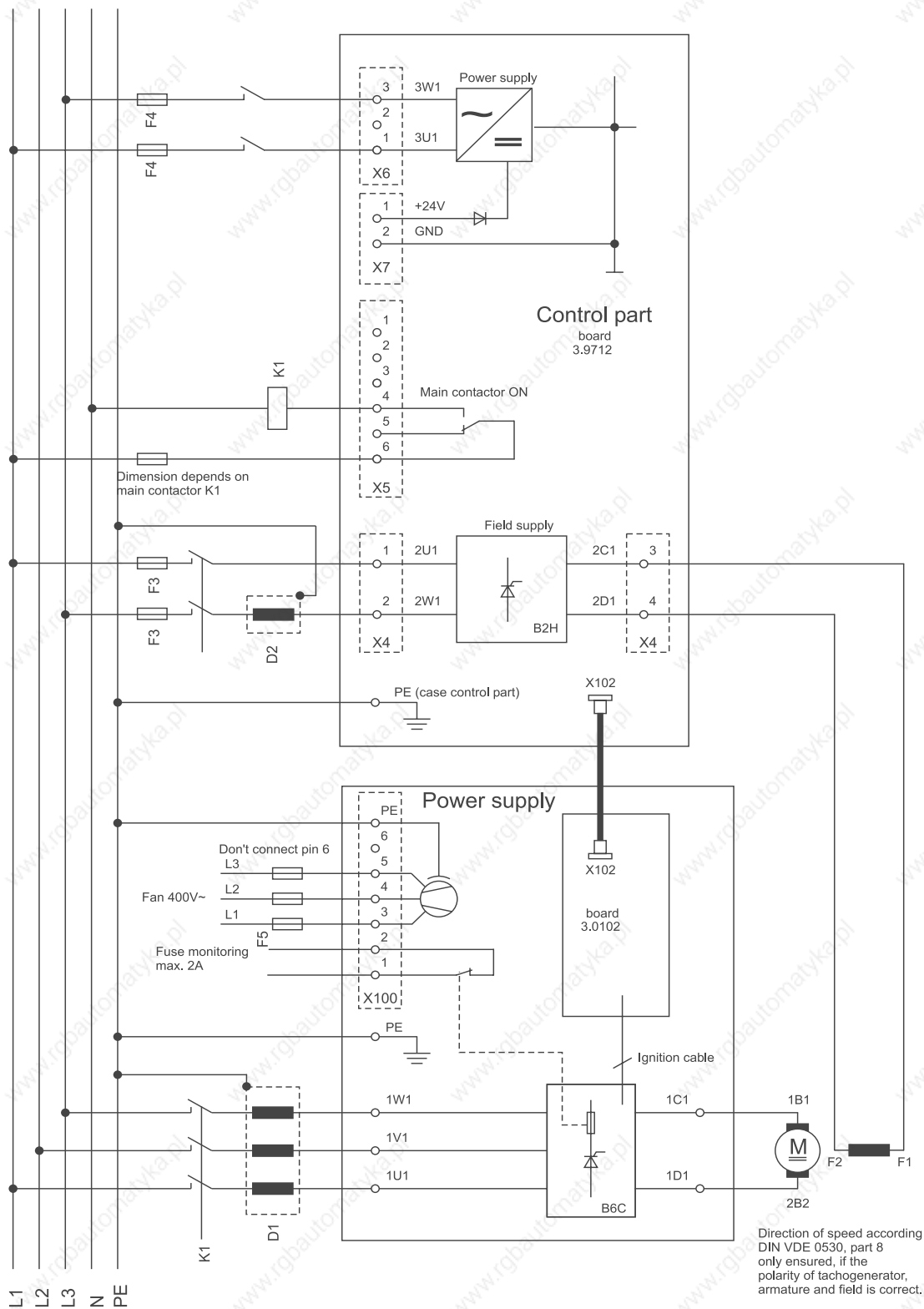

Illustration 19: Connection BKD 6 / 7000, size IV (1550 A, 1750 A, 2050 A)

3.3 Connection diagrams

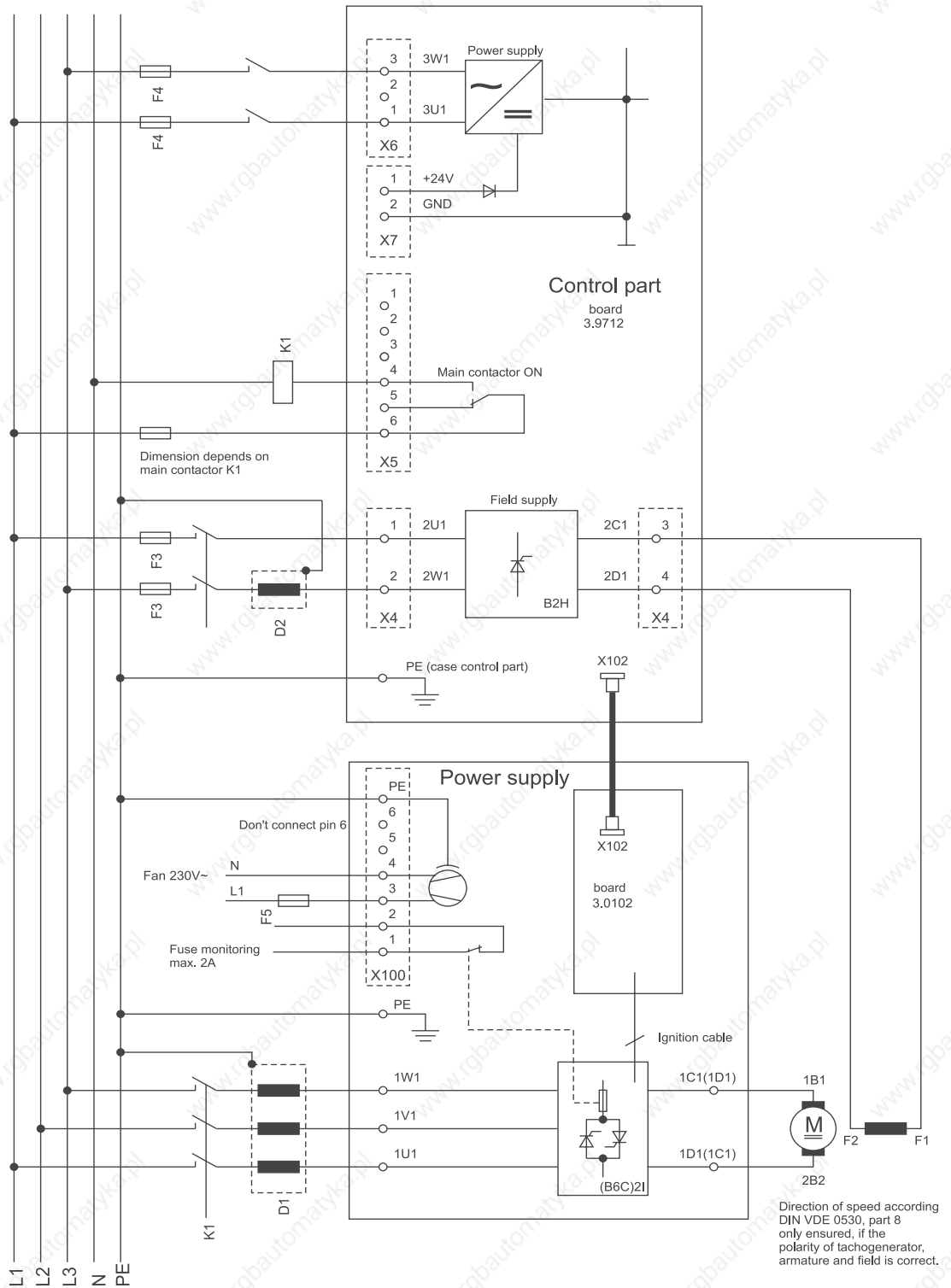

Illustration 20: Connection BKF 12/ 7000, size III (850 A)

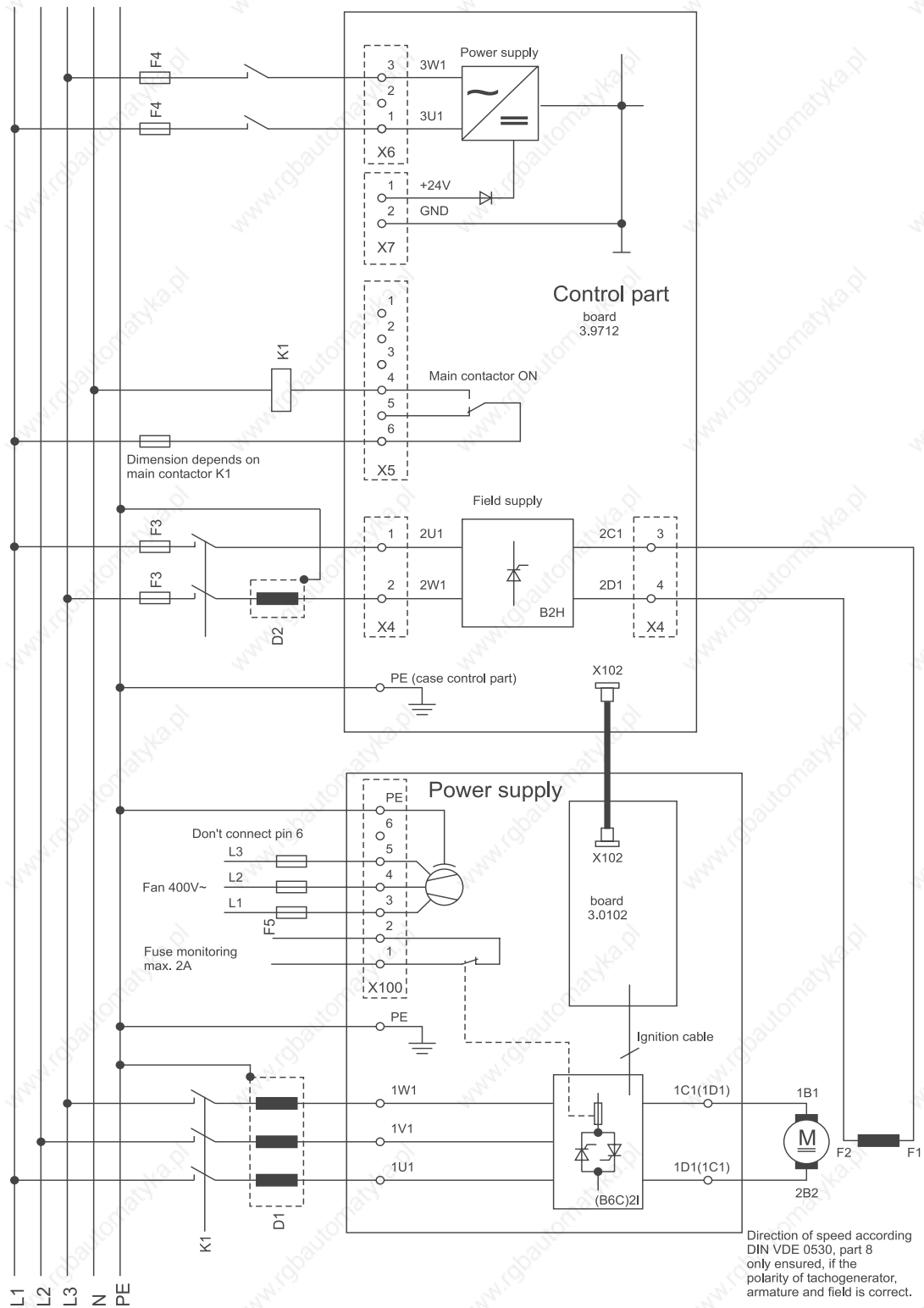





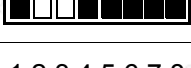
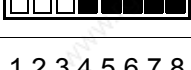



Illustration 21: Connection BKF 12 / 7000, size IV (1250 A, 1400 A, 1650 A)

3.4 Setting the power unit identification

3.4 Setting the power unit identification

3.4.1 BKD 7000 (armature power unit)

DIP switch S500	P002 (BKD/BKF)	P003 Power unit nominal current	P005 Power unit peak current	AL 227 Overload time in s	AL 221 Temperature threshold power unit in °C
1 2 3 4 5 6 7 8 ON 	1	0 A	0 A	0 s	99 °C
1 2 3 4 5 6 7 8 ON 	1	30 A	36 A	30 s	80 °C
1 2 3 4 5 6 7 8 ON 	1	50 A	60 A	30 s	95 °C
1 2 3 4 5 6 7 8 ON 	1	80 A	96 A	30 s	100 °C
1 2 3 4 5 6 7 8 ON 	1	100 A	120 A	30 s	110 °C
1 2 3 4 5 6 7 8 ON 	1	140 A	168 A	30 s	75 °C
1 2 3 4 5 6 7 8 ON 	1	200 A	240 A	30 s	80 °C
1 2 3 4 5 6 7 8 ON 	1	220 A	240 A	30 s	80 °C
1 2 3 4 5 6 7 8 ON 	1	0 A	0 A	0 s	99 °C





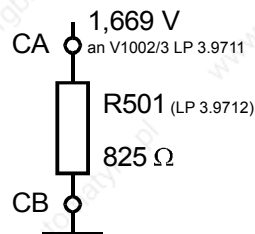

AL 221
Warning threshold for
power unit temperature in
°C
(warning W3)

Analogue identification BKD



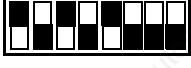





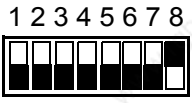

DIP switch S500	P002 (BKD/BKF)	P003 Power unit nominal current	P005 Power unit peak current	AL 227 Overload time in s	AL 221 Temperature threshold power unit in °C
1 2 3 4 5 6 7 8 ON	1	0 A	0 A	0 s	99 °C
1 2 3 4 5 6 7 8 ON	1	340 A	408 A	30 s	75 °C
1 2 3 4 5 6 7 8 ON	1	450 A	540 A	30 s	70 °C
1 2 3 4 5 6 7 8 ON	1	650 A	780 A	30 s	75 °C
1 2 3 4 5 6 7 8 ON	1	550 A	660 A	30 s	75 °C
1 2 3 4 5 6 7 8 ON	1	700 A	840 A	30 s	75 °C
1 2 3 4 5 6 7 8 ON	1	750 A	750 A	0 s	85 °C
1 2 3 4 5 6 7 8 ON	1	800 A	960 A	30 s	85 °C
1 2 3 4 5 6 7 8 ON	1	920 A	920 A	0 s	85 °C
1 2 3 4 5 6 7 8 ON	1	1100 A	1100 A	0 s	85 °C

3.4 Setting the power unit identification

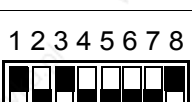
DIP switch S500	P002 (BKD/BKF)	P003 Power unit nominal current	P005 Power unit peak current	AL 227 Overload time in s	AL 221 Temperature threshold power unit in °C
1 2 3 4 5 6 7 8 ON 	1	950 A	1140 A	30 s	90 °C
1 2 3 4 5 6 7 8 ON 	1	0 A	0 A	0 s	99 °C
1 2 3 4 5 6 7 8 ON 	1	1550 A	1550 A	0 s	85 °C
1 2 3 4 5 6 7 8 ON 	1	0 A	0 A	0 s	99 °C
1 2 3 4 5 6 7 8 ON 	1	1750 A	1750 A	0 s	85 °C
1 2 3 4 5 6 7 8 ON 	1	2050 A	2050 A	0 s	85 °C

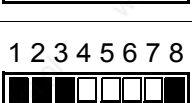
3.4.2 BKF 7000 (armature power unit)

DIP switch S500	P002 (BKD/BKF)	P003 Power unit nominal current	P005 Power unit peak current	AL 227 Overload time in s	AL 221 Temperature threshold power unit in °C
ON 	4	0 A	0 A	0 s	99 °C
ON 	4	30 A	36 A	30 s	80 °C
ON 	4	50 A	60 A	30 s	95 °C
ON 	4	80 A	96 A	30 s	100 °C
ON 	4	100 A	120 A	30 s	110 °C
ON 	4	140 A	168 A	30 s	70 °C
ON 	4	200 A	240 A	30 s	75 °C
ON 	4	0 A	0 A	0 s	99 °C
ON 	4	0 A	0 A	0 s	99 °C
ON 	4	240 A	288 A	30 s	70 °C

AL 221
Warning threshold for power unit temperature in °C (warning W3)

Analog identification BKF

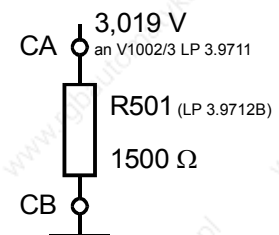







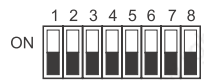

3.4 Setting the power unit identification

DIP switch S500	P002 (BKD/BKF)	P003 Power unit nominal current	P005 Power unit peak current	AL 227 Overload time in s	AL 221 Temperature threshold power unit in °C
1 2 3 4 5 6 7 8 ON	4	340 A	408 A	30 s	80 °C
1 2 3 4 5 6 7 8 ON	4	450 A	540 A	30 s	65 °C
1 2 3 4 5 6 7 8 ON	4	650 A	780 A	30 s	70 °C
1 2 3 4 5 6 7 8 ON	4	550 A	660 A	30 s	70 °C
1 2 3 4 5 6 7 8 ON	4	700 A	840 A	30 s	75 °C
1 2 3 4 5 6 7 8 ON	4	0 A	0 A	0 s	99 °C
1 2 3 4 5 6 7 8 ON	4	850 A	850 A	0 s	85 °C
1 2 3 4 5 6 7 8 ON	4	0 A	0 A	0 s	99 °C
1 2 3 4 5 6 7 8 ON	4	0 A	0 A	0 s	99 °C
1 2 3 4 5 6 7 8 ON	2	1250 A	1250 A	0 s	85 °C

DIP switch S500	P002 (BKD/BKF)	P003 Power unit nominal current	P005 Power unit peak current	AL 227 Overload time in s	AL 221 Temperature threshold power unit in °C
1 2 3 4 5 6 7 8 ON	4	1400 A	1400 A	0 s	85 °C
1 2 3 4 5 6 7 8 ON	4	0 A	0 A	0 s	99 °C
1 2 3 4 5 6 7 8 ON	4	1650 A	1650 A	0 s	85 °C
1 2 3 4 5 6 7 8 ON	4	0 A	0 A	0 s	99 °C
1 2 3 4 5 6 7 8 ON	4	0 A	0 A	0 s	99 °C

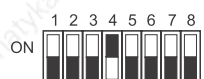
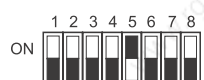
3.4 Setting the power unit identification

3.4.3 Field power unit

S 550	P 006	U _{identification} (at V1001/3 LP 3.9711)	I _{identification} (R550 - R557 LP 3.9712B)
	0.00 A		
	1.50 A	0.557 V	2.033 mA
	3.00 A	1.111 V	2.028 mA
	6.00 A	1.663 V	2.023 mA
	12.00 A	2.213 V	2.019 mA
	24.00 A	2.760 V	2.015 mA
	0.00 A	3.305 V	2.010 mA
	0.00 A	3.847 V	2.006 mA
	0.00 A	4.387 V	2.001 mA

CAUTION: the low-significant switch has priority

 = 3.00 A

I _{Field} [A]	W301	W350
1.50	B-C	A1-D1
3.00	-	A1-D1
6.00	-	A1-C1
12.00	-	A1-B1
24.00	B-A	A1-B1

Illustration 22: Field power unit BKx 7000 (board 3.9712)

3.5 Semiconductor protection fuses



NOTE

Safe protection of the power unit is no longer ensured if fuses other than those specified in the list are used !

Super-fast-action semiconductor protection fuses must be switched into the three-phase current supply line for thyristor protection.

For sizes I and II, the mains-end semiconductor protection fuses (phase fuses) must be arranged outside the converter in the switching cabinet.

For BKF converters, the armature circuit fuses must also be taken into consideration.

Converter sizes III and IV have branch fuses already included in the converter.

3.5.1 Converter size I

Connection voltage 3 x 400 V

Make: SIEMENS

Converter type BKD or BKF	Phase current (eff)	Rated direct current	Phase fuse	Rated current/ rated voltage	Article no.	Armature circuit fuse (for BKF convert- ers only)	Rated current/ rated voltage	Article no.
BK.../0030/...-7...	24.6 A	30 A	3NE8 003 3NE4 101	35 A / 660 V 32 A / 1000 V	113890 101940	3NE8 003 3NE4 101	35 A / 660 V 32 A / 1000 V	113890 101940
BK.../0050/...-7...	41.0 A	50 A	3NE8 017 3NE4 117	50 A / 660 V 50 A / 1000 V	101953 101941	3NE8 018 3NE4 118	63 A / 660 V 63 A / 1000 V	101958 101942
BK.../0080/...-7...	65.6 A	80 A	3NE8 020 3NE4 120	80 A / 660 V 80 A / 1000 V	110403 101943	3NE8 021 3NE4 121	100 A / 660 V 100 A / 1000 V	101957 110396
BK.../0100/...-7...	82.0 A	100 A	3NE8 021 3NE4 121	100 A / 660 V 100 A / 1000 V	101957 110396	3NE8 022 3NE4 122	125 A / 660 V 125 A / 1000 V	101959 101944
BK.../0140/...-7...	114.8 A	140 A	3NE8 022 3NE4 122	125 A / 660 V 125 A / 1000 V	101959 101944	3NE8 024 3NE4 124	160 A / 660 V 160 A / 1000 V	302927 101950
BK.../0200/...-7...	164.0 A	200 A	3NE4 327-0B	250 A / 800 V	205065	3NE4 327-0B	250 A / 800 V	205065

Connection voltage 3 x 500 V

Make: SIEMENS

Converter type BKD or BKF	Phase current (eff)	Rated direct current	Phase fuse	Rated current/ rated voltage	Article no.	Armature circuit fuse (for BKF convert- ers only)	Rated current/ rated voltage	Article no.
BK.../0030/...-7...	24.6 A	30 A	3NE4 101	32 A / 1000 V	101940	3NE4 101	32 A / 1000 V	101940
BK.../0050/...-7...	41.0 A	50 A	3NE4 117	50 A / 1000 V	101941	3NE4 118	63 A / 1000 V	101942
BK.../0080/...-7...	65.6 A	80 A	3NE4 120	80 A / 1000 V	101943	3NE4 121	100 A / 1000 V	110396
BK.../0100/...-7...	82.0 A	100 A	3NE4 121	100 A / 1000 V	110396	3NE4 122	125 A / 1000 V	101944
BK.../0140/...-7...	114.8 A	140 A	3NE4 122	125 A / 1000 V	101944	3NE4 124	160 A / 1000 V	101950
BK.../0200/...-7...	164.0 A	200 A	3NE4 327-0B	250 A / 800 V	205065	3NE4 327-0B	250 A / 800 V	205065

3.5 Semiconductor protection fuses

3.5.2 Converter size II

Connection voltage: 3 x 400 V / 3 x 500 V
Make: SIEMENS

Converter type BKD or BKF	Phase current (eff)	Rated direct current	Phase fuse	Rated current/ rated voltage	Article no.	Armature cir- cuit fuse (for BKF convert- ers only)	Rated current/ rated voltage	Article no.
BK.../0240/...-7...	196.8 A	240 A	3NE4 327-0B	250 A / 800 V	205065	3NE4 327-0B	250 A / 800 V	205065
BK.../0340/...-7...	278.8 A	340 A	3NE3 230-0B	315 A / 1000 V	205187	3NE3 232-0B	400 A / 1000 V	207004
BK.../0450/...-7...	369.0 A	450 A	3NE3 332-0B	400 A / 1000 V	207004	3NE3 334-0B	500 A / 1000 V	204481
BK.../0550/...-7...	451.0 A	550 A	3NE3 334-0B	500 A / 1000 V	204481	3NE3 336	630 A / 1000 V	204483
BK.../0650/...-7...	533.0 A	650 A	3NE3 335	560 A / 1000 V	204482	3NE3 337-8	710 A / 900 V	----
BK.../0700/...-7...	574,0 A	700 A	3NE3 336	630 A / 1000 V	----	3NE3 338-8	800 A / 800 V	----
BKD6/0800/470- 600-7...	656,0 A	800 A	3NE3 337-8	710 A / 900 V	----	----	----	----
BKD6/0950/470- 600-7...	779,0 A	950 A	3NE3 338-8	800 A / 800 V	----	----	----	----

3.5.3 Converter size III

With size III phase fuses are used, included in the power unit of the converter.

Connection voltage: 3 x 400 V / 3 x 500 V
Make: Ferraz

Converter type BKD or BKF	Phase current (eff)	Rated direct current	Phase fuse	Rated current/ rated voltage	Article no.
BKD6/0750/...-7...	433 A	750 A	6,6 URD 32 TTF 0500	500 A/ 690 V	-
BKD6/0920/...-7...	531 A	920 A	6,6 URD 32 TTF 0630	630 A/ 690 V	-
BKD6/1100/...-7...	635 A	1100 A	6,6 URD 32 TTF 0700	700 A/ 690 V	-
BKF12/0850/...-7...	491 A	850 A	6,6 URD 32 TTF 0630	630 A/ 690 V	-

3.5.4 Converter size IV

With size IV phase fuses are used, included in the power unit of the converter.

Connection voltage: 3 x 400 V / 3 x 500 V
Fabrikat: Ferraz

Converter type BKD or BKF	Phase current (eff)	Rated direct current	Phase fuse	Rated current/ rated voltage	Article no.
BKD6/1550/...-7...	895 A	1550 A	6,6 URD 33 TTF 1000	1000 A/ 690 V	-
BKD6/1750/...-7...	1010 A	1750 A	6,6 URD 33 TTF 1250	1250 A/ 660 V	-
BKD6/2050/...-7...	1184 A	2050 A	6,6 URD 32 TTF 0700 2 parallel	700 A/ 690 V	-
BKF12/1250/...-7...	722 A	1250 A	6,6 URD 33 TTF1000	1000 A/ 690 V	-
BKF12/1400/...-7...	808 A	1400 A	6,6 URD 33 TTF 1000	1000 A/ 690 V	-
BKF12/1650/...-7...	953 A	1650 A	6,6 URD 33 TTF 1000	1100 A/ 690 V	-

3.5.5 Fuse sizes

Make: SIEMENS

3NE8..	Size	00,	DIN 43620
3NE4 1..	Size	0,	DIN 43620
3NE4 3..-0B	Size	2,	Gauge 110 mm
3NE3 2..	Size	1,	Gauge 110 mm
3NE3 3..	Size	2,	Gauge 110 mm

3.5.6 Semiconductor fuse, field supply

Connection voltage: 2 x 400 V / 2 x 500 V

5 SD 420 16 A / 500 V size E27 (up to 12 A_{DC})

5 SD 430 20 A / 500 V size E27

5 SD 440 25 A / 500 V size E27 (24 A_{DC})

3.6 Mains chokes

3.6 Mains chokes

A mains choke is required between converter and mains (VDE 0160) to protect the thyristors from impermissible rates of current rise and to reduce converter disturbances of the supplying mains.

3.6.1 Three-phase current mains chokes

$U_N = 400 \text{ V} / 500 \text{ V} 50/60 \text{ Hz}$, $U_K = 4 \% / 4.8 \%$ with flat termination, IP00

Choke BK3-	Rated direct current A_{DC}	Mains current A_{eff}	a mm	b mm	c mm	d mm	e mm	f x g mm	Flat termination \varnothing mm x mm	Weight kg	Losses W	T_A °C	Article no.
0025/0030	30	25	155	130	132	130	72	8 x 12	20 x 2 / M6	6,0	65	45	368377
0040/0050	50	40	190	120	158	170	58	8 x 12	20 x 2 / M6	7,0	80	45	368378
0065/0080	80	65	190	140	158	170	78	8 x 12	20 x 2 / M6	10,0	97	45	368379
0080/0100	100	80	230	165	202	180	98	8 x 12	25 x 3 / M8	12,0	135	45	369380
0115/0140	140	115	230	190	202	180	122	8 x 12	25 x 3 / M10	18,0	160	40	368381
0165/0200	200	165	240	195	211	190	125	11 x 15	25 x 3 / M10	23,0	190	40	368382
0275/0340	340	275	300	225	271	240	145	5,8 x 11	30 x 5 / M10	38,0	300	40	368384
0365/0450	450	365	360	220	320	310	125	11 x 15	40 x 5 / M10	47,0	370	40	368385
0450/0550	550	450	360	260	320	310	140	11 x 15	50 x 5 / M12	58,0	460	40	368386
0530/0650	650	530	360	260	320	310	140	11 x 15	50 x 5 / M12	63,0	550	40	368387
0615/0750	750	615	420	285	375	370	151	11 x 15	60 x 5 / M12	68,0	630	40	368388
0750/0920	920	750	420	285	375	370	151	11 x 15	60 x 5 / M12	78,0	650	40	368389
0900/1100	1100	900	420	285	380	370	166	11 x 15	60 x 10 / M12	90,0	750	40	368390
1020/1250	1250	1020	on request										
1150/1400	1400	1150	on request										
1270/1550	1550	1270	on request										
1350/1650	1650	1350	on request										
1430/1750	1750	1430	on request										
1680/2050	2050	1680	on request										

Dimension drawings

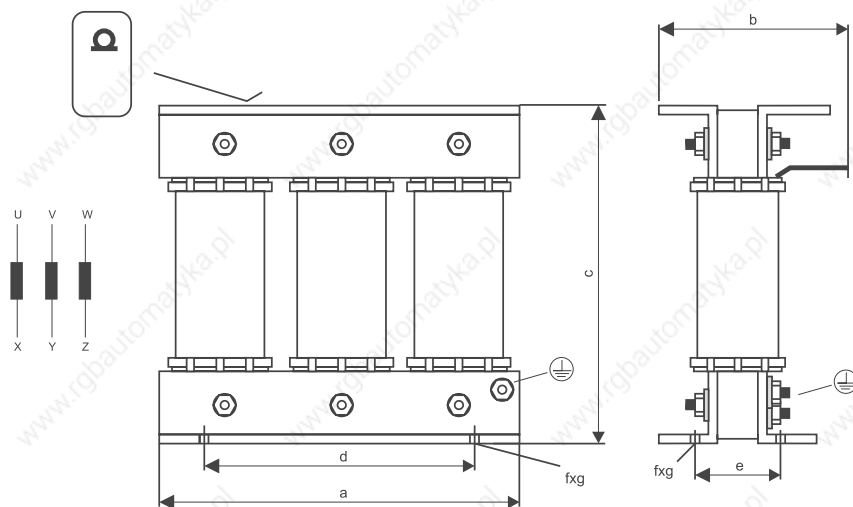



Illustration 23: Dimension drawing: Three-phase current mains chokes

3.6.2 Single-phase mains choke 

$U_N = 230\text{ V} -10\% \dots 500\text{ V} +10\%$ 50/60 Hz, $U_K = 4/4,8\%$, IP00, one choke

Choke BK1-	Rated direct current A	a mm	b mm	c mm	d mm	e mm	f x g mm	Weight kg	Loss W	T _A °C	Article no.
03/03-001	3	60	49	85	44	38	3,6 x 7	0,70	12	45	368391
06/06-001	6	66	62	90	50	49	4,9 X 9	1,0	15	45	368392
12/12-001	12	85	85	98	64	63	4,8 X 9	2,0	28	45	368393
24/24-001	24	96	88	112	84	72	5,8 X 11	2,8	32	40	368394

Dimension drawing

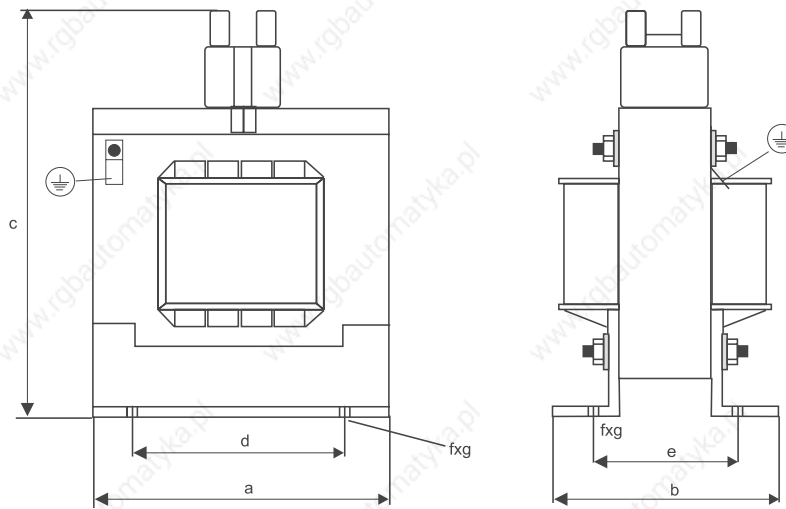

Illustration 24: Dimension drawing: Single-phase mains choke

3.7 Additional accessories

- PC interface cable 3 m article-no. 213846
- PC interface cable 5 m article-no. 213283
- other lengths on demand

3.7 Additional accessories

4

COMMISSIONING

4.1 Seven-segment display, keypad and LEDs

The seven-segment display consists of 5 positions for parameter values, errors, warnings and switching states at the digital switching inputs, for example.

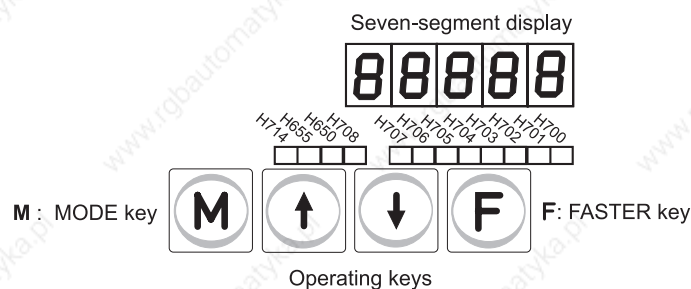

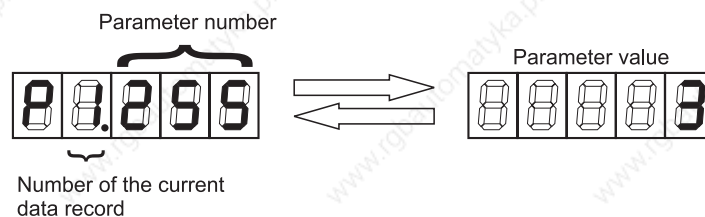

Illustration 25: Seven-segment display

Switch on the display by pressing the MODE key  below the display for about one second. This switches the display into alternating mode, displaying alternately the parameter number and the parameter value provided there are no errors and warnings.



P 1.255 means that the value of parameter P 255 is displayed in the **current** data record. The current data record is data record 1. After a changeover to data record 3, for example, the parameter number is displayed as P 3.255.

You can display the values in a specific data record that is not the current data record. Select this data record with parameter P 127. In this mode, $P\ 127 \neq 0$, the display is **fixed** to the selected data record. Even after a data record change, the display will still show the data record selected with P 127. In the display this state ($P\ 127 \neq 0$) is represented as follows: The data record number is displayed **in front of** the P.

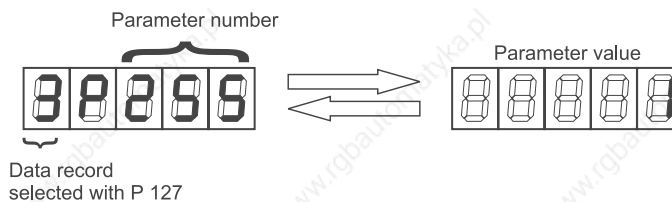

4.1 Seven-segment display, keypad and LEDs

Where values from a selected data record are displayed, the data record number is shown in front of the parameter number: **3P 255**.







It is only after P 127 has been reset to '0' that the display follows the current data record.

Use **one** of the two arrow keys to move to the next higher or lower parameter number. Keep the key pressed until you have reached the required parameter number. Pressing the  key simultaneously, speeds up selection of a new parameter number.

Pressing the  key once fixes the display to the parameter value. The display shows, and continuously refreshes, the current parameter value. Press the  key again to return to the alternating display mode (parameter number / parameter value).

4.1.1 Changing parameter values via the keypad

Switch on the display first (press  key), and then enable the keypad for parameter value modification. For this purpose, enter the value '17' in parameter P 32:

- ▶ Select parameter P 032 with one of the arrow keys.
- ▶ Press the MODE key  to fix the display to the parameter value.
- ▶ Use the arrow key  to set the value '17'.
- ▶ Press the MODE key  to transfer the value.
- ▶ The display alternates between parameter number and parameter value.







You may now modify parameters, following the same procedure you applied to enable the keypad.



CAUTION

It is strongly recommended to fix the data record to be edited by using parameter P 127 prior to commencing any modifications. This action prevents a data record change from leading to unintentional modification of the selected parameter in a different data record. Modifications may be performed in any data record that has already been programmed.

The display must be in alternating mode (alternating between parameter number and parameter value).

- ▶ Use one of the arrow keys  or  to display the required parameter number.
Tip: Simultaneous operation of the  key speeds up parameter selection.
- ▶ Press the MODE key  once the parameter has been selected. The display merely shows the associated parameter value.
- ▶ Use one of the arrow keys  or  to set the value in the display.
Tip: Simultaneous operation of the  key speeds up value setting.
- ▶ Press the MODE key to transfer the value into the associated **RAM** data record.
- ▶ The display again alternates between parameter number and parameter value.

**NOTE**

Note that a new parameter value is transferred only when pressing the MODE key and not as early as during arrow key adjustment. The value is then transferred into the RAM data record (not to the EEPROM data record). If the modified parameter belongs to the primary data group, it is automatically stored also in the EEPROM. If the parameter belongs to a data record, it can only be transferred into the EEPROM by subsequently storing the data record.

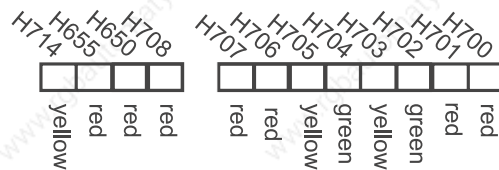
4.1.2 LEDs

- H700: Warning or error present
- H701: Disable controller
- H702: Enable controller
- H703: $n > n_{\min}$ (parameters P 505 and P 506);
illuminated if the speed has fallen below the value (P 505) - (P 506).
- H704: illuminated if torque direction 1 is activated
- H705: illuminated if torque direction 2 is activated
- H706: Current limit reached - speed controller output at the limit and armature current above 93 % of the current limit (ALink 68)
- H707: Control limit (α_G - P 360 or α_W - P 361 reached)
- H708: RESET
- H650: External watchdog tripped (error no. 30)
- H655: Shortcircuit or overload at a digital output (X2: 5 to X2: 10, error no. 43)
- H714: flashing on EEPROM access (from board 3.9711D and software release 03.10)

4.2 Data records

The EEPROM for data storage is divided into two sections. One stores up to 6 data records, the other contains primary data that are exempt from modification through a data record change; they exist only once. These data include the definitions (allocation) of input functions (DEF) for the programmable switching inputs (X2: 19 to X2: 26), for example.

The EPROM contains a non-variable data record 7 with preset values. There is no memory area for this in the EEPROM. The EPROM also contains preset values for the primary data.

As soon as the electronics supply is switched on, the data records programmed into the EEPROM are copied into the relevant RAM area. The primary data are also copied into the relevant RAM areas. Where not all six data records in the EEPROM are assigned, the values of data record 7 are taken from the EPROM into the associated RAM areas. These data records are neither visible nor accessible and become available only through programming.



NOTE

Since the 7000-series converters are supplied without programmed data records, the error messages '58' and '6' appear in parameter P 037 when the electronics supply is applied, and the ready relay remains dropped.

Error number 58: EEPROM empty

Error number 6: Invalid boot source entry

As no data have yet been stored in the EEPROM, the values of the EPROM data record (= data record 7) are transferred into the six existing RAM data records. The RAM also holds a copy of the EPROM data record which the user can merely use as an 'editor' for initial data record generation. In this case it is active for entry of the parameter values required for machine functioning. The settings of this data record can be written into data records 1 to 6 (see parameter P 153). In this process, the data are copied into the RAM area associated with the data record and permanently stored in the associated EEPROM area at the same time. Where the generated data record is to be stored in data records 1 and 3, for example, enter

P 153 = **7.1** to copy the edited RAM data record 7 into RAM data record 1 and permanently store it in EEPROM data record 1.

Then enter P 153 = **7.3** to copy the edited RAM data record 7 into RAM data record 3 and permanently store it in EEPROM data record 3.

The two data records 1 and 3 now contain the same values for the parameters. Now change the value of a parameter in data record 3. For this purpose, select data record 3 with P 127 = 3, change the required parameter and store the data of the edited RAM data record 3 in the EEPROM data record 3 with **P 153 = 3.3**.

Parameter P 45 shows the programmed data records in the top row of the seven-segment display, and in the bottom row the current (active) data record:

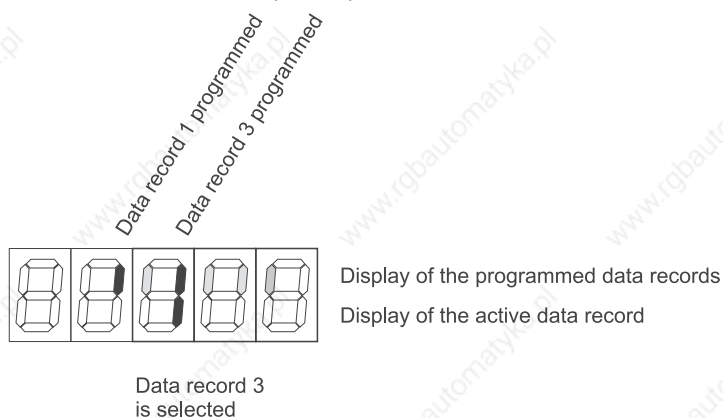

Once the required data records have been programmed, enter the number of an already programmed data record in parameter P 151 (Boot source).

Errors '58' and '6' can now be acknowledged by switching the electronics supply off and on again. The active data record then is the one whose number was entered in parameter P 151 (Boot source).

Data record 7 is no longer accessible directly if more than one data record was programmed. The following three approaches are possible:

Case 1:

Select an already programmed data record with parameter P 127 as the basis for the generation of further data records. Modify as necessary, and store the modified data record with parameter P 153.

Example:

Data record 3 is edited, and the data are to be stored in data record 4. Enter P 153 = 3.4 in parameter P 153.



NOTE

Since this case requires changing the values of an existing data record, the RAM now contains invalid values for the set. Once the new data record has been programmed, make sure in every case to switch the electronics supply off and on again to restore the original state.

Case 2:

Copy an already programmed data record to the data record to be created as a basis for the generation of further data records.

Modify as necessary, and store the modified data record on to itself with parameter P 153. Now all data records are valid since no 'non'-RAM data record was modified in this case.

Example:

Data record 3 is copied into data record 4 with P 153 = 3.4. Then use parameter P 127 = 4 to select data record 4 for editing, and modify as necessary. Store the modified data record 4 with P 153 = 4.4.



NOTE

Although this process has already generated a valid data record, the set is not suitable for machine operation !

Case 3:

Although data record 7 is no longer accessible for editing, it can be copied at any time into any data record x with parameter P 153 = 7.x and thus be stored in the associated EEPROM area at the same time.

Once the new data record has been modified, store it on to itself. Now all data records are valid since no 'non'-RAM data record was modified in this case.



NOTE

Although this process has already generated a valid data record, the set is not suitable for machine operation !

Make sure therefore to adapt the data in the newly generated data record to the individual requirements !

Example:

Use P 153 = 7.5 to transfer and store the preset values from the EPROM into data record 5. Then use P 127 = 5 to select data record 5 for the necessary settings. Use P 153 = 5.5 to store the final values in data record 5.

If the setting of a primary-data parameter (that is not contained in a data record) is changed, the new value is stored immediately in the EEPROM upon input.

Undoing modifications

The data records stored in the EEPROM are copied into the associated RAM areas after the electronics supply has been switched on. Where data were changed in the RAM area and not yet stored, the modification can be undone either through switching the electronics supply on and off or by overwriting the RAM data record with the values of the **associated** EEPROM data record. Source and target data record are **identical** in this case ! Proceed as follows to overwrite RAM data record 2 (for example) with its EEPROM values:

- P 157 = 0 (reset data record manager)
- P 158 = 2 (data record number)
- P 157 = 6 (Read data record from EEPROM)

It is also possible to erase a data record in the **EEPROM**. Note that the currently selected data record can not be erased. Any attempt to do so will result in warning 4. The boot data record entered in parameter P 151 cannot be erased either. Warning 9 is displayed in this case. Where the current boot data record is to be erased, enter the number of a different programmed data record in P 151. The original boot data record can then be erased. This requires the following inputs:

- P 157 = 0 (Reset data record manager)
- P 158 = DRno (Data record number)
- P 157 = 7 (Erase data record from EEPROM)

4.3 Basic settings

Input via converter keypad: Set P 032 to 17 (refer [▶Changing parameter values via the keypad](#) on page 56), the keypad is enabled for input.

Input via PC: Start WINBASS, set parameter P 125 to 1 (refer WINBASS description).

P 003 Rated current of power unit

P 006 Rated current of field power unit

P 070 Electronics supply (mains voltage) in V_{eff}
Preset value: 400 V_{eff}

P 071 Power unit supply (mains voltage) in V_{eff}
Preset value: 400 V_{eff}

P 072 Maximum converter current in A_{DC}
Preset value: 50 % of the value displayed in parameter P 003.

P 073 Motor armature voltage in V_{DC}
Preset value: 400 V_{DC} for BKF, 470 V_{DC} for BKD.

Setting parameters P 074 and P 078 is relevant only if i^2t monitoring is required for the motor.

P 074 Rated motor current in A_{DC}
Preset value: 50 % of the value displayed in parameter P 072.

P 078 Thermal time constant of the motor in minutes
Preset value: 0 min.

UL 508C: If you install an UL-conform machine, you must activate the i^2t monitoring of the motor by setting the parameter P 074 and P 078. The unit calculates the warming of the motor in percent and generates when reaching 100 % a warning (DLink 19), which must result in a deactivation of the drive.

P 079 Rated field current in A_{DC}
Preset value: 100 % of the value displayed in parameter P 006.

Setting P 080 is relevant only if the drive is field-weakened.

P 080 Minimum field current of the motor (in field weakening mode - P 255 = 5/6) in percent of the entered rated field current (P 079)
Preset value: 100 %

4.3 Basic settings

P 081 Field weakening range (required exclusively for actual speed monitoring / tachogenerator connection)

Preset value: 1.0 (no field weakening).

P 107 Stop mode

0: Coast drive.

1: Decelerate along the set deceleration ramp (P 109) and coast at $n < n_{\min}$ (P 505 / P 506)

Preset value: 0

P 108 Disable mode

0: Coast drive.

1: Decelerate along the set deceleration ramp (P 109) and coast with main contactor OFF at $n < n_{\min}$ (P 505 / P 506)

Preset value: 0

P 109 Ramp-down time, disable/stop

Preset value: 0.00 s (decelerate at current limit if P 107 and / or P 108 set to '1').

P 110 Ramp-down time, quick stop

Drive starts to coast once the speed has fallen below the value set with parameters P 505 and P 506.

Preset value: 0.00 s (decelerate at current limit)

P 111 General signal limit

The input and output signals of various function groups are limited to this value. Refer to sequential function charts for the areas where this limit is effective.

Preset value: 100.00 %.

P 255 Selection of actual value and field unit setting

Dependent on this are the settings of parameters P 256 to P 258 and/or P 261 to P 263.

Preset value: 1 (Armature voltage and constant field)

P 501 Threshold, overspeed monitoring

Preset value: 115.00 %

P 082 Optimisation (motor)

Once the converter has been set, store the values, and optimise at P 082 = 1. Store the data record again after optimisation.

**NOTE**

One of the error messages 44, 45, 46 or 47 may be displayed during optimisation if the motor has a high armature resistance. In that case, raise the thresholds for the associated monitoring functions for optimisation, and reset as required after optimisation and **before** storing the data.

4.3 Basic settings

5

OPERATION

5.1 Software-Update

Before updating the software with an incompatible software, read out and print the data records via a PC and erase the EEPROM. For additional information, see ([▶Error description◀](#) from page 428, error description F5)

5.2 Converter control

Depending on the configuration, converter control may be via hardware enables at terminal strip X2 and using control commands via a communication interface (field bus system, for example).

Only the hardware enables are effective if the converter is controlled without control commands while control via a communication interface requires a control command in addition to the hardware enables.

Parameter P 121 Communication source is used to set whether the converter is controlled exclusively via hardware enables or via a control command from a communication interface.

5.2.1 Hardware enable signals

There are 4 switching inputs available for converter control at terminal strip X2 of the terminal print (X2: 15...18).

These terminals enable and disable the controller and defined drive stop and deactivation.

- | | | | |
|--------------------------|---|--------------------------------|--------|
| ▶ Main contactor ON (MC) | / | Main contactor OFF | X2: 15 |
| ▶ Controller enable (CE) | / | Controller disable | X2: 16 |
| ▶ Deactivate quick stop | / | Quick stop (\overline{QS}) | X2: 17 |
| ▶ Pulse enable (PU) | / | Pulse inhibit | X2: 18 |

5.2 Converter control

Signal level: ON +24 V (+13 V...+30 V)

OFF 0 V (0 V...+7.5 V)

Input resistance: $R_i = 4 \text{ k}\Omega$

The controller enables can be displayed at the converter display with parameter P 042 (see also description P042).

For control without communication interface, the converter is enabled if X2: 16,17,18 are connected to +24 V and in addition, at X2: 15 a switching operation 0 V ► +24 V is performed. Input X2: 15 is edge-triggered.

The converter is disabled as soon as one connection is supplied 0 V or is open.

The diagram below shows the basic converter control along with the effects of the enable signals.

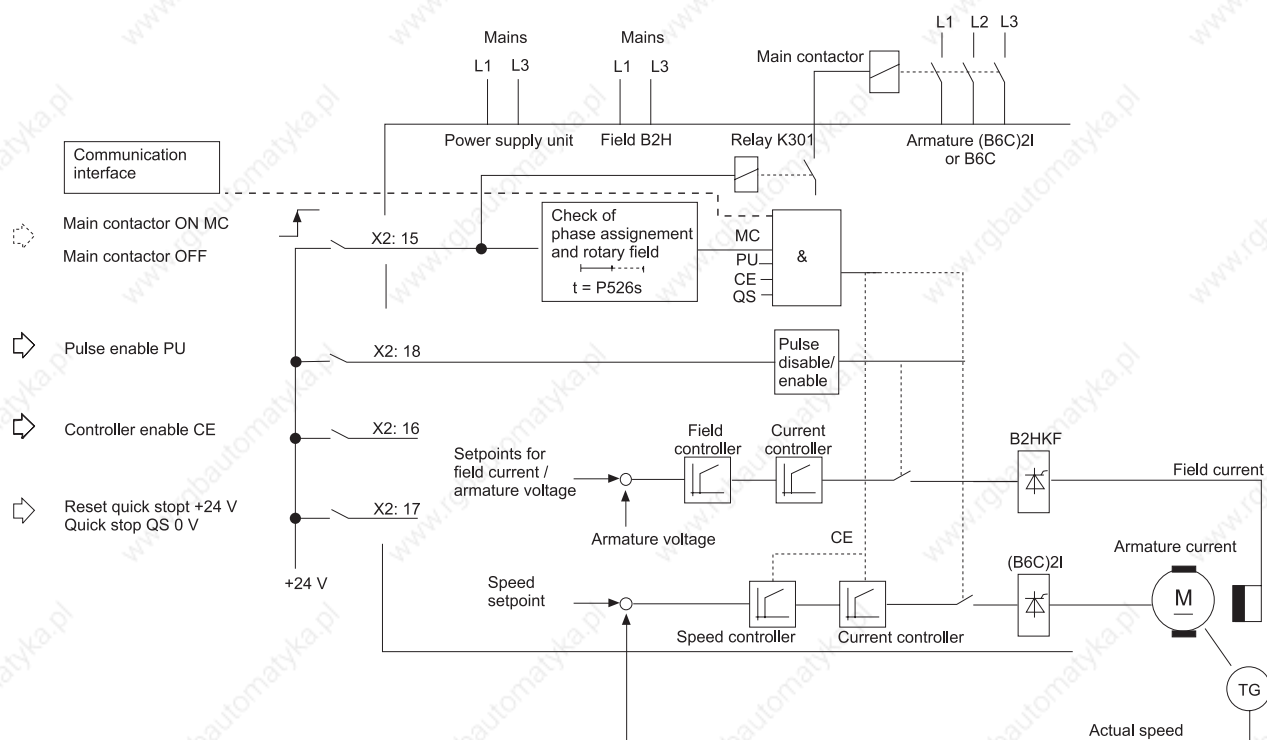

Illustration 26: Basic converter control; effects of enable signals

5.2.2 Converter control without field bus connection

In this operating mode, control is exclusively via the hardware enable signals, i. e., without control commands from a communication interface, and requires the following setting in parameter P 121 Communication source (see also description P 121):

P 121 = 0000_{hex} Standard setting, operation without communication interface.

P 121 = 0010_{hex} Operation with communication interface, converter control is exclusively via the hardware enables; only setpoint input and parameter accesses are via the field bus connection.

The individual hardware enables and their respective effects on converter control are described as follows.

5.2.2.1 Main contactor ON

Switching input: X2: 15

Enable: Edge triggering 0 V \Rightarrow +24 V

Disable: 0 V or open contact

Function

Enable: Relay K301 on power unit board 3.9712 picks up and connects the power unit to the mains via the main contactor, provided there are no error conditions.

To enable the converter, enter the operating command 'Deactivate quick stop' (QS) before 'Main contactor ON' (MC).

Once the command 'Main contactor ON' (MC) has been entered, the phase assignment of power unit connection, field connection and power supply unit (electronics supply) is checked. Phase failure and rotating field monitoring are also active.

One measuring cycle for data acquisition takes about 100 ms.

Due to various different pickup times of the contactors used for converter mains supply (switching capacity etc.), the measuring cycles are repeated several times until an error message is generated.

Parameter P 526 can be used to set the maximum measuring time during which the error messages are suppressed.

Any error messages reporting connection errors will be generated only after the set time has elapsed.



NOTE

If the contact 'Main contactor ON' is switched last to enable the drive, it **may** take max. the time set with P 526 until the drive is enabled and the motor starts rotating !

The input 'Main contactor ON' (MC) is edge-triggered and thus connection to +24 V cannot be fixed. This input **always** requires a switching operation to be performed to enable the converter.

Disable: The functionality is provided by parameter P 107:

P 107 = 0

Undecelerated Off: The drive starts to coast, and once the armature current has reached zero, the power unit is isolated from the mains via main contactor relay K301 and the external mains contactor.

The enable commands 'Quick stop' at terminal X2: 17 and 'Controller disable' at terminal X2: 16 have no further effect on the converter once the 'Main contactor OFF' command has been entered.

The function 'Main contactor OFF' can be interrupted: On re-enable, the previous speed is approached along the ramp of the ramp generator as long as that is switched on.

P 107 = 1

Decelerates the drive along the deceleration ramp for 'Main contactor OFF' and 'Controller disable' (P 109). Once the speed falls below the threshold set with P 505 and P 506, the drive starts to coast, and the main contactor relay K301 and the external mains contactor isolate the power unit from the mains.

The enable command 'Quick stop' at terminal X2: 17 affects the function of the deceleration process in this case: If the command 'Quick stop' is activated as well during the deceleration process, the system switches from the deceleration ramp for 'Main contactor OFF' and 'Controller disable' (P 109) to the deceleration ramp for 'Quick stop' (P 110).

The enable command 'Controller disable' at X2: 16 has no influence on the drive in this case.

The function 'Main contactor OFF' can be interrupted: On re-enable, the previous speed is approached along the ramp of the ramp generator as long as that is switched on.



NOTE

After the 'Main contactor ON' contact has opened, it must be closed at the earliest after the time set with P 518 plus 150 ms to ensure the controller is enabled. The converter remains disabled if the safety period is not observed !

This period must be observed also for an armature circuit changeover where 2 motors are serviced alternately by one converter.

Non-observance leads to the error message 'Tacho failure'.

5.2.2.2 Controller enable

Switching input: X2: 16

Enable: +24 V

Disable: 0 V or open contact

Function

Enable: Instantaneous enable of firing pulses and controller if the other enables are present.

Disable: The function is entered by parameter P 108:

P 108 = 0

Undecelerated Off: The drive starts to coast, the main contactor remains picked-up.

The enable commands 'Quick stop' at terminal X2: 17 and 'Main contactor OFF' at terminal X2: 15 have no further effect on the converter once the 'Controller disable' command has been entered.

The function 'Controller disable' can be interrupted: On re-enable, the previous speed is approached along the ramp of the ramp generator as long as that is switched on.

P 108 = 1

Decelerates the drive along the deceleration ramp for 'Main contactor OFF' and 'Controller disable' (P 109). The drive starts to coast once the speed falls below the threshold set with P 505 and P 506. The main contactor remains picked-up.

The enable commands 'Quick stop' at terminal X2: 17 and 'Main contactor OFF' at terminal X2: 15 affect the deceleration process function in this case:

If one of the two commands is entered additionally during deceleration, the drive switches to the respective function immediately:

On 'Quick stop': Switches to deceleration ramp for 'Quick stop', decelerates to speed = 0, drive coasts, main contactor relay K301 drops, thus isolating the power unit from the mains.

On 'Main contactor OFF': Function is dependent on parameter P 107:

P 107 = 0: Drive starts to coast immediately, followed by main contactor relay K301 dropping, thus isolating the power unit from the mains.

P 107 = 1: Deceleration along the deceleration ramp for 'Main contactor OFF' and 'Controller disable' continues, the drive starts to coast at zero speed. Then the main contactor relay K301 drops, thus isolating the power unit from the mains.

The function 'Controller disable' can be interrupted: On re-enable, the previous speed is approached along the ramp of the ramp generator as long as that is switched on.

5.2.2.3 Quick stop

Switching input: X2: 17

Enable: +24 V

Disable: 0V or open contact

Function

Enable: 'Deactivate quick stop'

To enable the converter, input the operating command 'Deactivate quick stop' (QS) before 'Main contactor ON' (MC).

Disable: Decelerates the drive along the deceleration ramp for 'Quick stop' (P 110). Once the speed falls below the threshold set with P 505 and P 506, the drive starts to coast, and the main contactor relay K301 and the external mains contactor isolate the power unit from the mains.

The commands 'Main contactor OFF' at terminal X2: 15 and 'Controller disable' at terminal X2: 16 have no further effect on the drive once the 'Quick stop' command has been input.

'Quick stop' can not be interrupted.

5.2.2.4 Pulse inhibit



CAUTION

Use the enable signal 'Pulse inhibit' in emergency cases only.

Switching input: X2: 18

Enable: +24 V

Disable: 0 V or open contact

Enable: Instantaneous enable of firing pulses and controller if the other enables are present.

Disable: The pulses controlling the armature and field power units are switched off after 15 ms independent of the operating state.

The pulse enable/pulse inhibit is a pure hardware function acting directly upon the power unit (pulse generation). Pulse inhibit may therefore lead to fuses blowing. In extreme cases (shoot-through), the thyristors may be damaged! Therefore, use this function as a higher-level switch-off mechanism only !

5.2.2.5 State machine for converter control for operation without field bus connection

The various converter states and the control sequence as a function of the hardware enables are described below on the basis of the state machine in accordance with DRIVECOM Profile-Power Transmission.

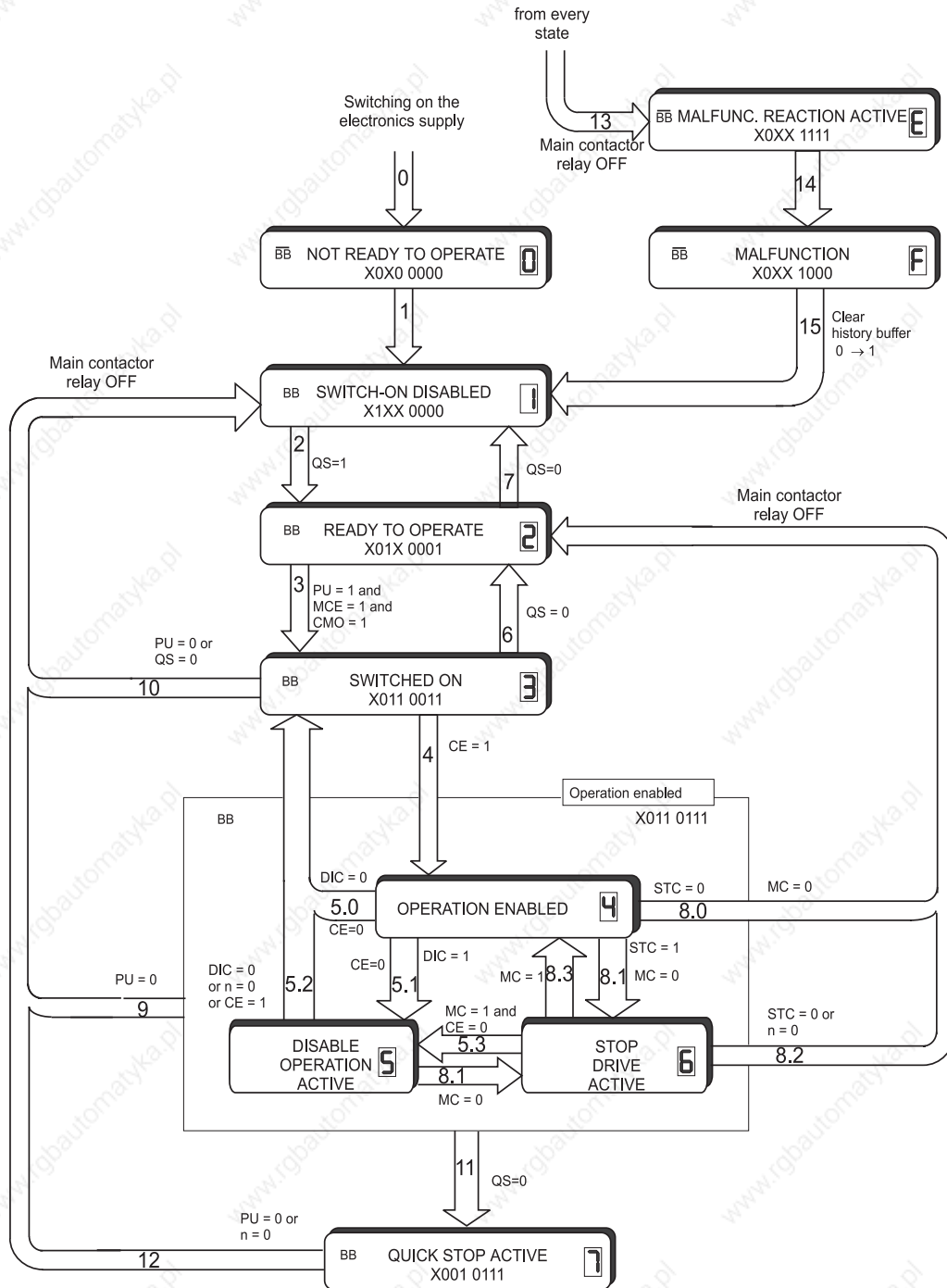

X2: 18 : PU = 1: Pulse enable to 1 level
 X2: 18 : PU = 0: Pulse enable to 0 level

X2: 17 : QS = 1: Quick stop to 1 level (inactive)
 X2: 17 : QS = 0: Quick stop to 0 level (active)

X2: 16 : CE = 1: Controller enable to 1 level
 X2: 16 : CE = 0: Controller enable to 0 level

X2: 15 : MC = 1: Main contactor enable to 1 level
 X2: 15 : MC = 0: Main contactor enable to 0 level

MCE = 1: positive main contactor edge applied
 MCE = 0: negative main contactor edge applied
 CMO = 1: Connection monitoring o.k.
 CMO = 0: Connection monitoring not o.k.

STC = 1: Stop mode (P 107) = 1 (braking at QS ramp)
 STC = 0: Stop mode (P 107) = 0 (drive coasting)

DIC = 1: Disable mode (P 108) = 1 (braking at QS ramp)
 DIC = 0: Disable mode (P 108) = 0 (drive coasting)

Illustration 27: Converter control state diagram - without field bus connection

5.2.3 Converter control via communication interface

In this operating mode, the converter is controlled via control commands from a communication interface. For this purpose, the communication interface must be selected accordingly with the help of parameter P 121 Communication source (see [Parameter description - Converter data](#) from page 181).

The various converter states and the control sequence are represented in the form of a state diagram (see [State machine of the converter control](#) on page 72) in accordance with the DRIVECOM profile Power Transmission.

Converter control via a communication interface requires the 4 hardware enables in addition to the control commands (see [Main contactor ON](#) on page 67 to [Pulse inhibit](#) on page 69).

Where the converter is to be controlled solely via control commands, the 3 hardware enables 'Controller enable' (CE) at X2: 15, 'Deactivate quick stop' (QS) at X2: 17 and 'Pulse enable' at X2: 18 (PU) may be fixed-linked to 24 V (X1: 25, 26).

One exception is the hardware enable 'Main contactor ON' at X2:15: This input is edge-triggered and can therefore not be fixed-linked to +24V.

Transition from operating state READY TO OPERATE (2) to SWITCHED ON (3) is possible only if, in addition to the control command 'Switch on', a switching operation from OFF to ON is performed at the hardware switching input 'Main contactor ON' (X12: 15).

5.2.3.1 State machine of the converter control

The various operating states of the converter define the converter behaviour (for example, operation enabled or disabled). These states as well as the conditions required to reach the respective states, are shown in [Illustration 28](#) on page 73.

The individual states are shown with the respective identification in the status word, and the conditions and control word commands that must be met to achieve transition from one state to the next, are also described.

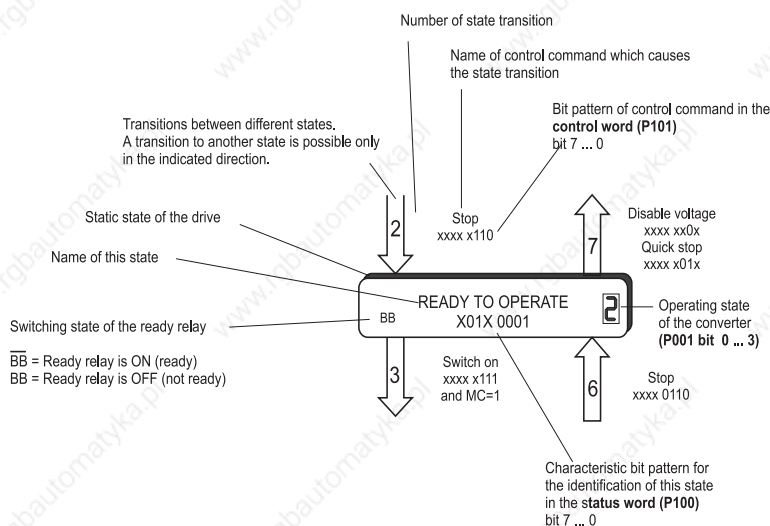

Within the states, bits 7...0 of the status word (P 100) are displayed in binary form XXXX XXXX. At the state transitions, bits 7...0 of the status word (P 101) are displayed in binary form xxxx xxxx.

Any positions identified X or x have no effect on state machine control and current state display.

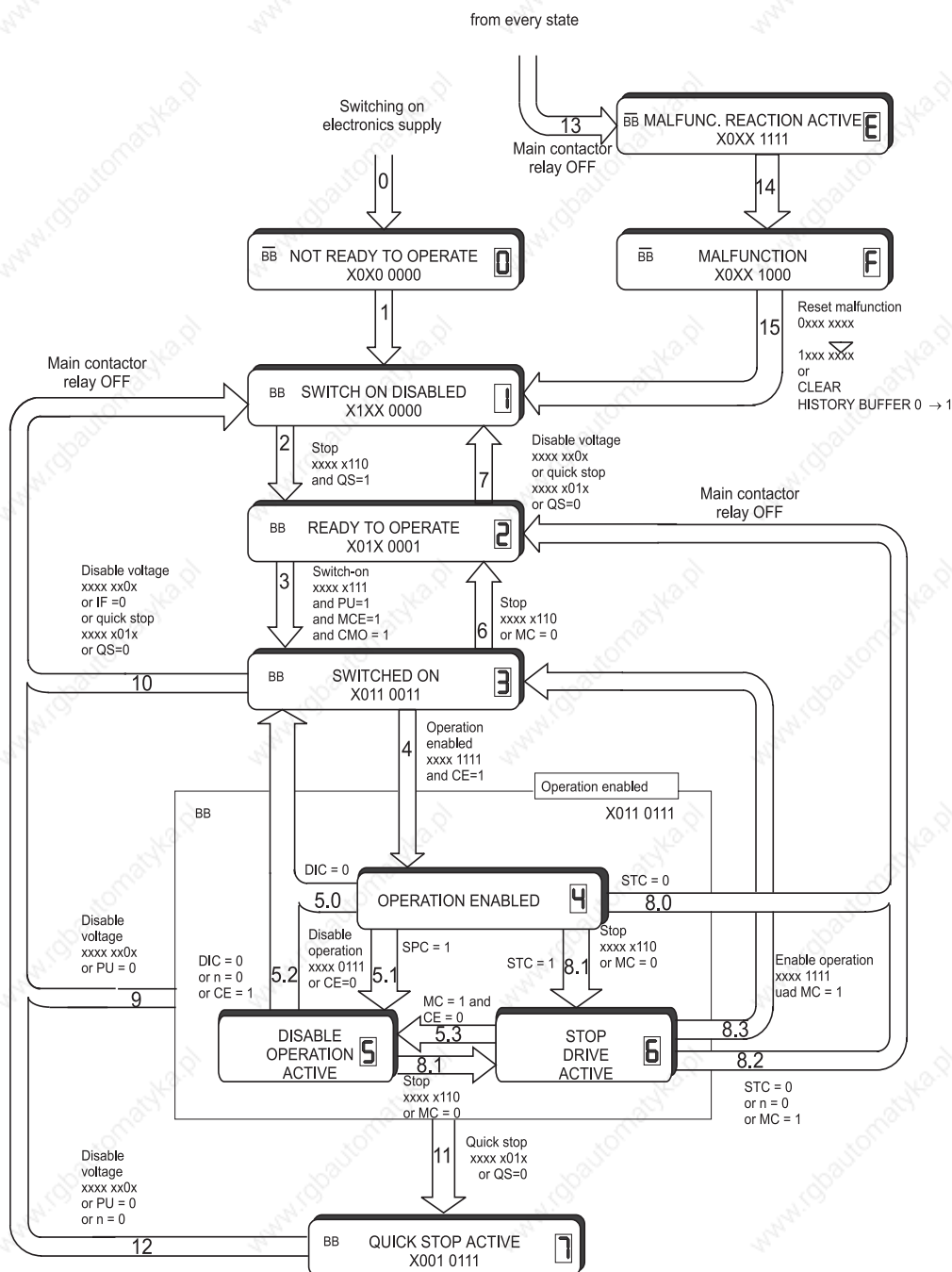

X2: 18 : PU = 1: Pulse enable to 1 level
X2: 18 : PU = 0: Pulse enable to 0 level

X2: 17 : QS = 1: Quick stop to 1 level (inactive)
X2: 17 : QS = 0: Quick stop to 0 level (active)

X2: 16 : CE = 1: Controller enable to 1 level
X2: 16 : CE = 0: Controller enable to 0 level

X2: 15 : MC = 1: Main contactor enable to 1 level
X2: 15 : MC = 0: Main contactor enable to 0 level

MCE = 1: positive main contactor edge applied
MCE = 0: negative main contactor edge applied

CMO = 1: Connection monitoring o.k.
CMO = 0: Connection monitoring not o.k.

STC = 1: Stop mode (P 107) = 1 (braking at MC ramp)
STC = 0: Stop mode (P 107) = 0 (drive coasting)

DIC = 1: Disable mode (P 108) = 1 (braking at MC ramp)
DIC = 0: Disable mode (P 108) = 0 (drive coasting)

Illustration 28: Converter control state diagram

5.2.3.2 Converter control states

- 0 **NOT READY TO OPERATE**
- ▶ Voltage is supplied to the electronics
 - ▶ Self-test running
 - ▶ Initialisation running
 - ▶ Drive function disabled
 - ▶ Ready-to-operate relay is OFF (drive not ready for operation)
- 1 **SWITCH-ON DISABLED**
- ▶ Software/hardware initialisation complete
 - ▶ Parameterisation complete
 - ▶ Application can be reparameterised
 - ▶ Drive function disabled
 - ▶ Ready-to-operate relay is ON (drive ready for operation)
- 2 **READY TO OPERATE**
- ▶ Application can be reparameterised
 - ▶ Drive function disabled
 - ▶ Ready-to-operate relay is ON (drive ready for operation)
- 3 **SWITCHED ON**
- ▶ Application can be reparameterised
 - ▶ Drive function disabled
 - ▶ Power unit ready to operate (connections checked)
 - ▶ Ready-to-operate relay is ON (drive ready for operation)
- 4 **OPERATION ENABLED**
- ▶ Application can be reparameterised (except parameters that can only be modified offline)
 - ▶ Drive function enabled
 - ▶ Ready-to-operate relay is ON (drive ready for operation)
- 5 **DISABLE OPERATION ACTIVE**
- ▶ Application can be reparameterised (except parameters that can only be modified offline)
 - ▶ Drive function enabled
 - ▶ Command 'Disable operation' is executed (parameterisable via P 108 / P 109)
 - ▶ Ready-to-operate relay is ON (drive ready for operation)
- 6 **STOP DRIVE ACTIVE**
- ▶ Application can be reparameterised (except parameters that can only be modified offline)
 - ▶ Drive function enabled
 - ▶ Command 'Stop' is executed (parameterisable via P 107 / P 109)
 - ▶ Ready-to-operate relay is ON (drive ready for operation)

7 QUICK STOP ACTIVE

- ▶ Application can be reparameterised (except parameters that can only be modified offline)
- ▶ Quick stop active (via adjustable ramp P 110)
- ▶ Drive function enabled
- ▶ Ready-to-operate relay is ON (drive ready for operation)

E MALFUNCTION REACTION ACTIVE

- ▶ Application can be reparameterised
- ▶ Error present
- ▶ Ready-to-operate relay is OFF (drive not ready for operation)

F MALFUNCTION

- ▶ Application can be reparameterised
- ▶ Drive function disabled
- ▶ Ready-to-operate relay is OFF (drive not ready for operation)

5.2.3.3 Description of control word commands

The commands passed on to the converter via the control word (P 101) are described below. As specified in the controller control state diagram, drive control also requires the associated hardware enables to be set.

Stop (required bit combination in the control word xxxx x110)

This command is required for the transition from state 'SWITCH-ON DISABLED' to state 'READY TO OPERATE' (for example, directly after the converter has been switched on, after an error was acknowledged or after a quick stop).

The command is also required to stop the drive. Stopping may be as follows:

- ▶ The drive starts to coast immediately (P 107 stop mode (Main contactor) = 0)
- ▶ The drive is decelerated along the deceleration ramp (P 107 stop mode (Main contactor)) = 1)

The stopping of the drive may be interrupted (command 'Enable operation') as long as the drive is still decelerated along the ramp.

After the stopping process, the main contactor is switched off, so that the hardware contact for main contactor ON must be operated again to re-enable the drive (edge for main contactor ON).

Disable voltage (required bit combination in the control word xxxx xx0x)

The command 'Disable voltage' always causes transition into the state 'SWITCH-ON DISABLED'. The drive function is disabled immediately, and the drive starts to coast. The main contactor is also switched off. The command thus corresponds largely to deactivating the hardware signal 'Pulse enable'.

Switch on (required bit combination in the control word xxxx 0111)

The command 'Switch on' is required to change from state 'READY TO OPERATE' to state 'SWITCHED ON'. The power unit connections are checked in the 'SWITCHED ON' state, and the drive can be enabled directly.

The command 'SWITCH ON' is included in the commands 'Enable operation' and 'Disable operation'.

Disable operation (required bit combination in the control word xxxx x111)

The command 'Disable operation' inhibits the drive function. Depending on the parameterisation, the drive is decelerated along the set deceleration ramp to standstill, or starts to coast directly.

The deceleration process initiated via the command 'Disable operation' can be interrupted. The command 'Enable operation' can be used to re-enable the controller. The deceleration process is terminated via commands 'Disable voltage', 'Stop' or 'Quick stop' and the associated reaction initiated.

'Disable operation' is possible only while the drive function is enabled and corresponds to deactivating the hardware signal 'Controller enable'.

Enable operation (required bit combination in the control word xxxx 1111)

The command 'Enable operation' enables the drive function if the controller is already in 'SWITCHED ON' state. This command corresponds to the hardware signal 'Controller enable'.

Quick stop (required bit combination in the control word xxxx x01x)

The command 'Quick stop' corresponds to deactivating the hardware signal 'Deactivate quick stop', always causes transition to the state 'SWITCH-ON DISABLED' and interrupts the deceleration processes due to the commands 'Disable operation' and/or 'Stop'.

The drive is decelerated along the set quick stop ramp and then disabled. The quick stop process can only be interrupted with the command 'Disable voltage'.

Reset malfunction (required bit combination in the control word 0xxx xxxx ▶ 1xxx xxxx)

This command acknowledges and deletes error messages. Any error messages must be acknowledged with this command before the converter may be re-enabled.

Parameter P 106 can be used to set whether this command acknowledges the errors individually or as a group. Once all errors have been acknowledged, the command 'Reset malfunction' causes a change to the 'Switch-on disabled' state.

After an unacknowledgeable error, the converter can only be reset by means of a restart. From software release S03.10, this restart can be performed automatically by means of a reset with command 'Reset malfunction'. This behaviour can also be set in parameter P 106.

5.2.3.4 Converter control in detail

For reasons of simplicity, it is assumed below that all hardware enables are present. Only the main contactor enable signal will receive special mentioning as it is edge-triggered. It is for this reason that a switching operation must be performed at this hardware contact even if control is via a field bus.

Process sequence of controller enable

Once switched on, the converter automatically assumes 'SWITCH-ON DISABLED' state (see also ► [Illustration 28](#) on page 73). The following actions must be performed one after the other to move from this state to the 'OPERATION ENABLED' state.

- ▶ Command 'Stop': Switches to 'READY TO OPERATE' state (2)
- ▶ Command 'Switch on': Required to change to 'SWITCHED ON' state (3) The hardware contact for main contactor ON must be operated in addition to the command (switching operation from OFF to ON)
- ▶ Command 'Enable operation': This command enables the controller, the converter assumes 'OPERATION ENABLED' state (4).

Since the command 'Switch on' is included in the command 'Enable operation', it is also possible to issue the command 'Enable operation' directly from the 'READY TO OPERATE' (2) state.

Process sequence of controller disable

Disabling the drive function from the 'Operation enabled' state requires the command 'Disable operation'. Depending on the parameterisation (P 108), the drive starts to coast immediately or is decelerated along the set deceleration ramp.

Deceleration along the deceleration ramp moves the drive into 'DISABLE OPERATION ACTIVE' state (5). The deceleration process can be interrupted by a re-enable (command 'Enable operation'). The deceleration process is also terminated via commands 'Stop', 'Disable voltage' and 'Quick stop'.

Process sequence of stop

Depending on the setting of parameter P 107, the command 'Stop' results in immediate drive coasting or in decelerating along the set deceleration ramp (P 109). Then the drive function is disabled and the main contactor contact isolated.

The controller assumes 'STOP DRIVE ACTIVE' state (6) if the 'Decelerate along deceleration ramp' mode has been set for stop purposes. During deceleration, the drive function can be re-enabled via the command 'Enable operation'. The deceleration process during stop can also be interrupted via the commands 'Quick stop' and 'Disable voltage'.

The command 'Stop' interrupts the command 'Disable operation' as long as the drive is in 'DISABLE OPERATION ACTIVE' state, in other words, is decelerated due to the command 'Disable operation'.

Process sequence of quick stop

If the 'Quick stop' command is entered with the controller enabled, the command 'Quick stop' initiates a deceleration process at the set quick stop ramp-down time, and the controller changes to 'QUICK STOP ACTIVE' state (7). As soon as the drive has reached standstill, the drive function is disabled, the main contactor de-energised, and the controller switches to 'SWITCH-ON DISABLED' state.

The command Quick stop also interrupts the deceleration process initiated by the commands 'Disable operation' or 'Stop'.

The quick stop function can only be terminated with the command 'Disable voltage'.

Process sequence of disable voltage

The command 'Disable voltage' causes the drive to coast immediately, regardless of the state. This command interrupts any other operating states and terminates even the quick stop function.

5.2.3.5 Converter control state transitions

This section describes the state changes ('state transitions') between the different converter control states, illustrating the conditions required for each state change and briefly describing which actions are performed in the converter during the state change.

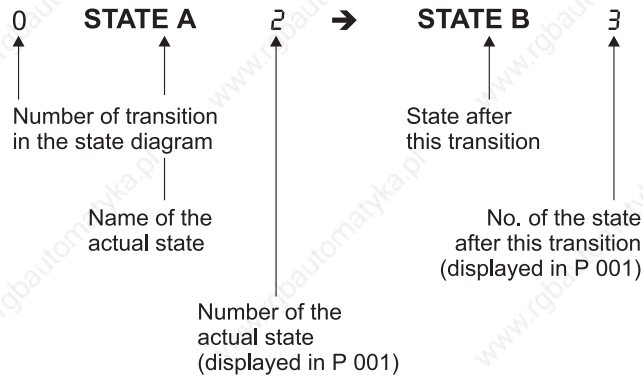

Event: Event, e.g. control command or condition
 Condition: which must be fulfilled for this condition
 Action: Actions which the converter executes with this state change

0	State machine input	→ NOT READY TO OPERATE 0
	Event:	- Hardware reset
		or
		or
	Action:	- Switch on electronics voltage
		- Ready-to-operate relay is switched off
		- Initialisation and self-test are started
1	NOT READY TO OPERATE 0	→ SWITCH-ON DISABLED 1
	Event:	- Initialisation and self-test completed without errors
	Action:	- Communication monitoring and process data monitoring are activated
		- Ready-to-operate relay is switched on
2	SWITCH-ON DISABLED 1	→ READY TO OPERATE 2
	Event:	- Command 'Stop'
	Condition:	- Quick stop input X2: 17 = HIGH
	Action:	- None

3	READY TO OPERATE Event: Condition: Action:	2 and 3	→ SWITCHED ON	3 - Command 'Switch on' - Pulse enable X2: 18 = HIGH - Positive edge at main contactor enable x2: 15 - Main contactor relay K301 is switched on - Power unit connections (armature and field) are checked - Power connections monitoring is activated
4	SWITCHED ON Event: Condition: Action:	3	→ OPERATION ENABLED	4 - Command 'Enable operation' - Controller enable X2: 16 = HIGH - Drive function is enabled
5.0	OPERATION ENABLED Event: Condition: Action:	4 or 3	→ SWITCHED ON	3 - Command 'Disable operation' - Controller enable X2: 16 = LOW - P 108 (Stop mode drive inhibit) = 0 - Drive function is disabled
5.1	OPERATION ENABLED Event: Condition: Action:	4 or 5	→ DISABLE OPERATION ACTIVE	5 - Command 'Disable operation' - Controller enable X2: 16 = LOW - P 108 (Disable mode) = 1 - Drive is decelerated along the MC/CE ramp (P 109).
5.2	DISABLE OPERATION ACTIVE Event: Condition: Action:	5 or or 3	→ SWITCHED ON	3 - Zero speed reached - P 108 (Disable mode) = 0 - Controller enable X2: 16 = HIGH - Drive function is disabled
5.3	STOP DRIVE ACTIVE Event: Condition: Action:	5 and 5	→ DISABLE OPERATION ACTIVE	5 - Command 'Disable operation' - Main contactor enable X2: 15 = HIGH - Controller enable X2: 16 = LOW - None
6	SWITCHED ON Event: Condition: Action:	3 or 2	→ READY TO OPERATE	2 - Command 'Stop' - Main contactor enable X2: 15 = LOW - Power connections monitoring is switched off - Main contactor relay K301 is switched off

5.2 Converter control

7	READY TO OPERATE	2	→ SWITCH-ON DISABLED 1
	Event:		- Command 'Quick stop'
		or	- Quick stop input X2: 17 = LOW
	Action:	or	- Command 'Disable voltage'
			- None
8.0	OPERATION ENABLED	4	→ READY TO OPERATE 2
	Event:		- Command 'Stop'
		or	- main contactor enable X2: 15 = LOW
	Condition:		- P 107 (Stop mode (main contactor)) = 0
	Action:		- Drive function is disabled
			- Power connections monitoring is switched off
			- Main contactor relay K301 is switched off
8.1	OPERATION ENABLED DISABLE OPERATION ACTIVE	4/ 5	→ STOP DRIVE ACTIVE 6
	Event:		- Command 'Stop'
		or	- main contactor enable X2: 15 = LOW
	Condition:		- P 107 (Stop mode (main contactor)) = 1
	Action:		- Drive is decelerated along the MC/CE ramp (P 109).
8.2	STOP DRIVE ACTIVE	6	→ READY TO OPERATE 2
	Event:		- Zero speed reached
		or	- P 107 (Stop mode (main contactor)) = 0
		or	- Main contactor enable X2: 15 = HIGH
	Action:		- Main contactor relay K301 is switched off
			- Power connection monitoring is switched off
8.3	STOP DRIVE ACTIVE	6	→ SWITCHED ON 3
	Event:		- Command 'Enable operation'
	Condition:		- Main contactor enable X2: 15 = HIGH
	Action:		- Drive deceleration is terminated
9	OPERATION ENABLED DISABLE OPERATION ACTIVE STOP DRIVE ACTIVE	4/ 5/ 6	→ SWITCH-ON DISABLED 1
	Event:		- Command 'Disable voltage'
		or	- Pulse enable X2: 18 = LOW
	Action:		- Drive function is disabled
			- Power connections monitoring is switched off
			- Main contactor relay (K301) is switched off

<p>10</p> <p>SWITCHED ON</p> <p>Event:</p> <p style="text-align: center;">or</p> <p>Action:</p>	<p>3</p>	<p>→ SWITCH-ON DISABLED 1</p> <ul style="list-style-type: none"> - Command 'Disable voltage' - Command 'Quick stop' - Quick stop input = LOW - Drive function is disabled - Power connections monitoring is switched off - Main contactor relay (K301) is switched off
<p>11</p> <p>OPERATION ENABLED</p> <p>DISABLE OPERATION ACTIVE</p> <p>STOP DRIVE ACTIVE</p> <p>Event:</p> <p style="text-align: center;">or</p> <p>Action:</p>	<p>4/ 5/ 6</p>	<p>→ QUICK STOP ACTIVE 7</p> <ul style="list-style-type: none"> - Command 'Quick stop' - Quick stop input X2: 17 = LOW - Quick stop function is tripped - Drive is decelerated along the quick stop ramp (P 110).
<p>12</p> <p>QUICK STOP ACTIVE</p> <p>Event:</p> <p style="text-align: center;">or</p> <p>Action:</p>	<p>7</p>	<p>→ SWITCH-ON DISABLED 1</p> <ul style="list-style-type: none"> - Command 'Disable voltage' - Quick stop completed (zero speed reached) - Pulse enable X2: 18 = LOW - Drive function is disabled - Power connections monitoring is switched off - Main contactor relay (K301) is switched off
<p>13</p> <p>All states</p> <p>Event:</p> <p>Action:</p>	<p>7</p>	<p>→ MALFUNCTION REACTION ACTIVE E</p> <ul style="list-style-type: none"> - Drive malfunction is detected - Ready-to-operate relay is switched off - Error present
<p>14</p> <p>MALFUNCTION REACTION ACTIVE</p> <p>Event:</p> <p>Action:</p>	<p>E</p>	<p>→ MALFUNCTION F</p> <ul style="list-style-type: none"> - Malfunction reaction complete - Drive function is disabled - Power connections monitoring is switched off - Main contactor relay (K301) is switched off
<p>15</p> <p>MALFUNCTION</p> <p>Event:</p> <p style="text-align: center;">or</p> <p>Condition:</p> <p>Action:</p>	<p>F</p>	<p>→ SWITCH-ON DISABLED 1</p> <ul style="list-style-type: none"> - Command 'Reset malfunction' - Digital input function 7 is executed - Malfunction no longer exists - Malfunction reset is performed - Ready-to-operate relay is switched on

The state change is effected only after the actions have been fully executed. The sequence of the actions is in accordance with their processing upon state change. After the actions have been fully processed, the next state has been reached, and new commands are accepted.

5.2.4 Switch ON and OFF sequence

Mains voltage supply to and disconnection from power supply unit (X6: 1,3), field supply (X4: 1,2) and power unit (1U1, 1V1, 1W1) must follow the subsequent guidelines, taking into account the enable criteria (see ▶[Main contactor ON](#)◀ on page 67 and ▶[Controller enable](#)◀ on page 68):

See also ▶[Connection instructions](#)◀ from page 21.

Observe in-phase condition of the three connection voltages, otherwise error messages P 37: For example, 21 (CCW rotating field at armature power unit), 19 (Field connection error (AC)), 20 (Armature power unit connection error (AC)).

5.2.4.1 Switch-on sequence

It is recommended to proceed as follows:

- ▶ Connect power supply unit and field supply to the mains simultaneously, input pulse enable at X2: 18 at this point at the latest.



NOTE

'Pulse enable' causes the hardware to enable the firing pulses for armature and field. The field current is tested directly after switch-on (power supply unit to mains), so that a delayed pulse enable therefore brings up error message 40 (Field current monitoring).

It may happen that motors with a very high field time constant produce error message 40 (Field current monitoring) despite correct procedure.

Remedy: Extend P 385 (Delay for field current monitoring).

- ▶ 'Deactivate quick stop' (QS = 1) at terminal X2: 17. For control via communication interface: Also control word P 101 ('Stop', xxxx x110)
- ▶ 'Main contactor ON' (MCE = 1) at terminal X2: 15:
Controls the mains contactor for the power unit via relay K301 on the converter power unit board 3.9712 (terminals X5: 4...6). For control via communication interface: Also control word P 101 ('Switch on, xxxx x111)
- ▶ Observe waiting period input by parameter P 526 (Maximum line stabilisation time). Standard setting: 0.5 s.
Non-observance may lead to delayed startup during subsequent 'Controller enable'.
- ▶ Finally, input 'Controller enable' (CE = 1) at terminal X2: 16 for defined and instantaneous startup. For control via communication interface: Also control word P 101 ('Enable operation', xxxx 1111)



NOTE

'Deactivate quick stop' must be provided before 'Main contactor ON' to enable the converter.

Example for drive control without field bus connection:

Starting point: The drive was stopped via 'Quick stop' (QS = 0) at terminal X2: 17, the remaining 3 enable commands 'Main contactor ON' at X2: 15, 'Controller enable' at X2: 16 and 'Pulse enable' at X2: 18 are still present.

There are two restarting options, requiring the following inputs at the converter:

- ▼ Startup is to be instantaneous:
 - ▶ 'Main contactor OFF' at terminal X2: 15, 'Controller disable' at terminal X2: 16
 - ▶ 'Deactivate quick stop' at terminal X2: 17
 - ▶ 'Main contactor ON' at terminal X2: 15
 - ▶ Observe waiting period input by parameter P 526 (Maximum line stabilisation time). Standard setting: 0.5 s, range: 0.1 s...5.0 s.
 - ▶ 'Controller enable' at X2: 16 results in instantaneous startup
- ▼ A short delay is permissible between enable command and drive start (duration: max. the time specified with P 526).
 - ▶ 'Main contactor OFF' at terminal X2: 15,
 - ▶ 'Deactivate quick stop' at terminal X2: 17
 - ▶ 'Main contactor ON' at terminal X2: 15 results in a delayed start.

The following options are also possible:

- ▼ Field supply
 - ▶ may be connected to mains prior to the power supply unit without additional measures.
 - ▶ It is possible at P 386 = 0 (Field monitoring ON/OFF) to connect the field to mains after the power supply section.
Mains connection must be effected at the latest upon input of the enable command 'Main contactor ON' as this is when the field connection is checked and field monitoring is activated.
- ▼ Mains contactor for the power unit
 - ▶ Mains connection is possible also without the assistance of relay K301 at the converter.
 - ▶ The power unit may be connected to mains before the power supply unit.

5.2.4.2 Switch-off sequence



NOTE

It is vital to observe that the power unit must only be isolated from the mains when the firing pulses are at the inverter firing angle limit and the armature current has fallen to zero.

Non-observance of this procedure may lead to fuses blowing. In extreme cases the thyristors may be damaged.

Therefore always make sure to deactivate one of the enable conditions first, except pulse enable !

The choice of how to stop the drive is up to the operator:

- ▶ Deactivate command 'Main contactor ON' (MC = 0) at terminal X2: 15
- ▶ Deactivate 'Controller enable' (CE = 0) at terminal X2: 16
- ▶ 'Quick stop' (QS = 0) at X2: 17

The following control commands may be used in the control word P 101 where control is effected via a communication interface:

- ▶ 'Stop' xxxx x110
- ▶ 'Disable operation' xxxx x111
- ▶ 'Disable voltage' xxxx xx0x

Then first isolate the power unit from the mains (unless this has already been done via one of the controller disable commands), then power unit and field converter.

Error message 40 (Field current monitoring) is generated if the field converter is switched off prior to the power supply unit.

5.3 Converter structure

5.3.1 ALink

An ALink (Analog link = analog connection signal) is a 16-bit-wide memory cell written in every controller cycle, that can be used in several places throughout the program run. The ALink can be compared to a soldering terminal in a converter with an analog structure. In general, the ALink has a range of ± 16384 , corresponding to a signal level of $\pm 100\%$. The maximum values are at ± 32767 , that is $\pm 200\%$. A signal stored in an ALink corresponds to an analog signal of conventional converters.

Examples: Setpoint
 Actual speed
 Ramp generator output
 Speed controller output etc.

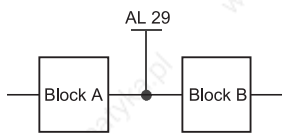

The signal from Block A is stored as an intermediate result in ALink 29 and utilised further as input of Block B. It can also be used as input signal for further function blocks, however.

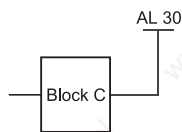

The signal from Block C is the end result and ends up in ALink 30. Further processing requires a link. See below.

5.3.1.1 Selecting an ALink

Selecting an ALink as input signal for a function block (ramp generator, speed controller etc.) is by entering the number of the required ALink in the associated selection parameter.

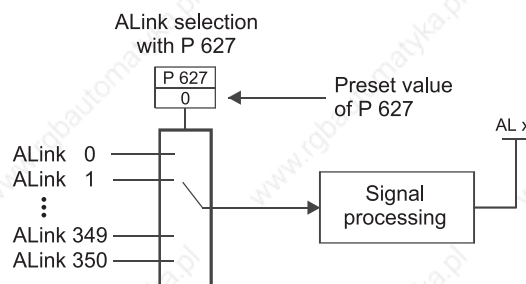
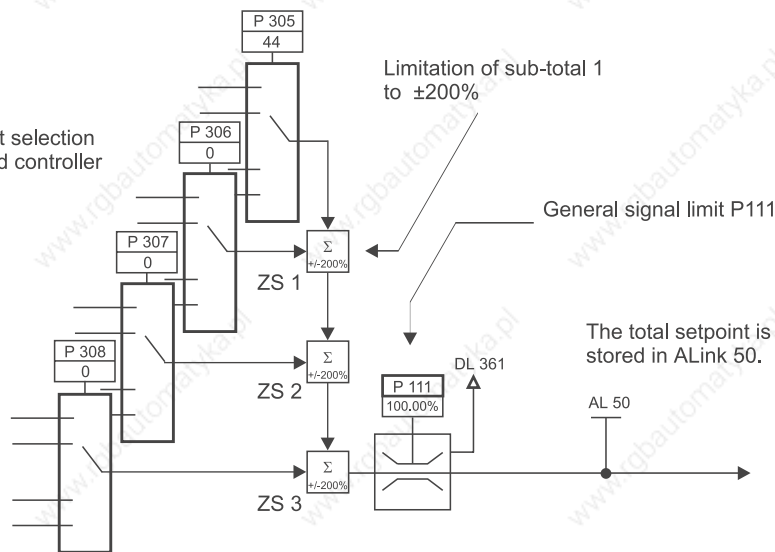

Illustration 29: Symbol for ALink selection

The selected input signals (ALinks) are always added for function blocks with several inputs (max. possible number: 4). Processing follows the sequence of rising selection parameter numbers. Each intermediate result is limited to $\pm 200\%$. In the example, the end result is limited to the value of the general signal limit parameter P 111.

5.3 Converter structure



5.3.1.2 Interconnecting ALinks

The diagram below illustrates that one ALink can be used by several function blocks.

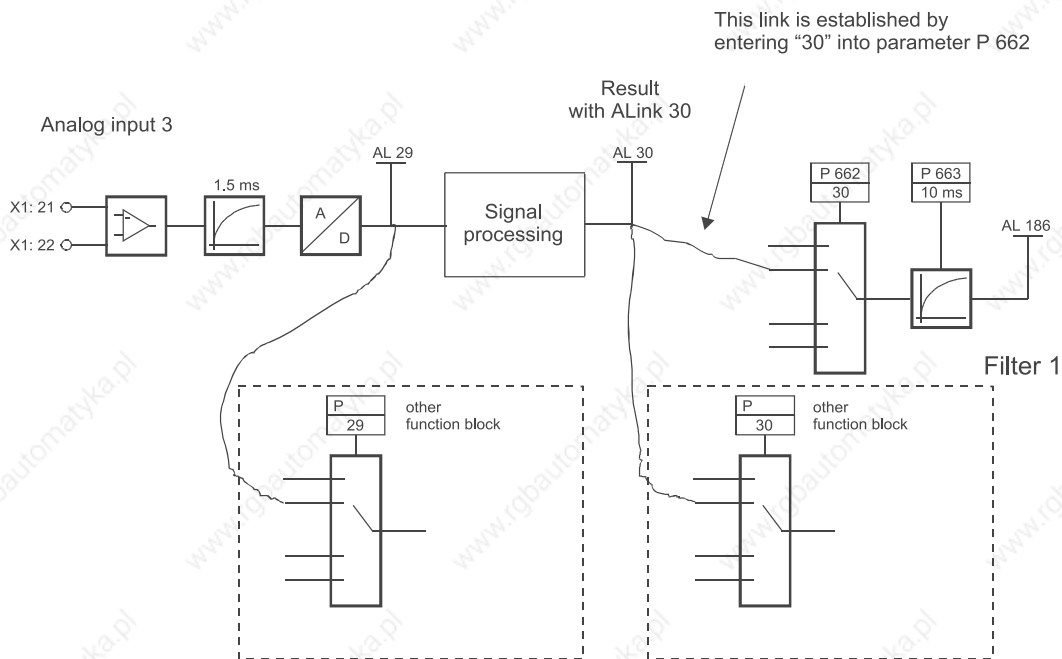

In the above example, the value converted by analog input 3 is filtered with the help of the unassigned filter 1. The processed value of analog input 3 is stored in ALink 30 and is not further connected to any other function block for the time being. Entering the value '30' in the parameter that selects the input of the unassigned filter 1 ($P\ 662 = 30$) generates a connection between analog input 3 and the filter. The filtered value of analog input 3 is now in ALink 186. Since that is not connected to any other function block, it is necessary to generate a separate connection by entering '186' in a selection parameter of another function block to enable further utilisation of this value.

5.3.1.3 Displaying an ALink value

There are four parameters to show the contents of two ALinks in the display or on the PC. Parameters P 46 and P 48 select the ALinks whose value is then displayed in parameters P 47 and P 49.

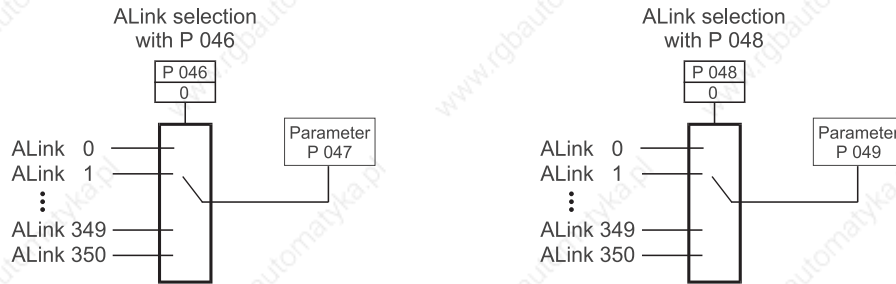

The values in parameters P 47 and P 49 are displayed as decimal figures in internal format. For signals with standard scaling (see [▶ALink list](#) from page 351) the signal range of $\pm 100\%$ is output as a figure within a range of ± 16384 .

5.3 Converter structure

5.3.2 DLink

A DLink (Digital Link = digital link signal) is a 1-bit cell set by the program. This does not have to happen in the controller cycle, but may also occur in a background program during the rest time. DLink contents can be influenced only indirectly from outside, direct write access is not possible. A DLink is modified by writing a control word or by setting/resetting a digital input, for example. The switching input states (terminals X2: 15 to X2: 26) are mapped in DLinks 452 to 463. Even the bits of the state words in the system are assigned DLinks. Bits not yet assigned of control and state words have a fixed value of LOW (= '0').

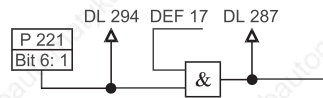

Bit states are temporarily stored in DLinks 294 and 278. They cause further internal reactions and may also be used for other connections.

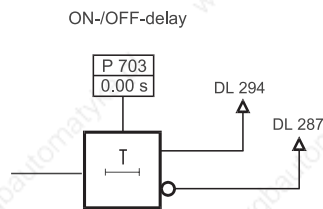

The output of the digital block is written into DLinks 592 and 593. Further processing requires a connection.

5.3.2.1 Selecting a DLink

Selecting a DLink as input signal for a function block (digital function block, digital inverter, digital outputs etc.) is by entering the number of the required DLink in the associated selection parameter.

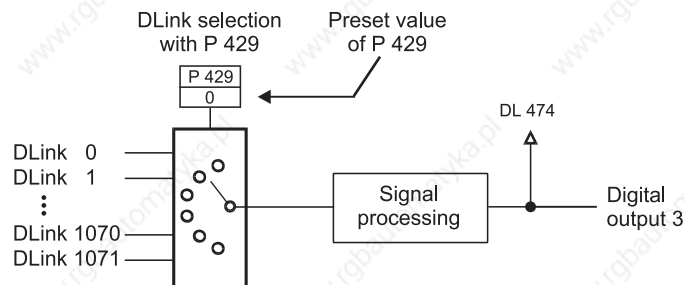
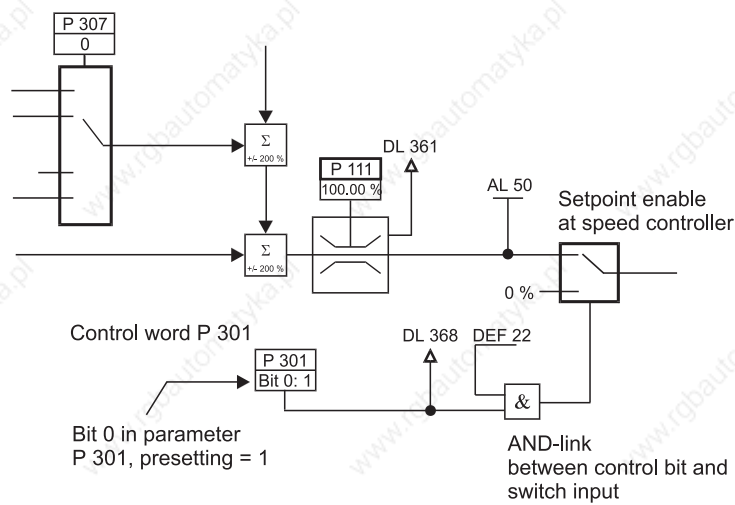

Illustration 30: Symbol for DLink selection

5.3.2.2 Influencing DLinks



Setpoint enable at the speed controller is via an external switch that has been assigned the digital input function 22 (DIF 22 - explanation further below), and via bit no. 0 of parameter P 301 (Control word (speed controller)). The control bit can now be modified via communication (field bus connection) by writing parameter P 301. The state of this control bit is mapped in DLink 368.

5.3.2.3 Displaying a DLink

There are two parameters to show the contents of a DLink in the display or on the PC. Parameter P 680 selects the DLink whose state is then shown in parameter P 681. The display is 1 bit wide and can adopt values 0 (= LOW) and 1 (= HIGH).

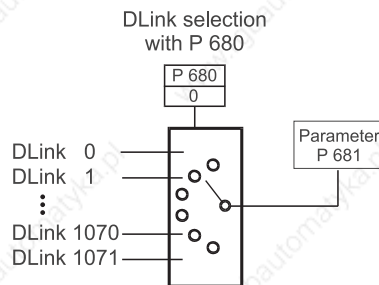

5.3 Converter structure

5.3.2.4 Digital basic functions

There are four digital inverters with one input each. The signal delay of each inverter can be parameterised. The specified time is valid for the LOW → HIGH as well as for the HIGH → LOW input signal transition.

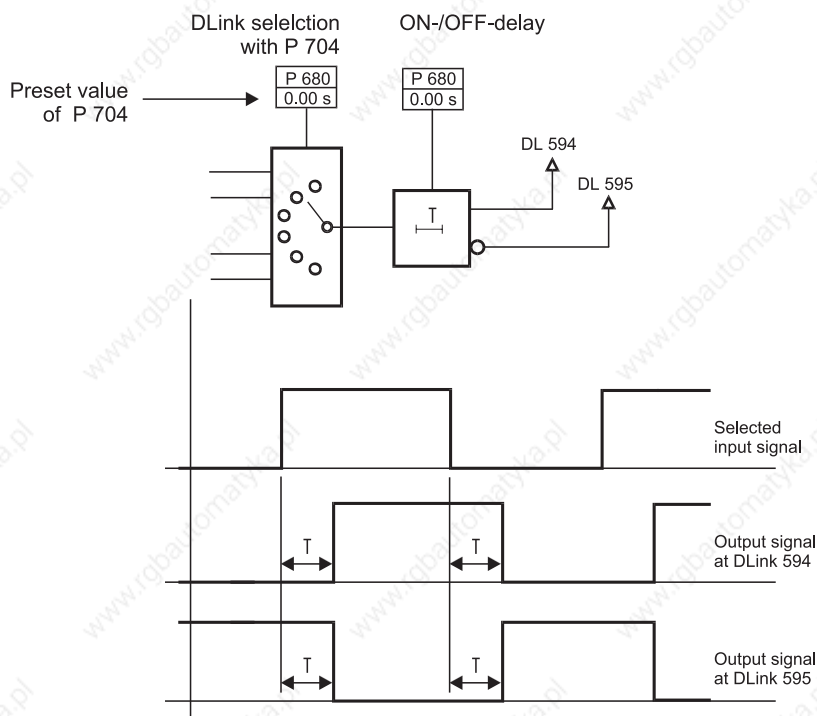

Level changes at the input shorter than the set delay time do not appear at the digital inverter outputs !

The DLinks may be linked with the four existing digital function blocks via AND, OR and Exclusive OR. The result then becomes available in two further DLinks. The first DLink contains the operation result, the subsequent one the inverted result.

Each of the four digital function blocks is configured with a parameter (P 710 in the example):

- 0: Function block not active
- 1: Function block configured as AND gate with four inputs; assign (DLink 1) to unassigned inputs
- 2: Function block configured as OR gate with four inputs; assign (DLink 0) to unassigned inputs
- 3: Function block configured as Exclusive OR gate with two inputs

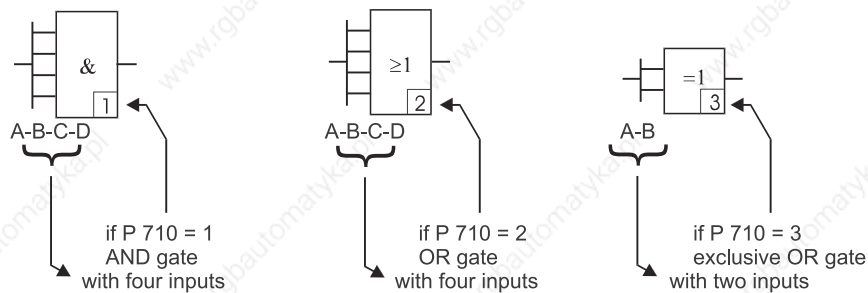
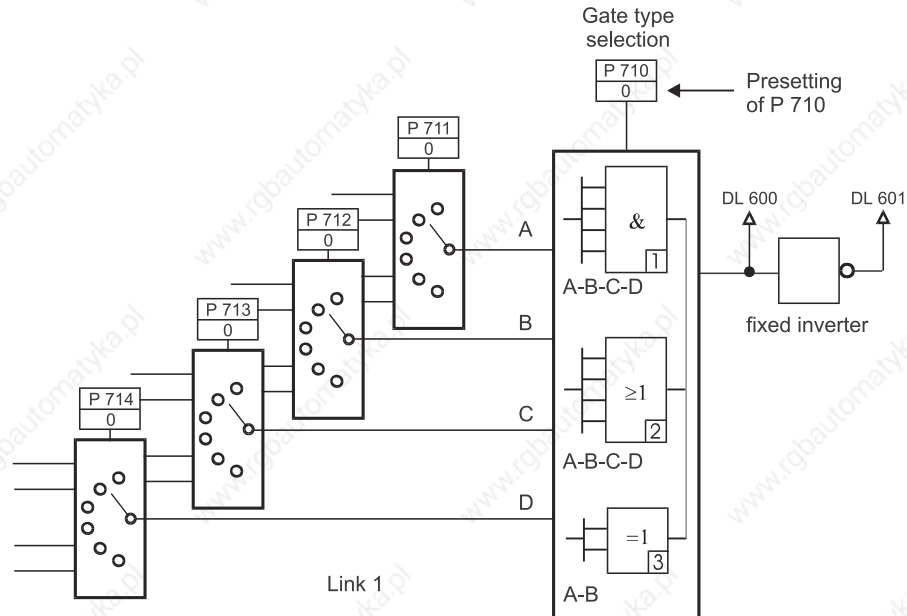

Illustration 31: Structure and parameterisation of an unassigned digital function block

5.3 Converter structure

5.3.3 Digital outputs

There are six programmable digital outputs. Each output has a free-wheeling diode. The outputs are protected against shortcircuits at the terminal. They are not isolated from the control !

Using the internal +24 V, each output can be loaded with max. 20 mA. Using external +24 V allows current loads of up to 100 mA per output.

The digital outputs have been assigned the following parameters and terminals:

Digital output	Selection parameter	ON delay	OFF delay	Polarity reversal	Terminal
1	P 421	P 422	P 423	P 424	X2: 5
2	P 425	P 426	P 427	P 428	X2: 6
3	P 429	P 430	P 431	P 432	X2: 7
4	P 433	P 434	P 435	P 436	X2: 8
5	P 437	P 438	P 439	P 440	X2: 9
6	P 441	P 442	P 443	P 444	X2: 10

The DLinks are available as output signals. DLinks may be combined with the help of the unsigned digital link elements and the result be connected to the output.

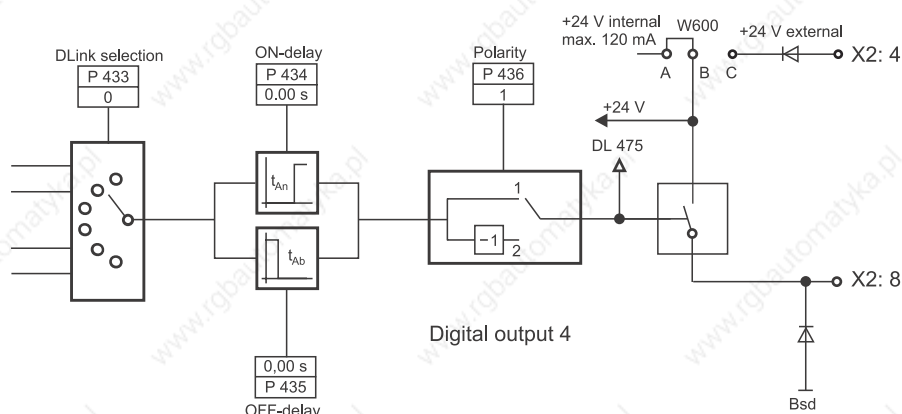

Illustration 32: Example of the basic digital output structure

The most common output functions are grouped together in DLinks 2 to 23.

DLink no.	Description	State parameter	Bit no.	Also DLink
0	Fixed value 0 (LOW)			
1	Fixed value 1 (HIGH)			
2	State 'Enabled'	P 100	0 ... 2	
3	State 'MALFUNCTION'	P 100	3	83
4	State 'WARNING'	P 100	7	87
5	Ramp generator setpoint reached	P 220	12	284
6	$n > n_{\max}$ (error 44, threshold P 501)	P 921	0	864
7	$n > n_{\min}$ (P 505 and P 506)	P 250	10	314
8	$n > n_{x1}$ (P 507 and P 508)	P 250	12	316
9	$n > n_{x2}$ (P 509 and P 510)	P 250	13	317
10	$n > n_{x3}$ (P 511 and P 512)	P 250	14	318
11	$n > n_{x4}$ (P 513 and P 514)	P 250	15	319
12	Drift lock active (P 322 to P 324)	P 300	8	360
13	$n_{\text{actual}} = n_{\text{set}}$ at the speed controller (P 515 to P 516)	P 300	12	364
14	Unassigned comparator			
15	$I_A > I_{x1}$ (P 521 and P 522)	P 350	8	392
16	$I_A > I_{x2}$ (P 523 and P 524)	P 350	9	393
17	Current limit reached	P 300	14	366
18	Speed controller output limit active	P 300	15	367
19	Motor i^2t monitoring	P 030	4	68
20	Heat sink temperature limit monitoring	P 020	6	54
21	Field current actual value < 50 % field current setpoint	P 370	8	424
22	State 'READY TO OPERATE'	P 100	0	80
23	Drive disabled	P 100	0...2	

5.3 Converter structure

5.3.4 Digital input functions DIF

There are 33 predefined functions available for the eight switch inputs at terminals X2: 19 to X2: 26. The setting of the function assigned to the input is stored outside the data records in the EEPROM. A data record change therefore cannot assign a switching input a different function. Entry of the required function is possible only while the drive is disabled; the setting will be stored immediately in the EEPROM upon input.

Each input is assigned a DLink that maps the switch position (the signal level) at the associated input terminal, even if a switching input has been assigned DIF 0.

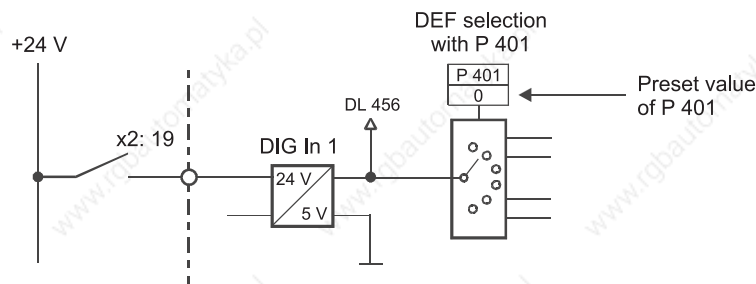
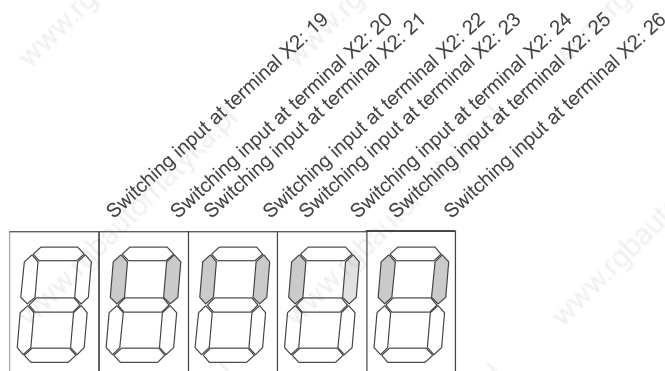

Illustration 33: Digital switching input 1

The DIF selection parameter defines the function of the switching input at the related terminal and is assigned to the selected DLink.

Parameter	Switching input	Terminal	DLink
P 401	Function, digital input 1	X2: 19	DL 456
P 402	Function, digital input 2	X2: 20	DL 457
P 403	Function digital input 3	X2: 21	DL 458
P 404	Function, digital input 4	X2: 22	DL 459
P 405	Function, digital input 5	X2: 23	DL 460
P 406	Function, digital input 6	X2: 24	DL 461
P 407	Function, digital input 7	X2: 25	DL 462
P 408	Function, digital input 8	X2: 26	DL 463

The signal levels at the switching inputs are displayed as bar code in parameter P 43. The bar assigned to the switching input is illuminated as soon as a HIGH level is available at the respective terminal.



In addition to that, if there is a bus connection, some of the functions may be tripped by setting/resetting the control word bits listed in the table below. The column Operation specifies the logic

function used to link control word bit and switch input. The specified operation applies also if several switching inputs are assigned the same function.

Example:

DIF 7: Acknowledge error

OR operation between control word bit P 101/bit 7 and the switching input which the digital input function DIF 7 was assigned to. The OR operation can be used to acknowledge an error either via the switch **or** via the control bit.

DIF 9: Set analog input 1 to zero

AND operation between control word bit P 181/bit 1 and the switching input which the digital input function DIF 9 was assigned to. Due to the AND operation, the signal at analog input 1 can be isolated only if the control bit is set (HIGH) **and** the switching input is at HIGH level (+24 V).

After voltage has been applied to the electronics supply, the control word bits for which an AND operation has been specified, are on HIGH level, and the control word bits for which an OR operation has been specified, on LOW level.

Any unused digital input functions for the switching inputs are set in accordance with the specified operation. At an AND operation to HIGH level, at an OR operation to LOW level.

The internal switch positions drawn in the function diagrams are drawn for unused digital input functions at terminals X2: 19 to X2: 26 and unaffected control word bits.

5.3 Converter structure

5.3.4.1 List of digital input functions DIF

DIF no.	Operation	Control word Bit no.	Description
0			Digital input switched off, DLink active
1			1: Load data record 1
2			1: Load data record 2
3			1: Load data record 3
4			1: Load data record 4
5			1: Load data record 5
6			1: Load data record 6
7	OR	P 101 Bit 7	1: Acknowledge error
8	OR	P 181 Bit 0	1: Negate analog input 1
9	AND	P 181 Bit 1	1: Enable analog input 1
10	OR	P 181 Bit 2	1: Negate analog input 2
11	AND	P 181 Bit 3	1: Enable analog input 2
12	OR	P 181 Bit 4	1: Negate analog input 3
13	AND	P 181 Bit 5	1: Enable analog input 3
14	OR	P 181 Bit 6	1: Negate analog input 4
15	AND	P 181 Bit 7	1: Enable analog input 4
16	OR	P 221 Bit 0	0: Ramp generator A parameter set 1 active 1: Ramp generator A parameter set 2 active
17	AND	P 221 Bit 6	1: Enable ramp generator A input (setpoint)
18	OR	P 221 Bit 5	1: Stop ramp generator A
19	AND	P 221 Bit 4	1: Enable ramp generator A output
20	OR	P 211 Bit 0	1: Motor potentiometer up (+)
21	OR	P 211 Bit 1	1: Motor potentiometer down (-)
22	AND	P 301 Bit 0	1: Enable speed controller setpoint (after addition)
23	OR	P 601 Bit 0	Unassigned change-over switch 1
24	OR	P 601 Bit 1	Unassigned change-over switch 2
25	OR	P 601 Bit 2	Unassigned change-over switch 3
26	AND	P 601 Bit 3	Unassigned change-over switch 4
27	AND	P 561 Bit 0	1: Unassigned controller : Enable setpoint (after addition)
28	AND	P 561 Bit 1	1: Unassigned controller : Enable controller
29	AND	P 561 Bit 2	1: Unassigned controller : Enable I-component
30	OR		Multiplier 1
31	OR		Multiplier 2
32	AND	P 221 Bit 7	1: Enable ramp generator B input (setpoint)
33	AND	P 221 Bit 8	1: Enable ramp generator B output

DEF Nr.	Verknüpfung	Steuerwort Bit Nr.	Bedeutung
0			Digitaler Eingang abgeschaltet, DLink aktiv
1			1: Datensatz 1 laden

2			1: Datensatz 2 laden
3			1: Datensatz 3 laden
4			1: Datensatz 4 laden
5			1: Datensatz 5 laden
6			1: Datensatz 6 laden
7	ODER	P 101 Bit 7	1: Fehler quittieren
8	ODER	P 181 Bit 0	1: Analogeingang 1 negieren
9	UND	P 181 Bit 1	1: Analogeingang 1 freigeben
10	ODER	P 181 Bit 2	1: Analogeingang 2 negieren
11	UND	P 181 Bit 3	1: Analogeingang 2 freigeben
12	ODER	P 181 Bit 4	1: Analogeingang 3 negieren
13	UND	P 181 Bit 5	1: Analogeingang 3 freigeben
14	ODER	P 181 Bit 6	1: Analogeingang 4 negieren
15	UND	P 181 Bit 7	1: Analogeingang 4 freigeben
16	ODER	P 221 Bit 0	0: Hochlaufgeber A Beschaltung 1 aktiv 1: Hochlaufgeber A Beschaltung 2 aktiv
17	UND	P 221 Bit 6	1: Hochlaufgeber A Eingang (Sollwert) freigeben
18	ODER	P 221 Bit 5	1: Hochlaufgeber A stop
19	UND	P 221 Bit 4	1: Hochlaufgeber A Ausgang freigeben
20	ODER	P 211 Bit 0	1: Motorpoti hoch (+)
21	ODER	P 211 Bit 1	1: Motorpoti runter (-)
22	UND	P 301 Bit 0	1: Drehzahlregler Sollwert (nach Summenpunkt) freigeben
23	ODER	P 601 Bit 0	Freier Umschalter 1
24	ODER	P 601 Bit 1	Freier Umschalter 2
25	ODER	P 601 Bit 2	Freier Umschalter 3
26	UND	P 601 Bit 3	Freier Umschalter 4
27	UND	P 561 Bit 0	1: Freier Regler : Sollwert (nach Summenpunkt) freigeben
28	UND	P 561 Bit 1	1: Freier Regler : Regler freigeben
29	UND	P 561 Bit 2	1: Freier Regler : I-Anteil freigeben
30	ODER		Vervielfacher 1
31	ODER		Vervielfacher 2
32	UND	P 221 Bit 7	1: Hochlaufgeber B Eingang (Sollwert) freigeben
33	UND	P 221 Bit 8	1: Hochlaufgeber B Ausgang freigeben

5.3 Converter structure

5.3.5 Overload function

An overload function is implemented in several power units. These power units can be run with a higher current as the power unit nominal current (P003) for a short time. The power unit's possible peak current is displayed in P005.

The overload period is limited by a Ixt monitoring.

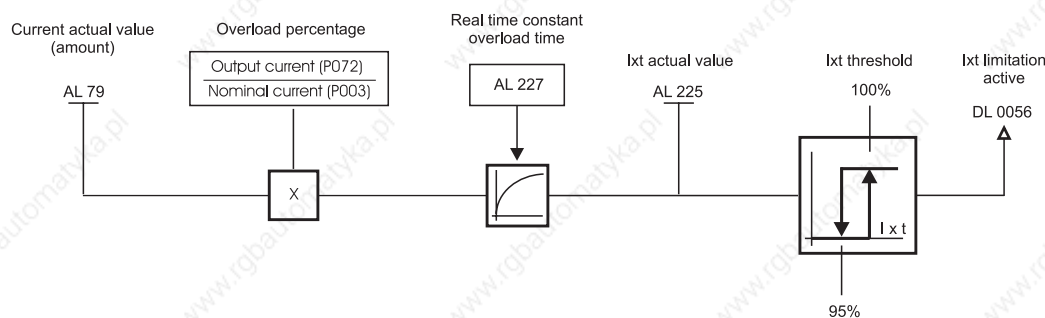

The possible overload period depends on the previous load. The overload period displayed in the power unit table is valid for a peak current load, if the device has not run before.

If the output current is lower than the peak current (e.g. only 1,1 * nominal current), the possible overload period is longer.

As soon as the Ixt value 100 % is reached, the output current of the device is limited to nominal current. The maximum output current can be supplied again, if the Ixt value is below 95 %.

Example for Ixt monitoring

Power unit nominal current: 100 A
 Power unit peak current: 120 A
 Device output current: 120 A
 Overload period: 30 s

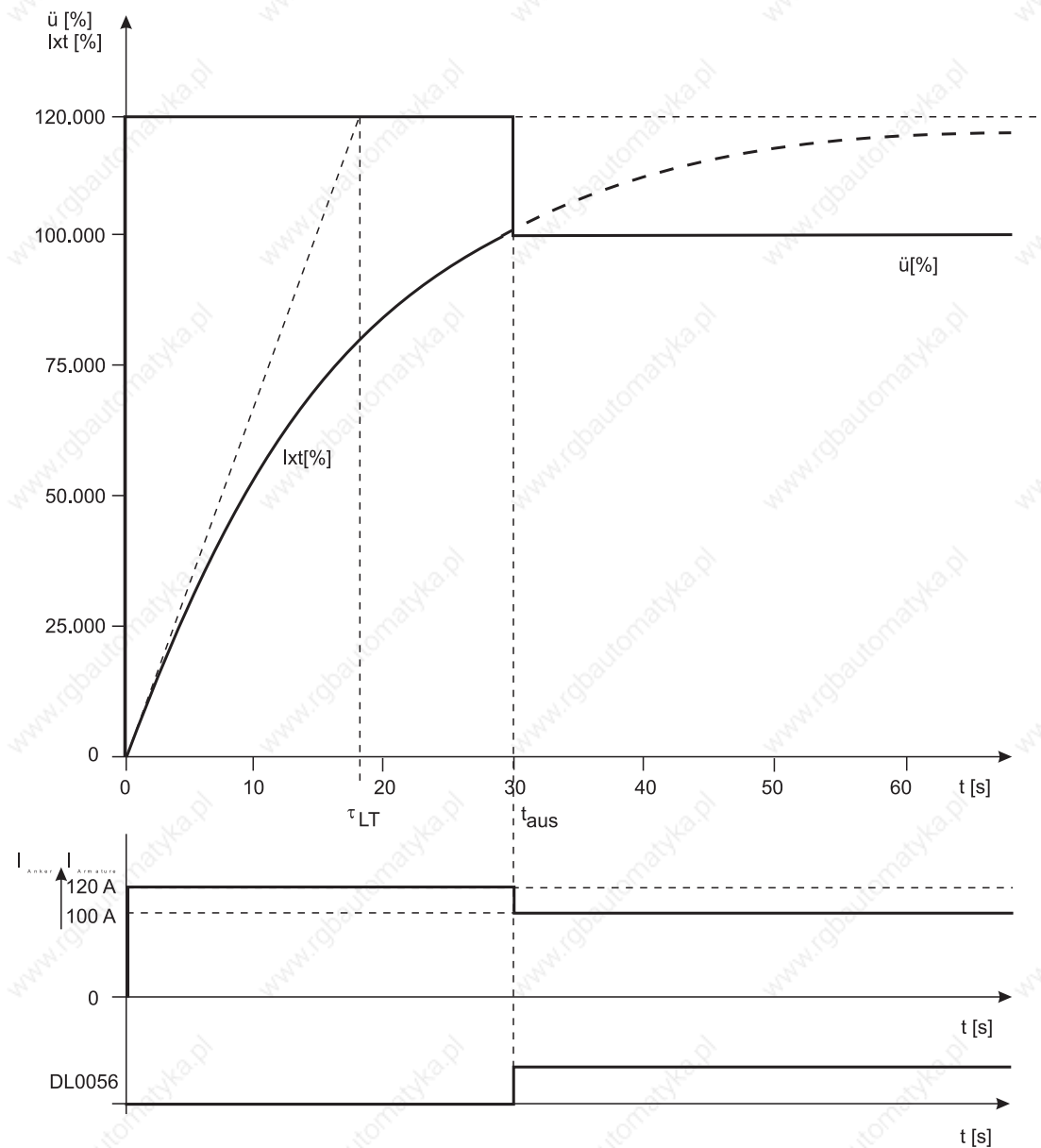

5.4 Function diagrams

The function diagrams below illustrate the converter structure and the different setting options. For a more detailed description of the individual parameters refer to sections [▶Parameter description - Converter data](#) from page 181 to [▶Parameter description - System parameters](#) from page 349.

For explanations regarding the symbols used and the graphic representations as well as the basic ALink and DLink combinations refer section [▶Converter structure](#) from page 85.

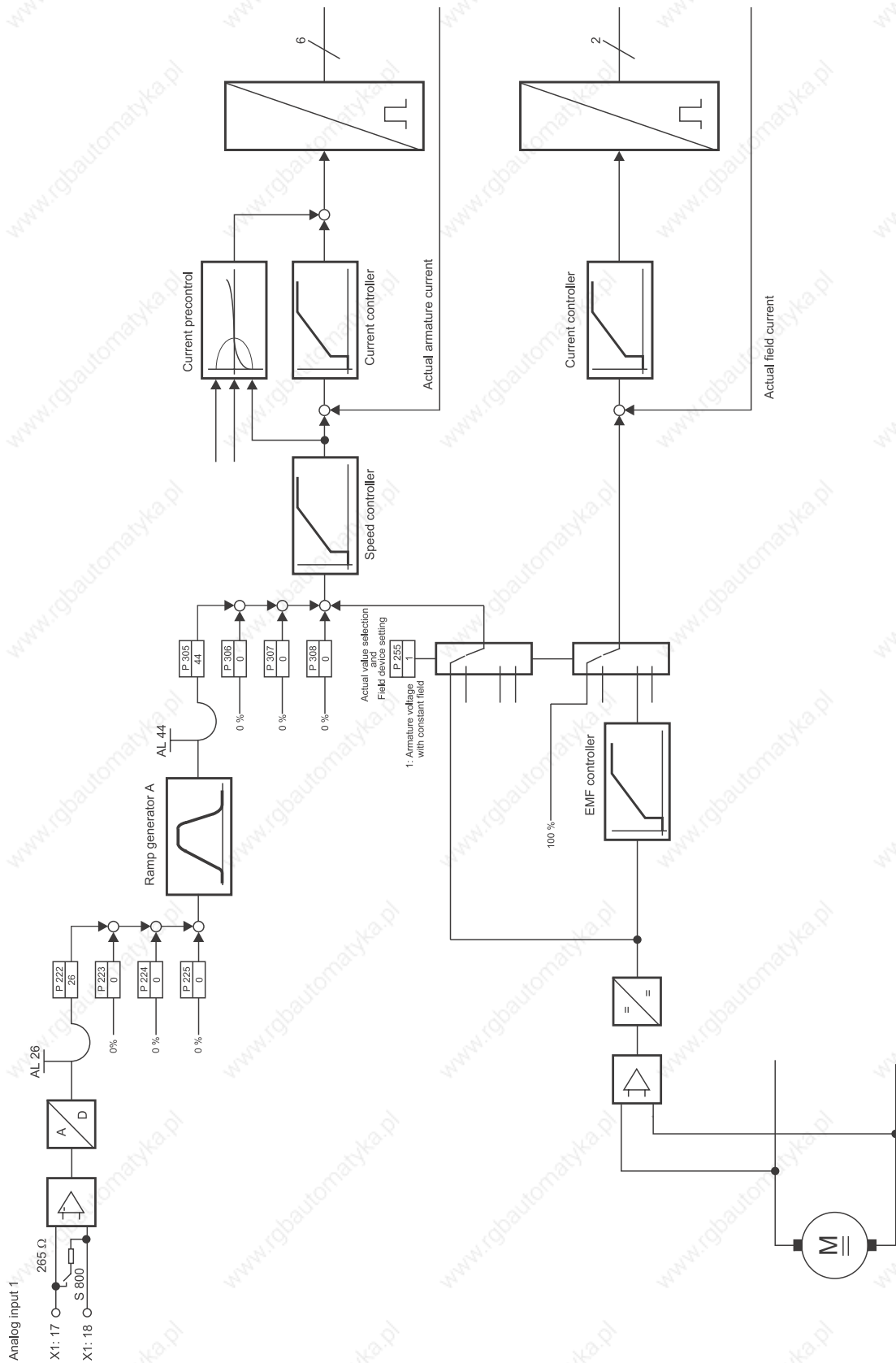

Illustration 34: Function diagram - As-supplied converter configuration

5.4 Function diagrams

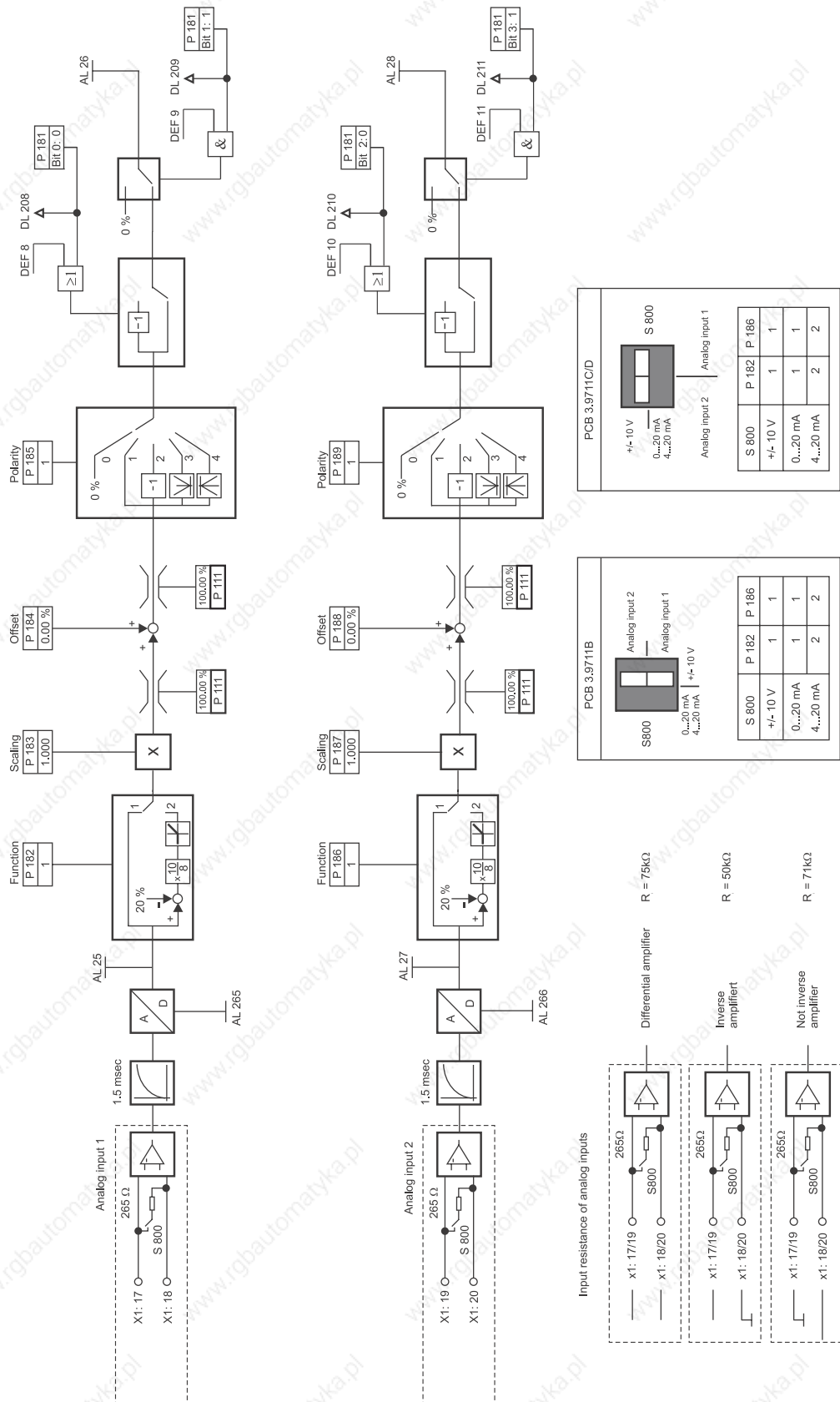

Illustration 35: Function diagram - Analog inputs 1 and 2

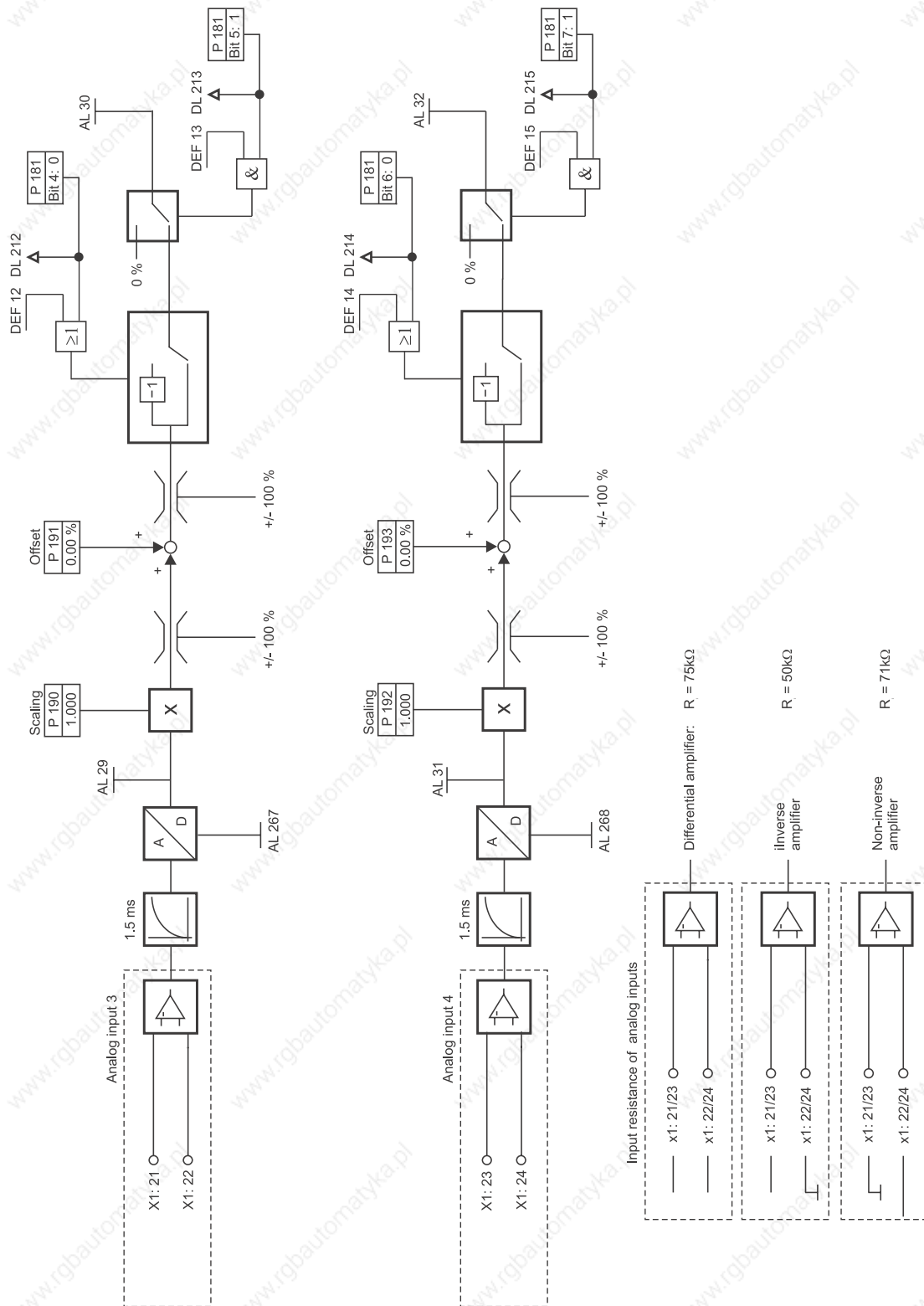

Illustration 36: Function diagram - Analog inputs 3 and 4

5.4 Function diagrams

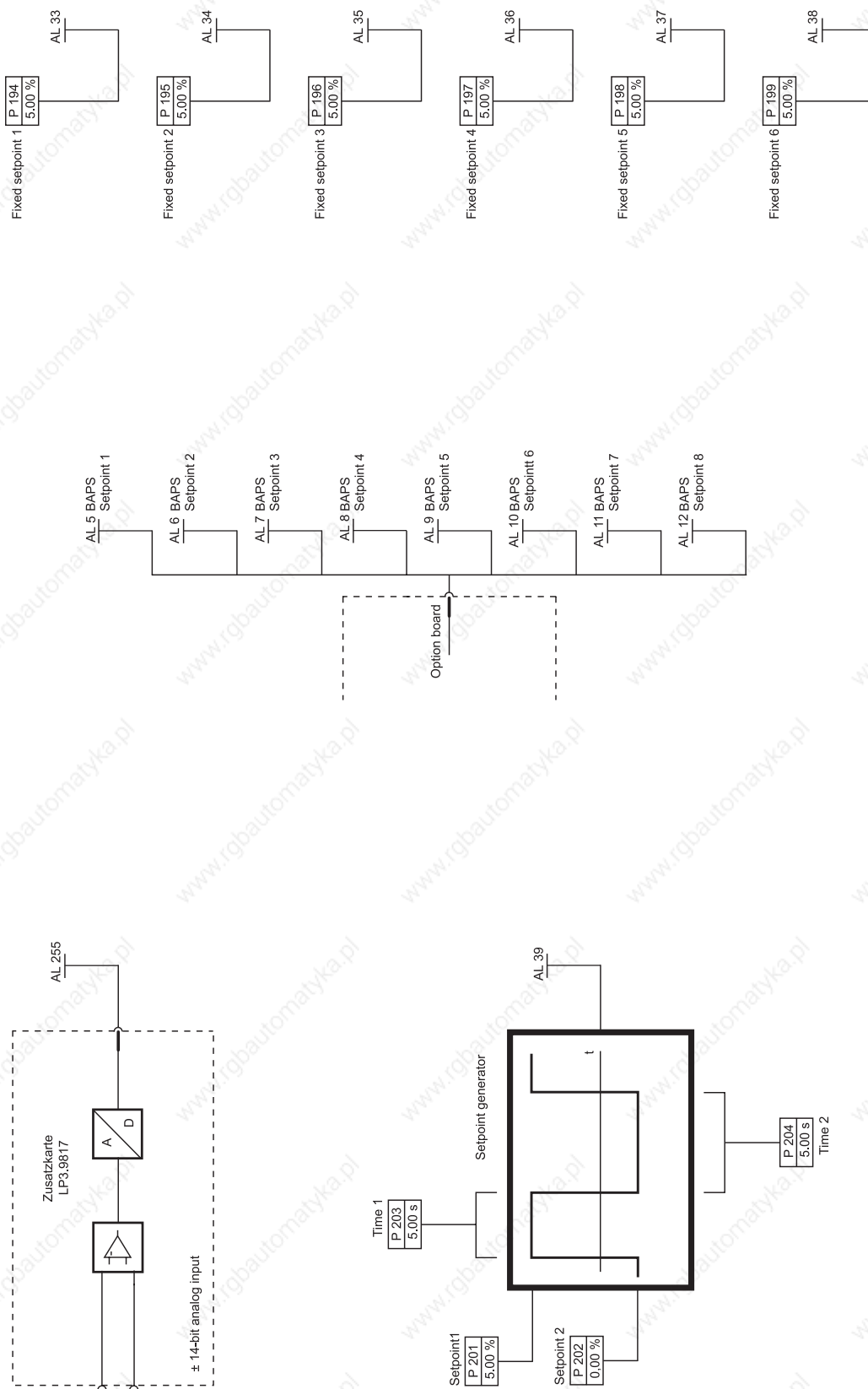

Illustration 37: Function diagram - Setpoints

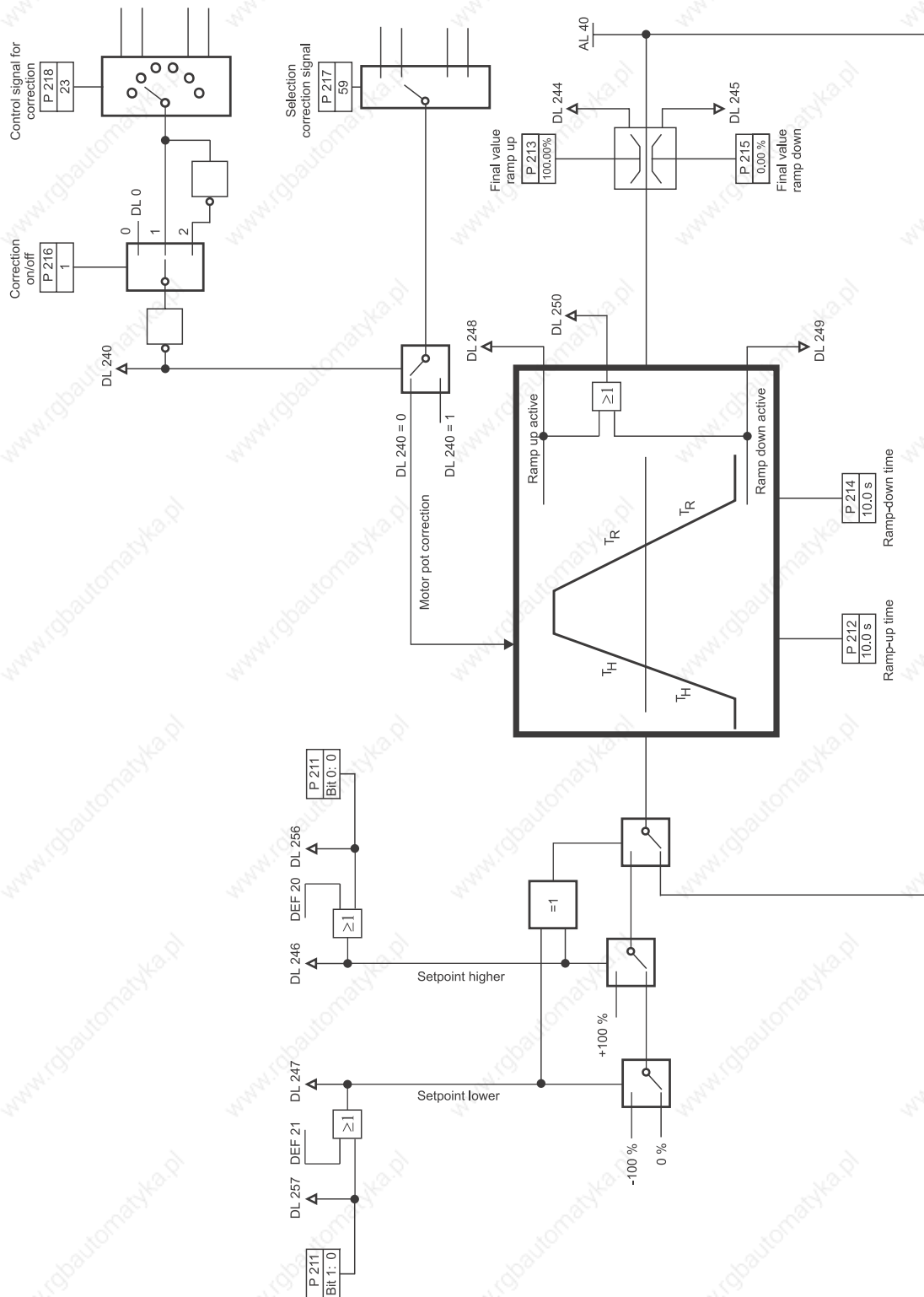

Illustration 38: Function diagram - Motorised potentiometer

5.4 Function diagrams

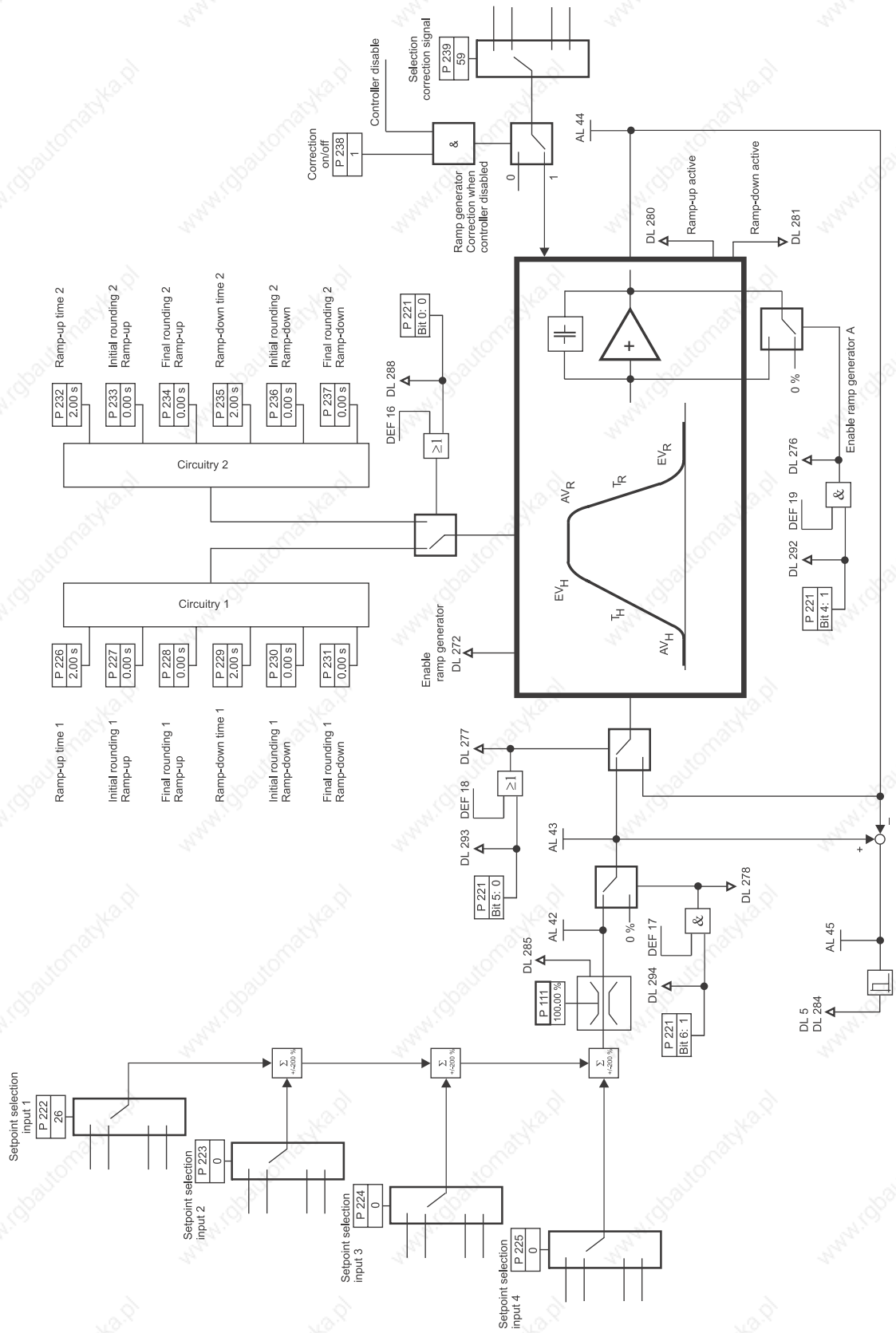

Illustration 39: Function diagram - Ramp generator A

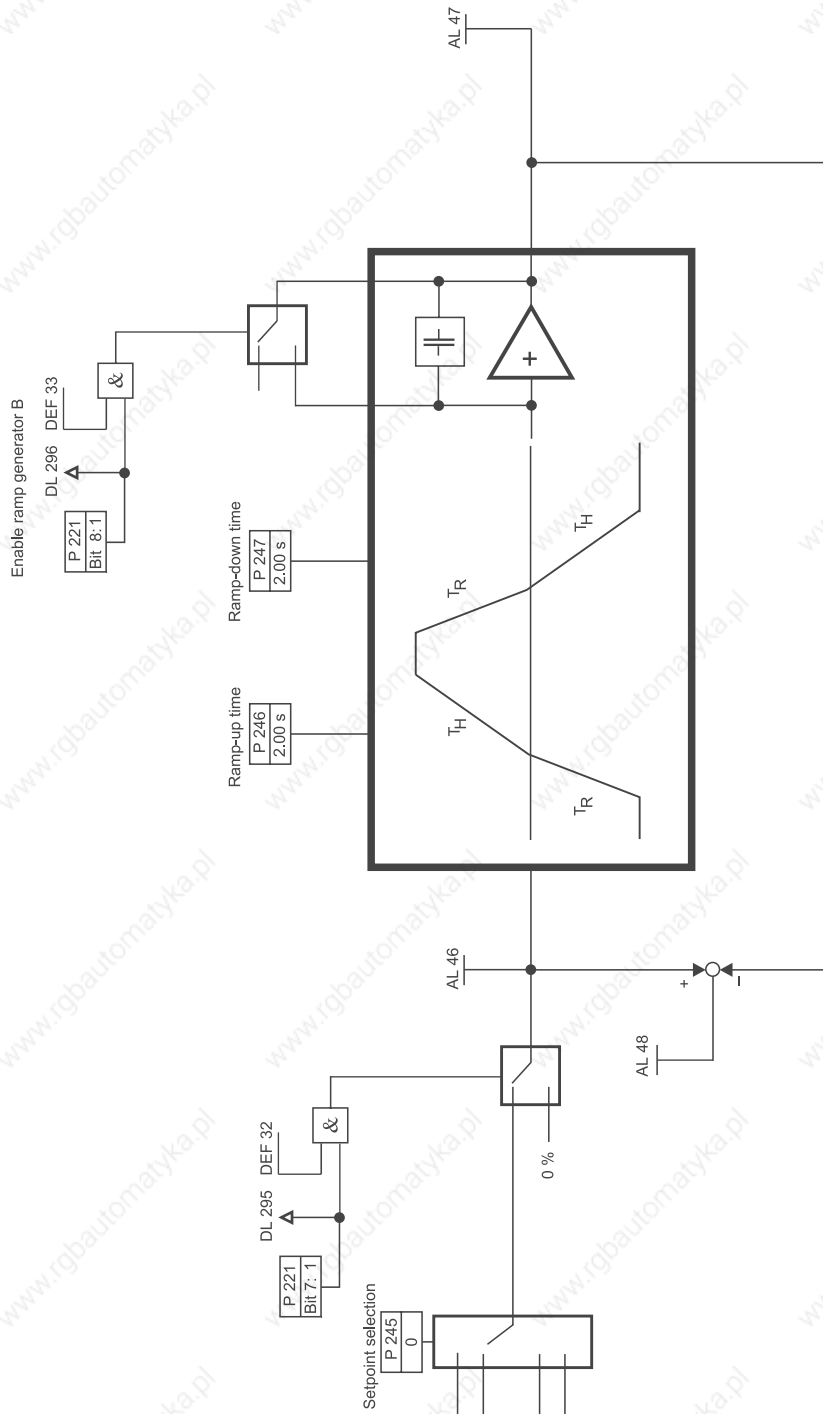

Illustration 40: Function diagram - Ramp generator B

5.4 Function diagrams

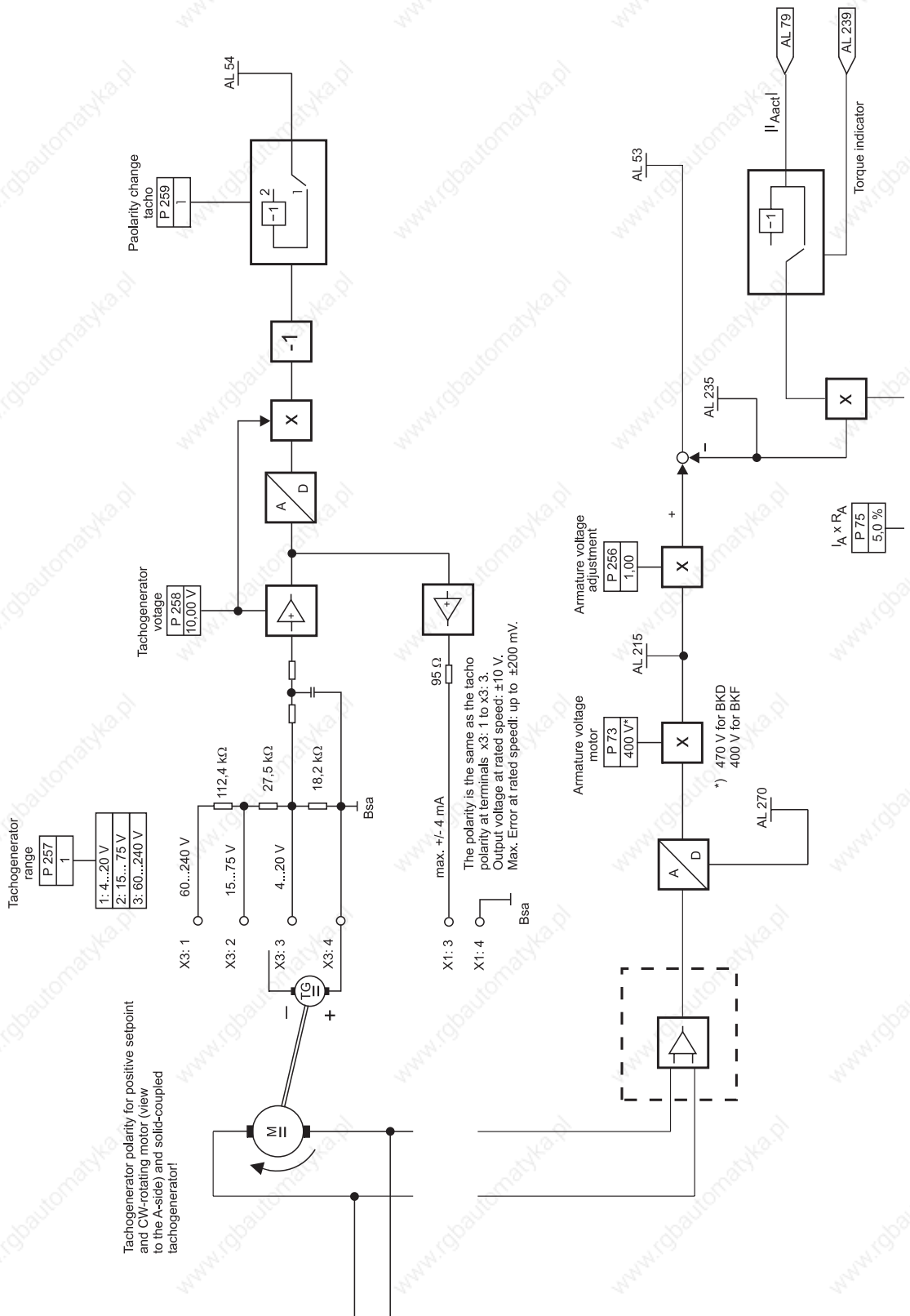

Illustration 41: Function diagram - Analog tacho / armature voltage detection input

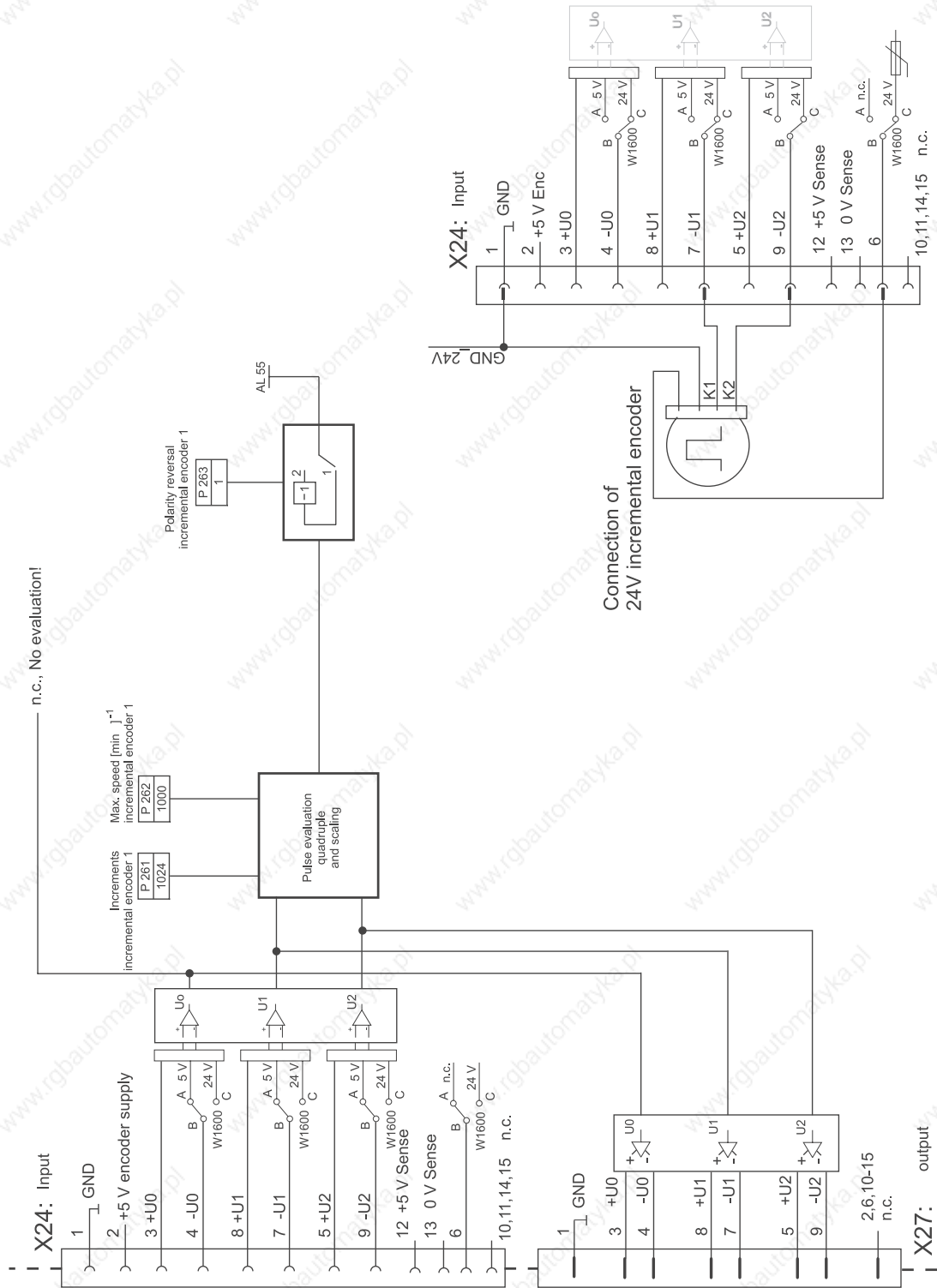

Illustration 42: Function diagram - Incremental encoder 1

5.4 Function diagrams

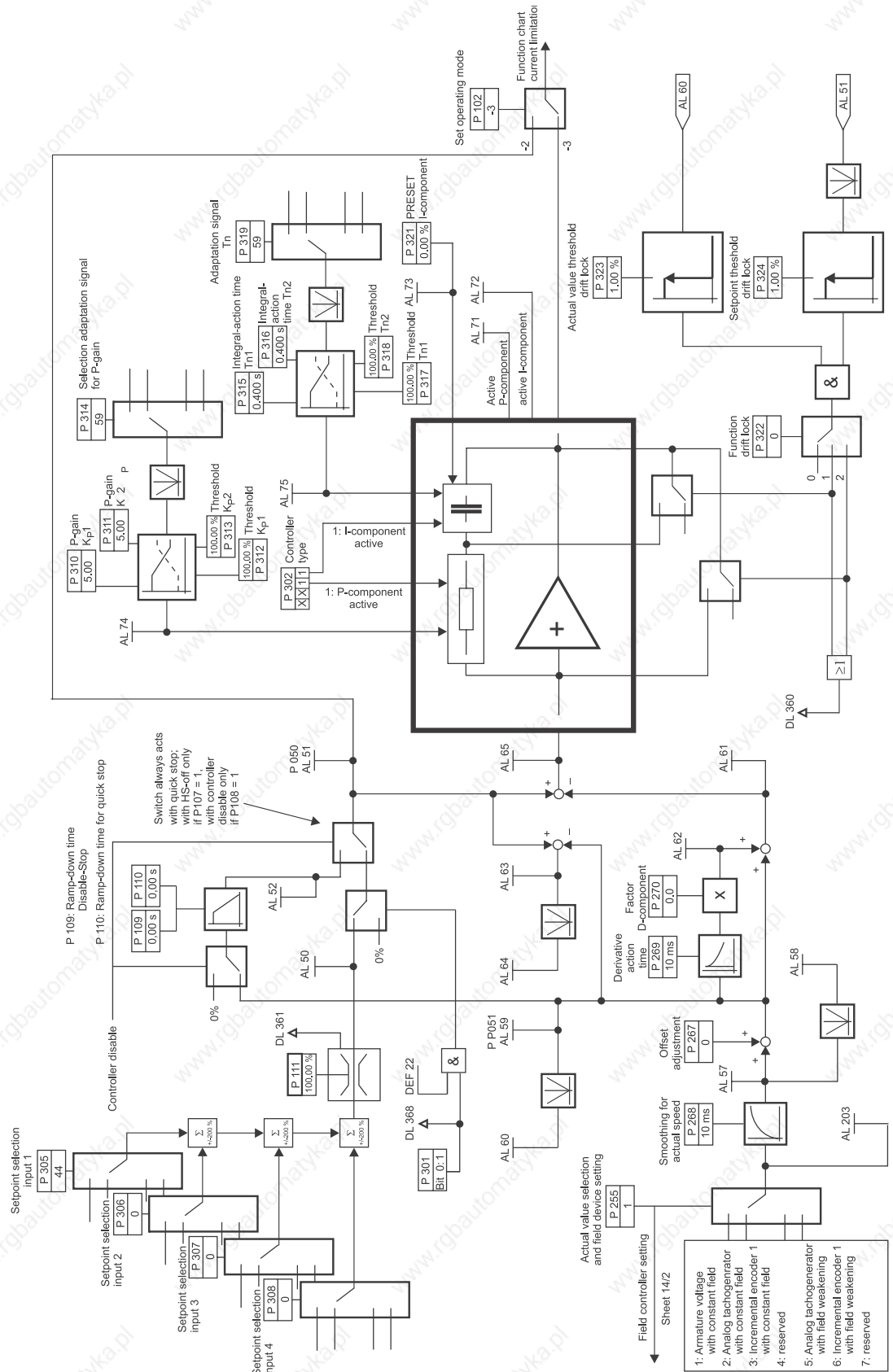
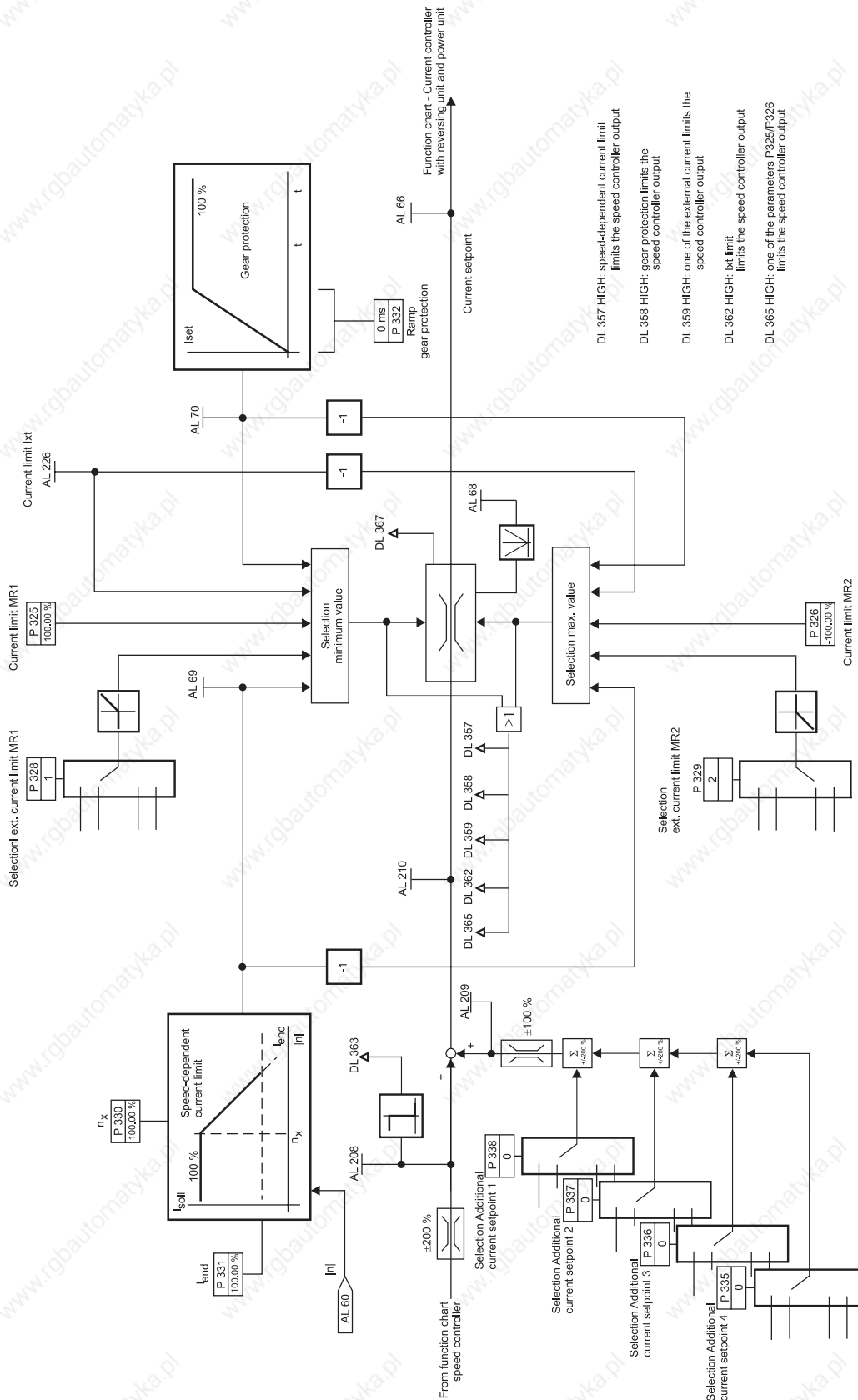

Illustration 43: Function diagram - Speed controller



- DL 357 HIGH: speed-dependent current limit limits the speed controller output
- DL 358 HIGH: gear protection limits the speed controller output
- DL 359 HIGH: one of the external current limits the speed controller output
- DL 362 HIGH: Ixt limit limits the speed controller output
- DL 365 HIGH: one of the parameters P325/P326 limits the speed controller output

Illustration 44: Function diagram - Current limitation

5.4 Function diagrams

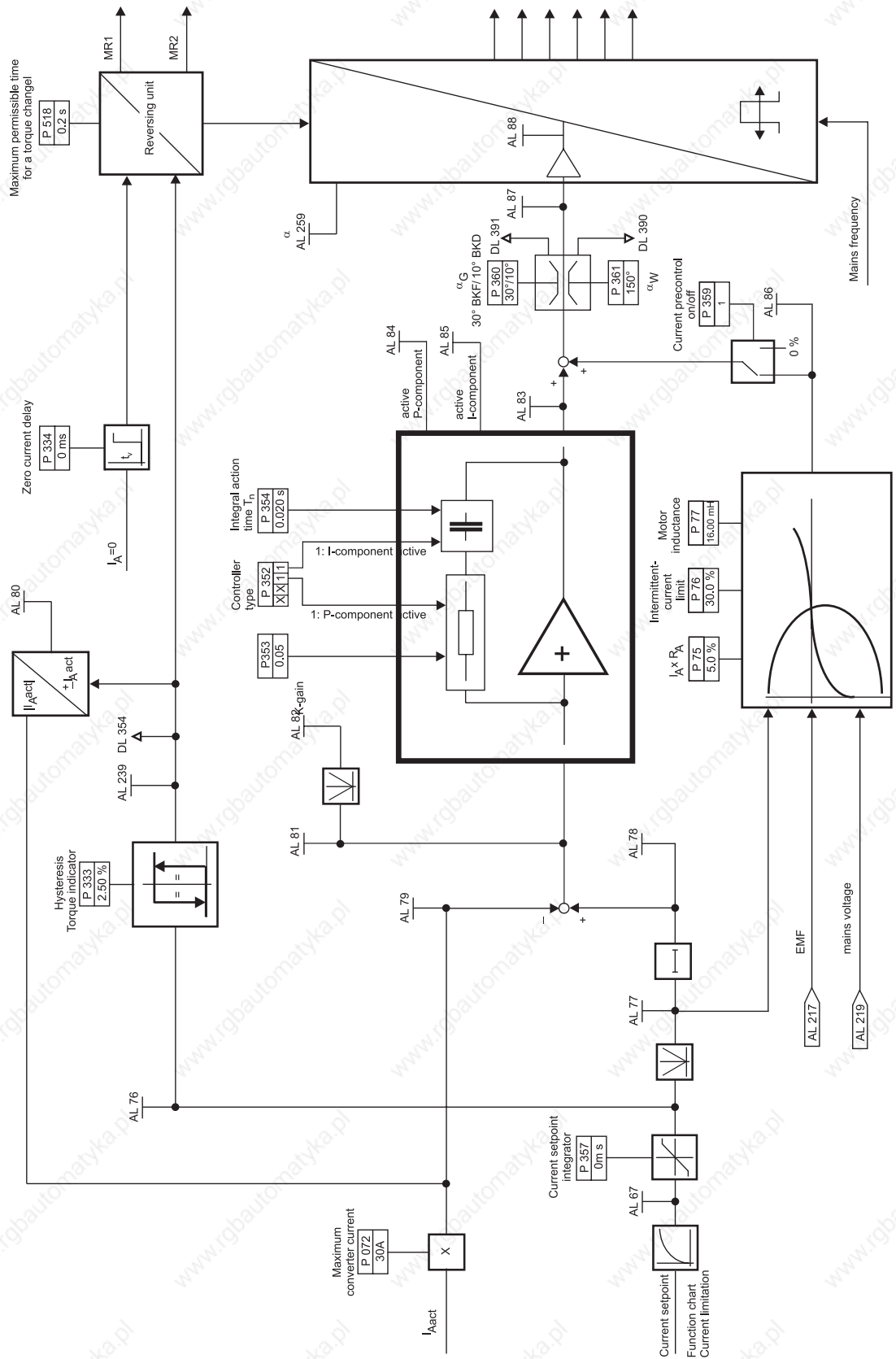

Illustration 45: Function diagram - Current controller with reversing unit and power unit

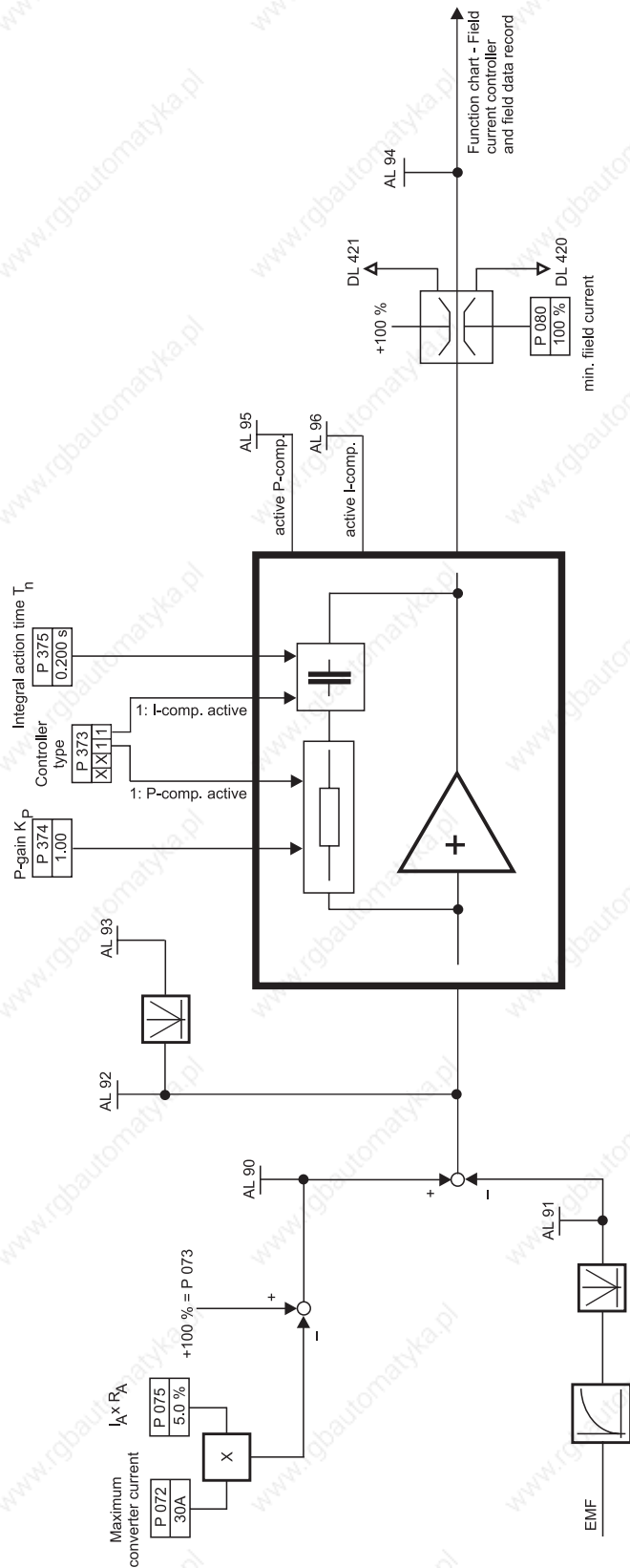

Illustration 46: Function diagram - Field unit EMF controller

5.4 Function diagrams

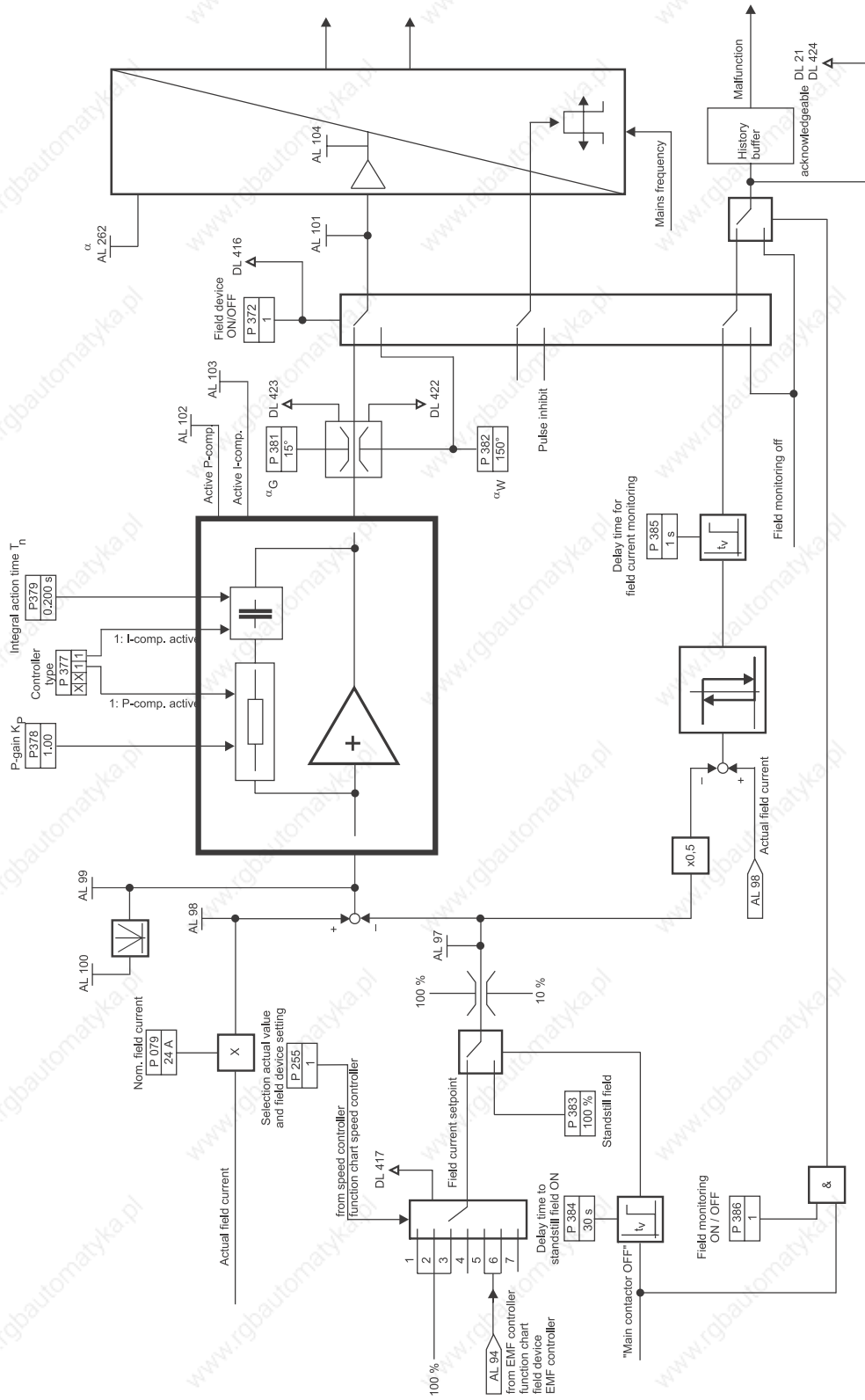

Illustration 47: Function diagram - Field unit, field current controller and field control unit

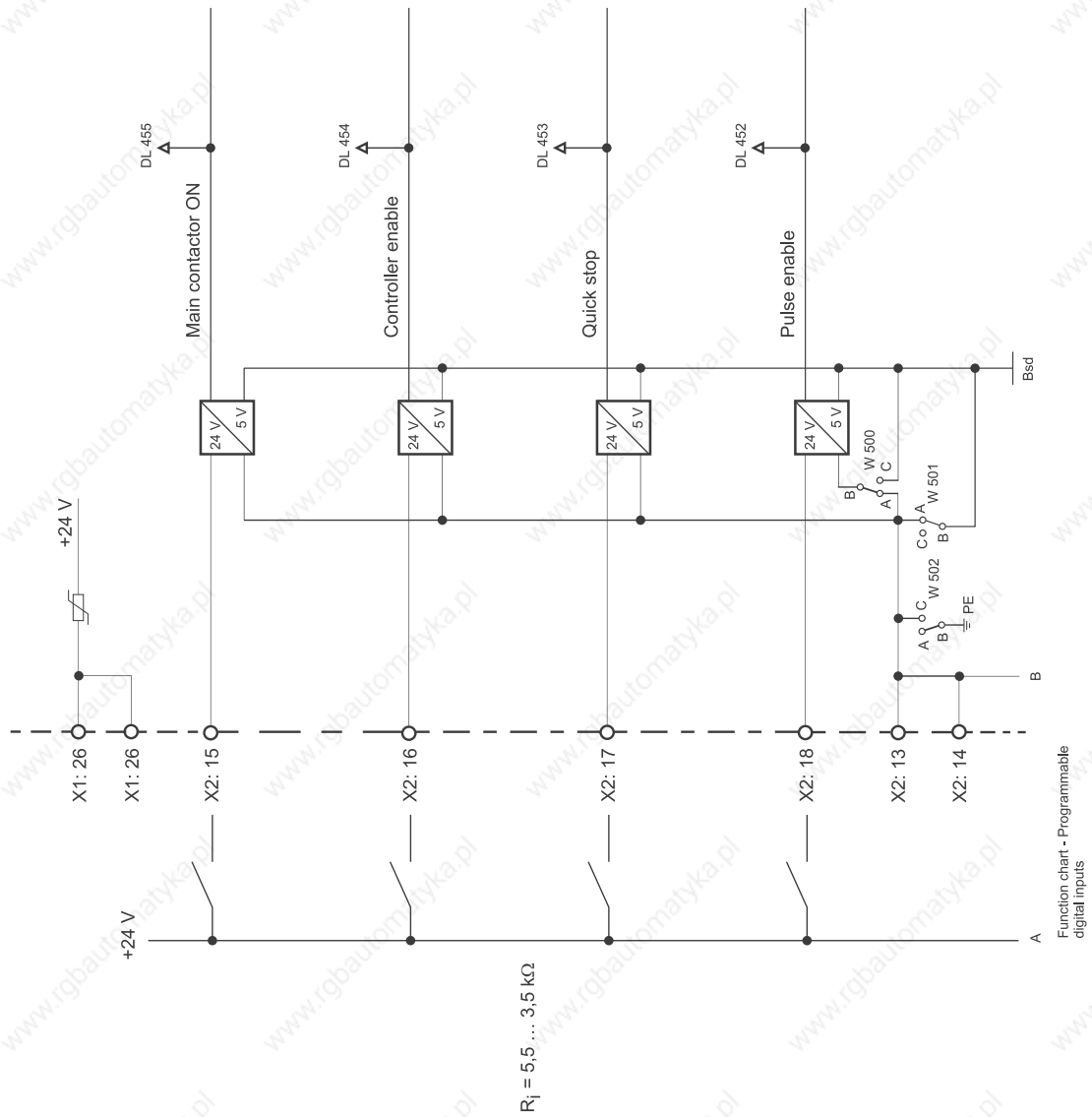

Illustration 48: Function diagram - Digital inputs for Controller enable

5.4 Function diagrams

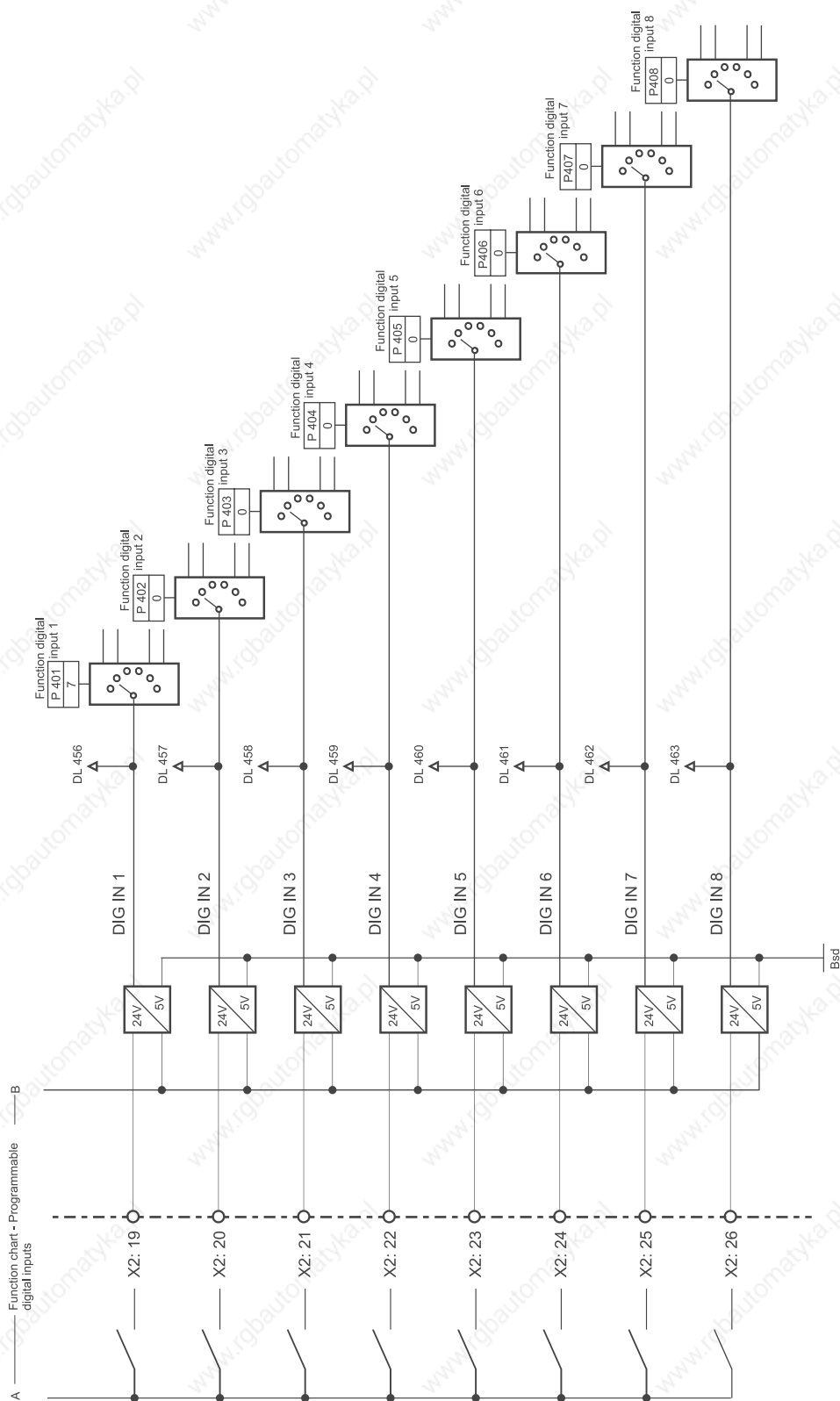

Illustration 49: Function diagram - Programmable digital inputs

Digital input multipliers see [▶Parameter description - Digital input multipliers◀](#) on page 258.

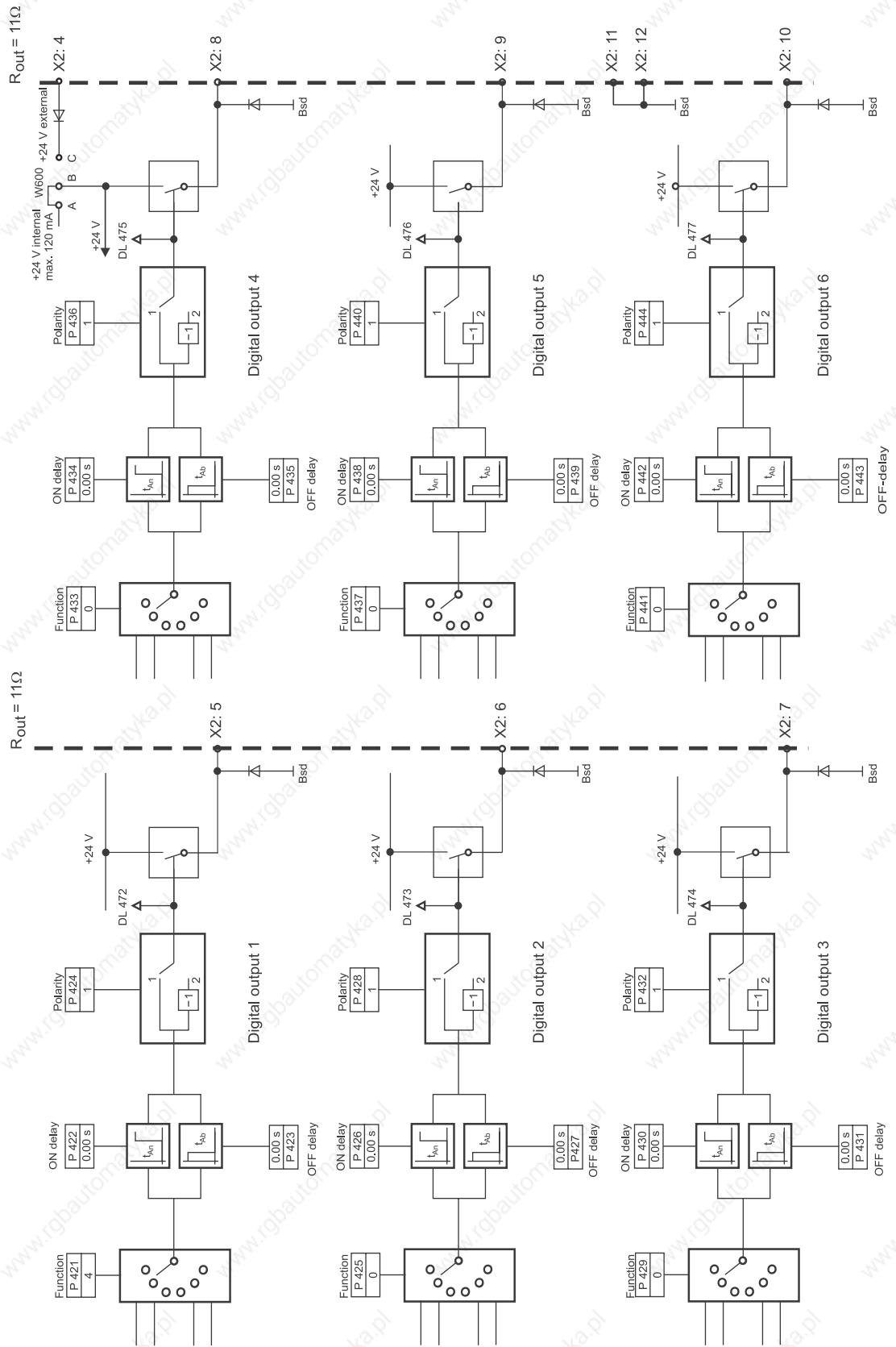

Illustration 50: Function diagram - Programmable digital outputs

5.4 Function diagrams

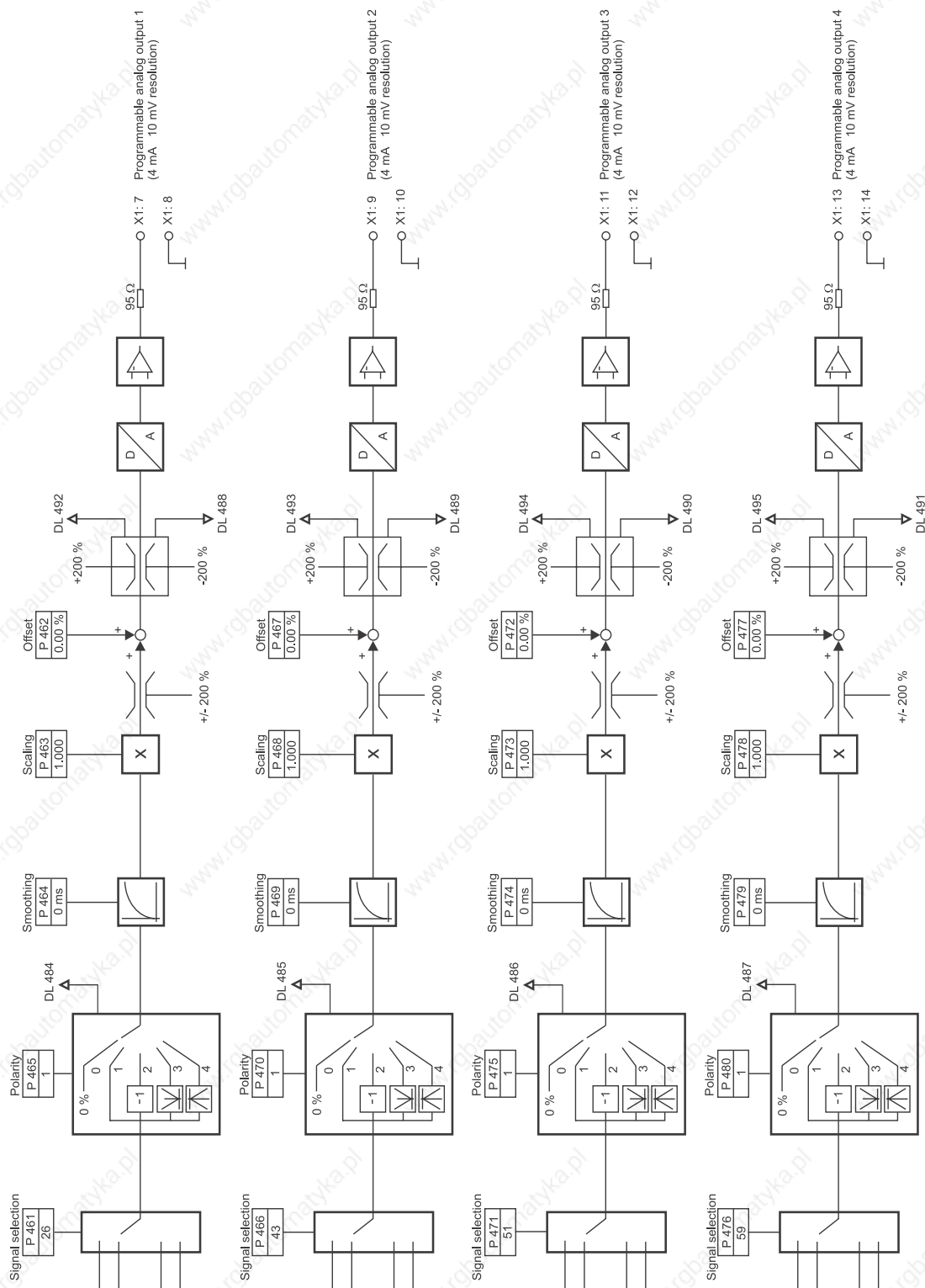

Illustration 51: Function diagram - Programmable analog outputs

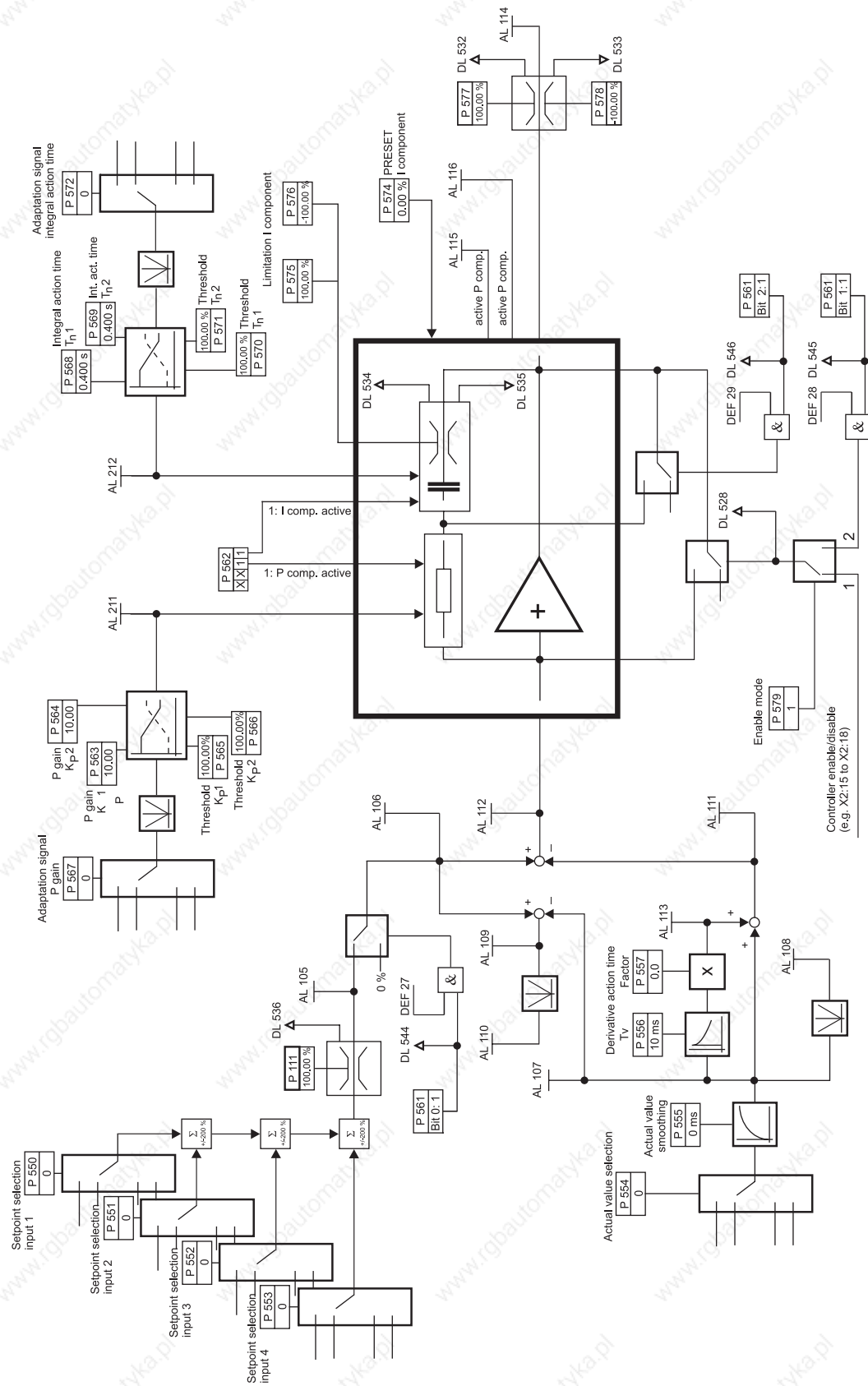

Illustration 52: Function diagram - Unassigned PI controller

5.4 Function diagrams

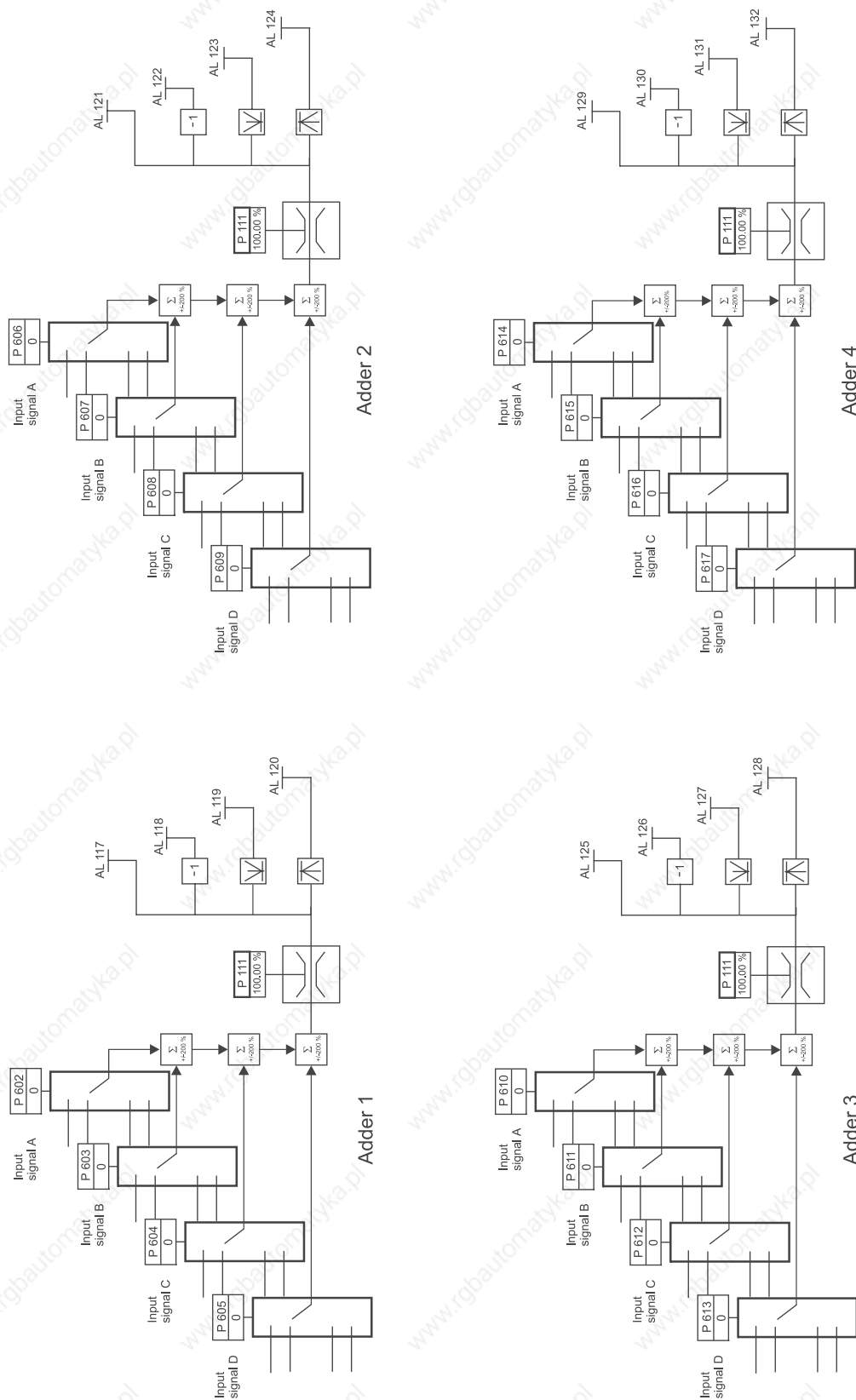

Illustration 53: Function diagram - Freely interconnectable adders

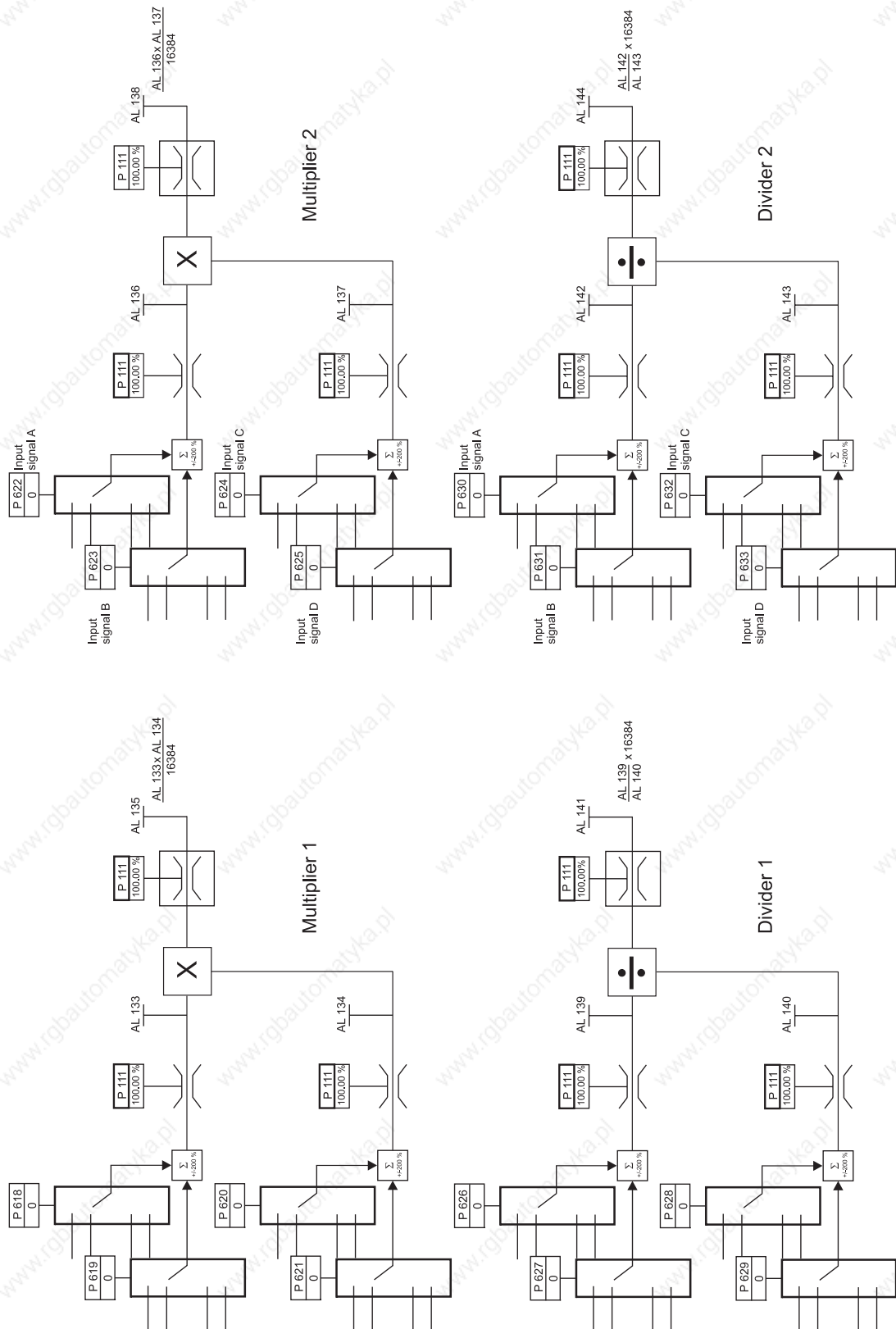

Illustration 54: Function diagram - Freely interconnectable multipliers / dividers

5.4 Function diagrams

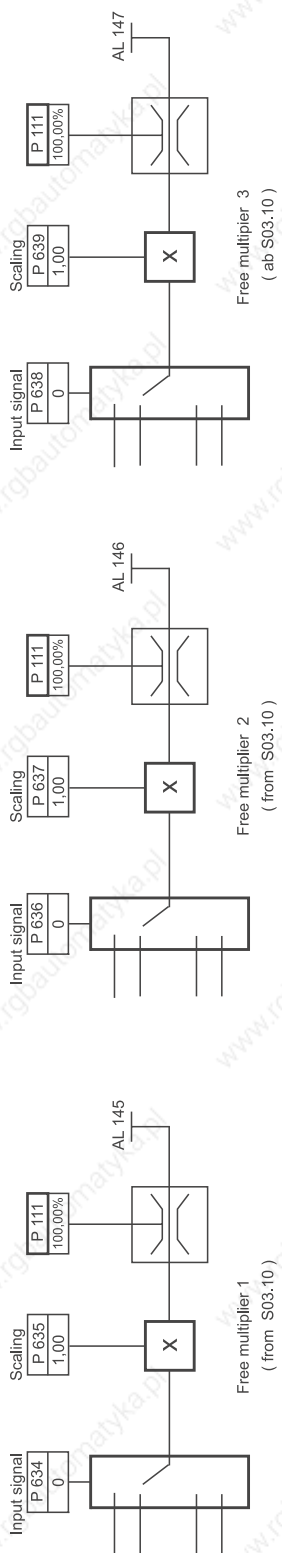

Illustration 55: Function diagram - Freely interconnectable function blocks 1

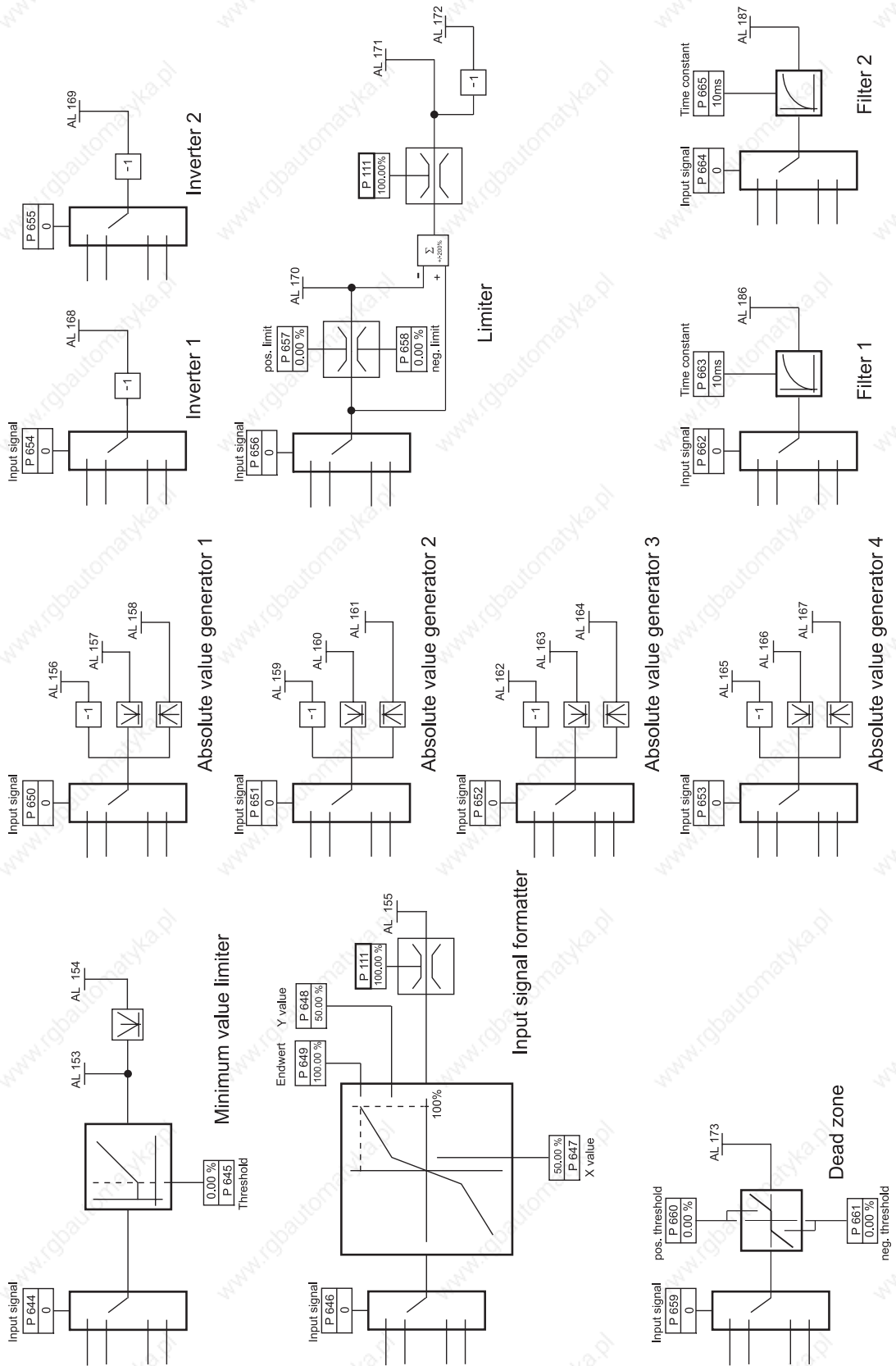

Illustration 56: Function diagram - Freely interconnectable function blocks 2

5.4 Function diagrams

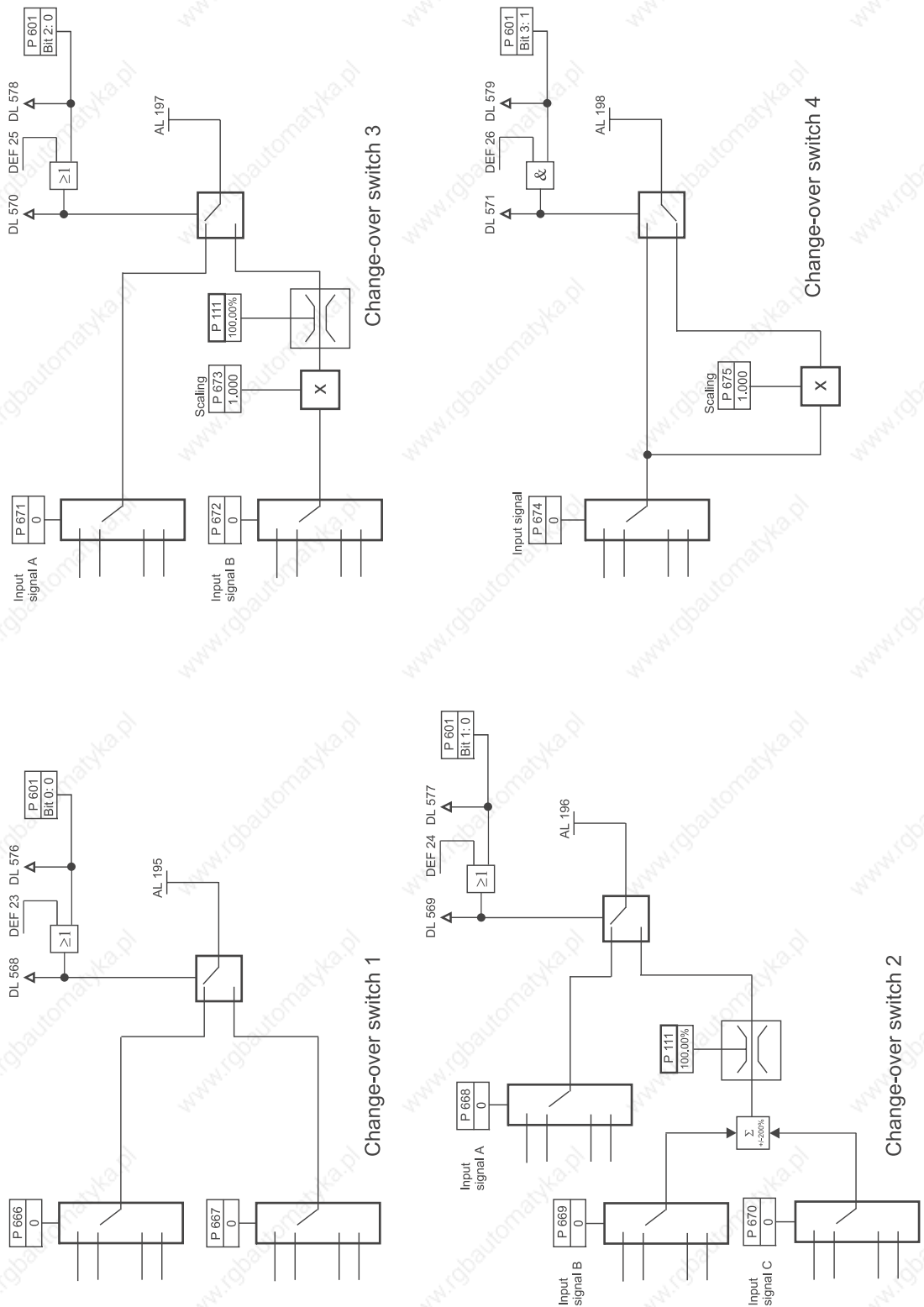

Illustration 57: Function diagram - Freely interconnectable changeover switches

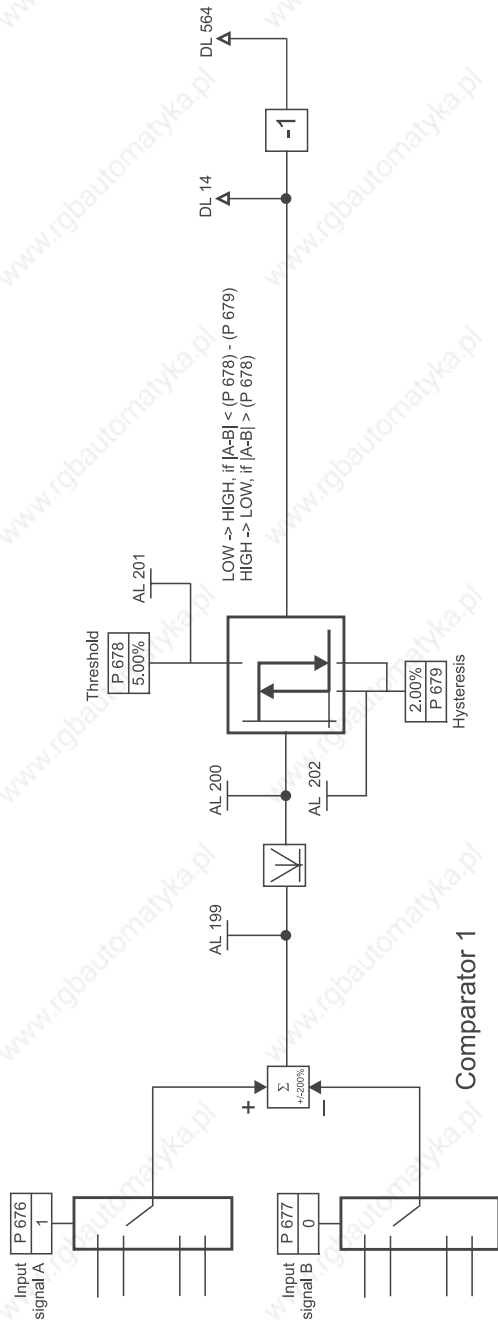

Illustration 58: Function diagram - Freely interconnectable comparator

5.4 Function diagrams

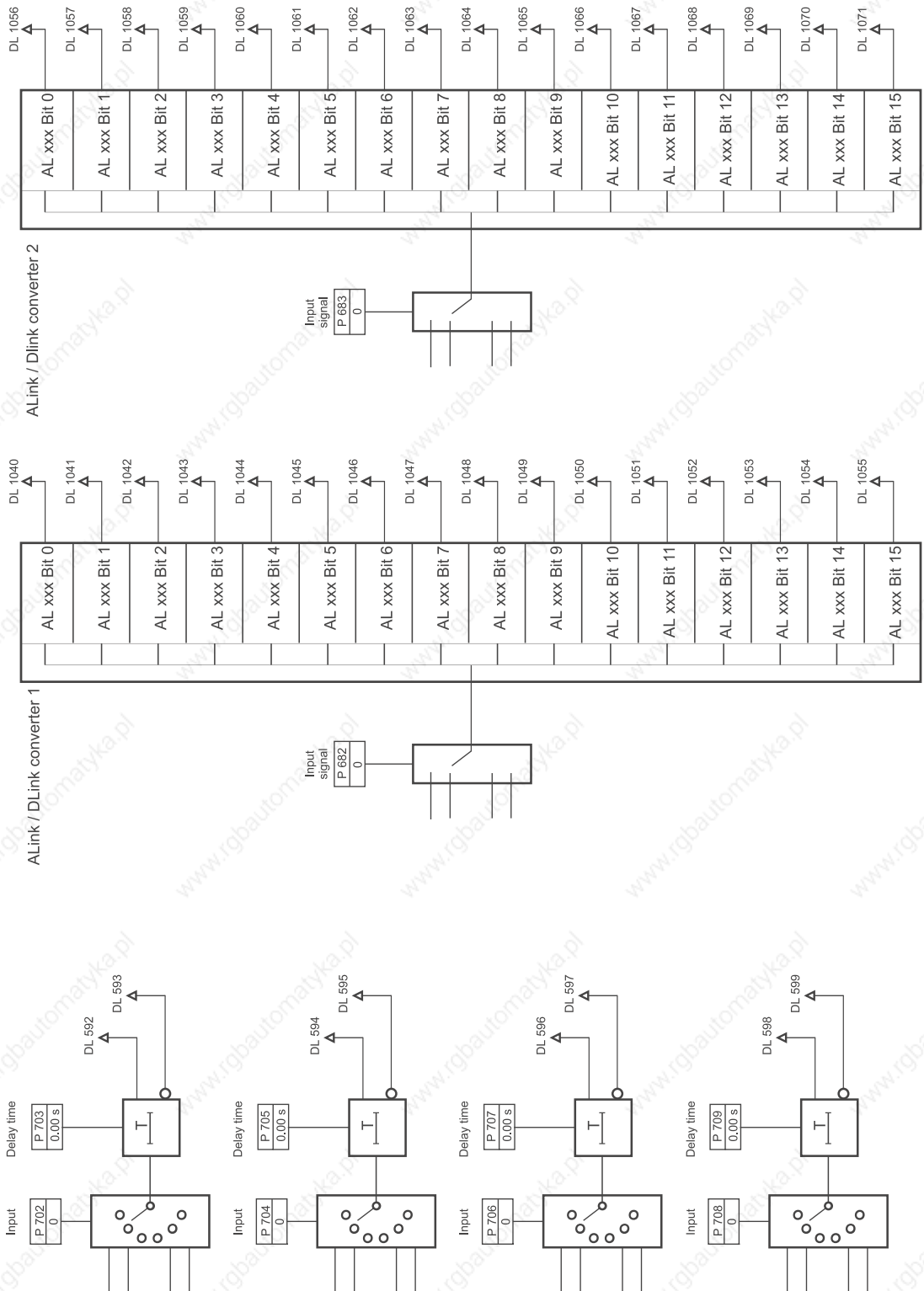

Illustration 59: Function diagram - Unassigned digital functions

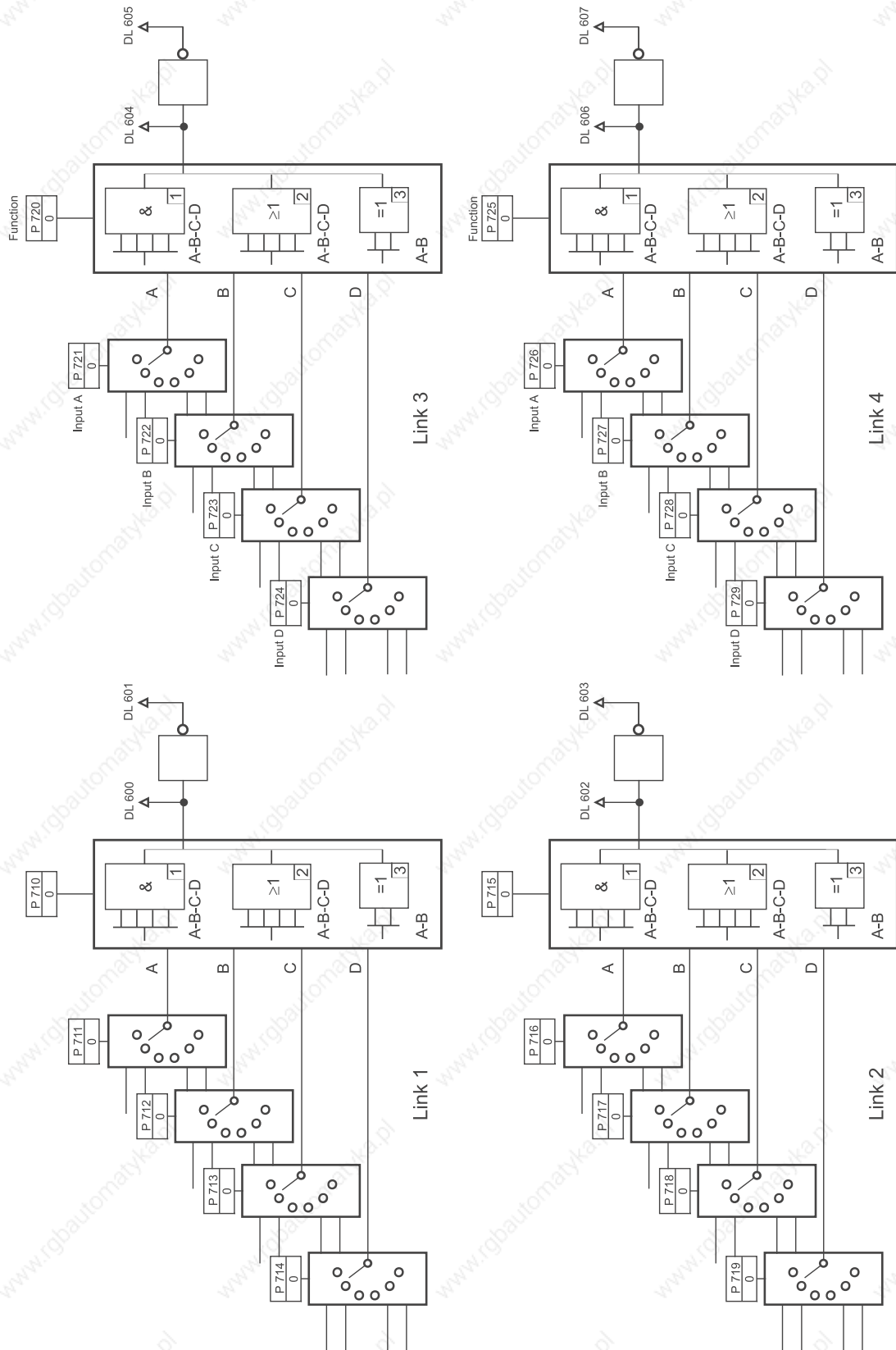

Illustration 60: Function diagram - Unassigned digital relations

5.4 Function diagrams

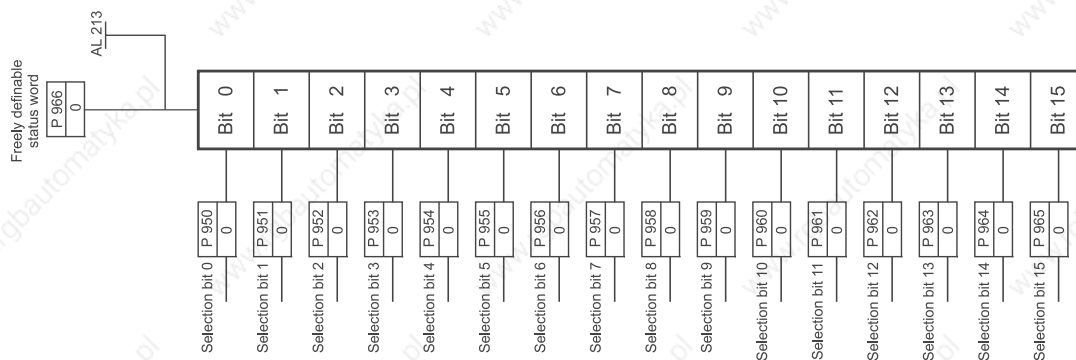

Illustration 61: Function diagram - Freely definable status word

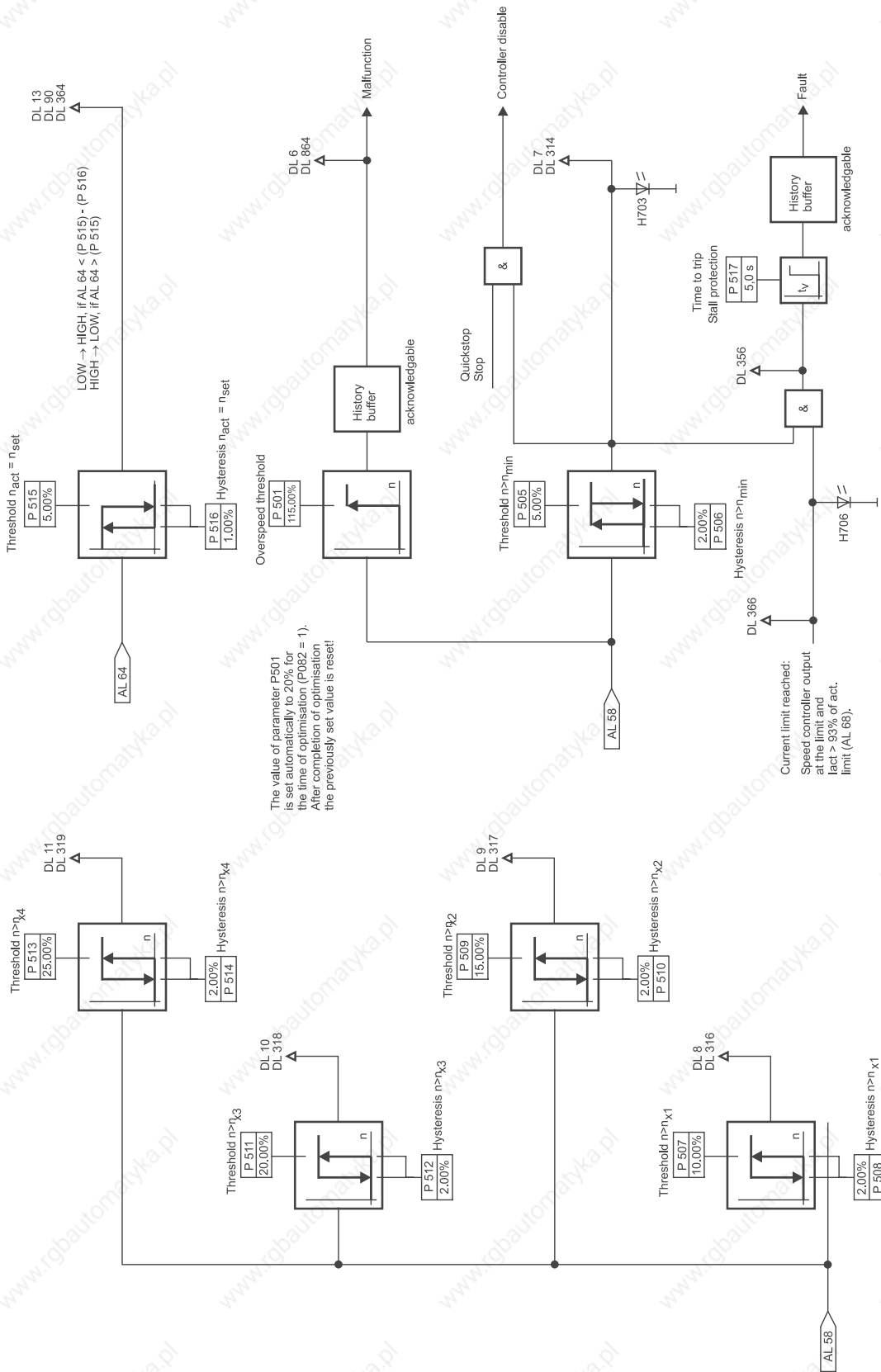

Illustration 62: Function diagram - Monitoring functions 1

5.4 Function diagrams

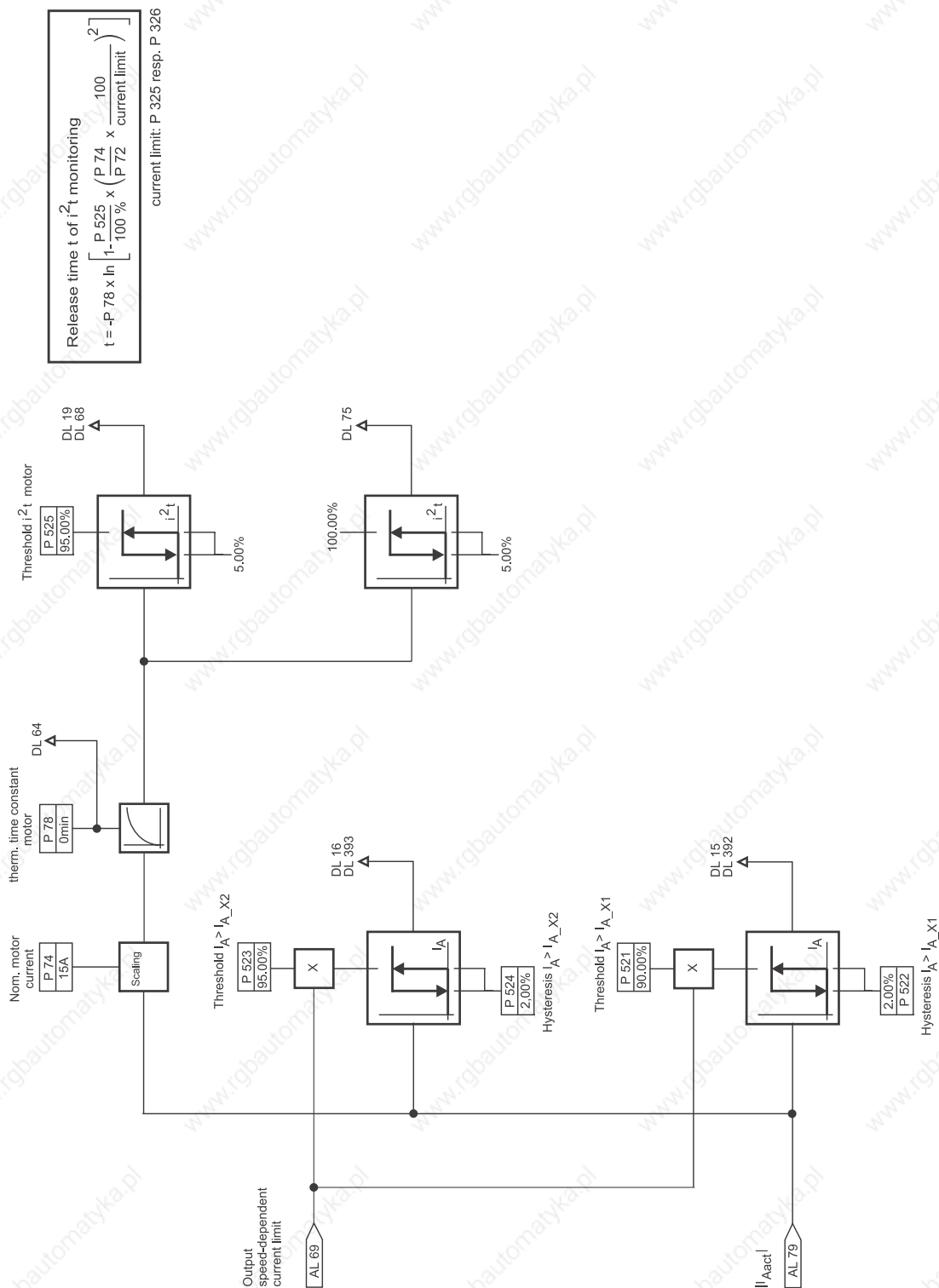

Illustration 63: Function diagram - Monitoring functions 3

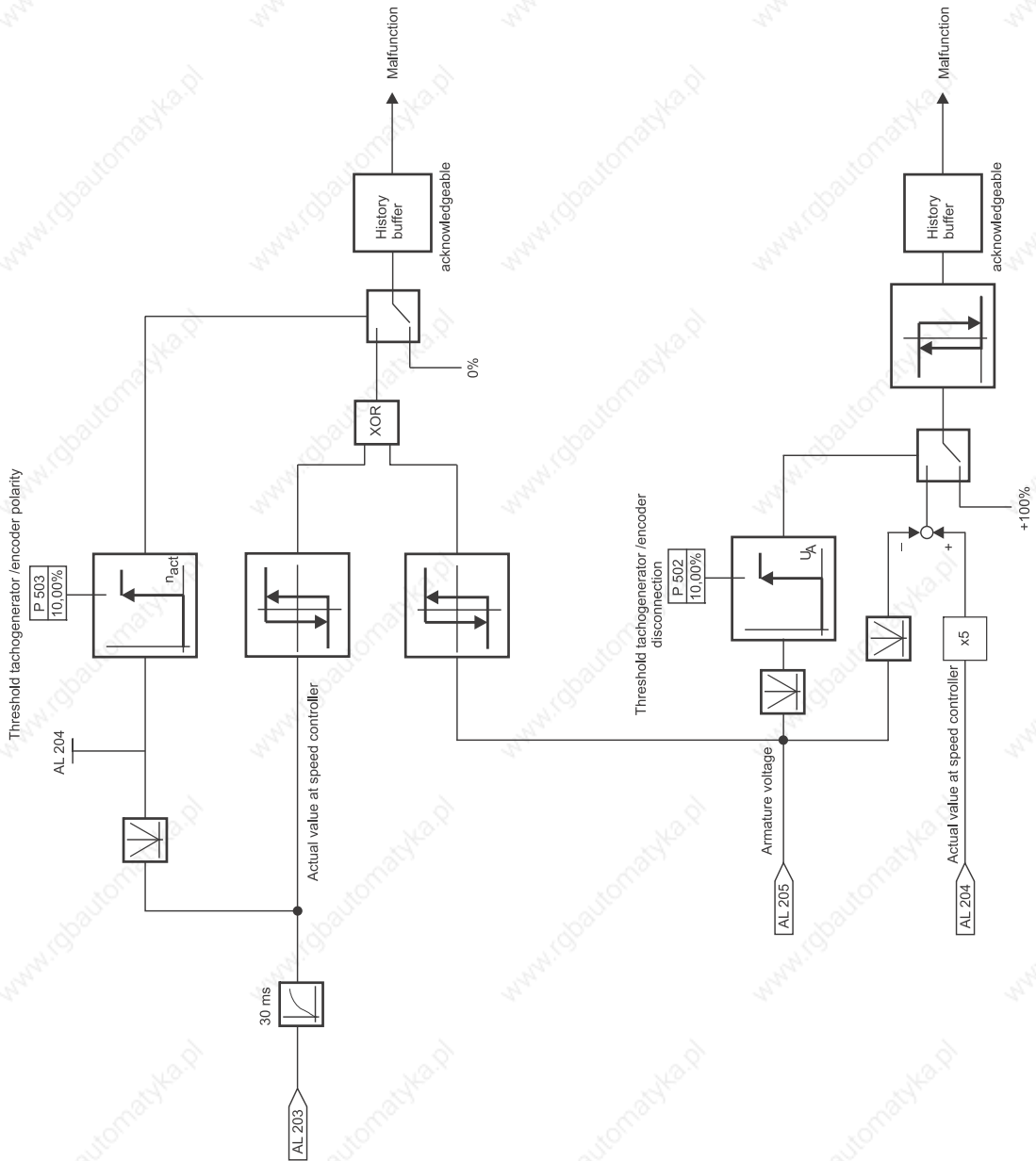

Illustration 64: Function diagram - Monitoring functions 4

5.4 Function diagrams

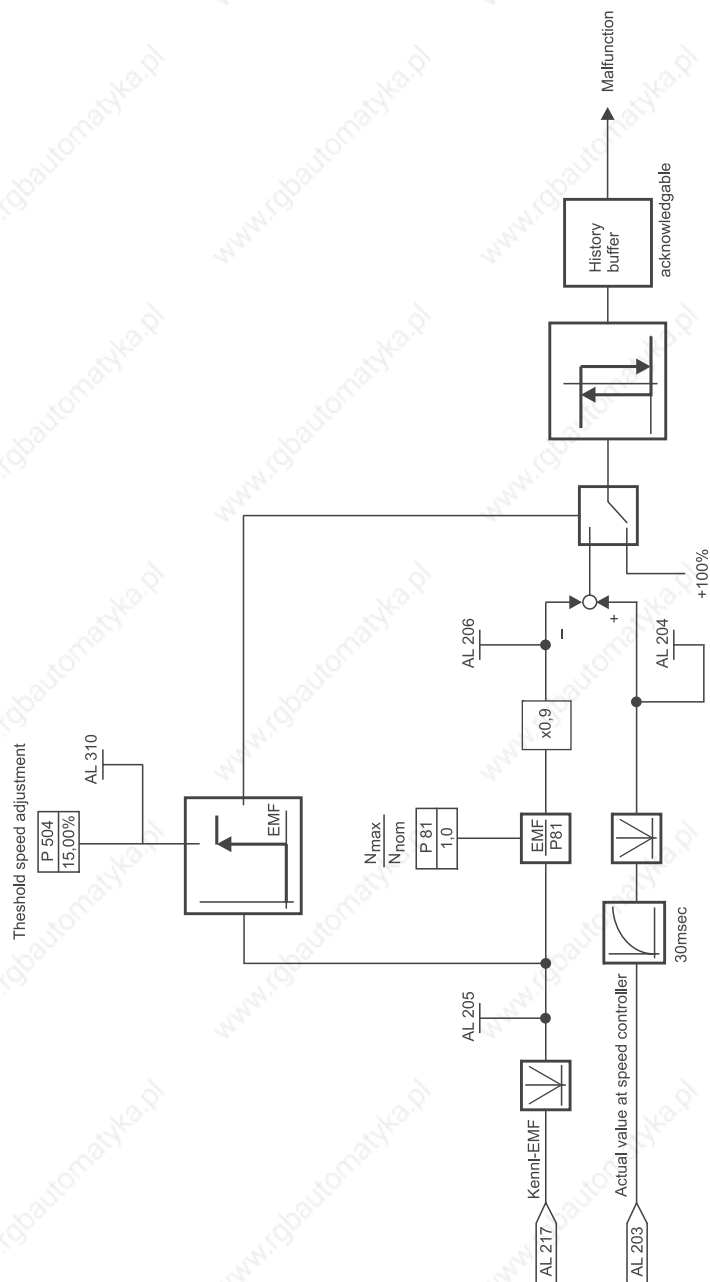

Illustration 65: Function diagram - Monitoring functions 5

5.5 Parameter list

When setting parameter values with the unit 'hex', the value must start with a leading 'h'.

CONVERTER DATA							
Parameter no.	Description	Default	Unit	Memory location	From software release	On- / offline	RW
1	Converter state		hex				R
2	Power unit type (1 = BKD / 4 = BKF)		Q				R
3	Rated current of power unit		A				R
4	Rated current of power unit rated, EEPROM		A	PD			R
5	Power unit peak current		A		3.20		R
6	Rated current of field power unit		A				R
7	Rated current of field power unit, EEPROM		A	PD			R
8							
9							

5.5 Parameter list

MEASURED VALUES							
Parameter no.	Description	Default	Unit	Memory location	From software release	On- / offline	R/W
10	Electronics supply (mains voltage)		Veff				R
11	Mains frequency		Hz				R
12	Rotating field (after main contactor ON)		-				R
13	Armature voltage		V				R
14	Armature voltage		%				R
15	Armature current		A				R
16	Armature current		%				R
17	ObjLst Index For internal use, inaccessible to the user and without any further significance		-				
18	ObjLst ObjNr. For internal use, inaccessible to the user and without any further significance		-				
19							
20	Power unit state		hex				R
21	Field current		A				R
22	Field current		%				R
23	Power input		%				R
24	Power output		%				R
25	Power unit temperature		°C				R
26							
27	Motor temperatur channel 1		°C		S 03.10		R
28	Motor temperatur channel 2		°C		S 03.10		R
29							
30	State motor i ² t		hex				R
31	Motor i ² t value		%				R

SERVICE PARAMETERS							
Parameter no.	Description	Default	Unit	Memory location	From software release	On- / offline	R/W
32	7S display ON and keypad enable		-			on	R/W
33							
34	Parameter selection Pxxx (7S display) (PC)		-			on	R/W
35	Software version		-				R
36	Converter software type		-				R
37	Error number		-				R
38	Number of errors		-				R
39	Warning number		-				R
40	Number of warnings		-				R
41							
42	Code, controller enables (on 7S display)		hex				R
43	Code, digital inputs (on 7S display)		hex				R
44	Code, digital outputs (on 7S display)		hex				R
45	Code, data records (on 7S display)		hex	PD			R
46	ALink selection for P 047	0	ALink	DR		on	R/W
47	Value of ALink (P 046)		-				R
48	ALink selection for P 049	0	ALink	DR		on	R/W
49	Value of ALink (P 048)		-				R
50	Speed setpoint (corresponds to ALink 51)		%				R
51	Actual speed (corresponds to ALink 59)		%				R
52							
53							
54							
55							
56							
57							

5.5 Parameter list

SERVICE PARAMETERS							
Parameter no.	Description	Default	Unit	Memory location	From software release	On- / offline	R/W
58							
59							
60							
61							
62							
63							
64							
65							
66							
67							
68							
69							

BASIC SETTINGS							
Parameter no.	Description	Default	Unit	Memory location	From software release	On- / offline	R/W
70	Electronics supply (mains voltage)	400	Veff	PD		off	R/W
71	Power unit supply (mains voltage)	400	Veff	PD		off	R/W
72	Maximum converter current	30	A	DR		off	R/W
73	Motor armature voltage BKD BKF	470 400	V	DR		off	R/W
74	Rated motor current NOTE: The default values must be replace by the values of the used motor, if you install a UL 508C-conform machine.	15	A	DR		off	R/W
75	Motor armature voltage drop $I_A \times R_A$	5.0	%	DR		on	R/W
76	Intermittent-current limit	30.0	%	DR		on	R/W
77	Motor inductance		mH	DR		on	R/W
78	Thermal time constant of the motor NOTE: The default values must be replace by the values of the used motor, if you install a UL 508C-conform machine.	0	min	DR		on	R/W
79	Rated field current	24.00	A	DR		on	R/W
80	Minimum field current of the motor	100	%	DR		on	R/W
81	Field weakening range (N_{Max} / N_{Rated})	1.0	-	DR		off	R/W
82	Optimisation (motor)	0	-			off	R/W
83							
84							
85							
86							
87							
88							
89							
90							
91							

5.5 Parameter list

BASIC SETTINGS							
Parameter no.	Description	Default	Unit	Memory location	From software release	On- / offline	R/W
92							
93							
94							
95							
96							
97							
98							
99							

OPERATING MODE SETTINGS							
Parameter no.	Description	Default	Unit	Memory location	From software release	On- / offline	R/W
100	Status word of current controller		hex				R
101	Control word (controller)		hex			on	R/W
102	Set operating mode	-3	-	DR		on	R/W
103	Actual operating mode		-				R
104	Function P 100: Bit 14		DLink	DR		on	R/W
105	Function P 100: Bit 15		DLink	DR		on	R/W
106	Error acknowledge mode	1	-	PD		on	R/W
107	Stop mode (main contactor - MC)	0	-	PD		off	R/W
108	Disable mode (controller disable - CD)	0	-	PD		off	R/W
109	Ramp-down time, disable/stop (CD/MC)	0.00	s	DR		on	R/W
110	Ramp-down time, quick stop (QS)	0.00	s	DR		on	R/W
111	General signal limit	100.00	%	DR		on	R/W
112	Evaluation power unit's temperature	0	-	PD	S 3.15	on	R/W
113							
114							
115							
116							
117							
118							
119							

5.5 Parameter list

COMMUNICATION							
Parameter no.	Description	Default	Unit	Memory location	From software release	On- / offline	R/W
120	Drive address (for USS connection)	0	-	PD		off	R/W
121	Communication source	0	hex	PD	S 3.12	on	R/W
122	Communication source monitoring	0	hex	PD	S 3.12	on	R/W
123	Monitoring period The value of parameter P 123 is transferred only at boot time. Any modification becomes effective only upon rebooting the converter (the new value must be stored before) ! Communication timeout monitoring with installed field bus option card.	0	ms	PD	S 3.12	on	R/W
124							
125	PC write authorisation (BASS)		-			on	R/W
126	Baud rate, PC (BASS)		Bit/s				R
127	Edit data record for PC (BASS)		-			on	R/W
128	PC state (BASS)		hex				
129							
130	USS state		hex				R
131	USS mode	0	hex	PD		on	R/W
132	Baud rate USS	9600	Bit/s	PD		on	R/W
133	Number of PIV elements (USS)	3	-	PD		on	R/W
134	Number of PCD elements (USS)	2	-	PD		on	R/W
135	Actual value 1 (USS)	59	ALink	PD		on	R/W
136	Actual value 2 (USS)	79	ALink	PD		on	R/W
137							
138							
139							
140	BAPS status		hex				R
141	BAPS master command word		hex				R
142	BAPS slave acknowledge		hex				R
143	BAPS state, parameter channel		hex				R

COMMUNICATION

Parameter no.	Description	Default	Unit	Memory location	From software release	On- / offline	R/W
144	Edit data record for BAPS	0	-		S 03.06	on	R/W
145							
146							
147							
148							
149							

5.5 Parameter list

DATA RECORD MANAGER							
Parameter no.	Description	Default	Unit	Memory location	From software release	On- / offline	R/W
150	State of data record manager		hex				R
151	Boot source	0	-	PD		on	R/W
152	Load data record		-			on	R/W
153	Save data record		-			on	R/W
154	Disable data record change	0	-	PD		on	R/W
155	Data record error		hex				R
156	Error in parameter Pxxx		-				R
157	Command of data record manager		-			on	R/W
158	Data record number		-			on	R/W
159	Active passwords		hex				
160	EEPROM programming cycles		-	PD			R
161	Article number		-				
162							
163							
164							
165							
166							
167							
168							
169							
170							
171							
172							
173							
174							
175							

DATA RECORD MANAGER							
Parameter no.	Description	Default	Unit	Memory location	From software release	On- / offline	R/W
176							
177							
178							
179							

5.5 Parameter list

ANALOG INPUTS							
Parameter no.	Description	Default	Unit	Memory location	From software release	On- / offline	R/W
180							
181	Control word (analog inputs)		hex			on	R/W
182	Function, analog input 1	1	-	PD		off	R/W
183	Scaling, analog input 1	1.000	-	DR		on	R/W
184	Offset; analog input 1	0.00	%	DR		on	R/W
185	Polarity, analog input 1	1	-	DR		on	R/W
186	Function, analog input 2	1	-	PD		off	R/W
187	Scaling, analog input 2	1.000	-	DR		on	R/W
188	Offset; analog input 2	0.00	%	DR		on	R/W
189	Polarity, analog input 2	1	-	DR		on	R/W
190	Scaling, analog input 3	1.000	-	DR		on	R/W
191	Offset; analog input 3	0.00	%	DR		on	R/W
192	Scaling, analog input 4	1.000	-	DR		on	R/W
193	Offset; analog input 4	0.00	%	DR		on	R/W

INTERNAL SETPOINTS							
Parameter no.	Description	Default	Unit	Memory location	From software release	On- / offline	R/W
194	Fixed setpoint 1	5.00	%	DR		on	R/W
195	Fixed setpoint 2	5.00	%	DR		on	R/W
196	Fixed setpoint 3	5.00	%	DR		on	R/W
197	Fixed setpoint 4	5.00	%	DR		on	R/W
198	Fixed setpoint 5	5.00	%	DR		on	R/W
199	Fixed setpoint 6	5.00	%	DR		on	R/W
200							
201	Generator, setpoint, 1 (internal setpoint generator)	5.00	%	DR		on	R/W
202	Generator, setpoint 2 (internal setpoint generator)	0.00	%	DR		on	R/W
203	Generator, time 1 (internal setpoint generator)	5.00	s	DR		on	R/W
204	Generator, time 2 (internal setpoint generator)	5.00	s	DR		on	R/W
205							
206							
207							
208							
209							

5.5 Parameter list

MOTORISED POTENTIOMETER							
Parameter no.	Description	Default	Unit	Memory location	From software release	On- / offline	R/W
210	Status word		hex				R
211	Control word		hex			on	R/W
212	Ramp-up time	10.0	s	DR		on	R/W
213	Upper limit	100.00	%	DR		on	R/W
214	Ramp-down time	10.0	s	DR		on	R/W
215	Lower limit	0.00	%	DR		on	R/W
216	Correction ON/OFF	1	-	PD		on	R/W
217	Selection, correction signal	59	ALink	PD		on	R/W
218	Selection, control signal for correction	23	DLink	PD	S 03.06	on	R/W
219							

RAMP GENERATOR A							
Parameter no.	Description	Default	Unit	Memory location	From software release	On- / offline	R/W
220	Status word		hex				R
221	Control word		hex			on	R/W
222	Setpoint selection, input 1	26	ALink	DR		on	R/W
223	Setpoint selection, input 2	0	ALink	DR		on	R/W
224	Setpoint selection, input 3	0	ALink	DR		on	R/W
225	Setpoint selection, input 4	0	ALink	DR		on	R/W
226	Ramp-up time 1	2.00	s	DR		on	R/W
227	Initial rounding 1, ramp-up	0.00	s	DR		on	R/W
228	Final rounding 1, ramp-up	0.00	s	DR		on	R/W
229	Ramp-down time 1	2.00	s	DR		on	R/W
230	Initial rounding 1, ramp-down	0.00	s	DR		on	R/W
231	Final rounding 1, ramp-down	0.00	s	DR		on	R/W
232	Ramp-up time 2	2.00	s	DR		on	R/W
233	Initial rounding 2, ramp-up	0.00	s	DR		on	R/W
234	Final rounding 2, ramp-up	0.00	s	DR		on	R/W
235	Ramp-down time 2	2.00	s	DR		on	R/W
236	Initial rounding 2, ramp-down	0.00	s	DR		on	R/W
237	Final rounding 2, ramp-down	0.00	s	DR		on	R/W
238	Correction ON/OFF	1	-	PD		on	R/W
239	Selection, correction signal	59	ALink	PD		on	R/W
240							
241							
242							
243							
244							

5.5 Parameter list

RAMP GENERATOR B							
Parameter no.	Description	Default	Unit	Memory location	From software release	On- / offline	R/W
245	Setpoint selection	0	ALink	DR		on	R/W
246	Ramp-up time	2.00	s	DR		on	R/W
247	Ramp-down time	2.00	s	DR		on	R/W
248							
249							

SPEED CONTROLLER ACTUAL VALUES							
Parameter no.	Description	Default	Unit	Memory location	From software release	On- / offline	R/W
250	Status word		hex				R
251							
252							
253							
254							
255	Selection of actual value and field unit setting	1	-	DR		off	R/W
256	Armature voltage adjustment	1.00	-	DR		on	R/W
257	Tachogenerator range	1	-	DR		off	R/W
258	Tachogenerator voltage	10.00	V	DR		on	R/W
259	Tachogenerator polarity change	1		DR	3.20	off	R/W
260	Status word of incremental encoder		hex				R
261	Increments of incremental encoder 1	1024	-	PD		off	R/W
262	Max. speed, incremental encoder 1	500	min ⁻¹	DR		on	R/W
263	Polarity reversal of incremental encoder 1	1	-	PD		off	R/W
264							
265							
266							
267	Speed offset (for the actual value at the speed controller)	0	-	DR		on	R/W
268	Actual speed smoothing	10	ms	DR		on	R/W
269	Derivative-action time (actual value D component)	10	ms	DR		on	R/W
270	Factor, D component	0.0	-	DR		on	R/W
271							
272							
273							
274							
275							

5.5 Parameter list

SPEED CONTROLLER ACTUAL VALUES							
Parameter no.	Description	Default	Unit	Memory location	From software release	On- / offline	R/W
276							
277							
278							
279							
280							
281							
282							
283							
284							
285							
286							
287							
288							
289							
290							
291							
292							
293							
294							
295							
296							
297							
298							
299							

SPEED CONTROLLER SETPOINTS							
Parameter no.	Description	Default	Unit	Storage location	From software release	On- / offline	R/W
300	Status		hex				R
301	Control word		hex			on	R/W
302	Controller type	11	hex	DR		on	R/W
303							
304							
305	Setpoint selection, input 1	44	ALink	DR		on	R/W
306	Setpoint selection, input 2	0	ALink	DR		on	R/W
307	Setpoint selection, input 3	0	ALink	DR		on	R/W
308	Setpoint selection, input 4	0	ALink	DR		on	R/W
309							

5.5 Parameter list

SPEED CONTROLLER PARAMETER SETS							
Parameter no.	Description	Default	Unit	Memory location	From software release	On- / offline	R/W
310	P-gain K_P 1	5.00	-	DR		on	R/W
311	P-gain K_P 2	5.00	-	DR		on	R/W
312	Threshold, P-gain K_P 1	100.00	%	DR		on	R/W
313	Threshold, P-gain K_P 2	100.00	%	DR		on	R/W
314	Adaptation signal K_P	59	ALink	DR		on	R/W
315	Integral-action time T_{n1}	0,400	s	DR		on	R/W
316	Integral-action time T_{n2}	0,400	s	DR		on	R/W
317	Threshold, integral-action time T_{n1}	100.00	%	DR		on	R/W
318	Threshold, integral-action time T_{n2}	100.00	%	DR		on	R/W
319	Adaptation signal T_n	59	ALink	DR		on	R/W
320							
321	Preset integral component - set TD	0.00	%	DR		on	R/W
322	Drift lock	0	-	DR		on	R/W
323	Drift lock, actual-value threshold	1.00	%	DR		on	R/W
324	Drift lock, setpoint threshold	1.00	%	DR		on	R/W

CURRENT LIMITS							
Parameter no.	Description	Default	Unit	Memory location	From software release	On- / offline	R/W
325	Current limit TD1 (positive)	100.00	%	DR		on	R/W
326	Current limit TD2 (negative)	-100.00	%	DR		on	R/W
327							
328	External current limit TD1	1	ALink	DR		on	R/W
329	External current limit TD2	2	ALink	DR		on	R/W
330	Threshold, speed-dependent limit n_x	100.00	%	DR		on	R/W
331	Current limit at n_{max} (I_{end})	100.00	%	DR		on	R/W
332	Ramp, gear protection (ramp-up/down time)	0	ms	DR		on	R/W
333	Hysteresis, TD indicator	2.50	%	DR		on	R/W
334	Zero-current delay (for torque change, BKF)	0	ms	DR		on	R/W
335	Additional current setpoint 1	0	ALink	DR	S 03.06	on	R/W
336	Additional current setpoint 2	0	ALink	DR	S 03.06	on	R/W
337	Additional current setpoint 3	0	ALink	DR	S 03.06	on	R/W
338	Additional current setpoint 4	0	ALink	DR	S 03.06	on	R/W
339							
340							
341							
342							
343							
344							
345							
346							
347							
348							
349							

5.5 Parameter list

CURRENT CONTROLLER							
Parameter no.	Description	Default	Unit	Memory location	From software release	On- / offline	R/W
350	Status (armature current controller)		hex				R
351							
352	Controller type	11	hex	DR		on	R/W
353	P-gain K_P	0.05	-	DR		on	R/W
354	Integral-action time T_n	0.020	s	DR		on	R/W
355							
356							
357	Current setpoint, integrator	0	ms	DR		on	R/W
358							
359	Current precontrol ON/OFF	1	-	PD		off	R/W
360	Rectifier firing angle limit (α_G armature BKD/BKF)	10 / 30	°el	DR		on	R/W
361	Inverter firing angle limit (α_W armature)	150	°el	DR		on	R/W
362	di_{Set}/dt Precontrol ON/OFF	1		DR		on	R/W
363							
364							
365							
366							
367							
368							
369							

FIELD UNIT							
Parameter no.	Description	Default	Unit	Memory location	From software release	On- / offline	R/W
370	Status word		hex				R
371							
372	Field unit ON/OFF	1	-	DR		off	R/W
373	EMF controller - controller type	11	hex	DR		on	R/W
374	Field EMF controller - P-gain K_P	1.00	-	DR		on	R/W
375	Field EMF controller - integral-action time T_n	0.200	s	DR		on	R/W
376							
377	Field current controller - controller type	11	hex	DR		on	R/W
378	Field current controller - P-gain K_P	1.00	-	DR		on	R/W
379	Current controller - integral-action time T_n	0.200	s	DR		on	R/W
380							
381	Rectifier firing angle limit (α_G field)	15	°el	DR		on	R/W
382	Inverter firing angle limit (α_W field)	150	°el	DR		on	R/W
383	Field current setpoint for standstill field	100	%	DR		on	R/W
384	Delay to standstill field ON	30	s	DR		on	R/W
385	Field current monitoring delay	1	s	DR		on	R/W
386	Field monitoring ON/OFF	1	-	DR		on	R/W
387							
388							
389							
390							
391							
392							
393							
394							
395							

5.5 Parameter list

FIELD UNIT							
Parameter no.	Description	Default	Unit	Memory location	From software release	On- / offline	RW
396							
397							
398							
399							

DIGITAL INPUTS							
Parameter no.	Description	Default	Unit	Memory location	From software release	On- / offline	R/W
400	Status word (digital inputs)		hex				R
401	Function, digital input 1 (X2: 19)	7	-	PD		off	R/W
402	Function, digital input 2 (X2: 20)	0	-	PD		off	R/W
403	Function, digital input 3 (X2: 21)	0	-	PD		off	R/W
404	Function, digital input 4 (X2: 22)	0	-	PD		off	R/W
405	Function, digital input 5 (X2: 23)	0	-	PD		off	R/W
406	Function, digital input 6 (X2: 24)	0	-	PD		off	R/W
407	Function, digital input 7 (X2: 25)	0	-	PD		off	R/W
408	Function, digital input 8 (X2: 26)	0	-	PD		off	R/W

5.5 Parameter list

DIGITAL INPUT MULTIPLIERS							
Parameter no.	Description	Default	Unit	Memory location	From software release	On- / offline	R/W
409	Function, multiplier 1.1 (multiplier 1, output 1)	0		PD		off	R/W
410	Function, multiplier 1.2 (multiplier 1, output 2)	0		PD		off	R/W
411	Function, multiplier 1.3 (multiplier 1, output 3)	0		PD		off	R/W
412	Function, multiplier 1.4 (multiplier 1, output 4)	0		PD		off	R/W
413	Function, multiplier 2.1 (multiplier 2, output 1)	0		PD		off	R/W
414	Function, multiplier 2.2 (multiplier 2, output 2)	0		PD		off	R/W
415	Function, multiplier 2.3 (multiplier 2, output 3)	0		PD		off	R/W
416	Function, multiplier 2.4 (multiplier 2, output 4)	0		PD		off	R/W
417							
418							
419							

DIGITAL OUTPUTS							
Parameter no.	Description	Default	Unit	Memory location	From software release	On- / offline	R/W
420	Status word (digital outputs)		hex				R
421	Function, digital output 1	4	DLink	DR		on	R/W
422	ON delay, digital output 1	0.00	s	DR		on	R/W
423	OFF delay, digital output 1	0.00	s	DR		on	R/W
424	Polarity, digital output 1	1	-	DR		on	R/W
425	Function, digital output 2	0	DLink	DR		on	R/W
426	ON delay, digital output 2	0.00	s	DR		on	R/W
427	OFF delay, digital output 2	0.00	s	DR		on	R/W
428	Polarity, digital output 2	1	-	DR		on	R/W
429	Function, digital output 3	0	DLink	DR		on	R/W
430	ON delay, digital output 3	0.00	s	DR		on	R/W
431	OFF delay, digital output 3	0.00	s	DR		on	R/W
432	Polarity, digital output 3	1	-	DR		on	R/W
433	Function, digital output 4	0	DLink	DR		on	R/W
434	ON delay, digital output 4	0.00	s	DR		on	R/W
435	OFF delay, digital output 4	0.00	s	DR		on	R/W
436	Polarity, digital output 4	1	-	DR		on	R/W
437	Function, digital output 5	0	DLink	DR		on	R/W
438	ON delay, digital output 5	0.00	s	DR		on	R/W
439	OFF delay, digital output 5	0.00	s	DR		on	R/W
440	Polarity, digital output 5	1	-	DR		on	R/W
441	Function, digital output 6	0	DLink	DR		on	R/W
442	ON delay, digital output 6	0.00	s	DR		on	R/W
443	OFF delay, digital output 6	0.00	s	DR		on	R/W
444	Polarity, digital output 6	1	-	DR		on	R/W
445							

5.5 Parameter list

DIGITAL OUTPUTS							
Parameter no.	Description	Default	Unit	Memory location	From software release	On- / offline	R/W
446							
447							
448							
449							
450							
451							
452							
453							
454							
455							
456							
457							
458							
459							

ANALOG OUTPUTS							
Parameter no.	Description	Default	Unit	Memory location	From software release	On- / offline	R/W
460	Status word		hex				R
461	Signal selection, analog output 1	26	ALink	DR		on	R/W
462	Offset, analog output 1	0.00	%	DR		on	R/W
463	Scaling, analog output 1	1.000	-	DR		on	R/W
464	Filtering, analog output 1	0	ms	DR		on	R/W
465	Polarity, analog output 1	1	-	DR		on	R/W
466	Signal selection, analog output 2	43	ALink	DR		on	R/W
467	Offset, analog output 2	0.00	%	DR		on	R/W
468	Scaling, analog output 2	1.000	-	DR		on	R/W
469	Filtering, analog output 2	0	ms	DR		on	R/W
470	Polarity, analog output 2	1	-	DR		on	R/W
471	Signal selection, analog output 3	51	ALink	DR		on	R/W
472	Offset, analog output 3	0.00	%	DR		on	R/W
473	Scaling, analog output 3	1.000	-	DR		on	R/W
474	Filtering, analog output 3	0	ms	DR		on	R/W
475	Polarity, analog output 3	1	-	DR		on	R/W
476	Signal selection, analog output 4	59	ALink	DR		on	R/W
477	Offset, analog output 4	0.00	%	DR		on	R/W
478	Scaling, analog output 4	1.000	-	DR		on	R/W
479	Filtering, analog output 4	0	ms	DR		on	R/W
480	Polarity, analog output 4	1	-	DR		on	R/W
481							
482							
483							
484							
485							

5.5 Parameter list

ANALOG OUTPUTS							
Parameter no.	Description	Default	Unit	Memory location	From software release	On- / offline	R/W
486							
487							
488							
489							
490							
491							
492							
493							
494							
495							
496							
497							
498							
499							

MONITORING FUNCTIONS							
Parameter no.	Description	Default	Unit	Memory location	From software release	On- / offline	R/W
501	Threshold, overspeed monitoring	115.00	%	DR		on	R/W
502	Threshold, tachogenerator/encoder failure	10.00	%	DR		on	R/W
503	Threshold, tachogenerator/encoder polarity	10.00	%	DR		on	R/W
504	Threshold, speed adjustment	15.00	%	DR		on	R/W
505	Threshold $n > n_{\min}$	5.00	%	DR		on	R/W
506	Hysteresis $n > n_{\min}$	2.00	%	DR		on	R/W
507	Threshold $n > n_{x1}$	10.00	%	DR		on	R/W
508	Hysteresis $n > n_{x1}$	2.00	%	DR		on	R/W
509	Threshold $n > n_{x2}$	15.00	%	DR		on	R/W
510	Hysteresis $n > n_{x2}$	2.00	%	DR		on	R/W
511	Threshold $n > n_{x3}$	20.00	%	DR		on	R/W
512	Hysteresis $n > n_{x3}$	2.00	%	DR		on	R/W
513	Threshold $n > n_{x4}$	25.00	%	DR		on	R/W
514	Hysteresis $n > n_{x4}$	2.00	%	DR		on	R/W
515	Threshold $n_{\text{Actual}} = n_{\text{Set}}$ (at speed controller)	5.00	%	DR		on	R/W
516	Hysteresis $n_{\text{Actual}} = n_{\text{Set}}$ (at speed controller)	1.00	%	DR		on	R/W
517	Stall protection, time to trip	5.0	s	DR		on	R/W
518	Maximum torque reversal time	0.2	s	PD		on	R/W
519	'Armature-circuit-open' time to trip	1.0	s	DR		on	R/W
520							
521	Threshold $I_A > I_{A_X1}$	90.00	%	DR		on	R/W
522	Hysteresis $I_A > I_{A_X1}$	2.00	%	DR		on	R/W
523	Threshold $I_A > I_{A_X2}$	95.00	%	DR		on	R/W
524	Hysteresis $I_A > I_{A_X2}$	2.00	%	DR		on	R/W
525	Threshold, motor i^2t monitoring	100	%	DR		on	R/W

5.5 Parameter list

MONITORING FUNCTIONS							
Parameter no.	Description	Default	Unit	Memory location	From software release	On- / offline	R/W
526	Maximum line stabilisation time	0.5	s	PD		on	R/W
527	Maximum time to restart (after mains failure)	0.0	s	PD		on	R/W
528	Frequency threshold	65,0	Hz	DR	S 03.10	on	R/W
529							
530							
531							
532							
533							
534							
535	Tachogenerator/encoder failure monitoring ON/OFF	1	-	DR	S 03.06	on	R/W
536	Tachogenerator/encoder polarity monitoring ON/OFF	1	-	DR	S 03.06	on	R/W
537	Speed adjustment monitoring ON/OFF	1	-	DR	S 03.06	on	R/W
538							
539							
540	Status word motor temperature		hex		S 03.10		R
541	Temperature monitoring channel 1 ON/OFF			DR	S 03.10	on	R/W
542	Warning temperature channel 1	+ 80	°C	DR	S 03.10	on	R/W
543	Shut down temperature channel 1	+ 80	°C	DR	S 03.10	on	R/W
544	Temperature monitoring channel 2 ON/OFF			DR	S 03.10	on	R/W
545	Warning temperature channel 2	+ 80	°C	DR	S 03.10	on	R/W
546	Shut down temperature channel 2	+ 80	°C	DR	S 03.10	on	R/W
547	Message threshold motor temperatur channel 1	+ 80	°C	DR	S 03.20	on	R/W
548	Message threshold motor temperatur channel 2	+ 80	°C	DR	S 03.20	on	R/W
549							

UNASSIGNED PI CONTROLLER							
Parameter no.	Description	Default	Unit	Memory location	From software release	On- / offline	R/W
550	Setpoint selection, input 1 (unass. PI controller)	0	ALink	DR		on	R/W
551	Setpoint selection, input 2	0	ALink	DR		on	R/W
552	Setpoint selection, input 3	0	ALink	DR		on	R/W
553	Setpoint selection, input 4	0	ALink	DR		on	R/W
554	Actual-value selection	0	ALink	DR		on	R/W
555	Actual-value smoothing	0	ms	DR		on	R/W
556	Actual-value derivative-action time (derivative-action element)	10	ms	DR		on	R/W
557	Factor of D component	0.0	-	DR		on	R/W
558							
559							
560	Status word		hex				R
561	Control word		hex			on	R/W
562	Controller type	11	hex	DR		on	R/W
563	P-gain K_P 1	10.00	-	DR		on	R/W
564	P-gain K_P 2	10.00	-	DR		on	R/W
565	Threshold, P-gain K_P 1	100.00	%	DR		on	R/W
566	Threshold, P-gain K_P 2	100.00	%	DR		on	R/W
567	Adaptation signal, proportional gain K_P	0	ALink	DR		on	R/W
568	Integral-action time T_{n1}	0,400	s	DR		on	R/W
569	Integral-action time T_{n2}	0,400	s	DR		on	R/W
570	Threshold for Integral-action time T_{n1}	100.00	%	DR		on	R/W
571	Threshold for Integral-action time T_{n2}	100.00	%	DR		on	R/W
572	Signal selection, integral-action time T_n	0	ALink	DR		on	R/W
573							
574	Preset I component	0.00	%	DR		on	R/W

5.5 Parameter list

UNASSIGNED PI CONTROLLER							
Parameter no.	Description	Default	Unit	Memory location	From software release	On- / offline	R/W
575	Positive limit for I component	100.00	%	DR		on	R/W
576	Negative limit for I component	-100.00	%	DR		on	R/W
577	Positive limit for controller output	100.00	%	DR		on	R/W
578	Negative limit for controller output	-100.00	%	DR		on	R/W
579	Enable mode	1	-	PD		on	R/W
580							
581							
582							
583							
584							
585							
586							
587							
588							
589							
590							
591							
592							
593							
594							
595							
596							
597							
598							
599							

UNASSIGNED FUNCTION BLOCKS							
Parameter no.	Description	Default	Unit	Memory location	From software release	On- / offline	R/W
600	Status word		hex				R
601	Control word		hex			on	R/W
602	Input signal A at unassigned adder 1	0	ALink	DR		on	R/W
603	Input signal B at unassigned adder 1	0	ALink	DR		on	R/W
604	Input signal C at unassigned adder 1	0	ALink	DR		on	R/W
605	Input signal D at unassigned adder 1	0	ALink	DR		on	R/W
606	Input signal A at unassigned adder 2	0	ALink	DR		on	R/W
607	Input signal B at unassigned adder 2	0	ALink	DR		on	R/W
608	Input signal C at unassigned adder 2	0	ALink	DR		on	R/W
609	Input signal D at unassigned adder 2	0	ALink	DR		on	R/W
610	Input signal A at unassigned adder 3	0	ALink	DR		on	R/W
611	Input signal B at unassigned adder 3	0	ALink	DR		on	R/W
612	Input signal C at unassigned adder 3	0	ALink	DR		on	R/W
613	Input signal D at unassigned adder 3	0	ALink	DR		on	R/W
614	Input signal A at unassigned adder 4	0	ALink	DR		on	R/W
615	Input signal B at unassigned adder 4	0	ALink	DR		on	R/W
616	Input signal C at unassigned adder 4	0	ALink	DR		on	R/W
617	Input signal D at unassigned adder 4	0	ALink	DR		on	R/W
618	Input signal A at unassigned multiplier 1	0	ALink	DR		on	R/W
619	Input signal B at unassigned multiplier 1	0	ALink	DR		on	R/W
620	Input signal C at unassigned multiplier 1	0	ALink	DR		on	R/W
621	Input signal D at unassigned multiplier 1	0	ALink	DR		on	R/W
622	Input signal A at unassigned multiplier 2	0	ALink	DR		on	R/W
623	Input signal B at unassigned multiplier 2	0	ALink	DR		on	R/W
624	Input signal C at unassigned multiplier 2	0	ALink	DR		on	R/W
625	Input signal D at unassigned multiplier 2	0	ALink	DR		on	R/W

5.5 Parameter list

UNASSIGNED FUNCTION BLOCKS							
Parameter no.	Description	Default	Unit	Memory location	From software release	On- / offline	R/W
626	Input signal A at unassigned divider 1	0	ALink	DR		on	R/W
627	Input signal B at unassigned divider 1	0	ALink	DR		on	R/W
628	Input signal C at unassigned divider 1	0	ALink	DR		on	R/W
629	Input signal D at unassigned divider 1	0	ALink	DR		on	R/W
630	Input signal A at unassigned divider 2	0	ALink	DR		on	R/W
631	Input signal B at unassigned divider 2	0	ALink	DR		on	R/W
632	Input signal C at unassigned divider 2	0	ALink	DR		on	R/W
633	Input signal D at unassigned divider 2	0	ALink	DR		on	R/W
634	Input selection multiplier 1	0	ALink	DR	S 03.10	on	R/W
635	Factor multiplier 1	1,00		DR	S 03.10	on	R/W
636	Input selection multiplier 2	0	ALink	DR	S 03.10	on	R/W
637	Factor multiplier 2	1,00		DR	S 03.10	on	R/W
638	Input selection multiplier 3	0	ALink	DR	S 03.10	on	R/W
639	Factor multiplier 3	1,00		DR	S 03.10	on	R/W
640							
641							
642							
643							
644	Input, minimum value limiter	0	ALink	DR		on	R/W
645	Threshold, minimum value limiter	0.00	%	DR		on	R/W
646	Input signal formatter	0	ALink	DR		on	R/W
647	X value of input signal formatter	50.00	%	DR		on	R/W
648	Y value of input signal formatter	50.00	%	DR		on	R/W
649	Final value of input signal formatter	100.00	%	DR		on	R/W
650	Input, absolute value generator 1	0	ALink	DR		on	R/W
651	Input, absolute value generator 2	0	ALink	DR		on	R/W
652	Input, absolute value generator 3	0	ALink	DR		on	R/W

UNASSIGNED FUNCTION BLOCKS							
Parameter no.	Description	Default	Unit	Memory location	From software release	On- / offline	R/W
653	Input, absolute value generator 4	0	ALink	DR		on	R/W
654	Input, inverter 1	0	ALink	DR		on	R/W
655	Input, inverter 2	0	ALink	DR		on	R/W
656	Input, limiter	0	ALink	DR		on	R/W
657	Positive limit, limiter	0.00	%	DR		on	R/W
658	Negative limit, limiter	0.00	%	DR		on	R/W
659	Input, dead band	0	ALink	DR		on	R/W
660	Positive threshold, dead band	0.00	%	DR		on	R/W
661	Negative threshold, dead band	0.00	%	DR		on	R/W
662	Input, filter 1	0	ALink	DR		on	R/W
663	Time constant, filter 1	10	ms	DR		on	R/W
664	Input selection, filter 2	0	ALink	DR		on	R/W
665	Time constant, filter 2	10	ms	DR		on	R/W
666	Input A, changeover switch 1	0	ALink	DR		on	R/W
667	Input B, changeover switch 1	0	ALink	DR		on	R/W
668	Input A, changeover switch 2	0	ALink	DR		on	R/W
669	Input B, changeover switch 2	0	ALink	DR		on	R/W
670	Input C, changeover switch 2	0	ALink	DR		on	R/W
671	Input A, changeover switch 3	0	ALink	DR		on	R/W
672	Input B, changeover switch 3	0	ALink	DR		on	R/W
673	Scaling, input B, changeover switch 3	1,000	-	DR		on	R/W
674	Input, changeover switch 4	0	ALink	DR		on	R/W
675	Scaling, changeover switch 4	1,000	-	DR		on	R/W
676	Input A, comparator	1	ALink	DR		on	R/W
677	Input B, comparator	0	ALink	DR		on	R/W
678	Threshold, comparator	5.00	%	DR		on	R/W
679	Hysteresis, comparator	2.00	%	DR		on	R/W

5.5 Parameter list

UNASSIGNED FUNCTION BLOCKS							
Parameter no.	Description	Default	Unit	Memory location	From software release	On- / offline	R/W
680	DLink selection for P 681	0	DLink	DR		on	R/W
681	Value of selected DLink	0	-				R
682	Input ALink/DLink converter 1	0	ALink	DR		on	R/W
683	Input ALink/DLink converter 2	0	ALink	DR		on	R/W
684	Set source parameter 1 for DLink 44/45	0	-	DR		on	R/W
685	Bit mask for source parameter 1	0	hex	DR		on	R/W
686	Bit pattern for source parameter 1	0	hex	DR		on	R/W
687	Set source parameter 2 for DLink 46/47	0	-	DR		on	R/W
688	Bit mask for source parameter 2	0	hex	DR		on	R/W
689	Bit pattern for source parameter 2	0	hex	DR		on	R/W
690	DLink x writing target parameter (P 691)	0	DLink	DR		on	R/W
691	Target parameter, DLink x (P690)	0	-	DR		on	R/W
692	Write mask for target parameter (P691)	0	hex	DR		on	R/W
693	Write pattern at DLink x: HIGH (P691)	0	hex	DR		on	R/W
694	Write pattern at DLink x: LOW (P691)	0	hex	DR		on	R/W
695	DLink x writing target parameter (P 696)	0	DLink	DR		on	R/W
696	Target parameter, DLink x (P695)	0	-	DR		on	R/W
697	Write mask for target parameter (P696)	0	hex	DR		on	R/W
698	Write pattern at DLink x: HIGH (P696)	0	hex	DR		on	R/W
699	Write pattern at DLink x: LOW (P696)	0	hex	DR		on	R/W

UNASSIGNED DIGITAL FUNCTIONS - DLINK FUNCTIONS							
Parameter no.	Description	Default	Unit	Memory location	From software release	On- / offline	R/W
700							
701							
702	Input at unassigned digital inverter 1	0	DLink	DR		on	R/W
703	Delay time for unassigned digital inverter 1	0.00	s	DR		on	R/W
704	Input selection at unassigned digital inverter 2	0	DLink	DR		on	R/W
705	Delay time for unassigned digital inverter 2	0.00	s	DR		on	R/W
706	Input selection at unassigned digital inverter 3	0	DLink	DR		on	R/W
707	Delay time for unassigned digital inverter 3	0.00	s	DR		on	R/W
708	Input selection at unassigned digital inverter 4	0	DLink	DR		on	R/W
709	Delay time for unassigned digital inverter 4	0.00	s	DR		on	R/W
710	Function, gate 1 (AND/OR/XOR)	0	-	DR		on	R/W
711	Input A, gate 1	0	DLink	DR		on	R/W
712	Input B, gate 1	0	DLink	DR		on	R/W
713	Input C, gate 1	0	DLink	DR		on	R/W
714	Input D, gate 1	0	DLink	DR		on	R/W
715	Function, gate 2 (AND/OR/XOR)	0		DR		on	R/W
716	Input A, gate 2	0	DLink	DR		on	R/W
717	Input B, gate 2	0	DLink	DR		on	R/W
718	Input C, gate 2	0	DLink	DR		on	R/W
719	Input D, gate 2	0	DLink	DR		on	R/W
720	Function, gate 3 (AND/OR/XOR)	0		DR		on	R/W
721	Input A, gate 3	0	DLink	DR		on	R/W
722	Input B, gate 3	0	DLink	DR		on	R/W
723	Input C, gate 3	0	DLink	DR		on	R/W
724	Input D, gate 3	0	DLink	DR		on	R/W
725	Function, gate 4 (AND/OR/XOR)	0		DR		on	R/W

5.5 Parameter list

UNASSIGNED DIGITAL FUNCTIONS - DLINK FUNCTIONS							
Parameter no.	Description	Default	Unit	Memory location	From software release	On- / offline	R/W
726	Input A, gate 4	0	DLink	DR		on	R/W
727	Input B, gate 4	0	DLink	DR		on	R/W
728	Input C, gate 4	0	DLink	DR		on	R/W
729	Input D, gate 4	0	DLink	DR		on	R/W
730	DLink selection for freely definable error	0	DLink	DR	S 03.15	on	R/W
731							
732							
733							
734							
735							
736							
737							
738							
739							
740	DLink x writing target parameter (P741)	0	DLink	DR	S 03.20	on	R/W
741	Target parameter, DLink x (P740)	0	PNr	DR	S 03.20	on	R/W
742	Write mask for target parameter (P741)	0	hex	DR	S 03.20	on	R/W
743	Write pattern at DLink x: HIGH (P741)	0	hex	DR	S 03.20	on	R/W
744	Write pattern at DLink x: LOW (P741)	0	hex	DR	S 03.20	on	R/W
745	DLink x writing target parameter (P746)	0	DLink	DR	S 03.20	on	R/W
746	Target parameter, DLink x (P745)	0	PNr	DR	S 03.20	on	R/W
747	Write mask for target parameter (P746)	0	hex	DR	S 03.20	on	R/W
748	Write pattern at DLink x: HIGH (P746)	0	hex	DR	S 03.20	on	R/W
749	Write pattern at DLink x: LOW (P746)	0	hex	DR	S 03.20	on	R/W
750	DLink x writing target parameter (P751)	0	DLink	DR	S 03.20	on	R/W
751	Target parameter, DLink x (P750)	0	PNr	DR	S 03.20	on	R/W
752	Write mask for target parameter (P751)	0	hex	DR	S 03.20	on	R/W

UNASSIGNED DIGITAL FUNCTIONS - DLINK FUNCTIONS							
Parameter no.	Description	Default	Unit	Memory location	From software release	On- / offline	R/W
753	Write pattern at DLink x: HIGH (P751)	0	hex	DR	S 03.20	on	R/W
754	Write pattern at DLink x: LOW (P751)	0	hex	DR	S 03.20	on	R/W
755	DLink x writing target parameter (P756)	0	DLink	DR	S 03.20	on	R/W
756	Target parameter, DLink x (P755)	0	PNr	DR	S 03.20	on	R/W
757	Write mask for target parameter (P756)	0	hex	DR	S 03.20	on	R/W
758	Write pattern at DLink x: HIGH (P756)	0	hex	DR	S 03.20	on	R/W
759	Write pattern at DLink x: LOW (P756)	0	hex	DR	S 03.20	on	R/W
760							
761							
762							
763							
764							
765							
766							
767							

5.5 Parameter list

OPTION BOARD PARAMETERS							
Parameter no.	Description	Default	Unit	Storage location	from software release	On- / offline	R/W
768	Option board OB parameter 0 The option board parameter contents is read out only at boot time. Online modifications have no effect on the drive ! In combination with field bus option boards.	6040	hex	PD		on	R/W
769	Option board OB parameter 1	0	hex	PD		on	R/W
770	Option board OB parameter 2	002E	hex	PD		on	R/W
771	Option board OB parameter 3	0	hex	PD		on	R/W
772	Option board OB parameter 4	0030	hex	PD		on	R/W
773	Option board OB parameter 5	0	hex	PD		on	R/W
774	Option board OB parameter 6	0	hex	PD		on	R/W
775	Option board OB parameter 7	0	hex	PD		on	R/W
776	Option board OB parameter 8	0	hex	PD		on	R/W
777	Option board OB parameter 9	0	hex	PD		on	R/W
778	Option board OB parameter 10	0	hex	PD		on	R/W
779	Option board OB parameter 11	0	hex	PD		on	R/W
780	Option board OB parameter 12	0	hex	PD		on	R/W
781	Option board OB parameter 13	0	hex	PD		on	R/W
782	Option board OB parameter 14	1	hex	PD		on	R/W
783	Option board OB parameter 15	1	hex	PD		on	R/W
784	Option board OB parameter 16	6041	hex	PD		on	R/W
785	Option board OB parameter 17	0	hex	PD		on	R/W
786	Option board OB parameter 18	003B	hex	PD		on	R/W
787	Option board OB parameter 19	0	hex	PD		on	R/W
788	Option board OB parameter 20	004F	hex	PD		on	R/W
789	Option board OB parameter 21	0	hex	PD		on	R/W
790	Option board OB parameter 22	0	hex	PD		on	R/W
791	Option board OB parameter 23	0	hex	PD		on	R/W

OPTION BOARD PARAMETERS							
Parameter no.	Description	Default	Unit	Storage location	from software release	On- / offline	R/W
792	Option board OB parameter 24	0	hex	PD		on	R/W
793	Option board OB parameter 25	0	hex	PD		on	R/W
794	Option board OB parameter 26	0	hex	PD		on	R/W
795	Option board OB parameter 27	0	hex	PD		on	R/W
796	Option board OB parameter 28	0	hex	PD		on	R/W
797	Option board OB parameter 29	0	hex	PD		on	R/W
798	Option board OB parameter 30	0	hex	PD		on	R/W
799	Option board OB parameter 31	0	hex	PD		on	R/W
800							
801							
802							
803							
804							
805							
806							
807							
808							
809							

5.5 Parameter list

ERROR MESSAGES							
Parameter no.	Description	Default	Unit	Memory location	From software release	On- / offline	R/W
900	System error 1 (error bit array)		hex				R
901	System error 2 (error bit array)		hex				R
902	System warning 1 (warning bit array)		hex				R
903	System warning 2 (warning bit array)		hex				R
904							
905							
906							
907							
908							
909							
910	Error in converter control module		hex				R
911	Error in speed controller module		hex				R
912	Error in incremental encoder 1 module		hex				R
913	Error in data record manager 1 module		hex				R
914	Error in operating system module		hex				R
915	Error in microcontroller module		hex				R
916	Error in EMF module		hex				R
917	Error in power stage module		hex				R
918	Error in field unit module		hex				R
919	Error in motor potentiometer module		hex				R
920	Error in digital outputs module		hex				R
921	Error in actual-value detector module		hex				R
922	Error in reversing unit module		hex				R
923	Error in power unit module		hex				R
924	Error in digital inputs module		hex				R
925	Error in analog inputs module		hex				R

ERROR MESSAGES							
Parameter no.	Description	Default	Unit	Memory location	From software release	On- / offline	R/W
926	Error in armature current controller module		hex				R
927	Error in data record manager 2 module		hex				R
928	Error in data record manager 3 module		hex		S 03.03		R
929	Error in unassigned function blocks module		hex		S 03.10		R
930	Error in module motor temperature monitoring		hex		S 03.10		R
931							
932							
933							
934							
935							
936							
937							
938							
939							
940							
941							
942							
943							
944							
945							
946							
947							
948							
949							

5.5 Parameter list

FREELY DEFINABLE STATUS WORD							
Parameter no.	Description	Default	Unit	Memory location	From software release	On- / offline	R/W
950	Select bit 0	0	DLink	PD		on	R/W
951	Select bit 1	0	DLink	PD		on	R/W
952	Select bit 2	0	DLink	PD		on	R/W
953	Select bit 3	0	DLink	PD		on	R/W
954	Select bit 4	0	DLink	PD		on	R/W
955	Select bit 5	0	DLink	PD		on	R/W
956	Select bit 6	0	DLink	PD		on	R/W
957	Select bit 7	0	DLink	PD		on	R/W
958	Select bit 8	0	DLink	PD		on	R/W
959	Select bit 9	0	DLink	PD		on	R/W
960	Select bit 10	0	DLink	PD		on	R/W
961	Select bit 11	0	DLink	PD		on	R/W
962	Select bit 12	0	DLink	PD		on	R/W
963	Select bit 13	0	DLink	PD		on	R/W
964	Select bit 14	0	DLink	PD		on	R/W
965	Select bit 15	0	DLink	PD		on	R/W
966	Freely definable status word	0	hex				R
967							
968							
969							
970							
971							
972							
973							
974							
975							

FREELY DEFINABLE STATUS WORD							
Parameter no.	Description	Default	Unit	Memory location	From software release	On- / offline	R/W
976							
977							
978							
979							
980							
981							
982							
983							
984							
985							
986							
987							
988							
989							

5.5 Parameter list

SYSTEM PARAMETERS							
Parameter no.	Description	Default	Unit	Memory location	From software release	On- / offline	R/W
990							
991							
992							
993	Timing via AL 302		Mod. no.	PD		on	R/W
994	Minimum-value memory (AL316)		ALink	DR		on	R/W
995	Maximum-value memory (AL317)		ALink	DR		on	R/W
996	Parameter/ALink converter 1 (ALink 300)	1	-				
997	Parameter/ALink converter 2 (ALink 301)	1	-				
998	Memory location address	FF1C	hex	PD		on	R/W
999	Memory location address contents	0	hex				R

5.6 Parameter description - Converter data

P 001 Converter state

Converter state (refer ▶[Converter control states](#)◀ on page 74).

Value	Description
0	Not ready to operate
1	Switch-on disabled
2	Ready To Operate
3	Switched on
4	Operation enabled
5	Disable operation active
6	Stop active
7	Quick stop active
E	Malfunction reaction active
F	Malfunction

P 002 Power unit type

The value of the analog power unit identification is displayed (R501 on PCB 3.9712). The displayed value does not apply on error 16 !

Value	Description
1	BKD 6 (1-quadrant operation)
4	BKF 12 (4-quadrant operation)

P 003 Rated current of power unit

The armature power unit current level is read from the identifier upon supply voltage application and displayed in Amps.

P 004 Rated current of power unit, EEPROM

The current levels of the armature power unit is read from the EEPROM and displayed in Amps.

Any deviations of the stored value from the contents of parameter P 003 result in error message 67, and the ready-to-operate relay drops out.

P 003 and P 004 may have different contents when changing the memory module or controller print.

5.6 Parameter description - Converter data

P 005 **Power unit peak current (from S 03.20)**

Maximum current of the armature power unit.

Some power units can supply a higher current as the rated current for a short period. This peak current is read from the identifier after connecting the power supply and is then displayed in this parameter.

The possible overload period is limited via a Ixt calculation. The overload time is displayed in ALink AL 227 (see also [►Overload function◄](#) on page 98).

P 006 **Rated current of field power unit**

The field power unit current level is read from the identifier upon supply voltage application and displayed in Amps.

P 007 **Rated current of field power unit, EEPROM**

The current level of the field power units read from the EEPROM and displayed in Amps.

Any deviations of the stored value from the contents of parameter P 006 result in error message 69, and the ready-to-operate relay drops out.

P 006 and P 007 may have different contents when changing memory module or controller print.

5.7 Parameter description - Measured values

P 010 **Electronics supply (mains voltage)**

Displays the current mains supply at the electronics feed-in point X6:1 / X6:3 in V_{eff} .

P 011 **Mains frequency**

Displays the current mains frequency in Hertz.

P 012 **Rotating field (after main contactor ON)**

Value	Description
0	Unassigned, rotating field is measured only when main contactor ON (X2: 15)
1	CW rotating field
2	CCW rotating field

P 013 **Armature voltage [V]**

Displays the current armature voltage in Volts with polarity.

P 014 **Armature voltage [%]**

Displays the current armature voltage in percent with polarity, with 100 % corresponding to the set motor rated voltage (P 073).

P 015 **Armature current [A]**

Displays the current armature current in Amps with polarity.

P 016 **Armature current [%]**

Displays the armature current in percent with polarity, with 100 % corresponding to the set converter rated current (see also P 072). This value is also stored in ALink 80.

P 017 **ObjLst Index**

Internal parameter for option boards.

P 018 **ObjLst ObjNr**

Internal parameter for option boards.

5.7 Parameter description - Measured values

P 020 Power unit state

Parameter number in hexadecimal representation: 0014

Bit no.	Description	DLink
0	0: Spare	DL0048
1	0: Spare	DL0049
2	0: Spare	DL0050
3	1: Error in module power unit	DL0051
4	0: Spare	DL0052
5	1: Pre-warning limit temperature power unit	DL0053
6	1: Warning: Power unit temperature > limit temperature	DL0054
7	1: Mains frequency \geq frequency threshold ($f_{\text{mains}} \geq P528$)	DL0055
8	1: Ixt threshold exceeded, current set value is limited to power unit rated current (P003) (from S 03.20)	DL0056
9	0: Spare	DL0057
10	0: Spare	DL0058
11	0: Spare	DL0059
12	0: Spare	DL0060
13	0: Spare	DL0061
14	0: Spare	DL0062
15	0: Spare	DL0063

P 021 Field current [A]

Displays the measured field current in Amps.

P 022 Field current [%]

Displays the measured field current in percent, with 100 % corresponding to the set rated field current (see also P 079). This value is also stored in ALink 98.

P 023 Power input [%]

The electrically input power is calculated from the product of converter output current (ALink 80) and armature voltage (ALink 215) and displayed in percent. This value is also stored in ALink 222. 100 % in the display correspond to the product of P 072 (rated armature current) and P 073 (rated armature voltage) and result in 10 V at the analog output.

P 024 Power output [%]

The electrically output power is calculated from the product of converter output current (ALink 80) and motor EMF (ALink 217) and displayed in percent. This value is stored in ALink 223. The value is smaller by the losses (motor-dependent) than the power input (P 023) and thus lower than 100 %.

P 025 Power unit temperature [°C]

Displays the temperature at the heat sink in °C.

P 027 Display motor temperature channel 1 [°C]

P541	displayed is
P541 = 0: (monitoring channel OFF)	Always displayed 0 °C!
P541 = 1 (monitoring channel ON):	Displayed is the measured temperature of monitoring channel 1 (sensor connected at X8:1 and X8:2 on board 3.0043).

The value can be used with ALink 346 [°C].

P 028 Display motor temperature channel 2 [°C]

P544	displayed is
P544 = 0: (monitoring channel OFF)	Always displayed 0 °C!
P544 = 1 (monitoring channel ON):	Displayed is the measured temperature of monitoring channel 1 (sensor connected at X8:4 and X8:5 on board 3.0043).

The value can be used with ALink 347 [°C].

5.7 Parameter description - Measured values

P 030 State motor i^2t

Parameter number in hexadecimal representation: 001E

Bit no.	Description	DLink
0	1: i^2t monitoring active	DL0064
1	0: Spare	DL0065
2	0: Spare	DL0066
3	0: Spare	DL0067
4	1: i^2t value has exceeded the threshold	DL0068
5	0: Spare	DL0069
6	0: Spare	DL0070
7	0: Spare	DL0071
8	0: Spare	DL0072
9	0: Spare	DL0073
10	0: Spare	DL0074
11	1: i^2t value has exceeded 100 %	DL0075
12	0: Spare	DL0076
13	0: Spare	DL0077
14	0: Spare	DL0078
15	0: Spare	DL0079

P 031 Motor i^2t value [%]

Displays the motor i^2t monitoring value. This value is stored in ALink 220. 100 % correspond to the motor rated temperature and result in 2.5 V at the analog output and in the decimal value 4096 in ALink 220.

P 032 7S display ON and keypad enable

Value	Description
0	Switch off display
17	Switch on display (through PC input, for example) and write authority: Display active for input
Others	Switch on display (read-only, through PC input, for example)

A setting of P 032 = 17 means that the keypad is always authorised for input, independent of the set communication source (P 121).

Range: 0...10000

Save: None

Standard value: 0

Modify: Online

P 034 Parameter selection P xxx (7S display) (PC)

Selects the parameter shown in the display (high-speed parameter selection on the 7S display via the PC).

Range: 1...999

Save: None

Standard value: 1

Modify: Online

P 035 Software version

This parameter displays the converter software version.

P 036 Converter software type

Value	Description
0	Serial software
99	Development version

P 037 Error number

Any existing error switches the display on automatically and displays parameter P 037. The error memory is read out one error after the other, with the first error marked '1.' in the display. The MODE key at the converter is not active. In the case of an error, DLink 3 can be used to set a digital output.

The control may set bit 7 in P 101 from 0 to 1, or a digital input (X2: 19 to X2: 26) with the digital input function 7 may be used for error acknowledgement. Depending on the setting in parameter P 106, the errors are acknowledged individually or as a group. Any unacknowledgeable errors will be resignalled. In such a case, reboot the converter by switching the supply voltage off and on again.

Error list refer [▶BKF7000 error list \(P 037\)◀](#) from page 424.

Every error has been assigned its own bit in parameters P 910 to P 929 to ensure fast error access via communication-based control (see also P 900 and P 901).

P 038 Number of errors

Number of errors occurred

P 039 Warning number

One or several warnings switch the display on automatically and display parameter P 039 (unless there are errors). The warning memory messages are read out one after the other. The MODE key at the converter is not active. In the case of a warning, DLink 4 can be used to set a digital output.

Warnings cannot be acknowledged but are cancelled by the converter as soon as the condition that tripped the warning, is no longer present (parameter conflict resolved, for example).

Warning list refer [▶BKF7000 \(P 039\) Warning list◀](#) from page 427.

Every warning has been assigned its own bit in parameters P 902 and P 903 to ensure fast control access to all warnings via communication-based control.

5.7 Parameter description - Measured values

P 040 **Number of warnings**
Number of warnings incurred

P 042 **Code, controller enables**

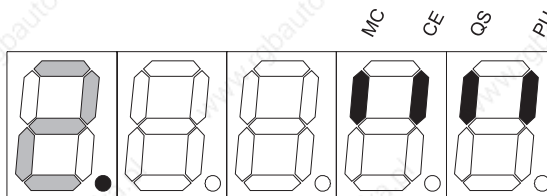

as of S03.08:
display P001
(controller state)

Enable bar on: Enable signal present

P 043 **Code, digital inputs DI**

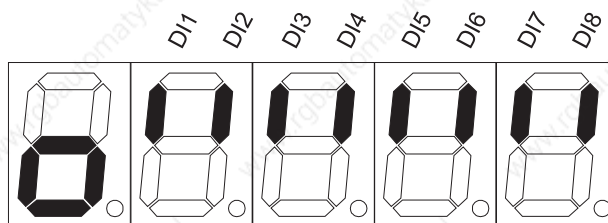

DIx on: Digital input x set

P 044 **Code, digital outputs DA**

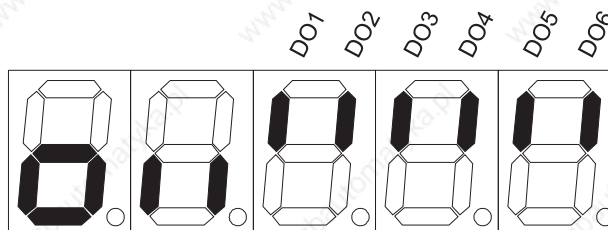

Main contactor
Relay
BBT relay
Control

DOx on: Digital output x set

Lower bar on: Relay set

P 045 Code, data records DR

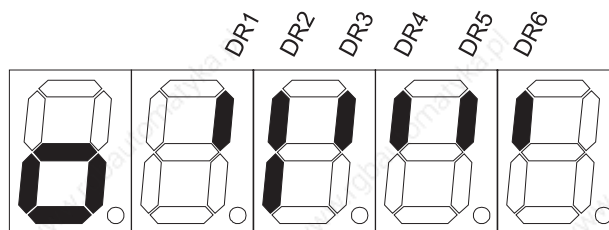

DR x on in upper row: Data record x programmed

DR x on in lower row: Data record x active (DR 2 active in this case, for example)

P 046 ALink selection for P 047

Selects the ALink whose value (contents) is to be displayed in P 047.

Range:	0...330	Save:	Data record
Range:	0...350	from S03.03	
Standard value:	0	Modify:	Online

P 047 Value of ALink (P 046)

Value (contents) of the ALink selected with P 046.

P 048 ALink selection for P 049

Selects the ALink whose value (contents) is to be displayed in P 049.

Range:	0...330	Save:	Data record
Range:	0...350	from S03.03	
Standard value:	0	Modify:	Online

P 049 Value of ALink (P 048)

Value (contents) of the ALink selected with P 048.

P 050 Speed setpoint [%]

Displays the setpoint at the speed controller input in percent, with 100 % corresponding to the set maximum speed (see also ALink 51).

P 051 Actual speed [%]

Displays the actual value at the speed controller input in percent, with 100 % corresponding to the set maximum speed (see also ALink 59).

5.8 Parameter description - Basic settings

P 070 Electronics supply (mains voltage)

Input of the rated value of the connection voltage at electronics supply X6: 1 (3U1) and X6: 3 (3W1).

The power supply unit can be operated directly on voltages from 380 V_{eff} to 500 V_{eff}. Lower mains voltages either require a series transformer, or the power supply unit must be supplied with an **additional** 24 V_{DC} externally at terminals X7: 1 (+24 V) and X7: 2 (GND).

Range: 200 V_{eff}...500 V_{eff} Save: Primary data

Standard value: 400 V_{eff} Modify: Offline

P 071 Power unit supply (mains voltage)

Input of the rated value of the connection voltage at the armature power unit 1U1, 1V1 and 1W1.

Range: 200 V_{eff}...500 V_{eff} Save: Primary data

Standard value: 400 V_{eff} Modify: Offline

P 072 Maximum converter current [A]

Input of the max. output current of the power unit in Amps.

The actual value display of parameter P 016 is scaled to this value, i. e., 100 % correspond to the set value. This value is also output as 10 V at the analog outputs (AL 79 and AL 80).

Range: 50...100 % of the converter current displayed in parameter P 003. Save: Data record

Standard value: 50 % of the converter current displayed in parameter P 003. Modify: Offline

P 073 Motor armature voltage [V]

Inputs the motor rated voltage in Volts.

The actual value display of parameter P 014 is scaled to this value, i. e., 100 % correspond to the set value. This value is also output as 10 V at the analog outputs (AL 215).

Range: 50 V...600 V Save: Data record

Standard value: 400 V for BKF (4-Q) Modify: Offline
470 V for BKD (1-Q)

P 074 Rated motor current [A]

Input of the rated current of the connected motor in Amps.

For motor i^2t value calculation. Signalling output using DLink 19 at one of the digital outputs.

Refer to parameters P 078 and P 525.

Range: 50 %...100 % of the current set in parameter P 072. Save: Data record

Standard value: 50 % of the current set in parameter P 072. Modify: Offline

NOTE:

You must set the nominal current of the used motor, if you install a UL 508C-conform machine (see Appendix C).

P 075 Motor armature voltage drop $I_A \times R_A$ [%]

The value is measured during optimization (P 082 = 1). The specification refers to the motor rated voltage set with parameter P 073 and is valid for the set converter current in P 072!

Range: 0.0 %...100.0 % Save: Data record

Standard value: 5.0 % Modify: Online

P 076 Intermittent-current limit [%]

The value is measured during optimization (P 082 = 1). The specification refers to the power unit output current set with parameter P 072.

Range: 0.0 %...100.0 % Save: Data record

Standard value: 30.0 % Modify: Online

P 077 Motor inductance

The value is measured during optimization (P 082 = 1).

Range: 0.10 mH...100.00 mH Save: Data record

Standard value: Modify: Online

P 078 Thermal time constant of the motor

For the time constant contact the motor manufacturer.

The i^2t monitoring function is **switched off** if a value of **0 min.** is entered.

i^2t monitoring is not active during optimization '1' (P 082 = 1).

Range: 0 min...180 min Save: Data record

Standard value: 0 min Modify: Online

NOTE:

You must set the thermal time constant of the used motor, if you install a UL 508C-conform machine (see Appendix C).

5.8 Parameter description - Basic settings

P 079 Rated field current

Inputs the field rated current of the connected motor in Amps.

The actual value display of parameter P 022 is scaled to this value, i. e., 100 % correspond to the set value. This value is also output as 10 V at the analog outputs (AL 98).

Range: 20 %...100 % of the field current displayed in parameter P 006 Save: Data record

Standard value: 100 % of the field current displayed in parameter P 006 Modify: Online

P 080 Minimum field current of the motor

Input of the minimum field current for field-weakened drives. 100 % correspond to the field current set in parameter P 079. Also note parameter P 382, Gating angle, maximum limit α_W Field. Effective only at P 255 = 5 and/or 6

Range: 10 %...100 % Save: Data record

Standard value: 100 % Modify: Online

P 081 Field weakening range (N_{Max} / N_{Rated})

For tachogenerator/encoder monitoring, in particular for monitoring the tachogenerator connection at terminal X3 of board 3.9711.

Definition:

N_{Max} speed at minimum field current (final speed during field weakening) and rated armature voltage (400/420 V and/or 460/470 V).

N_{Rated} speed at field rated current and rated armature voltage (400/420 V and/or 460/470 V).

Range: 1.0...4.0 Save: Data record
1,0...8,0 from S 03.15

Standard value: 1.0 Modify: Offline

P 082 Optimization (motor)

Value	Description
0	Normal operation (no optimisation and/or optimisation completed)
1	Optimization for I_{xR} , intermittent-current limit and motor inductance

**CAUTION**

Set the value of parameter P 527 to 0.0 before starting optimisation.

Block the motor before starting optimization.

This is especially necessary, if the motor is operated with armature voltage control. In this case the motor could adopt excessive speed (remenance).

Do not save data records if optimization is activated (P 082 \neq 0)! For P 082 \neq 0, the parameters P 501 = 20 %, P 372 = 0 and P 078 = 0 min and these settings would be saved.

i²t monitoring of the motor and stall protection are inactive during optimization.

Disabling the drive during optimization terminates optimization, and the controller adopts Switch-on disabled state (see P 001).

After completed or terminated optimization, the drive is started in (speed) controlled mode on re-enable.

Range: 0...1

Save: None

Standard value: 0

Modify: Offline

5.9 Parameter description - Drive manager

P 100 Status word of the controller

Parameter number in hexadecimal representation: 0064

This parameter corresponds to DRIVECOM object 6041hex and is the output word of the converter control state machine.

Bit no.	Name	Comment	DLink
0	Ready to operate	Converter control state machine	DL0080
1	Switched on	Converter control state machine	DL0081
2	Operation enabled	Converter control state machine	DL0082
3	Malfunction	Converter control state machine	DL0083
4	Voltage disabled	0: Disable voltage has been requested (command or main contactor contact)	DL0084
5	Quick stop	Converter control state machine	DL0085
6	Switch-on disabled	Converter control state machine	DL0086
7	Warning	See also P 039 and P 902 / P 903	DL0087
8	Message	At least one bit is set in the unassigned status word P 966.	DL0088
9	Remote	1: Converter can be parameterized via the set communication source*	DL0089
10	Setpoint reached	1: The specified setpoint has been reached	DL0090
11	0: Spare	0: Spare	DL0091
12	0: Spare	0: Spare	DL0092
13	0: Spare	0: Spare	DL0093
14	Configurable state bit	see P 104	DL0094
15	Configurable state bit	see P 105	DL0095

* Always 0 only when reading the status word via PROFIBUS-DP and USS protocol in the case of CAN and WinBASS.

The converter states are represented by the following status word bit combinations:

P 001	State of the converter control	Bit in status word					
		Bit no. 6 Switch-on disabled	Bit no. 5* Quick stop	Bit no. 3 Mal-function	Bit no. 2 Operation enabled	Bit no. 1 Switched on	Bit no. 0 Ready To Operate
0	NOT READY TO OPERATE	0	x	0	0	0	0
1	SWITCH-ON DISABLED	1	x	0	0	0	0
2	READY TO OPERATE	0	1	0	0	0	1
3	SWITCHED ON	0	1	0	0	1	1
4	OPERATION ENABLED	0	1	0	1	1	1
5	DISABLE OPERATION ACTIVE	0	1	0	1	1	1
6	STOP DRIVE ACTIVE	0	1	0	1	1	1
7	QUICK STOP ACTIVE	0	0	0	1	1	1
E	MALFUNCTION REACTION ACTIVE	0	x	1	1	1	1
F	MALFUNCTION	0	x	1	0	0	0

Bits identified x have no bearing on the converter control state.

* LOW active

5.9 Parameter description - Drive manager

P 101 Control word (controller)

Parameter number in hexadecimal representation: 0065. This parameter corresponds to DRIVECOM object 6040hex and is the input word of the converter control state machine (refer [►State machine of the converter control◄](#) on page 72).

Bit no.	DLink	Name	Comment
0	DL0096	Switch on	Converter control state machine
1	DL0097	Disable voltage	Converter control state machine
2	DL0098	Quick stop	Converter control state machine
3	DL0099	Enable operation	Converter control state machine
4	DL0100	Spare	Always set to zero
5	DL0101	Spare	Always set to zero
6	DL0102	Spare	Always set to zero
7	DL0103	Reset malfunction	Converter control state machine
8	DL0104	Spare	Always set to zero
9	DL0105	Spare	Always set to zero
10	DL0106	Spare	Always set to zero
11	DL0107	Free control bit	Can be used freely (e.g. for DLink connections)
12	DL0108	Spare	Always set to zero
13	DL0109	Spare	Always set to zero
14	DL0110	Spare	Always set to zero
15	DL0111	Write protection	See below.

If the write protection bit (bit no. 15) is set in the control word, the control word is protected from further write accesses until processed by the drive manager. After the write-protected control word has been processed, the drive manager resets the write protection bit.

The converter control commands are defined by the following bit combinations in the control word:

Command	Bit no. 15 Write protection	Bit no. 7 Reset malfunction	Bit no. 3 Enable operation	Bit no. 2* Quick stop	Bit no. 1* Disable voltage	Bit no. 0 Switch on	Transitions**
Stop	x	x	x	1	1	0	2, 6, 8
Switch on	x	x	x	1	1	1	3
Disable voltage	x	x	x	x	0	x	7, 9, 10, 12
Quick stop	x	x	x	0	1	x	7, 10, 11
Disable operation	x	x	0	1	1	1	5
Enable operation	x		1	1	1	1	4
Reset malfunction	x	0 -> 1	x	x	x	x	15

Bits identified x have no bearing on the converter control state.

* LOW active

** Transitions in the converter control state machine

P 102 Set operating mode

Selects the controller type

Value	Description
-3	Speed control
-2	Current control

Range: -3...-2

Save: Data record

Standard value: -3

Modify: Online

P 103 Actual operating mode

Indicates that the setting of parameter P 102 has been accepted.

P 104 Function P 100: Bit 14

P 105 Function P 100: Bit 15

The state of two DLinks can be copied into the converter status word P 100 (bit 14 and bit 15)
Setting: See freely definable control word P 950 - P 965 and P 966.

Range: 0...1200 (DLink no.)

Save: Primary data

Standard value: 0

Modify: Online

5.9 Parameter description - Drive manager

P 106 Error acknowledge mode

Value	Description
0	Errors must be acknowledged individually
1	Errors are acknowledged as a group (except non-acknowledgeable errors)
2	Errors are acknowledged as a group (a reset is performed for non-acknowledgeable errors) (from S03.10)

Range: 0...1 Save: Primary data
Range: 0...2 from S03.10
Standard value: 1 Modify: Online

P 107 Stop mode (main contactor - MC)

This parameter defines drive functioning upon deactivation of the main contactor enable (X2: 15) and/or upon the command 'Stop' while the controller is enabled.

Value	Description
0	Disable drive functioning (coast)
1	Decelerate along the deceleration ramp (see P 109); controller is disabled, when speed is lower than the set speed threshold P 505/P 506

Range: 0...1 Save: Primary data
Standard value: 0 Modify: Offline

P 108 Disable mode (controller disable - CD)

This parameter defines drive functioning upon deactivation of the controller enable (X2: 16) and/or upon the command 'Stop' while the controller is enabled.

Value	Description
0	Disable drive functioning (coast)
1	Decelerate along the deceleration ramp (see P 109); controller is disabled, when speed is lower than the set speed threshold P 505/P 506

Range: 0...1 Save: Primary data
Standard value: 0 Modify: Offline

P 109 Ramp-down time, disable/stop (CD/MC)

Deceleration in states 5 (Disable operation active) and 6 (Stop drive active) slows the drive down to 0 speed along a separate deceleration ramp. The time entered here applies for a 100 % setpoint change. This ramp does not affect ramp generators A and B. The value 0 s corresponds to 'Decelerate at current limit'.

Range: 0,00...600.00 s Save: Data record
Standard value: 0,00 s Modify: Online

P 110 Ramp-down time, quick stop (QS)

Deceleration in state 7 (Quick stop active) slows the drive down to 0 speed along a separate deceleration ramp. The time entered here applies to a 100 % setpoint change. This ramp does not affect ramp generators A and B. The value 0s corresponds to 'Decelerate at current limit'.

Range:	0.00...600.00 s	Save:	Data record
Standard value:	0.00 s	Modify:	Online

P 111 General signal limit

Global signal limitation. The input and/or output signals of various function groups are limited to this value. Refer to the function charts for the areas where this limit is effective (refer [►Function diagrams](#)◄ from page 100).

Range:	0.00...110.00 %	Save:	Data record
Standard value:	100.00 %	Modify:	Online

P 112 Power unit activate temperature error F 104 (from S 03.15)

P112 = 0:

When reaching the power unit's limit temperature (AL 221) only a warning is generated, the drive is not shut down.

P112 = 1:

When reaching the power unit's limit temperature the drive is switched off without torque, the ready for use relay is disabled and the error message F 104 is generated (see warning W13).

Range:	0...1	Save:	Primary data
Standard value:	0	Modify:	Online

NOTE:

You must set P112 equal to 1, if you install a UL 508C-conform machine (see Appendix C).

5.10 Parameter description - Communication

P 120 Drive address (for USS connection)

The converter address for USS connection and BASS protocol is set here. Address 32 is the broadcast address.

Range:	0...32	Save:	Primary data
Standard value:	0	Modify:	Offline

P 121 Communication source

This parameter manages the access rights of the different communication sources.

Communication sources are the function modules that exchange data with a higher-level control via a communications protocol. Since several such function modules may be implemented within a drive, but not all modules must access all parameters at the same time (in particular the converter-control control word (P 101)), write access must be managed accordingly.

The converter control activates and deactivates the various communication modules dependent on the parameter 'Communication source'. Each communication module has a state parameter that displays the current state (RUN: Parameter write enabled / STOP: Read only).

A communication module must write drive parameters only when it is in RUN state. Any write access is prohibited in STOP state. The drive parameters may be read in any state, however.

The parameters 'Communication source' (P 121) and 'PC write authority (BASS)' (P 125) can always be written via the PC service interface (BASS protocol: WinBASS operating program) and the dual-port-RAM communication process data channel.

The following communication sources are possible in accordance with converter configuration:

Bit no.	Description
0	1: BASS protocol enabled via RS 232 (PC interface)
1	1: USS protocol enabled via RS 485
2	1: Dual-port RAM (BAPS process data via option board)
3	1: Dual-port RAM (BAPS parameter channel via option boards)
4*	1: Dual-port RAM (BAPS cyclic data and demand data via option boards) Control word P 101 cannot be changed !
5	0: Spare
6	0: Spare
7	0: Spare
8	0: Spare
9	0: Spare
10	0: Spare
11	0: Spare
12	0: Spare
13	0: Spare
14	0: Spare
15	0: Spare

* Cyclic data and demand data transmission can be monitored with P 122 = 4, or P 122 = 8 or P 122 = 12 (=0C_{hex}).

Since cyclic DPRAM communication does not write directly to parameters but stores the set-points in separate ALinks, write authorization via bit no. 2 is applicable only for the converter-control control word (P 101).

If the parameter 'Communication source' is set to 0, the drive can be controlled only via the hardware signals pulse enable (PU), quick stop (QS), main contactor enable (MC) and controller disable (CD).

The control relay of the main contactor drops out automatically when the communication source is changed. If the communication source is changed while the drive is enabled, the new value is valid straightly and without any additional action. Note, that the former valid communication source (also when controlling the drive), cannot stop / disable the drive via control word when it will be disabled by parameter communication source

If the communication source is changed while the drive is disabled, the relay to control the main contactor drops out automatically. To enable the drive, a positive edge of the control input „main contactor ON“ (X2:15) is necessary!

This safety mechanism is necessary, because the drive is perhaps only via one command of the communication disabled (e.g. command „disable operation“), but all hardware enables are given. When switching to operation with communication source 0, only the hardware enables are evaluated, the drive would change from disabled state automatically to operation enabled and start running.

5.10 Parameter description - Communication

Range: 0...31

Save:

Primary data

Standard value: 0

Modify:

Offline: up to S03.11

Online: from S03.12

P 122 Communication source monitoring

This parameter may be used to activate communication source monitoring.

Bit no.	Description
0	1: BASS protocol monitored via RS 232 (PC interface)
1	1: USS protocol monitored via RS 485
2	1: Dual-port RAM (BAPS process data) is monitored
3	1: Dual-port RAM (BAPS parameter data channel) is monitored
4	0: Spare
5	0: Spare
6	0: Spare
7	0: Spare
8	0: Spare
9	0: Spare
10	0: Spare
11	0: Spare
12	0: Spare
13	0: Spare
14	0: Spare
15	0: Spare

Range: 0...15

Save:

Primary data

Standard value: 0

Modify:

Offline: up to S03.11

Online: from S03.12

P 123 Monitoring period

This parameter is used to set the communication monitoring period that applies to all communication sources.

If no data arrives from the current communication source during the time set in parameter 'Monitoring period' because the interface cable is interrupted or the communication card is defective, for example, the drive changes to malfunction state, and an error is displayed (error 1 .. 4). The monitoring period may be up to one minute, with the resolution being 1 ms. The monitoring function is not active at a 0 ms entry.

Field bus option boards at the BAPS interface evaluate this parameter at boot time only. Any changes to the parameter require the converter to be rebooted with the field bus card.

Range:	0...60000 ms	Save:	Primary data
Standard value:	0	Modify:	Offline: up to S03.11 Online: from S03.12

P 125 PC write authorization (BASS)

At P 125 = 1, the converter can be parameterized via PC independent of the set communication source (P 121). The advantage is that the control (enables) of the converter does not have to be via the PC in this case and thus no conflicts with the machine control can occur.

Value	Description
0	P 121 Communication source defines write authorisation for PC communication (BASS protocol)
1	Write accesses via PC communication are possible independent of P 121 (BASS protocol)

Range:	0...1	Save:	None
Standard value:	0	Modify:	Online



P 126 Baud rate, PC (BASS)

The Baud rate for PC communication is fixed to 9600 Baud (BASS protocol). This parameter is for display only and cannot be modified.

5.10 Parameter description - Communication

P 127 Edit data record for PC (BASS)

Setting is independent of the selection made with parameter P 144 !

Value	Description
0	<p>The parameters for display and PC communication are always read and modified from the current data record. Even after a data record change, it is always the current data record (display of current data record number in P 152) that is displayed / processed. The display shows a 'P' in the first position (left) and the data record number with a decimal point in the second position:</p> 
1..6	<p>The parameters for display and PC communication are read from the current data record and modified therein. Even after a data record change, it is always the selected data record that is displayed / processed. The display shows the data record number in the first position (left) and a 'P' in the second position:</p> 

Range: 0...6

Save: None

Standard value: 0

Modify: Online

P 128 **PC state (BASS)**

Parameter number in hexadecimal representation: 0080

Bit no.	DLink	Description
0	DL0112	1: Communication enabled (see also communication source)
1	DL0113	0: Spare
2	DL0114	0: Spare
3	DL0115	0: Spare
4	DL0116	Drive address bit 0 (see also USS drive address)
5	DL0117	Drive address bit 1 (see also USS drive address)
6	DL0118	Drive address bit 2 (see also USS drive address)
7	DL0119	Drive address bit 3 (see also USS drive address)
8	DL0120	Drive address bit 4 (see also USS drive address)
9	DL0121	Drive address bit 5 (see also USS drive address)
10	DL0122	Drive address bit 6 (see also USS drive address)
11	DL0123	Drive address bit 7 (see also USS drive address)
12	DL0124	0: Spare
13	DL0125	0: Spare
14	DL0126	0: Spare
15	DL0127	0: Spare

5.10 Parameter description - Communication

P 130 USS state

Parameter number in hexadecimal representation:0082

Description of USS protocol interface refer [►Appendix B - USS protocol◀](#) from page 457.

Bit no.	DLink	Description
0	DL0128	0: STOP : Incoming messages are not answered 1: RUN : Message evaluation active
1	DL0129	0: Spare
2	DL0130	0: Spare
3	DL0131	0: Spare
4	DL0132	1: No messages to own address received for longer than 1 s
5	DL0133	1: No messages on the bus for longer than 5 s
6	DL0134	0: Spare
7	DL0135	1: Error during function module initialisation
8	DL0136	0: Spare
9	DL0137	0: Spare
10	DL0138	1: Error during actual-value read
11	DL0139	1: Error during setpoint write
12	DL0140	0: Spare
13	DL0141	0: Spare
14	DL0142	0: Spare
15	DL0143	0: Spare

P 131 **USS mode**

This parameter is used to set the USS protocol operating mode.

Bit	Description
0	1: Scaling active 0: Scaling inactive
1	1: Broadcast coding active 0: Broadcast coding inactive
2	1: Response delay active 0: Response delay inactive
3	Spare: Always set to zero
4	Spare: Always set to zero
5	Spare: Always set to zero
6	Spare: Always set to zero
7	Spare: Always set to zero
8	Spare: Always set to zero
9	Spare: Always set to zero
10	Spare: Always set to zero
11	Spare: Always set to zero
12	Spare: Always set to zero
13	Spare: Always set to zero
14	Spare: Always set to zero
15	Spare: Always set to zero

Range: 0...7

Save:

Primary data

Standard value: 0

Modify:

Online

Bit no. 0 is used to select scaling for the parameter handling word PIV area.

With scaling off, the parameters are represented in the message in the original scaling ($\pm 100.00\%$, ± 2048 etc.); with scaling on, they are related uniformly to 4000h.

Bit no. 1 activates broadcast coding.

As a rule, a broadcast message addresses all existing (maximum 32) bus devices. Broadcast coding can be used to select the drives which the broadcast message is to reach. Only the selected drives respond to the control word contained in the broadcast message. The masking of this control word with the mask transmitted in PVA1 (PIV area) remains effective regardless.

▼ Broadcast coding requires the following prerequisites:

- ▶ The number of USS PIV elements (P 133) must be set to ≥ 3
- ▶ The number of USS PCD elements (P 134) must be set to ≥ 3
- ▶ USS mode (P 131) bit no. 1 must be set to = 1.

5.10 Parameter description - Communication

- ▶ The example below illustrates how broadcast coding works:
Assumption: Number of process data words PCD = 3, number of parameter handling words PIV = 3
PIV = 3

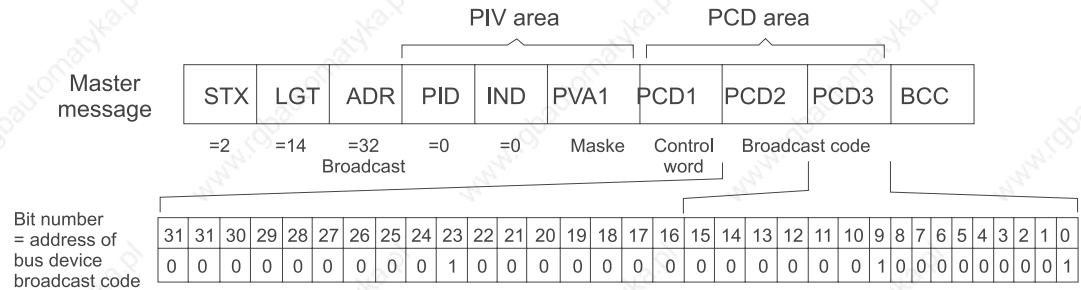

The broadcast code is in PCD 2 (HIGH word) and PCD 3 (LOW word) and indicates in this example that the control word in PCD1 (masked with the value in PVA 1) is to be accepted and executed by bus devices with the addresses 0, 9 and 23. All other bus devices are to ignore the information.

Bit no. 2 selects a response delay.

In accordance with the USS protocol specification, the drive sends its response message with a maximum delay of 2 ms after receiving the master message. This short period of time, however, does not always allow complete processing of the information contained in the master message (in the PCD area, for example), so that, therefore, a preliminary response message with not-yet-current contents is returned to the master. The correct response will be transmitted to the master only during the next message cycle (see arrow in the diagram below). In other words, responses are subject to a delay of one message cycle.

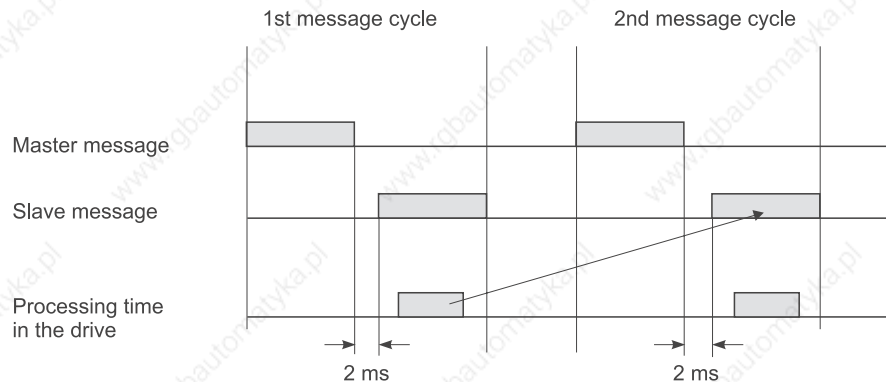

The information contained in the master message is processed after its receipt at the activated response delay (P 131, bit no. 2 = 1), and only then is the response message returned to the master (see arrow in the diagram below). Although this saves one message cycle, this approach creates uncertainty as to when exactly the response message is sent. At the activated response delay, message timing is no longer as specified.

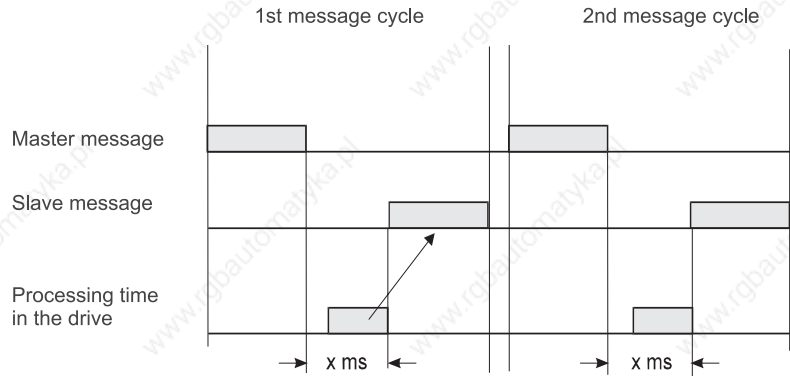

P 132 Baud rate USS

This parameter is used to set the baud rate for the RS485 interface.

Range: 150...19200 Baud Save: Primary data
 Standard value: 9600 Baud Modify: Online

P 133 Number of PIV elements (USS)

This parameter sets the number PIV elements in the PIV area of the net data block. The specification always relates to word-length PIV elements.

Value	Description
0	0 words (no parameterisation possible)
3	Always 3 words
4	Always 4 words

Range: 0...4 words Save: Primary data
 Standard value: 3 words Modify: Online

5.10 Parameter description - Communication

P 134 Number of PCD elements (USS)

This parameter can be used to change the number of process data elements in the net data block. The specification always relates to word-length PCD elements.

Value	Description
0	No process data
1	Control word/status word transmitted in PCD1 (no setpoint/actual value)
2	Control word/status word and 1 setpoint/actual value
3	Control word/status word and 2 setpoints/actual values

Range: 0...3 words Save: Primary data
Standard value: 2 words Modify: Online

P 135 Actual value 1 (USS)

This parameter is used to set the number of the ALink that is transmitted as actual value 1 in the PCD area (as per PCD number P 134).

Range: 0...330 Save: Primary data
Range: 0...350 from S03.03
Standard value: 59 Modify: Online

P 136 Actual value 2 (USS)

This parameter is used to set the number of the ALink that is transmitted as actual value 2 the PCD area (as per PCD number P 134).

Range: 0...330 Save: Primary data
Range: 0...350 from S03.03
Standard value: 79 Modify: Online

BAPS communication

The BAPS interface interlinks with optional field bus cards such as CAN, PROFIBUS-DP and CANopen. The following parameters refer to this interface and, with the exception of P 144, serve diagnostic purposes only.

P 140 BAPS state, process data

Parameter number in hexadecimal representation: 008C

Bit no.	Description	DLink
0	1: Communication enabled (see also communication source)	DL0144
1	1: Communication source 10 _{hex} active	DL0145
2	0: Spare	DL0146
3	0: Spare	DL0147
4	1: Communication initialised	DL0148
5	0: Spare	DL0149
6	0: Spare	DL0150
7	0: Spare	DL0151
8		DL0152
9		DL0153
10		DL0154
11	Messages from option boards (refer BAPS description)	DL0155
12		DL0156
13		DL0157
14		DL0158
15		DL0159

P 141 BAPS master command word

Master command word:

Value _[hex]	Description
00	No communication (process data)
01	Cyclic data exchange
02	Write configuration Initialise communication
03	
...	Spare
FFFF	

5.10 Parameter description - Communication

P 142 BAPS slave acknowledge

Slave acknowledge:

Value _[hex]	Description
00	No communication (process data)
01	Setpoints read, actual values written
02	Configuration/initialisation performed without errors
03	Spare
...	
7F	
80	Received uninterpretable command
81	No configuration/initialisation performed
82	Error reading actual value
83	Error writing setpoint
84	Spare
...	
FFFF	

P 143 BAPS state, parameter channel

Parameter number in hexadecimal representation: 008F

Bit no.	Description	DLink
0	1: Communication enabled (see also communication source)	DL0160
1	1: Communication source 10 _{hex} active	DL0161
2	0: Spare	DL0162
3	0: Spare	DL0163
4	0: Spare	DL0164
5	0: Spare	DL0165
6	0: Spare	DL0166
7	0: Spare	DL0167
8	0: Spare	DL0168
9	0: Spare	DL0169
10	0: Spare	DL0170
11	0: Spare	DL0171
12	0: Spare	DL0172
13	0: Spare	DL0173
14	0: Spare	DL0174
15	0: Spare	DL0175

P 144 Edit data record for BAPS (from S03.06)

This parameter is used to select a fixed data record for BAPS parameter channel communication. Setting is independent of the selection made with parameter P 127 !

PC display and display remain unaffected !

Value	Description
0	The parameter values are read from the current data record, or data are written to parameters of the current data record.
1..6	The parameter values are read only from the selected data record, or data are written to parameters of the selected data record. The selected data record does not have to be identical to the current data record !

Range: 0..6

Save: None

Standard value: 0

Modify: Online

5.11 Parameter description - Data record manager

Converter operating data are stored in a non-volatile EEPROM memory so that they remain preserved after switch-off.

Some of the parameters are stored only once (primary), others in data records. The remaining parameters (actual values, status words etc.) are not stored.

There are 6 data records available in the EEPROM (1 to 6). In addition to this, data record 7 includes a ROM data record in whose RAM copies parameters can be modified. These modifications are lost when the converter is switched off, but can be copied to one of the data records 1 to 6 (P 153).

All 7 data records exist currently in the RAM, and it is possible to switch between data records 1 to 6 (P 152).

All primary parameters are automatically written to the EEPROM when one of these parameters is changed. Additionally, all primary data are also stored after each data record save (P 153).

The converters are supplied with an empty EEPROM so that errors 6 and 58 occur in P 037 on switch-on. In this case, proceed as follows:

All machine-relevant parameters require adjustment (P 125 = 1 for PC input / P 032 = 17 for key pad input); enter P 153 = 7.1 to create data record 1 in the EEPROM. Once bits 0 and 1 have been set in P 150 (display xxx3 hex, xxx7 hex, xxxB hex or xxxF hex, may take approx. 40 seconds), the boot source can be set to data record 1 (P 151 = 1). Once P 150 then displays value xxxFh again (may take approx. 10 seconds), the converter must be rebooted by switching it off and on again.

P 150 **State of data record manager**

Parameter number in hexadecimal representation: 0096

Bit no.	Description	DLink
0	=0: STOP : Data record manager ready to operate	DL0176
1	=1: RUN : Data record manager executing a command =2 : Spare =3 : STAND_BY : Data record manager has completed a command	DL0177
2	1: Error in module (error code refer P 155: Data record manager message) see also P 927	DL0178
3	1: Error in module (error code refer P 155: Data record manager message) see also P 913	DL0179
4	1: Warning: Data record was not saved	DL0180
5	1: Parameter scaling active in the background	DL0181
6	1: Error in module, see also P 928	DL0182
7	0: Spare	DL0183
8	1: Data record 1 active	DL0184
9	1: Data record 2 active	DL0185
10	1: Data record 3 active	DL0186
11	1: Data record 4 active	DL0187
12	1: Data record 5 active	DL0188
13	1: Data record 6 active	DL0189
14	1: Data record 7 active	DL0190
15	0: Spare	DL0191

P 151 **Boot source**

Once all programmed data records have been copied during the boot, the system switches to the data record entered in this parameter. If the programming of the data record entered here is invalid, the system switches to the ROM data set 7 (the ready-to-operate relay drops out - error 6).

In as-supplied condition, the EEPROM is empty, and the boot source is set to 0.

Range: 1...6

Save:

Primary data

Standard value: 0

Modify:

Online

P 152 Load data record

If a new value is entered in this parameter, the system switches to this data record (note P 154 and error 57). Note that the RAM data record is changed. Therefore even changes are not saved are valid. To load data records from the EEPROM refer to (P157=6) [P 157 Data record manager command](#) on page 218.

This changeover is completed within one controller cycle. Exception: Parameters used to set times must be processed during the rest time (duration approx. 10 ms):

In addition to time-specific parameters, the following parameters also require scaling during the rest time (duration approx. 10 ms):

P 072 to P 076, P 079, P 081, P 102, P 104, P 105, P 111, P 213, P 215, P 222 to P 225, P 255, P 257, P 258, P 262, P 270, P 310 to P 313, P 315 to P 318, P 330 to P 333, P 360, P 361, P 381, P 382, P 421 to P 424, P 428 to P 431, P 435, P 439, P 443, P 447, P 461 to P 463, P 466 to P 468, P 471 to P 473, P 476 to P 478, P 501, P 505 to P 514, P 521 to P 524, P 692, P 693, P 996 and P 997.

Range: 1...6

Save: None

Standard value: 1

Modify: Online



WARNING

This affects all parameters stored in the data records, including parameters that can only be set while the **drive is disabled - offline** setting. Parameters stored in the data records are identified '**DR**' in the column Memory location in the parameter list. The parameter description includes the note '**Save: Data record**'.

The system doesn't check the correctness of the values. Therefore it is vital to take care when editing the values - you have to ensure that a parameter set change entails no unintentional or dangerous statuses at the machine.

Parameter P 154 = 1 allows data record changes only while the drive is disabled.

P 153 Save data record

This parameter can be used to write a data record into the EEPROM. The position before the point indicates the RAM source data record, the one after the point the target data record in the EEPROM.

Example: 2.2 writes data record 2 from the RAM into data record 2 in the EEPROM

3.4 writes data record 3 from the RAM into data record 4 in the EEPROM

Data record 4 in the RAM.

The primary parameters are always written into the EEPROM automatically upon a change. They are also written automatically into the EEPROM after each data record save.

Saving a data record takes about 40 s.

NOTE:

You should copy data records (e.g. data record 1 to data record 2) only if the controller is disabled. Several parameters can only be changed if the controller is disabled and it is possible this parameters are copied incorrectly.

Range: 1.0...7.6 Save: None
 Standard value: 1.1 Modify: Offline

P 154 Disable data record change

Value	Description
0	Data record change at controller disabled/enabled.
1	Data record change, controller disabled only

Any data record change requested at P 154 = 1 and enabled controller will not be executed, and warning 8 is displayed. The original data record remains active.

If the request remains active (possible only at switching input - terminals X2: 19 to X2: 26), the system changes to the requested data record on controller disable, and the warning is deleted.

Range: 0...1 Save: Primary data
 Standard value: 0 Modify: Online

P 155 Data record error

Bit no.	Description
0	1: Undefined command (in parameter P 157)
1	1: Data record does not exist
2	1: Incorrect checksum
3	1: Parameter cannot be written (see also P 037: Errors 59 to 65)
4	Spare
5	1: EEPROM too small
6	1: Error in configuration list (see also P 037: Errors 59 to 65)
7	1: Undefined parameter format (see also P 037: Errors 59 to 65)
8	1: Error in data record 1
9	1: Error in data record 2
10	1: Error in data record 3
11	1: Error in data record 4
12	1: Error in data record 5
13	1: Error in data record 6
14	Spare
15	1: Error in primary data

P 156 Error in parameter Pxxx

The number of a parameter affected by a message in P 155 is displayed here.

5.11 Parameter description - Data record manager

P 157 Data record manager command

Value	Description
0	Reset data record manager (P 155 and P 156 are set to zero)
1	Erase EEPROM (possible only after password entry)
2	Spare
3	Save primary data to EEPROM
4	Spare
5	Save data record to EEPROM) Source and target data record are identical and to be entered with parameter P 158.
6	Read data record from EEPROM (data record number = P 158) CAUTION: No data record change
7	Erase data record from EEPROM (data record number = P 158)
8	Enter password
9	Unlock EEPROM
10	Lock EEPROM

Range: 0...10

Save: None

Standard value: 0

Modify: Online

P 158 Data record number

In this parameter, enter the number of the data record to be written to the EEPROM, to be read or erased from the EEPROM (see also P 157 = 5, 6, 7). This parameter is set automatically when writing parameters P 152 and P 153.

Range: 1...7

Save: None

Standard value: 1

Modify: Online

P 159 Active passwords

Any passwords that have already been entered, are displayed here.

Bit no.	Description
0	Spare
1	Spare
2	Spare
3	Spare
4	1: Erase EEPROM (P 157 = 1)
5..15	Spare

P 160 EEPROM programming cycles

Saving a data record increases this parameter internally by 1 each time and saves it in the EEPROM. It is set to zero only when the EEPROM is erased.

5.12 Parameter description - Analog inputs

P 181 Control word (analog inputs)

Parameter number in hexadecimal representation: 00B5

Bit no.	Description	DLink
0	1: Invert analog input 1	DL0208
1	0: Set analog input 1 to zero	DL0209
2	1: Invert analog input 2	DL0210
3	0: Set analog input 2 to zero	DL0211
4	1: Invert analog input 3	DL0212
5	0: Set analog input 3 to zero	DL0213
6	1: Invert analog input 4	DL0214
7	0: Set analog input 4 to zero	DL0215
8	Spare: Always set to zero	DL0216
9	Spare: Always set to zero	DL0217
10	Spare: Always set to zero	DL0218
11	Spare: Always set to zero	DL0219
12	Spare: Always set to zero	DL0220
13	Spare: Always set to zero	DL0221
14	Spare: Always set to zero	DL0222
15	Spare: Always set to zero	DL0223

P 182 Function, analog input 1 (at terminal X1: 17/18)

1: Voltage input +/- 10 V or current input 0...20 mA input

2: Current input 4...20 mA (I < 3.3 mA results in malfunction and error message 51, acknowledgeable).

If used as a current input, move switch 'S800 - Analog input 1' into the lefthand (board 3.9711.B) and/or lower position (from board 3.9711.C).

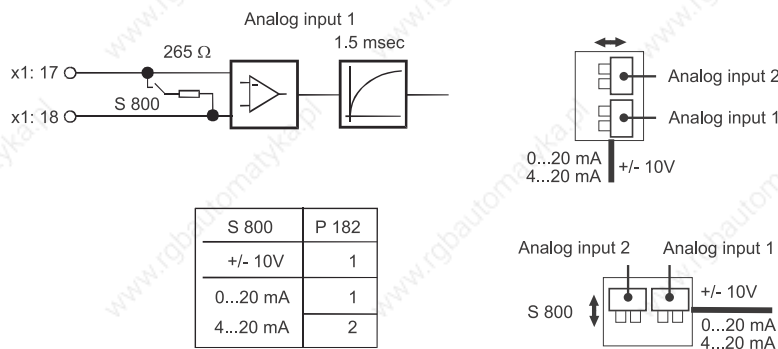

5.12 Parameter description - Analog inputs

Range:	1...2	Save:	Primary data
Standard value:	1	Modify:	Offline

P 183 **Scaling, analog input 1**

Multiplier for the value at analog input 1

Range:	0.000...5.000	Save:	Data record
Standard value:	1.000	Modify:	Online

P 184 **Offset, analog input 1**

Enters a constant that is added to the value at analog input 1 after scaling.

Range:	-100.00 %...+100.00 %	Save:	Data record
Standard value:	0.00 %	Modify:	Online

P 185 **Polarity, analog input 1**

0: Analog input 1 switched off. The value 0 is written in ALink AL 26 independent of the input signal value.

1: Input signal transmitted with polarity

2: Input signal transmitted after polarity change

3: Positive absolute value of the input signal

4: Negative absolute value of the input signal

Range:	0...4	Save:	Data record
Standard value:	1	Modify:	Online

The value of the input signal is available in **AL 26**.

P 186 Function, analog input 2 (at terminal X1: 19/20)

1: Voltage input +/- 10 V or current input 0...20 mA

2: Current input 4...20 mA (I < 3.3 mA results in malfunction and error message 51, acknowledgeable).

If used as a current input, move switch 'S800 - Analog input 2' into the lefthand (board 3.9711.B) and/or lower position (from board 3.9711.C).

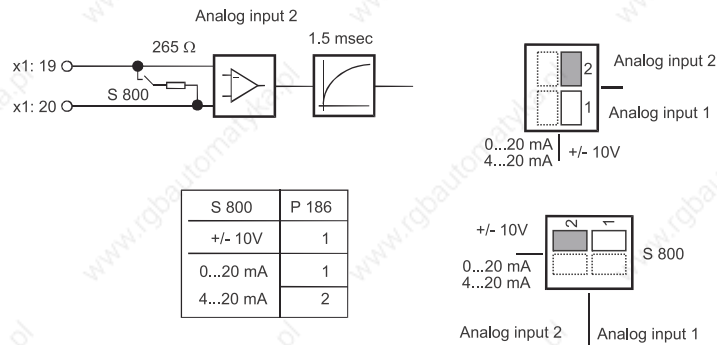

Range: 1...2
Standard value: 1

Save: Primary data
Modify: Offline

P 187 Scaling, analog input 2

Multiplier for the value at analog input 2

Range: 0.000...5.000
Standard value: 1.000

Save: Data record
Modify: Online

P 188 Offset, analog input 2

Enters a constant that is added to the value at analog input 2 after scaling.

Range: -100.00 %...+100.00 %
Standard value: 0.00 %

Save: Data record
Modify: Online

P 189 Polarity, analog input 2

0: Analog input 2 switched off. The value 0 is written in ALink AL 28 independent of the input signal value.

- 1:** Input signal transmitted with polarity
- 2:** Input signal transmitted after polarity change
- 3:** Positive absolute value of the input signal
- 4:** Negative absolute value of the input signal

Range: 0...4
Standard value: 1

Save: Data record
Modify: Online

The value of the input signal is available in **AL28**.

5.12 Parameter description - Analog inputs

P 190 **Scaling, analog input 3 (at terminal X1: 21/22)**

Multiplier for the value at analog input 3

Range: 0.000...5.000

Save:

Data record

Standard value: 1.000

Modify:

Online

P 191 **Offset, analog input 3**

Enters a constant that is added to the value at analog input 3 after scaling.

Range: -100.00 %...+100.00 %

Save:

Data record

Standard value: 0.00 %

Modify:

Online

The value of the input signal is available in **AL 30**.

P 192 **Scaling, analog input 4 (at terminal X1: 23/24)**

Multiplier for the value at analog input 4

Range: 0.000...5.000

Save:

Data record

Standard value: 1.000

Modify:

Online

P 193 **Offset, analog input 4**

Enters a constant that is added to the value at analog input 4 after scaling.

Range: -100.00 %...+100.00 %

Save:

Data record

Standard value: 0.00 %

Modify:

Online

The value of the input signal is available in **AL 32**.

5.13 Parameter description - Internal setpoints

P 194 Fixed setpoint 1

To be used as internal setpoint or multiplier of an unassigned multiplier, offset at ramp generator input etc., for example.

Range:	-100.00 %...+100.00 %	Save:	Data record
Standard value:	5.00 %	Modify:	Online

The value is available in **AL 33**.

P 195 Fixed setpoint 2

To be used as internal setpoint or multiplier of an unassigned multiplier, offset at ramp generator input etc., for example.

Range:	-100.00 %...+100.00 %	Save:	Data record
Standard value:	5.00 %	Modify:	Online

The value is available in **AL 34**.

P 196 Fixed setpoint 3

To be used as internal setpoint or multiplier of an unassigned multiplier, offset at ramp generator input etc., for example.

Range:	-100.00 %...+100.00 %	Save:	Data record
Standard value:	5.00 %	Modify:	Online

The value is available in **AL 35**.

P 197 Fixed setpoint 4

To be used as internal setpoint or multiplier of an unassigned multiplier, offset at ramp generator input etc., for example.

Range:	-100.00 %...+100.00 %	Save:	Data record
Standard value:	5.00 %	Modify:	Online

The value is available in **AL 36**.

P 198 Fixed setpoint 5

To be used as internal setpoint or multiplier of an unassigned multiplier, offset at ramp generator input etc., for example.

Range:	-100.00 %...+100.00 %	Save:	Data record
Standard value:	5.00 %	Modify:	Online

The value is available in **AL 37**.

5.13 Parameter description - Internal setpoints

P 199 Fixed setpoint 6

To be used as internal setpoint or multiplier of an unassigned multiplier, offset at ramp generator input etc., for example.

Range: -100.00 %...+100.00 % Save: Data record

Standard value: 5.00 % Modify: Online

The value is available in **AL 38**.

5.14 Parameter description - Setpoint generator

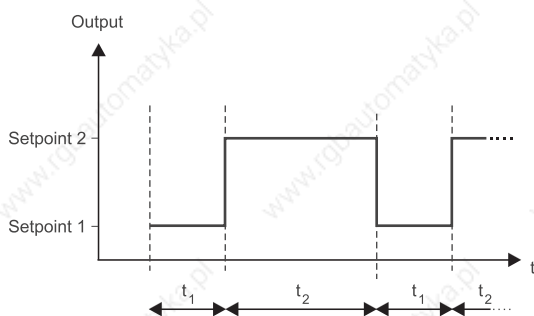

P 201 Generator, setpoint 1 (internal setpoint generator)

Effective for the time set with P 203.

Range:	-100.00 %...+100.00 %	Save:	Data record
Standard value:	5.00 %	Modify:	Online

P 202 Generator setpoint, 2 (internal setpoint generator)

Effective for the time set with P 204.

Range:	-100.00 %...+100.00 %	Save:	Data record
Standard value:	0.00 %	Modify:	Online

P 203 Generator, time 1 (internal setpoint generator)

The setpoint set with P 201 remains effective for this time.

Range:	0.02s...300.00 s	Save:	Data record
Standard value:	5.00 s	Modify:	Online

P 204 Generator, time 2 (internal setpoint generator)

The setpoint set with P 202 remains effective for this time.

Range:	0.02s...300.00 s	Save:	Data record
Standard value:	5.00 s	Modify:	Online

The output of the setpoint generator is available in **AL 39**.

5.15 Parameter description - Motor potentiometer

5.15 Parameter description - Motor potentiometer

The motor potentiometer function is a simulation of a standard motor potentiometer. Note though that unlike a mechanical potentiometer, the setpoint is not saved when the device is switched off and on. Certain adjustable operating states (controller disable, for example) allow the set value to be corrected.

P 210 Status word (motor potentiometer)

Parameter number in hexadecimal representation: 00D2

Bit no.	Description	DLink
0	1: Motor potentiometer correction inactive	DL0240
1	0: Spare	DL0241
2	0: Spare	DL0242
3	1: Error in module (conflicting parameters, for example)	DL0243
4	1: Upper limit reached	DL0244
5	1: Lower limit reached	DL0245
6	1: Setpoint UP	DL0246
7	1: Setpoint DOWN	DL0247
8	1: Ramp-up active	DL0248
9	1: Ramp-down active	DL0249
10	1: Motorised potentiometer running up or down	DL0250
11	0: Spare	DL0251
12	0: Spare	DL0252
13	0: Spare	DL0253
14	0: Spare	DL0254
15	0: Spare	DL0255

P 211 Control word (motor potentiometer)

Parameter number in hexadecimal representation: 00D3

Bit no.	Description	DLink
0	1: MP up	DL0256
1	1: MP down	DL0257
2	Spare: Always set to zero	DL0258
3	Spare: Always set to zero	DL0259
4	Spare: Always set to zero	DL0260
5	Spare: Always set to zero	DL0261
6	Spare: Always set to zero	DL0262
7	Spare: Always set to zero	DL0263
8	Spare: Always set to zero	DL0264
9	Spare: Always set to zero	DL0265
10	Spare: Always set to zero	DL0266
11	Spare: Always set to zero	DL0267

Bit no.	Description	DLink
12	Spare: Always set to zero	DL0268
13	Spare: Always set to zero	DL0269
14	Spare: Always set to zero	DL0270
15	Spare: Always set to zero	DL0271

P 212 Ramp-up time (motor potentiometer)

Time valid for one 100.00 % setpoint difference and for a setpoint range of -100.00 % to +100.00 %.

Range: 0.1 s...600.0 s Save: Data record
Standard value: 10.00 s Modify: Online

P 213 Upper limit (motor potentiometer)

Maximum value which the motor potentiometer does not exceed despite operation of the 'UP' key (refer to DIF20/21 ▶ [Page 418](#) ◀). This value must be higher than the lower limit value set with P 215. Otherwise error '42' is displayed.

Range: -100.00 %...+100.00 % Save: Data record
Standard value: 100.00 % Modify: Online

P 214 Ramp-down time (motor potentiometer)

Time valid for one 100.00 % setpoint difference and for a setpoint range of +100.00 % to -100.00 %.

Range: 0.1 s...600.0 s Save: Data record
Standard value: 10.00 s Modify: Online

P 215 Lower limit (motor potentiometer)

Minimum value which the motor potentiometer does not fall below despite operation of the 'DOWN' key (refer to DIF20/21 ▶ [Page 418](#) ◀). This value must be smaller than the upper limit value set with P 213. Otherwise error '42' is displayed.

Range: -100.00 %...+100.00 % Save: Data record
Standard value: 0.00 % Modify: Online

P 216 Correction ON/OFF (motor potentiometer)

Corrects the motor potentiometer in certain states (drive disabled, for example).

0: Motor potentiometer is not corrected. The 'UP' and 'DOWN' keys (refer to DIF20/21 ▶ [Page 418](#) ◀) remain active even if the drive is disabled.

1: Motor potentiometer is corrected if the selected DLink is HIGH (P 218). The 'UP' and 'DOWN' keys (refer to DIF20/21 ▶ [Page 418](#) ◀) are not active. The motor potentiometer output is set to the value of the signal selected with parameter P 217.

5.15 Parameter description - Motor potentiometer

2: Motor potentiometer is corrected if the selected DLink is LOW (P 218). The 'UP' and 'DOWN' keys (refer to DIF20/21 ▶ [Page 418](#) ◀) are not active. The motor potentiometer output is set to the value of the signal selected with parameter P 217.

Range:	0...1	Save:	Primary data
Range:	0...2	from S03.06	
Standard value:	1	Modify:	Online

P 217 Selection, correction signal

Selection of the signal (ALink) to whose value the output of the motor potentiometer is set when correction is active.

Range:	0...330	Save:	Primary data
Range:	0...350	from S03.03	
Standard value:	59	Modify:	Online

P 218 Selection, control signal for correction (motor potentiometer) (from S03.06)

Selection of the signal (DLink) used to control motor potentiometer correction. Correction is active

at P 216 = 1 if the selected DLink is HIGH.

at P 216 = 2 if the selected DLink is LOW.

See also parameter P 217.

Range:	0...1200	Save:	Primary data
Standard value:	23	Modify:	Online

The output of the motor potentiometer does not change if the 'UP' and 'DOWN' keys (refer to DIF20/21 ▶ [Page 418](#) ◀) are operated at the same time !

The output of the motor potentiometer is available in **AL 40**.

5.16 Parameter description - Ramp generator A

P 220 Status word (ramp generator A)

Parameter number in hexadecimal representation: 00DC

Bit no.	Description	DLink
0	1: Ramp generator RUN	DL0272
1	0: Spare	DL0273
2	0: Spare	DL0274
3	1: Error in module	DL0275
4	1: Ramp generator output internally set to 0 (ramp generator enable)	DL0276
5	1: Ramp regenerator output stopped at its value (ramp generator stop)	DL0277
6	1: Ramp generator input internally set to setpoint 0	DL0278
7	1: Quickstop or main contactor deceleration ramp active	DL0279
8	1: Running up	DL0280
9	1: Running down	DL0281
10	0: Spare	DL0282
11	0: Spare	DL0283
12	1: Ramp generator output = ramp generator input (setpoint reached)	DL0284
13	1: Setpoint limited	DL0285
14	0: Spare	DL0286
15	0: Spare	DL0287

P 224 Setpoint selection, input 3 (ramp generator A)

Selection of the signal (ALink) at ramp generator input A. Is added to the signals selected with parameters P 222, P 223 and P 225.

Range:	0...330	Save:	Data record
Range:	0...350 from S03.03		
Standard value:	0 (= 0 %)	Modify:	Online

P 225 Setpoint selection, input 4 (ramp generator A)

Selection of the signal (ALink) at ramp generator input A. Is added to the signals selected with parameters P 222, P 223 and P 224.

Range:	0...330	Save:	Data record
Range:	0...350 from S03.03		
Standard value:	0 (= 0 %)	Modify:	Online

Generated by the four setpoints (P 222 to P 225, limited to the value of parameter P 111), the addition setpoint at ramp generator input A is available in **AL 42**.

Defining the times of ramp generator A

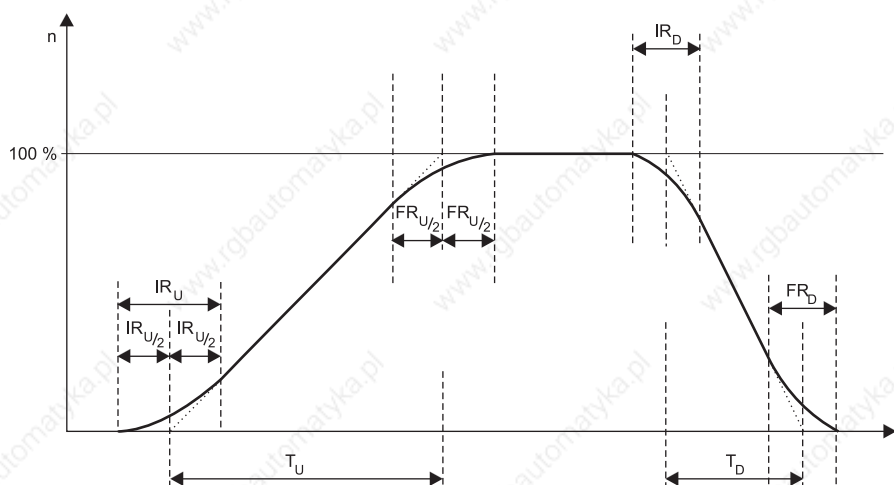

Illustration 66: Times of ramp generator A

IR _U	Initial rounding, UP	IR _D	Initial rounding, DOWN
T _U	Ramp-up time	T _D	Ramp-down time
FR _U	Final rounding, UP	FR _D	Final rounding, DOWN

The resulting ramp-up/down times are as follows:

$$t_{up} = \frac{P\ 227}{2} + P\ 226 + \frac{P\ 228}{2} \quad \text{und} \quad t_{down} = \frac{P\ 230}{2} + P\ 229 + \frac{P\ 231}{2}$$

For ramp generator parameter set 2, enter the values of the respective parameters

5.16 Parameter description - Ramp generator A

P 226 Ramp-up time 1 (ramp generator A)

Time valid for one 100.00 % setpoint difference and for a setpoint range of 0.00 % to +100.00 % and from 0.00 % to - 100.00 %.

Range:	0.00 s...600.00 s	Save:	Data record
Standard value:	2.00 s	Modify:	Online

P 227 Initial rounding 1, ramp-up (ramp generator A)

Range:	0.00 s...10.00 s	Save:	Data record
Standard value:	0.00 s	Modify:	Online

P 228 Final rounding 1, ramp-up (ramp generator A)

Range:	0.00 s...10.00 s	Save:	Data record
Standard value:	0.00 s	Modify:	Online

P 229 Ramp-down time 1 (ramp generator A)

Time valid for one 100.00 % setpoint difference and for a setpoint range from +100.00 % to 0.00 % and from -100.00 % to 0.00 %.

Range:	0.00 s...600.00 s	Save:	Data record
Standard value:	2.00 s	Modify:	Online

P 230 Initial rounding 1, ramp-down (ramp generator A)

Range:	0.00 s...10.00 s	Save:	Data record
Standard value:	0.00 s	Modify:	Online

P 231 Final rounding 1, ramp-down (ramp generator A)

Range:	0.00 s...10.00 s	Save:	Data record
Standard value:	0.00 s	Modify:	Online

P 232 Ramp-up time 2 (ramp generator A)

Time valid for one 100.00 % setpoint difference and for a setpoint range of 0.00 % to +100.00 % and from 0.00 % to -100.00 %.

Range:	0.00 s...600.00 s	Save:	Data record
Standard value:	2.00 s	Modify:	Online

P 233 Initial rounding 2, ramp-up (ramp generator A)

Range:	0.00 s...10.00 s	Save:	Data record
Standard value:	0.00 s	Modify:	Online

P 234 Final rounding 2, ramp-up (ramp generator A)

Range:	0.00 s...10.00 s	Save:	Data record
Standard value:	0.00 s	Modify:	Online

P 235 Ramp-down time 2 (ramp generator A)

Time valid for one 100.00 % setpoint difference and for a setpoint range from +100.00 % to 0.00 % and from -100.00 % to 0.00 %.

Range:	0.00 s...600.00 s	Save:	Data record
Standard value:	2.00 s	Modify:	Online

P 236 Initial rounding 2, ramp-down (ramp generator A)

Range:	0.00 s...10.00 s	Save:	Data record
Standard value:	0.00 s	Modify:	Online

P 237 Final rounding 2, ramp-down (ramp generator A)

Range:	0.00 s...10.00 s	Save:	Data record
Standard value:	0.00 s	Modify:	Online

Digital input function DIF 16 can be used to switch between ramp generator parameter sets 1 and 2.

P 238 Correction ON/OFF (ramp generator A)

Corrects the ramp generator A while the drive is disabled.

0: Ramp generator A is not corrected. Ramp generator A is active even while the drive is disabled.

1: Ramp generator A is corrected. Ramp generator A does not respond to the applied setpoint(s) while the drive is disabled. The output of ramp generator A is set to the value of the signal selected with parameter P 239.

Range:	0...1	Save:	Primary data
Standard value:	1	Modify:	Online

P 239 Selection, correction signal (ramp generator A)

Selection of the signal (ALink) to whose value the output of ramp generator A is set while the drive is disabled.

Range:	0...330	Save:	Primary data
Range:	0...350 from S03.03		
Standard value:	59	Modify:	Online

The output of ramp generator A is available in **AL 44**.

5.17 Parameter description - Ramp generator B

P 245 Setpoint selection (ramp generator B)

Selects the signal (ALink) at ramp generator input B.

Range: 0...330 Save: Data record

Range: 0...350 from S03.03

Standard value: 0 (= 0 %) Modify: Online

P 246 Ramp-up time (ramp generator B)

Time valid for one 100.00 % setpoint difference and for a setpoint range of 0.00 % to +100.00 % and from 0.00 % to -100.00 %.

Range: 0.00 s...600.00 s Save: Data record

Standard value: 2.00 s Modify: Online

P 247 Ramp-down time (ramp generator B)

Time valid for one 100.00 % setpoint difference and for a setpoint range from +100.00 % to 0.00 % and from -100.00 % to 0.00 %.

Range: 0.00 s...600.00 s Save: Data record

Standard value: 2.00 s Modify: Online

The output of ramp generator B is available in **AL 47**.

5.18 Parameter description - Speed controller actual values

P 250 Status word (actual value detection)

Parameter number in hexadecimal representation: 0FA

Bit no.	Description	DLink
0	1: Actual value detection active	DL0304
1	0: Spare	DL0305
2	0: Spare	DL0306
3	1: Error in module	DL0307
4	0: Spare	DL0308
5	n > overspeed	DL0309
6	0: Spare	DL0310
7	0: Spare	DL0311
8	0: Spare	DL0312
9	0: Spare	DL0313
10	n > n _{min}	DL0314
11	0: Spare	DL0315
12	n > n _{x1}	DL0316
13	n > n _{x2}	DL0317
14	n > n _{x3}	DL0318
15	n > n _{x4}	DL0319

P 255 Selection of actual value and field unit setting



NOTE

While armature voltage control P 255 = 1, it is only allowed to switch off the internal field device (P 372 = 0), when an external field device with field current monitoring is operating!

Change from field weakening to constant field only while the controller is disabled and the motor is in standstill condition (n = 0) (save data record change accordingly)!

From S 03.10 changing parameters (per keyboard, PC or data interface) is only possible with disabled controller and standstill condition (standstill message, speed is lower than the speed threshold set with P 505 / P 506). If P 255 cannot be changed when the motor stands still, increase the value of P 505, change parameter P 255 and then reset P 505 on the former needed value.

5.18 Parameter description - Speed controller actual values

This parameter must be set also when current control is set (P 102 = -2) !

Value	Description
1	Armature voltage and constant field
2	Analog tachogenerator and constant field
3	Incremental encoder 1 and constant field
4	Spare
5	Analog tachogenerator and field weakening
6	Incremental encoder 1 and field weakening
7	Spare

Range: 1...7 Save: Data record

Standard value: 1 Modify: Offline

The selected speed controller actual value is available in **AL 57** (without offset - P 267) and/or **AL 59** (with offset - P 267).

P 256 Armature voltage adjustment

'Speed' adjustment during armature voltage control (P 255 = 1). Motor speed decreases at input values < 1.00 and increases at input values > 1.00.

Range: 0.90...1.10 Save: Data record

Standard value: 1.00 Modify: Online

The armature voltage actual value for the speed controller is available in **AL 53**.

P 257 Tachogenerator range

Defines the analog tachogenerator connection (at P 255 = 2 and 5).



NOTE

Make sure in particular that the tachogenerator range selected with P 257 is in accordance with tachogenerator connection at terminal X3 of board 3.9711!

Value	Tachogenerator voltage (P 258)	Connection terminals
1	4 V to 20 V range	X3: 3 and X3: 4
2	15 V to 75 V range	X3: 2 and X3: 4
3	60 V to 240 V range	X3: 1 and X3: 4

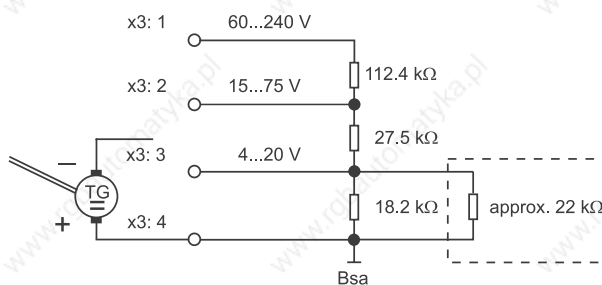

Range: 1...3
Standard value: 1

Save: Data record
Modify: Offline

P 258 Tachogenerator voltage

Input of the tachogenerator voltage at maximum speed (at P 255 = 2 and 5).

Range: 4.00 V...240.00 V
Standard value: 10.00 V

Save: Data record
Modify: Online

The tachogenerator actual value is available in **AL 54**.

P 259 Tachogenerator polarity change (from S 03.20)

Inverting the speed actual value signal of the tachogenerator input.

In general, the tacho generator should be connected with correct polarity. For special use, e.g. run of a BKD with a change-over of the field current, the actual value signal can be inverted with this parameter.

Value	Meaning
1	Polarity change switched-off
2	Polarity change switched-on

Range: 1... 2
Standard value: 1

Save: Data record
Modify: Offline

5.18 Parameter description - Speed controller actual values

P 260 Status word of incremental encoder

Parameter number in hexadecimal representation: 0104

Bit no.	Description	DLink
0	0: Spare	DL0336
1	0: Spare	DL0337
2	0: Spare	DL0338
3	1: Error in module	DL0339
4	0: Spare	DL0340
5	0: Spare	DL0341
6	0: Spare	DL0342
7	0: Spare	DL0343
8	1: Warning - Evaluation limit frequency exceeded	DL0344
9	0: Spare	DL0345
10	0: Spare	DL0346
11	0: Spare	DL0347
12	0: Spare	DL0348
13	0: Spare	DL0349
14	0: Spare	DL0350
15	0: Spare	DL0351

P 261 Increments of incremental encoder 1

Sets the number of increments of the used incremental encoder (at P 255 = 3 and 6). The incremental encoder **must have two** tracks displaced against each other by 90°, the frequency limit of the incremental encoder **must be** ≥ 300 kHz.

Max. frequency of the encoder evaluation: 200 kHz

max. speed:
$$n_{\max} = \frac{60 \cdot 200000}{P\ 261} [\text{min}^{-1}]$$

Theoretical minimum speed:
$$n_{\min} = \frac{90 \cdot f_{\text{mains}}}{P\ 261} [\text{min}^{-1}]$$

Actual value signal resolution:
$$A = \frac{9000 \cdot f_{\text{mains}}}{P\ 261 \cdot P\ 262} \%$$

Adaptation of the input for incremental encoder 1 (SUB-D plug X24, 15-pole female connector):

5 V differential signals Board 3.9711 W1600 B-A

24 V single ended signals Board 3.9711 W1600 B-C

Range: 100...10000 Save: Primary data
 Standard value: 1024 Modify: Offline

P 262 Max. speed of incremental encoder 1

Sets the maximum speed (at P 255 = 3 and 6).

Collision of parameters P 261 and P 262 (max. frequency of 200 kHz exceeded) limits the speed setting (P 262) and displays warning '1' in the display (P 039) (formula for the maximum possible speed refer P 261).

Range: 100...6000 [min⁻¹] Save: Data record
 Standard value: 500 [min⁻¹] Modify: Online

P 263 Polarity reversal of incremental encoder 1

Required if the directions of rotation of incremental encoder and motor differ due to the mechanical attachment of the incremental encoder.

Value	Description
1	Polarity reversal OFF
2	Polarity reversal ON

Range: 1...2 Save: Primary data
 Standard value: 1 Modify: Offline

The actual value of the incremental encoder is available in **AL 55**.

P 267 Speed offset (for the actual value at the speed controller)

Set value is added to the actual value, 100 corresponds to 0.61 % of the maximum speed. Effective after actual value smoothing (P 268).

Range: -400...+400 Save: Data record
 Standard value: 0 Modify: Online

P 268 Actual speed smoothing

As time constants lower than 8 ms remain ineffective (at $f_{Mains} = 45$ Hz), input of values between 1 and 7 ms results in automatic input of a value of 8 ms. Smoothing is switched off at a setting of 0 ms. There also is a hardware smoothing of approx. 1 ms.

Range: 0...100 ms Save: Data record
 Standard value: 10 ms Modify: Online

P 269 Derivative-action time (actual speed D component)

Sets the derivative-action time of the DT₁ element.

Range: 0...1000 ms Save: Data record
 Standard value: 10 ms Modify: Online

5.18 Parameter description - Speed controller actual values

P 270 Factor, D component

Multiplier for the output of the DT₁ element (P 269).

Range: 0.0...5.0

Save:

Data record

Standard value: 0.0

Modify:

Online

The effective D component of the actual value is available in **AL 62**.

5.19 Parameter description - Speed controller setpoints

P 300 Status word (speed controller)

Parameter number in hexadecimal representation: 012C

Bit no.	Description	DLink
0	=0: Speed controller disabled	DL0352
1	=1: Speed controller enabled	DL0353
	=2: Spare	
	=3: Speed controller deactivated (current control)	
2	=0: Torque direction 1 requested	DL0354
	=1: Torque direction 2 requested	
3	1: Error in module	DL0355
4	1: Drive blocked	DL0356
5	1: Speed-dependent limit active	DL0357
6	1: Gear protection limit active	DL0358
7	1: External limit active	DL0359
8	1: Drift lock active	DL0360
9	1: Setpoint limited	DL0361
10	1: Ixt limit is reached (from S 03.20)	DL0362
11	0: Speed controller output positive	DL0363
	1: Speed controller output negative	
12	1: Setpoint reached ($n_{Actual} = n_{Set}$)	DL0364
13	1: Parameter limit active (P 328 / P 329)	DL0365
14	1: Current limit reached	DL0366
15	1: Speed controller output at one of the limits (bits 5,6,7,10 or 13) (from S 03.20)	DL0367

5.19 Parameter description - Speed controller setpoints

P 301 Control word (speed controller)

Parameter number in hexadecimal representation: 012D

Bit no.	Description	DLink
0	0: Disable speed controller setpoint (after addition)	DL0368
1	Spare: Always set to zero	DL0369
2	Spare: Always set to zero	DL0370
3	Spare: Always set to zero	DL0371
4	Spare: Always set to zero	DL0372
5	Spare: Always set to zero	DL0373
6	Spare: Always set to zero	DL0374
7	Spare: Always set to zero	DL0375
8	Spare: Always set to zero	DL0376
9	Spare: Always set to zero	DL0377
10	Spare: Always set to zero	DL0378
11	Spare: Always set to zero	DL0379
12	Spare: Always set to zero	DL0380
13	Spare: Always set to zero	DL0381
14	Spare: Always set to zero	DL0382
15	Spare: Always set to zero	DL0383

P 302 Controller type (speed controller)

Defines the speed controller parameter set

Value	Description
xx00	Proportional and integral components not active, controller switched off, output = 0
xx01	P-component OFF, I-component active, I-controller, P 315 and P 316 are integration times
xx10	P-component active, I-component OFF, P controller
xx11	P- and I-components active, PI controller

Range: xx00/xx01/xx10/xx11 Save: Data record

Standard value: 11hex Modify: Online

P 305 Setpoint selection, input 1 (speed controller)

Selects the signal (ALink) effective as setpoint at the speed controller. Is added to the signals selected with parameters P 306, P 307 and P 308.

Range: 0...330 Save: Data record

Range: 0...350 from S03.03

Standard value: 44 Modify: Online

P 306 Setpoint selection, input 2 (speed controller)

Selects the signal (ALink) effective as setpoint at the speed controller. Is added to the signals selected with parameters P 305, P 307 and P 308.

Range:	0...330	Save:	Data record
Range:	0...350	from S03.03	
Standard value:	0 (= 0 %)	Modify:	Online

P 307 Setpoint selection, input 3 (speed controller)

Selects the signal (ALink) effective as setpoint at the speed controller. Is added to the signals selected with parameters P 305, P 306 and P 308.

Range:	0...330	Save:	Data record
Range:	0...350	from S03.03	
Standard value:	0 (= 0 %)	Modify:	Online

P 308 Setpoint selection, input 4 (speed controller)

Selects the signal (ALink) effective as setpoint at the speed controller. Is added to the signals selected with parameters P 305, P 306 and P 307.

Range:	0...330	Save:	Data record
Range:	0...350	from S03.03	
Standard value:	0 (= 0 %)	Modify:	Online

P 310 P-gain K_P1 (speed controller)

Proportional gain 1 of the speed controller. Is effective when the signal selected with parameter P 314 falls below the value set in parameter P 312.

Range:	0.10...100.00	Save:	Data record
Standard value:	10.00	Modify:	Online

P 311 P-gain K_P2 (speed controller)

Proportional gain 2 of the speed controller. Is effective when the signal selected with parameter P 314 exceeds the value set in parameter P 313.

Range:	0.10...100.00	Save:	Data record
Standard value:	10.00	Modify:	Online

The currently effective proportional gain is available in **AL 74**.

P 312 Threshold, P-gain K_P1

The proportional gain K_P1 of the speed controller (P 310) becomes effective as soon as the signal selected with parameter P 314 falls below the set value.

Range:	0.00 %...100.00 %	Save:	Data record
Standard value:	100.00 %	Modify:	Online

5.19 Parameter description - Speed controller setpoints

P 313 Threshold, P-gain K_P 2

The proportional gain K_P 2 of the speed controller (P 311) becomes effective as soon as the signal selected with parameter P 314 exceeds the set value.

Range:	0.00 %...100.00 %	Save:	Data record
Standard value:	100.00 %	Modify:	Online

P 314 Adaptation signal K_P

Selects the signal (ALink) used to adapt the speed controller P-gain.

Range:	0...330	Save:	Data record
Range:	0...350		from S03.03
Standard value:	59	Modify:	Online

- The threshold set with parameter P 313 is higher than the one set with parameter P 312.

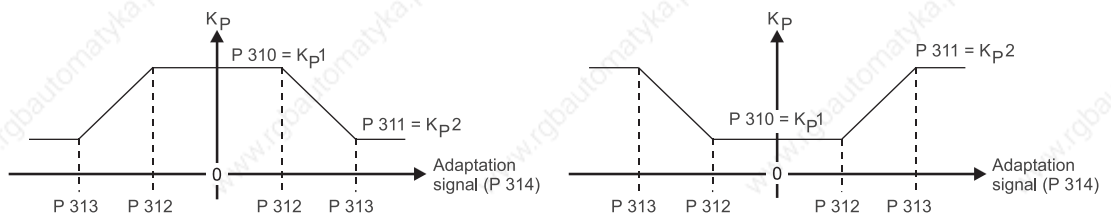

Illustration 67: K_P adaptation for the speed controller - Fig. 1

- The threshold set with parameter P 313 is lower than or equal to the one set with parameter P 312.

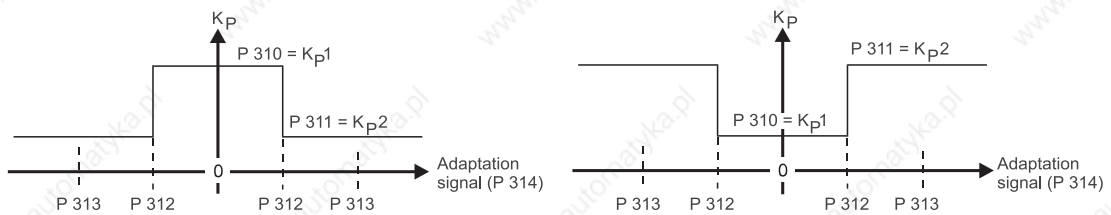

Illustration 68: K_P adaptation for the speed controller - Fig. 2

P 315 Integral-action time T_{n1} (speed controller)

Speed controller integral-action time 1. Is effective when the signal selected with parameter P 319 falls below the value set in parameter P 317.

Range:	0.020 s...10.000 s	Save:	Data record
Standard value:	0.400 s	Modify:	Online

P 316 Integral-action time T_{n2} (speed controller)

Speed controller integral-action time 2. Is effective when the signal selected with parameter P 319 exceeds the value set in parameter P 318.

Range: 0.020 s...10.000 s Save: Data record
 Standard value: 0.400 s Modify: Online

The currently effective integral-action time is available in **AL 75**.

P 317 Threshold, integral-action time T_{n1} (speed controller)

The speed controller integral-action time T_{n1} (P 315) becomes effective as soon as the signal selected with parameter P 319 falls below the set value.

Range: 0.00 %...100.00 % Save: Data record
 Standard value: 100.00 % Modify: Online

P 318 Threshold, integral-action time T_{n2} (speed controller)

The speed controller integral-action time T_{n2} (P 316) becomes effective as soon as the signal selected with parameter P 319 exceeds the set value.

Range: 0.00 %...100.00 % Save: Data record
 Standard value: 100.00 % Modify: Online

P 319 Adaptation signal T_n (speed controller)

Selects the signal (ALink) which is used to adapt the speed controller integral-action time.

Range: 0...330 Save: Data record
 Range: 0...350 from S03.03
 Standard value: 59 Modify: Online

► The threshold set with parameter P 318 is higher than the one set with parameter P 317.

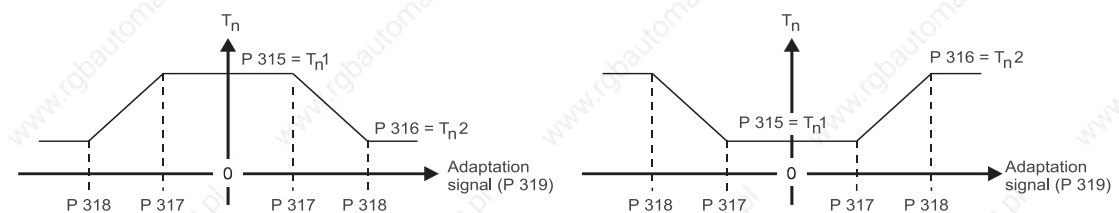

Illustration 69: T_n adaptation for the speed controller - Fig. 1

5.19 Parameter description - Speed controller setpoints

- ▶ The threshold set with parameter P 318 is lower than or equal to the one set with parameter P 317.

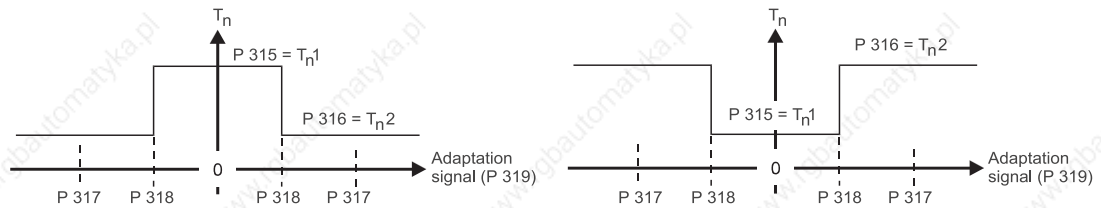

Illustration 70: T_n adaptation for the speed controller - Fig. 2

P 321 Preset integral component - set TD (speed controller)

While the drive is disabled, the set value is transferred into the I component of the speed controller (AL 72), and the associated torque direction is set with polarity for BKF-series converters (positive values result in torque direction 1, negative values in torque direction 2), for example improved starting characteristics for lift drives (BKF).

Range: -100.00 %...+100.00 % Save: Data record
 Standard value: 0.00 % Modify: Online

P 322 Drift lock (speed controller)

The drift lock settings are effective only in speed control (P 102 = -3).

If the actual value falls below the threshold set with P 323 **and** the setpoint falls below the threshold set with P 324, the speed controller feedback is affected as follows:

Value	Description
0	Speed controller feedback not affected
1	Speed controller I component is short-circuited, P component active
2	Speed controller feedback is short-circuited, the drive coasts, but is not disabled!

The feedback or the integral component is enabled if the setpoint exceeds the threshold set with P 324, **or** the actual value exceeds the threshold set with P 323.

Range: 0...2 Save: Data record
 Standard value: 0 Modify: Online

P 323 Drift lock, actual value threshold (speed controller)

Range: 0.00 %...20.00 % Save: Data record
 Standard value: 1.00 % Modify: Online

P 324 Drift lock, setpoint threshold (speed controller)

Range: 0.00 %...20.00 % Save: Data record
 Standard value: 1.00 % Modify: Online

5.20 Parameter description - Current limit

P 325 Current limit torque direction 1 (positive)

Input in percent of parameter P 072

Range: 0.00 %...100.00 %

Save: Data record

Standard value: 100.00 %

Modify: Online

P 326 Current limit torque direction 2 (negative)

Input in percent of parameter P 072

Range: 0.00 %...-100.00 %

Save: Data record

Standard value: -100.00 %

Modify: Online

P 328 External current limit TD1

Selects the signal (ALink) that acts upon the current limit TD 1.

An input signal of 0 to +100 % sets the current limit accordingly for torque direction 1. For negative signals, this current limit remains at 0 % !

Range: 0...330

Save: Data record

Range: 0...350 from S03.03

Standard value: 1 (= +100 %)

Modify: Online

P 329 External current limit TD2

Selects the signal (ALink) that acts upon the current limit TD 2.

An input signal of 0 to -100 % sets the current limit accordingly for torque direction 2. For positive signals, this current limit remains at 0 % !

Range: 0...330

Save: Data record

Range: 0...350 from S03.03

Standard value: 2 (= -100 %)

Modify: Online

P 330 Threshold, speed-dependent current limit n_x

Speed from which the speed-dependent current limitation is activated. Input value in percent of the maximum speed.

Range: 0.00 %...100.00 %

Save: Data record

Standard value: 100.00 %

Modify: Online

P 331 Current limit at n_{\max} (I_{End}) (speed-dependent current limitation)

Current limit at maximum speed. Input in percent of parameter P 072.

Range: 0.00 %...100.00 %

Save: Data record

Standard value: 100.00 %

Modify: Online

5.20 Parameter description - Current limit

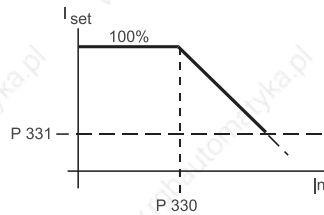

P 332 Ramp, gear protection (ramp-up and down time)

Ramp that acts upon the current limitation only after a torque change or after the drive has been enabled, thus limiting the rate of current rise. The time refers to a current setpoint change of 100.00 %.

Range: 0...500 ms

Save:

Data record

Standard value: 0 ms

Modify:

Online

P 333 Hysteresis, torque direction detection

Changeover threshold (torque change), symmetrical to zero.

Range: 0.00 %..6.25%

Save:

Data record

Range: 0.00 %...20.00 % from S 03.06

Standard value: 2.50 %

Modify:

Online

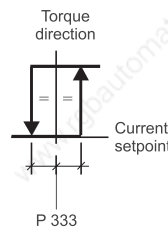

P 334 Zero-current delay (for torque change, BKF)

Delays the zero-current signal by the set time. This extends the changeover pause during a torque change by the input time (required for large inductances in the DC circuit).

Observe parameter **P 518**.

Range: 0...200 ms

Save:

Data record

Standard value: 0 ms

Modify:

Online

P 335 Additional current setpoint 1 (from S03.06)

Selects the ALink whose value is added to the speed controller output together with the signals selected with parameters P 336, P 337 and P 338 to form the resulting current setpoint.

The total of the additional current setpoints is limited to $\pm 100\%$ prior to addition to the speed controller output. This limited total is available in **AL 209**.

Range:	0...350	Save:	Data record
Standard value:	0 (= 0 %)	Modify:	Online

P 336 Additional current setpoint 2 (from S03.06)

Selects the ALink whose value is added to the speed controller output together with the signals selected with parameters P 335, P 337 and P 338 to form the resulting current setpoint.

The sum total of the additional current setpoints is limited to $\pm 100\%$ prior to addition to the speed controller output. This limited sum total is available in **AL 209**.

Range:	0...350	Save:	Data record
Standard value:	0 (= 0 %)	Modify:	Online

P 337 Additional current setpoint 3 (from S03.06)

Selects the ALink whose value is added to the speed controller output together with the signals selected with parameters P 335, P 336 and P 338 to form the resulting current setpoint.

The sum total of the additional current setpoints is limited to $\pm 100\%$ prior to addition to the speed controller output. This limited sum total is available in **AL 209**.

Range:	0...350	Save:	Data record
Standard value:	0 (= 0 %)	Modify:	Online

P 338 Additional current setpoint 4 (from S03.06)

Selects the ALink whose value is added to the speed controller output together with the signals selected with parameters P 335, P 336 and P 337 to form the resulting current setpoint.

The sum total of the additional current setpoints is limited to $\pm 100\%$ prior to addition to the speed controller output. This limited sum total is available in **AL 209**.

Range:	0...350	Save:	Data record
Standard value:	0 (= 0 %)	Modify:	Online

**NOTE**

When using the additional current setpoints (selection with parameters P 335 to P 338), make sure to observe the polarity of the resulting additional setpoint available in AL 209 !

Otherwise a **dangerous** or unwanted **state** may occur at the machine !

5.21 Parameter description - Current controller

5.21 Parameter description - Current controller

P 350 State (armature current controller)

Parameter number in hexadecimal representation: 015E

Bit no.	Description	DLink
0	1: Current controller enabled	DL0384
1	0: Spare	DL0385
2	0: Spare	DL0386
3	1: Error in module	DL0387
4	0: Spare	DL0388
5	0: Spare	DL0389
6	1: Inverter firing angle (α_W) reached	DL0390
7	1: Rectifier firing angle (α_G) reached	DL0391
8	1: I_{A_x1} threshold exceeded (refer P521)	DL0392
9	1: I_{A_x2} threshold exceeded (refer P523)	DL0393
10	0: Spare	DL0394
11	0: Spare	DL0395
12	0: Spare	DL0396
13	0: Spare	DL0397
14	0: Spare	DL0398
15	0: Spare	DL0399

P 352 Controller type (current controller)

Defines the current controller parameter set

Value	Description
xx00	P- and I-components not active, controller switched off, output = 0
xx01	P-component OFF, I-component active, I-controller, P 354 is integration time
xx10	P-component active, I- component OFF, P controller
xx11	P- and I-components active, PI controller

Range: xx00/xx01/xx10/xx11

Save: Data record

Standard value: 11hex

Modify: Online

P 353 P-gain K_P (current controller)

Range: 0.01...100.00

Save: Data record

Standard value: 0.05

Modify: Online

P 354 **Integral-action time T_n (current controller)**

Range: 0.010 s...1,500 s Save: Data record
 Standard value: 0.020 s Modify: Online

P 357 **Current setpoint, integrator**

Limits current rise in the armature circuit. The current setpoint integrator is **always** effective. The time refers to a current setpoint change of 100.00 %. Required for older-model motors (brush sparking in the case of motors with unlaminated yoke due to flow distortion upon excessive rates of current rise in the armature circuit).

Range: 0...100 ms Save: Data record
 Standard value: 0 ms Modify: Online

P 359 **Current precontrol ON/OFF**

Value	Description
0	Current controller in operation only, current precontrol OFF
1	Current controller and current precontrol active

Range: 0...1 Save: Primary data
 Standard value: 1 Modify: Offline

P 360 **Rectifier firing angle limit α_G (armature)**

Minimum angle for the control unit (LED H706)

Range: 10°...90° Save: Data record
 Standard value: 10° for BKD (1-Q) Modify: Online
 30° for BKF (4-Q)

P 361 **Inverter firing angle limit α_W (armature)**

Maximum angle for the control unit (LED H706)

Range: 90°...170° Save: Data record
 Standard value: 150° Modify: Online

P 362 **di_{set}/dt precontrol ON/OFF**

Optimizes current rise within the armature circuit.

Value	Description
0	di_{set}/dt component not active
1	di_{set}/dt component active

Range: 0...1 Save: Primary data
 Standard value: 1 Modify: Offline

5.22 Parameter description - Field unit

P 370 Status word field unit

Parameter number in hexadecimal representation: 0172

Bit no.	Description	DLink
0	1: Field unit ON	DL0416
1	0: Constant field 1: Field weakening	DL0417
2	0: Spare	DL0418
3	1: Error in module	DL0419
4	1: Minimum current limit reached	DL0420
5	1: Maximum current limit reached	DL0421
6	1: Inverter firing angle (α_w) reached	DL0422
7	1: Rectifier firing angle (α_G) reached	DL0423
8	1: Field current actual value < 50 % field current setpoint (incl. P 385)	DL0424
9	0: Spare	DL0425
10	0: Spare	DL0426
11	0: Spare	DL0427
12	0: Spare	DL0428
13	0: Spare	DL0429
14	0: Spare	DL0430
15	0: Spare	DL0431

P 372 Field unit ON/OFF

Pay attention to NOTE at parameter P 255!

Value	Description
0	Internal field unit OFF The firing pulses of the field unit are disabled internally, field connection monitoring and field current monitoring are OFF.
1	Internal field unit and monitoring functions active

Range: 0...1

Save: Data record

Standard value: 1

Modify: Offline

P 373 Field EMF controller - controller type (EMF controller active only during field weakening)

Defines the field EMF controller parameter set

Value	Description
xx00	P- and I-components not active, controller switched off, output = 0
xx01	P-component OFF, I-component active, I controller, P 375 is integration time
xx10	P-component active, I-component OFF, P controller
xx11	P- and I-components active, PI controller

Range: xx00/xx01/xx10/xx11 Save: Data record
 Standard value: 11hex Modify: Online

P 374 Field EMF controller - P-gain K_P

Range: 0.10...100.00 Save: Data record
 Standard value: 1.00 Modify: Online

P 375 Field EMF controller - integral-action time T_n

Range: 0,020 s...10,000 s Save: Data record
 Standard value: 0,200 s Modify: Online

P 377 Field current controller - controller type

Defines the field EMF controller parameter set

Value	Description
xx00	P- and I-components not active, controller switched off, output = 0
xx01	P-component OFF, I-component active, I controller, P 379 is integration time
xx10	P-component active, I-component OFF, P controller
xx11	P- and I-components active, PI controller

Range: xx00/xx01/xx10/xx11 Save: Data record
 Standard value: 11hex Modify: Online

P 378 Field current controller - P gain K_P

Range: 0.10...100.00 Save: Data record
 Standard value: 1.00 Modify: Online

P 379 Field current controller - integral-action time T_n

Range: 0.020 s...10.000 s Save: Data record
 Standard value: 0.200 s Modify: Online

5.22 Parameter description - Field unit

P 381 Rectifier firing angle limit α_G (field)

Minimum firing angle for the control unit. 15° result in a max. field direct voltage of approx. $0.98 \times U_{\text{eff}}$ [V]. This does not take into account mains voltage drops due to the commutating chokes !

Range:	10°...90°	Save:	Data record
Standard value:	15°	Modify:	Online

P 382 Inverter firing angle limit α_W (field)

Maximum firing angle for the control unit. 150° result in a min. field direct voltage of approx. $0.067 \times U_{\text{eff}}$ [V]. This does not take into account mains voltage drops due to the commutating chokes !

Range:	90°...150°	Save:	Data record
Standard value:	150°	Modify:	Online

P 383 Field current setpoint for standstill field

Related to the field current set with parameter P 079.

The field current is reduced to this value after the contact 'Main contactor ON' was opened at terminal X2: 15 and the time set in P 384 has expired. Input value 100 % with this parameter if the field current is not to be reduced.

Range:	20 %...100 %	Save:	Data record
Standard value:	100 %	Modify:	Online

P 384 Delay to standstill field ON

Range:	0 s...120 s	Save:	Data record
Standard value:	30 s	Modify:	Online

P 385 Delay for field current monitoring

Time to trip for minimum field current monitoring (threshold = 50 % of the field current setpoint).

The field current monitoring state is displayed in DLink 21. DLink 21 = HIGH means that the monitoring function has tripped.

Range:	1s...30 s	Save:	Data record
Standard value:	1s	Modify:	Online

P 386 **Field monitoring ON/OFF**

Value	Description
0	Field current monitoring is active only if the contact 'Main contactor ON' at terminal X2: 15 is closed.
1	Field current monitoring always active independent of contact 'Main contactor ON'

Range: 0...1

Save:

Data record

Standard value: 1

Modify:

Online

5.23 Parameter description - Digital inputs

P 400 Status word digital inputs

Parameter number in hexadecimal representation: 0190

Bit no.	Description	DLink
0	0: Spare	DL0448
1	0: Spare	DL0449
2	0: Spare	DL0450
3	1: Error in module	DL0451
4	1: Pulse enable at terminal	DL0452
5	1: Quick stop signal at terminal	DL0453
6	1: Controller enable at terminal	DL0454
7	1: Main contactor enable at terminal	DL0455
8	1: Digital input 1 HIGH	DL0456
9	1: Digital input 2 HIGH	DL0457
10	1: Digital input 3 HIGH	DL0458
11	1: Digital input 4 HIGH	DL0459
12	1: Digital input 5 HIGH	DL0460
13	1: Digital input 6 HIGH	DL0461
14	1: Digital input 7 HIGH	DL0462
15	1: Digital input 8 HIGH	DL0463

P 401 Function, digital input 1 (X2: 19)

Enters the digital input function assigned to this terminal. For a description of the available functions 0 to 33 refer to chapter [Digital input functions DIF](#) from page 94.

Range: 0 ...33 (DIF no.) Save: Primary data
 Standard value: 7 (Acknowledge error) Modify: Offline

P 402 Function, digital input 2 (X2: 20)

Enters the digital input function assigned to this terminal. For a description of the available functions 0 to 33 refer to chapter [Digital input functions DIF](#) from page 94.

Range: 0 ...33 (DIF no.) Save: Primary data
 Standard value: 0 (OFF) Modify: Offline

P 403 Function, digital input 3 (X2: 21)

Enters the digital input function assigned to this terminal. For a description of the available functions 0 to 33 refer to chapter [▶Digital input functions DIF◀](#) from page 94.

Range:	0 ...33 (DIF no.)	Save:	Primary data
Standard value:	0 (OFF)	Modify:	Offline

P 404 Function, digital input 4 (X2: 22)

Enters the digital input function assigned to this terminal. For a description of the available functions 0 to 33 refer to chapter [▶Digital input functions DIF◀](#) from page 94.

Range:	0 ...33 (DIF no.)	Save:	Primary data
Standard value:	0 (OFF)	Modify:	Offline

P 405 Function, digital input 5 (X2: 23)

Enters the digital input function assigned to this terminal. For a description of the available functions 0 to 33 refer to chapter [▶Digital input functions DIF◀](#) from page 94.

Range:	0 ...33 (DIF no.)	Save:	Primary data
Standard value:	0 (OFF)	Modify:	Offline

P 406 Function, digital input 6 (X2: 24)

Enters the digital input function assigned to this terminal. For a description of the available functions 0 to 33 refer to chapter [▶Digital input functions DIF◀](#) from page 94.

Range:	0 ...33 (DIF no.)	Save:	Primary data
Standard value:	0 (OFF)	Modify:	Offline

P 407 Function, digital input 7 (X2: 25)

Enters the digital input function assigned to this terminal. For a description of the available functions 0 to 33 refer to chapter [▶Digital input functions DIF◀](#) from page 94.

Range:	0 ...33 (DIF no.)	Save:	Primary data
Standard value:	0 (OFF)	Modify:	Offline

P 408 Function, digital input 8 (X2: 26)

Enters the digital input function assigned to this terminal. For a description of the available functions 0 to 33 refer to chapter [▶Digital input functions DIF◀](#) from page 94.

Range:	0 ...33 (DIF no.)	Save:	Primary data
Standard value:	0 (OFF)	Modify:	Offline

5.24 Parameter description - Digital input multipliers

5.24 Parameter description - Digital input multipliers

Multiplier 1 (or multiplier 2) can be assigned to any of the 8 digital inputs (X2: 19 to X2: 26) and has four outputs each of which is assigned a function (DIF no.). This way, the digital input x can initiate up to four different actions at the same time. Enter the value 30 in the associated parameter (P 401 to P 408) to switch the multiplier to digital input x. It is also possible to define multiplier 2 as target for multiplier 1. The digital input x can then initiate max. 7 actions.

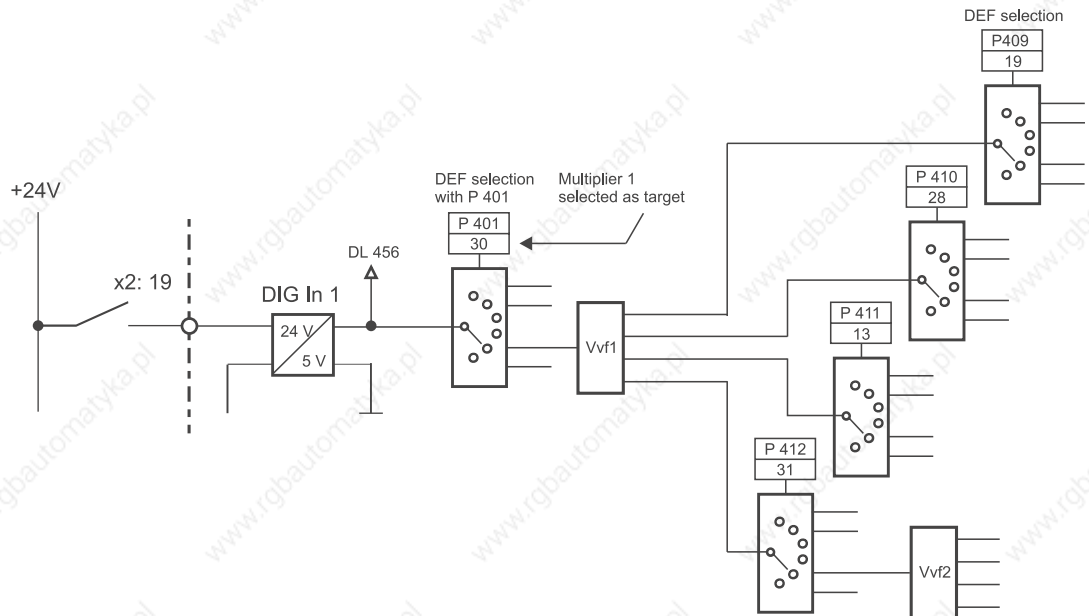

Illustration 71: Multiplier 1 and multiplier 2



NOTE

Only multiplier 2 must be connected after multiplier 1. The combination the other way round is not permissible.

In that case multiplier 1 has no effect !

Entering the own multiplier as target is not permissible either !

P 409 Function, multiplier 1.1 (multiplier 1, output 1)

Range: 0/ 7 ...29/31 ...33 (DIF no.)

Save:

Primary data

Standard value: 0 (OFF)

Modify:

Offline

P 410 Function, multiplier 1.2 (multiplier 1, output 2)

Range: 0/ 7 ...29/31 ...33 (DIF no.)

Save:

Primary data

Standard value: 0 (OFF)

Modify:

Offline

P 411 Function, multiplier 1.3 (multiplier 1, output 3)

Range: 0/ 7 ...29/31 ...33 (DIF no.) Save: Primary data
Standard value: 0 (OFF) Modify: Offline

P 412 Function, multiplier 1.4 (multiplier 1, output 4)

Range: 0/ 7 ...29/31 ...33 (DIF no.) Save: Primary data
Standard value: 0 (OFF) Modify: Offline

P 413 Function, multiplier 2.1 (multiplier 2, output 1)

Range: 0/ 7 ...29/32 ...33 (DIF no.) Save: Primary data
Standard value: 0 (OFF) Modify: Offline

P 414 Function, multiplier 2.2 (multiplier 2, output 2)

Range: 0/ 7 ...29/32 ...33 (DIF no.) Save: Primary data
Standard value: 0 (OFF) Modify: Offline

P 415 Function, multiplier 2.3 (multiplier 2, output 3)

Range: 0/ 7 ...29/32 ...33 (DIF no.) Save: Primary data
Standard value: 0 (OFF) Modify: Offline

P 416 Function, multiplier 2.4 (multiplier 2, output 4)

Range: 0/ 7 ...29/32 ...33 (DIF no.) Save: Primary data
Standard value: 0 (OFF) Modify: Offline

5.25 Parameter description - Digital outputs

P 420 Status word digital outputs

Parameter number in hexadecimal representation: 01A4

Bit no.	Description	DLink
0	0: Spare	DL0464
1	0: Spare	DL0465
2	0: Spare	DL0466
3	1: Error in module	DL0467
4	0: Spare	DL0468
5	0: Spare	DL0469
6	0: Spare	DL0470
7	0: Spare	DL0471
8	1: Digital output 1 at terminal HIGH	DL0472
9	1: Digital output 2 at terminal HIGH	DL0473
10	1: Digital output 3 at terminal HIGH	DL0474
11	1: Digital output 4 at terminal HIGH	DL0475
12	1: Digital output 5 at terminal HIGH	DL0476
13	1: Digital output 6 at terminal HIGH	DL0477
14	1: Ready-to-operate relay energised	DL0478
15	1: Main contactor relay energised	DL0479

P 421 Function, digital output 1 (at terminal X2: 5)

Selects the DLink whose state is output at this terminal.

Range: 0...1200 (DLink no.) Save: Data record
 Standard value: 4 (warning present) Modify: Online

P 422 ON delay, digital output 1

During this time, the selected message must be active for the output to adopt HIGH level. Any internal activation of the message, shorter than the set time, keeps the output at LOW level.

Range: 0.00 s...30.00 s Save: Data record
 0.00 s...160.00 s (from S 03.20)
 Standard value: 0.00 s Modify: Online

P 423 OFF delay, digital output 1

If the output was HIGH as a consequence of the selected message, it will remain active for the set time even after the message has been deactivated internally. If the internal message is no longer active for a period of time shorter than the OFF time, the output remains at HIGH level.

Range: 0.00 s...30.00 s Save: Data record
 0.00 s...160.00 s (from S 03.20)
 Standard value: 0.00 s Modify: Online

P 424 Polarity, digital output 1

Value	Description
1	Output at digital output 1 with polarity. Once the event selected with P 421 occurs, digital output 1 adopts HIGH level. Output HIGH active
2	Inverted output at digital output 1. Once the event selected with P421 occurs, digital output 1 adopts LOW level. Output LOW active

Range: 1...2 Save: Data record
 Standard value: 1 Modify: Online

P 425 Function, digital output 2 (at terminal X2: 6)

Selects the DLink whose state is to be output at this terminal.

Range: 0...1200 (DLink no.) Save: Data record
 Standard value: 0 Modify: Online

P 426 ON delay, digital output 2

During this time, the selected message must be active for the output to adopt HIGH level. Any internal activation of the message, shorter than the set time, keeps the output at LOW level.

Range: 0.00 s...30.00 s Save: Data record
 0.00 s...160.00 s (from S 03.20)
 Standard value: 0.00 s Modify: Online

P 427 OFF delay, digital output 2

If the output was HIGH as a consequence of the selected message, it will remain active for the set time even after the message has been deactivated internally. If the internal message is no longer active for a period of time shorter than the OFF time, the output remains at HIGH level.

Range: 0.00 s...30.00 s Save: Data record
 0.00 s...160.00 s (from S 03.20)
 Standard value: 0.00 s Modify: Online

5.25 Parameter description - Digital outputs

P 428 Polarity, digital output 2

Value	Description
1	Output at digital output 2 with polarity. Once the event selected with P 425 occurs, the digital output 2 adopts HIGH level. Output HIGH active
2	Inverted output at digital output 2. Once the event selected with P 425 occurs, the digital output 2 adopts LOW level. Output LOW active

Range: 1...2 Save: Data record
Standard value: 1 Modify: Online

P 429 Function, digital output 3 (at terminal X2: 7)

Selects the DLink whose state is to be output at this terminal.

Range: 0...1200 (DLink no.) Save: Data record
Standard value: 0 Modify: Online

P 430 ON delay, digital output 3

During this time, the selected message must be active for the output to adopt HIGH level. Any internal activation of the message, shorter than the set time, keeps the output at LOW level.

Range: 0.00 s...30.00 s Save: Data record
 0.00 s...160.00 s (from S 03.20)
Standard value: 0.00 s Modify: Online

P 431 OFF delay, digital output 3

If the output was HIGH as a consequence of the selected message, it will remain active for the set time even after the message has been deactivated internally. If the internal message is no longer active for a period of time shorter than the OFF time, the output remains at HIGH level.

Range: 0.00 s...30.00 s Save: Data record
 0.00 s...160.00 s (from S 03.20)
Standard value: 0.00 s Modify: Online

P 432 Polarity, digital output 3

Value	Description
1	Output at digital output 3 with polarity. Once the event selected with P 429 occurs, the digital output 3 adopts HIGH level. Output HIGH active
2	Inverted output at digital output 3. Once the event selected with P 429 occurs, the digital output 3 adopts LOW level. Output LOW active

Range: 1...2 Save: Data record
Standard value: 1 Modify: Online

P 433 Function, digital output 4 (at terminal X2: 8)

Selects the DLink whose state is to be output at this terminal.

Range: 0...1200 (DLink no.) Save: Data record
 Standard value: 0 Modify: Online

P 434 ON delay, digital output 4

During this time, the selected message must be active for the output to adopt HIGH level. Any internal activation of the message, shorter than the set time, keeps the output at LOW level.

Range: 0.00 s...30.00 s Save: Data record
 0.00 s...160.00 s (from S 03.20)
 Standard value: 0.00 s Modify: Online

P 435 OFF delay, digital output 4

If the output was HIGH as a consequence of the selected message, it will remain active for the set time even after the message has been deactivated internally. If the internal message is no longer active for a period of time shorter than the OFF time, the output remains at HIGH level.

Range: 0.00 s...30.00 s Save: Data record
 0.00 s...160.00 s (from S 03.20)
 Standard value: 0.00 s Modify: Online

P 436 Polarity, digital output 4

Value	Description
1	Output at digital output 4 with polarity. Once the event selected with P 433 occurs, the digital output 4 adopts HIGH level. Output HIGH active
2	Inverted output at digital output 4. Once the event selected with P 433 occurs, the digital output 4 adopts LOW level. Output LOW active

Range: 1...2 Save: Data record
 Standard value: 1 Modify: Online

P 437 Function, digital output 5 (at terminal X2: 9)

Selects the DLink whose state is to be output at this terminal.

Range: 0...1200 (DLink no.) Save: Data record
 Standard value: 0 Modify: Online

5.25 Parameter description - Digital outputs

P 438 ON delay, digital output 5

During this time, the selected message must be active for the output to adopt HIGH level. Any internal activation of the message, shorter than the set time, keeps the output at LOW level.

Range: 0.00 s...30.00 s Save: Data record
0.00 s...160.00 s (from S 03.20)
Standard value: 0.00 s Modify: Online

P 439 OFF delay, digital output 5

If the output was HIGH as a consequence of the selected message, it will remain active for the set time even after the message has been deactivated internally. If the internal message is no longer active for a period of time shorter than the OFF time, the output remains at HIGH level.

Range: 0.00 s...30.00 s Save: Data record
0.00 s...160.00 s (from S 03.20)
Standard value: 0.00 s Modify: Online

P 440 Polarity, digital output 5

Value	Description
1	Output at digital output 5 with polarity. Once the event selected with P 437 occurs, the digital output 5 adopts HIGH level. Output HIGH active
2	Inverted output at digital output 5. Once the event selected with P 437 occurs, the digital output 5 adopts LOW level. Output LOW active

Range: 1...2 Save: Data record
Standard value: 1 Modify: Online

P 441 Function, digital output 6 (at terminal X2: 10)

Selects the DLink whose state is output at this terminal.

Range: 0...1200 (DLink no.) Save: Data record
Standard value: 0 Modify: Online

P 442 ON delay, digital output 6

During this time, the selected message must be active for the output to adopt HIGH level. Any internal activation of the message, shorter than the set time, keeps the output at LOW level.

Range: 0.00 s...30.00 s Save: Data record
0.00 s...160.00 s (from S 03.20)
Standard value: 0.00 s Modify: Online

P 443 OFF delay, digital output 6

If the output was HIGH as a consequence of the selected message, it will remain active for the set time even after the message has been deactivated internally. If the internal message is no longer active for a period of time shorter than the OFF time, the output remains at HIGH level.

Range: 0.00 s...30.00 s Save: Data record
 0.00 s...160.00 s (from S 03.20)
 Standard value: 0.00 s Modify: Online

P 444 Polarity, digital output 6

Value	Description
1	Output at digital output 6 with polarity. Once the event selected with P 441 occurs, the digital output 6 adopts HIGH level. Output HIGH active
2	Inverted output at digital output 6. Once the event selected with P 441 occurs, the digital output 6 adopts LOW level. Output LOW active

Range: 1...2 Save: Data record
 Standard value: 1 Modify: Online

P 464 Smoothing, analog output 1

before scaling and offset.

As time constants lower than 8 ms remain ineffective (at $f_{\text{mains}} = 45 \text{ Hz}$), input of values between 1 and 7 ms results in automatic entry of a value of 8 ms. Smoothing is switched off at a setting of 0 ms.

Range: 0...1000 ms

Save:

Data record

Standard value: 0 ms

Modify:

Online

P 465 Polarity, analog output 1

before smoothing

Value	Description
0	Analog output 1 switched off, always 0 V (no tri-state)
1	Output at analog output 1 with polarity
2	Inverted output at analog output 1
3	Positive absolute value output at analog output 1
4	Negative absolute value output at analog output 1

Range: 0...4

Save:

Data record

Standard value: 1

Modify:

Online

P 466 Signal selection, analog output 2 (at terminal X1: 9/10)

Selects the signal (ALink) to be output.

Range: 0...330

Save:

Data record

Range: 0...350 from S03.03

Standard value: 43

Modify:

Online

P 467 Offset, analog output 2

Enters a constant added to the value of the output signal selected with P 466 after smoothing and scaling.

Range: -100.00 %...+100.00 %

Save:

Data record

Standard value: 0.00 %

Modify:

Online

P 468 Scaling, analog output 2

Multiplier for the output signal selected with P 466 after smoothing and before offset.

Range: 0,000...5,000

Save:

Data record

Standard value: 1.000

Modify:

Online

5.26 Parameter description - Analog outputs

P 469 Smoothing, analog output 2

before scaling and offset.

As time constants lower than 8 ms remain ineffective (at $f_{\text{mains}} = 45 \text{ Hz}$), input of values between 1 and 7 ms results in automatic entry of a value of 8 ms. Smoothing is switched off at a setting of 0 ms.

Range: 0...1000 ms Save: Data record
Standard value: 0 ms Modify: Online

P 470 Polarity, analog output 2

before smoothing

Value	Description
0	Analog output 2 switched off, always 0 V (no tri-state)
1	Output at analog output 2 with polarity
2	Inverted output at analog output 2
3	Positive absolute value output at analog output 2
4	Negative absolute value output at analog output 2

Range: 0...4 Save: Data record
Standard value: 1 Modify: Online

P 471 Signal selection, analog output 3 (at terminal X1: 11/12)

Selects the signal (ALink) to be output.

Range: 0...330 Save: Data record
Range: 0...350 from S03.03
Standard value: 51 Modify: Online

P 472 Offset, analog output 3

Enters a constant added to the value of the output signal selected with P 471 after smoothing and scaling.

Range: -100.00 %...+100.00 % Save: Data record
Standard value: 0.00 % Modify: Online

P 473 Scaling, analog output 3

Multiplier for the output signal selected with P 471 after smoothing and before offset.

Range: 0,000...5,000 Save: Data record
Standard value: 1.000 Modify: Online

P 474 Smoothing, analog output 3

before scaling and offset.

As time constants lower than 8 ms remain ineffective (at $f_{\text{mains}} = 45 \text{ Hz}$), input of values between 1 and 7 ms results in automatic entry of a value of 8 ms. Smoothing is switched off at a setting of 0 ms.

Range: 0...1000 ms Save: Data record
 Standard value: 0 ms Modify: Online

P 475 Polarity, analog output 3

before smoothing

Value	Description
0	Analog output 3 switched off, always 0 V (no tri-state)
1	Output at analog output 3 with polarity
2	Inverted output at analog output 3
3	Positive absolute value output at analog output 3
4	Negative absolute value output at analog output 3

Range: 0...4 Save: Data record
 Standard value: 1 Modify: Online

P 476 Signal selection, analog output 4 (at terminal X1: 13/14)

Selects the signal (ALink) to be output.

Range: 0...330 Save: Data record
 Range: 0...350 from S03.03
 Standard value: 59 Modify: Online

P 477 Offset, analog output 4

Enters a constant added to the value of the output signal selected with P 476 after smoothing and scaling.

Range: -100.00 %...+100.00 % Save: Data record
 Standard value: 0.00 % Modify: Online

P 478 Scaling, analog output 4

Multiplier for the output signal selected with P 476 after smoothing and before offset.

Range: 0,000...5,000 Save: Data record
 Standard value: 1.000 Modify: Online

5.26 Parameter description - Analog outputs

P 479 Smoothing, analog output 4

before scaling and offset.

As time constants lower than 8 ms remain ineffective (at $f_{\text{mains}} = 45 \text{ Hz}$), input of values between 1 and 7 ms results in automatic entry of a value of 8 ms. Smoothing is switched off at a setting of 0 ms.

Range: 0...1000 ms

Save:

Data record

Standard value: 0 ms

Modify:

Online

P 480 Polarity, analog output 4

before smoothing

Value	Description
0	Analog output 4 switched off, always 0 V (no tri-state)
1	Output at analog output 4 with polarity
2	Inverted output at analog output 4
3	Positive absolute value output at analog output 4
4	Negative absolute value output at analog output 4

Range: 0...4

Save:

Data record

Standard value: 1

Modify:

Online

5.27 Parameter description - Monitoring functions

P 501 Threshold, overspeed monitoring

Sets the trip threshold for overspeed monitoring. Input value in percent of the maximum speed. Exceeding the threshold leads to error message '44', and the ready-to-operate relay drops out. This error is acknowledgeable.



NOTE

This is no redundant safety system as an assumption is made as to the motor speed from the actual speed determined by the converter.

Monitoring requires an **error-free** tachogenerator or incremental encoder.

Operator safety guidelines must be observed !

Range:	0.00 %...120.00 %	Save:	Data record
Standard value:	115.00 %	Modify:	Online

P 502 Threshold, tachogenerator/encoder failure

Sets the threshold from which tachogenerator/encoder monitoring becomes effective. The set value refers to the EMF determined by the drive (AL 205). A set value of 30 %, for example, means that tachogenerator/encoder failure monitoring cuts in only from an EMF of +/- 30 %.

Input value in percent of the rated EMF (calculated from the armature voltage).

The monitoring function causes error message '45', and the ready-to-operate relay drops out. Time to trip: 40 ms at $f_{\text{mains}} = 50$ Hz. This error is acknowledgeable.

The associated error message may occur also when the **armature circuit is interrupted** !



NOTE

Increasing the input value switches the drive off at a tachogenerator/encoder failure only once a higher motor speed has been reached !

Operator safety guidelines must be observed !

Range:	5.00 %...65.00 %	Save:	Data record
Standard value:	10.00 %	Modify:	Online

P 503 Threshold, tachogenerator/encoder polarity

Sets the threshold from which tachogenerator/encoder polarity monitoring becomes effective. The set value refers to the tachogenerator/encoder signal. A set value of 50 %, for example, means that the tachogenerator/encoder polarity will be monitored only from a speed (AL 204) of +/- 50 % of the set maximum speed (P 257 and P 258 for tachogenerator control, P 262 for incremental encoder use for actual speed generation).

Input value in percent of the maximum speed.

The monitoring function causes error message '46', and the ready-to-operate relay drops out. Time to trip: 40 ms at $f_{\text{mains}} = 50$ Hz. This error is acknowledgeable.



NOTE

Increasing the input value means that the drive will be switched off at a polarity reversal at tachogenerator or incremental encoder only once a higher motor speed has been reached.

This is no redundant safety system as an assumption is made as to the state of the actual value encoder (tachogenerator or incremental encoder) from the actual speed determined by the converter. Operator safety guidelines must be observed !

Range:	5.00 %...65.00 %	Save:	Data record
Standard value:	10.00 %	Modify:	Online

P 504 Threshold, speed adjustment

For use of tachogenerator and incremental encoder for actual speed generation. The actual speed (AL 204) is compared to the determined EMF. The scaled actual speed signal must always be larger than the EMF (AL 205). Serves to check the tachogenerator connection at terminal X3 (tachogenerator range P 257).

Input value in percent of the rated EMF (calculated from the armature voltage).

Exceeding the threshold leads to error message '47', and the ready-to-operate relay drops out. This error is acknowledgeable.



NOTE

This is no redundant safety system as an assumption is made as to the motor speed from the actual speed determined by the converter.

Monitoring requires an **error-free** tachogenerator or incremental encoder.

Operator safety guidelines must be observed !

Range:	5.00 %...65.00 %	Save:	Data record
Standard value:	15.00 %	Modify:	Online

P 505 Threshold $n > n_{min}$

Inputs the speed from which DLinks 314 and DLink 7 adopt HIGH state. Input value in percent of the maximum speed. This signal is used internally as zero-speed indication to terminate the deceleration process on quick stop, controller disable or main contactor OFF and to coast the drive.

The zero-speed signal is also displayed via LED H703.

See also description of parameters P 107 and P 108.

Range:	0.10 %...110.00 %	Save:	Data record
Standard value:	5.00 %	Modify:	Online

P 506 Hysteresis $n > n_{min}$

This value is subtracted from the threshold of the signal $n > n_{min}$ and thus defines the lower threshold (switching threshold). Any value larger than the value in parameter P 505, entered here, sets the lower threshold to the minimum value of 0.10 % !

Input value in percent of the maximum speed.

The signal $n > n_{min}$ is displayed via DLinks 7 and 314.

DLink 7 changes from LOW to HIGH as soon as the actual speed exceeds the value P 505.

DLink 7 changes from HIGH to LOW as soon as the actual speed falls below the value P 505 - P 506.

This signal is used internally as zero-speed indication to terminate the deceleration process on quick stop, controller disable or main contactor OFF and to coast the drive. See also description of parameters P 107 and P 108.

The zero-speed signal is also displayed via LED H703.

Range:	0.01 %...110.00 %	Save:	Data record
Standard value:	2.00 %	Modify:	Online

The standard values make

the signal (**DLink 7**) adopt LOW state if the speed falls below 3 %,

the signal (**DLink 7**) adopt HIGH state if the speed exceeds 5 %,

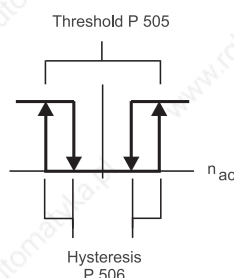

P 507 Threshold $n > n_{x1}$

Input value in percent of the maximum speed.

DLink 8 changes from LOW to HIGH as soon as the actual speed (AL 58) at the speed controller exceeds the set value.

DLink 8 changes from HIGH to LOW as soon as the actual speed at the speed controller falls below the set value minus the associated hysteresis (P 508).

Range:	0.10 %...110.00 %	Save:	Data record
Standard value:	10.00 %	Modify:	Online

5.27 Parameter description - Monitoring functions

P 508 Hysteresis $n > n_{x1}$

Input value in percent of the maximum speed.

Any value larger than the value in parameter P 507, entered here, sets the lower threshold to the minimum value of 0.10 % !

Range:	0.01 %...110.00 %	Save:	Data record
Standard value:	2.00 %	Modify:	Online

The standard values make

DLink 8 adopt LOW state if the speed falls below 8 %

DLink 8 adopt HIGH state if the speed exceeds 10 %

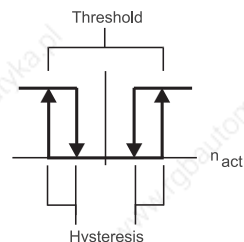

P 509 Threshold $n > n_{x2}$

Input value in percent of the maximum speed.

DLink 9 changes from LOW to HIGH as soon as the actual speed (AL 58) at the speed controller exceeds the set value.

DLink 9 changes from HIGH to LOW as soon as the actual speed at the speed controller falls below the set value minus the associated hysteresis (P 510).

Range:	0.10 %...110.00 %	Save:	Data record
Standard value:	15.00 %	Modify:	Online

P 510 Hysteresis $n > n_{x2}$

Input value in percent of the maximum speed.

Any value larger than the value in parameter P 509, entered here, sets the lower threshold to the minimum value of 0.10 % !

Range:	0.01 %...110.00 %	Save:	Data record
Standard value:	2.00 %	Modify:	Online

See also diagram under parameter P 508.

P 511 Threshold $n > n_{x3}$

Input value in percent of the maximum speed.

DLink 10 changes from LOW to HIGH as soon as the actual speed (AL 58) at the speed controller exceeds the set value.

DLink 10 changes from HIGH to LOW as soon as the actual speed at the speed controller falls below the set value minus the associated hysteresis (P 512).

Range:	0.10 %...110.00 %	Save:	Data record
Standard value:	20.00 %	Modify:	Online

P 512 Hysteresis $n > n_{x3}$

Input value in percent of the maximum speed.

Any value larger than the value in parameter P 511, entered here, sets the lower threshold to the minimum value of 0.10 % !

Range:	0.01 %...110.00 %	Save:	Data record
Standard value:	2.00 %	Modify:	Online

See also diagram under parameter P 508.

P 513 Threshold $n > n_{x4}$

Input value in percent of the maximum speed.

DLink 11 changes from LOW to HIGH as soon as the actual speed (AL 58) at the speed controller exceeds the set value.

DLink 11 changes from HIGH to LOW as soon as the actual speed at the speed controller falls below the set value minus the associated hysteresis (P 514).

Range:	0.10 %...110.00 %	Save:	Data record
Standard value:	25.00 %	Modify:	Online

P 514 Hysteresis $n > n_{x4}$

Input value in percent of the maximum speed.

Any value larger than the value in parameter P 513, entered here, sets the lower threshold to the minimum value of 0.10 % !

Range:	0.01 %...110.00 %	Save:	Data record
Standard value:	2.00 %	Modify:	Online

See also diagram under parameter P 508.

P 515 Threshold $n_{actual} = n_{set}$ (at speed controller)

Input value in percent of the maximum speed.

Once the difference between n_{actual} and n_{set} exceeds the set value, DLink 13 changes from HIGH to LOW.

Once the difference between n_{actual} and n_{set} falls below the set value minus the associated hysteresis (P 516), DLink 13 changes from LOW to HIGH.

Range:	0.10 %...50.00 %	Save:	Data record
Standard value:	5.00 %	Modify:	Online

5.27 Parameter description - Monitoring functions

P 516 Hysteresis, $n_{\text{actual}} = n_{\text{set}}$ signal (at speed controller)

Input value in percent of the maximum speed.

Any value larger than the value in parameter P 515, entered here, sets the lower threshold to the minimum value of 0.10 % !

Range: 0.01 %...50.00 % Save: Data record
Standard value: 1.00 % Modify: Online

The standard values make

DLink 13 adopt LOW state if the difference exceeds 5 %

DLink 13 adopt HIGH state if the difference falls below 4 %

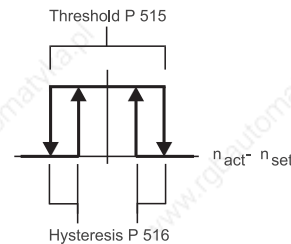

P 517 Stall protection, time to trip

The anti-blocking protection is **switched off** when a value of **0.0 s** is entered. During optimization, the stall protection is switched off internally, and the original set value is redopted on completion of optimization activities.

If the entered value does not equal 0.00 s, the stall protection trips if the drive is operated continuously at the current limit for longer than the set period **and** the speed threshold set with parameters P 505/P 506 is not reached.

The monitoring function causes error message '8', and the ready-to-operate relay drops out. This error is acknowledgeable.

Range: 0.0 s...30.0 s Save: Data record
Standard value: 5.0 s Modify: Online

P 518 Maximum torque reversal time

Of significance only for BKF-series four-quadrant converters.

Monitors the torque change duration. For weak systems, enter a higher value here as required to take into account the longer time before the braking current is commutated. It must also be set longer than the time in parameter **P 334**.

The monitoring function causes error message '48', and the ready-to-operate relay drops out. This error is acknowledgeable.

Range: 0.1 s...2.0 s Save: Primary data
Standard value: 0.2 s Modify: Online

P 519 'Armature-circuit-open' time to trip

Time delay for the signal 'Armature circuit open'.

The monitoring function causes error message '37', and the ready-to-operate relay drops out. This error is acknowledgeable.

Range:	0.5 s...5.0 s	Save:	Data record
Range:	0.5 s...60.0 s from S03.03		
Standard value:	1.0 s	Modify:	Online

P 521 Threshold $I_A > I_{A_X1}$

Input value in percent of the converter output current (P 072)

DLink 15 changes from LOW to HIGH as soon as the armature current exceeds the set value.

DLink 15 changes from HIGH to LOW as soon as the armature current falls below the set value minus the associated hysteresis (P 522).

The set threshold value is multiplied with the output of the speed-dependent current limit **AL 69** (refer P 330 and P 331).

Range:	0.10 %...110.00 %	Save:	Data record
Standard value:	90.00 %	Modify:	Online

Effect of the speed-dependent current limit on parameter P 521

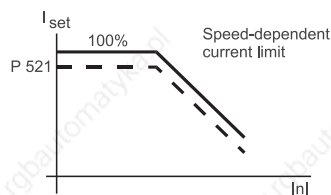

P 522 Hysteresis $I_A > I_{A_X1}$

Input value in percent of the converter output current (P 072)

Any value larger than the value in parameter P 521, entered here, sets the lower threshold to the minimum value of 0.10 % !

Range:	0.01 %...110.00 %	Save:	Data record
Standard value:	2.00 %	Modify:	Online

5.27 Parameter description - Monitoring functions

The standard values make

DLink 15 adopt HIGH state as soon as the armature current exceeds 90 %

DLink 15 adopt LOW state as soon as the armature current falls below 88 %

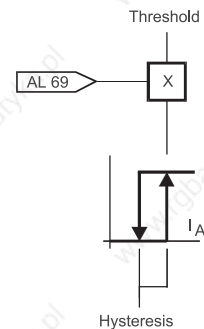

P 523 Threshold $I_A > I_{A_X2}$

Input value in percent of the converter output current (P 072)

DLink 16 changes from LOW to HIGH as soon as the armature current exceeds the set value.

DLink 16 changes from HIGH to LOW as soon as the armature current falls below the set value minus the associated hysteresis (P 524).

The set threshold value is multiplied with the output of the speed-dependent current limit **AL 69** (refer P 330 and P 331) (applicable as per diagram under parameter P 521).

Range:	0.10 %...110.00 %	Save:	Data record
Standard value:	95.00 %	Modify:	Online

P 524 Hysteresis $I_A > I_{A_X2}$

Input value in percent of the converter output current (P 072)

Any value larger than the value in parameter P 523, entered here, sets the lower threshold to the minimum value of 0.10 % !

(applicable as per diagram under parameter P 522).

Range:	0.01 %...110.00 %	Save:	Data record
Standard value:	2.00 %	Modify:	Online

P 525 Threshold, motor i^2t monitoring

The i^2t monitoring function is **switched off** if a value of **0 min** is entered in parameter P 078. During optimization, the i^2t monitoring function is switched off internally, and the original set value is redopted on completion of optimization activities.

Display of current i^2t value in parameter P 031, 100 % correspond to the rated motor temperature (dec. value 4096 in ALink 220).

Time to trip for the i^2t monitoring function on the condition that the set current in the armature circuit is flowing continuously:

$$t = -P 78 \times \ln \left[1 - \frac{P 525}{100 \%} \times \left(\frac{P 74}{P 72} \times \frac{100}{\text{current limit}} \right)^2 \right]$$

current limit: P 325 for TD1
P 326 for TD2

The signal changes from LOW to HIGH once the i^2t value exceeds the set value.

The signal changes from HIGH to LOW once the i^2t falls below the set value minus the associated fixed-set 5 % hysteresis.

The signal can be output via DLink 19 (see also [▶DLink 19 Motor \$i^2t\$ monitoring◀](#) on page 411).

Range:	50 %...110 %	Save:	Data record
Standard value:	100 %	Modify:	Online

The standard values make

the signal (DLink 19) adopt HIGH state once the i^2t value exceeds 100 %

the signal (DLink 19) adopt LOW state once the i^2t value falls below 95 %

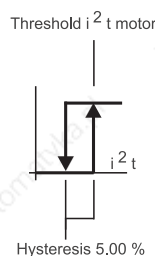

P 526 Maximum line stabilization time (contact at terminal X2: 15)

Once the contact 'main contactor ON' has closed, phase sequence, rotating field, phase failure at the power unit connections for the armature circuit and the phase sequence at the power unit connection of the field unit are checked. One measuring cycle takes 100 ms. Due to the different pick-up times of the contactors used for mains supply to the converter, several measuring cycles may result in errors despite correct connections. To avoid an error message in this case, set a **maximum time** with this parameter, during which the measuring cycles are repeated and the error messages are suppressed. Any error messages reporting connection errors will be issued only after the set time has elapsed.

Associated error messages: 19 to 22.

They cause the ready-to-operate relay to drop out; error '22' is acknowledgeable.



NOTE

If the contact 'Main contactor ON' is switched last by the enables, it **may** take max. the time set until the drive is enabled and the motor starts rotating !

Range:	0.1 s...5.0 s	Save:	Primary data
Standard value:	0.5 s	Modify:	Online

P 527 Maximum time to restart (after mains failure)

Mains failures shorter than the set time cause the drive to start automatically upon return of the mains voltage, as long as all enables are still present at the converter.

When operating the converter via communication interface (option card for field bus or USS protocol) and the automatical start upon return of the mains voltage should be used, the converter must be supplied additionally via the 24 V supply (X7).

When operating the converter without communication interface (parameter communication source P121 = 0) the function of the automatical start upon return of the mains voltage can be used without an additional 24 V supply.

A **0.0 s** input switches this function off.

5.27 Parameter description - Monitoring functions



WARNING

The safety regulations applicable to the machine must be observed since the drive **starts up automatically** on return of the mains voltage !

Operator protection !

Range: 0.0 s...3.0 s Save: Primary data
Standard value: 0.0 s Modify: Online

P 528 Frequency threshold [Hz] (from S03.10)

If the mains frequency is equal or higher than the set value, DLink 55 is set (HIGH). If the mains frequency is lower than the set value, DLink 55 is reset (LOW). The message has no hysteresis.

Range: 45,0 ... 65,0 Hz Save: Data record
Standard value: 65,0 Hz Modify: Online

P 535 Tachogenerator/encoder failure monitoring ON/OFF (from S03.06)

See also parameter P 502 and error 45

Value	Description
0	Tachogenerator/encoder failure monitoring active only if drive is enabled
1	Tachogenerator/encoder failure monitoring always active, even if the drive is disabled

Range: 0...1 Save: Data record
Standard value: 1 Modify: Online

P 536 Tachogenerator/encoder polarity monitoring ON/OFF (from S03.06)

See also parameter P 503 and error 46

Value	Description
0	Tachogenerator/encoder polarity monitoring active only if drive is enabled
1	Tachogenerator/encoder polarity monitoring always active, even if the drive is disabled

Range: 0...1 Save: Data record
Standard value: 1 Modify: Online

P 537 Speed adjustment monitoring ON/OFF (from S03.06)

See also parameters P 081, P 504 and error 47

Value	Description
0	Speed adjustment monitoring active only if drive is enabled
1	Speed adjustment monitoring always active, even if the drive is disabled

Range: 0...1

Save:

Data record

Standard value: 1

Modify:

Online

5.28 Parameter description - motor temperature monitoring (from SV 03.10)



CAUTION

When confusing the poles of the temperature sensor, the resistance of the sensor is decreased when the temperature is higher than 100 °C with further increasing temperature. The temperature monitoring of the motor is in this case above 100 °C inefficient (see [Appendix E - Option board motor temperature monitoring](#) from page 479). If the connection between board 3.9711 and board 3.0043 is missing, an error message is generated in software version 3.14 and higher, when the temperature monitoring is activated (P 541 = 1 and / or P 544 = 1).

P 540 Status word motor temperature monitoring

Parameter number in hexadecimal representation: 021C

Bit no.	Description	DLink
0	1: Motor temperature monitoring channel 1 active (P 541 = 1)	DL0512
1	1: Motor temperature monitoring channel 2 active (P 544 = 1)	DL0513
2	0: Spare	DL0514
3	1: Error in Module (F 96 till F 101)	DL0515
4	1: Warning motor temperature channel 1 active (W11)	DL0516
5	1: Warning motor temperature channel 1 active (W12)	DL0517
6	1: Temperature threshold channel 1 (P 547) exceeded	DL0518
7	1: Temperature threshold channel 2 (P 548) exceeded	DL0519
8	0: Spare	DL0520
9	0: Spare	DL0521
10	0: Spare	DL0522
11	0: Spare	DL0523
12	0: Spare	DL0524
13	0: Spare	DL0525
14	0: Spare	DL0526
15	0: Spare	DL0527

P 541 Motor temperature monitoring measurement channel 1 ON/OFF (X8:1 and X8:2 LP3.0043)

If the measurement channel is switched on, the connection of the assigned temperature sensor is monitored regarding disconnection and short circuit (F 98 and F 100).

Necessary temperature sensor: KTY 84-130.

Value	Description
0	Measurement channel 1 switched off
1	Measurement channel 1 switched on, the monitoring is active.

Range: 0...1

Save: Data record

Standard value: 0

Modify: Online

P 542 Warning temperature channel 1

Only active when P541 = 1!

When reaching the set value the warning W11 is generated and the assigned DLinks DL 516 / DL 666 are set HIGH. If the temperature is lower than the set value minus the fix set hysteresis of 5 °C, the warning is automatically erased and the DLinks DL 516 / DL 666 are reset LOW.

Range: +5 °C...+200 °C

Save: Data record

Standard value: +80 °C

Modify: Online

P 543 Switch off channel 1

Only active when P541 = 1!

When reaching the set value the error F 96 is generated and the assigned DLink DL 1024 is set HIGH.

Range: +5 °C...+200 °C

Save: Data record

Standard value: +80 °C

Modify: Online

P 544 Motor temperature monitoring measurement channel 2 ON/OFF (X8:4 and X8:5 LP3.0043)

If the measurement channel is switched on, the connection of the assigned temperature sensor is monitored regarding disconnection and short circuit (F 99 and F 101).

Necessary temperature sensor: KTY 84-130.

Value	Description
0	Measurement channel 2 switched off
1	Measurement channel 2 switched on, the monitoring is active.

Range: 0...1

Save: Data record

Standard value: 0

Modify: Online

P 545 Warning temperature channel 2

Only active when P544 = 1!

When reaching the set value the warning W11 is generated and the assigned DLinks DL 517 / DL 667 are set HIGH. If the temperature is lower than the set value minus the fix set hysteresis of 5 °C, the warning is automatically erased and the DLinks DL 516 / DL 666 are reset LOW.

Range:	+5 °C...+200 °C	Save:	Data record
Standard value:	+80 °C	Modify:	Online

P 546 Switch off channel 2

Only active when P544 = 1!

When reaching the set value the error F 97 is generated and the assigned DLink DL 1025 is set HIGH.

Range:	+5 °C...+200 °C	Save:	Data record
Standard value:	+80 °C	Modify:	Online

P 547 Message threshold motor temperature channel 1 (from S 03.20)

Only active when P541 = 1!

Configurable message threshold for the motor temperature monitoring of channel 1. If the measured motor temperature of channel 1 is higher than this threshold, DLink DL 518 is set. The DLink is reset, if the temperature is lower than the threshold less a fixed hysteresis of 5 °C.

Range:	+5 °C...+200 °C	Save:	Data record
Standard value:	+80 °C	Modify:	Online

P 548 Message threshold motor temperature channel 2 (from S 03.20)

Only active when P544 = 1!

Configurable message threshold for the motor temperature monitoring of channel 2. If the measured motor temperature of channel 2 is higher than this threshold, DLink DL 519 is set. The DLink is reset, if the temperature is lower than the threshold less a fixed hysteresis of 5 °C.

Range:	+5 °C...+200 °C	Save:	Data record
Standard value:	+80 °C	Modify:	Online

5.29 Parameter description - Unassigned PI controller

P 550 Setpoint selection, input 1 (unassigned PI controller)

Selects the signal (ALink) effective as setpoint at the unassigned PI controller. Is added to the signals selected with parameters P 551, P 552 and P 553.

Range:	0...330	Save:	Data record
Range:	0...350 from S03.03		
Standard value:	0 (= 0 %)	Modify:	Online

P 551 Setpoint selection, input 2 (unassigned PI controller)

Selects the signal (ALink) effective as setpoint at the unassigned PI controller. Is added to the signals selected with parameters P 550, P 552 and P 553.

Range:	0...330	Save:	Data record
Range:	0...350 from S03.03		
Standard value:	0 (= 0 %)	Modify:	Online

P 552 Setpoint selection, input 3 (unassigned PI controller)

Selects the signal (ALink) effective as setpoint at the unassigned PI controller. Is added to the signals selected with parameters P 550, P 551 and P 553.

Range:	0...330	Save:	Data record
Range:	0...350 from S03.03		
Standard value:	0 (= 0 %)	Modify:	Online

P 553 Setpoint selection, input 4 (unassigned PI controller)

Selects the signal (ALink) effective as setpoint at the unassigned PI controller. Is added to the signals selected with parameters P 550, P 551 and P 552.

Range:	0...330	Save:	Data record
Range:	0...350 from S03.03		
Standard value:	0 (= 0 %)	Modify:	Online

P 554 Actual value selection (unassigned PI controller)

Selects the signal (ALink) effective as actual value at the unassigned PI controller.

Range:	0...330	Save:	Data record
Range:	0...350 from S03.03		
Standard value:	0 (= 0 %)	Modify:	Online

5.29 Parameter description - Unassigned PI controller

P 555 Actual value smoothing (unassigned PI controller)

As time constants lower than 8 ms remain ineffective (at $f_{\text{mains}} = 45 \text{ Hz}$), input of values between 1 and 7 ms results in automatic entry of a value of 8 ms. Smoothing is switched off at a setting of 0 ms.

Range: 0...100 ms Save: Data record
Standard value: 0 ms Modify: Online

P 556 Actual-value derivative-action time (derivative-action element) (unassigned PI controller)

Sets the derivative-action time of the DT_1 element.

Range: 0...1000 ms Save: Data record
Standard value: 10 ms Modify: Online

P 557 Factor of D component (unassigned PI controller)

Multiplier for the output of the DT_1 element (P 556).

Range: 0.0...5.0 Save: Data record
Standard value: 0.0 Modify: Online

The effective D component of the actual value is available in **AL 113**.

P 560 Status word (unassigned PI controller)

Parameter number in hexadecimal representation: 0230

Bit no.	Description	DLink
0	1: Unassigned controller enabled	DL0528
1	0: Spare	DL0529
2	0: Spare	DL0530
3	1: Error in module	DL0531
4	1: Controller output, positive limit	DL0532
5	1: Controller output, negative limit	DL0533
6	1: I component, positive limit	DL0534
7	1: I component, negative limit	DL0535
8	1: Setpoint limit active	DL0536
9	0: Spare	DL0537
10	0: Spare	DL0538
11	0: Spare	DL0539
12	0: Spare	DL0540
13	0: Spare	DL0541
14	0: Spare	DL0542
15	0: Spare	DL0543

P 561 Control word (unassigned PI controller)

Parameter number in hexadecimal representation: 0231

Bit no.	Description	DLink
0	0: Unassigned controller: Disable setpoint (after addition)	DL0544
1	0: Unassigned controller: Disable controller	DL0545
2	0: Unassigned controller: Disable I component	DL0546
3	Spare: Always set to zero	DL0547
4	Spare: Always set to zero	DL0548
5	Spare: Always set to zero	DL0549
6	Spare: Always set to zero	DL0550
7	Spare: Always set to zero	DL0551
8	Spare: Always set to zero	DL0552
9	Spare: Always set to zero	DL0553
10	Spare: Always set to zero	DL0554
11	Spare: Always set to zero	DL0555
12	Spare: Always set to zero	DL0556
13	Spare: Always set to zero	DL0557
14	Spare: Always set to zero	DL0558
15	Spare: Always set to zero	DL0559

P 562 Controller type (unassigned PI controller)

Defines the unassigned PI controller parameter set

Value	Description
xx00	P- and I-components not active, controller switched off, output = 0
xx01	P-component OFF, I-component active, I controller, P 568, P 569 are integration times
xx10	P-component active, I-component OFF, P controller
xx11	P- and I-components active, PI controller

Range: xx00/xx01/xx10/xx11

Save:

Data record

Standard value: 11hex

Modify:

Online

P 563 P-gain K_p1 (unassigned PI controller)

P-gain 1 of the unassigned PI controller. Is effective when the signal selected with parameter P 567 falls below the value set in parameter P 565.

Range: 0.10...100.00

Save:

Data record

Standard value: 10.00

Modify:

Online

5.29 Parameter description - Unassigned PI controller

P 564 P-gain K_P 2 (unassigned PI controller)

Proportional gain 2 of the unassigned PI controller. Is effective when the signal selected with parameter P 567 exceeds the value set in parameter P 566.

Range: 0.10...100.00 Save: Data record
Standard value: 10.00 Modify: Online

The currently effective proportional gain is available in **AL 211**.

P 565 Threshold, P-gain K_P 1 (unassigned PI controller)

The proportional gain K_P 1 (P 563) becomes effective as soon as the signal selected with parameter P 567 falls below the set value.

Range: 0.00 %...100.00 % Save: Data record
Standard value: 100.00 % Modify: Online

P 566 Threshold, P-gain K_P 2 (unassigned PI controller)

The proportional gain K_P 2 (P 564) becomes effective as soon as the signal selected with parameter P 567 exceeds the set value.

Range: 0.00 %...100.00 % Save: Data record
Standard value: 100.00 % Modify: Online

P 567 Adaptation signal, P-gain K_P (unassigned PI controller)

Selects the signal (ALink) used for P-gain adaptation.

Range: 0...330 Save: Data record
Range: 0...350 from S03.03
Standard value: 0 Modify: Online

- The threshold set with parameter P 565 is higher than the one set with parameter P 566.

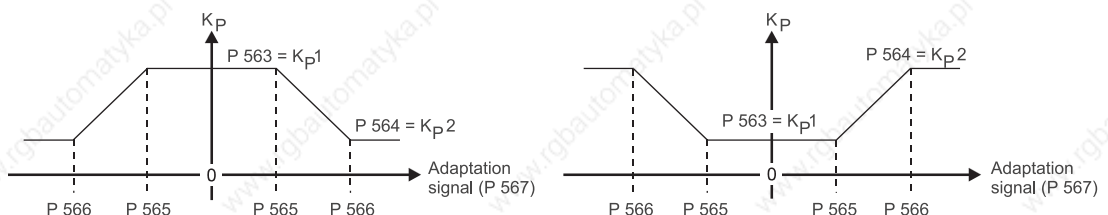

Illustration 72: K_P adaptation for the unassigned PI controller - Fig. 1

- The threshold set with parameter P 566 is lower than or equal to the one set with parameter P 565.

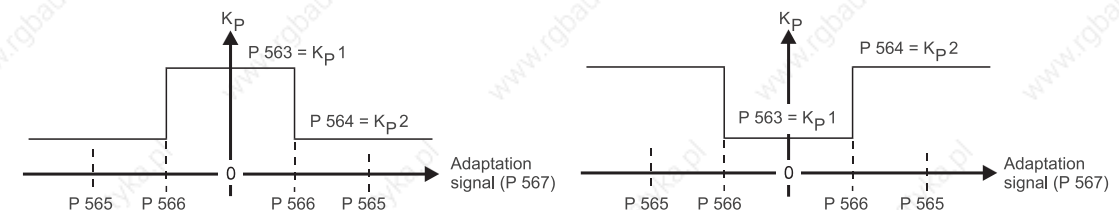

Illustration 73: K_P adaptation for the unassigned PI controller - Fig. 2

P 568 Integral-action time T_n 1 (unassigned PI controller)

Integral-action time 1 of the unassigned PI controller. Is effective when the signal selected with parameter P 572 falls below the value set in parameter P 571.

Range: 0,020 s...10,000 s Save: Data record
 Standard value: 0,400 s Modify: Online

P 569 Integral-action time T_n 2 (unassigned PI controller)

Integral-action time 2 of the unassigned PI controller. Is effective when the signal selected with parameter P 572 exceeds the value set in parameter P 571.

Range: 0,020 s...10,000 s Save: Data record
 Standard value: 0,400 s Modify: Online

The currently effective integral-action time is available in **AL 212**.

P 570 Threshold for Integral-action time T_n 1 (unassigned PI controller)

The integral-action time T_{n1} (P 568) becomes effective as soon as the signal selected with parameter P 572 falls below the set value.

Range: 0.00 %...100.00 % Save: Data record
 Standard value: 100.00 % Modify: Online

P 571 Threshold for Integral-action time T_n 2 (unassigned PI controller)

The integral-action time T_{n2} (P 569) becomes effective as soon as the signal selected with parameter P 572 exceeds the set value.

Range: 0.00 %...100.00 % Save: Data record
 Standard value: 100.00 % Modify: Online

P 572 Signal selection, unassigned PI controller, integral-action time

Selects the signal (ALink) used for integral-action time adaptation.

Range: 0...330 Save: Data record
 Range: 0...350 from S03.03
 Standard value: 0 Modify: Online

► The threshold set with parameter P 571 is larger than the one set with parameter P 570.

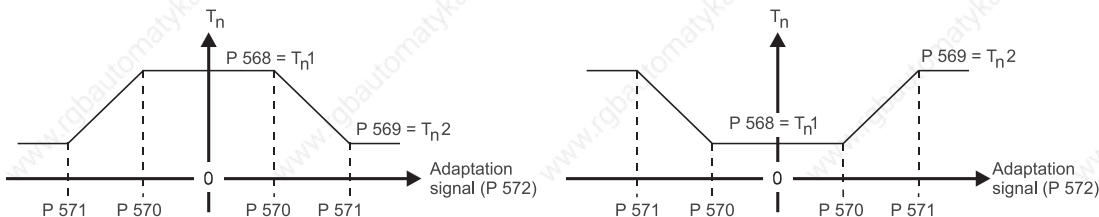

Illustration 74: K_P adaptation for the unassigned PI controller - Fig. 1

5.29 Parameter description - Unassigned PI controller

- ▶ The threshold set with parameter P 571 is lower than or equal to the one set with parameter P 570.

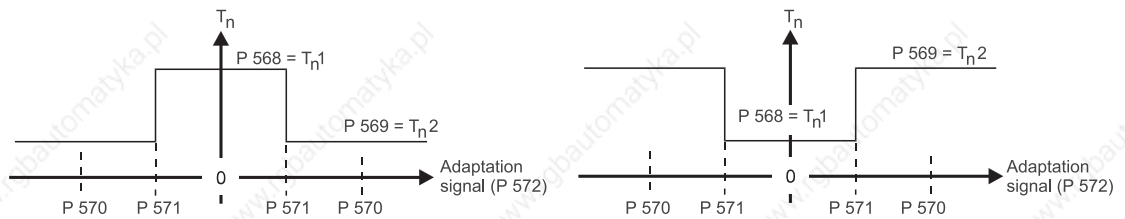

Illustration 75: K_p adaptation for the unassigned PI controller - Fig. 2

P 574 Preset I component (unassigned PI controller)

While the PI controller is disabled (refer parameter P 579), the set value is transferred into the I component of the unassigned PI controller (AL 116).

Range: -100.00 %...+100.00 % Save: Data record
Standard value: 0.00 % Modify: Online

P 575 Positive limit, I component (unassigned PI controller)

Range: 0.00 %...100.00 % Save: Data record
Standard value: 100.00 % Modify: Online

P 576 Negative limit, I component (unassigned PI controller)

Range: 0.00 %...-100.00 % Save: Data record
Standard value: -100.00 % Modify: Online

P 577 Positive limit, controller output (unassigned PI controller)

Range: 0.00 %...100.00 % Save: Data record
Standard value: 100.00 % Modify: Online

P 578 Negative limit, controller output (unassigned PI controller)

Range: 0.00 %...-100.00 % Save: Data record
Standard value: -100.00 % Modify: Online

P 579 Enable mode

Selects whether the controller disable, controller enable contacts or converter malfunction have an effect on the unassigned PI controller (digital input function DIF 28 is then **ineffective**), or whether the unassigned PI controller is to be enabled/disabled **independently** of the converter enables via digital input function DIF 28.

Value	Description
1	Converter controller enables affect unassigned PI controller, DIF 28 ineffective
2	Unassigned PI controller enabled/disabled only via digital input function DIF 28

Range: 1...2

Save: Primary data

Standard value: 1

Modify: Online

5.30 Parameter description - Unassigned function blocks

5.30 Parameter description - Unassigned function blocks

P 600 Status word (unassigned function blocks)

Parameter number in hexadecimal representation: 0258

Bit no.	Description	DLink
0	0: Spare	DL0560
1	0: Spare	DL0561
2	0: Spare	DL0562
3	0: Spare	DL0563
4	1: Comparator input signals below the set threshold	DL0564
5	0: Spare	DL0565
6	0: Spare	DL0566
7	0: Spare	DL0567
8	1: Changeover switch 1 active (signal P 667 passed on)	DL0568
9	1: Changeover switch 2 active (signals P 669+P 670 passed on)	DL0569
10	1: Changeover switch 3 active (signal P 672*P 673 passed on)	DL0570
11	1: Changeover switch 4 active (signal P 674 passed on)	DL0571
12	0: Spare	DL0572
13	0: Spare	DL0573
14	0: Spare	DL0574
15	0: Spare	DL0575

P 601 Control word (unassigned function blocks)

Parameter number in hexadecimal representation: 0259

Bit no.	Description	DLink
0	1: Unassigned changeover switch 1 active (signal P 667 passed on)	DL0576
1	1: Unassigned changeover switch 2 active (signals P 669+P 670 passed on)	DL0577
2	1: Unassigned changeover switch 3 active (signal P 672*P 673 passed on)	DL0578
3	1: Unassigned changeover switch 4 active (signal P 674 passed on)	DL0579
4	Spare: Always set to zero	DL0580
5	Spare: Always set to zero	DL0581
6	Spare: Always set to zero	DL0582
7	Spare: Always set to zero	DL0583
8	Spare: Always set to zero	DL0584
9	Spare: Always set to zero	DL0585
10	Spare: Always set to zero	DL0586
11	Spare: Always set to zero	DL0587
12	Spare: Always set to zero	DL0588
13	Spare: Always set to zero	DL0589
14	Spare: Always set to zero	DL0590
15	Spare: Always set to zero	DL0591

Parameter description - Arithmetic functions**P 602 Input signal A at unassigned adder 1**

Range: 0...330 Save: Data record
 Range: 0...350 from S03.03
 Standard value: 0 (= 0 %) Modify: Online

P 603 Input signal B at unassigned adder 1

Range: 0...330 Save: Data record
 Range: 0...350 from S03.03
 Standard value: 0 (= 0 %) Modify: Online

P 604 Input signal C at unassigned adder 1

Range: 0...330 Save: Data record
 Range: 0...350 from S03.03
 Standard value: 0 (= 0 %) Modify: Online

P 605 Input signal D at unassigned adder 1

Range:	0...330	Save:	Data record
Range:	0...350 from S03.03		
Standard value:	0 (= 0 %)	Modify:	Online

The outputs of unassigned adder 1 are available in ALinks 117 to 120.

P 606 Input signal A at unassigned adder 2

Range:	0...330	Save:	Data record
Range:	0...350 from S03.03		
Standard value:	0 (= 0 %)	Modify:	Online

P 607 Input signal B at unassigned adder 2

Range:	0...330	Save:	Data record
Range:	0...350 from S03.03		
Standard value:	0 (= 0 %)	Modify:	Online

P 608 Input signal C at unassigned adder 2

Range:	0...330	Save:	Data record
Range:	0...350 from S03.03		
Standard value:	0 (= 0 %)	Modify:	Online

P 609 Input signal D at unassigned adder 2

Range:	0...330	Save:	Data record
Range:	0...350 from S03.03		
Standard value:	0 (= 0 %)	Modify:	Online

The outputs of unassigned adder 2 are available in ALinks 121 to 124.

P 610 Input signal A at unassigned adder 3

Range:	0...330	Save:	Data record
Range:	0...350 from S03.03		
Standard value:	0 (= 0 %)	Modify:	Online

P 611 Input signal B at unassigned adder 3

Range:	0...330	Save:	Data record
Range:	0...350 from S03.03		
Standard value:	0 (= 0 %)	Modify:	Online

P 612 Input signal C at unassigned adder 3

Range:	0...330	Save:	Data record
Range:	0...350 from S03.03		
Standard value:	0 (= 0 %)	Modify:	Online

P 613 Input signal D at unassigned adder 3

Range:	0...330	Save:	Data record
Range:	0...350 from S03.03		
Standard value:	0 (= 0 %)	Modify:	Online

The outputs of unassigned adder 3 are available in ALinks 125 to 128.

P 614 Input signal A at unassigned adder 4

Range:	0...330	Save:	Data record
Range:	0...350 from S03.03		
Standard value:	0 (= 0 %)	Modify:	Online

P 615 Input signal B at unassigned adder 4

Range:	0...330	Save:	Data record
Range:	0...350 from S03.03		
Standard value:	0 (= 0 %)	Modify:	Online

P 616 Input signal C at unassigned adder 4

Range:	0...330	Save:	Data record
Range:	0...350 from S03.03		
Standard value:	0 (= 0 %)	Modify:	Online

P 617 Input signal D at unassigned adder 4

Range:	0...330	Save:	Data record
Range:	0...350 from S03.03		
Standard value:	0 (= 0 %)	Modify:	Online

The outputs of unassigned adder 4 are available in ALinks 129 to 132.

P 618 Input signal A at unassigned multiplier 1

Range:	0...330	Save:	Data record
Range:	0...350 from S03.03		
Standard value:	0 (= 0 %)	Modify:	Online

5.30 Parameter description - Unassigned function blocks

P 619 Input signal B at unassigned multiplier 1

Range:	0...330	Save:	Data record
Range:	0...350 from S03.03		
Standard value:	0 (= 0 %)	Modify:	Online

P 620 Input signal C at unassigned multiplier 1

Range:	0...330	Save:	Data record
Range:	0...350 from S03.03		
Standard value:	0 (= 0 %)	Modify:	Online

P 621 Input signal D at unassigned multiplier 1

Range:	0...330	Save:	Data record
Range:	0...350 from S03.03		
Standard value:	0 (= 0 %)	Modify:	Online

The multiplier output is

$$\frac{(\text{Input A} + \text{Input B}) \times (\text{Input C} + \text{Input D})}{100 \%}$$

The output of the unassigned multiplier 1 is available in ALink 135.

P 622 Input signal A at unassigned multiplier 2

Range:	0...330	Save:	Data record
Range:	0...350 from S03.03		
Standard value:	0 (= 0 %)	Modify:	Online

P 623 Input signal B at unassigned multiplier 2

Range:	0...330	Save:	Data record
Range:	0...350 from S03.03		
Standard value:	0 (= 0 %)	Modify:	Online

P 624 Input signal C at unassigned multiplier 2

Range:	0...330	Save:	Data record
Range:	0...350 from S03.03		
Standard value:	0 (= 0 %)	Modify:	Online

P 625 Input signal D at unassigned multiplier 2

Range:	0...330	Save:	Data record
Range:	0...350 from S03.03		
Standard value:	0 (= 0 %)	Modify:	Online

The multiplier output is

$$\frac{(\text{Input A} + \text{Input B}) \times (\text{Input C} + \text{Input D})}{100 \%}$$

The output of the unassigned multiplier 2 is available in ALink 138.

P 626 Input signal A at unassigned divider 1

Range:	0...330	Save:	Data record
Range:	0...350 from S03.03		
Standard value:	0 (= 0 %)	Modify:	Online

P 627 Input signal B at unassigned divider 1

Range:	0...330	Save:	Data record
Range:	0...350 from S03.03		
Standard value:	0 (= 0 %)	Modify:	Online

P 628 Input signal C at unassigned divider 1

Range:	0...330	Save:	Data record
Range:	0...350 from S03.03		
Standard value:	0 (= 0 %)	Modify:	Online

P 629 Input signal D at unassigned divider 1

Range:	0...330	Save:	Data record
Range:	0...350 from S03.03		
Standard value:	0 (= 0 %)	Modify:	Online

The divider output is

$$\frac{(\text{Input A} + \text{Input B})}{(\text{Input C} + \text{Input D})} \times 100 \% ; \quad \frac{0}{0} \text{ equals } +P 111 ; \quad \frac{\pm X}{0} \text{ equals } \pm P 111$$

The output of the unassigned divider 1 is available in ALink 141.

5.30 Parameter description - Unassigned function blocks

P 630 Input signal A at unassigned divider 2

Range:	0...330	Save:	Data record
Range:	0...350 from S03.03		
Standard value:	0 (= 0 %)	Modify:	Online

P 631 Input signal B at unassigned divider 2

Range:	0...330	Save:	Data record
Range:	0...350 from S03.03		
Standard value:	0 (= 0 %)	Modify:	Online

P 632 Input signal C at unassigned divider 2

Range:	0...330	Save:	Data record
Range:	0...350 from S03.03		
Standard value:	0 (= 0 %)	Modify:	Online

P 633 Input signal D at unassigned divider 2

Range:	0...330	Save:	Data record
Range:	0...350 from S03.03		
Standard value:	0 (= 0 %)	Modify:	Online

The divider output is

$$\frac{(\text{Input A} + \text{Input B})}{(\text{Input C} + \text{Input D})} \times 100 \% ; \quad \frac{0}{0} \text{ equals } +P 111; \quad \frac{\pm X}{0} \text{ equals } \pm P 111$$

The output of the unassigned divider 2 is available in ALink 144.

P 634 Input signal at unassigned multiplier 1 (from S03.10)

Selection of the ALink.

Range:	0...350	Save:	Data record
Standard value:	0 (= 0 %)	Modify:	Online

P 635 Scaling at unassigned multiplier 1 (from S03.10)

The selected signal (parameter P634) is multiplied by the set factor. The result is limited by the set value in parameter P 111 if necessary and assigned in any case to ALink 145.

Range:	-10,00...+10,00	Save:	Data record
Standard value:	+1,00	Modify:	Online

P 636 Input signal at unassigned multiplier 2 (from S03.10)

Selection of the ALink.

Range: 0...350

Save:

Data record

Standard value: 0 (= 0 %)

Modify:

Online

P 637 Scaling at unassigned multiplier 2 (from S03.10)

The selected signal (parameter P636) is multiplied by the set factor. The result is limited by the set value in parameter P 111 if necessary and assigned in any case to ALink 146.

Range: -10,00...+10,00

Save:

Data record

Standard value: +1,00

Modify:

Online

P 638 Input signal at unassigned multiplier 3 (from S03.10)

Selection of the ALink.

Range: 0...350

Save:

Data record

Standard value: 0 (= 0 %)

Modify:

Online

P 639 Scaling at unassigned multiplier 2 (from S03.10)

The selected signal (parameter P638) is multiplied by the set factor. The result is limited by the set value in parameter P 111 if necessary and assigned in any case to ALink 147.

Range: -10,00...+10,00

Save:

Data record

Standard value: +1,00

Modify:

Online

Parameter description - Unassigned function blocks**P 644 Input signal, minimum value limiter**

Range: 0...330

Save:

Data record

Range: 0...350 from S03.03

Standard value: 0 (= 0 %)

Modify:

Online

5.30 Parameter description - Unassigned function blocks

P 645 Threshold, minimum value limiter

Inputs the minimum output value of the limiter. The limiter output does not adopt any smaller values, not even if the input signal selected with parameter P 644 falls below the set threshold. The limiter has a gain 1.

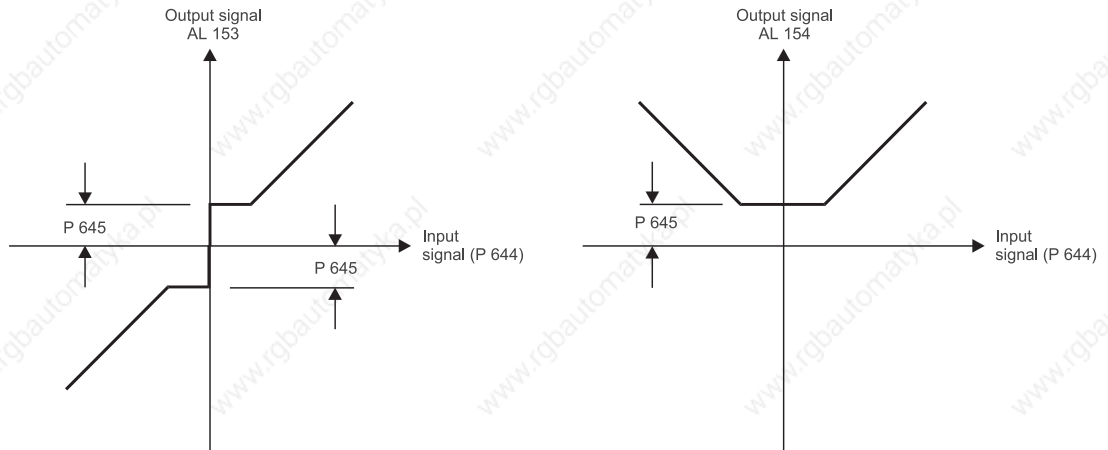

Range: 0.00 %...100.00 %

Save: Data record

Standard value: 0.00 %

Modify: Online

The output signals of the minimum value limiter are available in ALinks 153 and 154.

P 646 Input signal formatter

Range: 0...330

Save: Data record

Range: 0...350 from S03.03

Standard value: 0 (= 0 %)

Modify: Online

P 647 X value of input signal formatter

This parameter defines the value of the input signal at which the output signal rise changes.

Range: 0.00 %...100.00 %

Save: Data record

Standard value: 50.00 %

Modify: Online

P 648 Y value of input signal formatter

Once the input value reaches the value set with parameter P 647, the signal formatter output reaches the value set here.

Range: 0.00 %...100.00 %

Save: Data record

Standard value: 50.00 %

Modify: Online

P 649 Final value of input signal formatter

Signal formatter output value reached at 100 % of the input signal.

Range:	0.00 %...100.00 %	Save:	Data record
Standard value:	100.00 %	Modify:	Online

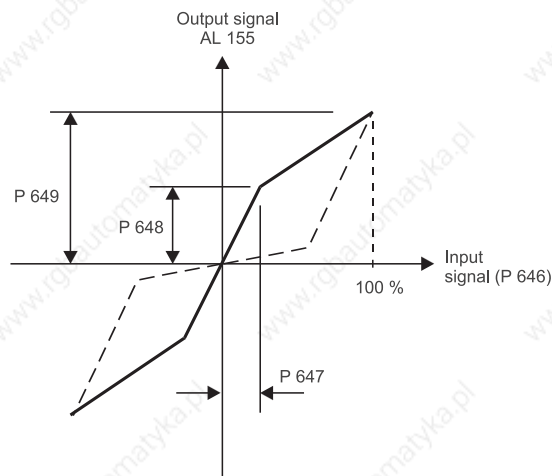

The output signal of the input signal formatter is available in ALink 155.

P 650 Input, absolute value generator 1

Range:	0...330	Save:	Data record
Range:	0...350 from S03.03		
Standard value:	0 (= 0 %)	Modify:	Online

The outputs of the unassigned absolute value generator are available in ALinks 156 to 158.

P 651 Input, absolute value generator 2

Range:	0...330	Save:	Data record
Range:	0...350 from S03.03		
Standard value:	0 (= 0 %)	Modify:	Online

The outputs of the unassigned absolute value generator are available in ALinks 159 to 161.

P 652 Input, absolute value generator 3

Range:	0...330	Save:	Data record
Range:	0...350 from S03.03		
Standard value:	0 (= 0 %)	Modify:	Online

The outputs of the unassigned absolute value generator are available in ALinks 162 to 164.

P 653 Input, absolute value generator 4

Range:	0...330	Save:	Data record
Range:	0...350 from S03.03		
Standard value:	0 (= 0 %)	Modify:	Online

The outputs of the unassigned absolute value generator are available in ALinks 165 to 167.

P 654 Input, inverter 1

Range:	0...330	Save:	Data record
Range:	0...350 from S03.03		
Standard value:	0 (= 0 %)	Modify:	Online

The output of the unassigned inverter is available in ALink 168.

P 655 Input, inverter 2

Range:	0...330	Save:	Data record
Range:	0...350 from S03.03		
Standard value:	0 (= 0 %)	Modify:	Online

The output of the unassigned inverter is available in ALink 169.

P 656 Input, limiter

Range:	0...330	Save:	Data record
Range:	0...350 from S03.03		
Standard value:	0 (= 0 %)	Modify:	Online

P 657 Positive limit, limiter

Range:	0.00 %...110.00 %	Save:	Data record
Range:	-100.00...100.00 from S03.10		
Standard value:	0.00 %	Modify:	Online

P 658 Negative limit, limiter

Range:	0.00 %...-110.00 %	Save:	Data record
Range:	-100.00...100.00 from S03.10		
Standard value:	0.00 %	Modify:	Online

The output of the unassigned limiter is available in ALink 170.

P 659 Input, dead band

Range:	0...330	Save:	Data record
Range:	0...350 from S03.03		
Standard value:	0 (= 0 %)	Modify:	Online

P 660 Positive threshold, dead band

Range:	0.00 %...110.00 %	Save:	Data record
Range:	-100.00...100.00 from S03.10		
Standard value:	0.00 %	Modify:	Online

P 661 Negative threshold, dead band

Range:	0.00 %...-110.00 %	Save:	Data record
Range:	-100.00...100.00 from S03.10		
Standard value:	0.00 %	Modify:	Online

The output of the unassigned dead band is available in ALink 173.

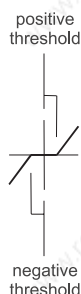

P 662 Input, filter 1

Range:	0...330	Save:	Data record
Range:	0...350 from S03.03		
Standard value:	0 (= 0 %)	Modify:	Online

P 663 Time constant, filter 1

As time constants lower than 8 ms remain ineffective (at $f_{mains} = 45 \text{ Hz}$), input of values between 1 and 7 ms results in automatic entry of a value of 8 ms. Smoothing is switched off at a setting of 0 ms.

Range:	0...1000 ms	Save:	Data record
Standard value:	10 ms	Modify:	Online

The output of the unassigned filter is available in ALink 186.

P 664 Input selection, filter 2

Range:	0...330	Save:	Data record
Range:	0...350 from S03.03		
Standard value:	0 (= 0 %)	Modify:	Online

5.30 Parameter description - Unassigned function blocks

P 665 Time constant, filter 2

As time constants lower than 8 ms remain ineffective (at $f_{\text{mains}} = 45 \text{ Hz}$), input of values between 1 and 7 ms results in automatic entry of a value of 8 ms. Smoothing is switched off at a setting of 0 ms.

Range:	0...1000 ms	Save:	Data record
Standard value:	10 ms	Modify:	Online

The output of the unassigned filter is available in ALink 187.

P 666 Input A, changeover switch 1

Range:	0...330	Save:	Data record
Range:	0...350 from S03.03		
Standard value:	0 (= 0 %)	Modify:	Online

P 667 Input B, changeover switch 1

Range:	0...330	Save:	Data record
Range:	0...350 from S03.03		
Standard value:	0 (= 0 %)	Modify:	Online

The unassigned changeover switch 1 is triggered via digital input function DIF 23 or via bit 0 in the control word of the unassigned function blocks (P 601).

Input A in ALink 195 if the control signal is LOW,
input B in ALink 195 if the control signal is HIGH.

P 668 Input A, changeover switch 2

Range:	0...330	Save:	Data record
Range:	0...350 from S03.03		
Standard value:	0 (= 0 %)	Modify:	Online

P 669 Input B, changeover switch 2

Range:	0...330	Save:	Data record
Range:	0...350 from S03.03		
Standard value:	0 (= 0 %)	Modify:	Online

P 670 Input C, changeover switch 2

Range:	0...330	Save:	Data record
Range:	0...350 from S03.03		
Standard value:	0 (= 0 %)	Modify:	Online

The unassigned changeover switch 2 is triggered via digital input function DIF 24 or via bit 1 in the control word of the unassigned function blocks (P 601).

Input A in ALink 196 if the control signal is LOW,

Sum of input signals B and C in ALink 196 if the control signal is HIGH.

P 671 Input A, changeover switch 3

Range:	0...330	Save:	Data record
Range:	0...350	from S03.03	
Standard value:	0 (= 0 %)	Modify:	Online

P 672 Input B, changeover switch 3

Range:	0...330	Save:	Data record
Range:	0...350	from S03.03	
Standard value:	0 (= 0 %)	Modify:	Online

P 673 Scaling input B, changeover switch 3

Multiplier for the value at input B

Range:	0,000...5,000	Save:	Data record
Range:	-5,000...+5,000	from S03.10	
Standard value:	1.000	Modify:	Online

The unassigned changeover switch 3 is triggered via digital input function DIF 25 or via bit 2 in the control word of the unassigned function blocks (P 601).

Input A in ALink 197 if the control signal is LOW.

Input signal B scaled with parameter P 673 in ALink 197 if the control signal is HIGH.

P 674 Input, changeover switch 4

Range:	0...330	Save:	Data record
Range:	0...350	from S03.03	
Standard value:	0 (= 0 %)	Modify:	Online

P 675 Scaling, changeover switch 4

Multiplier for the value at the input.

Range:	0,000...1,000	Save:	Data record
Range:	-1,000...+1,000	from S03.10	
Standard value:	1,000	Modify:	Online

The unassigned changeover switch 4 is triggered via digital input function DIF 26 or via bit 4 in the control word of the unassigned function blocks (P 601).

Input signal scaled with parameter P 675 in ALink 198 if the control signal is LOW.

Input signal in ALink 198 if the control signal is HIGH.

5.30 Parameter description - Unassigned function blocks

P 676 Input A, comparator

Range:	0...330	Save:	Data record
Range:	0...350 from S03.03		
Standard value:	1 (=+100 %)	Modify:	Online

P 677 Input B, comparator

Range:	0...330	Save:	Data record
Range:	0...350 from S03.03		
Standard value:	0 (= 0 %)	Modify:	Online

P 678 Threshold, comparator

Range:	0.10 %...100.00 %	Save:	Data record
Standard value:	5.00 %	Modify:	Online

P 679 Hysteresis, comparator

This value is subtracted from the threshold of the unassigned comparator and thus defines the lower threshold. Any value larger than the value in parameter P 678, entered here, sets the lower threshold to the minimum value of 0.10 % !

The input signal of the comparator (AL 200) is the difference between the two input signals [input A – input B].

The output signal of the comparator is available in DLink 14.

DLink 14 changes from LOW to HIGH if the absolute value of the input signal at the comparator falls below the value P 678 - P 679.

DLink 14 changes from HIGH to LOW if the absolute value of the input signal at the comparator exceeds the value P 678.

Range:	0.01 %...100.00 %	Save:	Data record
Standard value:	2.00 %	Modify:	Online

The standard values of P 678 and P 679

cause DLink 14 to adopt LOW state once the input signal at the comparator exceeds 5 %.

cause DLink 14 to adopt HIGH state once the input signal at the comparator falls below 3 %.

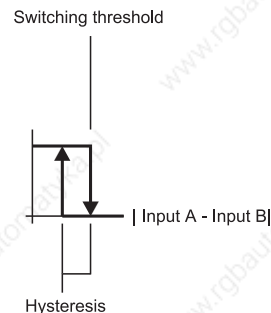

P 680 DLink selection for P 681

Shows the DLink whose value is to be displayed in P 681.

Range: 0...1200 (DLink no.) Save: Data record
 Standard value: 0 Modify: Online

P 681 Value of selected DLink (selected with P 680)

Value of the selected DLink, display width 1 bit - '0' or '1'

'0' → LOW

'1' → HIGH

P 682 Input ALink/DLink converter 1

Each of the 16 bits of the selected ALink is copied into 16 fixed-assigned DLinks (DLink 1040 to DLink 1055).

Bit 0 of the ALink is copied into DLink 1040, bit 1 of the ALink into DLink 1041, etc.

Bit no. of the selected ALink	Corresponding DLink no.
0	→ 1040
1	→ 1041
2	→ 1042
3	→ 1043
4	→ 1044
5	→ 1045
6	→ 1046
7	→ 1047
8	→ 1048
9	→ 1049
10	→ 1050
11	→ 1051
12	→ 1052
13	→ 1053
14	→ 1054
15	→ 1055

Range: 0...330 Save: Data record
 Range: 0...350 from S03.03
 Standard value: 0 Modify: Online

5.30 Parameter description - Unassigned function blocks

P 683 Input ALink/DLink converter 2

Each of the 16 bits of the selected ALink is copied into 16 fixed-assigned DLinks (DLink 1056 to DLink 1071).

Bit 0 of the ALink is copied into DLink 1056, bit 1 of the ALink into DLink 1057, etc.

Bit no. of the selected ALink	Corresponding DLink no.
0 →	1056
1 →	1057
2 →	1058
3 →	1059
4 →	1060
5 →	1061
6 →	1062
7 →	1063
8 →	1064
9 →	1065
10 →	1066
11 →	1067
12 →	1068
13 →	1069
14 →	1070
15 →	1071

Range: 0...330 Save: Data record
Range: 0...350 from S03.03
Standard value: 0 Modify: Online

P 684 Set source parameter 1 for DLink 44/45

Number of the parameter whose bit(s) is/are to be transferred into DLinks 44 and 45.

Range: 0...999 Save: Data record
Standard value: 0 Modify: Online

P 685 Bit mask for source parameter 1

Selection mask to define the bits of the source parameter (P 684), whose states (0 or 1) set DLink 44 to HIGH (and thus DLink 45 to LOW). Enter a '1' for each selected bit at the relevant position.

Example:

Selecting bits 2, 3, 8 and 9 requires a binary value of 0000'0011'0000'1100 to be entered as 030Chex. The state of these selected bits affects DLinks 44 and 45.

Range:	0000...FFFFhex	Save:	Data record
Standard value:	0000hex	Modify:	Online

P 686 Bit pattern for source parameter 1

State mask for the bits selected with parameter P 685.

Example:

Bits nos. 2, 3, 8 and 9 of the source parameter (P 684) were selected. DLink 44 is now to change to HIGH (DLink 45 to LOW) if bit 2 = '1', bit 3 = '0', bit 8 = '0' and bit 9 = '1'. This results in a binary value of 0000'0010'0000'0100 and must be entered as 0204hex.

Range:	0000...FFFFhex	Save:	Data record
Standard value:	0000hex	Modify:	Online

DLink 44 changes to HIGH (= '1') if in the source parameter selected with parameter P 684 the bits defined with parameter P 685 correspond to the pattern defined with parameter P 686. DLink 45 is inverted with regard to DLink 44.

P 687 Set source parameter 2 for DLink 46/47

Number of the parameter whose bit(s) is/are to be transferred into DLinks 46 and 47.

Range:	0...999	Save:	Data record
Standard value:	0	Modify:	Online

P 688 Bit mask for source parameter 2

Selection mask to define the bits of the source parameter (P 687), whose states (0 or 1) set DLink 46 to HIGH (and thus DLink 47 to LOW). Enter a '1' for each selected bit at the relevant position.

Example:

Selecting bits 0, 5, 12 and 14 requires a binary value of 0101'0000'0010'0001 to be entered as 5021 hex. The state of these selected bits affects DLinks 46 and 47.

Range:	0000...FFFFhex	Save:	Data record
Standard value:	0000hex	Modify:	Online

P 689 Bit pattern for source parameter 2

State mask for the bits selected with parameter P 688.

Example:

Bits nos. 0, 5, 12 and 14 of the source parameter (P 687) were selected.

DLink 46 will now change to HIGH (DLink 47 to LOW) when bit 0 = '1',

bit 5 = '0', bit 12 = '1' and bit 14 = '1'. This results in a binary value of 0101'0000'0000'0001 to be entered as 5001hex.

Range: 0000...FFFFhex Save: Data record

Standard value: 0000hex Modify: Online

DLink 46 changes to HIGH (= '1') if in the source parameter selected with parameter P 687 the bits defined with parameter P 688 correspond to the pattern defined with parameter P 689. DLink 47 is inverted with regard to DLink 46.

P 690 DLink x writing target parameter (P 691)

DLink number influencing the target parameter defined with P 691.

Range: 0...1200 (DLink no.) Save: Data record

Standard value: 0 Modify: Online

P 691 Target parameter, DLink x (P690)

Number of the parameter which is influenced by the DLink defined in P 690.

Range: 0...999 Save: Data record

Standard value: 0 Modify: Online

P 692 Write mask for target parameter (P691)

Mask for the bits of the target parameter (P 691), influenced by DLink x. For each selected bit a "1" must be set at the corresponding position.

Example:

Writing bits 3 and 4 requires a binary value of 0000'0000'0001'1000 to be entered as 0018hex.

Range: 0000...FFFFhex Save: Data record

Standard value: 0000hex Modify: Online

P 693 Write pattern for DLink x: HIGH (P691)

Bit pattern (0/1) which is written at HIGH state of DLink x to the selected bits (P692) of the target parameter (P691).

Example:

As long as DLink x (selected with P 690) is HIGH, bit 3 is to be set to '0' and bit 4 to '1' in the target parameter selected with P 691. The bits were selected with P 692. Therefore a binary value of 0000'0000'0001'0000 is required and to be entered as 0010hex.

Range:	0000...FFFFhex	Save:	Data record
Standard value:	0000hex	Modify:	Online

P 694 Write pattern for DLink x: LOW (P691)

Bit pattern (0/1) which is written at LOW state of DLink x to the selected bits (P692) of the target parameter (P691).

Example:

As long as DLink x (selected with P 690) is LOW, bit 3 is to be set to '1' and bit 4 to '0' in the target parameter selected with P 691. The bits were selected with P 692. Therefore a binary value of 0000'0000'0000'1000 is required and to be entered as 0008hex.

Range:	0000...FFFFhex	Save:	Data record
Standard value:	0000hex	Modify:	Online

P 695 DLink x writing target parameter (P 696)

DLink number influencing the target parameter defined with P 696.

Range:	0...1200 (DLink no.)	Save:	Data record
Standard value:	0	Modify:	Online

P 696 Target parameter, DLink x (P695)

Number of the parameter which is influenced by the DLink defined in P 695.

Range:	0...999	Save:	Data record
Standard value:	0	Modify:	Online

P 697 Write mask for target parameter (P696)

Mask for the bits of the target parameter (P 696), influenced by DLink x. For each selected bit a "1" must be set at the corresponding position.

Example:

Writing bits 3, 7 and 8 requires a binary value of 0000'0001'1000'1000 to be entered as 0188hex.

Range:	0000...FFFFhex	Save:	Data record
Standard value:	0000hex	Modify:	Online

5.30 Parameter description - Unassigned function blocks

P 698 Write pattern for DLink x: HIGH (P696)

Bit pattern (0/1) which is written at HIGH state of DLink x to the selected bits (P697) of the target parameter (P696).

Example:

As long as DLink y (selected with P 695) is HIGH, bit 3 is to be set to '1', bit 7 to '1' and bit 8 to '0' in the target parameter selected with P 696. The bits were selected with P 697. This requires a binary value of 0000'0000'1000'1000 to be entered as 0088hex.

Range:	0000...FFFFhex	Save:	Data record
Standard value:	0000hex	Modify:	Online

P 699 Write pattern for DLink x: LOW (P696)

Bit pattern (0/1) which is written at LOW state of DLink x to the selected bits (P697) of the target parameter (P696).

Example:

As long as DLink y (selected with P 695) is LOW, bit 3 is to be set to '0', bit 7 to '0' and bit 8 to '1' in the target parameter selected with P 696. The bits were selected with P 697. This requires a binary value of 0000'0001'0000'0000 to be entered as 0100hex.

Range:	0000...FFFFhex	Save:	Data record
Standard value:	0000hex	Modify:	Online

5.31 Parameter description - DLink functions

P 702 Input at unassigned digital inverter 1

Range: 0...1200 (DLink no.) Save: Data record
 Standard value: 0 (LOW) Modify: Online

The output of the unassigned inverter is available in DLinks DL 592 and DL 593.

P 703 Delay time, unassigned digital inverter 1

A level change of the DLink selected with P 702 is accepted into DLinks DL 592 (original signal) and DL 593 (inverted signal) only after the set time.

Range: 0.00...30.00 s Save: Data record
 0.00...160.00 s (from S 03.20)
 Standard value: 0.00 s Modify: Online

P 704 Input at unassigned digital inverter 2

Range: 0...1200 (DLink no.) Save: Data record
 Standard value: 0 (LOW) Modify: Online

The output of the unassigned inverter is available in DLinks DL 594 and DL 595.

P 705 Delay time, unassigned digital inverter 2

A level change of the DLink selected with P 704 is accepted into DLinks DL 594 (original signal) and DL 595 (inverted signal) only after the set time.

Range: 0.00...30.00 s Save: Data record
 0.00...160.00 s (from S 03.20)
 Standard value: 0.00 s Modify: Online

P 706 Input at unassigned digital inverter 3

Range: 0...1200 (DLink no.) Save: Data record
 Standard value: 0 (LOW) Modify: Online

The output of the unassigned inverter is available in DLinks DL 596 and DL 597.

P 707 Delay time, unassigned binary inverter 3

A level change of the DLink selected with P 706 is accepted into DLinks DL 596 (original signal) and DL 597 (inverted signal) only after the set time.

Range: 0.00...30.00 s Save: Data record
 0.00...160.00 s (from S 03.20)
 Standard value: 0.00 s Modify: Online

5.31 Parameter description - DLink functions

P 708 Input at unassigned digital inverter 4

Range: 0...1200 (DLink no.) Save: Data record
Standard value: 0 (LOW) Modify: Online

The output of the unassigned inverter is available in DLinks DL 598 and DL 599.

P 709 Delay time for unassigned digital inverter 4

A level change of the DLink selected with P 708 is accepted into DLinks DL 598 (original signal) and DL 599 (inverted signal) only after the set time.

Range: 0.00...30.00 s Save: Data record
0.00...160.00 s (from S 03.20)
Standard value: 0.00 s Modify: Online

P 710 Function, gate 1 (AND/OR/XOR)

This parameter selects one of the digital functions AND, OR or XOR. The operation result is stored in DLink DL 600, the inverted result in DLink DL 601.

Value	Description
0	No relation active; DL 600 always LOW - DL 601 always HIGH
1	AND gate with four inputs, assign DL 1 to unassigned inputs
2	OR gate with four inputs, assign DL 0 to unassigned inputs
3	EXCLUSIVE OR gate with two inputs: Only the signals set with parameters P 711 and P 712 are XOR-gated.

Range: 0...3 Save: Data record
Standard value: 0 Modify: Online

P 711 Input A, gate 1

Range: 0...1200 (DLink no.) Save: Data record
Standard value: 0 (LOW) Modify: Online

P 712 Input B, gate 1

Range: 0...1200 (DLink no.) Save: Data record
Standard value: 0 (LOW) Modify: Online

P 713 Input C, gate 1

Setting this parameter at P 710 = **3** is ineffective !

Range: 0...1200 (DLink no.) Save: Data record
Standard value: 0 (LOW) Modify: Online

P 714 Input D, gate 1

Setting this parameter at P 710 = 3 is ineffective !

Range: 0...1200 (DLink no.) Save: Data record

Standard value: 0 (LOW) Modify: Online

P 715 Function, gate 2 (AND/OR/XOR)

This parameter selects one of the digital functions AND, OR or XOR. The operation result is stored in DLink DL 602, the inverted result in DLink DL 603.

Value	Description
0	No relation active, DL 602 always LOW - DL 603 always HIGH
1	AND gate with four inputs , assign DL 1 to unassigned inputs
2	OR gate with four inputs, assign DL 0 to unassigned inputs
3	EXCLUSIVE OR gate with two inputs: Only the signals set with parameters P 716 and P 717 are XOR-gated.

Range: 0...3 Save: Data record

Standard value: 0 Modify: Online

P 716 Input A, gate 2

Range: 0...1200 (DLink no.) Save: Data record

Standard value: 0 (LOW) Modify: Online

P 717 Input B, gate 2

Range: 0...1200 (DLink no.) Save: Data record

Standard value: 0 (LOW) Modify: Online

P 718 Input C, gate 2

Setting this parameter at P 715 = 3 is ineffective !

Range: 0...1200 (DLink no.) Save: Data record

Standard value: 0 (LOW) Modify: Online

P 719 Input D, gate 2

Setting this parameter at P 715 = 3 is ineffective !

Range: 0...1200 (DLink no.) Save: Data record

Standard value: 0 (LOW) Modify: Online

5.31 Parameter description - DLink functions

P 720 Function, gate 3 (AND/OR/XOR)

This parameter selects one of the digital functions AND, OR or XOR. The operation result is stored in DLink DL 604, the inverted result in DLink DL 605.

Value	Description
0	No relation active, DL 604 always LOW - DL 605 always HIGH
1	AND gate with four inputs , assign DL 1 to unassigned inputs
2	OR gate with four inputs, assign DL 0 to unassigned inputs
3	EXCLUSIVE OR gate with two inputs: Only the signals set with parameters P 721 and P 722 are XOR-gated.

Range: 0...3 Save: Data record
Standard value: 0 Modify: Online

P 721 Input A, gate 3

Range: 0...1200 (DLink no.) Save: Data record
Standard value: 0 (LOW) Modify: Online

P 722 Input B, gate 3

Range: 0...1200 (DLink no.) Save: Data record
Standard value: 0 (LOW) Modify: Online

P 723 Input C, gate 3

Setting this parameter at P 720 = **3 is ineffective !**

Range: 0...1200 (DLink no.) Save: Data record
Standard value: 0 (LOW) Modify: Online

P 724 Input D, gate 3

Setting this parameter at P 720 = **3 is ineffective !**

Range: 0...1200 (DLink no.) Save: Data record
Standard value: 0 (LOW) Modify: Online

P 725 Function, gate 4 (AND/OR/XOR)

This parameter selects one of the digital functions AND, OR or XOR. The operation result is stored in DLink DL 606, the inverted result in DLink DL 607.

Value	Description
0	No relation active; DL 606 always LOW - DL 607 always HIGH
1	AND gate with four inputs , assign DL 1 to unassigned inputs
2	OR gate with four inputs, assign DL 0 to unassigned inputs
3	EXCLUSIVE OR gate with two inputs: Only the signals set with parameters P 726 and P 727 are XOR-gated.

Range: 0...3 Save: Data record
Standard value: 0 Modify: Online

P 726 Input A, gate 4

Range: 0...1200 (DLink no.) Save: Data record
Standard value: 0 (LOW) Modify: Online

P 727 Input B, gate 4

Range: 0...1200 (DLink no.) Save: Data record
Standard value: 0 (LOW) Modify: Online

P 728 Input C, gate 4

Setting this parameter at P 725 = 3 is ineffective !

Range: 0...1200 (DLink no.) Save: Data record
Standard value: 0 (LOW) Modify: Online

P 729 Input D, gate 4

Setting this parameter at P 725 = 3 is ineffective !

Range: 0...1200 (DLink no.) Save: Data record
Standard value: 0 (LOW) Modify: Online

5.31 Parameter description - DLink functions

P 730 Input freely definable error F105 (from S 03.15)

The set DLink enables the error reaction.

Error enable when DLink is HIGH. The error message is deactivated when P730 = 0. If P730 ≠ 0 the drive is switched torque-free and the ready for use relay is disabled, as soon as the selected DLink is HIGH.

Range:	0...1200 (DLink no.)	Save:	Data record
Standard value:	0	Modify:	Online

P 740 DLink x writing target parameter (P 741) (from S 03.20)

DLink number influencing the target parameter defined with P 741.

Range:	0... 1200 (DLink no.)	Save:	Data record
Standard value:	0	Modify:	Online

P 741 Target parameter, DLink x (P 740) (from S 03.20)

Number of the parameter which is influenced by the DLink defined in P 740.

Range:	0... 999	Save:	Data record
Standard value:	0	Modify:	Online

P 742 Write mask for target parameter (P 741) (from S 03.20)

Mask for the bits of the target parameter (P 741), influenced by DLink x. For each selected bit a "1" must be set at the corresponding position.

Example: see P 692

Range:	0000... FFFFhex	Save:	Data record
Standard value:	0000hex	Modify:	Online

P 743 Write pattern for DLink x: HIGH (P 741) (from S 03.20)

Bit pattern (0/1), which is written at HIGH state of DLink x to the selected bits (P 742) of the target parameter (P 741).

Example: see P 693

Range:	0000... FFFFhex	Save:	Data record
Standard value:	0000hex	Modify:	Online

P 744 Write pattern for DLink x: LOW (P 741) (from S 03.20)

Bit pattern (0/1), which is written at LOW state of DLink x to the selected bits (P 742) of the target parameter (P 741).

Example: see P 694

Range:	0000... FFFFhex	Save:	Data record
Standard value:	0000hex	Modify:	Online

P 745 DLink x writing target parameter (P 746) (from S 03.20)

Dlink number influencing the target parameter defined in P 746.

Range:	0... 1200 (DLink no.)	Save:	Data record
Standard value:	0	Modify:	Online

P 746 Target parameter, DLink x (P 745) (from S 03.20)

Number of the parameter which is influenced by the DLink defined in P 745.

Range:	0... 999	Save:	Data record
Standard value:	0	Modify:	Online

P 747 Write mask for target parameter (P 746) (from S 03.20)

Mask for the bits of the target parameter (P 746), influenced by DLink x. For each selected bit a "1" must be set at the corresponding position.

Example: see P 692

Range:	0000... FFFFhex	Save:	Data record
Standard value:	0000hex	Modify:	Online

P 748 Write pattern for DLink x: HIGH (P 746) (from S 03.20)

Bit pattern (0/1), which is written at HIGH state of DLink x to the selected bits (P 747) of the target parameter (P 746).

Example: see P 693

Range:	0000... FFFFhex	Save:	Data record
Standard value:	0000hex	Modify:	Online

P 749 Write pattern at DLink x: LOW (P 746) (from S 03.20)

Bit pattern (0/1), which is written at LOW state of DLink x to the selected bits (P 747) of the target parameter (P 746).

Example: see P 694

Range:	0000... FFFFhex	Save:	Data record
Standard value:	0000hex	Modify:	Online

P 750 DLink x writing target parameter (P 751) (from S 03.20)

Dlink number influencing the target parameter defined in P 751.

Range:	0... 1200 (DLink no.)	Save:	Data record
Standard value:	0	Modify:	Online

5.31 Parameter description - DLink functions

P 751 Target parameter, DLink x (P 750) (from S 03.20)

Number of the parameter which is influenced by the DLink defined in P 750.

Range:	0... 999	Save:	Data record
Standard value:	0	Modify:	Online

P 752 Write mask for target parameter (P 751) (from S 03.20)

Mask for the bits of the target parameter (P 751), influenced by DLink x. For each selected bit a "1" must be set on the corresponding position.

Example: see P 692

Range:	0000... FFFFhex	Save:	Data record
Standard value:	0000hex	Modify:	Online

P 753 Write pattern at DLink x: HIGH (P 751) (from S 03.20)

Bit pattern (0/1), which is written at HIGH state of DLink x to the selected bits (P 752) of the target parameter (P 751).

Example: see P 693

Range:	0000... FFFFhex	Save:	Data record
Standard value:	0000hex	Modify:	Online

P 754 Write pattern at DLink x: LOW (P 751) (from S 03.20)

Bit pattern (0/1), which is written at LOW state of DLink x to the selected bits (P 752) of the target parameter (P 751).

Example: see P 694

Range:	0000... FFFFhex	Save:	Data record
Standard value:	0000hex	Modify:	Online

P 755 DLink x writing target parameter (P 756) (from S 03.20)

Dlink number influencing the target parameter defined with P 756.

Range:	0... 1200 (DLink no.)	Save:	Data record
Standard value:	0	Modify:	Online

P 756 Target parameter, DLink x (P 755) (from S 03.20)

Number of the parameter which is influenced by the DLink defined in P 755.

Range:	0... 999	Save:	Data record
Standard value:	0	Modify:	Online

P 757 Write mask for target parameter (P 756) (from S 03.20)

Mask for the bits of the target parameter (P 756), influenced by DLink x. For each selected bit a "1" must be set on the corresponding position.

Example: see P 692

Range:	0000... FFFFhex	Save:	Data record
Standard value:	0000hex	Modify:	Online

P 758 Write pattern for DLink x: HIGH (P 756) (from S 03.20)

Bit pattern (0/1), which is written at HIGH state of DLink x to the selected bits (P 757) of the target parameter (P 756).

Example: see P 693

Range:	0000... FFFFhex	Save:	Data record
Standard value:	0000hex	Modify:	Online

P 759 Write pattern for DLink x: LOW (P 756) (from S 03.20)

Bit pattern (0/1), which is written at LOW state of DLink x to the selected bits (P 757) of the target parameter (P 756).

Example: see P 694

Range:	0000... FFFFhex	Save:	Data record
Standard value:	0000hex	Modify:	Online

5.32 Parameter description - Option board parameters

5.32 Parameter description - Option board parameters

P 768 **Option board parameters X**

to

P 799

The settings of these parameters are stored in the converter and required by plug-in option boards. Enter as a HEX value. The description is dependent on the respective option board. For details refer to option board description.

P 768 Option board ZK 0

P 769 Option board ZK 1

etc.

P 799 Option board ZK 31

Range: 0000...8000 hex

Save:

Primary data

Modify:

Online

5.33 Parameter description - Error messages

P 900 System error 1 (error bit array)

Bit	Description	DLink
0	1= Error in converter control module, refer P 910	624
1	Not assigned = 0	625
2	Not assigned = 0	626
3	Not assigned = 0	627
4	Not assigned = 0	628
5	Not assigned = 0	629
6	Not assigned = 0	630
7	1= Error in speed controller module, refer P 911	631
8	1= Error in incremental encoder 1 evaluation module, see P 912	632
9	1= Error in data record manager module, see P 913	633
10	Not assigned = 0	634
11	1= Error in operating system module, see P 930	635
12	1= Error in μ P module, see P 915	636
13	1= Error in EMF module, see P 916	637
14	1= Error in power unit module, refer P 917	638
15	1= Error in field unit module, refer P 918	639

5.33 Parameter description - Error messages

P 901 System error 2 (error bit array)

Bit	Description	DLink
0	1= Error in motor potentiometer module, see P 919	640
1	1= Error in digital outputs module, see P 920	641
2	1= Error in actual value detector module, see P 921	642
3	1= Error in reversing unit module, see P 922	643
4	1= Error in power unit module, see P 923	644
5	1= Error in digital inputs module, see P 924	645
6	1= Error in analog inputs module, see P 925	646
7	1= Error in armature current controller module, see P 926	647
8	Error in data record manager 2 module (see P 927)	648
9	Error in data record manager 3 module (see P 928) (from S03.03)	649
10	Error in unassigned function blocks module (see P 929) (from S03.10)	650
11	Error in module motor temperature monitoring (see P 930) (from S03.10)	651
12	Not assigned = 0	652
13	Not assigned = 0	653
14	Not assigned = 0	654
15	Not assigned = 0	655

P 902 System warning 1 (warning bit array)

Bit	Description	DLink
0	1= Warning 1 active: P 261 / P 262 parameter conflict	656
1	1 = Warning 2 active: Data record save not completed	657
2	1 = Warning 3 active: Power unit temperature exceeded	658
3	1 = Warning 4 active: Data record not erased	659
4	1 = Warning 5 active: P 072 / P 074 parameter conflict	660
5	1 = Warning 6 active: Intermittent-current limit cannot be ascertained (at P 082 = 1)	661
6	1 = Warning 7 active: Data record change not possible	662
7	1 = Warning 8 active: Motor i ² t tripped	663
8	1 = Warning 9 active: Cannot erase boot data record	664
9	1 = Warning 10 active: Cannot reset	665
10	1= Warning 11 active: Warning temperature channel 1 (motor temp. ≥ P 542)	666
11	1= Warning 12 active: Warning temperature channel 2 (motor temp. ≥ P 545)	667
12	1= Warning 13 active: Pre-warning power unit temperature	668
13	Not assigned = 0	669
14	Not assigned = 0	670
15	Not assigned = 0	671

5.33 Parameter description - Error messages

P 903 System warning 2 (warning bit array)

Bit	Description	DLink
0	Not assigned = 0	672
1	Not assigned = 0	673
2	Not assigned = 0	674
3	Not assigned = 0	675
4	Not assigned = 0	676
5	Not assigned = 0	677
6	Not assigned = 0	678
7	Not assigned = 0	679
8	Not assigned = 0	680
9	Not assigned = 0	681
10	Not assigned = 0	682
11	Not assigned = 0	683
12	Not assigned = 0	684
13	Not assigned = 0	685
14	Not assigned = 0	686
15	Not assigned = 0	687

P 910 Error in converter control module

Bit	Description	DLink
0	1 = Error 1 active: BASS communication time monitoring	688
1	1 = Error 2 active: USS communication time monitoring	689
2	1 = Error 3 active: Process data channel time monitoring	690
3	1 = Error 4 active: Parameter channel transmission time monitoring	691
4	Not assigned = 0	692
5	Not assigned = 0	693
6	Not assigned = 0	694
7	Not assigned = 0	695
8	1 = Error 91 active: Undefined field bus card state	696
9	1 = Error 92 active: Field bus error	697
10	1 = Error 93 active: Field bus setpoint/actual-value configuration error	698
11	Not assigned = 0	699
12	Not assigned = 0	700
13	Not assigned = 0	701
14	Not assigned = 0	702
15	1 = Error 7 active: Program branching error	703

5.33 Parameter description - Error messages

P 911 Error in speed controller module

Bit	Description	DLink
0	Not assigned = 0	704
1	1 = Error 8 active: Drive blocked	705
2	Not assigned = 0	706
3	Not assigned = 0	707
4	Not assigned = 0	708
5	Not assigned = 0	709
6	Not assigned = 0	710
7	Not assigned = 0	711
8	Not assigned = 0	712
9	Not assigned = 0	713
10	Not assigned = 0	714
11	Not assigned = 0	715
12	Not assigned = 0	716
13	Not assigned = 0	717
14	Not assigned = 0	718
15	Not assigned = 0	719

P 912 Error in incremental encoder module

Bit	Description	DLink
0	1 = Error 9 active: Incremental encoder 1, scaling error	720
1	Not assigned = 0	721
2	Not assigned = 0	722
3	Not assigned = 0	723
4	Not assigned = 0	724
5	Not assigned = 0	725
6	Not assigned = 0	726
7	Not assigned = 0	727
8	Not assigned = 0	728
9	Not assigned = 0	729
10	Not assigned = 0	730
11	Not assigned = 0	731
12	Not assigned = 0	732
13	Not assigned = 0	733
14	Not assigned = 0	734
15	Not assigned = 0	735

5.33 Parameter description - Error messages

P 913 Error in data record manager 1 module

Bit	Description	DLink
0	1 = Error 10 active: EEPROM-to-RAM copy error	736
1	1 = Error 11 active: Damaged boot data record header	737
2	1 = Error 12 active: Boot data record checksum error	738
3	1 = Error 13 active: Damaged primary data header	739
4	1 = Error 14 active: EEPROM too small	740
5	1 = Error 15 active: Error on data record save	741
6	1 = Error 57 active: Ambiguous data record change source	742
7	1 = Error 58 active: EEPROM empty	743
8	1 = Error 59 active: Parameter error in data record 1 (write error/value)	744
9	1 = Error 60 active: Parameter error in data record 2 (write error/value)	745
10	1 = Error 61 active: Parameter error in data record 3 (write error/value)	746
11	1 = Error 62 active: Parameter error in data record 4 (write error/value)	747
12	1 = Error 63 active: Parameter error in data record 5 (write error/value)	748
13	1 = Error 64 active: Parameter error in data record 6 (write error/value)	749
14	1 = Error 65 active: Error in ROM data record (no. 7)	750
15	1 = Error 66 active: Primary data parameter error	751

P 914 Error in operating system module

Bit	Description	DLink
0	1 = Error 16 active: Ambiguous converter type BKD/BKF (1-Q/4-Q)	752
1	1 = Error 17 active: Error ext. ADC	753
2	1 = Error 18 active: Unknown field power unit identification	754
3	1 = Error 19 active: Field connection error (AC)	755
4	1 = Error 20 active: Armature power unit connection error (AC)	756
5	1 = Error 21 active: CCW rotating field at armature power unit	757
6	1 = Error 22 active: Phase failure at armature power unit	758
7	Not assigned = 0	759
8	Not assigned = 0	760
9	Not assigned = 0	761
10	Not assigned = 0	762
11	Not assigned = 0	763
12	Not assigned = 0	764
13	Not assigned = 0	765
14	Not assigned = 0	766
15	Not assigned = 0	767

5.33 Parameter description - Error messages

P 915 Error in microcontroller module

Bit	Description	DLink
0	1 = Error 23 active: External bus error	768
1	1 = Error 24 active: Program address error	769
2	1 = Error 25 active: Data address error	770
3	1 = Error 26 active: Protected OPCODE	771
4	1 = Error 27 active: OPCODE error	772
5	1 = Error 28 active: Stack underflow	773
6	1 = Error 29 active: Stack overflow	774
7	1 = Error 30 active: External watchdog tripped	775
8	1 = Error 31 active: Internal watchdog tripped	776
9	1 = Error 32 active: RAM test error	777
10	1 = Error 70 active: Option board does not respond	778
11	Not assigned = 0	779
12	Not assigned = 0	780
13	Not assigned = 0	781
14	Not assigned = 0	782
15	Not assigned = 0	783

P 916 Error in EMF module

Bit	Description	DLink
0	1 = Error 33 active: Parameter conflict P 071 / P 073	784
1	1 = Error 34 active: Repeated negative armature current actual value	785
2	1 = Error 52 active: Mains undervoltage	786
3	1 = Error 53 active: Overcurrent TD1	787
4	1 = Error 54 active: Overcurrent TD2	788
5	Not assigned = 0	789
6	Not assigned = 0	790
7	Not assigned = 0	791
8	Not assigned = 0	792
9	Not assigned = 0	793
10	Not assigned = 0	794
11	Not assigned = 0	795
12	Not assigned = 0	796
13	Not assigned = 0	797
14	Not assigned = 0	798
15	Not assigned = 0	799

5.33 Parameter description - Error messages

P 917 Error in power unit module

Bit	Description	DLink
0	1 = Error 35 active: No synchronisation	800
1	1 = Error 36 active: Firing pulse interval differs from specified value	801
2	Not assigned = 0	802
3	1 = Error 38 active: Mains frequency < 45 Hz	803
4	1 = Error 39 active: Mains frequency > 65 Hz	804
5	1 = Error 55 active: Zero-current detector defective	805
6	Not assigned = 0	806
7	Not assigned = 0	807
8	Not assigned = 0	808
9	Not assigned = 0	809
10	Not assigned = 0	810
11	Not assigned = 0	811
12	Not assigned = 0	812
13	Not assigned = 0	813
14	Not assigned = 0	814
15	Not assigned = 0	815

P 918 Error in field unit module

Bit	Description	DLink
0	1 = Error 40 active: Field current monitoring	816
1	1 = Error 69 active: Field power unit differs from EEPROM value	817
2	Not assigned = 0	818
3	Not assigned = 0	819
4	Not assigned = 0	820
5	Not assigned = 0	821
6	Not assigned = 0	822
7	Not assigned = 0	823
8	Not assigned = 0	824
9	Not assigned = 0	825
10	Not assigned = 0	826
11	Not assigned = 0	827
12	Not assigned = 0	828
13	Not assigned = 0	829
14	Not assigned = 0	830
15	Not assigned = 0	831

5.33 Parameter description - Error messages

P 919 Error in motor potentiometer module

Bit	Description	DLink
0	1 = Error 42 active: P 213 / P 215 parameter conflict	832
1	Not assigned = 0	833
2	Not assigned = 0	834
3	Not assigned = 0	835
4	Not assigned = 0	836
5	Not assigned = 0	837
6	Not assigned = 0	838
7	Not assigned = 0	839
8	Not assigned = 0	840
9	Not assigned = 0	841
10	Not assigned = 0	842
11	Not assigned = 0	843
12	Not assigned = 0	844
13	Not assigned = 0	845
14	Not assigned = 0	846
15	Not assigned = 0	847

P 920 Error in digital outputs module

Bit	Description	DLink
0	1 = Error 43 active: Shortcircuit/overload at a digital output	848
1	Not assigned = 0	849
2	Not assigned = 0	850
3	Not assigned = 0	851
4	Not assigned = 0	852
5	Not assigned = 0	853
6	Not assigned = 0	854
7	Not assigned = 0	855
8	Not assigned = 0	856
9	Not assigned = 0	857
10	Not assigned = 0	858
11	Not assigned = 0	859
12	Not assigned = 0	860
13	Not assigned = 0	861
14	Not assigned = 0	862
15	Not assigned = 0	863

5.33 Parameter description - Error messages

P 921 Error in actual-value detector module

Bit	Description	DLink
0	1 = Error 44 active: Overspeed	864
1	1 = Error 45 active: Tachogenerator/encoder failure or armature circuit open	865
2	1 = Error 46 active: Tachogenerator/encoder polarity reversed	866
3	1 = Error 47 active: Speed range error	867
4	Not assigned = 0	868
5	Not assigned = 0	869
6	Not assigned = 0	870
7	Not assigned = 0	871
8	Not assigned = 0	872
9	Not assigned = 0	873
10	Not assigned = 0	874
11	Not assigned = 0	875
12	Not assigned = 0	876
13	Not assigned = 0	877
14	Not assigned = 0	878
15	Not assigned = 0	879

P 922 Error in reversing unit module

Bit	Description	DLink
0	1 = Error 48 active: Torque change time exceeded	880
1	Not assigned = 0	881
2	Not assigned = 0	882
3	Not assigned = 0	883
4	Not assigned = 0	884
5	Not assigned = 0	885
6	Not assigned = 0	886
7	Not assigned = 0	887
8	Not assigned = 0	888
9	Not assigned = 0	889
10	Not assigned = 0	890
11	Not assigned = 0	891
12	Not assigned = 0	892
13	Not assigned = 0	893
14	Not assigned = 0	894
15	Not assigned = 0	895

5.33 Parameter description - Error messages

P 923 Error in power unit module

Bit	Description	DLink
0	1 = Error 49 active: Error of armature power unit identification	896
1	1 = Error 67 active: Armature power unit identification differs from EEPROM value	897
2	1= Error 102 active: Cable break temperature sensor power unit	898
3	1= Error 103 active: Short circuit temperature sensor power unit	899
4	1= Error 104 active: Power unit limit temperature exceeded, P 112	900
5	Not assigned = 0	901
6	Not assigned = 0	902
7	Not assigned = 0	903
8	Not assigned = 0	904
9	Not assigned = 0	905
10	Not assigned = 0	906
11	Not assigned = 0	907
12	Not assigned = 0	908
13	Not assigned = 0	909
14	Not assigned = 0	910
15	Not assigned = 0	911

P 924 Error in digital inputs module

Bit	Description	DLink
0	1 = Error 50 active: Data record selection error	912
1	Not assigned = 0	913
2	Not assigned = 0	914
3	Not assigned = 0	915
4	Not assigned = 0	916
5	Not assigned = 0	917
6	Not assigned = 0	918
7	Not assigned = 0	919
8	Not assigned = 0	920
9	Not assigned = 0	921
10	Not assigned = 0	922
11	Not assigned = 0	923
12	Not assigned = 0	924
13	Not assigned = 0	925
14	Not assigned = 0	926
15	Not assigned = 0	927

5.33 Parameter description - Error messages

P 925 Error in analog inputs module

Bit	Description	DLink
0	1 = Error 51 active: Input current < 3.3 mA at 4 mA...20 mA	928
1	1 = Error 95 active: No +15 V or -15 V supply voltage	929
2	Not assigned = 0	930
3	Not assigned = 0	931
4	Not assigned = 0	932
5	Not assigned = 0	933
6	Not assigned = 0	934
7	Not assigned = 0	935
8	Not assigned = 0	936
9	Not assigned = 0	937
10	Not assigned = 0	938
11	Not assigned = 0	939
12	Not assigned = 0	940
13	Not assigned = 0	941
14	Not assigned = 0	942
15	Not assigned = 0	943

P 926 Error in armature current controller module

Bit	Description	DLink
0	1 = Error 56 active: Offset error armature current detection (< 50 mV)	944
1	1 = Error 41 active: P 072 out of range	945
2	1 = Error 37 active: Armature circuit open	946
3	Not assigned = 0	947
4	Not assigned = 0	948
5	Not assigned = 0	949
6	Not assigned = 0	950
7	Not assigned = 0	951
8	Not assigned = 0	952
9	Not assigned = 0	953
10	Not assigned = 0	954
11	Not assigned = 0	955
12	Not assigned = 0	956
13	Not assigned = 0	957
14	Not assigned = 0	958
15	Not assigned = 0	959

5.33 Parameter description - Error messages

P 927 Error in data record manager 2 module

Bit	Description	DLink
0	1 = Error 5 active: Incompatible software	960
1	1 = Error 6 active: Invalid boot source entry	961
2	1 = Error 71 active: Illegal value in P 072 / P 074 in data record 1	962
3	1 = Error 72 active: Illegal value in P 072 / P 074 in data record 2	963
4	1 = Error 73 active: Illegal value in P 072 / P 074 in data record 3	964
5	1 = Error 74 active: Illegal value in P 072 / P 074 in data record 4	965
6	1 = Error 75 active: Illegal value in P 072 / P 074 in data record 5	966
7	1 = Error 76 active: Illegal value in P 072 / P 074 in data record 6	967
8	1 = Error 77 active: Illegal value in P 079 in data record 1	968
9	1 = Error 78 active: Illegal value in P 079 in data record 2	969
10	1 = Error 79 active: Illegal value in P 079 in data record 3	970
11	1 = Error 80 active: Illegal value in P 079 in data record 4	971
12	1 = Error 81 active: Illegal value in P 079 in data record 5	972
13	1 = Error 82 active: Illegal value in P 079 in data record 6	973
14	1 = Error 68 active: Data record change: Data record does not exist	974
15	1 = Error 83 active: EEPROM write time exceeded	975

P 928 Error in data record manager 3 module (from S03.03)

Bit	Description	DLink
0	1 = Error 84 active: Primary data checksum error	976
1	1 = Error 85 active: Checksum error, data record 1	977
2	1 = Error 86 active: Checksum error, data record 2	978
3	1 = Error 87 active: Checksum error, data record 3	979
4	1 = Error 88 active: Checksum error, data record 4	980
5	1 = Error 89 active: Checksum error, data record 5	981
6	1 = Error 90 active: Checksum error, data record 6	982
7	Not assigned = 0	983
8	Not assigned = 0	984
9	Not assigned = 0	985
10	Not assigned = 0	986
11	Not assigned = 0	987
12	Not assigned = 0	988
13	Not assigned = 0	989
14	Not assigned = 0	990
15	Not assigned = 0	991

5.33 Parameter description - Error messages

P 929 Error in unassigned function blocks module (from S03.10)

Bit	Description	DLink
0	1= Error 94 active: P 657/P 658 parameter conflict	992
1	1= Error 105 active: freely definable error, P 730	993
2	Not assigned = 0	994
3	Not assigned = 0	995
4	Not assigned = 0	996
5	Not assigned = 0	997
6	Not assigned = 0	998
7	Not assigned = 0	999
8	Not assigned = 0	1000
9	Not assigned = 0	1001
10	Not assigned = 0	1002
11	Not assigned = 0	1003
12	Not assigned = 0	1004
13	Not assigned = 0	1005
14	Not assigned = 0	1006
15	Not assigned = 0	1007

P 930 Error in motor temperature monitoring module (from S03.10)

Bit	Description	DLink
0	1= Error 96 active: Switch off temperatur channel 1 (Motor temperature \geq P 543)	1024
1	1= Error 97 active: Switch off temperatur channel 2 (Motor temperature \geq P 546)	1025
2	1= Error 98 active: Disconnection motor temperatur sensor channel 1	1026
3	1= Error 99 active: Disconnection motor temperatur sensor channel 2	1027
4	1= Error 100 active: Short circuit motor temperatur sensor channel 1	1028
5	1= Fehler 101 aktiv: Short circuit motor temperatur sensor channel 2	1029
6	Not assigned = 0	1030
7	Not assigned = 0	1031
8	Not assigned = 0	1032
9	Not assigned = 0	1033
10	Not assigned = 0	1034
11	Not assigned = 0	1035
12	Not assigned = 0	1036
13	Not assigned = 0	1037
14	Not assigned = 0	1038
15	Not assigned = 0	1039

5.34 Function description- Freely definable status word

5.34 Function description- Freely definable status word

P 950 DLink selection for the freely definable status word P 966

to

P 965 Here, the states of selected DLinks (= bits) can be copied into a 16-bit word in the desired sequence to allow the control to read in the converter state relevant to the machine during a read access.

P 950 defines the contents of bit '0' in parameter P 966

P 951 defines the contents of bit '1' in parameter P 966

P 952 defines the contents of bit '2' in parameter P 966

etc. to

P 965 defines the contents of bit '15' in parameter P 966

Example:

Bit '0' of parameter P 966 is to be set when the output of ramp generator A has reached the set-point at the input.

Therefore enter the value **284** (= DL 284) in parameter **P 950**.

Bit '12' of parameter P 966 is to be set when the power unit temperature exceeds the limit value.

Therefore enter the value **54** (= DL 54) in parameter **P 962**.

Range: 0...1200 (DLink no.) Save: Primary data

Standard value: 0 (LOW) Modify: Online

P 966 Freely definable status word

16-bit-wide status word whose contents is defined with parameters P 950 to P 965. The freely definable status word is generated during the rest time and is therefore **no** real-time map of the converter state ! The freely definable status word is also mapped in ALink 213.

Range: Save: None

Standard value: 0000hex Modify: By the converter

5.35 Parameter description - System parameters

P 993 Timing via AL 302

Enters the number of the program module whose runtime is to be measured. Timing resolution: 0.8 μ s. Display with parameter P 046 / P 047 and/or P 048 / P 049.

Range:	0...29	Save:	
Standard value:	0	Modify:	Online

P 994 Minimum-value memory (AL 316)

Minimum-value memory. Selects an ALink whose minimum value is transferred into ALink 316. A new measuring cycle can be started by a new entry in parameter P 994. Output of the value via one of the four analog outputs or via parameters P 046 / P 047 or P 048 / P 049.

Range:	0...330	Save:	Data record
Range:	0...350	from S03.03	
Standard value:	0 (= 0 %)	Modify:	Online

P 995 Maximum-value memory (AL 317)

Maximum-value memory. Selects an ALink whose maximum value is transferred into ALink 317. A new measuring cycle can be started by a new entry in parameter P 995. Output of the value via one of the four analog outputs or via parameters P 046 / P 047 or P 048 / P 049.

Range:	0...330	Save:	Data record
Range:	0...350	from S03.03	
Standard value:	0 (= 0 %)	Modify:	Online

P 996 Parameter/ALink converter 1 (AL 300)

Selects the parameter whose value is stored in ALink 300. Output of the value via one of the four analog outputs or via parameters P 046 / P 047 or P 048 / P 049. Can also be used for the cyclic transmission of a parameter (status word, for example). ALink 300 is updated during the program rest time and does not necessarily have to represent the state of the just-completed controller cycle.

Range:	1...999	Save:	Data record
Standard value:	1	Modify:	Online

P 997 Parameter/ALink converter 2 (AL 301)

Selects the parameter whose value is stored in ALink 301. Output of the value via one of the four analog outputs or via parameters P 046 / P 047 or P 048 / P 049. Can also be used for the cyclic transmission of a parameter (status word, for example). ALink 301 is updated during the program rest time and does not necessarily have to represent the state of the just-completed controller cycle.

Range:	1...999	Save:	Data record
Standard value:	1	Modify:	Online

5.35 Parameter description - System parameters

P 998 Selection memory location address

Selects an internal address (memory cell) whose value is displayed in parameter P 999.

Range:	hex	Save:	Primary data
Standard value:	FF1Chex	Modify:	Online

P 999 Memory location address contents

Hex display of the contents of the address selected with P 998.

5.36 ALink list

Scaling

All standard-scaled signals are identified 'S' in the 'Scaling' column.
The scaling of all non-standard-scaled signals has been specified.

Standard scaling

+100 % corresponds to an internal value of +16384
0 % corresponds to an internal value of 0
-100 % corresponds to an internal value of -16384

The following applies to the four analog output channels for standard scaling:

+100 % correspond to +10 V
0 % correspond to 0 V
-100 % correspond to -10 V

This applies only if the parameters assigned to the analog output channels are set as follows:

	Offset	Scaling	Polarity
Analog channel 1	P 462 = 0.00 %	P 463 = 1.000	P 465 = 1
Analog channel 2	P 467 = 0.00 %	P 468 = 1.000	P 470 = 1
Analog channel 3	P 472 = 0.00 %	P 473 = 1.000	P 475 = 1
Analog channel 4	P 477 = 0.00 %	P 478 = 1.000	P 480 = 1



NOTE

Any non-assigned ALinks have a value of 0 !

5.36 ALink list

ALink no.	Scaling	Description	From software release
0	S	Fixed value 0 %	
1	S	Fixed value +100 %	
2	S	Fixed value -100 %	
3	S	Value of parameter P 111)	
4	S	Inverted value of parameter P 111	
5	S	BAPS setpoint 1	
6	S	BAPS setpoint 2	
7	S	BAPS setpoint 3	
8	S	BAPS setpoint 4	
9	S	BAPS setpoint 5	
10	S	BAPS setpoint 6	
11	S	BAPS setpoint 7	
12	S	BAPS setpoint 8	
13		BAPS actual value 1	
14		BAPS actual value 2	
15		BAPS actual value 3	
16		BAPS actual value 4	
17		BAPS actual value 5	
18		BAPS actual value 6	
19		BAPS actual value 7	
20		BAPS actual value 8	
21	S	USS protocol, setpoint 1	
22	S	USS protocol, setpoint 2	
23		USS protocol, actual value 1	
24		USS protocol, actual value 2	
25	S	Value at analog input 1 (terminal input signal at terminal X1: 17-18)	
26	S	Transfer value, analog input 1	

ALink no.	Scaling	Description	From software release
27	S	Value at analog input 2 (terminal input signal at terminal X1: 19-20)	
28	S	Transfer value, analog input 2	
29	S	Value at analog input 3 (terminal input signal at terminal X1: 21-22)	
30	S	Transfer value, analog input 3	
31	S	Value at analog input 4 (terminal input signal at terminal X1: 23-24)	
32	S	Transfer value, analog input 4	
33	S	Fixed setpoint 1	
34	S	Fixed setpoint 2	
35	S	Fixed setpoint 3	
36	S	Fixed setpoint 4	
37	S	Fixed setpoint 5	
38	S	Fixed setpoint 6	
39	S	Output, setpoint generator	
40	S	Output, motor potentiometer	
41	S	Transfer value, motor potentiometer	
42	S	Ramp generator A total setpoint	
43	S	Input, ramp generator A	
44	S	Output, ramp generator A	
45	S	Input/output difference, ramp generator A	
46	S	Input, ramp generator B	
47	S	Output, ramp generator B	
48	S	Input/output difference, ramp generator B	
49			
50	S	Speed controller total setpoint	
51	S	Setpoint at the speed controller input	
52	S	Output, down ramp for quick stop and main contactor off / controller disabled	

5.36 ALink list

ALink no.	Scaling	Description	From software release
53	S	Motor EMF for armature voltage control	
54	S	Input, analog tachogenerator (actual value signal)	
55	S	Input, incremental encoder 1 (actual value signal)	
56			
57	S	Actual value at the speed controller after smoothing	
58	S	Positive absolute value, ALink 57	
59	S	Actual value at speed controller after smoothing, with offset (P 267)	
60	S	Positive absolute value, ALink 59	
61	S	Actual value at the speed controller with D component	
62	S	D component of the speed controller actual value	
63	S	Speed controller setpoint/actual value difference without D component	
64	S	Positive absolute value, ALink 63	
65	S	Speed controller setpoint/actual value difference with D component	
66	S	Current setpoint after limiting	
67	S	Smoothed current setpoint	
68	S	Positive absolute value, active current limit	
69	S	Output, speed-dependent current limit	
70	S	Output, gear protection	
71	S	Speed controller output, P component	
72	S	Speed controller output, I component	
73	S	Preset value of speed controller I component (P 321)	
74		Momentary speed-controller P-gain ($K_P = 1.00 \rightarrow 61$ mV at the analog output)	
75		Momentary speed-controller integral-action time ($T_n = 100$ ms $\rightarrow 61$ mV at the analog output)	
76	S	Output of current setpoint integrator	
77	S	Rectifier output for current setpoint	03.03

ALink no.	Scaling	Description	From software release
78	S	Setpoint at the current controller input	
79	S	Actual value at the current controller input	
80	S	+/- actual armature current	
81	S	Setpoint/actual value difference at current controller input	
82	S	Positive absolute value, ALink 81	
83	S	Output of current controller	
84	S	P component of current controller output	
85	S	I component of current controller output	
86	S	Output, current precontrol	
87	S	Input of armature control unit	
88	S	Coupler output of armature control unit	
89	S	Corrected coupler output of armature control unit	
90	S	Setpoint of EMF controller (field unit)	
91	S	Actual value of EMF controller (field unit)	
92	S	Setpoint/actual value difference at EMF controller (field unit)	
93	S	Positive absolute value, ALink 92	
94	S	EMF controller output (field unit)	
95	S	P component of the EMF controller output (field unit)	
96	S	I component of the EMF controller output (field unit)	
97	S	Setpoint of field current controller	
98	S	Actual value of field current controller	
99	S	Setpoint/actual value difference at field current controller input	
100	S	Positive absolute value, ALink 99	
101	S	Output of field current controller	
102	S	P component of field current controller output	
103	S	I component of field current controller output	
104	S	Coupler output of field power stage	
105	S	Unassigned PI controller total setpoint	

5.36 ALink list

ALink no.	Scaling	Description	From software release
106	S	Setpoint at the unassigned PI controller input	
107	S	Actual value at the unassigned PI controller after smoothing	
108	S	Positive absolute value, ALink 107	
109	S	Setpoint/actual value difference at unassigned PI controller (without D component)	
110	S	Positive absolute value, ALink 109	
111	S	Actual value at the unassigned PI controller (with D component)	
112	S	Setpoint/actual value difference at unassigned PI controller with D component	
113	S	D component of the unassigned PI controller actual value	
114	S	Output of unassigned PI controller	
115	S	P component of the unassigned PI controller output	
116	S	I component of the unassigned PI controller output	
117	S	Output of unassigned adder 1 (P 111 active)	
118	S	Inverted output, unassigned adder 1	
119	S	Positive absolute value of output of unassigned adder 1	
120	S	Negative absolute value of output of unassigned adder 1	
121	S	Output of unassigned adder 2 (P 111 active)	
122	S	Inverted output of unassigned adder 2	
123	S	Positive absolute value of output of unassigned adder 2	
124	S	Negative absolute value of output of unassigned adder 2	
125	S	Output of unassigned adder 3 (P 111 active)	
126	S	Inverted output of unassigned adder 3	
127	S	Positive absolute value of output of unassigned adder 3	
128	S	Negative absolute value of output of unassigned adder 3	
129	S	Output of unassigned adder 4 (P 111 active)	
130	S	Inverted output of unassigned adder 4	
131	S	Positive absolute value of output of unassigned adder 4	
132	S	Negative absolute value of output of unassigned adder 4	

ALink no.	Scaling	Description	From software release
133	S	Adding input of unassigned multiplier 1 $P 618 + P 619 = \Sigma_1$ (P 111 active)	
134	S	Adding input of unassigned multiplier 1 $P 620 + P 621 = \Sigma_2$ (P 111 active)	
135	S	Output of unassigned multiplier 1: $\Sigma_1 \times \Sigma_2$ (P 111 active)	
136	S	Adding input at unassigned multiplier 2 $P 622 + P 623 = \Sigma_1$ (P 111 active)	
137	S	Adding input at unassigned multiplier 2 $P 624 + P 625 = \Sigma_2$ (P 111 active)	
138	S	Output of unassigned multiplier 2: $\Sigma_1 \times \Sigma_2$ (P 111 active)	
139	S	Adding input at unassigned divider 1 $P 626 + P 627 = \Sigma_1$ (P 111 active)	
140	S	Adding input at unassigned divider 1 $P 628 + P 629 = \Sigma_2$ (P 111 active)	
141	S	Output, unassigned divider 1: $\Sigma_1 \div \Sigma_2$ (P 111 active)	
142	S	Adding input at unassigned divider 2 $P 630 + P 631 = \Sigma_1$ (P 111 active)	
143	S	Adding input at unassigned divider 2 $P 624 + P 625 = \Sigma_2$ (P 111 active)	
144	S	Output of unassigned divider 2: $\Sigma_1 \div \Sigma_2$ (P 111 active)	
145	S	Output unassigned multiplier 1 (P111 active)	03.10
146	S	Output unassigned multiplier 2 (P111 active)	03.10
147	S	Output unassigned multiplier 3 (P111 active)	03.10
148			
149			
150			
151			
152			
153	S	Minimum value limiter, output with polarity	
154	S	Positive absolute value, ALink 153	

5.36 ALink list

ALink no.	Scaling	Description	From software release
155	S	Output of input signal formatter (P 111 active)	
156	S	Inverted input of absolute value generator 1	
157	S	Positive absolute value of absolute value generator 1	
158	S	Negative absolute value of absolute value generator 1	
159	S	Inverted input of absolute value generator 2	
160	S	Positive absolute value of absolute value generator 2	
161	S	Negative absolute value of absolute value generator 2	
162	S	Inverted input of absolute value generator 3	
163	S	Positive absolute value of absolute value generator 3	
164	S	Negative absolute value of absolute value generator 3	
165	S	Inverted input of absolute value generator 4	
166	S	Positive absolute value of absolute value generator 4	
167	S	Negative absolute value of absolute value generator 4	
168	S	Output of unassigned inverter 1	
169	S	Output of unassigned inverter 2	
170	S	Output of unassigned limiter	
171	S	Input/output difference of unassigned limiter (P 111 active)	
172	S	Inverted to ALink 171 (P 111 active)	
173	S	Output of unassigned dead band	
174			
175			
176			
177			
178			
179			
180			
181			
182			

ALink no.	Scaling	Description	From software release
183			
184			
185			
186	S	Output of unassigned filter 1	
187	S	Output of unassigned filter 2	
188			
189			
190			
191			
192			
193			
194			
195	S	Output of unassigned changeover switch 1	
196	S	Output of unassigned changeover switch 2 (P 682 → P 111 not active, P 683 + P 684 → P 111 active)	
197	S	Output of unassigned changeover switch 3 (P 685 → P 111 not active, P 686 + P 687 → P 111 active)	
198	S	Output of unassigned changeover switch 4	
199	S	Input signal of unassigned comparator	
200	S	Positive absolute value of ALink 199	
201	S	Upper switch threshold of unassigned comparator (P 678)	
202	S	Lower switch threshold of unassigned comparator (P 678 – P 679)	
203	S	Unsmoothed speed controller actual value	03.06
204	S	Actual-speed positive absolute value for speed adjustment monitoring (F 47)	03.06
205	S	EMF-characteristics positive absolute value for speed adjustment monitoring (F 47)	03.06
206	S	EMF compare signal for speed adjustment monitoring (F 47)	03.06
207			

5.36 ALink list

ALink no.	Scaling	Description	From software release
208	S	Speed controller output	03.06
209	S	Additional current setpoint	03.06
210	S	Current setpoint before limiting	03.06
211		Momentary P-gain of the unassigned PI controller ($K_P = 1.00 \rightarrow 61 \text{ mV}$ at the analog output)	
212		Momentary integral-action time of the unassigned PI controller ($T_n = 100 \text{ ms} \rightarrow 61 \text{ mV}$ at the analog output)	
213		Freely definable status word P 966	
214			
215	S	Armature voltage, motor (100 % \rightarrow value in P 073)	
216	S	EMF characteristics, not smoothed	
217	S	EMF characteristics, smoothed (30 ms at $f_{\text{mains}} = 50 \text{ Hz}$)	
218		Mains voltage of electronics supply ($400 V_{\text{eff}} \rightarrow 16384$)	
219	S	Computed armature power unit mains voltage	
220		Motor i^2t value (rated temperature =100 % $\rightarrow 2.5 \text{ V}$ at analog output)	
221		Power section temperature threshold ($^{\circ}\text{C}$)	
222	S	Power input ($U_A \times I_A$)	
223	S	Power output ($\text{EMF} \times I_A$)	
224		Power unit temperature [$^{\circ}\text{C}$]	03.15
225	S	Ixt value of the power unit monitoring	03.20
226	S	Current limit because of Ixt monitoring	03.20
227		Overload period in s (read from power unit identifier)	03.20
228			
229			
230		internal value P 071, $16384 \cong 400 \text{ V}$	
231			
232		Smoothed power unit voltage (30 ms at $f_{\text{mains}} = 50 \text{ Hz}$)	03.10
233	S	$L \times di_{\text{set}}/dt$ (armature current))	03.03

ALink no.	Scaling	Description	From software release
234	S	Smoothed power unit voltage for mains EMF computation (30 ms at $f_{mains} = 50$ Hz)	
235	S	$I_{A_actual} \times R_A$	
236	S	$U_A - I_{A_actual} \times R_A$	
237	S	$L \times di_{actual}/dt$ (armature current)	
238	S	I_{A_OFFs} ; 8192 $\hat{=}$ the value set in parameter P 003	
239		Output of torque direction detector (0 % \rightarrow TD1 50 % \rightarrow TD2)	
240		Second-pulse suppression (0 % \rightarrow second-pulse suppression not active; 50 % \rightarrow second-pulse suppression active)	
241		EMF related to the mains voltage	
242		arsin table value, correct polarity for current precontrol	
243	S	Intermittent-current limit related to mains voltage	
244	S	Table value of intermittent-current characteristic	
245	S	EMF precontrol value	
246	S	Current precontrol value (g)	
247	S	Current precontrol value (x)	
248		Inductance constant for current precontrol di_{set}/dt	
249	S	Control voltage difference at field coupler output	
250	S	EMF register (current precontrol)	
251	S	Current intermittent-current limit	03.06
252		Internal, counted back tachometer voltage	03.20
253		Internal correction factor tachometer	03.20
254			
255	S	16-bit analog input via option board 3.9817	
256			
257		α_G Armature current converter (internal value of parameter P 360, 16384 \rightarrow 0° el.)	
258		α_W Armature current converter (internal value of parameter P 361, -16384 \rightarrow 180° el.)	

5.36 ALink list

ALink no.	Scaling	Description	From software release
259		α Armature current converter (momentary firing angle in X.XX °el; display without decimal point)	
260		α_G Field current converter (internal value of parameter P 381, 16384 → 0° el)	
261		α_W Field current converter (internal value of parameter P 382, -16384 → 180° el.)	
262		α Field current converter (momentary firing angle in X.XX °el; display without decimal point)	
263	S	DAC code, analog tachogenerator	
264	S	DAC code, actual field current	
265		Ext. ADC channel 1, analog input 1; not scaled	
266		Ext. ADC channel 2, analog input 2; not scaled	
267		Ext. ADC channel 3, analog input 3; not scaled	
268		Ext. ADC channel 4, analog input 4; not scaled	
269		Ext. ADC channel 5, field current; not scaled	
270		Ext. ADC channel 6, armature voltage; not scaled	
271		Ext. ADC channel 7, armature current, not scaled	
272		Ext. ADC channel 8, analog tachogenerator, not scaled	
273		μ P ADC channel 1, spare, not scaled	
274		μ P ADC channel 2, power unit temperature 1, not scaled	
275		μ P ADC channel 3, (power unit temperature 2), not scaled	
276		μ P ADC channel 4, mains voltage of electronics supply, not scaled	
277		μ P ADC channel 5, power unit identification of field, not scaled	
278		μ P ADC channel 6 (mains failure duration), not scaled	
279		μ P ADC channel 7, BKD/BKF identifier, not scaled BKD _{setpoint} 377 BKD _{range} 307...439 BKD _{setpoint} 683 BKD _{range} 612...744	
280		μ P ADC channel 8, spare, not scaled	
281		Incremental encoder constant 1	
282		Scaling factor, incremental encoder 1	

ALink no.	Scaling	Description	From software release
283		Increments per scan, incremental encoder 1	
284		Counting interval, incremental encoder 1 (resolution 0.8 μ s)	
285			
286			
287			
288			
289		Armature firing pulse interval (resolution 0.8 μ s)	
290		Mains counter hardware	
291		Mains counter software	
292		Momentary mains block	
293		Current control voltage block	
294		Current firing pattern selection	
295		Current firing pattern	
296		Sync correction, field	
297		Firing pulse interval (armature 4166 \rightarrow 60° el. at $f_{\text{mains}} = 50$ Hz; actual - set)	
298		Mains counter hardware (ALink 290) - Mains counter software (ALink 291)	
299			
300		Parameter value 1 (parameter selected via P 996)	
301		Parameter value 2 (parameter selected via P 997)	
302		Momentary processing time of program module (resolution 0.8 μ s; selected with P 993)	
303		Momentary processing time of controller-program (resolution 0.8 μ s)	
304		Milliseconds counter (\rightarrow numerical value corresponds to ms \rightarrow communication monitoring)	
305		Max. processing time of controller program (resolution 0.8 μ s)	
306		Max. processing time of background program (resolution 0.8 μ s)	

5.36 ALink list

ALink no.	Scaling	Description	From software release
307		Momentary processing time of background program (resolution 0.8 μ s)	
308		Unassigned development ALink (no fixed assignment)	
309			
310		Threshold for speed adjustment (P 504)	
311		Slave pointer, ramp generator A	
312		Internal ALink required for data record manager	
313			
314			
315		Contents of parameter P 999	
316		Minimum value of ALink x, selected with P 994	
317		Maximum value of ALink x, selected with P 995	
318		Zero-current time to intermittent-current limit (resolution 0.8 μ s)	
319			
320			
321		Software version (as per parameter P 035)	03.03
322		Software type (as per parameter P 036)	03.03
323		Software number (For BKx 7000: 6.1200 - only 1200 displayed !).	03.03
324		Option board identification at interface BAPS 1 (X201)	03.03
325		Option board software version at interface BAPS 1 (X201)	03.03
326		Option board software type at interface BAPS 1 (X201)	03.03
327		Option board software number at interface BAPS 1 (X201)	03.03
328		Option board identification at interface BAPS 2 (not available)	03.03
329		Option board software version at interface BAPS 2 (not available)	03.03
330		Option board software type at interface BAPS 2 (not available)	03.03

ALink no.	Scaling	Description	From software release
331		Option board software number at interface BAPS 2 (not available)	03.03
332		Option board identification at interface BAPS 3 (not available)	03.03
333		Option board software version at interface BAPS 3 (not available)	03.03
334		Option board software type at interface BAPS 3 (not available)	03.03
335		Option board software number at interface BAPS 3 (not available)	03.03
336		Option board identification see also at interface BAPS 4 (X200)	03.03
337		Option board software version at interface BAPS 4 (X200)	03.03
338		Option board software type at interface BAPS 4 (X200)	03.03
339		Option board software number at interface BAPS 4 (X200)	03.03
340		Power unit type, serial; 0: BKD 1: BKF	03.04
341		Power unit current intensity code, serial	03.04
342			
343			
344		Mains frequency in Hz	03.10
345		Synchro filter correction value	03.10
346		Motor temperature channel 1 [°C] (corresponds with parameter P 027)	03.10
347		Motor temperature channel 2 [°C] (corresponds with parameter P 028)	03.10
348			
349			
350			

5.37 DLink list

DLink no.	Description	Parameter	Bit no.	From software release
0	Fixed value 0 (LOW)			
1	Fixed value 1 (HIGH)			
2	HIGH: State 'ENABLED' (P 001 = 4, 5, 6 or 7)	P 100	0...2	
3	HIGH: State 'MALFUNCTION'; (see also DL0083)	P 100	3	
4	HIGH: State 'WARNING' (see also DL0087)	P 100	7	
5	HIGH: Ramp generator setpoint reached (see also DL0284)	P 220	12	
6	HIGH: $n > n_{max}$ (error 44, see also DL0864)	P 921	0	
7	HIGH: $n > n_{min}$ (see also DL0314)	P 250	10	
8	HIGH: $n > n_{x1}$ (see also DL0316)	P 250	12	
9	HIGH: $n > n_{x2}$ (see also DL0317)	P 250	13	
10	HIGH: $n > n_{x3}$ (see also DL0318)	P 250	14	
11	HIGH: $n > n_{x4}$ (see also DL0319)	P 250	15	
12	HIGH: Drift lock active (see also DL0360)	P 300	8	
13	HIGH: $n_{actual} = n_{set}$ at the speed controller (see also DL0364)	P 300	12	
14	HIGH: Unassigned comparator A < B (see also DL0564)			
15	HIGH: $i_a > i_{a_x1}$ (see also DL0392)	P 350	8	
16	HIGH: $i_a > i_{a_x2}$ (see also DL0393)	P 350	9	
17	HIGH: Current limit reached (see also DL0366)	P 300	14	
18	HIGH: Speed controller output limit active (see also DL0367)	P 300	15	
19	HIGH: Motor i^2t monitoring (see also DL0068)	P 030	4	
20	HIGH: Monitoring of heat sink temperature limit (see also DL0054)	P 020	6	
21	HIGH: Actual field current < 50 % field current setpoint (including P 385; see also DL0424)	P 370	8	
22	HIGH: Status 'READY TO OPERATE' (P 001 = 2, see also DL0080)	P 100	0	
23	HIGH: Drive disabled (inverted with regard to DLink 2)	P 100	0...2	03.06

DLink no.	Description	Parameter	Bit no.	From software release
24				
25				
26				
27				
28				
29				
30				
31				
32				
33				
34				
35				
36				
37				
38				
39				
40				
41				
42				
43				
44	Bit pattern from parameter P xxx (P 684 - P 686)			
45	Inverted with regard to DL0044			
46	Bit pattern from parameter P yyy (P 687 - P 689)			
47	Inverted with regard to DL0046			
48	LOW: Spare	P 020	0	
49	LOW: Spare	P 020	1	
50	LOW: Spare	P 020	2	
51	Error in module power unit	P 020	3	

5.37 DLink list

DLink no.	Description	Parameter	Bit no.	From software release
52	LOW: Spare	P 020	4	
53	HIGH: Warning 13: Power unit temperature exceeded pre-warning threshold	P 020	5	03.15
54	HIGH: Power unit temperature > limit value (limit value in ALink 221)	P 020	6	
55	HIGH: Mains frequency \geq threshold frequency (P 528)	P 020	7	03.10
56	HIGH: Ixt threshold exceeded, current set value limited	P 020	8	03.20
57	LOW: Spare	P 020	9	
58	LOW: Spare	P 020	10	
59	LOW: Spare	P 020	11	
60	LOW: Spare	P 020	12	
61	LOW: Spare	P 020	13	
62	LOW: Spare	P 020	14	
63	LOW: Spare	P 020	15	
64	HIGH: Motor I ² t monitoring switched on (P 078 unequal 0 min)	P 030	0	
65	LOW: Spare	P 030	1	
66	LOW: Spare	P 030	2	
67	LOW: Spare	P 030	3	
68	HIGH: Motor I ² t value \geq threshold (P 525)	P 030	4	
69	LOW: Spare	P 030	5	
70	LOW: Spare	P 030	6	
71	LOW: Spare	P 030	7	
72	LOW: Spare	P 030	8	
73	LOW: Spare	P 030	9	
74	LOW: Spare	P 030	10	
75	HIGH: Motor I ² t value \geq 100 %	P 030	11	
76	LOW: Spare	P 030	12	
77	LOW: Spare	P 030	13	
78	LOW: Spare	P 030	14	

DLink no.	Description	Parameter	Bit no.	From software release
79	LOW: Spare	P 030	15	
80	HIGH: Ready	P 100	0	
81	HIGH: Switched on	P 100	1	
82	HIGH: Operation enabled	P 100	2	
83	HIGH: Error (malfunction)	P 100	3	
84	HIGH: Voltage disabled	P 100	4	
85	HIGH: Quick stop	P 100	5	
86	HIGH: Switch-on disabled	P 100	6	
87	HIGH: Warning	P 100	7	
88	HIGH: in freely definable status word (P 966). At least one bit set	P 100	8	
89	HIGH: Communication source parameter P 121 not 0	P 100	9	
90	HIGH: Setpoint reached ($n_{actual} = n_{set}$ at the speed controller)	P 100	10	
91	LOW: Spare	P 100	11	
92	LOW: Spare	P 100	12	
93	LOW: Spare	P 100	13	
94	Freely configurable status bit (see parameter P 104)	P 100	14	
95	Freely configurable status bit (see parameter P 105)	P 100	15	
96	Switch on	P 101	0	
97	Disable voltage	P 101	1	
98	Quick stop	P 101	2	
99	Enable operation	P 101	3	
100	LOW: Spare	P 101	4	
101	LOW: Spare	P 101	5	
102	LOW: Spare	P 101	6	
103	Reset malfunction	P 101	7	
104	LOW: Spare	P 101	8	
105	LOW: Spare	P 101	9	
106	LOW: Spare	P 101	10	

5.37 DLink list

DLink no.	Description	Parameter	Bit no.	From software release
107	LOW: Spare	P 101	11	
108	LOW: Spare	P 101	12	
109	LOW: Spare	P 101	13	
110	LOW: Spare	P 101	14	
111	Write protection	P 101	15	
112	HIGH: Communication enabled	P 128	0	
113	LOW: Spare	P 128	1	
114	LOW: Spare	P 128	2	
115	LOW: Spare	P 128	3	
116	Bit 0 of drive address (see also USS drive address P 120)	P 128	4	
117	Bit 1 of drive address (see also USS drive address P 120)	P 128	5	
118	Bit 2 of drive address (see also USS drive address P 120)	P 128	6	
119	Bit 3 of drive address (see also USS drive address P 120)	P 128	7	
120	Bit 4 of drive address (see also USS drive address P 120)	P 128	8	
121	Bit 5 of drive address (see also USS drive address P 120)	P 128	9	
122	Bit 6 of drive address (see also USS drive address P 120)	P 128	10	
123	Bit 7 of drive address (see also USS drive address P 120)	P 128	11	
124	LOW: Spare	P 128	12	
125	LOW: Spare	P 128	13	
126	LOW: Spare	P 128	14	
127	LOW: Spare	P 128	15	
128	HIGH: Message evaluation active	P 130	0	
129	LOW: Spare	P 130	1	
130	LOW: Spare	P 130	2	
131	LOW: Spare	P 130	3	
132	HIGH: No messages to own address received for longer than 1 s	P 130	4	
133	HIGH: No messages on the bus for longer than 5 s	P 130	5	
134	LOW: Spare	P 130	6	

DLink no.	Description	Parameter	Bit no.	From software release
135	HIGH: USS interface initialisation error	P 130	7	
136	LOW: Reserved	P 130	8	
137	LOW: Reserved	P 130	9	
138	HIGH: Error during actual-value reading	P 130	10	
139	HIGH: Error during setpoint writing	P 130	11	
140	LOW: Spare	P 130	12	
141	LOW: Spare	P 130	13	
142	LOW: Spare	P 130	14	
143	LOW: Spare	P 130	15	
144	HIGH: Communication enabled (BAPS process data)	P 140	0	
145	HIGH: Communication source 10 _{hex} (control word not active)	P 140	1	
146	LOW: Spare	P 140	2	
147	LOW: Spare	P 140	3	
148	HIGH: Communication initialised (BAPS cyclic data)	P 140	4	
149	LOW: Spare	P 140	5	
150	LOW: Spare	P 140	6	
151	LOW: Spare	P 140	7	
152	Option board messages	P 140	8	
153		P 140	9	
154		P 140	10	
155		P 140	11	
156		P 140	12	
157		P 140	13	
158		P 140	14	
159		P 140	15	
160	HIGH: Communication enabled (BAPS demand data)	P 143	0	
161	LOW: Spare	P 143	1	
162	LOW: Spare	P 143	2	

5.37 DLink list

DLink no.	Description	Parameter	Bit no.	From software release
163	LOW: Spare	P 143	3	
164	LOW: Spare	P 143	4	
165	LOW: Spare	P 143	5	
166	LOW: Spare	P 143	6	
167	LOW: Spare	P 143	7	
168	LOW: Spare	P 143	8	
169	LOW: Spare	P 143	9	
170	LOW: Spare	P 143	10	
171	LOW: Spare	P 143	11	
172	LOW: Spare	P 143	12	
173	LOW: Spare	P 143	13	
174	LOW: Spare	P 143	14	
175	LOW: Spare	P 143	15	
176	Bit combinations 00 Data record manager ready for command	P 150	0	
177	01 Data record manager executing command 10 Spare 11 Data record manager completed command		1	
178	LOW: Spare	P 150	2	
179	HIGH: Error in data record manager (error code see P 155)	P 150	3	
180	HIGH: Warning: Data record was not saved	P 150	4	
181	LOW: Spare	P 150	5	
182	LOW: Spare	P 150	6	
183	LOW: Spare	P 150	7	
184	HIGH: Data record 1 active	P 150	8	
185	HIGH: Data record 2 active	P 150	9	
186	HIGH: Data record 3 active	P 150	10	
187	HIGH: Data record 4 active	P 150	11	
188	HIGH: Data record 5 active	P 150	12	
189	HIGH: Data record 6 active	P 150	13	

DLink no.	Description	Parameter	Bit no.	From software release
190	HIGH: Data record 7 active	P 150	14	
191	LOW: Spare	P 150	15	
192	LOW: Spare (P 180)			
193	LOW: Spare			
194	LOW: Spare			
195	LOW: Spare			
196	LOW: Spare			
197	LOW: Spare			
198	LOW: Spare			
199	LOW: Spare			
200	LOW: Spare			
201	LOW: Spare			
202	LOW: Spare			
203	LOW: Spare			
204	LOW: Spare			
205	LOW: Spare			
206	LOW: Spare			
207	LOW: Spare (P 180)			
208	Invert analog input 1	P 181	0	
209	Set analog input 1 to zero	P 181	1	
210	Invert analog input 2	P 181	2	
211	Set analog input 2 to zero	P 181	3	
212	Invert analog input 3	P 181	4	
213	Set analog input 3 to zero	P 181	5	
214	Invert analog input 4	P 181	6	
215	Set analog input 4 to zero	P 181	7	
216	LOW: Spare	P 181	8	
217	LOW: Spare	P 181	9	

5.37 DLink list

DLink no.	Description	Parameter	Bit no.	From software release
218	LOW: Spare	P 181	10	
219	LOW: Spare	P 181	11	
220	LOW: Spare	P 181	12	
221	LOW: Spare	P 181	13	
222	LOW: Spare	P 181	14	
223	LOW: Spare	P 181	15	
224	LOW: Spare (P 200)			
225	LOW: Spare (P 200)			
226	LOW: Spare (P 200)			
227	LOW: Spare (P 200)			
228	LOW: Spare (P 200)			
229	LOW: Spare (P 200)			
230	LOW: Spare (P 200)			
231	LOW: Spare (P 200)			
232	LOW: Spare (P 200)			
233	LOW: Spare (P 200)			
234	LOW: Spare (P 200)			
235	LOW: Spare (P 200)			
236	LOW: Spare (P 200)			
237	LOW: Spare (P 200)			
238	LOW: Spare (P 200)			
239	LOW: Spare (P 200)			
240	HIGH: Motor potentiometer enabled, LOW: Correction active	P 210	0	
241	LOW: Spare	P 210	1	
242	LOW: Spare	P 210	2	
243	HIGH: Motor potentiometer error (P 213 / P 215 parameter conflict, for example)	P 210	3	
244	HIGH: Motor potentiometer has reached upper limit	P 210	4	
245	HIGH: Motor potentiometer has reached lower limit	P 210	5	

DLink no.	Description	Parameter	Bit no.	From software release
246	HIGH: Motor potentiometer UP command active	P 210	6	
247	HIGH: Motor potentiometer DOWN command active	P 210	7	
248	HIGH: Motor potentiometer ramp-up	P 210	8	
249	HIGH: Motor potentiometer ramp-down	P 210	9	
250	HIGH: Motor potentiometer ramp-up or -down	P 210	10	
251	LOW: Spare	P 210	11	
252	LOW: Spare	P 210	12	
253	LOW: Spare	P 210	13	
254	LOW: Spare	P 210	14	
255	LOW: Spare	P 210	15	
256	Motor potentiometer UP	P 211	0	
257	Motor potentiometer DOWN	P 211	1	
258	LOW: Spare	P 211	2	
259	LOW: Spare	P 211	3	
260	LOW: Spare	P 211	4	
261	LOW: Spare	P 211	5	
262	LOW: Spare	P 211	6	
263	LOW: Spare	P 211	7	
264	LOW: Spare	P 211	8	
265	LOW: Spare	P 211	9	
266	LOW: Spare	P 211	10	
267	LOW: Spare	P 211	11	
268	LOW: Spare	P 211	12	
269	LOW: Spare	P 211	13	
270	LOW: Spare	P 211	14	
271	LOW: Spare	P 211	15	
272	HIGH: Ramp generator A enabled	P 220	0	
273	LOW: Spare	P 220	1	

5.37 DLink list

DLink no.	Description	Parameter	Bit no.	From software release
274	LOW: Spare	P 220	2	
275	HIGH: Error in ramp generator A module	P 220	3	
276	HIGH: Ramp generator A output set to zero (quick ramp-down active)	P 220	4	
277	HIGH: Ramp generator A stop active	P 220	5	
278	HIGH: Ramp generator A, setpoint 0 setting active	P 220	6	
279	HIGH: Quick stop or disable/stop deceleration ramp active (P 109 / P 110)	P 220	7	
280	HIGH: Ramp generator A ramp-up active	P 220	8	
281	HIGH: Ramp generator A ramp-down active	P 220	9	
282	LOW: Reserved	P 220	10	
283	LOW: Reserved	P 220	11	
284	HIGH: Ramp generator A setpoint reached (output = input)	P 220	12	
285	HIGH: Ramp generator A setpoint limit active	P 220	13	
286	LOW: Spare	P 220	14	
287	LOW: Spare	P 220	15	
288	Select ramp generator A parameter set (LOW: Parameter set 1 / HIGH: Parameter set 2)	P 221	0	
289	LOW: Spare	P 221	1	
290	LOW: Spare	P 221	2	
291	LOW: Spare	P 221	3	
292	Ramp generator A output = 0 (quick ramp-down active)	P 221	4	
293	Stop ramp generator A	P 221	5	
294	Setpoint 0 at input of ramp generator A	P 221	6	
295	Setpoint 0 at input of ramp generator B	P 221	7	
296	Ramp generator B output = 0 (quick ramp-down active)	P 221	8	
297	LOW: Spare	P 221	9	
298	LOW: Spare	P 221	10	
299	LOW: Spare	P 221	11	

DLink no.	Description	Parameter	Bit no.	From software release
300	LOW: Spare	P 221	12	
301	LOW: Spare	P 221	13	
302	LOW: Spare	P 221	14	
303	LOW: Spare	P 221	15	
304	HIGH: Actual value detector active	P 250	0	
305	LOW: Spare	P 250	1	
306	LOW: Spare	P 250	2	
307	HIGH: Error in actual value detection	P 250	3	
308	LOW: Spare	P 250	4	
309	HIGH: Overspeed monitoring function has tripped (threshold: P 501)	P 250	5	
310	LOW: Spare	P 250	6	
311	LOW: Spare	P 250	7	
312	LOW: Spare	P 250	8	
313	LOW: Spare	P 250	9	
314	HIGH: $n > n_{\min}$ (threshold P 505, hysteresis P 506)	P 250	10	
315	LOW: Spare	P 250	11	
316	HIGH: $n > n_{x1}$ (threshold P 507, hysteresis P 508)	P 250	12	
317	HIGH: $n > n_{x2}$ (threshold P 509, hysteresis P 510)	P 250	13	
318	HIGH: $n > n_{x3}$ (threshold P 511, hysteresis P 512)	P 250	14	
319	HIGH: $n > n_{x4}$ (threshold P 513, hysteresis P 514)	P 250	15	
320	LOW: Spare			
321	LOW: Spare			
322	LOW: Spare			
323	LOW: Spare			
324	LOW: Spare			
325	LOW: Spare			
326	LOW: Spare			

5.37 DLink list

DLink no.	Description	Parameter	Bit no.	From software release
327	LOW: Spare			
328	LOW: Spare			
329	LOW: Spare			
330	LOW: Spare			
331	LOW: Spare			
332	LOW: Spare			
333	LOW: Spare			
334	LOW: Spare			
335	LOW: Spare			
336	LOW: Spare	P 260	0	
337	LOW: Spare	P 260	1	
338	LOW: Spare	P 260	2	
339	HIGH: Error in incremental encoder	P 260	3	
340	LOW: Spare	P 260	4	
341	LOW: Spare	P 260	5	
342	LOW: Spare	P 260	6	
343	LOW: Spare	P 260	7	
344	HIGH: Frequency limit for encoder evaluation exceeded (warning 1)	P 260	8	
345	LOW: Spare	P 260	9	
346	LOW: Spare	P 260	10	
347	LOW: Spare	P 260	11	
348	LOW: Spare	P 260	12	
349	LOW: Spare	P 260	13	
350	LOW: Spare	P 260	14	
351	LOW: Spare	P 260	15	
352	Bit combinations 00 Speed controller disabled	P 300	0	
353	01 Speed controller enabled 10 Spare 11 Current control (P 102 = -2)		1	

DLink no.	Description	Parameter	Bit no.	From software release
354	LOW: Torque direction 1 requested, HIGH: Torque direction 2 requested	P 300	2	
355	HIGH: Error in speed controller	P 300	3	
356	HIGH: Drive blocked (error 8)	P 300	4	
357	HIGH: Speed-dependent current limit active for the speed controller	P 300	5	
358	HIGH: Gear protection limit active for the speed controller	P 300	6	
359	HIGH: External current limit active for the speed controller	P 300	7	
360	HIGH: Drift lock active	P 300	8	
361	HIGH: Speed controller input setpoint limit active	P 300	9	
362	HIGH: Ixt limit limits the speed controller	P 300	10	03.20
363	LOW: Speed controller output positive HIGH: Speed controller output negative	P 300	11	
364	HIGH: $n_{\text{actual}}=n_{\text{set}}$ at speed controller	P 300	12	
365	HIGH: P 325 / P 326 limit active for the speed controller	P 300	13	
366	HIGH: Current limit reached (LED H706)	P 300	14	
367	HIGH: Speed controller output at the limit	P 300	15	
368	Setpoint 0 at speed controller if HIGH	P 301	0	
369	LOW: Spare	P 301	1	
370	LOW: Spare	P 301	2	
371	LOW: Spare	P 301	3	
372	LOW: Spare	P 301	4	
373	LOW: Spare	P 301	5	
374	LOW: Spare	P 301	6	
375	LOW: Spare	P 301	7	
376	LOW: Spare	P 301	8	
377	LOW: Spare	P 301	9	
378	LOW: Spare	P 301	10	
379	LOW: Spare	P 301	11	
380	LOW: Spare	P 301	12	

5.37 DLink list

DLink no.	Description	Parameter	Bit no.	From software release
381	LOW: Spare	P 301	13	
382	LOW: Spare	P 301	14	
383	LOW: Spare	P 301	15	
384	HIGH: Armature current controller enabled	P 350	0	
385	LOW: Reserved	P 350	1	
386	LOW: Reserved	P 350	2	
387	HIGH: Error in armature current controller	P 350	3	
388	LOW: Reserved	P 350	4	
389	LOW: Reserved	P 350	5	
390	HIGH: Armature circuit α_W reached	P 350	6	
391	HIGH: Armature circuit α_G reached	P 350	7	
392	HIGH: $I_A > I_{Ax_1}$ threshold exceeded (threshold P 521, hysteresis P 522)	P 350	8	
393	HIGH: $I_A > I_{Ax_2}$ threshold exceeded (threshold P 523, hysteresis P 524)	P 350	9	
394	LOW: Spare	P 350	10	
395	LOW: Spare	P 350	11	
396	LOW: Spare	P 350	12	
397	LOW: Spare	P 350	13	
398	LOW: Spare	P 350	14	
399	LOW: Spare	P 350	15	
400	LOW: Spare			
401	LOW: Spare			
402	LOW: Spare			
403	LOW: Spare			
404	LOW: Spare			
405	LOW: Spare			
406	LOW: Spare			
407	LOW: Spare			

DLink no.	Description	Parameter	Bit no.	From software release
408	LOW: Spare			
409	LOW: Spare			
410	LOW: Spare			
411	LOW: Spare			
412	LOW: Spare			
413	LOW: Spare			
414	LOW: Spare			
415	LOW: Spare			
416	LOW: Field unit OFF HIGH: Field unit ON	P 370	0	
417	LOW: Constant field HIGH: Field weakening	P 370	1	
418	LOW: Spare	P 370	2	
419	HIGH: Error in field unit	P 370	3	
420	HIGH: Minimum field current setpoint reached	P 370	4	
421	HIGH: Maximum field current setpoint reached	P 370	5	
422	HIGH: Field circuit α_W reached	P 370	6	
423	HIGH: Field circuit α_G reached	P 370	7	
424	HIGH: Field current actual value < 50 % field current setpoint (after release time)	P 370	8	
425	LOW: Spare	P 370	9	
426	LOW: Spare	P 370	10	
427	LOW: Spare	P 370	11	
428	LOW: Spare	P 370	12	
429	LOW: Spare	P 370	13	
430	LOW: Spare	P 370	14	
431	LOW: Spare	P 370	15	
432	LOW: Spare			
433	LOW: Spare			
434	LOW: Spare			

5.37 DLink list

DLink no.	Description	Parameter	Bit no.	From software release
435	LOW: Spare			
436	LOW: Spare			
437	LOW: Spare			
438	LOW: Spare			
439	LOW: Spare			
440	LOW: Spare			
441	LOW: Spare			
442	LOW: Spare			
443	LOW: Spare			
444	LOW: Spare			
445	LOW: Spare			
446	LOW: Spare			
447	LOW: Spare			
448	LOW: Reserved	P 400	0	
449	LOW: Spare	P 400	1	
450	LOW: Spare	P 400	2	
451	HIGH: Error in binary inputs	P 400	3	
452	LOW: Pulse inhibit - HIGH: Pulse enable (terminal)	P 400	4	
453	LOW: Quick stop active - HIGH: Quick stop not active (terminal)	P 400	5	
454	LOW: Disable controller - HIGH: Enable controller (terminal)	P 400	6	
455	LOW: Main contactor OFF - HIGH: Main contactor ON (terminal)	P 400	7	
456	HIGH: Digital input 1 has HIGH signal at terminal	P 400	8	
457	HIGH: Digital input 2 has HIGH signal at terminal	P 400	9	
458	HIGH: Digital input 3 has HIGH signal at terminal	P 400	10	
459	HIGH: Digital input 4 has HIGH signal at terminal	P 400	11	
460	HIGH: Digital input 5 has HIGH signal at terminal	P 400	12	
461	HIGH: Digital input 6 has HIGH signal at terminal	P 400	13	
462	HIGH: Digital input 7 has HIGH signal at terminal	P 400	14	

DLink no.	Description	Parameter	Bit no.	From software release
463	HIGH: Digital input 8 has HIGH signal at terminal	P 400	15	
464	LOW: Spare	P 420	0	
465	LOW: Spare	P 420	1	
466	LOW: Spare	P 420	2	
467	HIGH: Error in digital outputs	P 420	3	
468	LOW: Spare	P 420	4	
469	LOW: Spare	P 420	5	
470	LOW: Spare	P 420	6	
471	LOW: Spare	P 420	7	
472	HIGH: Digital output 1 has HIGH signal at terminal	P 420	8	
473	HIGH: Digital output 2 has HIGH signal at terminal	P 420	9	
474	HIGH: Digital output 3 has HIGH signal at terminal	P 420	10	
475	HIGH: Digital output 4 has HIGH signal at terminal	P 420	11	
476	HIGH: Digital output 5 has HIGH signal at terminal	P 420	12	
477	HIGH: Digital output 6 has HIGH signal at terminal	P 420	13	
478	HIGH: Ready relay triggered	P 420	14	
479	HIGH: Main contactor relay triggered	P 420	15	
480	LOW: Spare	P 460	0	
481	LOW: Spare	P 460	1	
482	LOW: Spare	P 460	2	
483	LOW: Spare	P 460	3	
484	HIGH: Analog output 1 ON (P 465 unequal 0)	P 460	4	
485	HIGH: Analog output 2 ON (P 470 unequal 0)	P 460	5	
486	HIGH: Analog output 3 ON (P 475 unequal 0)	P 460	6	
487	HIGH: Analog output 4 ON (P 480 unequal 0)	P 460	7	
488	HIGH: Analog output 1, negative signal limit active	P 460	8	
489	HIGH: Analog output 2, negative signal limit active	P 460	9	
490	HIGH: Analog output 3, negative signal limit active	P 460	10	

5.37 DLink list

DLink no.	Description	Parameter	Bit no.	From software release
491	HIGH: Analog output 4, negative signal limit active	P 460	11	
492	HIGH: Analog output 1, positive signal limit active	P 460	12	
493	HIGH: Analog output 2, positive signal limit active	P 460	13	
494	HIGH: Analog output 3, positive signal limit active	P 460	14	
495	HIGH: Analog output 4, positive signal limit active	P 460	15	
496	LOW: Spare			
497	LOW: Spare			
498	LOW: Spare			
499	LOW: Spare			
500	LOW: Spare			
501	LOW: Spare			
502	LOW: Spare			
503	LOW: Spare			
504	LOW: Spare			
505	LOW: Spare			
506	LOW: Spare			
507	LOW: Spare			
508	LOW: Spare			
509	LOW: Spare			
510	LOW: Spare			
511	LOW: Spare			
512	HIGH: Motor temperature monitoring channel 1 active (P 541 = 1)	P 540	0	03.10
513	HIGH: Motor temperature monitoring channel 2 active (P 544 = 1)	P 540	1	03.10
514	LOW: Spare	P 540	2	03.10
515	HIGH: Error in module motor temperature monitoring (F 96 to F 101)	P 540	3	03.10
516	HIGH: Warning motor temperatur channel 1 active (W 11)	P 540	4	03.10
517	HIGH: Warning motor temperatur channel 2 active (W 12)	P 540	5	03.10
518	HIGH: Message threshold motor temperature channel 1 exceeded	P 540	6	03.20

DLink no.	Description	Parameter	Bit no.	From software release
519	HIGH: Message threshold motor temperature channel 2 exceeded	P 540	7	03.20
520	LOW: Spare	P 540	8	03.10
521	LOW: Spare	P 540	9	03.10
522	LOW: Spare	P 540	10	03.10
523	LOW: Spare	P 540	11	03.10
524	LOW: Spare	P 540	12	03.10
525	LOW: Spare	P 540	13	03.10
526	LOW: Spare	P 540	14	03.10
527	LOW: Spare	P 540	15	03.10
528	LOW: Unassigned PI controller disabled HIGH: Unassigned PI controller enabled	P 560	0	
529	LOW: Spare	P 560	1	
530	LOW: Spare	P 560	2	
531	HIGH: Error in unassigned PI controller	P 560	3	
532	HIGH: Controller output, positive limit active (P 577)	P 560	4	
533	HIGH: Controller output, negative limit active (P 578)	P 560	5	
534	HIGH: I component, positive limit active (P 575)	P 560	6	
535	HIGH: I component, negative limit active (P 576)	P 560	7	
536	HIGH: Unassigned PI controller setpoint limit active	P 560	8	
537	LOW: Spare	P 560	9	
538	LOW: Spare	P 560	10	
539	LOW: Spare	P 560	11	
540	LOW: Spare	P 560	12	
541	LOW: Spare	P 560	13	
542	LOW: Spare	P 560	14	
543	LOW: Spare	P 560	15	
544	LOW: Switch setpoint = 0 at unassigned PI controller	P 561	0	
545	LOW: Disable unassigned PI controller	P 561	1	
546	LOW: Deactivate I component at unassigned PI controller	P 561	2	

5.37 DLink list

DLink no.	Description	Parameter	Bit no.	From software release
547	LOW: Spare	P 561	3	
548	LOW: Spare	P 561	4	
549	LOW: Spare	P 561	5	
550	LOW: Spare	P 561	6	
551	LOW: Spare	P 561	7	
552	LOW: Spare	P 561	8	
553	LOW: Spare	P 561	9	
554	LOW: Spare	P 561	10	
555	LOW: Spare	P 561	11	
556	LOW: Spare	P 561	12	
557	LOW: Spare	P 561	13	
558	LOW: Spare	P 561	14	
559	LOW: Spare	P 561	15	
560	LOW: Spare	P 600	0	
561	LOW: Spare	P 600	1	
562	LOW: Spare	P 600	2	
563	LOW: Spare	P 600	3	
564	HIGH: Unassigned comparator output inverted to DLink 14	P 600	4	
565	LOW: Spare	P 600	5	
566	LOW: Spare	P 600	6	
567	LOW: Spare	P 600	7	
568	Changeover switch 1 active (signal P 667 passed on) (feedback signal)	P 600	8	
569	Changeover switch 2 active (signals P 669+P 670 passed on) (feedback signal)	P 600	9	
570	Changeover switch 3 active (signal P 672*P 673 passed on) (feedback signal)	P 600	10	
571	Changeover switch 4 active (signal P 674 passed on) (feedback signal)	P 600	11	
572	LOW: Spare	P 600	12	

DLink no.	Description	Parameter	Bit no.	From software release
573	LOW: Spare	P 600	13	
574	LOW: Spare	P 600	14	
575	LOW: Spare	P 600	15	
576	HIGH: Unassigned changeover switch 1 active (signal P 667 passed on)	P 601	0	
577	HIGH: Unassigned changeover switch 2 active (signals P 669+P 670 passed on)	P 601	1	
578	HIGH: Unassigned changeover switch 3 active (signal P 672*P 673 passed on)	P 601	2	
579	HIGH: Unassigned changeover switch 4 active (signal P 674 passed on)	P 601	3	
580	LOW: Spare	P 601	4	
581	LOW: Spare	P 601	5	
582	LOW: Spare	P 601	6	
583	LOW: Spare	P 601	7	
584	LOW: Spare	P 601	8	
585	LOW: Spare	P 601	9	
586	LOW: Spare	P 601	10	
587	LOW: Spare	P 601	11	
588	LOW: Spare	P 601	12	
589	LOW: Spare	P 601	13	
590	LOW: Spare	P 601	14	
591	LOW: Spare	P 601	15	
592	Output of digital delay element 1 (P 702 / P 703)	-	-	
593	Inverted DLink 592	-	-	
594	Output of digital delay element 2 (P 704 / P 705)	-	-	
595	Inverted DLink 594	-	-	
596	Output of digital delay element 3 (P 706 / P 707)	-	-	
597	Inverted DLink 595	-	-	
598	Output of digital delay element 4 (P 708 / P 709)	-	-	

5.37 DLink list

DLink no.	Description	Parameter	Bit no.	From software release
599	Inverted DLink 596	-	-	
600	Output of gate 1 (AND / OR / XOR) (P 710-P 714)	-	-	
601	Inverted DLink 600	-	-	
602	Output of gate 2 (AND / OR / XOR) (P 715-P 719)	-	-	
603	Inverted DLink 602	-	-	
604	Output of gate 3 (AND / OR / XOR) (P 720-P 724)	-	-	
605	Inverted DLink 604	-	-	
606	Output of gate 4 (AND / OR / XOR) (P 725-P 729)	-	-	
607	Inverted DLink 606	-	-	
608	LOW: Spare			
609	LOW: Spare			
610	LOW: Spare			
611	LOW: Spare			
612	LOW: Spare			
613	LOW: Spare			
614	LOW: Spare			
615	LOW: Spare			
616	LOW: Spare			
617	LOW: Spare			
618	LOW: Spare			
619	LOW: Spare			
620	LOW: Spare			
621	LOW: Spare			
622	LOW: Spare			
623	LOW: Spare			
624	HIGH: Error in converter control module	P 900	0	
625	LOW: Spare	P 900	1	
626	LOW: Spare	P 900	2	

DLink no.	Description	Parameter	Bit no.	From software release
627	LOW: Spare	P 900	3	
628	LOW: Spare	P 900	4	
629	LOW: Spare	P 900	5	
630	LOW: Spare	P 900	6	
631	HIGH: Error in speed controller module	P 900	7	
632	HIGH: Error in incremental encoder 1 evaluation module	P 900	8	
633	HIGH: Error in data record manager module	P 900	9	
634	LOW: Spare	P 900	10	
635	HIGH: Error in operating system module	P 900	11	
636	HIGH: Error in μ P module	P 900	12	
637	HIGH: Error in EMF module	P 900	13	
638	HIGH: Error in power unit module	P 900	14	
639	HIGH: Error in field unit module	P 900	15	
640	HIGH: Error in motor potentiometer module	P 901	0	03.10
641	HIGH: Error in digital outputs module	P 901	1	03.10
642	HIGH: Error in actual value detector module	P 901	2	03.10
643	HIGH: Error in reversing unit module	P 901	3	03.10
644	HIGH: Error in power unit module	P 901	4	03.10
645	HIGH: Error in digital inputs module	P 901	5	03.10
646	HIGH: Error in analog inputs module	P 901	6	03.10
647	HIGH: Error in armature current controller module	P 901	7	03.10
648	HIGH: Error in data record manager 2	P 901	8	03.10
649	HIGH: Error in data record manager 3	P 901	9	03.10
650	HIGH: Error in module unassigned funktion blocks	P 901	10	03.10
651	HIGH: Error in module motor temperature monitoring (F 96 to F 101)	P 901	11	03.10
652	LOW: Spare	P 901	12	
653	LOW: Spare	P 901	13	
654	LOW: Spare	P 901	14	

5.37 DLink list

DLink no.	Description	Parameter	Bit no.	From software release
655	LOW: Spare	P 901	15	
656	HIGH: Warning 1 active P 261 / P 262 parameter conflict	P 902	0	
657	HIGH: Warning 2 active Data record save not completed	P 902	1	
658	HIGH: Warning 3 active Power unit temperature exceeded	P 902	2	
659	HIGH: Warning 4 active Data record not erased	P 902	3	
660	HIGH: Warning 5 active P 072 / P 074 parameter conflict	P 902	4	
661	HIGH: Warning 6 active Intermittent-current limit cannot be defined (at P 082 = 1)	P 902	5	
662	HIGH: Warning 7 active Data record change not possible	P 902	6	
663	HIGH: Warning 8 active Motor i^2t tripped	P 902	7	
664	HIGH: Warning 9 active Cannot erase boot data record	P 902	8	
665	HIGH: Warning 10 active Cannot reset	P 902	9	
666	HIGH: Warning motor temperature channel 1 active (W 11)	P 902	10	03.10
667	HIGH: Warning motor temperature channel 2 active (W 12)	P 902	11	03.10
668	HIGH: Warning 13 active: Pre-warning power unit temperature	P 902	12	03.15
669	LOW: Spare	P 902	13	
670	LOW: Spare	P 902	14	
671	LOW: Spare	P 902	15	
672	LOW: Spare	P 903	0	
673	LOW: Spare	P 903	1	
674	LOW: Spare	P 903	2	
675	LOW: Spare	P 903	3	
676	LOW: Spare	P 903	4	
677	LOW: Spare	P 903	5	
678	LOW: Spare	P 903	6	
679	LOW: Spare	P 903	7	
680	LOW: Spare	P 903	8	
681	LOW: Spare	P 903	9	

DLink no.	Description	Parameter	Bit no.	From software release
682	LOW: Spare	P 903	10	
683	LOW: Spare	P 903	11	
684	LOW: Spare	P 903	12	
685	LOW: Spare	P 903	13	
686	LOW: Spare	P 903	14	
687	LOW: Spare	P 903	15	
688	HIGH: Error 1 active: BASS communication time monitoring	P 910	0	
689	HIGH: Error 2 active: USS communication time monitoring	P 910	1	
690	HIGH: Error 3 active: Cyclic data time monitoring	P 910	2	
691	HIGH: Error 4 active: Demand data transmission time monitoring	P 910	3	
692	LOW: Spare	P 910	4	
693	LOW: Spare	P 910	5	
694	LOW: Spare	P 910	6	
695	LOW: Spare	P 910	7	
696	HIGH: Error 91 active: Undefined field bus card status	P 910	8	03.04
697	HIGH: Error 92 active: Field bus error	P 910	9	03.04
698	HIGH: Error 93 active: Field bus setpoint/actual-value configuration error	P 910	10	03.04
699	LOW: Spare	P 910	11	
700	LOW: Spare	P 910	12	
701	LOW: Spare	P 910	13	
702	LOW: Spare	P 910	14	
703	HIGH: Error 7 active: Program branching error	P 910	15	
704	LOW: Spare	P 911	0	
705	HIGH: Error 8 active: Drive blocked	P 911	1	
706	LOW: Spare	P 911	2	
707	LOW: Spare	P 911	3	
708	LOW: Spare	P 911	4	
709	LOW: Spare	P 911	5	

5.37 DLink list

DLink no.	Description	Parameter	Bit no.	From software release
710	LOW: Spare	P 911	6	
711	LOW: Spare	P 911	7	
712	LOW: Spare	P 911	8	
713	LOW: Spare	P 911	9	
714	LOW: Spare	P 911	10	
715	LOW: Spare	P 911	11	
716	LOW: Spare	P 911	12	
717	LOW: Spare	P 911	13	
718	LOW: Spare	P 911	14	
719	LOW: Spare	P 911	15	
720	HIGH: Error 9 active: Incremental encoder 1, scaling error	P 912	0	
721	LOW: Spare	P 912	1	
722	LOW: Spare	P 912	2	
723	LOW: Spare	P 912	3	
724	LOW: Spare	P 912	4	
725	LOW: Spare	P 912	5	
726	LOW: Spare	P 912	6	
727	LOW: Spare	P 912	7	
728	LOW: Spare	P 912	8	
729	LOW: Spare	P 912	9	
730	LOW: Spare	P 912	10	
731	LOW: Spare	P 912	11	
732	LOW: Spare	P 912	12	
733	LOW: Spare	P 912	13	
734	LOW: Spare	P 912	14	
735	LOW: Spare	P 912	15	
736	HIGH: Error 10 active: EEPROM-to-RAM copy error	P 913	0	
737	HIGH: Error 11 active: Damaged boot data record header	P 913	1	

DLink no.	Description	Parameter	Bit no.	From software release
738	HIGH: Error 12 active: Boot data record checksum error	P 913	2	
739	HIGH: Error 13 active: Damaged primary data header	P 913	3	
740	HIGH: Error 14 active: EEPROM too small	P 913	4	
741	HIGH: Error 15 active: Error on data record save	P 913	5	
742	HIGH: Error 57 active: Ambiguous data record change source	P 913	6	
743	HIGH: Error 58 active: EEPROM empty	P 913	7	
744	HIGH: Error 59 active: Parameter error in data record 1 (write error/value)	P 913	8	
745	HIGH: Error 60 active: Parameter error in data record 2 (write error/value)	P 913	9	
746	HIGH: Error 61 active: Parameter error in data record 3 (write error/value)	P 913	10	
747	HIGH: Error 62 active: Parameter error in data record 4 (write error/value)	P 913	11	
748	HIGH: Error 63 active: Parameter error in data record 5 (write error/value)	P 913	12	
749	HIGH: Error 64 active: Parameter error in data record 6 (write error/value)	P 913	13	
750	HIGH: Error 65 active: Error in ROM data record (no. 7)	P 913	14	
751	HIGH: Error 66 active: Primary data parameter error	P 913	15	
752	HIGH: Error 16 active: Ambiguous converter type BKD/BKF (1-Q/4-Q)	P 914	0	
753	HIGH: Error 17 active: Error ext. analog-digital converter	P 914	1	
754	HIGH: Error 18 active: Unknown field power unit identification	P 914	2	
755	HIGH: Error 19 active: Field connection error (AC)	P 914	3	
756	HIGH: Error 20 active: Armature power unit connection error (AC)	P 914	4	
757	HIGH: Error 21 active: CCW rotating field at armature power unit	P 914	5	
758	HIGH: Error 22 active: Phase failure at armature power unit	P 914	6	
759	LOW: Spare	P 914	7	
760	LOW: Spare	P 914	8	
761	LOW: Spare	P 914	9	

5.37 DLink list

DLink no.	Description	Parameter	Bit no.	From software release
762	LOW: Spare	P 914	10	
763	LOW: Spare	P 914	11	
764	LOW: Spare	P 914	12	
765	LOW: Spare	P 914	13	
766	LOW: Spare	P 914	14	
767	LOW: Spare	P 914	15	
768	HIGH: Error 23 active: External bus error	P 915	0	
769	HIGH: Error 24 active: Program address error	P 915	1	
770	HIGH: Error 25 active: Data address error	P 915	2	
771	HIGH: Error 26 active: Protected OPCODE	P 915	3	
772	HIGH: Error 27 active: OPCODE error	P 915	4	
773	HIGH: Error 28 active: Stack underflow	P 915	5	
774	HIGH: Error 29 active: Stack overflow	P 915	6	
775	HIGH: Error 30 active: External watchdog tripped	P 915	7	
776	HIGH: Error 31 active: Internal watchdog tripped	P 915	8	
777	HIGH: Error 32 active: RAM test error	P 915	9	
778	HIGH: Error 70 active: Option board does not respond	P 915	10	
779	LOW: Spare	P 915	11	
780	LOW: Spare	P 915	12	
781	LOW: Spare	P 915	13	
782	LOW: Spare	P 915	14	
783	LOW: Spare	P 915	15	
784	HIGH: Error 33 active: Parameter conflict P 071 / P 073	P 916	0	
785	HIGH: Error 34 active: Repeated negative actual armature current	P 916	1	
786	HIGH: Error 52 active: Mains undervoltage	P 916	2	
787	HIGH: Error 53 active: Overcurrent TD1	P 916	3	
788	HIGH: Error 54 active: Overcurrent TD2	P 916	4	
789	LOW: Spare	P 916	5	

DLink no.	Description	Parameter	Bit no.	From software release
790	LOW: Spare	P 916	6	
791	LOW: Spare	P 916	7	
792	LOW: Spare	P 916	8	
793	LOW: Spare	P 916	9	
794	LOW: Spare	P 916	10	
795	LOW: Spare	P 916	11	
796	LOW: Spare	P 916	12	
797	LOW: Spare	P 916	13	
798	LOW: Spare	P 916	14	
799	LOW: Spare	P 916	15	
800	HIGH: Error 35 active: No synchronisation	P 917	0	
801	HIGH: Error 36 active: Firing pulse interval differs from specified value	P 917	1	
802	LOW: Spare	P 917	2	
803	HIGH: Error 38 active: Mains frequency < 45 Hz	P 917	3	
804	HIGH: Error 39 active: Mains frequency > 65 Hz	P 917	4	
805	HIGH: Error 55 active: Zero-current detector defective	P 917	5	
806	LOW: Spare	P 917	6	
807	LOW: Spare	P 917	7	
808	LOW: Spare	P 917	8	
809	LOW: Spare	P 917	9	
810	LOW: Spare	P 917	10	
811	LOW: Spare	P 917	11	
812	LOW: Spare	P 917	12	
813	LOW: Spare	P 917	13	
814	LOW: Spare	P 917	14	
815	LOW: Spare	P 917	15	
816	HIGH: Error 40 active: Field current monitoring	P 918	0	
817	HIGH: Error 69 active: Field power unit differs from EEPROM value	P 918	1	

5.37 DLink list

DLink no.	Description	Parameter	Bit no.	From software release
818	LOW: Spare	P 918	2	
819	LOW: Spare	P 918	3	
820	LOW: Spare	P 918	4	
821	LOW: Spare	P 918	5	
822	LOW: Spare	P 918	6	
823	LOW: Spare	P 918	7	
824	LOW: Spare	P 918	8	
825	LOW: Spare	P 918	9	
826	LOW: Spare	P 918	10	
827	LOW: Spare	P 918	11	
828	LOW: Spare	P 918	12	
829	LOW: Spare	P 918	13	
830	LOW: Spare	P 918	14	
831	LOW: Spare	P 918	15	
832	HIGH: Error 42 active: P 213 / P 215 parameter conflict	P 919	0	
833	LOW: Spare	P 919	1	
834	LOW: Spare	P 919	2	
835	LOW: Spare	P 919	3	
836	LOW: Spare	P 919	4	
837	LOW: Spare	P 919	5	
838	LOW: Spare	P 919	6	
839	LOW: Spare	P 919	7	
840	LOW: Spare	P 919	8	
841	LOW: Spare	P 919	9	
842	LOW: Spare	P 919	10	
843	LOW: Spare	P 919	11	
844	LOW: Spare	P 919	12	
845	LOW: Spare	P 919	13	

DLink no.	Description	Parameter	Bit no.	From software release
846	LOW: Spare	P 919	14	
847	LOW: Spare	P 919	15	
848	HIGH: Error 43 active: Shortcircuit/overload at a digital output	P 920	0	
849	LOW: Spare	P 920	1	
850	LOW: Spare	P 920	2	
851	LOW: Spare	P 920	3	
852	LOW: Spare	P 920	4	
853	LOW: Spare	P 920	5	
854	LOW: Spare	P 920	6	
855	LOW: Spare	P 920	7	
856	LOW: Spare	P 920	8	
857	LOW: Spare	P 920	9	
858	LOW: Spare	P 920	10	
859	LOW: Spare	P 920	11	
860	LOW: Spare	P 920	12	
861	LOW: Spare	P 920	13	
862	LOW: Spare	P 920	14	
863	LOW: Spare	P 920	15	
864	HIGH: Error 44 active: Overspeed	P 921	0	
865	HIGH: Error 45 active: Tachogenerator/encoder failure or armature circuit open	P 921	1	
866	HIGH: Error 46 active: Tachogenerator/encoder polarity reversed	P 921	2	
867	HIGH: Error 47 active: Speed range error	P 921	3	
868	LOW: Spare	P 921	4	
869	LOW: Spare	P 921	5	
870	LOW: Spare	P 921	6	
871	LOW: Spare	P 921	7	

5.37 DLink list

DLink no.	Description	Parameter	Bit no.	From software release
872	LOW: Spare	P 921	8	
873	LOW: Spare	P 921	9	
874	LOW: Spare	P 921	10	
875	LOW: Spare	P 921	11	
876	LOW: Spare	P 921	12	
877	LOW: Spare	P 921	13	
878	LOW: Spare	P 921	14	
879	LOW: Spare	P 921	15	
880	HIGH: Error 48 active: Torque change time exceeded	P 922	0	
881	LOW: Spare	P 922	1	
882	LOW: Spare	P 922	2	
883	LOW: Spare	P 922	3	
884	LOW: Spare	P 922	4	
885	LOW: Spare	P 922	5	
886	LOW: Spare	P 922	6	
887	LOW: Spare	P 922	7	
888	LOW: Spare	P 922	8	
889	LOW: Spare	P 922	9	
890	LOW: Spare	P 922	10	
891	LOW: Spare	P 922	11	
892	LOW: Spare	P 922	12	
893	LOW: Spare	P 922	13	
894	LOW: Spare	P 922	14	
895	LOW: Spare	P 922	15	
896	HIGH: Error 49 active: Armature power unit identification error	P 923	0	
897	HIGH: Error 67 active: Armature power unit identification differs from EEPROM value	P 923	1	
898	HIGH: Error 102 active: Cable break temperature sensor power unit	P 923	2	03.15
899	HIGH: Error 103 active: Short circuit temperature sensor power unit	P 923	3	03.15

DLink no.	Description	Parameter	Bit no.	From software release
900	HIGH: Power unit limit temperature exceeded (P112 = 1)	P 923	4	03.15
901	LOW: Spare	P 923	5	
902	LOW: Spare	P 923	6	
903	LOW: Spare	P 923	7	
904	LOW: Spare	P 923	8	
905	LOW: Spare	P 923	9	
906	LOW: Spare	P 923	10	
907	LOW: Spare	P 923	11	
908	LOW: Spare	P 923	12	
909	LOW: Spare	P 923	13	
910	LOW: Spare	P 923	14	
911	LOW: Spare	P 923	15	
912	HIGH: Error 50 active: Data record selection error	P 924	0	
913	HIGH: Error 68 active: Data record does not exist	P 924	1	
914	LOW: Spare	P 924	2	
915	LOW: Spare	P 924	3	
916	LOW: Spare	P 924	4	
917	LOW: Spare	P 924	5	
918	LOW: Spare	P 924	6	
919	LOW: Spare	P 924	7	
920	LOW: Spare	P 924	8	
921	LOW: Spare	P 924	9	
922	LOW: Spare	P 924	10	
923	LOW: Spare	P 924	11	
924	LOW: Spare	P 924	12	
925	LOW: Spare	P 924	13	
926	LOW: Spare	P 924	14	
927	LOW: Spare	P 924	15	

5.37 DLink list

DLink no.	Description	Parameter	Bit no.	From software release
928	HIGH: Error 51 active: Input current < 3.3 mA at 4 mA ... 20 mA	P 925	0	
929	LOW: Spare	P 925	1	
930	LOW: Spare	P 925	2	
931	LOW: Spare	P 925	3	
932	LOW: Spare	P 925	4	
933	LOW: Spare	P 925	5	
934	LOW: Spare	P 925	6	
935	LOW: Spare	P 925	7	
936	LOW: Spare	P 925	8	
937	LOW: Spare	P 925	9	
938	LOW: Spare	P 925	10	
939	LOW: Spare	P 925	11	
940	LOW: Spare	P 925	12	
941	LOW: Spare	P 925	13	
942	LOW: Spare	P 925	14	
943	LOW: Spare	P 925	15	
944	HIGH: Error 56 active: Offset error armature current detector (> 50 mV)	P 926	0	
945	HIGH: Error 41 active: P 072 out of range	P 926	1	
946	HIGH: Error 37 active: Armature circuit open	P 926	2	
947	LOW: Spare	P 926	3	
948	LOW: Spare	P 926	4	
949	LOW: Spare	P 926	5	
950	LOW: Spare	P 926	6	
951	LOW: Spare	P 926	7	
952	LOW: Spare	P 926	8	
953	LOW: Spare	P 926	9	
954	LOW: Spare	P 926	10	
955	LOW: Spare	P 926	11	

DLink no.	Description	Parameter	Bit no.	From software release
956	LOW: Spare	P 926	12	
957	LOW: Spare	P 926	13	
958	LOW: Spare	P 926	14	
959	LOW: Spare	P 926	15	
960	HIGH: Error 5 active: Incompatible software	P 927	0	
961	HIGH: Error 6 active: Invalid boot source entry	P 927	1	
962	HIGH: Error 71 active: Illegal value in P 72 / P 74 in data record 1	P 927	2	
963	HIGH: Error 72 active: Illegal value in P 72 / P 74 in data record 2	P 927	3	
964	HIGH: Error 73 active: Illegal value in P 72 / P 74 in data record 3	P 927	4	
965	HIGH: Error 74 active: Illegal value in P 72 / P 74 in data record 4	P 927	5	
966	HIGH: Error 75 active: Illegal value in P 72 / P 74 in data record 5	P 927	6	
967	HIGH: Error 76 active: Illegal value in P 72 / P 74 in data record 6	P 927	7	
968	HIGH: Error 77 active: Illegal value in P 79 in data record 1	P 927	8	
969	HIGH: Error 78 active: Illegal value in P 79 in data record 2	P 927	9	
970	HIGH: Error 79 active: Illegal value in P 79 in data record 3	P 927	10	
971	HIGH: Error 80 active: Illegal value in P 79 in data record 4	P 927	11	
972	HIGH: Error 81 active: Illegal value in P 79 in data record 5	P 927	12	
973	HIGH: Error 82 active: Illegal value in P 79 in data record 6	P 927	13	
974	HIGH: Error 68 active: Data record does not exist	P 927	14	
975	HIGH: Error 83 active: EEPROM write time exceeded	P 927	15	
976	HIGH: Error 84 active: Primary data checksum error	P 928	0	03.03
977	HIGH: Error 85 active: Checksum error in data record 1	P 928	1	03.03
978	HIGH: Error 86 active: Checksum error in data record 2	P 928	2	03.03
979	HIGH: Error 87 active: Checksum error in data record 3	P 928	3	03.03
980	HIGH: Error 88 active: Checksum error in data record 4	P 928	4	03.03

5.37 DLink list

DLink no.	Description	Parameter	Bit no.	From software release
981	HIGH: Error 89 active: Checksum error in data record 5	P 928	5	03.03
982	HIGH: Error 90 active: Checksum error in data record 6	P 928	6	03.03
983	LOW: Spare	P 928	7	
984	LOW: Spare	P 928	8	
985	LOW: Spare	P 928	9	
986	LOW: Spare	P 928	10	
987	LOW: Spare	P 928	11	
988	LOW: Spare	P 928	12	
989	LOW: Spare	P 928	13	
990	LOW: Spare	P 928	14	
991	LOW: Spare	P 928	15	
992	HIGH: Error 94 active: (P 657 / P 658) parameter conflict	P 929	0	03.10
993	HIGH: Error 105 active: freely definable error, P730	P 929	1	03.15
994	LOW: Spare	P 929	2	
995	LOW: Spare	P 929	3	
996	LOW: Spare	P 929	4	
997	LOW: Spare	P 929	5	
998	LOW: Spare	P 929	6	
999	LOW: Spare	P 929	7	
1000	LOW: Spare	P 929	8	
1001	LOW: Spare	P 929	9	
1002	LOW: Spare	P 929	10	
1003	LOW: Spare	P 929	11	
1004	LOW: Spare	P 929	12	
1005	LOW: Spare	P 929	13	
1006	LOW: Spare	P 929	14	
1007	LOW: Spare	P 929	15	
1008	HIGH: Bit 0 set in freely definable status word	P 966	0	

DLink no.	Description	Parameter	Bit no.	From software release
1009	HIGH: Bit 1 set in freely definable status word	P 966	1	
1010	HIGH: Bit 2 set in freely definable status word	P 966	2	
1011	HIGH: Bit 3 set in freely definable status word	P 966	3	
1012	HIGH: Bit 4 set in freely definable status word	P 966	4	
1013	HIGH: Bit 5 set in freely definable status word	P 966	5	
1014	HIGH: Bit 6 set in freely definable status word	P 966	6	
1015	HIGH: Bit 7 set in freely definable status word	P 966	7	
1016	HIGH: Bit 8 set in freely definable status word	P 966	8	
1017	HIGH: Bit 9 set in freely definable status word	P 966	9	
1018	HIGH: Bit 10 set in freely definable status word	P 966	10	
1019	HIGH: Bit 11 set in freely definable status word	P 966	11	
1020	HIGH: Bit 12 set in freely definable status word	P 966	12	
1021	HIGH: Bit 13 set in freely definable status word	P 966	13	
1022	HIGH: Bit 14 set in freely definable status word	P 966	14	
1023	HIGH: Bit 15 set in freely definable status word	P 966	15	
1024	HIGH: Error 96 active: Motor switch off temperature channel 1 reached (P 543)	P 930	0	03.10
1025	HIGH: Error 97 active: Motor switch off temperature channel 2 reached (P 546)	P 930	1	03.10
1026	HIGH: Error 98 active: Disconnection motor temperature sensor channel 1	P 930	2	03.10
1027	HIGH: Error 99 active: Disconnection motor temperature sensor channel 2	P 930	3	03.10
1028	HIGH: Error 100 active: Short circuit motor temperature sensor channel 1	P 930	4	03.10
1029	HIGH: Error 101 active: Short circuit motor temperature sensor channel 2	P 930	5	03.10
1030	LOW: Spare	P 930	6	03.10
1031	LOW: Spare	P 930	7	03.10
1032	LOW: Spare	P 930	8	03.10
1033	LOW: Spare	P 930	9	03.10

5.37 DLink list

DLink no.	Description	Parameter	Bit no.	From software release
1034	LOW: Spare	P 930	10	03.10
1035	LOW: Spare	P 930	11	03.10
1036	LOW: Spare	P 930	12	03.10
1037	LOW: Spare	P 930	13	03.10
1038	LOW: Spare	P 930	14	03.10
1039	LOW: Spare	P 930	15	03.10
1040	Status of bit 0 of the ALink selected with P 682			
1041	Status of bit 1 of the ALink selected with P 682			
1042	Status of bit 2 of the ALink selected with P 682			
1043	Status of bit 3 of the ALink selected with P 682			
1044	Status of bit 4 of the ALink selected with P 682			
1045	Status of bit 5 of the ALink selected with P 682			
1046	Status of bit 6 of the ALink selected with P 682			
1047	Status of bit 7 of the ALink selected with P 682			
1048	Status of bit 8 of the ALink selected with P 682			
1049	Status of bit 9 of the ALink selected with P 682			
1050	Status of bit 10 of the ALink selected with P 682			
1051	Status of bit 11 of the ALink selected with P 682			
1052	Status of bit 12 of the ALink selected with P 682			
1053	Status of bit 13 of the ALink selected with P 682			
1054	Status of bit 14 of the ALink selected with P 682			
1055	Status of bit 15 of the ALink selected with P 682			
1056	Status of bit 0 of the ALink selected with P 683			
1057	Status of bit 1 of the ALink selected with P 683			
1058	Status of bit 2 of the ALink selected with P 683			
1059	Status of bit 3 of the ALink selected with P 683			
1060	Status of bit 4 of the ALink selected with P 683			
1061	Status of bit 5 of the ALink selected with P 683			

DLink no.	Description	Parameter	Bit no.	From software release
1062	Status of bit 6 of the ALink selected with P 683			
1063	Status of bit 7 of the ALink selected with P 683			
1064	Status of bit 8 of the ALink selected with P 683			
1065	Status of bit 9 of the ALink selected with P 683			
1066	Status of bit 10 of the ALink selected with P 683			
1067	Status of bit 11 of the ALink selected with P 683			
1068	Status of bit 12 of the ALink selected with P 683			
1069	Status of bit 13 of the ALink selected with P 683			
1070	Status of bit 14 of the ALink selected with P 683			
1071	Status of bit 15 of the ALink selected with P 683			
1072				
1073				
1074				
1075				
1076				
7077				
1078				
1079				
1080				
1081				
1082				
1083				
1084				
1085				

5.37.1 Description of DLinks (2...23)

DLink 2 State 'Enabled'

The converter is in 'enabled' status P 001 = 4, 5, 6, 7). See also [►State machine of the converter control](#) from page 72.

DLink 3 State 'Malfunction'

The bit is in HIGH state if there is a malfunction. As soon as a malfunction occurs, the drive **starts to coast** and the ready relay drops out (contacts X2: 1, 2 and 3). Certain errors can be acknowledged externally (see P 101, [►BKF7000 error list \(P 037\)](#) from page 424 and [►Digital input functions DIF](#) from page 94).

The bit is in LOW status if there is no error (malfunction) present.

To output the signal LOW active (protection against wire breakage), use the associated parameter to reverse the polarity of the digital output used.

DLink 4 State 'Warning'

The bit is in HIGH state if there is a warning present. Warnings do not affect the drive - it remains ready for operation. The ready relay remains picked-up. Warnings cannot be acknowledged externally. As soon as the condition triggering the warning is no longer present, the converter automatically revokes the signal.

The bit is in LOW status if there is no warning signal present.

DLink 5 Ramp generator setpoint reached

Signal to indicate that the ramp generator output has reached the value applied to the input. The bit is in HIGH state if the ramp generator output equals the ramp generator input. The bit is in LOW state if ramp generator output and ramp generator input are not identical.

DLink 6 $n > n_{\max}$

The bit changes to HIGH status if the drive has reached the threshold set with parameter P 501. The drive **starts to coast**, and the ready-to-operate relay drops out. Error 44 is displayed.

The bit is in LOW state if the motor speed remains below the set threshold.

During optimisation, the overspeed monitoring threshold is internally set to 20 %. After completing optimisation, the original value is re-entered into parameter P 501.



NOTE

This is no redundant safety system as an assumption is made as to the motor speed from the actual speed determined by the converter.

Monitoring requires an **error-free** tachogenerator or incremental encoder.

Operator safety guidelines must be observed !

DLink 7 $n > n_{\min}$ signal (also LED H703)

The bit changes to LOW state as soon as the motor falls below speed $n = P\ 505 - P\ 506$.

The bit changes to HIGH state as soon as the motor exceeds speed $n = P\ 505$.

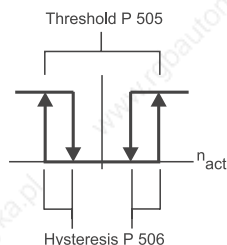

If the value entered in parameter Hysteresis P 506 is higher than the threshold P 505, the lower switching threshold is set to 0.10 %.

This signal also defines the limit which, once fallen short of, switches the drive from braking by quick stop or stop into the coasting state (drive disabled). See parameters P 107 to P 110.

DLink 8 $n > n_{x1}$ signal

The following applies to the signal thresholds:

The bit changes to HIGH state as soon as the actual speed exceeds the value set with parameter P 507, in other words $n > P\ 507$.

The bit changes to LOW state as soon as the actual speed falls below the threshold set with parameter P 507 minus the hysteresis set in parameter P 508, in other words at $n < P\ 507 - P\ 508$.

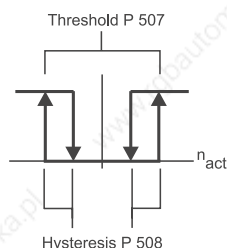

If the value entered in parameter Hysteresis P 508 is higher than the threshold P 507, the lower switching threshold is set to 0.10 %.

DLink 9 $n > n_{x2}$ signal

The following applies to the signal thresholds:

The bit changes to HIGH state as soon as the actual speed exceeds the value set with parameter P 509, in other words $n > P\ 509$.

The bit changes to LOW state as soon as the actual speed falls below the threshold set with parameter P 509 minus the hysteresis set in parameter P 510, in other words at $n < P\ 509 - P\ 510$.

If the value entered in parameter Hysteresis P 510 is higher than the threshold P 509, the lower switching threshold is set to 0.10 %.

For a diagram on the switching thresholds see DLink 8.

DLink 10 $n > n_{x3}$ signal

The following applies to the signal thresholds:

The bit changes to HIGH state as soon as the actual speed exceeds the value set with parameter P 511, in other words at $n > P 511$.

The bit changes to LOW state as soon as the actual speed falls below the threshold set with parameter P 511 minus the hysteresis set in parameter P 512, in other words at $n < P 511 - P 512$.

If the value entered in parameter Hysteresis P 512 is higher than the threshold P 511, the lower switching threshold is set to 0.10 %.

For a diagram on the switching thresholds see DLink 8.

DLink 11 $n > n_{x4}$ signal

The following applies to the signal thresholds:

The bit changes to HIGH state as soon as the actual speed exceeds the value set with parameter P 513, in other words at $n > P 513$.

The bit changes to LOW state as soon as the actual speed falls below the threshold set with parameter P 513 minus the hysteresis set in parameter P 514, in other words at $n < P 513 - P 514$.

If the value entered in parameter Hysteresis P 514 is higher than the threshold P 513, the lower switching threshold is set to 0.10 %.

For a diagram on the switching thresholds see DLink 8.

DLink 12 Drift lock active

The drift lock is active when **P 322 \neq 0**, the actual speed has fallen below the threshold set with parameter P 323 **and** the speed setpoint has fallen below the threshold set with parameter P 324. It is inactive if **P 322 = 0**, or if at **P 322 \neq 0** the actual speed exceeds the threshold set with parameter P 323 **or** the speed setpoint exceeds the threshold set with parameter P 324.

The bit adopts HIGH state when the drift lock is active.

The bit adopts LOW state when the drift lock is inactive.

The drift lock can become active only if parameter P 322 contains a value other than 0. At P 322 = 0, this bit is always in LOW state !

An active drift lock affects the speed controller feedback only, **the drive is not disabled !**

DLink 13 $n_{actual} = n_{set}$ signal at the speed controller

The bit adopts HIGH state as soon as the difference between setpoint and actual value at the speed controller (ALink 60, actual value without D component !) falls below the value set with parameter P 515 minus the hysteresis P 516.

The bit adopts LOW state as soon as the difference between setpoint and actual value at the speed controller (ALink 64) exceeds the value set with parameter P 515.

If the value entered in parameter Hysteresis P 516 is higher than the threshold P 515, the lower switching threshold is set to 0.10 %.

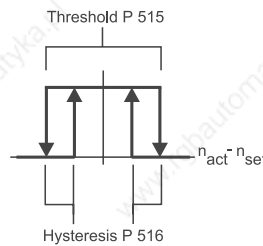

DLink 14 Unassigned comparator A < B

The bit adopts HIGH state if the difference between input 1 (=A) and input 2 (=B) becomes smaller than the threshold set with parameter P 678 minus the hysteresis specified with parameter P 679.

The bit adopts HIGH state as soon as $|A - B| < P 678 - P 679$ is reached.

The bit adopts LOW state if the difference between input 1 (=A) and input 2 (=B) becomes greater than the threshold set with parameter P 678.

The bit adopts LOW state as soon as $|A - B| > P 678$ is reached.

If the value entered in parameter Hysteresis P 679 is higher than the threshold P 678, the lower switching threshold is set to 0.10 %.

Caution: DLink 564 is inverted with regard to DLink 14 !

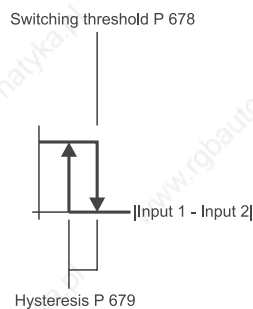

DLink 15 $I_A > I_{Ax1}$ signal

The following applies to the signal thresholds:

The bit adopts HIGH state as soon as the actual armature current exceeds the value set with parameter P 521, in other words $I_A > P 521$.

The bit adopts LOW state as soon as the actual armature current falls below the threshold set with parameter P 521 minus the hysteresis set in parameter P 522, in other words $I_A < P 521 - P 522$.

The inputs are in percent of the set **converter** output current (P 072).

The value set with parameter P 521 is influenced by the output of the speed-dependent current limit (ALink 69). This does not apply to the hysteresis specified with parameter P 522:

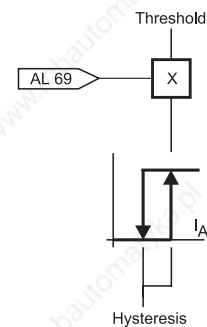
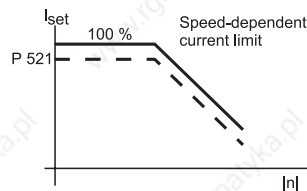

If the value entered in parameter Hysteresis P 522 is higher than the threshold P 521, the lower switching threshold is set to 0.10 %.

DLink 16 $I_A > I_{Ax2}$ signal

The following applies to the signal thresholds:

The bit adopts HIGH state as soon as the actual armature current exceeds the value set with parameter P 523, in other words $I_A > P 523$.

The bit adopts LOW state as soon as the actual armature current falls below the threshold set with parameter P 523 minus the hysteresis set in parameter P 524, in other words $I_A < P 523 - P 524$.

The inputs are in percent of the set **converter** output current (P 072).

The value set with parameter P 523 is influenced by the output of the speed-dependent current limit (ALink 69). This does not apply to the hysteresis specified with parameter P 524.

If the value entered in parameter Hysteresis P 524 is higher than the threshold P 523, the lower switching threshold is set to 0.10 %.

For a diagram on the switching thresholds see DLink 15.

DLink 17 Current limit reached signal (also LED H706)

The following applies to the signal thresholds:

The bit adopts HIGH state if the speed controller output limit is active **and** the actual armature current exceeds 95 % of the **current** limit value (active current limit).

The bit adopts LOW state as soon as the actual armature current falls below 89 % of the current limit value (active current limit), independent of whether the speed controller output limit is still active.

DLink 18 Speed controller output limit active (speed controller at 'limit')

The bit adopts HIGH state if the speed controller output limit is active.

The bit adopts LOW state if the speed controller output limit is not active.

DLink 19 Motor i^2t monitoring

The monitoring function is **active** if **P078 \neq 0min** was set, and inactive if P 078 = 0 min was specified. The bit is then always in LOW state.

P 078 \neq 0 min:

The bit adopts HIGH state as soon as the calculated i^2t value exceeds the threshold set with parameter P 525.

The bit adopts LOW state as soon as the calculated i^2t value falls below the threshold set with parameter P 525 minus the fixed-set 5 % hysteresis.

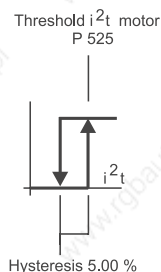

An i^2t value of 100 % is reached if the motor is continuously operated at the current set in parameter P 074 (= rated **motor** current).

Parameter P 031 displays the current i^2t value, 100 % correspond to the motor rated temperature.

NOTE:

For the installation of UL 508C-conform machines: the motor i^2t message must be evaluated by a master control, switching off the drive when the message is generated.

Time to trip of the i^2t monitoring function on the condition that the max. armature current is flowing:

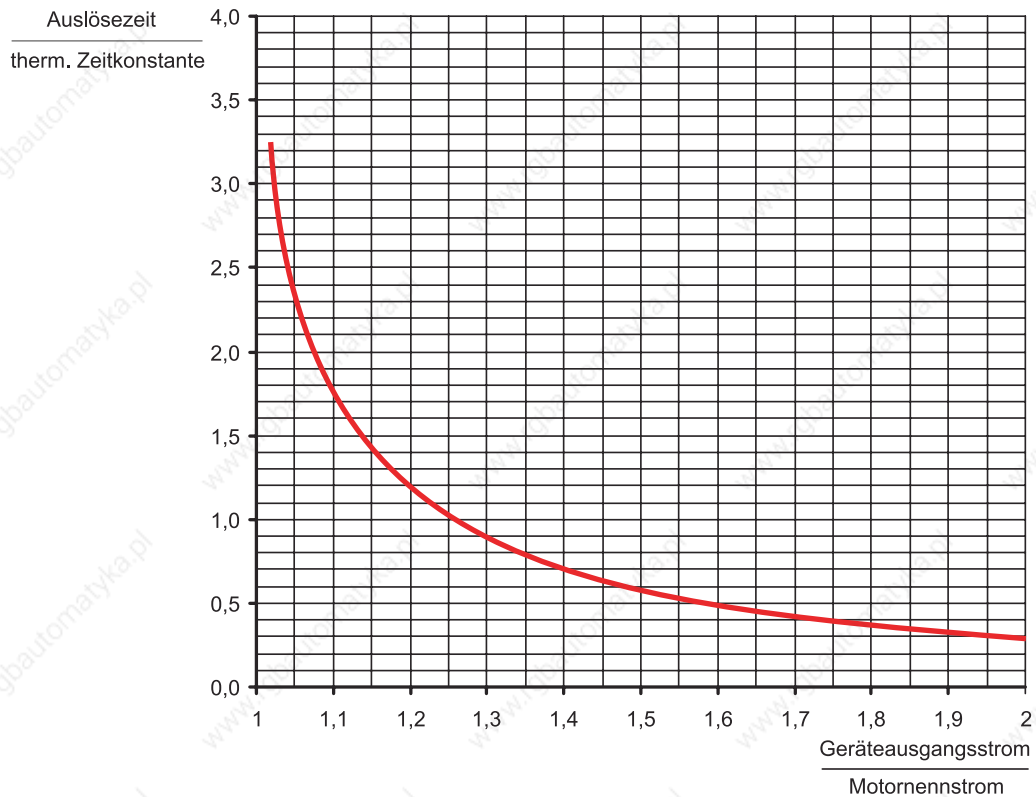

Illustration 76: Motor i^2t monitoring - Threshold to trip of is 100 %

$$t[\text{min}] = -P\ 078 \times \ln \left[1 - \frac{P\ 525}{100\ \%} \times \left(\frac{P\ 074}{P\ 072} \times \frac{100}{\text{current limit}} \right)^2 \right]$$

current limit: P 325 resp. P 326

The monitoring function is switched off internally while optimisation is active. The original state is re-established once optimisation has been completed.

DLink 20 Heat sink temperature limit monitoring

The value of the heat sink temperature limit is dependent on the power unit, available in ALink 221 and displayed in ° C.

The bit adopts HIGH state as soon as the heat sink temperature limit is exceeded.

The bit adopts LOW state as soon as the heat sink temperature drops below the temperature limit minus 3° C.

DLink 21 Actual field current < 50 % field current setpoint

The bit adopts HIGH state as soon as the actual field current drops below 50 % of the active field current setpoint.

The bit adopts LOW state as soon as the actual field current becomes >70 % of the active field current setpoint.

DLink 21 and DLink 424 assume HIGH state if the field unit is switched off with parameter P 372 !

DLink 22 State 'Ready to operate'

The converter is ready to switch on, i. e., it is at least in READY TO OPERATE state (2). The signal corresponds to bit 0 in the converter status word (P 100).

DLink 23 Drive disabled

The converter is in disabled state. The signal is inverted with regard to DLink 2.

5.38 List of digital input functions DIF

5.38 List of digital input functions DIF

DIF no.	Operation	Control word Bit no.	Description
0			Digital input switched off, DLink active
1			1: Load data record 1
2			1: Load data record 2
3			1: Load data record 3
4			1: Load data record 4
5			1: Load data record 5
6			1: Load data record 6
7	OR	P 101 Bit 7	1: Acknowledge error
8	OR	P 181 Bit 0	1: Negate analog input 1
9	AND	P 181 Bit 1	1: Enable analog input 1
10	OR	P 181 Bit 2	1: Negate analog input 2
11	AND	P 181 Bit 3	1: Enable analog input 2
12	OR	P 181 Bit 4	1: Negate analog input 3
13	AND	P 181 Bit 5	1: Enable analog input 3
14	OR	P 181 Bit 6	1: Negate analog input 4
15	AND	P 181 Bit 7	1: Enable analog input 4
16	OR	P 221 Bit 0	0: Ramp generator A parameter set 1 active 1: Ramp generator A parameter set 2 active
17	AND	P 221 Bit 6	1: Enable ramp generator A input (setpoint)
18	OR	P 221 Bit 5	1: Stop ramp generator A
19	AND	P 221 Bit 4	1: Enable ramp generator A output
20	OR	P 211 Bit 0	1: Motor potentiometer up (+)
21	OR	P 211 Bit 1	1: Motor potentiometer down (-)
22	AND	P 301 Bit 0	1: Enable speed controller setpoint (after addition)
23	OR	P 601 Bit 0	Unassigned change-over switch 1
24	OR	P 601 Bit 1	Unassigned change-over switch 2
25	OR	P 601 Bit 2	Unassigned change-over switch 3
26	AND	P 601 Bit 3	Unassigned change-over switch 4
27	AND	P 561 Bit 0	1: Unassigned controller : Enable setpoint (after addition)
28	AND	P 561 Bit 1	1: Unassigned controller : Enable controller
29	AND	P 561 Bit 2	1: Unassigned controller : Enable I-component
30	OR		Multiplier 1
31	OR		Multiplier 2
32	AND	P 221 Bit 7	1: Enable ramp generator B input (setpoint)
33	AND	P 221 Bit 8	1: Enable ramp generator B output

5.38.1 Description of digital input functions DIF

DIF 0 Input switched off

Associated switching input not active. The associated DLinks DL 456 to DL 463 are set/reset dependent on the signal level at the terminal, however.

HIGH level at the terminal:: DLink is '1'.
 LOW level at the terminal: DLink is '0'.

DIF 1 Load data record 1 (Observe parameter P 152)

The system switches to data record 1 if this terminal is energised at +24 V. If several inputs are programmed for the function Data record change, only one input must be connected to +24 V. If more than one input is on +24 V, this leads to error message 50 after approx. 500 ms, to setting of bit no. 0 in parameter P 924, and the ready-to-operate relay drops out. The drive is disabled internally and **starts to coast**. The original data record remains the active data record.

If the voltage is switched off the terminal after a data record change, the data record last selected remains active until a new data record is loaded via a different input.

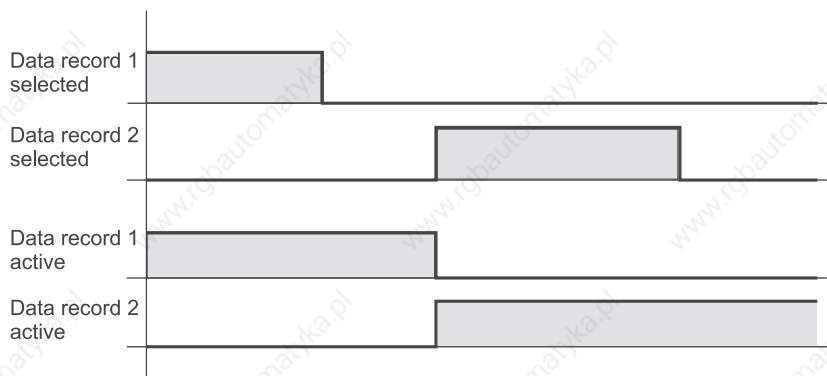

WARNING

The control must not write parameter P 152 if the converter has a bus link and if at least one switching input is programmed for data record change. In that case, not even data record selection via parameters P 157 and P 158 is permissible (data record selection integrity !). Writing one of the specified parameters regardless leads to error message 57, bit no. 6 is set in parameter P 913, and the ready-to-operate relay drops out. The drive is disabled internally and **starts to coast**.

Changing to a non-existent data record leads to error message 68, bit no.1 is set in parameter P 924, and the ready-to-operate relay drops out. The drive is disabled internally and **starts to coast**.



WARNING

This affects all parameters stored in the data records, including parameters that can only be set while the **drive is disabled - offline** setting. Parameters stored in the data records are identified '**DR**' in the column Memory location in the parameter list. The parameter description includes the note '**Save: Data record**'.

The system doesn't check the correctness of the values. Therefore it is vital to take care when editing the values - you have to ensure that a parameter set change entails no unintentional or dangerous statuses at the machine.

Parameter P 154 = 1 allows data record changes only while the drive is disabled.

-
- DIF 2** **Load data record 2** (Observe parameter P 152)
See DIF 1
- DIF 3** **Load data record 3** (Observe parameter P 152)
See DIF 1
- DIF 4** **Load data record 4** (Observe parameter P 152)
See DIF 1
- DIF 5** **Load data record 5** (Observe parameter P 152)
See DIF 1
- DIF 6** **Load data record 6** (Observe parameter P 152)
See DIF 1
- DIF 7** **Acknowledge error**
Edge-triggered ! A positive (LOW - HIGH) edge deletes any acknowledgeable errors present (see description of errors), and the ready-to-operate relay picks up again. A positive edge at the enable contact 'Main contactor ON' is required to enable the drive.
- DIF 8** **Negate analog input 1** (see ► [Illustration 35](#) ◀ on page 102)
A HIGH signal at the terminal inverts the digitized value (polarity reversal).
A LOW signal at the terminal does not affect the digitized value.
- DIF 9** **Set analog input 1 to zero** (see ► [Illustration 35](#) ◀ on page 102)
A HIGH signal at the terminal transfers the digitized value into ALink 26.
A LOW signal at the terminal does not transfer the digitized value into ALink 26, and a value '0' is written into ALink 26 independent of the input signal present.

- DIF 10 Negate analog input 2** (see ► [Illustration 35](#)◄ on page 102)
A HIGH signal at the terminal inverts the digitized value (polarity reversal).
A LOW signal at the terminal does not affect the digitized value.
- DIF 11 Set analog input 2 to zero** (see ► [Illustration 35](#)◄ on page 102)
A HIGH signal at the terminal transfers the digitized value into ALink 28.
A LOW signal at the terminal does not transfer the digitized value into ALink 28, and a value '0' is written into ALink 28 independent of the input signal present.
- DIF 12 Negate analog input 3** (see ► [Illustration 36](#)◄ on page 103)
A HIGH signal at the terminal inverts the digitized value (polarity reversal).
A LOW signal at the terminal does not affect the digitized value.
- DIF 13 Set analog input 3 to zero** (see ► [Illustration 36](#)◄ on page 103)
A HIGH signal at the terminal transfers the digitized value into ALink 30.
A LOW signal at the terminal does not transfer the digitized value into ALink 30, and a value '0' is written into ALink 30 independent of the input signal present.
- DIF 14 Negate analog input 4** (see ► [Illustration 36](#)◄ on page 103)
A HIGH signal at the terminal inverts the digitized value (polarity reversal).
A LOW signal at the terminal does not affect the digitized value.
- DIF 15 Set analog input 4 to zero** (see ► [Illustration 36](#)◄ on page 103)
A HIGH signal at the terminal transfers the digitized value into ALink 32.
A LOW signal at the terminal does not transfer the digitized value into ALink 32, and a value '0' is written into ALink 32 independent of the input signal present.
- DIF 16 Ramp generator A parameter set** (see ► [Illustration 39](#)◄ on page 106)
A HIGH signal at the terminal indicates that parameter set 2 (P 232 to P 237) is active at ramp generator A.
A LOW signal at the terminal indicates that parameter set 1 (P 226 to P 231) is active at ramp generator A.
- DIF 17 Ramp generator A setpoint zero** (see ► [Illustration 39](#)◄ on page 106)
A HIGH signal at the terminal passes the total setpoint (ALink 42) to the input of ramp generator A (ALink 43).
A LOW signal at the terminal does not pass the total setpoint (ALink 42) to the input of ramp generator A (ALink 43). A setpoint '0' is input at the ramp generator input; this value is also entered in ALink 43. The ramp generator output (ALink 44) follows the set ramp to 0 value.

- DIF 18 Stop ramp generator A** (see ► [Illustration 39](#)◄ on page 106)
- A HIGH signal at the terminal interrupts the ramp-up and/or ramp-down process. The ramp generator output remains at its momentary level until the signal at the terminal is deactivated.
- A LOW signal at the terminal does not affect the ramp generator. The ramp generator output changes at a setpoint change with the set ramp-up and/or ramp-down time.
- DIF 19 Ramp generator A output zero** (deactivate quick ramp-down) (see ► [Illustration 39](#)◄ on page 106)
- A HIGH signal at the terminal enables the ramp generator. The output follows the setpoint at the input with the set ramp-up and/or ramp-down time.
- A LOW signal at the terminal sets the ramp generator output immediately to '0' without any delay (quick ramp-down). Any changes to the setpoint at the ramp generator input will then have no influence on its output. If the speed controller is supplied only one setpoint, and if this comes from ramp generator A, the drive is decelerated at the current limit to zero speed in this case. The controller will not be disabled ! The drive is still enabled !
- As soon as a HIGH signal is switched to the terminal, the ramp generator will ramp up to the applied setpoint along the set ramp.
- DIF 20 MP up** (see ► [Illustration 38](#)◄ on page 105)
- A HIGH signal at the terminal increases the motor potentiometer output (ALink 40) in the direction of positive values at the set ramp-up time (P 212). As soon as the output reaches the limit set with parameter P 213, the motor potentiometer output will not be further increased despite the HIGH signal.
- A LOW signal at the terminal does not affect the motorised potentiometer output.
- Simultaneous input of 'MP up' and 'MP down' (see DIF 21) does not change the motor potentiometer output !
- DIF 21 MP down** (see ► [Illustration 38](#)◄ on page 105)
- A HIGH signal at the terminal decreases the motor potentiometer output (ALink 40) in the direction of negative values at the set ramp-down time (P 214). As soon as the output reaches the limit set with parameter P 215, the motor potentiometer output will not be further decreased despite the HIGH signal.
- A LOW signal at the terminal does not affect the motor potentiometer output.
- Simultaneous input of 'MP up' (see DIF 20) and 'MP down' does not change the motor potentiometer output !
- DIF 22 Enable speed controller setpoint** (see ► [Illustration 43](#)◄ on page 110)
- A HIGH signal at the terminal passes the total setpoint (ALink 50) to the input of the speed controller (ALink 51).
- A LOW signal at the terminal does not pass the total setpoint (ALink 50) to the input of the speed controller (ALink 51). A setpoint '0' is input at the speed controller; and this value is also entered in ALink 51. Although the drive returns to zero speed at the current limit, the controller is not disabled ! The drive is still enabled !

- DIF 23** **Unassigned changeover switch 1** (► [Illustration 57](#)◄ on page 124)
A HIGH signal at the terminal transfers the ALink set with parameter P 667 into ALink 195.
A LOW signal at the terminal transfers the ALink set with parameter P 666 into ALink 195.
- DIF 24** **Unassigned changeover switch 2** (► [Illustration 57](#)◄ on page 124)
A HIGH signal at the terminal transfers the total of the ALinks set with parameters P 669 and P 670 into ALink 196. The total is limited to the value set with P 111.
A LOW signal at the terminal transfers the ALink set with parameter P 668 into ALink 196.
- DIF 25** **Unassigned changeover switch 3** (► [Illustration 57](#)◄ on page 124)
A HIGH signal at the terminal transfers the ALink set with parameter P 672 into ALink 197. Before entry into ALink 197, the selected value is multiplied with the value set in P 673 and then limited to the value set with P 111.
A LOW signal at the terminal transfers the ALink set with parameter P 671 into ALink 197.
- DIF 26** **Unassigned changeover switch 4** (► [Illustration 57](#)◄ on page 124)
A HIGH signal at the terminal transfers the ALink set with parameter P 674 into ALink 198.
A LOW signal at the terminal scales the ALink set with parameter P 674 and then transfers it into ALink 197. The scaling factor is defined with parameter P 675 and ranges from 0.000 to 1.000.
- DIF 27** **Unassigned controller: Enable setpoint** (see ► [Illustration 52](#)◄ on page 119)
A HIGH signal at the terminal passes the total setpoint (ALink 105) to the input of the unassigned PI controller (ALink 106).
A LOW signal at the terminal does not pass the total setpoint (ALink 105) to the input of the unassigned PI controller (ALink 106). A setpoint '0' is input at the unassigned PI controller; and this value is also entered in ALink 106.
- DIF 28** **Unassigned controller: Enable controller** (see ► [Illustration 52](#)◄ on page 119)

**NOTE**

This function is effective only if parameter **P 579 is set to 2** !

A HIGH signal at the terminal enables the PI controller.

A LOW signal at the terminal disables the PI controller. Its output signal has a value 0 even if a value other than 0 was entered in parameter P 574 (Preset I component) ! The preset value is transferred into the I component when the controller is enabled. While the controller is disabled, the value of parameter P 574 is transferred into the current I component and is available in ALink 116.

5.38 List of digital input functions DIF

DIF 29 Unassigned controller: Enable I component (see ▶Illustration 52◀ on page 119)

A HIGH signal at the terminal enables the I component of the PI controller.

A LOW signal at the terminal disables the I component of the PI controller. The controller operates as a P controller.

DIF 30 Multiplier 1

This module has one input and four outputs. The input signal can be taken from any of the 8 programmable digital inputs. Each of the four outputs is assigned a DIF function, so that one switching input can trigger up to four different events. One output of multiplier 1 can also be connected to the input of multiplier 2 to enable one input to execute up to seven actions.

DIF 31 Multiplier 2

This module has one input and four outputs. The input signal can be taken from any of the 8 programmable digital inputs. Each of the four outputs is assigned a DIF function, so that one switching input can trigger up to four different events. The input of multiplier 2 can also be controlled by multiplier 1 (see DIF 28).



NOTE

The input of multiplier 1 must **not** be connected to the output of multiplier 2 as this would render **multiplier 1 ineffective!**

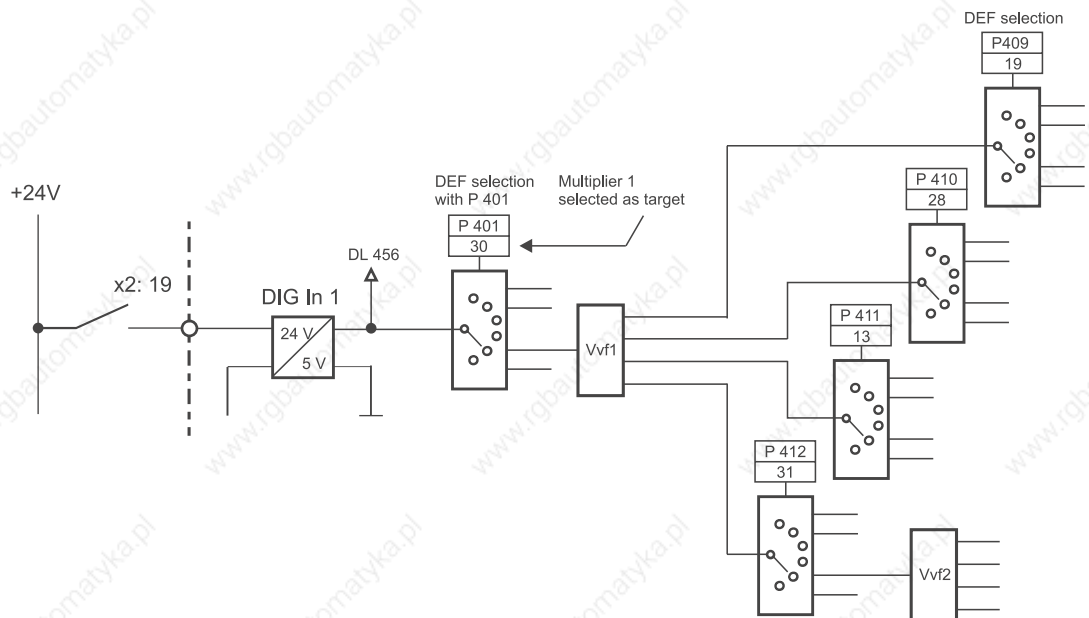

Illustration 77: Multiplier interconnection example

DIF 32 Enable ramp generator B input (setpoint) (see [▶Illustration 40◀](#) on page 107)

A HIGH signal at the terminal passes the setpoint selected with parameter P 245 to the input of ramp generator B (ALink 46).

A LOW signal at the terminal does not pass the setpoint selected with parameter P 245 to the input of ramp generator B (ALink 46). A setpoint '0' is input at the ramp generator input; this value is also entered in ALink 46. The ramp generator output (ALink 47) follows the set ramp to 0 value.

DIF 33 Disable ramp generator B output (deactivate quick ramp-down)
(see [▶Illustration 40◀](#) on page 107)

A HIGH signal at the terminal enables the ramp generator. The output follows the setpoint at the input with the set ramp-up and/or ramp-down time.

A LOW signal at the terminal sets the ramp generator output immediately to '0' without any delay (quick ramp-down). Any changes to the setpoint at the ramp generator input will then have no influence on its output. If the speed controller is supplied only one setpoint, and if this comes from ramp generator B, the drive is decelerated at the current limit to zero speed in this case. The controller will not be disabled ! The drive is still enabled !

As soon as a HIGH signal is switched to the terminal, the ramp generator will ramp up to the applied setpoint along the set ramp.

5.38 List of digital input functions DIF

ERRORS AND WARNINGS

6.1 Error display at seven-segment display

The red LED H700 will be illuminated as soon as there is at least one error/one warning. The seven-segment display is switched on automatically, and the numbers of all existing errors are displayed one after the other. The display changes between parameter number P 037 and error numbers at intervals of about a second. The Mode key (Ⓢ) is ineffective with this parameter !

The display shows the parameter number first and then the number of the next error present and loops back to the first error number after displaying the last.

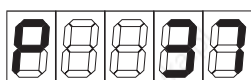

Parameter P 037, Error number

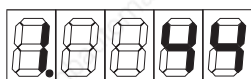

Displays the first error detected, identified by a preceding 1.

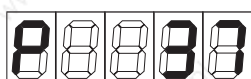

Error display parameter

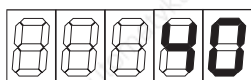

Displays the second detected error

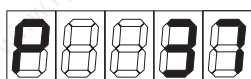

Error display parameter

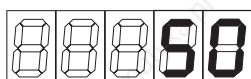

Displays the third detected error

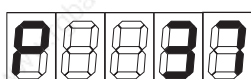

Error display parameter

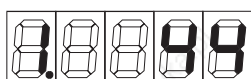

The history buffer was read out completely once. The display loops back to the beginning, displaying the first detected error identified with the preceding 1.

6.2 BKF7000 error list (P 037)

6.2 BKF7000 error list (P 037)

Error messages differ between acknowledgeable and non-acknowledgeable errors, the latter requiring a converter restart. Acknowledgeable errors may be acknowledged via digital input functions or via the control word (P101).

Non-acknowledgeable errors can be acknowledged from software release S03.10. In this case, the converter executes a reset when errors are acknowledged via digital input functions or control word. This characteristic can be set in parameter P106. See also description P106.

Error no.	Error description	DLink
1	BASS communication time monitoring	688
2	USS communication time monitoring	689
3	Cyclic data time monitoring	690
4	Demand data time monitoring	691
5	Incompatible software	960
6	Invalid boot source entry	961
7	Program branching error	703
8	Drive blocked	705
9	Incremental encoder 1, scaling error	720
10	EEPROM-to-RAM copy error	736
11	Damaged boot data record header	737
12	Boot data record checksum error	738
13	Damaged primary data header	739
14	EEPROM too small	740
15	Error on data record save	741
16	Ambiguous converter type BKD/BKF (1-Q/4-Q)	752
17	Error ext. analog - digital converter	753
18	Unknown field power unit identifier	754
19	Field connection error (AC)	755
20	Armature power unit connection error (AC)	756
21	CCW rotating field at armature power unit	757
22	Phase failure at armature power unit	758
23	Microprocessor error 1	768
24	Microprocessor error 2	769
25	Microprocessor error 3	770
26	Microprocessor error 4	771
27	Microprocessor error 5	772
28	Microprocessor error 6	773
29	Microprocessor error 7	774
30	External watchdog tripped	775

Bold: Errors are only acknowledgeable when P 106 = 2, the converter executes then an internal reset.

Error no.	Error description	DLink
31	Internal watchdog tripped	776
32	RAM test error	777
33	Parameter conflict (P 071 / P 073)	784
34	Repeated negative actual armature current	785
35	No synchronisation	800
36	Firing pulse interval differs from specified value	801
37	Armature circuit open ($\alpha = \alpha_G$ and $I_A < 10$ % of setpoint)	946
38	Mains frequency < 45 Hz	803
39	Mains frequency > 65 Hz	804
40	Field current monitoring (actual field current < 50 % field current setpoint)	816
41	P 072 out of range	945
42	P 213 / P 215 parameter conflict	832
43	Shortcircuit/overload at a digital output	848
44	Overspeed ($n > P 501$)	864
45	Tachogenerator/encoder failure or armature circuit open (time to trip 12 scan cycles / 40 ms at 50 Hz)	865
46	Tachogenerator/encoder polarity reversed (time to trip 12 scan cycles / 40 ms at 50 Hz)	866
47	Speed range error (P 257)	867
48	Torque change time exceeded (> 100 scans)	880
49	Unknown armature power unit identification (current)	896
50	Data record selection error (digital input functions 1-6)	912
51	Input current < 3.3 mA at 4 mA to 20 mA	928
52	Mains undervoltage P 010 < 0.8 x P 070	786
53	Overcurrent TD1 ($I_A > 2x P 072$)	787
54	Overcurrent TD2 ($I_A > 2x P 072$)	788
55	Zero-current detector defective	805
56	Offset error armature current detector > 50 mV	944
57	Ambiguous data record change source	742
58	EEPROM empty	743
59	Parameter error in data record 1 (write error/value)	744
60	Parameter error in data record 2 (write error/value)	745
61	Parameter error in data record 3 (write error/value)	746
62	Parameter error in data record 4 (write error/value)	747
63	Parameter error in data record 5 (write error/value)	748
64	Parameter error in data record 6 (write error/value)	749
65	Error in ROM data record (no. 7)	750
66	Primary data parameter error	751
67	Armature power unit identification differs from EEPROM value	897
68	Data record change: Data record does not exist	913

Bold: Errors are only acknowledgeable when P 106 = 2, the converter executes then an internal reset.

6.2 BKF7000 error list (P 037)

Error no.	Error description	DLink
69	Field power unit differs from EEPROM value	817
70	Option board does not respond	778
71	Illegal value in P 072 / P 074 in data record 1	962
72	Illegal value in P 072 / P 074 in data record 2	963
73	Illegal value in P 072 / P 074 in data record 3	964
74	Illegal value in P 072 / P 074 in data record 4	965
75	Illegal value in P 072 / P 074 in data record 5	966
76	Illegal value in P 072 / P 074 in data record 6	967
77	Illegal value in P 079 in data record 1	968
78	Illegal value in P 079 in data record 2	969
79	Illegal value in P 079 in data record 3	970
80	Illegal value in P 079 in data record 4	971
81	Illegal value in P 079 in data record 5	972
82	Illegal value in P 079 in data record 6	973
83	EEPROM write time exceeded	975
84	Primary data checksum error	976
85	Checksum error in data record 1	977
86	Checksum error in data record 2	978
87	Checksum error in data record 3	979
88	Checksum error in data record 4	980
89	Checksum error in data record 5	981
90	Checksum error in data record 6	982
91	Undefined field bus card status	696
92	Field bus error	697
93	Field bus setpoint/actual value configuration error	698
94	P 657 / P 658 parameter conflict	992
96	Motor reached switch off temperature channel 1 (motor temperature \geq P543)	1024
97	Motor reached switch off temperature channel 1 (motor temperature \geq P546)	1025
98	Disconnection of motor temperature sensor channel 1 (X8:1 and X8:2 board 3.0043)	1026
99	Disconnection of motor temperature sensor channel 2 (X8:4 and X8:5 board 3.0043)	1027
100	Short circuit of motor temperature sensor channel 1 (X8:1 and X8:2 board 3.0043)	1028
101	Short circuit of motor temperature sensor channel 2 (X8:4 and X8:5 board 3.0043)	1029
102	Cable break temperature sensor power unit	898
103	Short circuit temperature sensor power unit	899
104	Power unit limit temperature exceeded (P112 = 1)	900
105	Error reaction freely definable error (P730 \neq 0)	993

Bold: Errors are only acknowledgeable when P 106 = 2,
the converter executes then an internal reset.

6.3 BKF7000 (P 039) Warning list

Warning no.	Warning description	DLink
1	P 261 / P 262 parameter conflict: Incremental encoder 1 maximum frequency exceeded	656
2	Data record save not completed	657
3	Power unit temperature exceeded	658/54
4	Data record not erased	659
5	P 072 / P 074 parameter conflict: Current limits not reached/exceeded	660
6	Intermittent-current limit cannot be defined (optimisation)	661
7	Data record change not possible	662
8	Motor i ² t tripped	663
9	Cannot erase boot data record	664
10	Cannot reset	665
11	Motor warning temperatur channel 1 reached (motor temperature \geq P542)	666
12	Motor warning temperatur channel 2 reached (motor temperature \geq P545)	667
13	Pre-warning limit temperature power unit	668/53

6.4 Error description

Error messages differ between acknowledgeable and non-acknowledgeable errors, the latter requiring a converter restart. Acknowledgeable errors may be acknowledged via digital input functions or via the control word (P101).

Non-acknowledgeable errors can be acknowledged from software release S03.10. In this case, the converter executes a reset when errors are acknowledged via digital input functions and/or control word. This characteristic can be set in parameter P106. Also refer description P106.

- | | | |
|------------|--|---|
| F 1 | BASS communication time monitoring | Error acknowledgeable |
| | There was no communication during the period set with parameter P 123. | |
| | Drive starts to coast | ready-to-operate relay drops out |
|
 | | |
| F 2 | USS communication time monitoring | Error acknowledgeable |
| | There was no communication during the period set with parameter P 123. | |
| | Drive starts to coast | ready-to-operate relay drops out |
|
 | | |
| F 3 | Cyclic communication time monitoring | Error acknowledgeable |
| | There was no communication during the period set with parameter P 123. | |
| | Drive starts to coast | ready-to-operate relay drops out |
|
 | | |
| F 4 | Demand data time monitoring | Error acknowledgeable |
| | There was no communication during the period set with parameter P 123. | |
| | Drive starts to coast | ready-to-operate relay drops out |
|
 | | |
| F 5 | Incompatible software | Error not acknowledgeable |
| | The data stored in the EEPROM come from a software group which differ from the controller software. | |
| | This error message may occur after a software change, for example when the original software 07.xx is replaced by software 08.xx . In this case, the data stored in the EEPROM are no longer accessible. | |
| | This error may occur also, when the EEPROM is not total erased (e.g. the electronic supply is switched off during erasing procedure) or after erasure of the EEPROM and premature switching off of the electronic supply. After repeated erasure of the EEPROM (P 157) only errors F 6 and F 58 should remain. | |
| | Read out and print the data records via a PC before changing software. The EEPROM then needs to be completely erased. This requires the following inputs: | |
| | P 157 = | 0 |
| | P 157 = | 8 |
| | P 157 = | 25 |
| | P 157 = | 0 |
| | P 157 = | 1 |

Then wait until the lowest-value position becomes '3', '7' or 'B' (P 150 = xxx3 , P 150 = xxx7 or P 150 = xxxB) in parameter P 150.

The erase takes approx. $55 \text{ s} + n \times 20 \text{ s}$, with n representing the number of programmed data records.

Enter the data records based on the printout, and save.

Drive continues to coast

ready-to-operate relay remains dropped out

F 6 Invalid boot source entry

Error not acknowledgeable

Parameter P 151 contains a value outside the permissible range from 1 to 6, or the specified data record does not exist. A value has not yet been entered here if parameter P 151 = 0.

Drive continues to coast

ready-to-operate relay remains dropped out

F 7 Program branching error

Error not acknowledgeable

Drive starts to coast

ready-to-operate relay drops out

F 8 Drive blocked

Error acknowledgeable

The stall protection is **OFF** if parameter **P 517 = 0.0 s**, and **ON** if parameter **P 517 \neq 0.0 s**.

The protection trips if the signal 'Current limit reached' is present continuously for the time set with parameter P 517 (LED H706 ON, refer DLink 17) and the speed is continuously lower than the threshold set with parameter P 505, minus the hysteresis set with P 506.

Drive starts to coast

ready-to-operate relay drops out

F 9 Incremental encoder 1, scaling error

Error not acknowledgeable

The scaling constant for actual value calculation was negative. Program not executed properly.

Drive starts to coast

ready-to-operate relay drops out

F 10 EEPROM-to-RAM copy error

Error not acknowledgeable

The programmed data records are copied from the EEPROM into the RAM after the electronics supply has been applied. Afterwards, the RAM data are compared to the EEPROM data. This compare has produced an error.

EEPROM defective. Program not executed properly.

Drive continues to coast

ready-to-operate relay remains dropped out

F 11 Damaged boot data record header

Error not acknowledgeable

The programmed data records are copied into the RAM after the electronics supply has been applied. The process detected a faulty header entry in the boot data record.

EEPROM defective.

Program not executed properly.

Hardware defect

Drive starts to coast

ready-to-operate relay drops out

- F 12 Boot data record checksum error** Error not acknowledgeable
- The programmed data records are copied into the RAM after the electronics supply has been applied. The checksum for the boot record differs from the one stored with the data record.
- EEPROM defective
- Drive continues to coast** **ready-to-operate relay drops out**
- F 13 Damaged primary data header** Error not acknowledgeable
- The programmed data records and the primary data (data stored outside a data record) are copied into the RAM after the electronics supply has been applied. The process detected a faulty header entry for the primary data.
- EEPROM defective
- Drive continues to coast** **ready-to-operate relay remains dropped out**
- F 14 EEPROM too small** Error not acknowledgeable
- The EEPROM is too small for the data quantity to be stored (primary data or data record areas). Can occur only during a software update. Use new memory module with larger EEPROM.
- Drive starts to coast** **ready-to-operate relay drops out**
- F 15 Error on data record save** Error not acknowledgeable
- A verify error occurred during the programming of a data record. The EEPROM did not store the piece of data within the specified period of time. The data record will be identified as not programmed.
- EEPROM defective
- Drive starts to coast** **ready-to-operate relay drops out**
- F 16 Ambiguous converter type BKD/BKF (1-Q/4-Q)** Error not acknowledgeable
- There are two converter type identifiers, BKD (single-quadrant converter) or BKF (four-quadrant converter). The error message is displayed if the identifiers do not match. The check is performed during the boot process after the electronics supply has been applied. The parameter P 002 displays the analog identifier, but is not clear. The read value of the analog identifier is shown in AL 279.
- Compare switch position S500/8 on board 3.9712 with type code BKF/BKD (see [▶Setting the power unit identification](#) from page 42).
- Missing connection cable (X102) between control unit and power unit of converter sizes III and VI (750 A up to 2050 A).
- Drive continues to coast** **ready-to-operate relay remains dropped out**
- F 17 Error ext. analog - digital converter** Error acknowledgeable
- At the analog - digital converter there is no status signal to indicate that the initiated conversion was completed within the specified period of time. The error message is displayed if the signal is missing for three successive conversions.
- Drive starts to coast** **ready-to-operate relay drops out**

- F 18 Unknown field power unit identifier** Error not acknowledgeable
- The field power unit identifier is read in after the electronics supply has been applied. The identifier could not be assigned to any known power unit (rated current).
- Drive continues to coast** **ready-to-operate relay remains dropped out**
- F 19 Field connection error** Error not acknowledgeable
- The field power unit supply is checked after +24 V have been applied to switching input x2: 15, 'Main contactor ON'. The error message is displayed if there is no connection or in the case of a phase angle.
- Disconnect the converter and connect the field power unit as per connection diagram. Since the reference signal is generated from the electronics supply, check this connection as well in accordance with the connection diagram.
- Drive continues to coast** **ready-to-operate relay drops out**
- F 20 Armature power unit connection error (AC)** Error not acknowledgeable
- The armature power unit supply is checked after +24 V have been applied to switching input x2: 15, 'Main contactor ON'. The error message is displayed if there is no connection or in the case of a phase angle.
- Disconnect the converter and connect the armature power unit as per connection diagram. Since the reference signal is generated from the electronics supply, check this connection as well in accordance with the connection diagram.
- Drive continues to coast** **ready-to-operate relay drops out**
- F 21 CCW rotating field at armature power unit** Error not acknowledgeable
- The armature power unit supply is checked after +24 V have been applied to switching input x2: 15, 'Main contactor ON'. The process revealed a CCW rotating field.
- Disconnect the converter and connect the armature power unit as per connection diagram.
- Drive continues to coast** **ready-to-operate relay drops out**
- F 22 Phase failure at armature power unit** Error acknowledgeable
- The armature power unit supply is checked continuously for phase failure after +24 V have been applied to switching input x2: 15, 'Main contactor ON'. The time to trip for this error message is 6 controller cycles (20 ms at a 50 Hz mains frequency).
- Drive starts to coast** **ready-to-operate relay drops out**
- F 23 Microprocessor error 1** Error not acknowledgeable
- Illegal bus access. Hardware defective.
- Drive starts to coast** **ready-to-operate relay drops out**

6.4 Error description

F 24	Microprocessor error 2 Illegal bus access. Program not executed properly. Drive starts to coast	Error not acknowledgeable ready-to-operate relay drops out
F 25	Microprocessor error 3 Illegal bus access. Program not executed properly. Drive starts to coast	Error not acknowledgeable ready-to-operate relay drops out
F 26	Microprocessor error 4 Hardware defective or improper program execution. Drive starts to coast	Error not acknowledgeable ready-to-operate relay drops out
F 27	Microprocessor error 5 Hardware defective or improper program execution. Drive starts to coast	Error not acknowledgeable ready-to-operate relay drops out
F 28	Microprocessor error 6 Improper program execution. Drive starts to coast	Error not acknowledgeable ready-to-operate relay drops out
F 29	Microprocessor error 7 Improper program execution. Drive starts to coast	Error not acknowledgeable ready-to-operate relay drops out
F 30	External watchdog tripped Improper program execution. The external watchdog (monoflop) was not reset during the last 20 ms and thus the controller program was not processed properly. Drive starts to coast	Error not acknowledgeable ready-to-operate relay drops out
F 31	Internal watchdog tripped Improper program execution. The internal watchdog was not reset during the last 40 ms and thus the controller program was not processed properly. Drive starts to coast	Error not acknowledgeable ready-to-operate relay drops out

- F 32 RAM test error** Error not acknowledgeable
- The RAM test is performed during the boot process after the supply voltage has been applied and covers all RAM cells. For this purpose, these are written with different patterns which are then read back. Any discrepancies between written and read values trip the error message.
- Exchange memory module
- Drive continues to coast** **ready-to-operate relay remains dropped out**
- F 33 Parameter conflict (P071 / P073)** Error acknowledgeable
- The values entered in parameters P 071, 'Power unit supply (mains voltage)', and P 073, 'Motor armature voltage' indicate that the range has been exceeded.
- The error message is tripped when the drive is enabled.
- Single-quadrant (BKD) converters trigger the error message if the value in parameter P 073 is larger than 121% (140% from S 03.15) of parameter P 071.
- $$U_{\text{armature}} > 1.21 \times U_{\text{power unit}} \quad U_{\text{armature}} > 1,40 \times U_{\text{power unit}} \text{ (from S 03.15)}$$
- Four-quadrant (BKF) converters trigger the error message if the value in parameter P 073 is larger than 1.05 × value (1,15 x value from S 03.15) of parameter P 071.
- $$U_{\text{armature}} > 1.05 \times U_{\text{power unit}} \quad U_{\text{armature}} > 1,15 \times U_{\text{power unit}} \text{ (from S 03.15)}$$
- Check parameter settings in all programmed data records and correct when necessary, save.
- Drive continues to coast** **ready-to-operate relay drops out**
- F 34 Repeated negative actual armature current** Error acknowledgeable
- This error message is triggered by eight successive controller cycles measuring an actual armature current of less than -2 %.
- Hardware defective.
- Drive starts to coast** **ready-to-operate relay drops out**
- F 35 No synchronisation** Error not acknowledgeable
- The control unit is no longer synchronised.
- There may be a loose contact in the electronics supply (check screw cap fit for screw-in fuses), or the hardware is defective.
- Time to trip 6 mains periods plus the time set with parameter P 527.
- Drive starts to coast** **ready-to-operate relay drops out**
- F 36 Firing pulse interval differs from specified value** Error not acknowledgeable
- The firing pulse interval specified by the control unit and the measured pulse interval differ from each other by more than 320 µs. Time to trip 30 controller cycles.
- Hardware defective.
- Drive starts to coast** **ready-to-operate relay drops out**

- F 37 Armature circuit open** Error acknowledgeable
- This error message is displayed if the control unit input is at the rectifier firing angle limit (P 360) for the time set with parameter P 519, and if during this time the actual armature current is smaller 10 % than the specified armature current setpoint.
- Armature circuit fuse defective.
- Armature circuit connection faulty (loose/no terminal connection).
- Check the setting of the parameter for the rectifier firing angle limit P 360.
- Check for mains undervoltage.
- Check speed setting.
- Check field current setting.
- Check field weakening/constant field setting (P 255).
- Drive starts to coast** **ready-to-operate relay drops out**
-
- F 38 Mains frequency < 45 Hz** Error not acknowledgeable
- Drive starts to coast** **ready-to-operate relay drops out**
-
- F 39 Mains frequency > 65 Hz** Error not acknowledgeable
- Drive starts to coast** **ready-to-operate relay drops out**
-
- F 40 Field current monitoring** Error acknowledgeable
- This error message is displayed once the actual field current falls by more than 50 % below the field current setpoint for the time set in parameter P 385. This error can be acknowledged only when the actual field current exceeds 70 % of the field current setpoint.
- The error will not be deleted automatically if the field unit is switched off with parameter 372 while the error message is present. It can be acknowledged, however. In this case, the system signals Ready-to-operate only when the error is acknowledged.
- Drive starts to coast** **ready-to-operate relay drops out**
-
- F 41 P072 out of range** Error acknowledgeable
- The value in parameter P 072 must only adopt values within the range of $0.5 \times P 003$ to $1.0 \times P 003$. Parameter P 003 contains the maximum output current [A] of the power unit. The program entered $0.5 \times$ the current displayed in parameter P 003 into parameter P 072.
- This error message may occur after the memory module was exchanged.
- Enter the correct value for parameter P 072 in the affected data records, and save.
- Drive continues to coast** **ready-to-operate relay remains dropped out**

F 42 Parameter conflict (P213 / P215)

Error acknowledgeable

The values entered in parameters P 213 'Upper limit (motor potentiometer)' and P 215 'Lower limit (motor potentiometer)' result in a range overlap. The value in parameter P 215 is larger than that in parameter P 213. Parameter P 213 must contain the larger of the two values.

The error message is tripped when the drive is enabled.

Correct parameter setting and save.

Drive continues to coast ready-to-operate relay drops out

F 43 Shortcircuit/overload at a digital output

Error acknowledgeable

Hardware monitoring of the digital outputs at terminals x2: 5 to x2: 10.

Jumper W600 not fitted.

Jumper W600 fitted to B-C with no external 24 V supply at terminal x2: 4. External supply voltage outside specified limits (too low). External supply polarity reversed. Outputs will stay switched off until the error is acknowledged.

Drive starts to coast

ready-to-operate relay drops out

F 44 Overspeed (n > P501)

Error acknowledgeable

The speed has exceeded the value set in parameter P 501.

During optimisation, the threshold is reduced internally to 20 %, so that optimisation is aborted as soon as this speed is exceeded (due to the field circuit remanence). Once optimisation is completed, the original monitoring threshold will be restored.

**NOTE**

This is no redundant safety system as an assumption is made as to the motor speed from the actual speed determined by the converter.

Monitoring requires an **error-free** tachogenerator or incremental encoder.

Operator safety guidelines must be observed !

Drive starts to coast

ready-to-operate relay drops out

F 45 Tachogenerator/encoder failure (time to trip 12 scan cycles/40 ms at 50 Hz)

Error acknowledgeable

Tachogenerator/encoder line failure or line shortcircuit or no tachogenerator/encoder connection No encoder supply or encoder without second track.

This error message may occur also when the armature circuit is interrupted !

Drive starts to coast

ready-to-operate relay drops out

6.4 Error description

- F 46 Tachogenerator/encoder polarity reversed** Error acknowledgeable
Swap armature, field or tachogenerator/encoder connection.
Drive starts to coast **ready-to-operate relay drops out**
- F 47 Speed range error** Error acknowledgeable
The tachogenerator was not connected to the terminal X3: x corresponding to the tachogenerator range selected in parameter P 257. The system only detects a connection error that would lead to higher-than-set speeds (P 258).
This monitoring function is effective also if a pulse encoder is used for speed detection if an excessive speed was input (rated speed, P 262).
Possible further causes:
Armature current monitoring defect
Excessive field current
Parameter P 081 $N_{\max}/N_{\text{rated}}$ set wrongly.
Tachogenerator/encoder link interrupted.
Drive starts to coast **ready-to-operate relay drops out**
- F 48 Torque change time exceeded (>100 scans)** Error acknowledgeable
A torque change takes longer than specified with parameter P 518.
The cause for this is often that, in a weak mains, the armature current cannot be commutated within the set period of time. There may also be a hardware defect in the zero-current detector, or the inverter firing angle limit P 361 is set too low.
Drive starts to coast **ready-to-operate relay drops out**
- F 49 Unknown armature power unit identification** Error not acknowledgeable
The power unit identifier is read during the boot process after the electronics supply has been applied. This error message is displayed if the value for the power unit type (BKD / BKF) is unknown in the software.
Drive continues to coast **ready-to-operate relay remains dropped out**
- F 50 Data record selection not unique (dig. input function 1 - 6)** Error acknowledgeable
Only one data record must be selected via the programmable switching inputs (refer DIF 1 to DIF 6). If two or more data records are selected at the same time, the drive will be disabled after 150 controller cycles (500 ms at a 50 Hz mains frequency). No error message will be displayed if a contact overlap is eliminated within 150 controller cycles. The original data record remains active as long as the contacts overlap.
Drive starts to coast **ready-to-operate relay drops out**

- F 51 Input current < 3.3 mA at set value 4 to 20 mA** Error acknowledgeable
- This error message is tripped immediately (without delay) as soon as the input current for the setpoint input falls below the value of 3.3 mA.
- P 182 or P 186 set wrongly.
- Wire breakage of setpoint line or connection polarity reversed.
- Drive starts to coast** **ready-to-operate relay drops out**
- F 52 Mains undervoltage P 010 < 0,8 x P 070** Error acknowledgeable
- The measured voltage at the electronics supply is below the tripping threshold for four controller cycles. The tripping threshold is 80 % of the voltage rated value input with parameter P 070. Display of the measured voltage value in parameter P 010 in V_{eff} .
- Drive starts to coast** **ready-to-operate relay drops out**
- F 53 Overcurrent TD1 ($I_A > 2x P 072$)** Error acknowledgeable
- An armature current twice as high as the converter output current set with parameter P 072 has occurred.
- Possible cause: coils without interference suppression in the switching cabinet (operating hour counter, contactors etc.)
- Drive starts to coast** **ready-to-operate relay drops out**
- F 54 Overcurrent TD 2 ($I_A > 2x P 072$)** Error acknowledgeable
- An armature current twice as high as the converter output current set with parameter P 072 has occurred.
- Possible cause: coils without interference suppression in the switching cabinet (operating hour counter, contactors etc.)
- Drive starts to coast** **ready-to-operate relay drops out**
- F 55 Zero-current detector defective** Error not acknowledgeable
- The zero-current signal is checked during the boot process after the electronics supply has been activated. The error message is displayed if a level other than zero-current is measured.
- Hardware defect
- Drive continues to coast** **ready-to-operate relay remains dropped out**
- F 56 Offset error armature current detector > 50 mV** Error acknowledgeable
- The offset averaged over 30 measurements is above 50 mV. The offset is measured continuously if terminal X2: 15 is not energised ('Main contactor ON' contact is open).
- Hardware defect
- Drive continues to coast** **ready-to-operate relay drops out**

- F 57 Ambiguous data record change source** Error acknowledgeable
- No data record must be selected via PC or existing bus link (writing one of parameters P 152, P 157, P 158) if at least one programmable switching input is programmed for data record change (DIF 1 to DIF 6). This error message is displayed if this happens regardless.
- Drive starts to coast** **ready-to-operate relay drops out**
- F 58 EEPROM empty** Error not acknowledgeable
- No data record has been generated yet. The preset values were loaded from the after the EEPROM electronics supply was switched on. This data record must now be adapted to machine requirements and be stored in a data record. Set the boot source P 151 to a stored data record. Switch electronics supply off and on again.
- Drive continues to coast** **ready-to-operate relay remains dropped out**
- F 59 Parameter error in data record 1 (write error or value)** Error not acknowledgeable
- The programmed data records are copied from the EEPROM into the RAM after the supply voltage has been switched on. The process revealed incorrect values. The number of the affected parameter is displayed in P 156.
- Use parameter P 127 to change to data record 1 P 127 = 1. Correct the value and store data record 1 (P 153 = 1.1). LED H714 flashes during programming, and the lowest-value position in parameter P 150 changes to '3', '7' or 'B', P 150 = xxx3, P 150 = xxx7 or P 150 = xxxB. The electronics supply must be switched off and on again after programming.
- Drive continues to coast** **ready-to-operate relay remains dropped out**
- F 60 Parameter error in data record 2 (write error or value)** Error not acknowledgeable
- The programmed data records are copied from the EEPROM into the RAM after the supply voltage has been switched on. The process revealed incorrect values. The number of the affected parameter is displayed in P 156.
- Use parameter P 127 to change to data record 2 P 127 =2. Correct the value and store data record 2 (P 153 = 2.2). LED H714 flashes during programming, and the lowest-value position in parameter P 150 changes to '3', '7' or 'B', P 150 = xxx3, P 150 = xxx7 or P 150 = xxxB. The electronics supply must be switched off and on again after programming.
- Drive continues to coast** **ready-to-operate relay remains dropped out**
- F 61 Parameter error in data record 3 (write error or value)** Error not acknowledgeable
- The programmed data records are copied from the EEPROM into the RAM after the supply voltage has been switched on. The process revealed incorrect values. The number of the affected parameter is displayed in P 156.
- Use parameter P 127 to change to data record 3 P 127 = 3. Correct the value and store data record 3 (P 153 = 3.3). LED H714 flashes during programming, and the lowest-value position in parameter P 150 changes to '3', '7' or 'B', P 150 = xxx3, P 150 = xxx7 or P 150 = xxxB. The electronics supply must be switched off and on again after programming.
- Drive continues to coast** **ready-to-operate relay remains dropped out**

- F 62 Parameter error in data record 4 (write error or value)** Error not acknowledgeable
- The programmed data records are copied from the EEPROM into the RAM after the supply voltage has been switched on. The process revealed incorrect values. The number of the affected parameter is displayed in P 156.
- Use parameter P 127 to change to data record 4 P 127 = 4. Correct the value and store data set 4 (P 153 = 4.4). LED H714 flashes during programming, and the lowest-value position in parameter P 150 changes to '3', '7' or 'B', P 150 = xxx3, P 150 = xxx7 or P 150 = xxxB. The electronics supply must be switched off and on again after programming.
- Drive continues to coast** **ready-to-operate relay remains dropped out**
- F 63 Parameter error in data record 5 (write error or value)** Error not acknowledgeable
- The programmed data records are copied from the EEPROM into the RAM after the supply voltage has been switched on. The process revealed incorrect values. The number of the affected parameter is displayed in P 156.
- Use parameter P 127 to change to data record 5 P 127 = 5. Correct the value and store data set 5 (P 153 = 5.5). LED H714 flashes during programming, and the lowest-value position in parameter P 150 changes to '3', '7' or 'B', P 150 = xxx3, P 150 = xxx7 or P 150 = xxxB. The electronics supply must be switched off and on again after programming.
- Drive continues to coast** **ready-to-operate relay remains dropped out**
- F 64 Parameter error in data record 6** Error not acknowledgeable
- The programmed data records are copied from the EEPROM into the RAM after the supply voltage has been switched on. The process revealed incorrect values. The number of the affected parameter is displayed in P 156.
- Use parameter P 127 to change to data record 6 P 127 = 6. Correct the value and store data record 6 (P 153 = 6.6). LED H714 flashes during programming, and the lowest-value position in parameter P 150 changes to '3', '7' or 'B', P 150 = xxx3, P 150 = xxx7 or P 150 = xxxB. The electronics supply must be switched off and on again after programming.
- Drive continues to coast** **ready-to-operate relay remains dropped out**
- F 65 Error in ROM data record** Error not acknowledgeable
- Drive continues to coast** **ready-to-operate relay remains dropped out**

- F 66 Primary data parameter error** Error not acknowledgeable
- The primary data are copied from the EEPROM into the RAM after the supply voltage has been switched on. The process revealed incorrect values. The number of the affected parameter is displayed in P 156.
- Correct the value of this parameter. The input value is also stored in the EEPROM. After programming - the lowest-value position in parameter P 150 changes to '3', '7' or 'B', P 150 = xxx3, P 150 = xxx7 or P 150 = xxxB - the electronics supply must be switched off and on again.
- Drive continues to coast** **ready-to-operate relay remains dropped out**

- F 67 Armature power unit identific. differs from EEPROM value** Error not acknowledgeable
- This error message may be displayed if an already programmed memory module or the processor board was exchanged. The data records in the EEPROM were programmed at a converter with a different rated output current. Parameter P 004 shows the converter current of the original converter, parameter P 003 that of the current one.
- In the programmed data records, set parameters P 072 and P 074 in accordance with the motor requirements, and save !



CAUTION

Check whether the data stored in the EEPROM (data records and primary data) are suitable for the machine.

Then re-optimize (P 082 = 1).

Drive continues to coast **ready-to-operate relay remains dropped out**

- F 68 Data record does not exist** Error acknowledgeable
- Writing parameter P 152 or a programmable switching input selected a non-existent data record. The original data record remains active.
- Generate and save data record.
- Drive starts to coast** **ready-to-operate relay drops out**

F 69 Field power unit differs from EEPROM value

Error not acknowledgeable

This error message may be displayed if an already programmed memory module or the processor board was exchanged. The data records in the EEPROM were programmed at a unit with a different field output current. Parameter P 007 shows the field current of the original converter, parameter P 006 that of the current one.

In the programmed data records, set parameters P 079 and P 080 in accordance with the motor requirements, and save !

**CAUTION**

Check whether the data stored in the EEPROM (data records and primary data) are suitable for the machine.

Drive continues to coast**ready-to-operate relay remains dropped out****F 70 Option board does not respond**

Error not acknowledgeable

No handshake signal from the option board.

Drive starts to coast**ready-to-operate relay drops out****F 71 Illegal value in P 072 / P 074 in data record 1**

Error not acknowledgeable

This error message may be displayed if an already programmed memory module or the processor board was exchanged. The data records in the EEPROM were programmed at a unit with a different rated output current. Parameter P 004 shows the converter current of the original converter, parameter P 003 that of the current one.

50 % of the detected (P 003) power unit current are entered in parameter P 072, and 50 % of the value of parameter P 072 for the rated motor current P 074.

Use P 127 to select data record 1, P 127 = 1, set parameters P 072 and P 074 in accordance with the motor requirements and save with an input of P 153=1.1 !

**CAUTION**

Check whether the data (data records and primary data) stored in the EEPROM are suitable for the machine (speed adjustment, constant field, field weakening etc.).

Then re-optimize (P 082 = 1).

Drive continues to coast**ready-to-operate relay remains dropped out**

F 72 Illegal value in P 072 / P 074 in data record 2

Error not acknowledgeable

This error message may be displayed if an already programmed memory module or the processor board was exchanged. The data records in the EEPROM were programmed at a unit with a different rated output current. Parameter P 004 shows the converter current of the original converter, parameter P 003 that of the current one.

50 % of the detected (P 003) power unit current are entered in parameter P 072, and 50 % of the value of parameter P 072 for the rated motor current P 074.

Use P 127 to select data record 2, P 127 = 2, set parameters P 072 and P 074 in accordance with the motor requirements and save with an input of P 153=2.2 !



CAUTION

Check whether the data (data records and primary data) stored in the EEPROM are suitable for the machine (speed adjustment, constant field, field weakening etc.).

Then re-optimize (P 082 = 1).

Drive continues to coast

ready-to-operate relay remains dropped out

F 73 Illegal value in P 072 / P 074 in data record 3

Error not acknowledgeable

This error message may be displayed if an already programmed memory module or the processor board was exchanged. The data records in the EEPROM were programmed at a unit with a different rated output current. Parameter P 004 shows the converter current of the original converter, parameter P 003 that of the current one.

50 % of the detected (P 003) power unit current are entered in parameter P 072, and 50 % of the value of parameter P 072 for the rated motor current P 074.

Use P 127 to select data record 3, P 127 = 3, set parameters P 072 and P 074 in accordance with the motor requirements and save with an input of P 153=3.3 !



CAUTION

Check whether the data (data records and primary data) stored in the EEPROM are suitable for the machine (speed adjustment, constant field, field weakening etc.).

Then re-optimize (P 082 = 1).

Drive continues to coast

ready-to-operate relay remains dropped out

F 74 Illegal value in P 072 / P 074 in data record 4

Error not acknowledgeable

This error message may be displayed if an already programmed memory module or the processor board was exchanged. The data records in the EEPROM were programmed at a unit with a different rated output current. Parameter P 004 shows the converter current of the original converter, parameter P 003 that of the current one.

50 % of the detected (P 003) power unit current are entered in parameter P 072, and 50 % of the value of parameter P 072 for the rated motor current P 074.

Use P 127 to select data record 4, P 127 = 4, set parameters P 072 and P 074 in accordance with the motor requirements and save with an input of P 153=4.4 !

**CAUTION**

Check whether the data (data records and primary data) stored in the EEPROM are suitable for the machine (speed adjustment, constant field, field weakening etc.).

Then re-optimize (P 082 = 1).

Drive continues to coast**ready-to-operate relay remains dropped out****F 75 Illegal value in P 072 / P 074 in data record 5**

Error not acknowledgeable

This error message may be displayed if an already programmed memory module or the processor board was exchanged. The data records in the EEPROM were programmed at a unit with a different rated output current. Parameter P 004 shows the converter current of the original converter, parameter P 003 that of the current one.

50 % of the detected (P 003) power unit current are entered in parameter P 072, and 50 % of the value of parameter P 072 for the rated motor current P 074.

Use P 127 to select data record 5, P 127 = 5, set parameters P 072 and P 074 in accordance with the motor requirements and save with an input of P 153=5.5 !

**CAUTION**

Check whether the data (data records and primary data) stored in the EEPROM are suitable for the machine (speed adjustment, constant field, field weakening etc.).

Then re-optimize (P 082 = 1).

Drive continues to coast**ready-to-operate relay remains dropped out**

F 76 Illegal value in P 072 / P 074 in data record 6

Error not acknowledgeable

This error message may be displayed if an already programmed memory module or the processor board was exchanged. The data records in the EEPROM were programmed at a unit with a different rated output current. Parameter P 004 shows the converter current of the original converter, parameter P 003 that of the current one.

50 % of the detected (P 003) power unit current are entered in parameter P 072, and 50 % of the value of parameter P 072 for the rated motor current P 074.

Use P 127 to select data record 6, P 127 = 6, set parameters P 072 and P 074 in accordance with the motor requirements and save with an input of P 153=6.6 !



CAUTION

Check whether the data (data records and primary data) stored in the EEPROM are suitable for the machine (speed adjustment, constant field, field weakening etc.).

Then re-optimize (P 082 = 1).

Drive continues to coast

ready-to-operate relay remains dropped out

F 77 Illegal value in P 079 in data record 1

Error not acknowledgeable

This error message may be displayed if an already programmed memory module or the processor board was exchanged. The data records in the EEPROM were programmed at a unit with a different field output current. Parameter P 007 shows the field current of the original converter, parameter P 006 that of the current one.

The value (= rated field unit current) of the identified field power unit (P 006) is entered in parameter P 079.

Use P 127 to select data set 1, P 127 = 1, set parameter P 079 in accordance with the motor requirements and save with an input of P 153=1.1 !



CAUTION

Check whether the data (data records and primary data) stored in the EEPROM are suitable for the machine (speed adjustment, constant field, field weakening etc.).

Drive continues to coast

ready-to-operate relay remains dropped out

F 78 Illegal value in 079 in data record 2

Error not acknowledgeable

This error message may be displayed if an already programmed memory module or the processor board was exchanged. The data records in the EEPROM were programmed at a unit with a different field output current. Parameter P 007 shows the field current of the original converter, parameter P 006 that of the current one.

The value (= rated field unit current) of the identified field power unit (P 006) is entered in parameter P 079.

Use P 127 to select data record 2, P 127 = 2, set parameter P 079 in accordance with the motor requirements and save with an input of P 153=2.2 !

**CAUTION**

Check whether the data (data records and primary data) stored in the EEPROM are suitable for the machine (speed adjustment, constant field, field weakening etc.).

Drive continues to coast**ready-to-operate relay remains dropped out****F 79 Illegal value in P 079 in data record 3**

Error not acknowledgeable

This error message may be displayed if an already programmed memory module or the processor board was exchanged. The data records in the EEPROM were programmed at a unit with a different field output current. Parameter P 007 shows the field current of the original converter, parameter P 006 that of the current one.

The value (= rated field unit current) of the identified field power unit (P 006) is entered in parameter P 079.

Use P 127 to select data record 3, P 127 = 3, set parameter P 079 in accordance with the motor requirements and save with an input of P 153=3.3 !

**CAUTION**

Check whether the data (data records and primary data) stored in the EEPROM are suitable for the machine (speed adjustment, constant field, field weakening etc.).

Drive continues to coast**ready-to-operate relay remains dropped out**

F 80 Illegal value in P 079 in data record 4

Error not acknowledgeable

This error message may be displayed if an already programmed memory module or the processor board was exchanged. The data records in the EEPROM were programmed at a unit with a different field output current. Parameter P 007 shows the field current of the original converter, parameter P 006 that of the current one.

The value (= rated field unit current) of the identified field power unit (P 006) is entered in parameter P 079.

Use P 127 to select data record 4, P 127 = 4, set parameter P 079 in accordance with the motor requirements and save with an input of P 153=4.4 !



CAUTION

Check whether the data (data records and primary data) stored in the EEPROM are suitable for the machine (speed adjustment, constant field, field weakening etc.).

Drive continues to coast

ready-to-operate relay remains dropped out

F 81 Illegal value in P 079 in data record 5

Error not acknowledgeable

This error message may be displayed if an already programmed memory module or the processor board was exchanged. The data records in the EEPROM were programmed at a unit with a different field output current. Parameter P 007 shows the field current of the original converter, parameter P 006 that of the current one.

The value (= rated field unit current) of the identified field power unit (P 006) is entered in parameter P 079.

Use P 127 to select data record 5, P 127 = 5, set parameter P 079 in accordance with the motor requirements and save with an input of P 153=5.5 !



CAUTION

Check whether the data (data records and primary data) stored in the EEPROM are suitable for the machine (speed adjustment, constant field, field weakening etc.).

Drive continues to coast

ready-to-operate relay remains dropped out

F 82 Illegal value in P 079 in data record 6

Error not acknowledgeable

This error message may be displayed if an already programmed memory module or the processor board was exchanged. The data records in the EEPROM were programmed at a unit with a different field output current. Parameter P 007 shows the field current of the original converter, parameter P 006 that of the current one.

The value (= rated field unit current) of the identified field power unit (P 006) is entered in parameter P 079.

Use P 127 to select data record 6, P 127 = 6, set parameter P 079 in accordance with the motor requirements and save with an input of P 153=6.6 !

**CAUTION**

Check whether the data (data records and primary data) stored in the EEPROM are suitable for the machine (speed adjustment, constant field, field weakening etc.).

Drive continues to coast**ready-to-operate relay remains dropped out****F 83 EEPROM write time exceeded**

Error acknowledgeable

A data record or an individual piece of data (primary data) could not be programmed within the specified time limit. Programming was aborted. The data record in question was identified as non-existent.

EEPROM defective.

Hardware defect

Drive starts to coast**ready-to-operate relay drops out****F 84 Primary data checksum error**

Error not acknowledgeable

The primary data are copied into the RAM after the electronics supply has been applied. This process detected a checksum different from the one stored with the data.

EEPROM defective.

Drive continues to coast**ready-to-operate relay drops out****F 85 Checksum error in data record 1**

Error not acknowledgeable

The programmed data records are copied into the RAM after the electronics supply has been applied. The checksum for data record 1 differs from the one stored with the data record.

EEPROM defective.

Drive continues to coast**ready-to-operate relay drops out****F 86 Checksum error in data record 2**

Error not acknowledgeable

The programmed data records are copied into the RAM after the electronics supply has been applied. The checksum for data record 2 differs from the one stored with the data record.

EEPROM defective.

Drive continues to coast**ready-to-operate relay drops out****F 87 Checksum error in data record 3**

Error not acknowledgeable

The programmed data records are copied into the RAM after the electronics supply has been applied. The checksum for data record 3 differs from the one stored with the data record.

EEPROM defective.

Drive continues to coast**ready-to-operate relay drops out**

- F 88 Checksum error in data record 4** Error not acknowledgeable
The programmed data records are copied into the RAM after the electronics supply has been applied. The checksum for data record 4 differs from the one stored with the data record.
EEPROM defective.
Drive continues to coast **ready-to-operate relay drops out**
- F 89 Checksum error in data record 5** Error not acknowledgeable
The programmed data records are copied into the RAM after the electronics supply has been applied. The checksum for data record 5 differs from the one stored with the data record.
EEPROM defective.
Drive continues to coast **ready-to-operate relay drops out**
- F 90 Checksum error in data record 6** Error not acknowledgeable
The programmed data records are copied into the RAM after the electronics supply has been applied. The checksum for data record 6 differs from the one stored with the data record.
EEPROM defective.
Drive continues to coast **ready-to-operate relay drops out**
- F 91 Undefined field bus card status** Error acknowledgeable
Drive starts to coast **ready-to-operate relay drops out**
- F 92 Field bus error** Error acknowledgeable
Faulty bus link between master (control) and option board on the converter.
Master (control) not transmitting.
Bus cable between control and option board defective or incontinuous.
Drive starts to coast **ready-to-operate relay drops out**
- F 93 Field bus setpoint/actual-value configuration error** Error acknowledgeable
Error occurs when booting the converter. The number of the setpoints and/or actual values entered in option board parameters P 768 to P 799 differs from the number defined in the higher-level control.
Drive starts to coast **ready-to-operate relay drops out**

- F 94 P657 / P658 parameter conflict (from S03.10)** Error acknowledgeable
- The values entered in parameters P 657, 'Positive limit, limiter', and P 658, 'Negative limit, limiter', result in a range overlap. The value in parameter P 658 is larger than that in parameter 657. Parameter P 657 must contain the larger of the two values.
- The error message is tripped when the drive is enabled.
- Correct parameter setting and save.
- Drive continues to coast** **ready-to-operate relay drops out**
- F 96 Motor temperature reached shut-off temperature 1 (channel 1)** Error acknowledgeable
- Active when P 541 = 1
- The motor temperature reached or exceeded the value set in parameter P 543 (sensor connection X8:1 and X8:2 on board LP 3.0043).
- From software S03.14 this error is also generated, when the option board is not available or the connection X212 is missing (when P541=1).
- Drive starts to coast** **ready-to-operate relay drops out**
- F 97 Motor temperature reached shut-off temperature 2 (channel 2)** Error acknowledgeable
- Active when P 544 = 1
- The motor temperature reached or exceeded the value set in parameter P 546 (sensor connection X8:4 and X8:5 on board LP 3.0043).
- From software S03.14 this error is also generated, when the option board is not available or the connection X212 is missing (when P541=1).
- Drive starts to coast** **ready-to-operate relay drops out**

6.4 Error description

- F 98 No connection motor temperature sensor 1 (channel 1)** Error acknowledgeable
- Active when P 541 = 1
- The resistance between the connections X8:1 and X8:2 on board 3.0043 is higher than 2700 Ω , it is assumed, that the sensor cables are broken.
- Check the connections in the motor connection box (TM+ and TM-) and on the board 3.0043 (X8:1 and X8:2)
- Disconnect temperature sensor and check with ohmmeter.
- Typical resistance:
- | | |
|---------|---------------|
| 0 °C | 500 Ω |
| +25 °C | 600 Ω |
| +50 °C | 720 Ω |
| +100 °C | 1000 Ω |
| +150 °C | 1300 Ω |
- Drive starts to coast** **ready-to-operate relay drops out**
- F 99 Cable broken of motor temperature sensor 2 (channel 2)** Error acknowledgeable
- Active when P 544 = 1
- The resistance between the connections X8:4 and X8:5 on board 3.0043 is higher than 2700 Ω , it is assumed, that the sensor cables are broken.
- Check the connections in the motor connection box (TM+ and TM-) and on the board 3.0043 (X8:4 and X8:5)
- Disconnect temperature sensor and check with ohmmeter.
- Typical resistance of the sensor: see description error F 98.
- Drive starts to coast** **ready-to-operate relay drops out**
- F 100 Short circuit of motor temperature sensor 1 (channel 1)** Error acknowledgeable
- Active when P 541 = 1
- The resistance between the connections X8:1 and X8:2 on board 3.0043 is lower than 132 Ω , a short circuit of the sensor cables is assumed.
- Check sensor cables with regard to insulation fault.
- Disconnect temperature sensor and check with ohmmeter.
- Typical resistance of the sensor: see description error F 98.
- Drive starts to coast** **ready-to-operate relay drops out**

- F 101 Short circuit of motor temperature sensor 2 (channel 2)** Error acknowledgeable
- Active when P 544 = 1
- The resistance between the connections X8:4 and X8:5 on board 3.0043 is lower than 132 Ω , a short circuit of the sensor cables is assumed.
- Check sensor cables with regard to insulation fault.
- Disconnect temperature sensor and check with ohmmeter.
Typical resistance of the sensor: see description error F 98.
- Drive starts to coast** **ready-to-operate relay drops out**
- F 102 Cable break temperature sensor power unit (from S 03.15)** Error acknowledgeable
- Threshold unit size I and II: +120 °C, without hysteresis
- Threshold unit size III and IV: -26 °C, without hysteresis
- Drive starts to coast** **ready-to-operate relay drops out**
- F 103 Short circuit temperature sensor power unit (from S 03.15)** Error acknowledgeable
- Threshold unit size I and II: -38 °C, without hysteresis
- Threshold unit size III and IV: +120 °C, without hysteresis
- Drive starts to coast** **ready-to-operate relay drops out**
- F 104 Power unit temperature limit reached (from S 03.15)** Error acknowledgeable
- Error message only generated when P 112 = 1. The valid temperature threshold is available in ALink 221. At the same time the warning W3 is generated (W3 is also active when P 112 = 0), the error message is without hysteresis.
- Drive starts to coast** **ready-to-operate relay drops out**
- F 105 Error reaction freely definable error (from S 03.15)** Error acknowledgeable
- The event (DLink) selected with parameter P 730 is detected.
- Drive starts to coast** **ready-to-operate relay drops out**

6.5 Warning description

W 1 Speed input incremental encoder 1 to high

The specified frequency limit of 200 kHz was exceeded on entering parameters P 261, 'Increments of incremental encoder 1' and P 262, 'Max. speed, incremental encoder 1'. Entry of the number of increments (P 261) calculates the speed taking into account the frequency limit and enters this value in parameter P 262.

The input will be corrected by the drive !

To acknowledge the warning, re-enter the speed taking into account the frequency limit.

W 2 Data record save not completed

A command to save the data record was entered although a previous save has not been completed yet. The data record last selected was not saved. A data record is fully programmed as soon as the lowest-value position in parameter P 150 changes to '3', '7' or 'B', P 150 = xxx3 P 150 = xxx7 or P 150 = xxxB.

To acknowledge the warning, reprogram the rejected data record after the previous data record has been processed.

W 3 Power unit temperature exceeded

The heat sink temperature has exceeded the permitted temperature limit. The temperature limit is dependent on current intensity and converter type (BKD / BKF). The value is available in ALink 221 and specified in °C.

Operation may be continued for max. 5 mins before the drive must be switched off. The measure must be taken by the operator. The warning is deleted as soon as the heat sink temperature falls by 3 °C below the limit value.

Occurs also if unit size I/II has a cable break to its temperature sensor, display in P 025 = +159 °C.

Occurs also if unit size III/IV has a short circuit on its temperature sensor cable, display in P 025 = +124 °C.

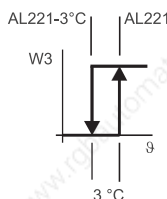

W 4 Data record not erased

An attempt was made to erase the currently selected data record. This is not possible. EEPROM data record erases are effective only for a data record that is currently not in use.

W 5 P 072 / P 074 parameter conflict

The values entered in parameters P 072, 'Maximum converter current', and P 074, 'Rated motor current', result in a range overlap.

The warning is displayed if, when the drive is enabled, the value in parameter P 074 is larger than the value of parameter P 072 or smaller than 50% P 072. The following applies:

$$0.5 \times P\ 072 \leq P\ 074 \leq P\ 072$$

Correct parameter setting and save.

W 6 Intermittent-current limit cannot be defined

The message is displayed during optimisation P 082 = 1 if the intermittent-current limit cannot be defined because of a value larger than 100 %. 100 % corresponds to the value of the maximum converter output current, programmed with parameter P 072. The reason for this is that the armature circuit inductance is insufficient for the settings.

Check whether the motor can be operated at a higher current for the duration of the optimisation run. If so, optimise at the higher current (increase value in parameter P 072). After optimisation, set the current limits with parameters P 325 and P 326 in a way not to exceed the permissible motor current during operation.

W 7 Data record change not possible

A data record change was requested while the drive was enabled (parameter P 152 or programmed switching contact) although the setting of parameter P 154 permits data record changes only while the drive is disabled. The original data record remains active.

W 8 Motor i^2t tripped

The monitoring function trips as soon as the calculated i^2t value exceeds the threshold set with parameter P 525. The drive does not start to coast. The motor can be operated for another 5 minutes max. before the operator must disable the drive.

Possible causes:

Parameter P 525 set too low.

Therm. time constant parameter P 078 set too low.

Motor operated on overcurrent for too long.

W 9 Cannot erase boot data record

An attempt was made to erase the boot data record. This is not possible. Only a data record not entered as a boot source in parameter P 151 can be erased in the EEPROM.

W 10 Cannot reset

The reset (DIF 7 and P 106) cannot be executed as EEPROM activities have not been completed.

6.5 Warning description

W 11 Motor warning temperature channel 1 reached

Active when P 541 = 1

The motor temperature reached or exceeded the value set in parameter P 542 (sensor connection X8:1 and X8:2 on board LP 3.0043).

The warning is removed when the temperature is P 542 - 5 °C.

W 12 Motor warning temperature channel 2 reached

Active when P 541 = 1

The motor temperature reached or exceeded the value set in parameter P 545 (sensor connection X8:4 and X8:5 on board LP 3.0043).

The warning is removed when the temperature is P 545 - 5 °C.

W 13 Power unit temperature has reached the pre-warning limit (from S 03.15)

The pre-warning is activated when the power unit's temperature is

$$\vartheta = \text{limit temperature} + 10 \text{ °C.}$$

The pre-warning is deleted when the power unit's temperature is lower than

$$\vartheta = \text{Grenztemperatur} + 13 \text{ °C.}$$

The value of the valid power unit's limit temperature is stored in ALink 221.



APPENDIX A - ABBREVIATIONS

7S	seven segments
ADC	Analog-digital-converter
ADR	Slave-Adress, USS
aG	Rectifier firing angle limit
AL	Analog Link = analog connection signal
ALink	Analog Link = analog connection signal
aW	Inverter firing angle limit
BAPS	Baumüller Antriebe parallel interface
BASS	Baumüller Antriebe serial interface
BCC	Block Check Character (XOR relation of all characters)
Bsa	Reference potential analog
Bsd	Reference potential digital
Bse	Reference potential external
CCW	counterclockwise
CD	Controller disabled
CE	Controller enable
CR	Command and response identification, USS
CW	clockwise
D content	differential part of signal
DIF	digital input function
DL	Digital Link = Digital link signal
DLink	Digital Link = Digital link signal
DR	data record, i.e.one of the 6 data records

DRNo	Data record number
DT1 element	D element with first order time delay
EMF	Electromotive force
FRD	Final rounding, DOWN
FRU	Final rounding, UP
IND	Index, USS
IRD	Initial rounding, DOWN
IRU	Initial rounding, UP
KP	Adaptation signal
LGT	Message length, USS
MC	Main contactor
MP	Motorpotentiometer
PCD	Process Data, USS
PCO	Parameter code
PCV	Parameter coded value, USS
PD	primary data, i.e. data not saved in one of the 6 data records
PI	Proportional Integral
PNU	Parameter-No., USS
PU	Pulse enable
QS	Deactivate quick stop
QS	Quick stop
S	Software (Example S03.03)
STX	Start of Text, USS
TD	Ramp-down time
TD	torque direction
Tn	Integral-action time
TU	Ramp-up time
ZK	Option board



APPENDIX B - USS PROTOCOL



NOTE

The USS protocol is a registered Siemens AG trademark.

The USS protocol interface allows a communication between master and slave using a fixed message length.

B.1 Data transmission and security

(layers 1 and 2 of the ISO/OSI model)

The following applies for data transmission and security:

- ▶ The mode is strictly half-duplex.
- ▶ The protocol is a master/slave protocol with bus capability, with the external processor always assuming the master and the drives always assuming the slave function.
- ▶ The message length is fixed and cannot be changed online.
- ▶ All messages must be transmitted unbroken, i. e. without gaps. No acknowledge and repeat messages are required due to the strictly cyclic message exchange.
- ▶ The transmission framework for the individual characters is defined as follows:
1 start bit, 8 data bits, 1 parity bit (even parity), 1 stop bit.

The start character of each message (master and slave messages) is the ASCII character STX = 02hex in combination with a preceding 33 -bit transmission break. All other characters in the message are code-independent.

Different data security measures achieve a Hamming distance of $d = 4$, which means that, per message, there must be at least 4 bit errors at defined locations within the message before a faulty message is no longer recognised as such.

STX	LGT	ADR	Net data block with n-characters	BCC
-----	-----	-----	----------------------------------	-----

Illustration 78: Message structure

B.1 Data transmission and security

with

STX: Start of Text (02hex)

LGT: Message length 2 - 254 bytes (excluding STX and LGE, but including ADR and BCC)

ADR: Slave address 0 - 31; 32: Broadcast message, = 64: Mirror message

BCC: Block Check Character (XOR relation of all characters)

B.1.1 Transmission procedure

The start character STX (02hex) alone does not suffice to identify the beginning of a message as this bit combination may also occur right in the middle of the message, in the net data block, for example. This is the reason for the 33-bit transmission break before master and slave messages. Only an STX received with a preceding transmission break identifies a valid message start. The half-duplex mode (either transmission or reception only at any one time) always ensures this start break in error-free operation.

The definition of the start break makes it a prerequisite that this break time must never occur between two characters within a message. For this reason, all messages must be transmitted unbroken, i. e., without gap.

Each drive responds only after it has received a complete and error-free message sent to its own address.

The reasons why a slave does not answer a master message with a response message may be as follows:

- ▶ The slave is not switched on yet.
- ▶ The slave received a faulty message.
- ▶ The communication line is interrupted or faulty.

As a rule, a slave responds to each master message after a short processing period. The sequence involving several slaves is shown in the diagram below:

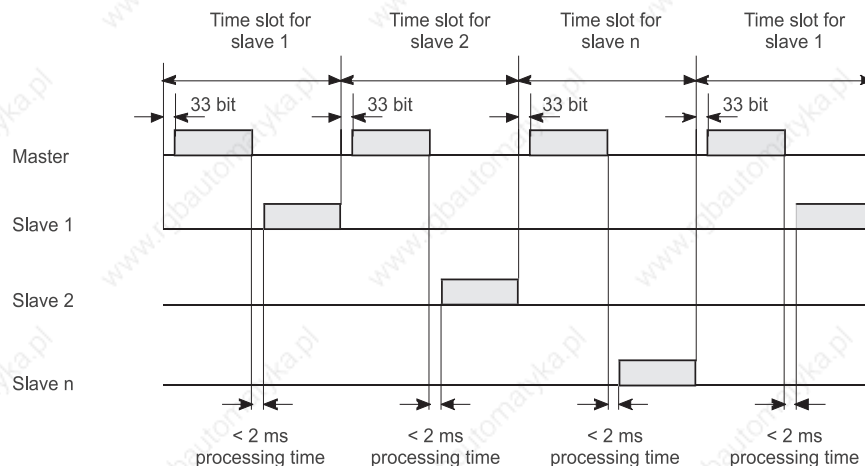

Illustration 79: 2-wire and 4-wire mode (half-duplex)

B.1.2 Net data block structure

The net data block is divided into two areas:

- ▶ PCV area (parameter code value)
- ▶ PCD area (process data)

The **PCV area** assists in the exchange of parameters between two communication partners, i. e., in the reading and writing of parameter values and reading of the parameter description.

The **PCD area** contains the signals required for automation:

Master-to-slave control word and setpoints

Slave-to-master status word and actual values

Both areas together form the net data block. This structure applies for the command message (master ⇒ slave) as well as for the response message (slave ⇒ master).

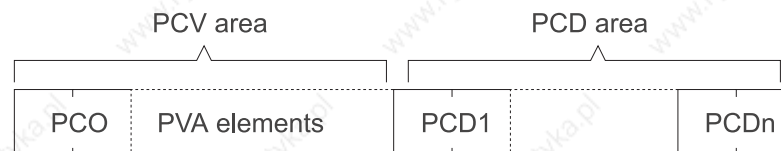

PCO: Parameter code (PCO) identifies and initiates commands and responses on parameter processing and is always one word long (= 16 bit).

PVA element: Parameter value, with extension or other operating data as required. The number of PVA elements may also be 0 if PCD data only are to be transmitted in the net data block.

PCD1-PCDn: Process data (control/status word and setpoints/actual values). The required setpoints and actual values are transmitted in this area. Its length must always be agreed between drive and control.

The number of PCD elements may also be 0 if PCV data only are to be transmitted in the net data block.

Depending on the direction of transmission, the control or status word must always be transmitted in PCD1. The setpoints or actual values are transmitted in the subsequent process data PCD2 to PCDn.

B.1.3 Bus addresses

The bus addresses are set with the help of parameter P 120 KOM Drive address. Address 32 is the broadcast address.

B.1.4 Mirror message

The bus master can request a mirror message from the slave. The master sends a message to the respective slave, which differs from a normal message only in that bit no. 7 is set in the address byte ADR.

The slave returns this message to the master immediately as response message on receipt.

The mirror message can be used to check proper functioning of the data transmission between master and slave. This is advantageous during step-by-step commissioning or for error location in the bus system, for example.

B.1.5 Broadcast message

A broadcast message is a master message addressed to all slaves at the same time. It differs from a normal master message only in that the address byte ADR contains address 32 (bit no. 5 = 1).

Broadcast messages receive no slave response, and the master does not expect any response messages.

The net data are processed as follows:

- ▶ Setpoints in the PCD area are not accepted.
- ▶ Commands in the PCV area are not processed.
- ▶ The control word in PCD1 is linked with its mask in PVA1 so that only those bits in the drive control word are refreshed that are set to '1' in the mask. The bits masked '0' are not refreshed and retain the original status.

The broadcast mode is possible only if PCV number > 3 and PCD number > 1. The command code must be set to 0 ('No command').

The control word is accepted unmasked if PCV number = 0 is set.

B.1.6 Structure of the PCV area

The structure of the PCV area is always the same in terms of the sequence of its elements and differs in its standard structure only in the number of its parameter values (PVA).

The parameter Number of PCV elements (USS) (P 133) allows the PCV area to be set with a fixed length (3 or 4 words).

Set a PCV number = 0 if no PCV area is required in the net data block, so that no parameterisation is possible via this interface.

B.1.6.1 PCV area at fixed message length

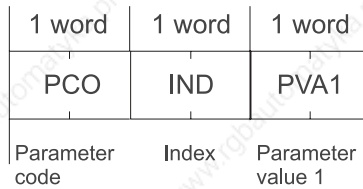

Illustration 80: Standard structure for parameter values as word size (PCV number = 3)

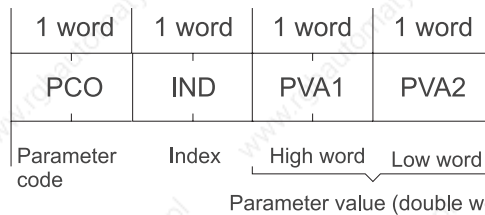

Illustration 81: Standard structure for parameter values as double word size (PCV number = 4)

This applies for both the command as well as for the response message.

B.1.6.2 Description of the individual PCV elements

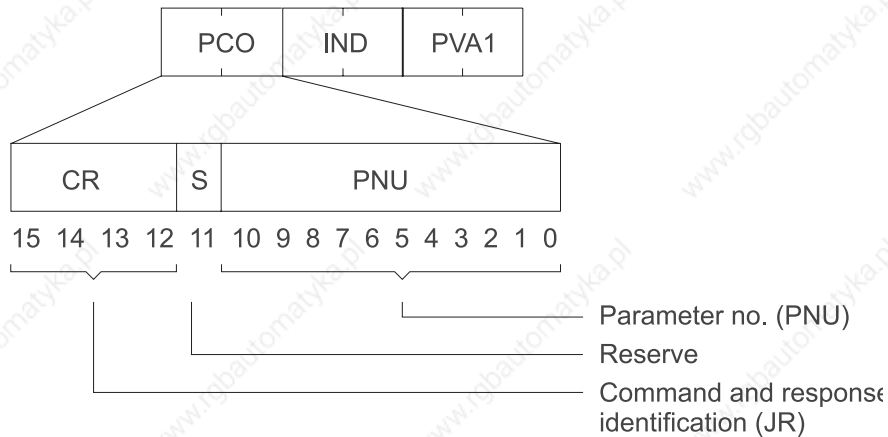

Illustration 82: Parameter code (PCO)

B.1.6.3 Command and response code

All commands passed from the master to the slave are encrypted in the command code. The slave processes the command and words the associated response which is then encrypted (CR) and passed on to the master. The CR is defined in such a way that a command or a response is clearly defined by the PCO (CR+PNU), and, in addition to that, for certain commands/responses also by the index word IND.

B.1 Data transmission and security

Command code (master ⇒ slave)

Bit no.				Function	Description
15	14	13	12		
0	0	0	0	No command	No command for the PCV interface
0	0	0	1	Request PVA	Requesting a PVA
0	0	1	0	Change PVA (word)	Writing a PVA word (16 bit)
0	0	1	1	Change PVA (double word)	Writing a PVA double word (32 bit)
0	1	0	0	Request PDE element	Reading an element from the parameter description (PDE) IND specifies the element to be read.

Response code (slave ⇒ master)

Bit no.				Function	Description
15	14	13	12		
0	0	0	0	No response	No response
0	0	0	1	Transmit PVA (word)	Transmitting a PVA word (16 bit)
0	0	1	0	Transmit PVA (double word)	Transmitting a PVA double word (32 bit)
0	0	1	1	Transmit PDE element	Transmitting an element from the parameter description (PDE) IND specifies the element to be transmitted.
0	1	1	1	Cannot execute command	Error code in PVA, see also error list

Relationship between transmitted command and associated response

Command code				Response code					
Code		Function		Code		Function			
15	14	13	12	15	14	13	12		
0	0	0	0	No command	0	0	0	No response	
0	0	0	1	Request PVA	0	0	0	1	Transmit PVA (word)
0	0	1	0	Change PVA (word)	0	0	1	0	Transmit PVA (double word)
0	0	1	1	Change PVA (double word)	0	0	0	1	Transmit PVA (word)
0	1	0	0	Request PDE element	0	0	1	0	Transmit PVA (double word)
0	1	0	0	Request PDE element	0	0	1	1	Transmit PDE element

B.1.6.4 Significance of the IND field (index)

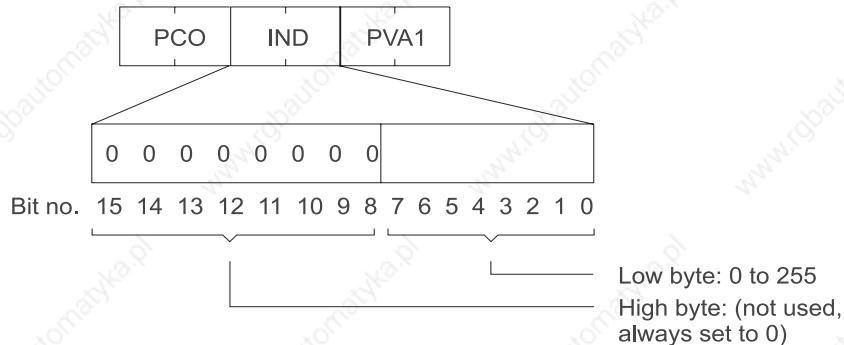

The index is used for writing and reading the parameter description.

In all other cases, the index is carried as 'zero word' in the message, i. e., all bits are set to 0.

The above significance of the IND field (index) is valid only in combination with the Request PDE (parameter description element) command codes. In this command, the value in IND must be used to further define which element is to be read from the parameter description.

PBE elements

Value	Description
1	Parameter attribute
2	Parameter info
5	Parameter minimum value
6	Parameter maximum value

B.1.6.5 Parameter value PVA

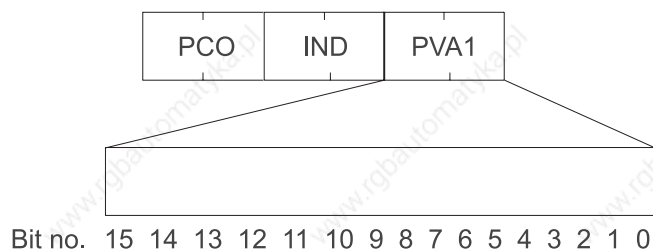

PVA contents is dependent on the command passed on, and/or the associated response, respectively.

PCV length for word sizes always 3 words (PCO, IND and PVA)

PCV length for double word sizes always 4 words (PCO, IND and PVA1 and PVA2))

B.1.6.6 Error code list

The slave acknowledges any commands that cannot be executed with the response code 'Cannot execute command' and transfers the associated error code in the parameter value (PVA).

Code	Description
0	Impermissible PNU
1	Parameter cannot be changed
2	MIN/ MAX limit
3	Faulty IND
4	No array
5	Wrong data type
6	Setting not permitted
7	Description element cannot be changed
:	:
100	Reserved
101	Unspecified error
102	Service not implemented
103	Parameter format too big for PCV area
104	PDE element does not exist

B.1.6.7 Command/response processing

Command/response processing describes the chronological and functional data transmission sequence for the PCV interface between master and slaves.

- ▶ The master must only ever pass one command to a slave and must wait for the associated response code. The master must repeat its command while it is waiting for the response code.
- ▶ The command/response must be transmitted complete within one message.
- ▶ Any change to the command means a new command which must be acknowledged with the associated response! The command code 'No command' is answered with the response code 'No command'!
- ▶ The command 'No response' must be emitted if no information is required from the PCV interface during cyclic operation.
- ▶ If the periods between cyclic message sequence and response transmission in the system are large, the slave continues transmitting the response for the 'old command' during the transition phase between 'old' and 'new' commands until the 'new command' is detected and the associated response prepared.
- ▶ For responses including parameter values, the slave always responds with the current value when repeating the response messages.
- ▶ Upon initial communication between master and slave, the slave can only respond with the code 'No response' during the transition phase in which a response is prepared in the system.
- ▶ The master must react accordingly if it does not receive a response code pertaining to the command from the contacted slave.
- ▶ The slave does not expect acknowledgement from the master as to whether the response was received.
- ▶ Identifying the response to a command in the master:
The master identifies the correct response in the response message by logically checking response code, parameter number, index and value.

- ▶ Identifying a new command in the slave:
Each command the master passes on after receiving a valid response to the old command is identified as a new one.
- ▶ If the master transmits a broadcast message, the slaves must not send a response message to the master in reply to this broadcast message.

B.1.6.8 Reading parameter attribute feedback

When reading the parameter attribute via the command Request PDE, the controller feeds back the attribute information in the element PVA2 in a special code. The individual bits are described in the table below.

Bit	Description	Definition	Comments
0 - 1	Data length of an element in bytes	00 1 Byte 01 2 Byte 10 4 Byte 11 8 Byte	
2 - 3	Data type of an element	00 SIGNED 01 UNSIGNED 10 FLOAT	Integer with sign Integer without sign Floating-point number
4 - 5	Number of elements	00 FIXED 01 VARIABLE	One element variable number of elements
6 - 7	Element type	00 DATA 01 COMMAND	
8 - 11	Display format	0000 BIN 0001 DEC 0010 HEX 0100 NORM 0101 FIX 0110 SCI 0111 ENG 1000 ASCII	Binary decimal Hexadecimal Floating point without exponent Floating point with fixed exponent Floating point, scientific Floating point, technical ASCII character
12 - 15	Positions after comma	0000 0 1111 15	No positions after comma 15 positions after comma

B.1 Data transmission and security

B.1.6.9 Reading parameter info feedback

When reading the parameter information via the command Request PDE, the controller feeds back further information on the parameter in the element PVA. Since this information is available in 32-bit format, it can be read only if the PCV area is set for double word transmissions (PCV number = 4). This information, too, is bit-coded. For a description see table below.

Bit	Description	Definition	Comments
0 – 2	Write protection	000 UNPROTECTED 011 PROTECTED	Not protected Write-protected
3 – 4	Save mode	00 NONSTORE 01 STORE DR 10 STORE ZD	Parameter value is not stored. Parameter value is stored in data record. Parameter value is stored in primary data.
5 – 11	Not assigned		
12 – 15	Decimal weighting factor	0 $\cong 10^0$ 1 $\cong 10^1$ 2 $\cong 10^2$ 3 $\cong 10^3$ 4 $\cong 10^4$	For the conversion from internal scaling to output values
16 – 32	Assessment factor	16Bit UNSIGNED	For the conversion from internal scaling to output values

Conversion from internal representation to output values is performed automatically by the converter for PCV communication if so set in parameter P 131, USS mode.

- ▶ These scaling functions are:
 - ▶ For write accesses:

$$\text{internal value} = \text{external value} \frac{\text{Assessment factor}}{10^{\text{Weighting}}}$$

- ▶ For read accesses:

$$\text{external value} = \text{internal value} \bullet \frac{10^{\text{Weighting}}}{\text{Assessment factor}}$$

B.1.7 Structure of the PCD area

The structure of the PCD area is always the same in terms of the sequence of its elements (= words) and differs in its standard structure only in the number of transmitted setpoints/actual values.

It comprises max. 3 words and min. 0 words, i. e., there is no PCD area in the net data block.

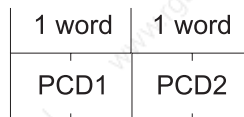

Control / Status word Setpoint 1 Actual value 1

Illustration 83: Standard structure at 1 setpoint/actual value (PCD number = 2):

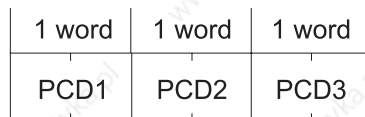

Control / Status word Setpoint 1 Act. value 1 Setpoint 2 Actual value 2

} Setpoints Actual values

Illustration 84: Standard structure at 2 setpoints/actual values (PCD number = 3):

B.1.7.1 Description of the individual PCD elements

Control word and status word

The significance of the bits in control word and status word is described in the converter control under parameters Control word (P 101) and Status word (P 100).

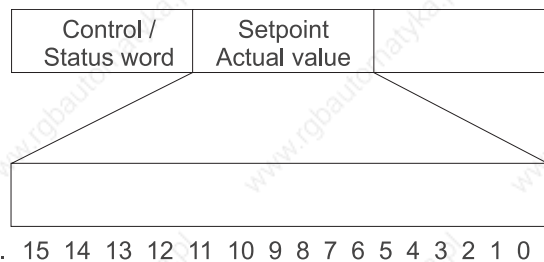

Illustration 85: Setpoints/actual values

Transmission of internally scaled setpoints and actual values, see also [ALink](#) from page 85.

B.2 Bus system commissioning (fixed message length)

B.2 Bus system commissioning (fixed message length)

The following applies for commissioning communication with USS protocol interface at fixed message length:

- ▶ The following applies for communication between master and slave:
Command and response messages have the same length, i. e., same length in terms of PCV and PCD areas.
- ▶ This length must be fixed-set prior to initial bus system commissioning and must not be modified during operation.
- ▶ A fixed message length means a fixed net data block size.
- ▶ The net data block size is set via two parameters, Number of PCV elements (USS)(P 133), and Number of PCD elements (USS) (P 134).
- ▶ If the master passes on a command that would entail a response exceeding the set PCV area size, this command is acknowledged with the response code 'Cannot execute command'. The command 'Request PVA double word' cannot be executed at PVA number = 3, for example.
- ▶ The commands the master is expected to pass on must be defined before setting the net data block size. Then this must be taken as the basis to define the PCV area size. In other words, if double word processing is envisaged, the PCV area must be set to 4 words as a rule prior to initial commissioning, even if word processing prevails.

Sample messages:**Example 1:** PCV number = 3, PCD number = 2

Allows parameterisation of word parameters and transmission of 1 setpoint and actual value.

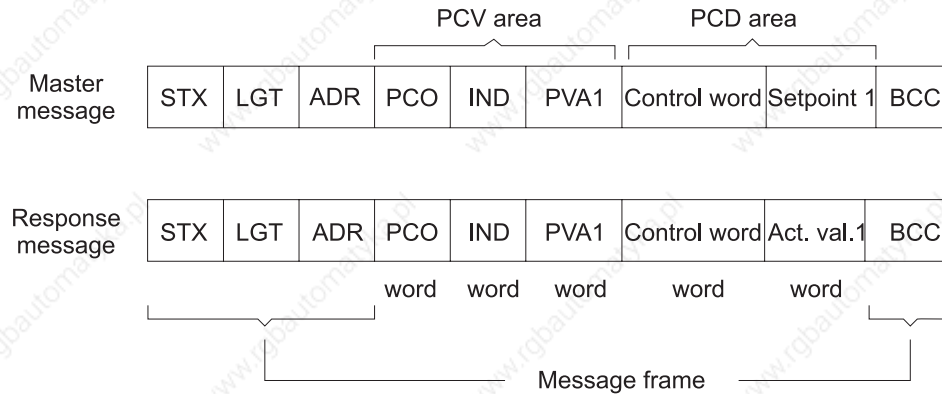
**Example 2:** PCV number = 0, PCD number = 3

Allows transmission of 1 and 2 setpoints and actual values. Does not allow parameterisation via PCV area.

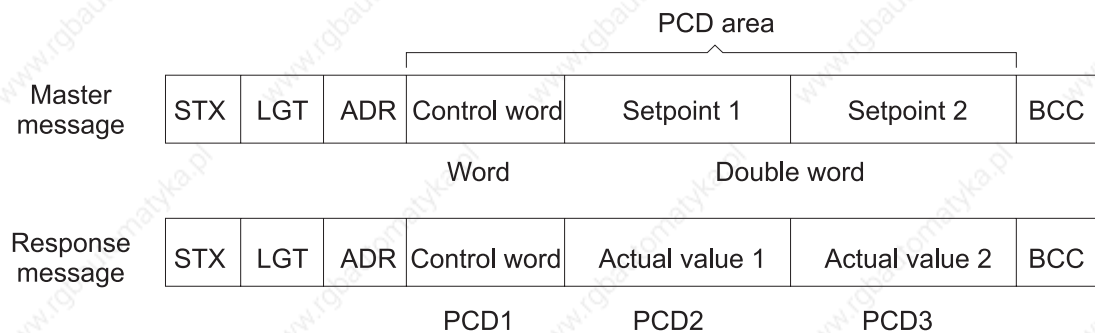
**Example 3:** PCV number = 4, PCD number = 0

Allows parameterisation of word and double word parameters. Does not allow setpoint specification and drive control.

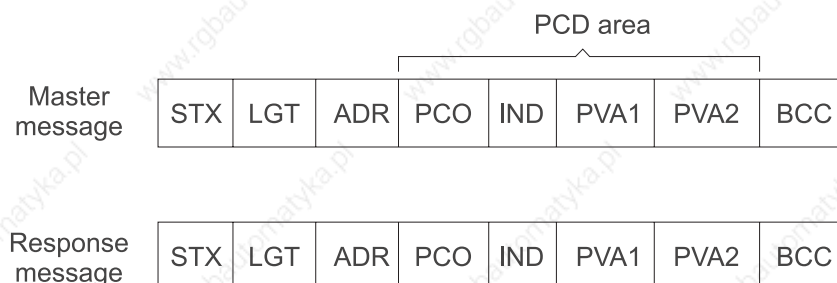



APPENDIX C - DECLARATION OF CONFORMITY/ MANUFACTURER UL-CERTIFICATION

C.1 Declaration of conformity

EG-Konformitätserklärung

Declaration of conformity

gemäß EG-Richtlinie 72/23/EG (Niederspannung) vom 19.02.1973
geändert durch: 93/68/EWG vom 22.07.1993

in accordance with EC directive 72/23/EG (low voltage) dated 19.02.1973
changed by: 93/68/EWG dated 22.07.1993

Stromrichtergerät / Converter

BKD 6/ ...7000 BKF 12/ 7000 (BKxXX / XXXX / XXX-XXX / X XX XX XX 0X)

Das obige Gerät wurde entwickelt und konstruiert sowie anschließend gefertigt in Übereinstimmung mit o.g. EG-Richtlinie und u.g. Normen in alleiniger Verantwortung von:
the unit specified above was developed and constructed as well as manufactured in accordance with the above mentioned directive and the standards mentioned below under liability of:

Baumüller Nürnberg GmbH, Ostendstr. 80 - 90, D-90482 Nürnberg

Berücksichtigte Normen - standards complied with:

Norm / standard	
EN 50178	Ausrüstung von Starkstromanlagen mit elektrischen Betriebsmitteln Electronic equipment for use in power installations
EN 60204-1	Sicherheit von Maschinen - Elektrische Ausrüstung von Maschinen Safety of machinery - Electrical equipment of machines
EN 60529	Schutzarten durch Gehäuse (IP Code) Degrees of protection provided by enclosures (IP Code)
HD 625.1 51	Isolationskoordination für elektrische Betriebsmittel in Niederspannungsanlagen Insulation coordination for equipment within low-voltage systems

Nürnberg, 12.04.2005

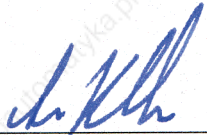

14/4/05

Andreas Baumüller
Geschäftsführer
Head Division



12.4.2005

ppa. Dr. Peter Heidrich
Entwicklungsleiter
Head of development

C.2 Declaration of manufacturer

EG-Herstellererklärung

Declaration of manufacturer

gemäß EG-Richtlinie 98/37/EG (Maschinen) vom 22.06.1998

geändert durch: 98/79/EG vom 27.10.1998

in accordance with EC directive 98/37/EG (machinery) dated 22.06.1998

changed by: 98/79/EC dated 27.10.1998

Stromrichtergerät / Converter

BKD 6/ ...7000 BKF 12/ 7000 (BKxXX / XXXX / XXX-XXX / X XX XX XX 0X)

Das obige Gerät wurde entwickelt und konstruiert sowie anschließend gefertigt in Übereinstimmung mit o.g. EG-Richtlinie und u.g. Normen in alleiniger Verantwortung von:

The unit specified above was developed and constructed as well as manufactured in accordance with the above mentioned directive and the standards mentioned below under liability of:

Baumüller Nürnberg GmbH, Ostendstr. 80 - 90, D-90482 Nürnberg

Berücksichtigte Normen - standards complied with:

Norm / standard

EN 60204-1	Sicherheit von Maschinen - Elektrische Ausrüstung von Maschinen Safety of machinery - Electrical equipment of machines
------------	---

In seiner Funktion als Sicherheitsbauteil garantieren wir folgende Sicherheitsfunktion des Gerätes - in its function as safety part we guaranty the following safety function of the unit:

Momentenfreischaltung des Antriebs - momentum disconnection of the drive

Die Inbetriebnahme der Maschine, in die dieses Gerät eingebaut wird, ist untersagt bis die Konformität der Maschine mit der obengenannte Richtlinie erklärt ist.

The machinery into which this unit is to be incorporated must not be put into service until the machinery has been declared in conformity with the provisions of the directive mentioned above.

Nürnberg, 12.04.2005

Andreas Baumüller
Geschäftsführer
Head Division



ppa. Dr. Peter Heidrich
Entwicklungsleiter
Head of development

C.3 UL-certification





UL is a mark of conformity, which is assigned from **Underwriters Laboratories Inc.** (www.ul.com), an American company. The UL-certification is not statutory regulated, but takes place voluntarily.

In order to be allowed to mark equipments and components with the UL-mark of conformity, tests must have to be done, which are attended and documented by an UL-inspector. Only if all necessary tests have been passed and regular product monitoring at the production process of the equipment or the components has been passed without objections, the UL-mark of conformity may be attached to the equipment under test.

Line filters of the company Baumüller Nürnberg GmbH are checked in accordance of the UL-standard UL 508C (UL-Standard for Safety for Power Conversion Equipment) and are recorded under the category control number NMMS. The product- and test description is recorded under file-no. E179860.

Only if all necessary tests have been completely carried out the -mark may be attached to the equipments or components. If single tests have not already taken place at the manufacturer's, but are carried out not until at the user's, then only the -mark may be attached.

With products of the Baumüller Nürnberg GmbH all tests are already completed at the UL-certification process, so that they may be marked with the -mark.

In case with the UL-certification process also standards of the CSA (**C**anadian **S**tandard **A**ssociation) are considered, then instead of the - or -mark the  or -mark may be attached to the product.

With products of the company Baumüller GmbH the CSA-standard Norm C 22.2 was considered, that's why they are marked with the -mark.

If products of Baumüller Nürnberg GmbH are mounted into an UL-certified installation, then certain application-, mounting- and installation notices must be considered, which are upon the functioning of the device. We have marked these notes in the manual with „UL 508C ...“. Only if you follow these notes and apply to them you may go by it, that the installation has been mounted UL-conform.

An UL-certification was only made for the units size I and II_x including the 650 A units

D

APPENDIX D - TECHNICAL DATA

D.1 Armature converter

Frequency (mains)	45 ... 65 Hz
Rated direct voltage (acc. to DIN 40030) BKF (4Q) BKD (1Q)	Connection voltage 400 V~ ¹⁾ 420 V 470 V
Rated direct voltage (acc. to DIN 40030) BKF (4Q) BKD (1Q)	Connection voltage 500 V~ ¹⁾ 520 V 600 V
Rated currents I _A size I	30 A, 50 A, 80 A, 100 A, 140 A, 200 A
Rated currents I _A size IIa	240 A (only BKF), 340 A
Rated currents I _A size IIb	450 A, 550 A, 650 A, 700 A
Rated currents I _A size IIc	BKD (1Q): 800 A, 950 A
Rated currents I _A size III ²⁾	BKD (1Q): 750 A, 920 A, 1100A BKF (4Q): 850A
Rated currents I _A size IV ²⁾	BKD (1Q): 1550 A, 1750 A, 2050 A BKF (4Q): 1250 A, 1400 A, 1650 A
Dynamic overload	1.2 x I _A for 20 ms using devices size I and size II
Setting range	0,5 .. 1,0 x I _A
Power supply unit connection voltage	340V~ ... 550V~
Operating temperature range Sizes I, IIa, IIb	For internal ventilation: up to 100 A converter 0...45 °C For external ventilation: up to 140 A converter 0...40 °C
Sizes III, IV	0...35 °C
At temperatures up to 55 °C	Rated direct current reduction of 1 % per °C
At H > 1000 m ams	Rated direct current reduction of 10 % per 1000 m
Storage and transport temperature	-30...+70 °C
Humidity rating acc. to DIN 40440	Sizes I, IIa, IIb : F Sizes III, IV : E
	IP 00

D.2 Field current converter

- 1) The specified rated direct voltage can no longer be reached if these rated connection voltages are fallen short of by more than 10%.
 2) Operating temperature range: 0 ... 35°C

Max. reachable output voltage of the converter (rectifier mode) in dependence on the mains voltage and the rectifier firing angle α_G (without paying regard to the commutation and pre-connected impedance):

$$U_{di\alpha_G} = \frac{3 \cdot \sqrt{2}}{\pi} \cdot U_{\text{mains}} \cdot \cos(\alpha_G)$$

with α_G = set value of parameter P 360

D.2 Field current converter

	340 V~... 550 V~
Frequency (mains)	45 ... 65 Hz
Rated direct voltage (acc. to DIN 40030)	Connection voltage 400 V~ ¹⁾ 310 V
Rated direct voltage (acc. to DIN 40030)	Connection voltage 500 V~ ¹⁾ 390 V ~
Rated direct current field I_E (dependent on the rated current I_A of the respective converter)	$I_A \leq 100 \text{ A} : 1,5 \text{ A} - 3 \text{ A} - 6 \text{ A} - 12 \text{ A}$ $I_A > 100 \text{ A} : 1,5 \text{ A} - 3 \text{ A} - 6 \text{ A} - 12 \text{ A} - 24 \text{ A}$
	0,2 .. 1,0 x I_A

- 1) The specified rated direct voltage can no longer be reached if these rated connection voltages are fallen short of by more than 10%.

Max. reachable output voltage of the field current converter (rectifier mode) in dependence on the mains voltage and the rectifier firing angle α_G (without paying regard to the commutation and pre-connected impedance):

$$U_{di\alpha_G} = \frac{2 \cdot \sqrt{2}}{\pi} \cdot U_{\text{mains}} \cdot \frac{1 + \cos(\alpha_G)}{2}$$

with α_G = set value of parameter P381

D.3 Converter ventilators

Converter	Number	Voltage	Frequency	Power	Current/ ventilator
140 A	2	230 V / 1~	50 Hz 60 Hz	19 W 18 W	0,12 A 0,11 A
200 A	2	230 V / 1~	50 Hz 60 Hz	19 W 18 W	0,12 A 0,11 A
240 A	1	230 V / 1~	50 Hz 60 Hz	40 W 42 W	0,25 A 0,26 A
340 A	1	230 V / 1~	50 Hz 60 Hz	40 W 42 W	0,25 A 0,26 A
450 A	1	230 V / 1~	50 Hz 60 Hz	190 W 200 W	0,84 A 0,88 A
550 A	1	230 V / 1~	50 Hz 60 Hz	190 W 200 W	0,84 A 0,88 A
650 A	1	230 V / 1~	50 Hz 60 Hz	190 W 200 W	0,84 A 0,88 A
700 A	1	230 V / 1~	50 Hz 60 Hz	190 W 200 W	0,84 A 0,88 A
750 A	1	230 V / 1~	50 Hz 60 Hz	140 W	0,62 A
800 A	1	230 V / 1~	50 Hz 60 Hz	190 W 200 W	0,84 A 0,88 A
850 A	1	230 V / 1~	50 Hz 60 Hz	140 W	0,62 A
920 A	1	230 V / 1~	50 Hz 60 Hz	140 W	0,62 A
950 A	1	230 V / 1~	50 Hz 60 Hz	190 W 200 W	0,84 A 0,88 A
1100 A	1	230 V / 1~	50 Hz 60 Hz	140 W	0,62 A
1250 A	1	400 V / 3~	50 Hz 60 Hz	550 W 790 W	1,20 A 1,45 A
1400 A	1	400 V / 3~	50 Hz 60 Hz	550 W 790 W	1,20 A 1,45 A
1550 A	1	400 V / 3~	50 Hz 60 Hz	550 W 790 W	1,20 A 1,45 A
1650 A	1	400 V / 3~	50 Hz 60 Hz	550 W 790 W	1,20 A 1,45 A
1750 A	1	400 V / 3~	50 Hz 60 Hz	550 W 790 W	1,20 A 1,45 A
2050 A	1	400 V / 3~	50 Hz 60 Hz	550 W 790 W	1,20 A 1,45 A

D.4 Type code

D.4 Type code

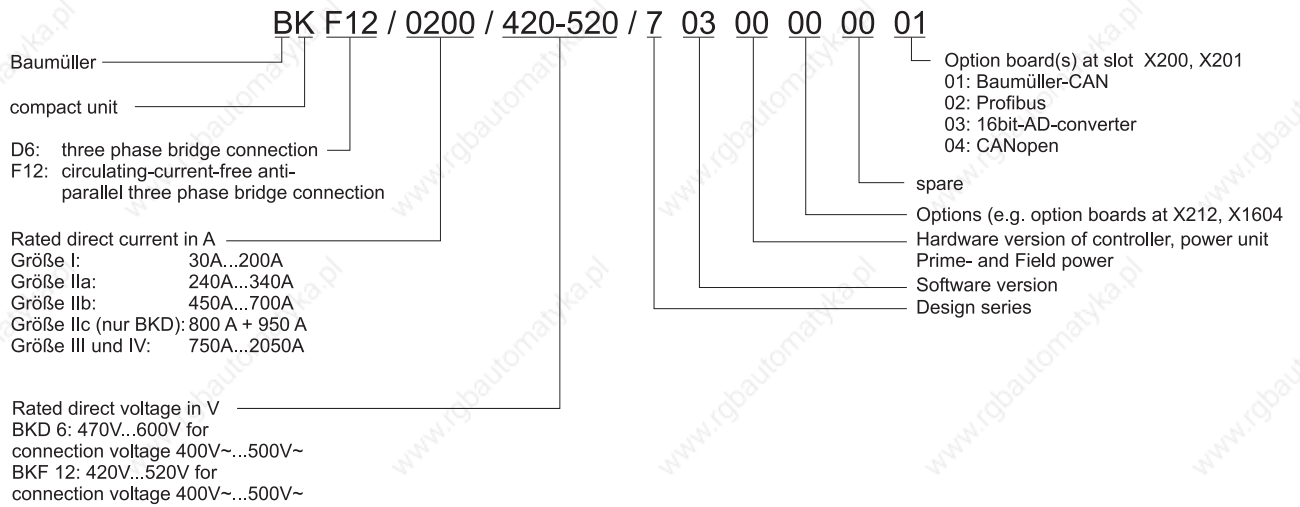



APPENDIX E - OPTION BOARD MOTOR TEMPERATURE MONITORING

An option board (3.0043) is available for motor temperature monitoring. Two independent measurement channels are implemented. The temperature sensor type KTY84 (PTC) must be used. Don't confuse the poles when connection the temperature sensor. The electrical connection to the controller board 3.9711D is done via a 20-pin cable. It connects the plug X212 of board 3.9711D and the plug X212 of board 3.0043.

E.1 Assumption



ATTENTION

This option board can only be used from controller board 3.9711D.

The setting parameter necessary for the temperature monitoring are available from software version 3.10.

Both plug-in jumpers W700 and W701 must be in position A-B.

E.2 Connecting the measurement sensors (LP 3.0043)

Measurement channel 1:

X8:1 Anode connection of temperature sensor (connection TM+ in motor connection box)

X8:2 Cathode connection of temperature sensor (connection TM- in motor connection box)

X8:3 Free ground connection (electronic ground)

Measurement channel 2:

X8:4 Anode connection of temperature sensor (connection TM+ in motor connection box))

X8:5 Cathode connection of temperature sensor (connection TM- in motor connection box)

X8:6 Free ground connection (electronic ground)

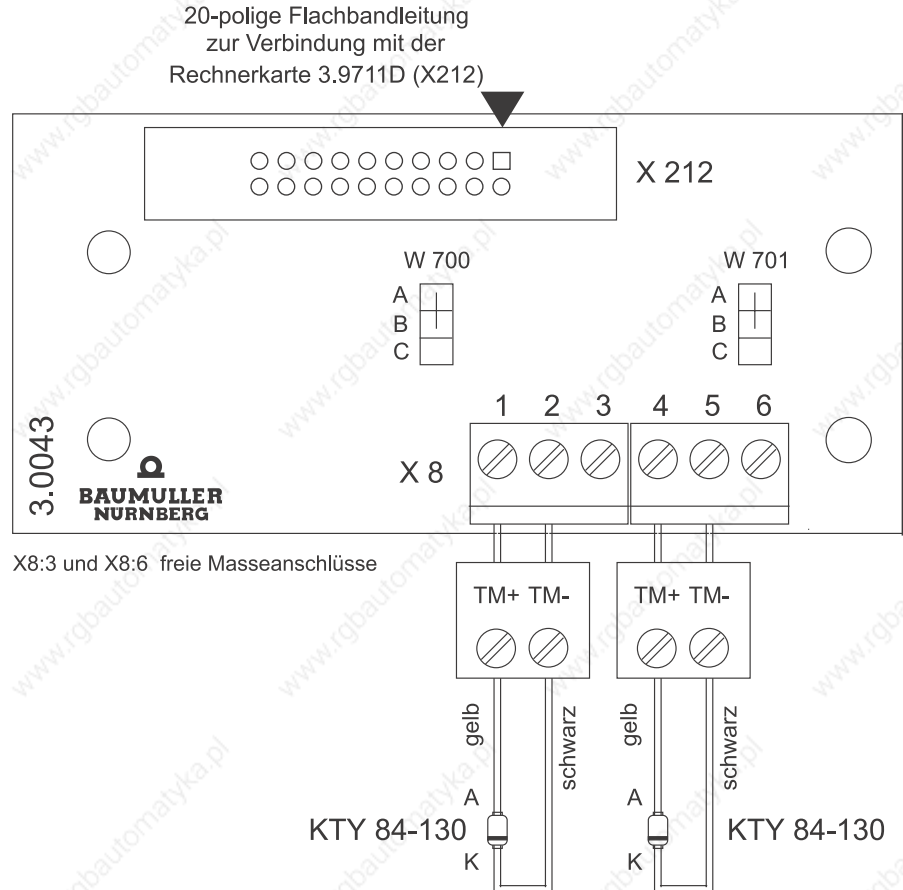

Illustration 86: Option board 3.0043 motor temperature monitoring

E.3 Temperature sensor

Use sensors type KTY 84-130 for temperature monitoring.

Note the direction of installation.

The cathode ring of measurement channel 1 must be connected with terminal X8:2!

The anode ring of measurement channel 2 must be connected with terminal X8:5!



CAUTION

When confusing the poles of the temperature sensor, the resistance of the sensor is decreased when the temperature is higher than 100 °C with further increasing temperature. The temperature monitoring of the motor is in this case above 100 °C inefficient.

If the connection between board 3.9711 and board 3.0043 is missing, an error message is generated in software version 3.14 and higher, when the temperature monitoring is activated (P 541 = 1 and / or P 544 = 1).



E.3.1 Connection of the option board

Connection of the option board for motor temperature monitoring

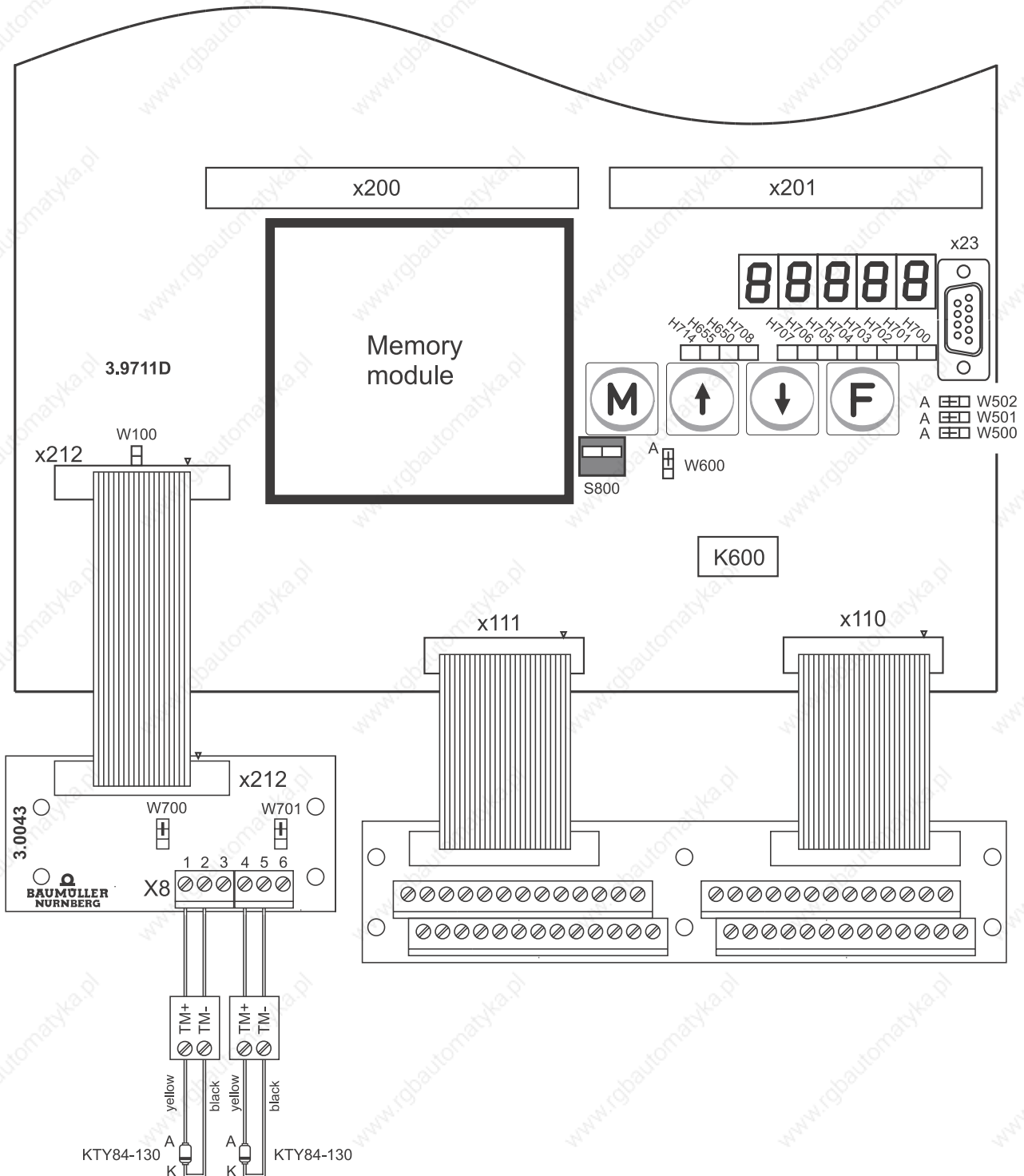

Illustration 87: Connection option board 3.0043





Index

A			
ALink	85		
Analog Link	85		
B			
BAPS interface	211		
C			
CCW rotating field	431		
Control word	75		
D			
Data record	58		
Declaration by Manufacturer	471		
Declaration of Conformity	471		
DEF selection parameter	94		
Digital Link	88		
Display	55		
switch on	55, 56		
Drive address	459		
E			
EEPROM	58		
empty	58		
erase	428		
Enable key pad	56		
Errors			
acknowledgeable	424		
Display	423		
List	424		
non-acknowledgeable	424		
F			
Fuse sizes	51		
H			
H700	57		
H714	57		
K			
Key pad	55		
L			
LED			
H700	57		
H714	57		
Overview	29, 30, 57		
LEDs	55, 57		
M			
MODE key	55		
N			
Net data block	459		
P			
Phase failure	431		
PKW area	459		
PZD area	459		
Q			
Quick stop			
Restart	83		
R			
Red LED			
ON	423		
Reset			
impossible	453		
S			
Semiconductor fuse, field	51		
Seven-segment display	55		
software update	428		
U			
UL-Zertifizierung	474		
update			
software	428		
USS protocol	457		
W			
Warning			
list	427		
Warning W 4	60		
Watchdog	57		
external	424, 432		
internal	425, 432		



Index

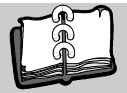

Table of illustrations

Dimensions, size 1	11
Dimensions, size 2	12
Dimensions controller and field supply, sizes III, IV	13
Dimensions power supply BKD 6, size III (750 A, 920 A)	14
Dimensions power unit BKD 6, size III (1100 A)	15
Dimensions power unit BKF 12, size III (850 A)	16
Dimensions power unit, size IV	17
Dimensions power connections, size IV	18
Dimensions connection angle bar, size IV	18
Location diagram, board 3.9711B	29
Location diagram, board 3.9711D	30
Location diagram, board 3.9712B	32
Connection diagram, analog inputs and outputs	33
Connection diagram, digital inputs and outputs	34
Connection diagram, RS 232 - RS 485 - incremental encoder	35
Connection, power unit BKD 6/ 7000, sizes I and II	36
Connection power unit BKF 12/ 7000, sizes I and II	37
Connection BKD 6 / 7000, size III (750 A, 920 A, 1100 A)	38
Connection BKD 6 / 7000, size IV (1550 A, 1750 A, 2050 A)	39
Connection BKF 12/ 7000, size III (850 A)	40
Connection BKF 12 / 7000, size IV (1250 A, 1400 A, 1650 A)	41
Field power unit BKx 7000 (board 3.9712)	48
Dimension drawing: Three-phase current mains chokes	52
Dimension drawing: Single-phase mains choke	53
Seven-segment display	55
Basic converter control; effects of enable signals	66
Converter control state diagram - without field bus connection	71
Converter control state diagram	73
Symbol for ALink selection	85
Symbol for DLink selection	88
Structure and parameterisation of an unassigned digital function block	91
Example of the basic digital output structure	92
Digital switching input 1	94
Function diagram - As-supplied converter configuration	101
Function diagram - Analog inputs 1 and 2	102
Function diagram - Analog inputs 3 and 4	103
Function diagram - Setpoints	104
Function diagram - Motorised potentiometer	105
Function diagram - Ramp generator A	106
Function diagram - Ramp generator B	107
Function diagram - Analog tachometer / armature voltage detection input	108
Function diagram - Incremental encoder 1	109
Function diagram - Speed controller	110
Function diagram - Current limitation	111
Function diagram - Current controller with reversing unit and power unit	112
Function diagram - Field unit EMF controller	113
Function diagram - Field unit, field current controller and field control unit	114
Function diagram - Digital inputs for Controller enable	115
Function diagram - Programmable digital inputs	116
Function diagram - Programmable digital outputs	117
Function diagram - Programmable analog outputs	118
Function diagram - Unassigned PI controller	119
Function diagram - Freely interconnectable adders	120
Function diagram - Freely interconnectable multipliers / dividers	121



Table of illustrations

Function diagram - Freely interconnectable function blocks 1.....	122
Function diagram - Freely interconnectable function blocks 2.....	123
Function diagram - Freely interconnectable changeover switches.....	124
Function diagram - Freely interconnectable comparator	125
Function diagram - Unassigned digital functions	126
Function diagram - Unassigned digital relations.....	127
Function diagram - Freely definable status word.....	128
Function diagram - Monitoring functions 1.....	129
Function diagram - Monitoring functions 3.....	130
Function diagram - Monitoring functions 4.....	131
Function diagram - Monitoring functions 5.....	132
Times of ramp generator A.....	231
K_P adaptation for the speed controller - Fig. 1.....	244
K_P adaptation for the speed controller - Fig. 2.....	244
T_n adaptation for the speed controller - Fig. 1	245
T_n adaptation for the speed controller - Fig. 2	246
Multiplier 1 and multiplier 2.....	258
K_P adaptation for the unassigned PI controller - Fig. 1.....	288
K_P adaptation for the unassigned PI controller - Fig. 2.....	288
K_P adaptation for the unassigned PI controller - Fig. 1.....	289
K_P adaptation for the unassigned PI controller - Fig. 2.....	290
Motor i^2t monitoring - Threshold to trip of is 100 %	412
Multiplier interconnection example	420
Message structure	457
2-wire and 4-wire mode (half-duplex)	458
Standard structure for parameter values as word size (PCV number = 3).....	461
Standard structure for parameter values as double word size (PCV number = 4)	461
Parameter code (PCO).....	461
Standard structure at 1 setpoint/actual value (PCD number = 2):	467
Standard structure at 2 setpoints/actual values (PCD number = 3):	467
Setpoints/actual values.....	467
Option board 3.0043 motor temperature monitoring.....	480
Connection option board 3.0043.....	481

be in motion

Baumüller Nürnberg GmbH Ostendstraße 80-90 90482 Nürnberg T: +49(0)911-5432-0 F: +49(0)911-5432-130 www.baumueller.de

All information given in this manual is customer information, subject to change without notice. We reserve the right to further develop and actualize our products continuously using our permanent revision service. Please notice, that specifications/data/information are current values according to the printing date. These statements are not legally binding according to the measurement, computation and calculations. Before you make any information given in this manual to the basis of your own calculations and/or applications, please make sure that you have the latest edition of the information in hand. No liability can be accepted concerning the correctness of the information.