

SIEMENS

SIMATIC HMI

OP7, OP17 Operator Panel

Equipment Manual

Preface, Contents

1
Part I Introduction **▽**
2

3
Part II Basic Functions **▽**
10

11
Part III Expanded, Configurable
Functions **▽**
13

14
Part IV Commissioning and
Description of Devices **▽**
16

A
Part V Appendix **▽**
F

Glossary, Index

6AV3991-1AE05-1AB0

Release 04/99

Safety Guidelines

This manual contains notices which you should observe to ensure your own personal safety, as well as to protect the product and connected equipment. These notices are highlighted in the manual by a warning triangle and are marked as follows according to the level of danger:



Warning

indicates that death, severe personal injury or substantial property damage **can** result if proper precautions are not taken.



Caution

indicates that minor personal injury or property damage can result if proper precautions are not taken.

Note

draws your attention to particularly important information on the product, handling the product, or to a particular part of the documentation.

Qualified Personnel

Equipment may be commissioned and operated only by **qualified personnel**. Qualified personnel within the meaning of the safety notices in this manual are persons who are authorized to commission, ground and identify equipment, systems and circuits in accordance with safety engineering standards.

Correct Usage

Note the following:



Warning

The equipment may be used only for the applications stipulated in the catalog and in the technical description and only in conjunction with other equipment and components recommended or approved by Siemens.

Startup must not take place until it is established that the machine, which is to accommodate this component, is in conformity with the guideline 89/392/EEC.

Faultless and safe operation of the product presupposes proper transportation, proper storage, erection and installation as well as careful operation and maintenance.

Trademarks

SIMATIC® is a registered trademark of Siemens AG.

Some of the other designations used in these documents are also registered trademarks; the owner's rights may be violated if they are used by third parties for their own purposes.

Impressum

Editor and Publisher: A&D PT1

Copyright © Siemens AG 1996 All rights reserved

The reproduction, transmission or use of this document or its contents is not permitted without express written authority. Offenders will be liable for damages. All rights, including rights created by patent grant or registration of a utility model or design, are reserved.

Siemens AG,
Automation & Drives
SIMATIC Human Machine Interface
Postfach 4848, D-90327 Nuernberg

Disclaimer of Liability

We have checked the contents of this manual for agreement with the hardware and software described. Since deviations cannot be precluded entirely, we cannot guarantee full agreement. However, the data in this manual are reviewed regularly and any necessary corrections included in subsequent editions. Suggestions for improvement are welcomed.

Technical data subject to change.
© Siemens AG 1996

Preface

Guide through the manual

The “OP7, OP17 Operator Panel” equipment manual is divided into five parts:

Part	Chapter	Contents
I	1 – 2	Overview of the OPs and their range of functions.
II	3 – 10	Step-by-step instructions on how you control the OPs with the standard screens.
III	11 – 13	Expanded functions of the OPs (online changes to system settings, PLC jobs and the scheduler).
IV	14 – 16	– Mechanical and electrical installation – Commissioning – Detailed information about the OPs and their maintenance
V	Appendix A – F	Contains general tables and a list of the technical terms used in this manual.

Conventions

The following conventions are used in this manual:

<i>Motor off</i>	Text on the display of the OP is shown in “typewriter” style.
<i>Variable</i>	Symbolic names representing variable values on the display are shown in italic “typewriter” style.
<i>Screens</i>	Functions which you can choose are shown in normal italics.
<i>Screens → Print</i>	Steps that are performed in succession are linked by an arrow.
ESC	The names of keys are shown in a different typeface.

History

The various editions of this equipment manual correspond to the following firmware and ProTool versions:

Edition	Remark	ProTool Version
09/96	First edition of the “OP7, OP17 Operator Panel” equipment manual	V 2.5 or higher
04/99	Technical revision	V5.01 or higher

Other support

In the case of technical queries, please contact your local Siemens in the subsidiaries and branches responsible for your area. Refer to Appendix F of this equipment manual for a list of addresses.

SIMATIC Customer Support Hotline

Available worldwide, at all times:

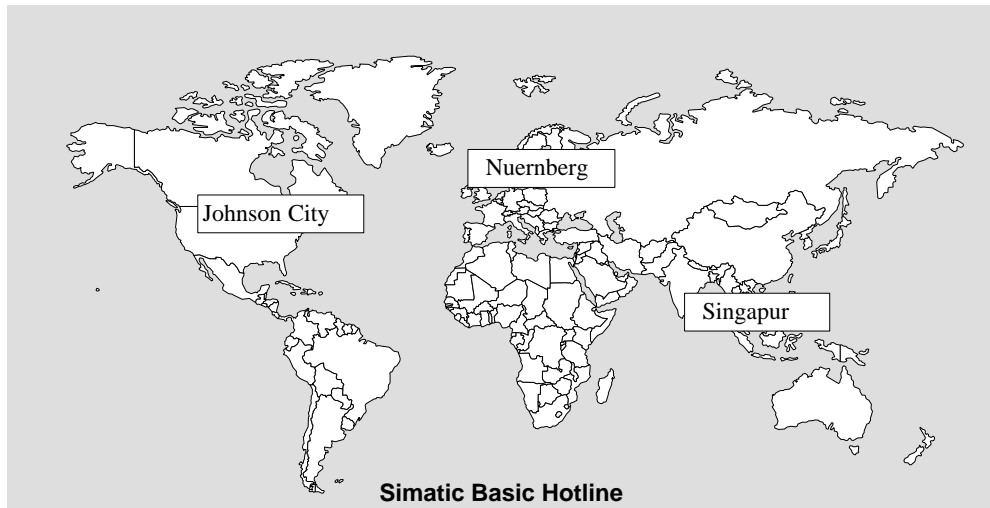

Nuernberg

SIMATIC BASIC Hotline

Local time:
Mon - Fri 8:00 to 18:00

Telephone:
+49 (911) 895-7000

Fax: +49 (911) 895-7002

E-Mail: simatic.support@nbgm.siemens.de

SIMATIC Premium Hotline

(charged, only with
SIMATIC Card)

Time:
Mon - Fri 0:00 to 24:00

Telephone:
+49 (911) 895-7777

Fax:
+49 (911) 895-7001

Johnson City

SIMATIC BASIC Hotline

Local time:
Mon - Fri 8:00 to 17:00

Telephone:
+1 423 461-2522

Fax: +1 423 461-2231

E-Mail: simatic.hotline@sea.siemens.com

Singapur

SIMATIC BASIC Hotline

Local time:
Mon - Fri 8:00 to 17:30

Telephone:
+65 740-7000

Fax: +65 740-7001

E-Mail: simatic@singnet.com.sg

SIMATIC Customer Online Services

SIMATIC Customer Support offers comprehensive additional information concerning SIMATIC products through its Online services as follows:

- Up-to-date general information is provided
 - in **Internet** under <http://www.ad.siemens.de/simatic>
 - via **Fax-Polling** under 08765-93 02 77 95 00
- Up-to-date product information and downloads for practical use can be found:
 - in **Internet** under <http://www.ad.siemens.de/support/html-00/>
 - via the **Bulletin Board System** (BBS) in Nürnberg (*SIMATIC Customer Support Mailbox*) under +49 (911) 895-7100

In order to contact the mailbox, please use a modem with up to 28.8 kBaud (V.34) capacity. Set the parameters as follows: 8, N, 1, ANSI, or dial for connection via ISDN (x.75, 64 kBit).

Abbreviations

The abbreviations used in this equipment manual have the following meanings:

AM	Alarm message
AS 511	Protocol of the PU interface to the SIMATIC S5
ASCII	American Standard Code für Information Interchange
CPU	Central Processing Unit
EEPROM	Electrically erasable programmable read-only memory
EM	Event message
FB	Function block
HMI	Human Machine Interface
IF	Interface designation
LCD	Liquid-crystal display
LED	Light-emitting diode
MPI	Multipoint Interface
OP	Operator Panel
PLC	Programmable Logic Controller
PPI	Point to Point Interface
PU	Programming Unit (German abbreviation: PG)
RAM	Random access memory (working memory)
TD	Text Display
TP	Touch Panel

Contents

Part I Introduction

1	Product Description	1-1
1.1	Configuration and process control phases	1-1
1.2	Visualizing and controlling processes	1-3
1.3	Design of Operator Panel OP7	1-6
1.4	Design of Operator Panel OP17	1-8
2	Functionality	2-1

Part II Basic Functions

3	General Operation	3-1
3.1	Integrated keyboard	3-1
3.1.1	System Keys	3-2
3.2	Entering Values	3-6
3.2.1	Entering Numerical Values	3-7
3.2.2	Entering Alphanumeric Values	3-8
3.2.3	Entering Symbolic Values	3-11
3.2.4	Entering Timer Values	3-12
3.3	Help Text	3-14
4	Using the OP with Its Standard Functions	4-1
4.1	Operating Levels	4-1
4.2	Standard Screens	4-3
4.3	Branching in Standard Screens	4-5
5	Screens	5-1
5.1	Screen Entries	5-2
5.2	Selecting Screens	5-3
5.3	Editing Screens	5-4
5.4	Printing Screens	5-4
6	Password Protection	6-1
6.1	Password Levels and Access	6-1
6.2	Logging-in and logging-out on the OP (LOGIN/LOGOUT)	6-3
6.3	Password Management	6-4

7	Messages	7-1
7.1	Message types	7-2
7.1.1	Event and alarm messages	7-2
7.1.2	Alarm messages	7-4
7.1.3	System messages	7-6
7.2	Displaying Messages	7-7
7.2.1	Display Sequences	7-8
7.2.2	Scrolling through Waiting Messages at Message Level	7-8
7.2.3	Viewing Event and Alarm Message Text	7-9
7.3	Message Buffers	7-10
7.4	Deleting Messages	7-12
7.4.1	Deleting alarm message and event message buffers upon buffer overflow	7-12
7.4.2	Deleting alarm and event messages via standard screens	7-13
7.4.3	Automatically Deleting the System Message Buffer upon Buffer Overflow	7-13
7.5	Printing Messages	7-14
7.5.1	Direct Message Logging	7-14
7.5.2	Printing the Message Buffer	7-15
8	Recipes	8-1
8.1	Creating and Editing Data Records	8-4
8.2	Copying Data Records	8-6
8.3	Transferring Data Records	8-7
8.4	Deleting Data Records	8-10
9	STATUS/FORCE VAR with the OP	9-1
9.1	FORCE VAR	9-2
10	System Settings	10-1
10.1	Selecting a Language	10-1
10.2	Modifying Parameters in Online Mode	10-2
10.3	Adjusting Contrast	10-4
10.4	Setting OP Modes	10-5

Part III Expanded, Configurable Functions

11	Process-Dependent Operator Guidance	11-1
11.1	Branching by Means of Soft Keys and Function Keys	11-1
11.2	Self-Defined Screen Hierarchy	11-3
12	Schedulers (OP17 only)	12-1
13	Controlling the OP from the PLC	13-1

Part IV Commissioning and Description of Devices

14	Installation	14-1
14.1	Mechanical Installation	14-2
14.2	Electrical Installation	14-3
14.2.1	Connecting the Power Supply	14-4
14.2.2	Connecting a Configuration Computer	14-5
14.2.3	Connections to PLC	14-6
14.2.4	Loop-Through Mode (OP17 only)	14-8
14.2.5	Connecting a Printer	14-9
15	Commissioning	15-1
15.1	Initial commissioning	15-3
15.2	Recommissioning	15-4
15.3	Start-up Behavior	15-5
15.4	Testing the Configuration in OFFLINE Mode	15-6
15.5	Testing the Configuration in Conjunction with the PLC	15-7
15.6	Testing Communication via the PROFIBUS-DP	15-8
16	Device Description	16-1
16.1	OP7	16-1
16.2	OP17	16-3
16.3	Labeling of the Function Keys	16-5
16.4	Optional Backup Battery for the OP17	16-8
16.5	Maintenance	16-9

Part V Appendix

A	Brief Description of Standard Screens	A-1
B	System Messages	B-1
C	Technical Data	C-1
D	Interface Assignment	D-1
E	SIMATIC HMI Documentation	E-1
F	Siemens Worldwide	F-1

Part I Introduction

Product Description

1

Functionality

2

Product Description

1

Applications of OP7 and OP17

Operator Panels OP7 and OP17 allow operating states, current process values and malfunctions of a connected PLC to be visualized. In addition, inputs can be made on the OP which can be written directly to the PLC. Some functions relating to machine diagnostics can also be executed on the Operator Panel.

The Operator Panels feature a number of standard functions. The displays and operation of the devices can be optimized by the configurer to meet the requirements of the process.

The Operator Panels are suitable for fitting into switching cabinets and control desks. A printer can be attached to the OP for logging processes during automation operation.

1.1 Configuration and process control phases

Creating data areas

Before an OP can go into service, it has to be prepared for its job of visualizing data from the PLC, i.e. it has to be configured. As far as the PLC is concerned, data areas used by the OP to communicate with the PLC have to be created in the memory.

Configuration with ProTool

The configuration for the OP is created on a computer (PC/PU) using ProTool configuration software under Microsoft® Windows™. When the configuration is ready, it is transferred to the OP. Before this can be done, however, the computer has to be connected to the Operator Panel. Following transfer of the configuration, the OP has to be connected to the PLC.

The OP now communicates with the PLC and reacts to program flows on the PLC on the basis of the configured requirements.

figure 1-1 depicts the configuration and process control phases described above:

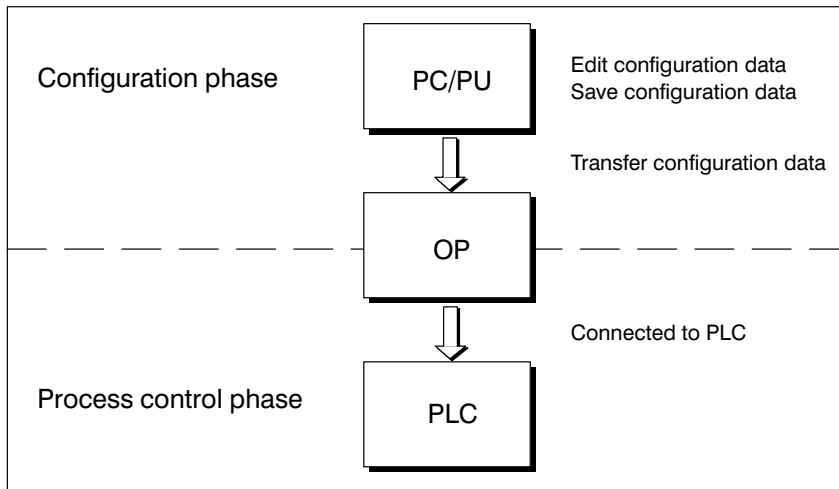

Figure 1-1 Configuration and Process Control Phase

Static and variable text components

Text which is required to be displayed on the OP has first to be created on the PC/PU with ProTool and then transferred to the OP. If, for example, text for display is required to comprise static and variable components, the tags have to be configured and the static text for explaining the tags has to be entered - for example:

Temperature *Variable1* °C of Furnace1

Here, Temperature °C of Furnace1 is the static text and *Variable1* is the tag that is read from the memory area of the PLC.

Further information

You will find information on configuring the OP in the *ProTool/Lite User's Guide*. The *Communication User's Guide* provides information on connecting the OP to the PLC.

1.2 Visualizing and controlling processes

Display and control functions

The basic functions of an OP consist in displaying process states and in controlling the process. The following display and control functions can be configured on Operator Panels OP7 and OP17:

- screens
- event messages
- alarm messages
- recipes
- help text
- logging
- languages
- schedulers for the OP17

Screens

Data supplied by the PLC may be displayed together on a screen and modified individually, if required. A screen consists of several screen entries since, for example, more related data are required for describing a machine state than can normally be displayed in the window of a screen. Therefore data on operating temperature, fill level, speed and running time can illustrate the current machine state.

The OP7 and OP17 are Operator Panels with text based displays. Accordingly, a screen on the display comprises text items which may include static text and current state values.

Screens may be combined on the OP in a directory. You can use the directory to display, print and edit screens.

Event messages

Event messages are information and operating notes on current machine and process states during regular production operations. Event messages may contain process values. Process values are displayed either numerically - for example,

Motor running at 3000 revs

or symbolically - for example,

Motor running normally,

where a specific control value is assigned to normally.

The classification of a message as an event message is done at the configuration stage.

Alarm messages

Alarm messages show, in contrast to event messages, critical machine states during production operations. Due to their urgency, they have to be acknowledged before any other action is possible.

Alarm messages may contain process values. Process values are displayed either numerically - for example

Motor speed 4500

or symbolically - for example

Motor speed too high,

where a specific control value is assigned to too high.

This type of message has a higher display priority than an event message. If an alarm message is issued, any event message or screen that is being displayed is replaced with a flashing alarm on the display.

The classification of a message as an alarm message is made at the configuration stage.

Recipes

When a product is made up of various ingredients in certain ratios, this information is stored in a so-called recipe.

Take orange juice for example. Its production and bottling requires that orange concentrate and water be mixed in a certain ratio. These values are stored as tags in a recipe.

Each recipe can be made up of several data records containing different values for the recipe.

The data can be edited in the OP, transferred to the PLC and read out from the PLC.

In the OP, the recipes are combined by recipe number and title in a recipe directory.

Help text

Help text consists of configurable additional information and operator instructions relating to event messages, alarm messages and screens. If for example an alarm message arises, this enables additional information on how to eliminate faults to be displayed.

Help text can also be displayed by pressing a key, if required, when the HELP LED is on.

Logging

Messages can be printed in online mode by means of the printer connected to the OP. Furthermore, there is a possibility of printing all the event and alarm messages that have accumulated in the buffer concerned.

Multilinguality

Message text, screens, help text and system messages may be displayed in several languages. Up to three of the languages listed below can be loaded simultaneously on the same OP and presented to the operator for selection on line:

- German
- English
- French
- Italian
- Spanish
- Russian (Cyrillic characters).

Schedulers

A scheduler is a regularly recurring point in time (i.e., hourly, daily, weekly, annually) at which a certain function is to be executed. When a scheduler time is reached, the configured bit is set in the interface area of the PLC and the configured function is executed.

The following functions are available:

- Print alarm message buffer
- Print event message buffer
- Select screen
- Print screen
- Print data record

1.3 Design of Operator Panel OP7

OP7 versions

The OP7 has a plastic housing with a touch-sensitive front and is therefore suitable for ungrounded installation. The coloring of the front foil conforms with machinery directive EN 60204.

The OP7 is available in the following versions:

- OP7/PP,
- OP7/DP and
- OP7/DP-12.

The versions differ only in their communication options. figure 1-2 shows the design of Operator Panel OP7.

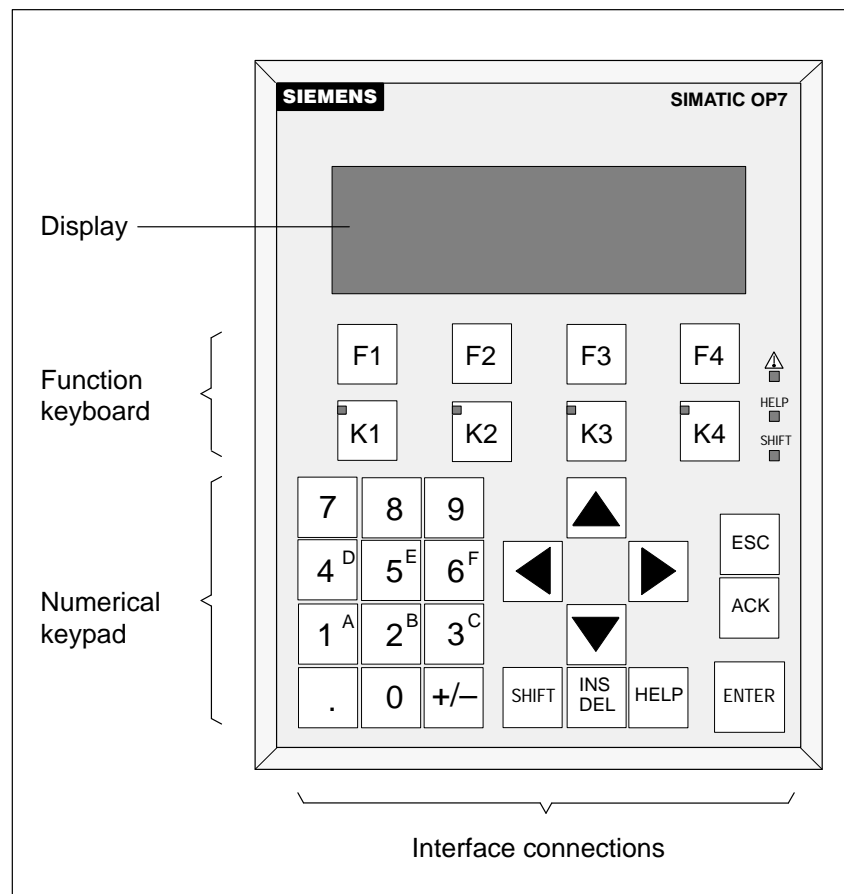

Figure 1-2 Design of Operator Panel OP7

LCD	High-contrast LC display with LED back-lighting. Display of up to 4 lines each having a maximum length of 20 characters; the height of the characters is 8 mm.
Function keyboard	8 keys (F1 to F4 and K1 to K4) for calling freely programmable, generally valid standard functions. The green LEDs embedded in keys K1 to K4 can be driven by the PLC.
Soft keys	All eight function keys may alternatively be configured as soft keys. Each of these keys can be configured with different functions for the various screens.
System keyboard	22 keys for calling universally valid, standard functions (keypad, arrow keys, etc.).
Data buffer	The OP7 operates without a battery and is therefore maintenance-free. Operating data are retained in a non-volatile state in the flash memory on the OP.
Interfaces	<ul style="list-style-type: none"> • 1 x RS232/TTY for connecting to the PLC/computer/printer • 1 x RS422/485 for connecting to the PLC/computer
Fuse	Maintenance-free electronic fuse.
Compatibility	The OP7 is upwards compatible with the OP5. All cabling can be continue to be used. Existing OP5 configurations can be converted automatically for the OP7 by means of the ProTool configuration software.

1.4 Design of Operator Panel OP17

OP17 versions

The OP17 has a plastic housing with a touch-sensitive front and is therefore suitable for ungrounded installation. The coloring of the front foil conforms with machinery directive EN 60204.

The OP17 is available in the following versions:

- OP17/PP,
- OP17/DP and
- OP17/DP-12.

The versions differ only in their communication options. Figure 1-3 shows the design of Operator Panel OP17.

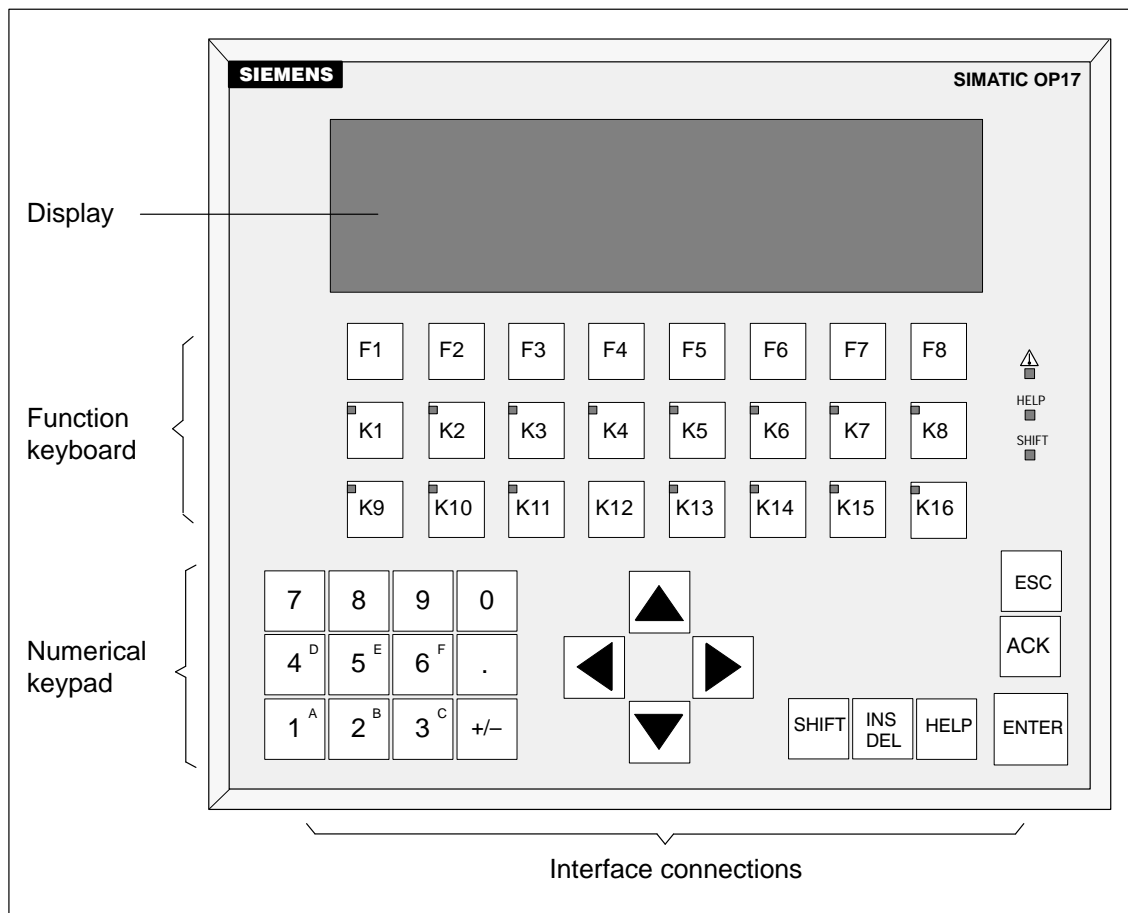

Figure 1-3 Design of the OP17

LCD	<p>High-contrast LC display with LED back-lighting. The following displays can be configured:</p> <ul style="list-style-type: none"> • 4 lines each of 20 characters; height of characters is 11 mm • 8 lines each of 40 characters; height of characters is 6 mm.
Function keyboard	<p>24 keys (F1 to F8 and K1 to K16) for calling freely configurable functions. The two-color LEDs (red/green) embedded in keys K1 to K16 can be driven by the PLC.</p>
Softkeys	<p>16 function keys (F1 to F8 and K1 to K8) can be used as function keys too. Soft keys can be configured with functions which vary from screen to screen.</p>
System keyboard	<p>22 keys for calling universally valid, standard functions (keypad, arrow keys, etc.).</p>
Data buffer	<p>The OP7 operates without a battery and is therefore maintenance-free. Operating data are retained in a non-volatile state in the flash memory on the OP. The message buffer is backed up for several hours after the power supply is turned off.</p> <p>The internal hardware clock has reserve power for several days after the power supply is turned off.</p> <p>The OP17 can be optionally upgraded with a lithium battery. The battery is not supplied with OP as a standard component.</p>
Interfaces	<ul style="list-style-type: none"> • 1 x RS232/TTY active, for connecting to the PLC/computer/printer • 1 x RS232/TTY passive, for connecting to the PLC/computer/printer • 1 x RS422/485 for connecting to the PLC/computer
Fuse	<p>Maintenance-free electronic fuse.</p>
Compatibility	<p>The OP17 is upwards compatible with the OP15/C. All cabling can be continue to be used. Existing OP15/C configurations can be converted automatically for the OP17 by means of the ProTool configuration software.</p>

Functionality

table 2-1 below summarizes the range of functions of Operator Panels OP7 and OP17. The values quoted are the maximum values that can be managed by the OP.

Table 2-1 Functionality of OP7 and OP17

Function		OP7	OP17
Event messages	Number	499	999
	Length (characters)	80	
	Display	✓	
	Print	✓	
	Display event message texts	✓	
	Number of entries in event message buffer	256	
	Display event message buffer	✓	
	Print event message buffer	✓	
	Delete event message buffer	✓	
Alarm messages	Number	499	999
	Length (characters)	80	
	Display	✓	
	Print	✓	
	Display alarm message texts	✓	
	Number of entries in alarm message buffer	256	
	Display alarm message buffer	✓	
	Print alarm message buffer	✓	
	Delete alarm message buffer	✓	
Message acquisition	Time of occurrence	Date, Time	
	Message event	Arrive, Depart, Acknowledged	
Tag input	Digits or letters	✓	
	By means of symbolic tags	✓	
Actual-value display	Numerical and symbolic	✓	
Combined actual-value display/set-point entry		✓	
Limit monitoring	On inputs by operator	✓	

Table 2-1 Functionality of OP7 and OP17, continued

Function		OP7	OP17
Password protection	Number of passwords	50	
	Password levels	9 (1..9)	
Screens	Number	99	
	Display	✓	
	Print	✓	
	Screen entries per screen	99	
	Number of fields per screen	300	
	Number of fields per screen entry	32	
Recipes	Number	99	
	Display	✓	
	Print	✓	
	Recipe entries per recipe	99	
	Recipe memory size (kbytes)	4	20
	Data records per recipe	99	
	Store/retrieve data record in/from OP	✓	
Help text	Length (characters)	320	
Schedule times		–	48
Function keys	Number	8	24
	Of which can be configured as soft keys	8	16
	Integrated LEDs	4	16
Reports		✓	
Diagnostics function	STATUS/FORCE VAR	✓	
Loop-through operation for configuration computer		✓	
Configurable OP languages		German, English, French, Italian, Spanish, Russian (Cyrillic characters)	
Online language change	Number of languages	3	

Table 2-1 Functionality of OP7 and OP17, continued

Function		OP7	OP17
Communication	SIMATIC S5 – AS511 – FAP – PROFIBUS-DP up to 1.5 Mbaud – PROFIBUS-DP up to 12 Mbaud		PP, DP-12 PP, DP-12 DP, DP-12 DP-12
	SIMATIC S7/M7 – PPI – MPI – PROFIBUS-DP up to 1.5 Mbaud – PROFIBUS-DP up to 12 Mbaud		DP, DP-12 DP, DP-12 DP, DP-12 DP-12
	SIMATIC 500/505 – NITP		PP, DP-12
	Loadable NATIVE drivers (separat bestellbar) – Allen-Bradley (DF1) – AEG/Modicon (Modbus) – Mitsubishi (FX) – Telemecanique (Adjust and Uni-Telway)		PP, DP-12 PP, DP-12 PP, DP-12 PP, DP-12

Time response of data updating

With the OP7 and the OP17, updated and newly created data are stored in a non-volatile flash memory. This means that current data are immediately available following an OP re-start.

The flash memory cannot be accessed while data are being updated, and the OP cannot be operated. The update rate is determined by the time response of the delete and write cycles of the flash memory. For technological reasons, this rate is slower than the access time for volatile memories.

A system message is output to the OP while data updating is in progress.

Part II Basic Functions

General Operation	3
Using the OP with Its Standard Functions	4
Screens	5
Password Protection	6
Messages	7
Recipes	8
STATUS/FORCE VAR with the OP	9
System Settings	10

General Operation

3.1 Integrated keyboard

Keypads

The OP7 and OP17 operator panels are controlled via the keyboard.. The keyboard of the OPs consists of two functional blocks:

- System keys (Numeric keypad and control keys)
- Function keys

figure 3-1 shows the keyboard of the OP7, by way of an example.

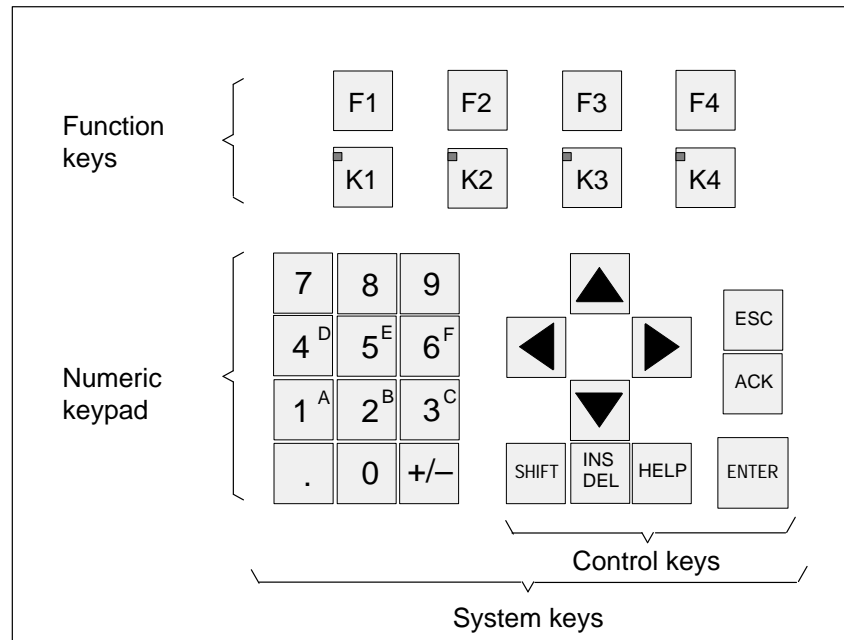

Figure 3-1 Keyboard of the OP7

Note

Simultaneous pressing of more than one key may result, among other things, in erroneous input.

3.1.1 System Keys

Function keys for global function assignment

A “function key for global function assignment” always activates the same action on the OP or in the PLC irrespective of the screen currently displayed (global meaning on the OP). Examples of such actions include:

- Opening a screen
- Starting a screen printout (Print Screen)

The following keys can be assigned global functions:

- **OP7:** F1 to F4 and K1 to K4,
- **OP17:** F1 to F8 and K1 to K16.

Function keys for local function assignment (soft keys)

A “function key for local function assignment” or “soft key” has a screen-specific (local) meaning.

The function of soft key can differ from screen to screen.

The following keys can be assigned local functions:

- **OP7:** F1 to F4 and K1 to K4,
- **OP17:** F1 to F8 and K1 to K8.

Two-tier soft keys are particularly suitable for implementing binary states and machine functions – for example:

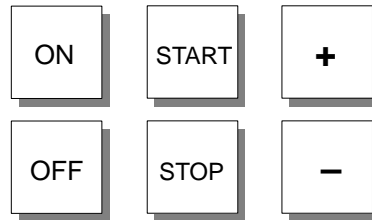







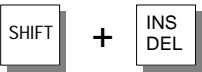

System keys

The system keys are used to make inputs on the OP. They are divided up into input keys for numerical and alphanumeric characters (numeric keypad) and control keys (see Figure 3-1).

Key functions





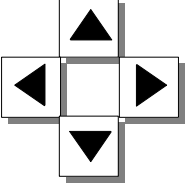









The system keys of the OPs have the following functions:

Key	Function	Purpose
	Shift	<p>Enable the second function of dual-assignment keys – for example, shift of numeric keys 1 to 6 for inserting characters A to F or switching from DELETE mode to INSERT mode.</p> <p>The enabled SHIFT key is indicated by the SHIFT LED. The second function of a dual-assignment key can then be called.</p> <p>The SHIFT LED is located on the right of the function keys.</p>
	Delete	<p>When entering values in a field with <i>string</i> format, the character located at the current position of the cursor is deleted. All subsequent characters are moved one position to the left.</p>
	Insert	<p>When entering values in a field with <i>string</i> format, a space (blank) is inserted at the current position of the cursor. All subsequent characters are moved one position to the right.</p>
	Display Help text (Help)	<p>If the HELP LED linked with this key comes on, you can open a context-sensitive Help text specifically about the screen currently displayed (see chapter 3.3).</p> <p>The HELP LED is located on the right of the function keyboard.</p>
	Enter	<p>Enter and terminate your input. This means that, among other things, you also change from message level to screen level.</p>
	Acknowledge	<p>Acknowledge alarm messages. The ACK LED</p> <ul style="list-style-type: none"> • is on, when at least one unacknowledged alarm message is present, • flashes, when only acknowledged alarm messages are still queued. <p>The ACK-LED (icon ) is located on the right of the function keys.</p>

Key	Function	Purpose
	Escape	<p>The ESC key has the following functions:</p> <ul style="list-style-type: none"> • Cancel Cancel field inputs provided that they have not been terminated by pressing  • Branch backward Within a screen, you branch back to the configured cross-jump destination (by default, the last position called) and, finally, from the start screen to the message level. • Hide system message Hide a non-serious system message. • Cancel display of help text Cancel the display of help text to return to the previous display. • Reset while scrolling through messages Cancel scrolling through messages to reset the display to the current message. • Cancel Download mode Cancel Download mode as long as data are not being downloaded to the OP. The OP acknowledges the abort by issuing a system message.
	Move cursor	<p>Depending on the operating situation, the cursor is moved one character, field, entry or display to the left, right, up or down.</p> <p>The arrow keys have a repetitive function, i.e. if you keep a key pressed, your input is repeated after a short delay until you release the key.</p>





Key combinations

The table below shows key combinations that can be used to activate functions from the OP.

Keys	Function	Purpose
 + 	Adjust contrast	Adjusting the contrast of the display.
 +    	Scrolling in symbolic lists	Scrolling in symbolic lists and calling of the extended character set (see chapters 3.2.2 and 3.2.3).
 	Inhibit alarm messages	
  	Download	<p>Loading of firmware and configuration is aborted and the system switches to Download mode.</p> <p>It is possible to quit Download mode provided data are not being downloaded from the PC or PU to the OP.</p>
  	Overall Reset	With this key combination, you erase the configuration memory when turning on the OP's power supply.

3.2 Entering Values

General procedure In input fields, values can be entered on the OP and transferred to the PLC. To do this, proceed as follows:

Step	Procedure
1	Branch, as described in section 4.3, initially to the screen you require and then to the corresponding screen entry.
2	Using the arrow keys, select the input field you require within the screen entry.
3	<p>Then enter your value. Depending on how the field has been configured, values may be input as</p> <ul style="list-style-type: none"> • numerical values (see chapter 3.2.1) • alphanumeric values (see chapter 3.2.2) • symbolic values (see chapter 3.2.3) • timer values (see chapter 3.2.4)
4	<p>Confirm your input with </p> <p>You can cancel any incorrect input by pressing </p> <p>The original value is then automatically reinserted in the field. Insert the correct value and then enter the corrected value by pressing </p>
5	<p>Position the cursor in the next input field, insert the next value etc.</p> <p>You can also use the arrow keys to move the cursor to the left or right to the previous input field to insert a different value in it.</p>
6	Close the screen. 



3.2.1 Entering Numerical Values

Entering via system keys

You enter numerical values character-by-character (digit-by-digit) via the input keys of the system keyboard. If the field already contains a value, this entire value is deleted from the field as soon as you enter the first new character. Once you have begun entering a value, you can no longer quit this field until you have confirmed or canceled your input.

Possible values

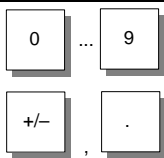
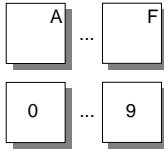

The following values can be entered in numerical input fields:

Possible values	Keys	Description
Decimal value		The input keys of the system keypad belong to the numerical key assignment.
Hex value		To enter characters A...F, the input keys must be switched over to the alphanumeric key assignment.
Digital value		The input keys belong to the numerical key assignment.

Right-justified input

In numerical fields, input initially is normally right-justified. Digits that have already been entered are moved to the left (pocket calculator format).

Exception:

Input fields for tags in KM format – for instance, when calling the functions Status/Force Var – are changed to left-justified. When input begins, the old value does not disappear from the display completely but its bit pattern is overwritten one character at a time. You move the cursor in this type of field by pressing  or  with activated Shift Lock mode.

Limit-value check

You can configure **limit values** for numerical input fields. In this type of field, a limit-value check takes place, i.e. the entered values are applied only if they lie within the configured limits. If a value outside these limits is entered, a system message is displayed and, after it has been canceled, the old value is restored in the field.

Decimal places

If a numerical field has been configured with a certain number of **decimal places** and too many have been entered, they are ignored; if too few have been entered, the field is padded with zeroes.

3.2.2 Entering Alphanumeric Values

Mixed input of digits and letters

Entering alphanumeric values consists of entering both digits and letters. If the field already contains a value, this entire value is deleted from the field as soon as you enter the first new character. Once you have begun entering a value, you can no longer quit this field until you have confirmed or aborted your input.

Entering A to F characters















A to F characters can be entered directly with activated Shift Lock mode using numeric keys 1 to 6.



Extended character set

If the characters available on the keypad are not sufficient for the alphanumeric input, you can select additional letters and special characters from the extended character set. The extended character set is available for all fields with the String representation.

Entering the characters

You enter the characters as follows:

Step	Keys	Description
1	Enter digits  ...   , 	If necessary, press the Shift key beforehand to switch back from the alphanumeric to the numerical key assignment. The Shift LED goes out. 
	Enter letters A to F   ... 	Switch to the alphanumeric key assignment. The Shift LED comes on. If you enter several letters consecutively, the Shift Lock setting remains activated and you move the cursor by means of the cursor control keys illustrated here.  
	Enter characters from the extended character set   	Switch to the alphanumeric key assignment. The Shift LED comes on. Select the desired characters from the extended character set. If you enter several letters consecutively, the Shift Lock setting remains activated and you move the cursor by means of the cursor control keys illustrated here.  





Step	Keys	Description	
2	Apply input or		<ul style="list-style-type: none"> The input becomes valid. The keypad switches back from the alphanumeric to the numeric key assignment. The input cursor is deleted. The keypad switches back from the alphanumeric to the numeric key assignment. The “old” input becomes valid again.
	cancel input		



Left-aligned input

Inputs in alphanumeric fields begin at the left edge, i.e. they are left-aligned. Each time you enter a character, the cursor is moved one position to the right. If the maximum possible number of characters is exceeded, the OP overwrites the last character with each additional input.

Correcting input











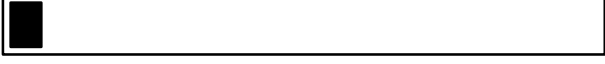

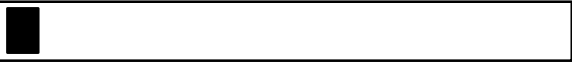



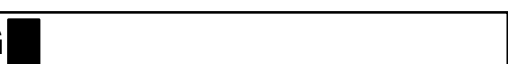

If you have made a mistake when entering characters in a field, the following options are available for making corrections before you apply the input.

Incorrect input	Remedy	Using keys
Character incorrect	<p>Switch to the alphanumeric key assignment. The Shift LED comes on.</p> <p>Move the cursor to the incorrect character.</p> <p>Enter A...F or characters from the extended character set</p> <p>or</p> <p>switch to the numeric key assignment (the Shift LED goes out) and enter a digit.</p>	  ,  

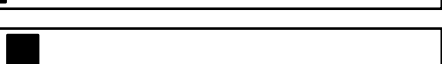
Incorrect input	Remedy	Using keys
Character too many	With the keypad set to the numerical key assignment, delete the character at the cursor position. The gap that arises is closed through the characters being moved from right to left.	
Character too few	Switch to the alphanumeric key assignment. The Shift LED comes on. Insert a space at the cursor position. The existing input starting from the cursor position is moved to the right. Overwrite the space.	 

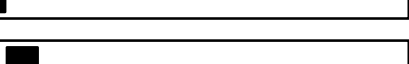
Example of an alphanumeric input

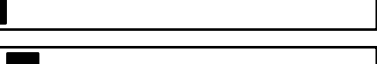



You want to enter “Fig. 05”. You do so by carrying out the following steps.

Key	Display
	
	F 
 , 	F I 
 , 	F I G 
	F I G. 
 , 	F I G. 
 , 	F I G. 0 
	F I G. 0 5 
	Apply input

3.2.3 Entering Symbolic Values

Text instead of a value

When you enter a symbolic value, text is displayed instead of the value. If a field has to be filled by entering symbolic values, take the value from a list of options. To do so, proceed as follows:

Step	Keys	Description
1	Activate selection list 	The Shift LED comes on. The selection list with the configured symbolic inputs is activated.
2	Select input  	Move cursor line by line.
3	Apply input or cancel input  	<ul style="list-style-type: none"> • The value that belongs to the selected input becomes valid. • The selection list is deactivated. • The “old” value becomes valid again. • The selection list is deactivated.

3.2.4 Entering Timer Values

Entering via system keys

You enter timer values character-by-character (digit-by-digit) via the input keys of the system keyboard. If the field already contains a value, this entire value is deleted from the field as soon as you enter the first new character. Once you have begun entering a value, you can no longer quit this field until you have confirmed or canceled your input.

Possible values

The following values can be entered in input fields used to display timers:

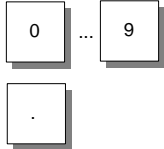
Possible values	Keys	Description
Decimal value	 The diagram shows a grid of keys. The top row contains keys for digits 0, an ellipsis (...), and 9. The bottom row contains a key for a decimal point (.).	The input keys of the system keypad belong to the numerical key assignment.

Right-aligned input

Inputs in fields used to display timers usually begin at the right edge, i.e. they are right-aligned. Digits entered are moved to the left (pocket calculator format).

Limit check

Limits can be configured for input fields used to display timers. A limit check is performed in these fields. The values entered are only applied if they are within the limits configured. If a value is entered that is not within these limits, a system message is displayed. After you have canceled this message, the old input value is re-entered in the field.

Digits to the right of the decimal point (with S7-200)

If a field used to display a timer has been configured with a specific number of **digits to the right of the decimal point**, excess digits to the right of the decimal point are ignored and digit spaces that have not been used are zero-filled after you confirm your input.

Entering a timer value

A timer can be assigned a start value by means of an input field. These values must be entered in a specific manner depending on the PLC being used. Proceed as follows:

- SIMATIC S5 and SIMATIC S7-300/400

You enter the value for the timer in seconds. You select the time base of the timer depending on the range of values in which the value entered is and on how many digits have been entered to the right of the decimal point of the value.

Range of values	Max. permissible number of digits to right of decimal point	Time base (dep. on number of digits to right of decimal point)	Input example
1000 s – 9990 s	0	10 s (0)	1960 (s)
100 s – 999 s	0	1 s (0)	179 (s)
10.0 s – 99.9 s	1	100 ms (1) 1 s (0)	78.5 (s) 78 (s)
0.01 s – 9.99 s	2	10 ms (2) 100 ms (1) 1 s (0)	9.54 (s) 9.5 (s) 9 (s)

- SIMATIC S7-200

The time base is set automatically in the PLC program as soon as the timer is selected. The program always operates with a timer value in milliseconds.

You have already specified in the configuration how many digits the value displayed has to the right of the decimal point. Now enter on the OP the required number of digits to the right of the decimal point in the input field.

The table below contains a few examples:

Digits to right of decimal point	Input example	Value in the S7-200
0	1960 (ms)	1960 ms
1	78.5 (s)	78500 ms
2	9.54 (s)	9540 ms
3	0.179 (s)	179 ms

3.3 Help Text

Purpose

Help text is written when configuring with ProTool and provides additional information in the language set at the OP. Info text can be configured for

- event messages and alarm messages,
- screens,
- screen entries,
- input fields and dual I/O fields,
- recipes, recipe entries,
- schedulers.

Help text can be used to convey, for example, information to the user on the current assignment of the soft keys. Help text relating to an alarm message may contain additional hints, for example, on the possible cause of the alarm and how to remedy it.

Displaying help text



The availability of help text is indicated by the HELP LED being lit. Configured help text can be output by pressing the HELP key on the OP.

If the cursor is positioned in an input field or in an I/O field for which help text is available (lit LED), the help text is output by pressing the HELP key. Pressing the HELP key a second time displays help text associated with the screen entry, if configured.

If the HELP key is pressed in a field for which help text is not available, help text associated with the screen entry, if configured, is displayed directly.

Configured information text associated with a screen is obtained either by pressing the HELP key in the directory when the cursor is positioned on the corresponding screen.

Scrolling through help text

The keys  and  are used to scroll through help text, if appropriate. The ESC key terminates display of help text, and the previous display is shown again.

Using the OP with Its Standard Functions

4

Loading a configuration

Once the operating voltage has been connected, you have to load a configuration into the OP so that you can operate it. The OP is in Download mode until a configuration is loaded.

Using standard screens

The configuration software supplied to you, ProTool, includes a configuration which contains standard screens. You can choose all the functions required for operating the OPs by using these standard screens. The different functions are described in this manual with reference to the standard screens.

4.1 Operating Levels

Message level and screen level

In OP operation, you have to distinguish between two distinct operating levels, between which you can switch:

- **Message level**

The message level is the highest level on the OP. At message level, waiting event messages, alarm messages and system messages are displayed. After the OP starts up, it changes to message level if

- a system message or an alarm message is waiting to be displayed
- a start screen has not been defined in the configuration. In this case, the OP displays the standby message (refer to section 7.1.1).

- **Screen level**

At the screen level, functions are chosen, serviced and executed. If a start screen has been defined in the configuration, the OP changes to screen level after it starts up and calls the start screen. From the start screen you branch, depending on the configuration, to other screens.

On the screens, you view current process values, can enter values and initiate functions by means of soft keys.

Screen hierarchy

The linking of individual screens is referred to as a "screen hierarchy". If you go to the bottom of the screen hierarchy, you go back one stage by pressing key ESC, right back to the start screen should you wish. From here you can return to the message level by pressing the ESC key. You can also return directly to the message level from a screen, depending on the configuration.

Changing operating levels

The operating level is changed either by the operator or automatically by the OP (figure 4-1).

- **Change by the operator:**

Press key

ENTER to change the operating level from message level to screen level,

ESC to change the operating level from screen level to message level.

You cannot branch backward from the message level by pressing ESC. The key is designed to terminate the display of a system message at this level.

- **Forced change to message level:**

You exit from the screen level automatically whenever a system message or an alarm message is waiting to be displayed. The OP then changes to message level to display the message. You cannot exit from the message level while a system message or unacknowledged alarm message is being displayed. The display of an unacknowledged alarm message is indicated on the OP by flashing of

- the alarm message and
- the ACK-LED (icon .

Press key

ACK to acknowledge an alarm message,

ESC to hide a system message.

After the alarm message has been acknowledged, the ACK LED goes off and, after the system message has been hidden, the OP returns to the point from which it changed to the message level.

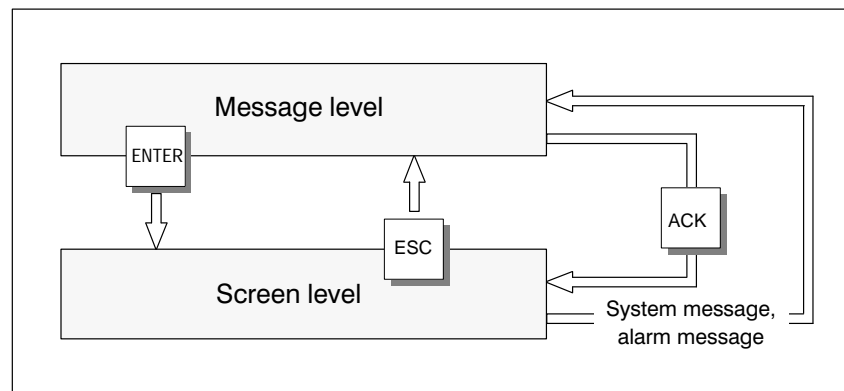

Figure 4-1 Changing between Message Level and Screen Level

4.2 Standard Screens

Basic operations with standard screens

The standard screens contain functions that are fundamental to OP operation. They include, for instance, calling and printing message buffers, editing passwords and modifying parameters in online mode. Process-specific implementations, such as event messages or screens for the process, are not included.

Functions on standard screens

Standard screens are called from a basic screen by means of a soft key. From the basic screen, a jump is made to the following screens:

- **Event messages**
At this point the event buffer is called, printed or deleted.
- **Alarm messages**
At this point the alarm buffer is called, printed or deleted.
- **Screens**
At this point the screen directory is called to edit or print screens. All the screens which were given the "directory" attribute are listed here. If you still have not created any screens of your own, the directory will be empty.
- **Data records**
At this point you can set up, edit and print data records. You can also transfer data records from the OP to the PLC and back.
- **Status tag**
At this point the PU function STATUS VAR is called; you can use it to display PLC operands.
- **Force tag**
At this point the PU function FORCE VAR is called; you can use it to display and modify PLC operands.
- **System settings**
At this point you can modify settings in online mode. This includes, for example, printer parameters, interface parameters, mode, and language changing.
- **Edit password**
At this point the superuser assigns passwords for the different password levels. Furthermore, login and logout are included here.

Figure 4-2 shows an overview of the screen hierarchy of standard screens. You will find detailed information on functions and handling standard screens in the relevant chapters of this manual.

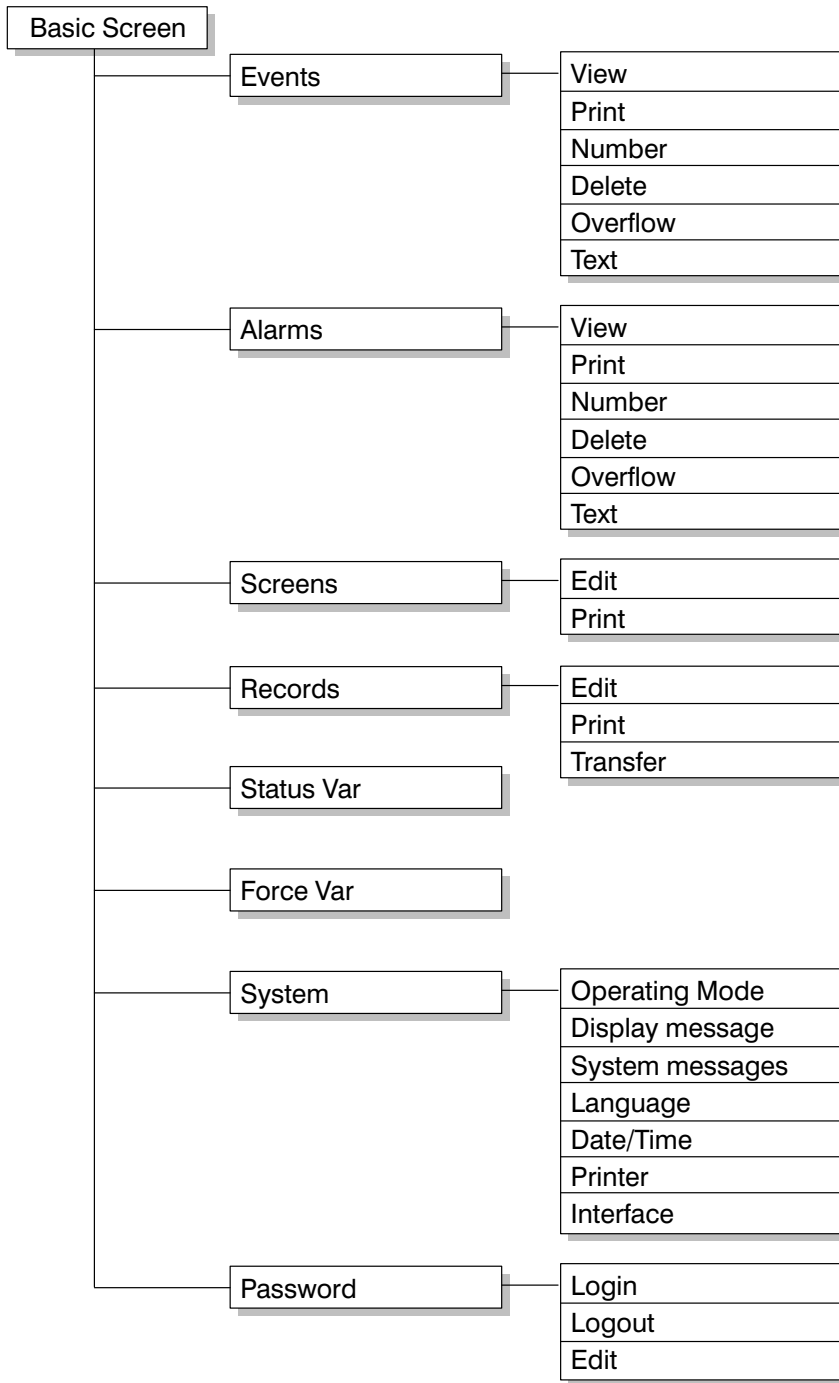



Figure 4-2 Screen Hierarchy of Standard Screens for the OP7 and OP17

4.3 Branching in Standard Screens

Branching to screen level

With  you change from message level to screen level. At this point you can control and monitor the process by means of suitable screens and standard screens and perform system settings.

With reference to the standard screens, a description is provided below of the procedure for branching between individual screens within the screen hierarchy.

Branching using soft keys

Call in your configured screen hierarchy the *standard basic screen*. Its name is displayed on the first line. Depending on the OP version and the number of lines to be configured (OP17), the next lines include a different number of text elements of the current entry. These text elements show the name of other standard screens to which you can branch by using the assigned soft keys.

Using the soft keys beneath the symbols << and >>, you can move the displayed screen segment of the current screen. You branch to the next screen by pressing the soft key beneath the appropriate text indicating the name of the screen to be called.

Figure 4-3 shows the branch principle on a configured 8-line display (in this instance, the OP17). figure 4-4 shows the branch principle of the 4-line display of the OP7.

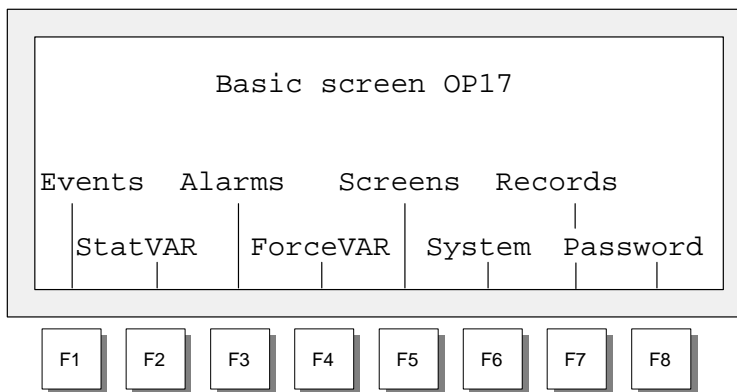

Figure 4-3 Branching at Screen Level (for an OP17, 8x40 representation)

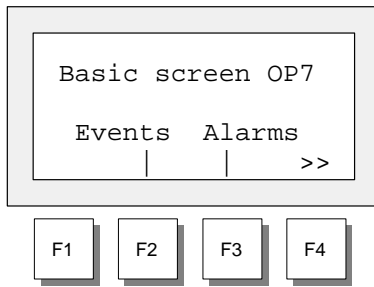

Figure 4-4 Branching at Screen Level (for OP7)

Selecting screens

You select a screen by pressing the soft key assigned to it during configuration.

Use the horizontal scroll function << and >> if the required screen segment is not within the visible display area.

Calling functions

Functions are called by means of the soft keys assigned to them during configuration.

As protection against unauthorized use, a password having a specific password level has to be entered first for some functions (refer to chapter 6).

Screens

Displaying and influencing the process on screens

On the OP, the process – for example, a processing machine or a mixing unit – is displayed on screens and manipulated. The screens are configured by the configurator for specific users.

On screens, associated process values are acquired and provide an overview of a process or system. In addition to this alphanumeric "imaging" of the process, screens provide a means of entering process values and, consequently, of controlling the process.

Process values on a screen can be randomly assigned to subject-related groups. An example of this is shown in figure 5-1.

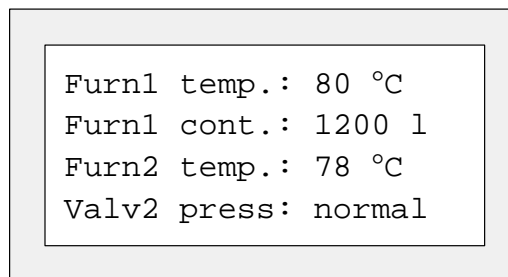



Figure 5-1 Example of Process Values Grouped by Subject on a Screen

Screen components

Every screen contains

- a title (optional, maximum number of characters: display width minus 3),
- max. 99 entries.
- a return destination reached by pressing 

Possible return destinations are

- the message level
- another screen
- a directory
- the point at which the current screen was selected.

Screen directory

Screens can be grouped during configuration in a screen directory, which is used to display them on screen or print and edit them. A screen can be retrieved from its screen directory by its screen number and its screen title, if configured.

5.1 Screen Entries

Displaying a screen entry

Screens consist of entries. Every screen may contain up to 99 entries. Irrespective of the configured number of lines, precisely one entry is displayed per display page on the OP. Lines which may have not been fully configured are displayed as blank lines.

An example of a screen entry is the two lines in the afore mentioned example (figure 5-1)

```
Furn1 temp.: 80 °C
Furn1 cont.: 1200 l.
```

Components of a screen entry

A screen entry consists of the following components:

- entry text
The static text contains explanations for the operator. It may also include information on how the soft keys have been assigned.
- fields for the
 - output of PLC actual values, date, time,
 - input of PLC tags which are immediately transferred to the PLC after being entered,
 - combined I/O of PLC tags.
- soft keys
Different function calls for the different screens are assigned to the soft keys.

Updating values in screen entries

The configuration defines the intervals at which PLC values are updated, i.e. read again from the PLC and displayed.

With large screens containing more than 159 actual values or setpoint-actual values, "partial screen updating" is automatically enabled. To enhance performance, only those values are updated which are currently present on the display. This may mean that an older value is briefly displayed when scrolling through screen entries. Updating of the visible actual values is faster as a result, however.

I/O fields

Output fields display actual values of the PLC in numerical or symbolic form; input fields define tags in numerical or symbolic form. In input fields, the flashing cursor is visible.

For symbolic I/O fields, you can configure up to 256 text elements which you can call on the OP using a selection field and apply to the screen entry.

With inputs of numerical values, configured number formats and limit values apply with respect to the number of places before and after the decimal point.

5.2 Selecting Screens

Methods of selecting screens

Screens can be viewed on the OP and serviced (edited) and printed. Before this is possible, they have to be selected. A screen can readily be selected by means of

- soft key,
- function key,
- directory,
- PLC job.



Selecting with soft key

With soft keys, you can branch from one screen to another. The branch is defined in the configuration.

Selecting with function key

The configured assignment of the function keys, unlike the soft keys, is valid globally. In this way the screen that was permanently defined during configuration can be selected in any operating situation.

Selecting with screen directory

Step	Procedure	Result
1	Depending on the action you want to take, call on of the two standard screens <ul style="list-style-type: none"> • <i>Screens</i> → <i>Edit</i> or • <i>Screens</i> → <i>Print</i>. 	The screen directory is shown. It contains only screens which were included in the directory during configuration – for example: <div style="border: 1px solid black; padding: 5px; margin: 10px 0;"> <pre>09 Fill level 14 Parameter_A 15 Parameter_B 17 Report</pre> </div>
2	Select a screen  	
3	Confirm selection 	Depending on the standard screen called in step 1, the screen you select is <ul style="list-style-type: none"> • displayed or • printed.



Selecting with PLC job

To implement operator guidance, a screen can be selected from the PLC by means of a PLC job. In this instance, the cursor is already positioned in a specified entry or in an input field, in which the operator can perform his input.

5.3 Editing Screens

Procedure





Screens can be manipulated, i.e. edited, by means of entries in input fields and combined I/O fields. To edit a screen, proceed as follows:

Step	Procedure
1	Select the screen you wish to edit as described in section 5.2. The cursor jumps to the first input field.
2	Move the cursor to the field concerned.  
3	Perform the modifications you wish to make as described in section 3.2.
4	After confirming your input, position the cursor again, if necessary, to perform further modifications.
5	Terminate editing 

5.4 Printing Screens

Procedure

To output a screen to a connected printer, proceed as follows:

Step	Procedure
1	Select the screen you want to edit as described in section 5.2. The screen directory is displayed (but not when selecting by means of a function key or a PLC job; in these instances, the corresponding screen is printed immediately).
2	Scroll to the screen number you require or, if configured, to the screen title  
3	Print the screen selected 
4	Terminate the action 

Password Protection

Access protection Password protection can be configured for function keys/soft keys and input fields in order to permit only authorized persons to work with the OP.

6.1 Password Levels and Access

Password hierarchy

When configuring with ProTool, the function keys/soft keys and input fields are assigned hierarchically ordered password levels from 0 to 9, 0 being the lowest and 9 the highest level in the hierarchy. The password levels of the standard screens are listed in Appendix A.

At the same time as you assign a password to an operator or to an entire group of operators, you also assign them authorization to execute functions of a certain password level.

When you log in with the OP under a password of a certain password level, you are given the authority to execute functions of this password level and functions from lower levels.

Password level 0

At this level, the lowest in the hierarchy, functions are assigned which, when executed, have no or little effect on the course of the process; these are normally calls of functions not having input options – for example, viewing message buffers.

You do not have to enter a password to call a function of password level 0. If you call a function that is assigned a higher level, the OP prompts you to enter a password.

Password levels 1 to 8

Levels 0 to 8 are assigned to functions of ascending importance. A password level is assigned to a password by the superuser as part of his password management responsibilities.

Password level 9

Permission to execute functions of password level 9 is the sole responsibility of the superuser, who has access to all OP functions. Only the superuser is allowed to perform password management.

Supervisor password

The supervisor password is specified during configuration. The default setting in the standard configuration is “100”. This setting can be changed on the OP.

Format

The password must be a minimum of 3 and a maximum of 8 characters long. It can be made up of digits and the characters A to F. Leading zeros are not permissible.

Standard screen

The standard screen *Edit Password* offers you the following functions:

- logging-in and logging-out on the OP (login/logout)
- changing and deleting passwords
- viewing the password list



6.2 Logging-in and logging-out on the OP (LOGIN/LOGOUT)

Login

You can log into the OP

- via the standard screen *Password processing* → *Login*
- by calling a function for which the current password level is too low. In this case, the OP automatically prompts you to enter a password.

Logging in via standard screen

Step	Procedure	Result
1	Select the standard screen <i>Password processing</i> → <i>Login</i> .	The password input screen is shown on the display. This screen is similarly displayed when a function call is made for which the current password level is too low. The cursor is located in the first field of the input area.
2	Enter the password by means of the system keyboard.	The input begins left-aligned. Each character entered is represented by an asterisk (*).
3	Confirm your input by pressing  or cancel the input by pressing 	<ul style="list-style-type: none"> – If the password is valid, the standard screen is exited. – If the password is invalid, you can either repeat your input or cancel.

Automatic call

If a higher password level than the one currently valid is required for operating a function key/soft key or an input field, the OP automatically prompts you to enter a suitable password beforehand.

Logout

If you do not make an input at the OP during a configured time period, the current password level is automatically reset to zero and the OP branches to the message level. This ensures that the OP cannot be operated by unauthorized persons.

You can also log out of the OP via the standard screen.

Logging out via standard screen

Select the standard screen *Password processing* → *Logout*. The OP then switches from the currently valid password level to the password level zero and branches to the message level.

6.3 Password Management

Functions

The standard screen *Password processing* contains the following functions for managing the passwords:



- viewing the password list
- configuring passwords and assigning password levels
- deleting passwords
- changing passwords and password levels.

These functions can only be called in password level 9. For this purpose, log in beforehand using the supervisor password via *Password processing* → *Login*.

Displaying password list

The password list contains all the passwords configured on the OP. The supervisor password is also displayed.

The table below shows how you open, look through and exit the password list. figure 6-1 demonstrate what a password list looks like.

Step	Procedure	Result
1	Select the standard screen <i>Password processing</i> → <i>Edit</i> .	The password list appears on the display.
2	You can use the cursor keys to scroll line by line through the list if required.  	The password index, password and password level are displayed inverted at the current cursor position.
3	Cancel the procedure by pressing 	You exit the standard screen.

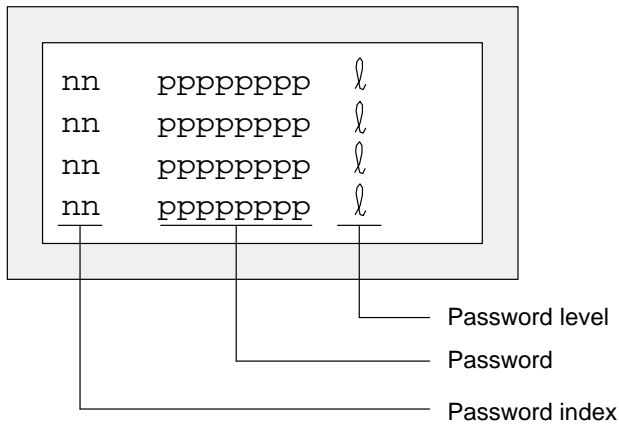

Figure 6-1 Password List (Example: 4 x 20 representation)





Password index

The passwords are numbered consecutively with a two-digit password index. If no password is entered under a password index, the fields for the password and for password level are contain dashes.



Configuring a password

A maximum of 50 different passwords can be configured on the OP. Password level 9 (supervisor) can be assigned only once.





To assign a password and password level, proceed as follows:

Step	Procedure	Result
1	Select the line for the password entry in the password list.	The cursor is positioned on the first character of the field in which the password is to be entered.
2	Enter a password that does not already exist and confirm it by pressing 	The cursor jumps back to the first character of the input field.
3	Position the cursor in the field for the password level. 	
4	Enter a password level 1...8 for the password and confirm it by pressing 	The cursor jumps back to the first character of the input field.
5	Exit the standard screen by pressing 	The new password is stored in the OP.

Deleting a password

Step	Procedure	Result
1	Select the line in the password list, that contains the password entry to be deleted.	The cursor is positioned on the first character of the field in which the password is to be entered.
2	Overwrite the first character of the password with a zero and confirm your input by pressing 	The cursor jumps back to the first character of the input field.
3	Exit the standard screen by pressing 	The password is deleted.

Changing a password and password level

Step	Procedure	Result
1	Select the line in the password list, that contains the password entry to be changed.	The cursor is positioned on the first character of the field in which the password is to be entered.
2	Overwrite the old password with the new one and confirm you input by pressing 	The cursor jumps back to the first character of the input field.
3	Position the cursor in the field for the password level. 	
4	Enter the new password level 1..8 for the password and confirm by pressing 	The cursor jumps back to the first character of the input field.
5	Exit the standard screen by pressing 	The password is changed.

Messages

Overview

Messages displayed on the OP indicate events and states in the control process. A message consists of at least static text and can also include tags.

The following types of message are displayed on the OP:

- event messages,
- alarm messages and
- system messages.

Event and alarm messages displayed are stored in the OP in their own message buffers. The messages stored in the buffers can be shown on the display and printed out on the printer in the form of a log.

Message states

Event and alarm messages can have the following events:

- **Arrive:**
identifies the occurrence or arrival of the message.
- **Depart:**
cause of the message is no longer available.
- **Acknowledged** (alarm messages only):
Message has been noticed and confirmed by the operator or the PLC.

These message states are detected by the OP with accurate timing and output when a message page or the message buffer is displayed.

7.1 Message types

Event and alarm messages Event and alarm messages are configured. Event messages indicate a status in the process, alarm messages indicate faults/errors. Event and alarm messages are initiated by the PLC. Due to their critical nature, alarm messages have to be acknowledged.

System messages System messages are initiated by the OP. They are not configured. They provide information on operating states of the OP or maloperations and breakdowns in communication.

7.1.1 Event and alarm messages

Definition The process states indicated by event messages and those indicated by alarm messages are defined during configuration.

Messages that provide information on regular processes or states should be categorized as event messages – for example

Temperature reached or
Motor running.

Messages on malfunctions referring to processes or states should be categorized as alarm messages – for example

Motor temperature too high or
Valve will not open.

Due to their critical nature, alarm messages have to be acknowledged. In doing so, the operator confirms that he has noticed the alarm message. Messages can also be acknowledged by the PLC.

Apart from status messages, information on operation can also be configured as event or alarm messages. If, for example, a machine operator wants to start the bottling process but has forgotten to open the water intake valve on the mixer, a message such as

Open water intake valve

can prompt him to rectify the error.

Presentation Event and alarm messages can be configured in such a way that any text components can be made to stand out from the remaining message text by means of flashing or a large font size. Alarm messages that have not been acknowledged always flash.

Messages may contain static text and tag fields. The tag fields display current actual values of the PLC in numerical or symbolic form. In addition, the date and time can also be output in messages.

Standby message

A sub-category of the event message is the standby message. The standby message is the event message number 0. It appears on the display when the OP is operating at the message level and event or alarm messages are not waiting.

The standby message is stored in the firmware and contains the version and the device type – for example

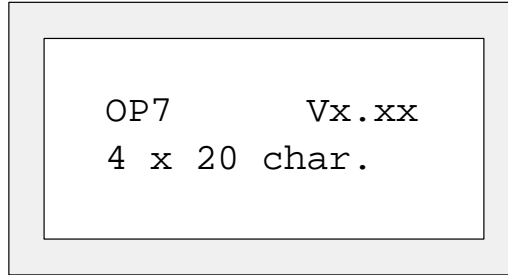

Figure 7-1 Example of Standard Standby Message on OP7

Depending on the configuration, the standby message can be represented by other text – for example a company logo. It can contain the date and time but not tags.

Alarm and event buffers

Alarm and event messages are written to alarm and event buffers, respectively, on the OP when they arrive.

The message buffer of the OP can store up to 256 events. Events are the:

- arrival of a message,
- acknowledgment of a message,
- departure of a message.

The following details are entered in the buffer in chronological order:

- incident of events
- arrival, departure and acknowledgement
- message numbers
- values of tags at the time of arrival and departure.

Overflow warning

During configuration, you can define a remaining buffer space. When this remaining buffer space has been reached, an automatic overflow warning is issued – for example

EM remaining buffer.

Messages continue to be inserted into the buffer even after the remaining buffer space has been reached.

Message bit procedure

If there is a condition present in the current process for a message to be issued – for example, a tag has been reached – a bit is set by the PLC application program in the data area for event and alarm messages. The OP reads the data area after a configured polling time. In this way, a message is detected as having "arrived". The bit is reset by the PLC when the condition for issuing the message no longer exists. The message is then regarded as having "departed".

7.1.2 Alarm messages

Acknowledging an alarm message

Due to their critical nature, alarm messages have to be acknowledged. This can be done manually by the operator or automatically by the PLC.

To acknowledge an alarm message manually, press this system key.



The OP displays unacknowledged alarm messages in flashing mode.

The LED assigned to the Acknowledge key (icon ) also flashes.

After all the alarm messages have been acknowledged, the ACK LED display changes from flashing to permanently on. Not until all the acknowledged alarm messages have departed is the LED turned off. In this way, it is impossible for you to forget an alarm message.

If several alarm messages are waiting to be displayed, after one has been acknowledged the next one is shown, which similarly has to be acknowledged.

If no more alarm messages are waiting to be displayed, the OP reverts to the operating level from which it branched to the message level to display the alarm messages.

Acknowledgement groups, group acknowledgement

During configuration, you can combine several alarm messages to form an "acknowledgement group". In this way you can acknowledge all the other alarm messages (consequential faults) in that acknowledgment group by acknowledging the first alarm message – for example, the cause of the fault – without all of them having to be output to the display on the OP (group acknowledgement). You can configure up to four acknowledgment groups.

If alarm messages are not assigned to an acknowledgment group, only the one that happens to be on the display is acknowledged if more are waiting.

Inhibiting the display of alarm messages

There is the possibility of inhibiting the display of frequently occurring alarm messages for the time being until the OP starts up as a result of a cold or warm start. Before you can inhibit the display of an alarm message, you must have logged onto the OP with a password having a password level of at least 8.

Operation

To inhibit an alarm message, press the following keys simultaneously

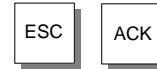

The OP acknowledges inhibition of the alarm message by means of system message \$ 335. After that, this message will not be displayed until the next time the OP starts up.

Inhibited alarm messages are no longer inserted into the alarm buffer from the time of inhibition, either. They are stored in the alarm buffer only from the time they first occur until such time as the display is inhibited.

Note

The alarm message inhibit function should be used only during the commissioning phase of the OP.

7.1.3 System messages

Definition

System messages indicate operating states within the OP. For example, they draw your attention to maloperations or a breakdown in communication. This message type has top display priority. If a relevant fault occurs on the OP, the active event message or alarm message is removed from the display and a system message is issued in its place.

After the system message has been hidden, the OP returns to the point from which it branched.

Serious and non-serious system messages

System messages are classified as serious and non-serious system messages. A serious system message is based on an error that can be rectified only by a cold or warm restart of the OP. All other errors generate a non-serious system message – for example, when printing has been initiated but a printer has not been connected to the OP.

If the display of a non-serious system message is not automatically canceled after a short while, you can do so manually by pressing this system key.



Display of a non-serious system message can also be canceled automatically when a configured display time has expired.

A list of possible system messages and their explanations will be found in the appendix B of this manual.

Inhibiting system messages

Display of system messages (with the exception of internal errors 7xx) can be inhibited at the configuration stage. System messages whose display has been inhibited continue to be inserted into the system message buffer and thus can be viewed on the display later.

System message buffer

The system message buffer can store up to 100 messages. System messages are inserted into it with their message number and their arrival; their departure is not recorded. Some minor errors and operator errors are not logged in the system message buffer. Messages from the system message buffer are displayed in the same order as they arrived, i.e. first in first out, last in last out.

7.2 Displaying Messages

- Display** Event and alarm messages are always output to the display at message level and are displayed according to display and message priorities.
- If several messages having identical display and message priorities exist simultaneously, the most recent is displayed in all cases, for both event and alarm messages.
- Display priorities** System messages always have top priority in so far as display is concerned; unacknowledged alarm messages always have the second highest priority. Otherwise, messages are displayed in different sequences depending on whether separate or together output of event and alarm messages was configured.
- Message priorities** Message priorities of
- 1 (low) to
 - 4 (high)
- can be set within event and alarm messages in the configuration according to their importance. If several messages of the same display priority exist simultaneously, they are displayed according to their message priorities, those with the highest message priority being shown first and those with the lowest last.
- Displaying the first/last message** Depending on the setting, either the oldest message (*First*) or the newest message (*Last*) is displayed when there are several alarm messages present. You can change this setting on the OP online via the standard screen *System Settings*. To do this, select the standard screen *System Settings* → *DispMsg* and set the appropriate parameter.

7.2.1 Display Sequences

Message length

Event and alarm messages can be configured with up to 80 characters and displayed either separately or together.

Single message display (setting "separate")

With this display sequence, only one alarm message, event message or system message is shown on the display. On the OP17 four messages are displayed in the case of 8 x 40 representation.

If several messages are queuing, the messages are displayed in succession and output according to the following priorities:

1. System message, the most recent one, if there are several.
2. Unacknowledged alarm message.
3. Event message yet to depart.
4. Acknowledged alarm message yet to depart.
5. Standby message.





Combined message display (setting "together")

If there is no system message, the alarm and event messages having the highest priority are displayed simultaneously one on top of the other. On the OP17, two event messages and two alarm messages are displayed with the 8 x 40 representation.

7.2.2 Scrolling through Waiting Messages at Message Level

Meaning of keys

If there are neither system messages nor unacknowledged alarm messages, you can scroll at message level through the messages that have not yet departed. To do this, use the following keys:

Key	Purpose
 	Return/continue to older/newer alarm message
 	Return/continue to older/newer event message
	Return to the current (newest) message

The message currently waiting will be displayed if there is no operator input on the OP for one minute.

Example

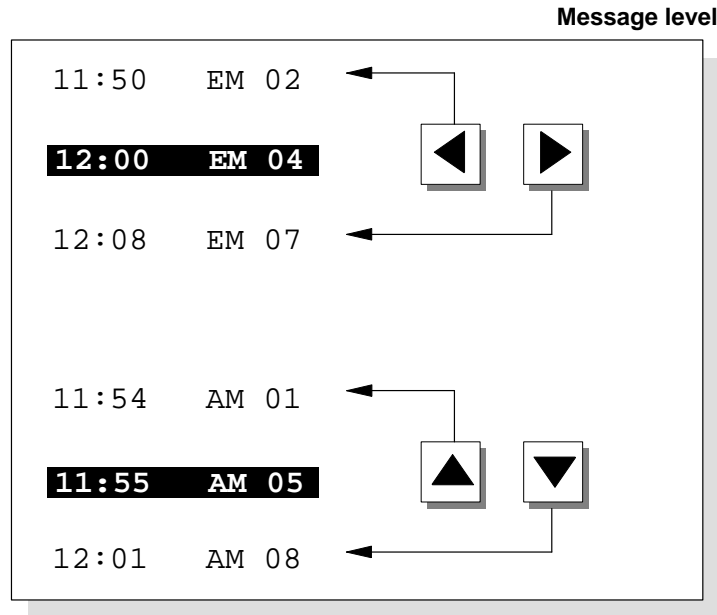

The event messages (EM) and alarm messages (AM) illustrated below are queued on the OP.



7.2.3 Viewing Event and Alarm Message Text

Viewing Messages

Irrespective of the current contents of the event or alarm buffer, all configured event and alarm message text can be shown on the OP. To do so, proceed as follows:

Step	Procedure
1	Choose the standard screen <ul style="list-style-type: none">• <i>Alarms</i> → <i>Text</i> to display alarm messages or• <i>Events</i> → <i>Text</i> to display event messages.
2	By using the arrow keys, you can now scroll through the list of configured message text.  

7.3 Message Buffers

Purpose Messages displayed on the OP are written to the message buffer concerned. The message buffers can be called to view message history by means of standard screens.

The times of occurrence, acknowledgment and departure are displayed in chronological order for all messages.

Back-up

- **OP7**
The data in the message buffers are lost when the OP7 is turned off or following an interruption of the power supply.
- **OP17**
The data in the message buffers remain stored for several hours when the OP17 is turned off or following an interruption of the power supply.

Viewing message buffer

Select the corresponding standard screen:





- *Alarms* → *View*
- *Events* → *View*
- *System settings* → *SysMsg*

The messages contained in the message buffer are displayed in the message list on the OP. They contain the following information:

	Alarm messages	Event messages	System messages
Message number	✓	✓	✓
Date and time	✓	✓	✓
Message status: A = arrived D = departed K = acknowledged	✓ ✓ ✓	✓ ✓ -	- - -
Acknowledgement group	✓	-	-

Cursor keys

You can use the cursor keys to select and deselect the message texts of a message and to scroll through the message list.

Key	Result
	Displays the message text for the message selected.
	Deselects the message text and returns to the message list.
 , 	Scroll through the message list.

Viewing number of messages in alarm message buffer or event message buffer

In order to gain an overview of the sum of all alarm and event messages in the buffer and of the number of alarm and event messages still queued, select the appropriate standard screen:

- *Alarms* → *Number*
- *Events* → *Number*

7.4 Deleting Messages

Purpose All message events for event and alarm messages are automatically stored in the event message buffer or alarm message buffer respectively. Each of these buffers has space for up to 256 events. To prevent a buffer overflow, event and alarm messages must be deleted from their buffers.

Message events from the event message buffer or alarm message buffer are deleted

- automatically when buffer overflow occurs
- by means of the appropriate standard screen.

System messages are deleted automatically only when the buffer overflows.

7.4.1 Deleting alarm message and event message buffers upon buffer overflow

Overflow warning When the specified remaining buffer capacity for the alarm and event message buffers is reached, an overflow warning is output by default. Output of this overflow warning can be activated and deactivated online via the corresponding standard screen:

- *Alarms* → *Overflow*
- *Events* → *Overflow*

Deleting upon buffer overflow If the alarm or event message buffer has insufficient space to accept any more message events, message events are automatically deleted until the specified remaining buffer capacity is reached. Deletion is carried out in the following order:

- The oldest departed messages.

For departed event messages, the message events 'arrival' and 'departure' are deleted. For departed alarm messages, the message events 'arrival', 'departure' and 'acknowledged' are deleted.

- Queued messages.

If there is still insufficient space for new events, the oldest queued messages are deleted in the case of event messages.

In the case of alarm messages, deletion is carried out in the following order:

- Acknowledged alarm messages yet to depart
- Unacknowledged alarm messages that have already departed
- Unacknowledged alarm messages yet to depart.

Automatic printout If "Printout Overflow" has been configured and a printer is connected to the OP and switched on, a forced printout of all deleted messages is initiated.



7.4.2 Deleting alarm and event messages via standard screens

Procedure

Standard screens can be used to delete

- all (not individual) acknowledged and departed alarm messages
- all (not individual) arrived and departed event messages.

To delete event and alarm messages, proceed as follows:

Step	Procedure
1	Depending on the type of message you want to delete, choose one of two standard screens <ul style="list-style-type: none">• <i>Alarms</i> → <i>Delete</i> for alarm messages or• <i>Events</i> → <i>Delete</i> for event messages.
2	Press  to delete buffer,  to not delete buffer.

7.4.3 Automatically Deleting the System Message Buffer upon Buffer Overflow

Procedure

If the system message buffer is completely full, the oldest message is deleted automatically from the buffer when another system message occurs. There is no overflow warning or forced printout of the deleted message, in the case of event and alarm messages.

7.5 Printing Messages

- How to print out** You can print alarm and event messages
- as a direct message log (refer to section 7.5.1),
 - as a full printout of the message buffer (refer to section 7.5.2),
 - upon buffer overflow (refer to section 7.4.1).

7.5.1 Direct Message Logging

Print time Event and alarm messages can be printed upon arrival and departure (alarm messages upon acknowledgment, too) if this was set when the message was configured. System messages are not logged directly.

If direct message logging follows another print function, the header of the direct message log is re-printed.

Temporary storage if the printer is disabled If the printer is disabled, not ready or assigned to another print function, up to 16 messages are stored temporarily. Temporary storage of the messages for the message log is independent of the message buffer concerned.

Activating/deactivating direct message logging You can activate and deactivate direct message logging online at the OP via the standard screen *System Settings* → *Printer*. You do this by selecting the symbolic input field *Message log* in the list of parameters and setting the value *ON* or *OFF*.

The table below shows the interdependency between the settings on the OP and the settings configured in ProTool.

Setting in ProTool	Setting on OP	
	Message logging ON	Message logging OFF
Message event	Messages are logged	Messages are not logged
Buffer overflow	Messages are logged	Buffer overflow is printed out
OFF	Messages are logged	No effect

7.5.2 Printing the Message Buffer

Sequence

Messages from the alarm or event buffers, but not the system buffer, can be printed

- **chronological,**
all messages contained in the buffer of the message type concerned are printed in the order in which they are contained in the buffer
- **together,**
all messages contained in the buffer of the type of message concerned are printed in ascending message number order. If a message occurs more than once, it is slotted according to time-related subcriteria.

Procedure

Choose the standard screen

- *Alarms* → *Print* to print alarm messages or
- *Events* → *Print* to print event messages.

The default setting is *Chronological*. The default setting can be modified during configuration. A choice of either *Chronological* or *Together* online on the OP is possible only when it has been configured.

Recipes

Purpose

Recipes are combinations of tags for a certain purpose. The purpose of recipes is to transfer data together to the PLC. This involves synchronization between the OP and PLC.

Data records

When configuring you define not only the recipe but the data structure too. The structure is assigned data at the OP. This data structure (recipe) can be used repeatedly and assigned different data. Recipes assigned data are referred to as “data records“. Data records are stored in the OP. This saves memory space in the PLC.

Example of a recipe

Orange nectar, orange drink and orange juice are to be produced using the same bottling station at a fruit juice plant. The mixing proportions are different for each drink, but the ingredients are always identical. The production details are configured in this example as the recipe called ”Mixture”.

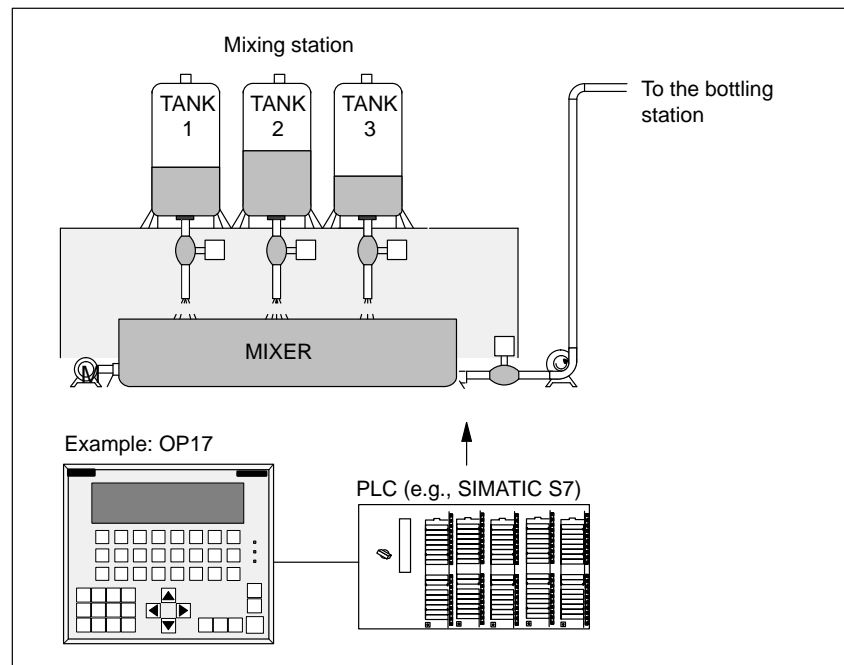

Figure 8-1 Example of a fruit juice plant

Components of a recipe

A recipe consists of a series of recipe entries. Each entry contains a maximum of one input field (i.e., tag). Depending on the configuration, either direct or symbolic value input can be used in an input field.

The recipe called *Mixture* could be set up from the following entries.

Name :	<input type="text"/>
Orange :	<input type="text"/> l
Water :	<input type="text"/> l
Sugar :	<input type="text"/> kg
Flavoring :	<input type="text"/> g

|
Input fields (tags)

In contrast to screens, several entries are displayed on the OP simultaneously for recipes.

Data records on the OP

On the OP, the tags allocated to the input fields are assigned with values and stored on the OP. Together, these values form one data record of the recipe.

Several data records can be created for one recipe. This permits a fruit juice plant to operate with different types of drinks, for example, by using a different data record for each type of drink.

Name :	Drink	Nectar	Juice
Orange :	90 l	70 l	95 l
Water :	10 l	30 l	5 l
Sugar :	1.5 kg	1.5 kg	0.5 kg
Flavoring :	200 g	400 g	100 g

| | | |
Entries of the recipe Data record 1 Data record 2 Data record 3
"Mixture"

All data records are stored in the OP. Only the data record which is active at the moment is stored in the PLC. This saves memory space in the PLC.

Identification of recipes and data records

A recipe is identified by a recipe number and a recipe title specified during configuration. A data record is identified by a data record number and a data record name assigned in the OP.

The clear and unmistakable identification factor for a data record is the data record number and not the data record name.

This means that, although several data records with the same name may exist, several data records with the same number cannot exist. If no name is assigned to a data record, it is assigned the name "data record".

Standard screen for data records

The standard screen *Records* offers you the following functions:

- *Record* → *Edit*:
Creating, editing and deleting data records.
- *Record* → *Print*:
Printing out data records on a printer.
- *Record* → *Transfer*:
Transferring data records from the OP to the PLC or from the PLC to the OP.

Directory for recipes

Recipes are combined into a recipe directory which can be used to indicate them on the OP, and to print and edit them. A recipe is located in the recipe directory under its recipe number and its recipe title.

Transferring data records

The OP offers a transfer screen for transferring data records from the OP to the PLC and back. Transfer a data record to the PLC when required by the PLC.

The data record in the PLC can be overwritten by another data record stored on the OP.

The active data record can also be transferred from the PLC to the OP and stored on the OP.

Note

Only one recipe data record at a time can be active on the PLC.

Transmission of data records between OP and PLC is synchronized to prevent uncontrolled overwriting.

8.1 Creating and Editing Data Records

Default







The OP automatically creates a data record with the number 1 and the name "data record" for each recipe. All values of the data records are preset with 0. You can edit this data record.

To create more data records, either

- copy this data record (see chapter 8.2), or
- edit this data record and save it under a different name.

Editing data records

Proceed as follows to change existing recipe, data record values.

Step	Procedure
1	Select standard screen <i>Record</i> → <i>Edit</i>
2	Select the desired recipe in the recipe directory.
3	Select the data record to be edited in the data record directory. Note: You can have the recipe title displayed by paging up in the first entry.
4	Position cursor on the value to be changed.
5	Enter numeric or symbolic value.
6	Confirm the value. If you want to change more values, position the cursor in the input field of the next entry and change the value there.
7	To conclude editing data records after the last modified value has been accepted, press  You will then be asked whether you want to save the data record.
8	Save: Position cursor on the Yes field and confirm with  Do not save: Press  Since the data record number already exists, you will then be asked whether you want to overwrite the data record.
9	Overwrite: Press  Do not overwrite: Press 
10	Exit standard screen with 

As long as you have not confirmed an input value, you can terminate editing with **ESC**. The old value is then displayed again.

Storing a changed data record as a new data record

To save a changed data record as a new data record, do not overwrite the called data record when exiting the input screen. Instead, enter a new data record number and, if necessary, a new data record name before saving the data record.

Proceed as follows:

Step	Procedure
1	Position cursor in the field for the data record number. Enter the number, and confirm.
2	Position cursor in the field for the data record name. Enter the name, and confirm. The data record name may not exceed 12 characters.

The next time you call the data record directory, you will find the new data record listed under the new data record number.

8.2 Copying Data Records

Overview

There are two ways to copy a data record.

- You can call an existing data record for editing, and save it unchanged under a new number and, if necessary, under a new name. Then make your changes.
- Save an existing record via data record transfer under a new number and, if necessary, under a new name. Then make your changes in the copy.

Procedure

Proceed as follows to obtain a copy of a data record whose values you want to change later.

Step	Procedure
1	Call the data record to be copied via the standard screen <i>Record → Edit.</i>
2	Instead of changing a value in the data record, exit the displayed data record again immediately by pressing  When the standard screen is exited, you will be asked whether you want to save the data record regardless of whether values have been changed or not.
3	Position cursor in the field for the data record number. Enter the number, and confirm.
4	Position cursor in the field for the data record name. Enter the name, and confirm.

The next time you call the data record directory, you will find the new data record in the list.

8.3 Transferring Data Records

Overview

A transfer screen offering the following functions is available for transferring data records.

- **OP → PLC**
Before a changed or newly set up data record in a recipe can become effective in the PLC, it must first be transferred via data record transfer to the PLC.
- **PLC → OP**
Transfer the data record which is active in the PLC to the OP under a new number and a new name.
- **OP → OP**
Copy an already existing data record on the OP.

Transfer screen

The transfer screen is called via *Record → Transfer*. It is shown below.

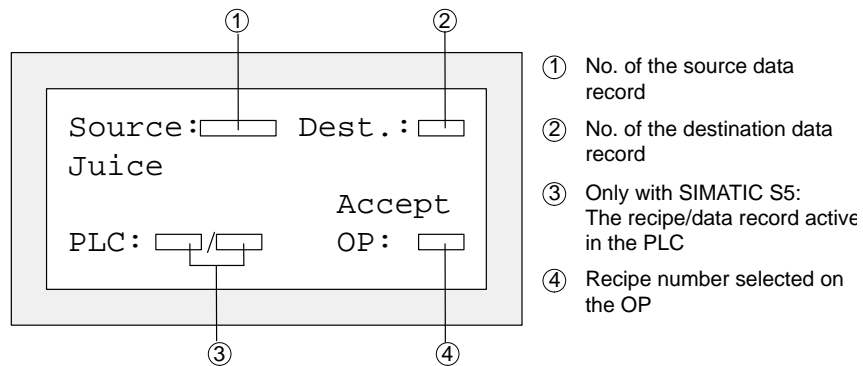

Figure 8-2 Transfer screen (Example: OP7)

Specifying source and destination

The data record numbers for the source data record and the destination data record must be entered in the transfer screen.

- The PLC data record is always "0" for both directions of transfer.
- The OP data record must always be specified as a number > 0.

Example of entering source and destination:

OP → PLC Transfer		
Source	Destination	Description
11	0	Source data record 11 is an existing data record on the OP and is to become the active data record on the PLC (destination).

PLC → OP Transfer		
Source	Destination	Description
0	22	The source data record 0 is the active data record on the PLC which is to appear on the OP (destination) after the transfer under data record number 22 . If data record number 22 already exists, it can be overwritten or not if requested.

OP → OP Transfer (i.e., copying)		
Source	Destination	Description
33	44	Source data record 33 is an already existing data record on the OP which is to be copied as data record 44 . If data record number 44 already exists on the OP, it can be overwritten or not if requested.

Note

Symbolic value entries in the input fields source and destination:

The data record numbers from data records already stored on the OP can be taken from a data record selection list.

”PLC” stands for data record 0 in the selection list.

Using the transfer screen

Proceed as follows to transfer a data record.

Step	Procedure
1	Select the standard screen <i>Record</i> → <i>Transfer</i> .
2	Select the recipe in the recipe directory
3	Position the cursor on the <i>Source</i> field in the transfer screen. Depending on the direction of transfer desired, enter the appropriate source number (see examples), and confirm.
4	Position the cursor on the <i>Destination</i> field. Depending on the direction of transfer desired, enter the appropriate destination number (see examples), and confirm.
5	Position the cursor on the <i>Accept</i> field, and confirm transfer. During the data transfer, an asterisk ("*") is indicated in the acceptance field.
6	Exit the standard screen with 

8.4 Deleting Data Records





Note

Data records of a recipe can be deleted from the data record directory. These data records are then no longer available for the recipe.

When a data record which is active in the PLC is deleted from the directory of the OP, this data record still continues to be active in the PLC.

Procedure

Proceed as follows to delete data records.

Step	Procedure
1	Select <i>Record</i> → <i>Edit</i> in the standard screen.
2	Select the desired recipe from the recipe directory.
3	Using the cursor keys, select the data record to be deleted from the data record directory.
4	Press 
5	To delete: Press  To not delete: Press 
6	Repeat steps 3 and 4 as necessary. If only one single data record exists, this record cannot be deleted.
7	Exit the standard screen with 

STATUS/FORCE VAR with the OP

- Purpose** The operator panel offers you the two functions *STATUS VAR* and *FORCE VAR* which enable you to display and modify operand values from the connected SIMATIC S5/S7/M7 PLC via standard screens.
- In online mode, this means that PLC operands can be edited directly on the OP without having to connect a programming unit/PC to the PLC.
- STATUS VAR** You can use *STATUS VAR* to display the status of operands of a SIMATIC S5/S7/M7.
- FORCE VAR** You can use *FORCE VAR* to control operands of a SIMATIC S5/S7/M7 by modifying their tag values and transferring them back to the PLC.
- Note for SIMATIC S7/M7** After calling the *STATUS VAR* and *FORCE VAR* functions, the OP prompts you to enter the MPI or PPI address, respectively.

9.1 FORCE VAR

You call FORCE VAR by means of the standard screen *ForceVAR*. Following the call, the operand list is displayed. Depending on the display, an operand is displayed on either one or two lines.

Figure 9-1 shows the display for the SIMATIC S5 on the OP17 (8 x 40 representation). Figure 9-2 shows the display for the SIMATIC S7/M7 on the OP7.

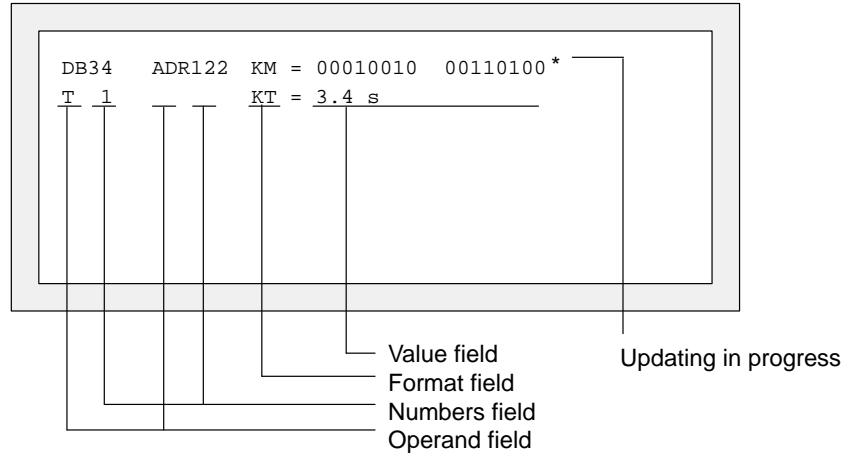

Figure 9-1 Display of PLC Operands for SIMATIC S5 (OP17, 8x40 representation)

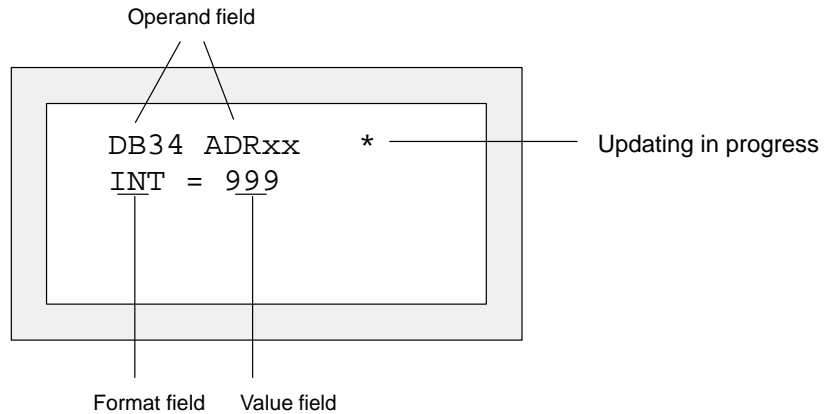







Figure 9-2 Display of PLC Operands for SIMATIC S7/M7 (4x20 representation)

Displaying PLC operands

Step	Procedure
1	Press  Select the data type you wish to have displayed using the cursor keys.
2	Press  The corresponding data format is set automatically in the format field. Shift Lock mode is de-activated at the same time.

Going to numbers fields

Step	Procedure
1	Go to the numbers field using 
2	Enter in the numbers field the number of the operand you want to display or modify by means of the keypad and confirm it by pressing 
3	Modify the default data format using 

Refer to the table at the end of this chapter for the valid S5/S7/M7 operands and data types.

Entering values

Within the lines and value fields, the cursor can be moved horizontally. A total of ten lines can be assigned. Confirm inputs by pressing .

The values of the operands you select are displayed in the value field in the specified format.

Inserting and changing lines

If the cursor is located in the first field and if input has not been started and updating is not in progress, you can insert a new tag line in front of the current line using the Insert key and you can delete the current line with the Delete key.

If the cursor is located in a value field (not KM) containing at least one character, use  to delete the character at the cursor location.

Updating values

When you have finished editing the operand list, the values on the PLC have to be updated. This is not done immediately after an individual value has been entered. Not until you press the Enter key again after entering the final value is updating of all the new values explicitly initiated. During updating, a flashing asterisk, *, is visible in the top right corner of the display. If the asterisk does not flash, this means that the OP did not succeed in establishing a logical link to the PLC.

Inputs cannot be made while updating is in progress. Updating can be canceled by pressing .

Operand	Data type
SIMATIC S5	
DW	KH KF
MW	KG KM
AW	KS KY
EW	KT KC
Z	KH KM KC (Output only)
T	KH KM KT (Output only)
SIMATIC S7-200	
VW	CHAR
EW	INT WORD
AW	REAL
MW	BOOL STRING
T	TIMER
Z	COUNTER
SIMATIC S7-300/400	
DB, M	CHAR INT WORD REAL BOOL STRING TIMER COUNTER
E, PE, A, PA	CHAR INT WORD REAL BOOL STRING
T	TIMER
Z	COUNTER

System Settings

In this chapter

This chapter informs you of functions that can be triggered by standard screens to perform system settings. They include:

- Selecting a language,
- Modifying parameters for OP interfaces, printers, message display, date and time,
- Adjusting display contrast,
- Setting OP mode.

10.1 Selecting a Language

Languages available

The configuration can be loaded on the OP in up to three languages simultaneously. You can switch between the separate languages online at any time. After switching over, all language-dependent text is displayed in the new language. The following languages are available for OP7 and OP17:

- German
- English
- French
- Italian
- Spanish
- Russian (Cyrillic characters)

Procedure

To choose another language, proceed as follows:



Step	Procedure
1	Choose the standard screen <i>System settings</i> → <i>Language</i> .
2	Select the language you require by means of a symbolic input. The selection list contains only the languages which have been loaded on the OP. The OP performs a cold restart and loads all elements of language-dependent text in the new language.

10.2 Modifying Parameters in Online Mode

Modifying interface parameters

The parameters set as default parameters for the OP interfaces during configuration can be modified by means of standard screens.

To do this, proceed as follows:

Step	Procedure
1	Depending on the OP you are using, choose one of the standard screens marked <i>System settings</i> → <i>IF</i> .
2	Scroll through the parameter list on the display using the arrow keys to the parameter you require. Some of the parameters displayed cannot be modified.  
3	Choose the value for the parameter by using a symbolic value.
4	Exit from the standard screen by pressing 



Modifying printer parameters and setting message logging ON/OFF

The default settings configured for printouts on the connected printer can be modified by means of a standard screen. In this instance, you can set the following:

- characters per line (parameter values: 20, 40 or 80)
- lines per page (parameter values: 60 to 72)
- message log (ON, OFF).

When message logging is active (ON), each message event (arrival and departure; for alarm messages also acknowledge) is printed out. When set to OFF, message logging is deactivated.

To set the parameters for your printer, proceed as follows:

Step	Procedure
1	Choose the standard screen <i>System settings</i> → <i>Printer</i> .
2	Scroll through the parameter list on the display using the arrow keys.  
3	Choose the value for the parameter at the cursor location by using a symbolic input.
4	Exit from the standard screen by pressing 





Setting first/last message display

To define whether the oldest or the most recent alarm messages (for first/last message refer to section 7.2) is displayed when several are waiting to be displayed, proceed as follows:

Step	Procedure
1	Choose the standard screen <i>System settings</i> → <i>DispMsg</i> .
2	Select the corresponding parameter, i.e. either <i>First</i> or <i>Last</i> .
3	Exit from the standard screen by pressing 

Setting date and time

You can adjust the current date and time on the OP – for example, to allow for summer or winter time. Any change you make will affect all messages and screens for which a date or time tag has been defined. The display format for date and time is defined in your configuration and cannot be changed by means of the menu system on the OP.

Step	Procedure
1	<p>Choose the standard screen <i>System settings</i> → <i>Dat/Time</i>.</p> <p>Use the arrow keys to move the cursor from the date field to the clock field and back again. </p> <p>To move the arrow keys within the input field for the date or time, activate Shift Lock mode beforehand so that the LED is on.  </p> <p>Change the day of the week using a symbolic input and the date and time of day by means a numeric input.</p>
2	Confirm your input by pressing 
3	Exit from the standard screen by pressing 

Note

- OP7** Date and time are generated by software. This information has to be updated every time the OP7 starts up.
- OP17** Without a backup battery (upgradable option), the OP17 continues to count the date and the time for several days following interruption of the power supply. If the OP17 starts up after this stored energy time has expired, the internal hardware clock has to be updated.

10.3 Adjusting Contrast



Settings

On the OP7 and OP17, you can adjust the contrast of the LCD. The display contrast can be adjusted by means of

- direct adjustment or a
- standard screen.

Direct contrast adjustment

The display contrast of the LCD can be adjusted at all times in normal mode by means of direct control:

Step	Procedure
1	Press the key. The SHIFT LED lights. 
2	Press the key to set the contrast to the value you require. 
3	Press the key. The SHIFT LED is off. 

Contrast adjustment by means of a standard screen

LCD display contrast can also be adjusted by means of a standard screen. To do so, proceed as follows :

Step	Procedure
1	Choose the standard screen <i>System settings</i> → <i>Language</i> .
2	Move the cursor to <i>Contrast</i> .
3	Select the contrast value you require by means of symbolic input (1 for minimum contrast, 16 for maximum contrast).

10.4 Setting OP Modes

Modes

You can set the following OP modes by means of standard screens:

- Online,
- Offline,
- Download and
- Loop-Through (OP17 only).

Online

This the default operating mode for unrestricted control and visualization of the process. In Online mode, there is a logical link between the OP and the PLC, or the OP tries to establish a link.

Offline

In Offline mode, a logical link does not exist between the OP and the PLC. The OP does not even attempt to establish a link. You can still operate the OP. It is not possible to control and visualize the process.

Download

In Download mode, data can be downloaded from the configuration computer to the OP. There is no logical link between the PLC and the OP in this mode. You are not able to operate the OP in download mode.

Loop-Through with OP17

While the OP is being commissioned, troubleshooting or optimization of the PLC program is often necessary. For this purpose, the PU or PC can be connected to the second interface of the OP17 in Loop-Through mode. This way it is possible to communicate between PC/PU and the PLC through the OP17. For the restrictions which have to be taken into account in Loop-Through mode refer to section 14.2.4.

Jobs from the PLC to the OP17 can be initiated only when the OP17 is either working in online mode or has been switched to loop-through mode.

Setting the OP mode on standard screens

To set OP modes, proceed as follows:

Step	Procedure
1	Choose the standard screen <i>System settings</i> → <i>OpMode</i> .
2	Set the mode you require by means of a symbolic input.
3	Exit from the standard screen by pressing 

You will find further information on OP modes in chapter 15 of this manual.

Part III Expanded, Configurable Functions	Process-Dependent Operator Guidance	11
	Schedulers (OP17 only)	12
	Controlling the OP from the PLC	13

Situation-specific process control

Different action is normally required or allowed in different operating situations. To support changing requirements during process control, you can configure the following measures, which provide the operator with situation-specific purposeful help:

- screen-dependent soft keys,
- global function keys and
- user-defined screen hierarchies.

11.1 Branching by Means of Soft Keys and Function Keys

Soft keys: function keys with a tag assignment

You can assign function calls to the function keys on the OP7 and the OP17. We distinguish in this instance between local and global assignment. Global means that the assignment applies to the entire configuration. Local means that the assignment applies to one screen entry only. This makes it possible for the operator to initiate functions as and when required by the situation. When the assignment of function keys may vary from screen entry to screen entry, the keys are referred to as soft keys.

The following keys can be assigned as soft keys on the different devices:

OP7 The two tiers of keys F1 to F4 and K1 to K4 of the function keyboard may be configured both as soft keys and global function keys.

OP17 The two tiers of keys F1 to F8 and K1 to K8 of the function keyboard may be configured both as soft keys and global function keys. Function keys K9 to K16 can be assigned only globally.

While configuring soft keys, you must make sure that function calls which are required to be permanently available, i.e. also during screen editing, are not assigned to keys which you intended to be soft keys.

Assignments of function keys and soft keys

You can assign the following functions to function keys and soft keys:

- branch to message level,
- select screen,
- initiate a print job,
- display directory,
- modify parameters in online mode.

Password level assignment

A password level may be assigned to a function key or a soft key. This means that you can make functions, such as "Modify parameters in online mode", available only to authorized persons.

Special feature with function keys

If a function can be called in a given situation by means of a specific function key, the LED assigned to the function key can be turned on by the PLC in this manner.

OP7 Function keys K1 to K4 are all provided with a green LED.

OP17 Function keys K1 to K16 are all provided with a two-color LED (red/green).

Convenient operator prompting can be implemented by means of the option of activating the LEDs on function keys (refer to Chapter 13).

Special feature with soft keys

A bit can be configured in a tag for every soft key. This insures that a bit is set in the PLC when a soft key is pressed. In this instance, the OP always transfers the whole tag to the PLC instead of the individual bits and overwrites the information it contains.

When the key is released or upon a change of display which modifies soft-key assignment, the bit is reset.

11.2 Self-Defined Screen Hierarchy

Defining the screen hierarchy

The screen hierarchy can be adapted to system-specific requirements and be modified either in part or in whole. Screens can be removed or added.

Screens can be linked together in random order. The design, sequence of the link, inclusion in the screen directory and the relevant cross-jump destinations are defined during configuration with ProTool.

Branching using soft keys and cross-jump destinations

You branch between the different screens by means of soft keys and configured cross-jump destinations. Branching from entries of different screens to one and the same screen is possible (figure 11-1). Cross-jumps are not restricted to screen level, but can branch to the message level too.

Defining the start screen

Another feature that is configured is the picture you want to have displayed on the OP as your start screen.

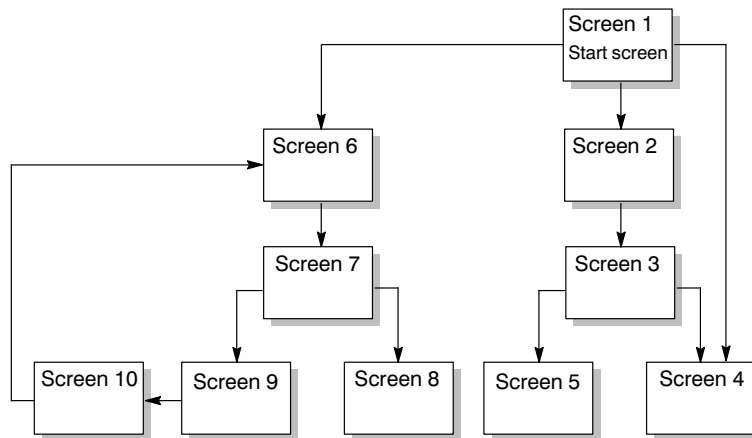

Figure 11-1 Principle of a Screen Hierarchy

An overview is presented below, with reference to an example, of the design of a screen hierarchy. Detailed information on configuration will be found in the *ProTool/Lite User's Guide*.

Example

The OP is used to operate and monitor a system for producing and bottling different fruit juices. The system consists basically of a mixing unit and a bottling machine.

Mixing unit

The ingredients for the fruit juices are contained in three tanks. Depending on the juice that you wish to manufacture, ingredients are mixed in certain ratios.

Bottling machine

After it has been mixed, the fruit juice flows into the bottling tank after a valve has been opened and then bottled in the correct quantities. The bottles are conveyed on a belt. Before being filled, they are checked for breakages. After they have been filled, the bottles are capped, labeled and transferred to pallets.

The configured basic screen could look – for example, on the OP7 display – like the one shown in figure 11-2. It consists of static text only.

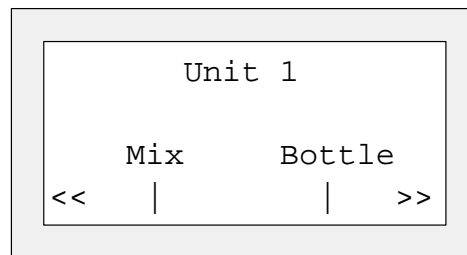

Figure 11-2 Start Screen of the System (Example)

The screen segment on the display can be moved horizontally with the soft keys below the symbol << and >>.

Pressing the soft key beneath the "Mix" entry allows you to view the entry shown in figure 11-3. It similarly consists only of static text which refers to other screens ("Tank2", "Tank3" and "Mixer").

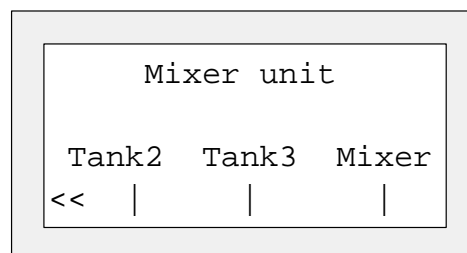

Figure 11-3 Screen with Static Text (Example)

If you press the "Tank2" soft key, the entry displayed in figure 11-4 appears. This entry contains static text and two output fields (Tank Contents and Set Temperature) as well as an input field (Valve Position) The position of the tank valve can be set in the input field by means of a symbolic value input – for example, OPEN or CLOSED).

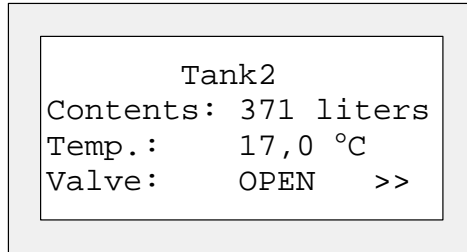

Figure 11-4 Screen with Input and Output Fields (Example)

Schedulers (OP17 only)

Definition

Depending on the configuration, you can specify so-called schedulers for the OP17. A scheduler is a regularly recurring point in time (i.e., hourly, daily, weekly, annually) at which a certain function is to be executed. Up to 48 schedulers and their corresponding functions can be configured

A scheduler is contained in a screen entry where it can be entered, changed or deactivated when the screen is displayed.

When a scheduler time is reached, the configured bit is set in the interface area of the PLC.

See *User's Guide Communication* for detailed information on the interface area of the PLC.

Functions

The following functions can be called via schedulers.

- Print alarm message buffer (chronologically or together)
- Print event message buffer (chronologically or together)
- Select screen
- Print screen
- Print data record



Displaying schedulers

The schedulers have already been preset via configuration. A scheduler can be changed or deactivated via input fields in a screen entry.

The scheduler is activated as long as a time is displayed in the input field. Activated means that the configured function will be executed when the scheduler time is reached. If the input field contains ???, the scheduler is deactivated.

Changing schedulers

Proceed as follows to set a scheduler time.

Step	Procedure
1	Select input field. You can use the cursor keys to switch between scheduler type and day of the week field, and date field and time field.
2	Enter scheduler time. <ul style="list-style-type: none">– Date and time are entered via the system keyboard. Activate the SHIFT-LOCK combination to control the cursor within the input field for date or time using – The day of the week is set via a symbolic entry.
3	Confirm entry with  The scheduler is now activated.

Deactivating schedulers

You can delete the scheduler time in a screen entry by pressing .

The scheduler is then deactivated (i.e., the configured function will not be executed).

Controlling the OP from the PLC

Common data areas

The OP and the application program communicate with each other by alternately reading from and writing to the data areas in the memory of the PLC. Thus the PLC and the OP can make each other execute different actions by evaluating data areas.

PLC jobs

PLC jobs are functions that are initiated on the OP – for example, selecting screens, printing screens, transferring the date and time from the OP to the PLC. Jobs are stored with a job number and parameters on the PLC.

The PLC, for example, can call a screen on the OP to draw the operator's attention to a particular condition or to the fact that inputs are required.

You will find a complete list of all the PLC jobs with their parameters and a description of all the data user areas that have to be configured on the PLC in the *Communication User's Manual*.

LED control

The LEDs on the function keys of the OP can be driven from within the PLC. This means it is possible to signal to the operator by means of a lit key LED that it is advisable to press a specific key in a certain situation.

For LED control, it is necessary to create an LED image on the PLC. In the configuration, two bits are assigned to every LED in the LED image area. These two bits can be used to implement four different LED states:

OP7 Off, Permanently On, Low-Speed Flashing, High-Speed Flashing.

OP17 Off, Green Permanently On, Red Permanently On, Red Flashing.

Evaluating the screen number

The OP stores information about the object type called in the screen number area of the PLC. Thus it is possible for information about the current display contents of the OP to be transferred to the application program on the PLC and, from there, for certain reactions to be initiated – for example, calling another screen.

Function keyboard image

With pressing a function key, it can be used to set a bit on the PLC, where it is evaluated by the application program.

For this, you must have created the necessary data area on the PLC for the keyboard image and have specified the appropriate area pointer in the configuration for assigning the key to a bit.

At most, the activation of two simultaneously pressed keys can be transferred.

System keyboard image

A bit is permanently assigned to every key on the system key board – apart from the arrow keys – in the data area for system keyboard bits. The bit remains set for as long as the corresponding key is pressed. The bit is reset when you release the key.

Owing to the evaluation of this data area, the operator's attention can be drawn to the wrong operation of a key – for example, by means of an error message.

Date and time

Transfer of date and time can be initiated from the OP by means of a PLC job in order to synchronize the OP and PLC.

PLC → OP acknowledgment area

By creating a suitable data area, it is possible for alarm messages to be acknowledged by the PLC instead of on the OP.

OP → PLC acknowledgment area

If the PLC is required to announce that an alarm message has been acknowledged, this can be done following creation of a suitable data area.

Part IV Commissioning and Description of Devices

Installation

14

Commissioning

15

Device Description

16

Mounting location and conditions

Operator Panels OP7 and OP17 are suitable for fitting into control cabinets and consoles.

Before you install an OP, you must cut out a section of the front panel (mounting cutout) (see chapter 16). The front panel must not be thicker than 6 mm. No other drilled holes are required for mounting.

You will find mounting depth details in chapter 16.

Make sure at the location where you plan to install the OP that there is a clearance of at least 50 mm beneath its housing to accommodate protruding connectors.



Caution

- The OP must be brought to room temperature before it is commissioned. In the event of moisture condensation, do not turn on the OP until it is absolutely dry.
 - The OP was subjected to function testing before being supplied to you. Should a fault occur for all that, please enclose a precise description of the fault on returning the OP.
 - To prevent the OP from overheating in operation,
 - the device must not be exposed to direct sunlight (this simultaneously prevents fading of the foil front) and
 - the ventilation slits in the device housing must remain free after mounting.
 - On opening the panel, certain parts of the system become accessible that may conduct hazardous voltage.
-

Degree of protection

The IP65 degree of protection on the front panel can be insured only when the gasket on the front panel of the OP fits properly.

Prior to installation

Should you wish to modify the labels on the function keys, replace the labeling strips before you install the OP. You will find tips on how to replace labeling strips in section 16.3.

14.1 Mechanical Installation

Installing the OP

Step	Procedure
1	<p>Push the enclosed gasket from the rear over the housing and insert the OP from the front in the prepared mounting cutout.</p> <p>Take suitable measures to prevent the OP from falling out of the front panel before it is finally fixed in position.</p>
2	<p>Insert the retaining hooks of the screw type clamps ① enclosed with the OP into the corresponding mounting locations in the housing of the OP.</p> <p>You require four screw type clamps for the OP7 and five for the OP17.</p>
3	<p>Tighten the OP from behind in the front panel using a screw-driver ②.</p> <p>Note: Make sure that the gasket fits properly on the front plate. Avoid excessively high torques.</p>

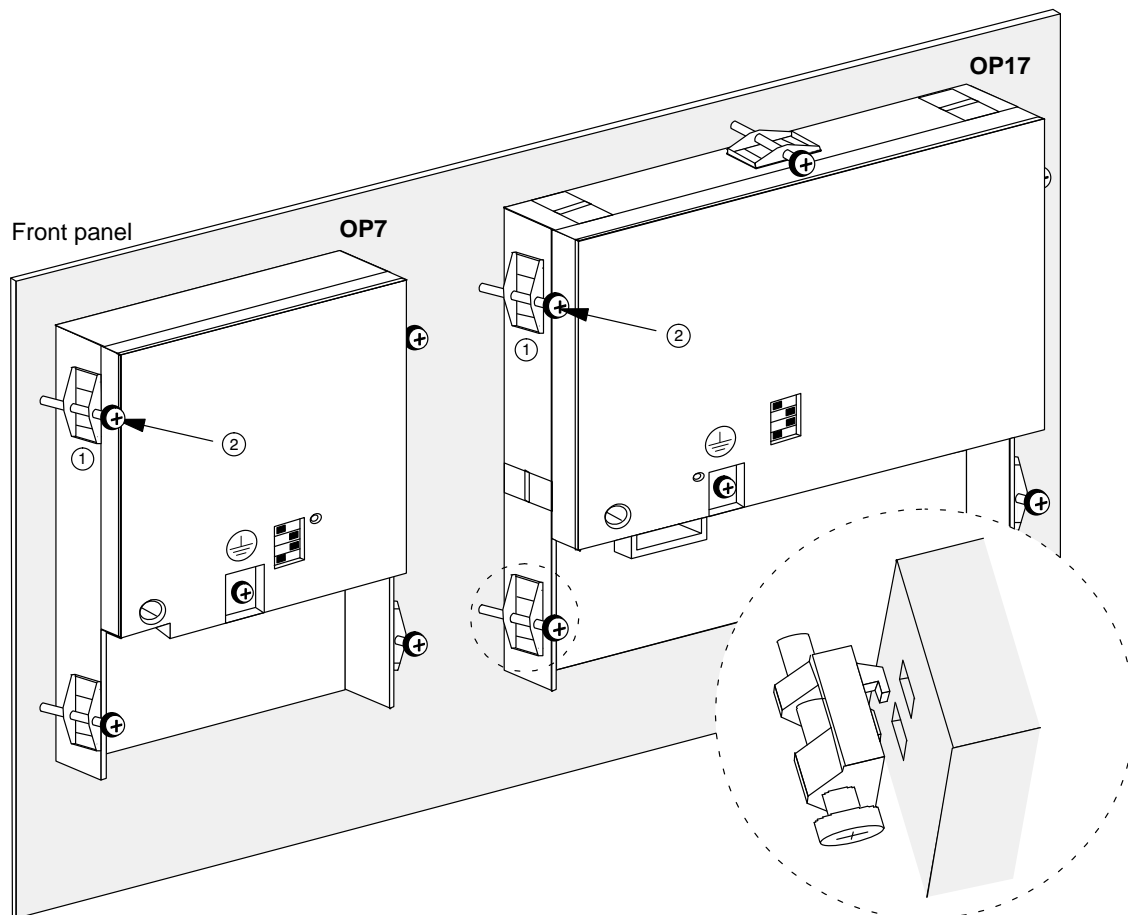

14.2 Electrical Installation

Electrical connections

The OP requires the following electrical connections

- to the power supply,
- to the configuring computer (PC or programming unit),
- to the PLC.

The electrical connection to the configuration computer is required only to download the firmware and configuration.

Interference-proof hardware design

The basis for interference-free operation is interference-proof hardware design of the PLC in accordance with EMC guidelines and the use of interference-proof cables. The guidelines for interference-proof design of your PLCs also apply accordingly for installation of the OP.



Caution

- Use only shielded cable for all signal connections.
 - Screw down or lock all plug connections.
 - Do not install signal lines in the same cable ducts as high voltage lines.
 - Siemens AG accepts no responsibility whatsoever for malfunctions and damage arising from the use of self-made cables or cables from other manufacturers.
-

Polarity reversal protection

The OPs have polarity reversal protection. This does not work if there is already a link to another unit via an RS232 interface. For this reason, always proceed as follows whenever commissioning the OP:

1. Connect the power supply.
2. Switch on the OP. If the OP does not run up, swap over the connections because their polarity is reversed.
3. Once the OP has run up, connect the configuration computer or I/O device.

14.2.1 Connecting the Power Supply

Terminal Block

There is a two-pin screw-type terminal on the lower side of the OP housing for connecting the power supply. The screw-type terminal is designed for cables having a cross-section not larger than 2.5 mm². The terminal screws are accessible via drill holes in the rear panel.

Figure 14-1 shows the location of the screw-type terminals on the OP7 and OP17.

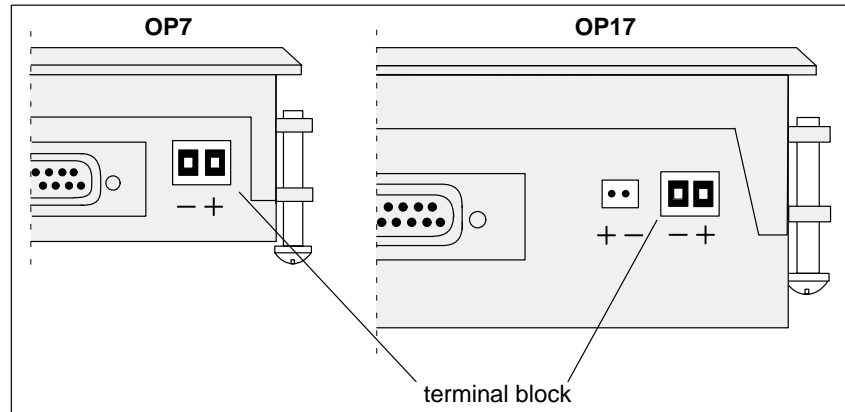



Figure 14-1 Connecting the Power Supply (View of Underside of OP)



Caution

- With a 24 V supply, make sure the extra-low voltage is isolated safely. Use only power supplies complying with ICE 364-4-41 or HD 384.04.41 (DE 0100. Part 410).
- The voltage supply must be within the permissible voltage range for the device in question (see chapter C), otherwise it is not possible to exclude the possibility of failures.

Chassis ground

Connect the chassis ground  on the bottom of the device to the cabinet ground.

14.2.2 Connecting a Configuration Computer

Connection Configuration Scheme

Figure 14-2 shows you how to connect an OP7 and an OP17 temporarily to a configuration computer (PU or PC) for downloading the firmware and configuration data. Standard cables are available for the connections shown in the figure (refer to the ST80.1 catalog).

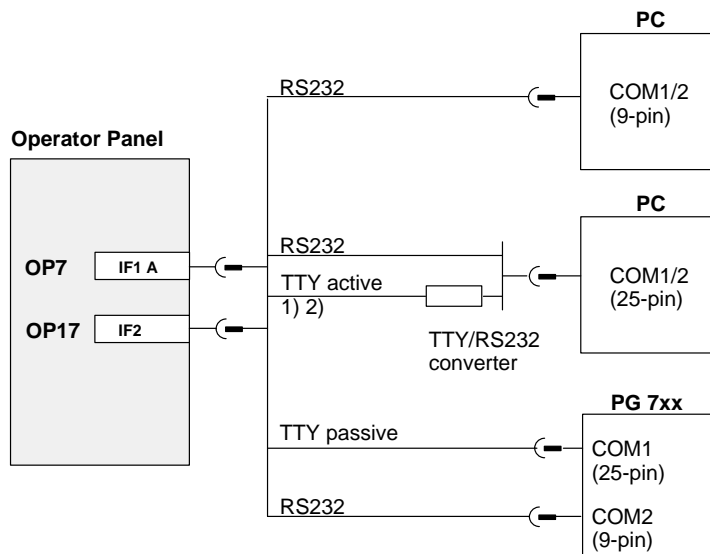

- 1) Not with OP7-DP and OP17
- 2) Do not use the converter cable from Siemens for connecting via TTY, since OP7-DP and OP17 do not supply 20 mA.

Figure 14-2 Connection Configuration Scheme for Configuration Computers

14.2.3 Connections to PLC

Connection Configuration Scheme

Figure 14-3 shows the basic options for connecting the OP to the PLC. For further details concerning the different OP versions please refer to Tables 16-1 and 16-2 in Chapter 16. Standard cables are available for the connections shown in the figure (refer to the ST80.1 catalog).

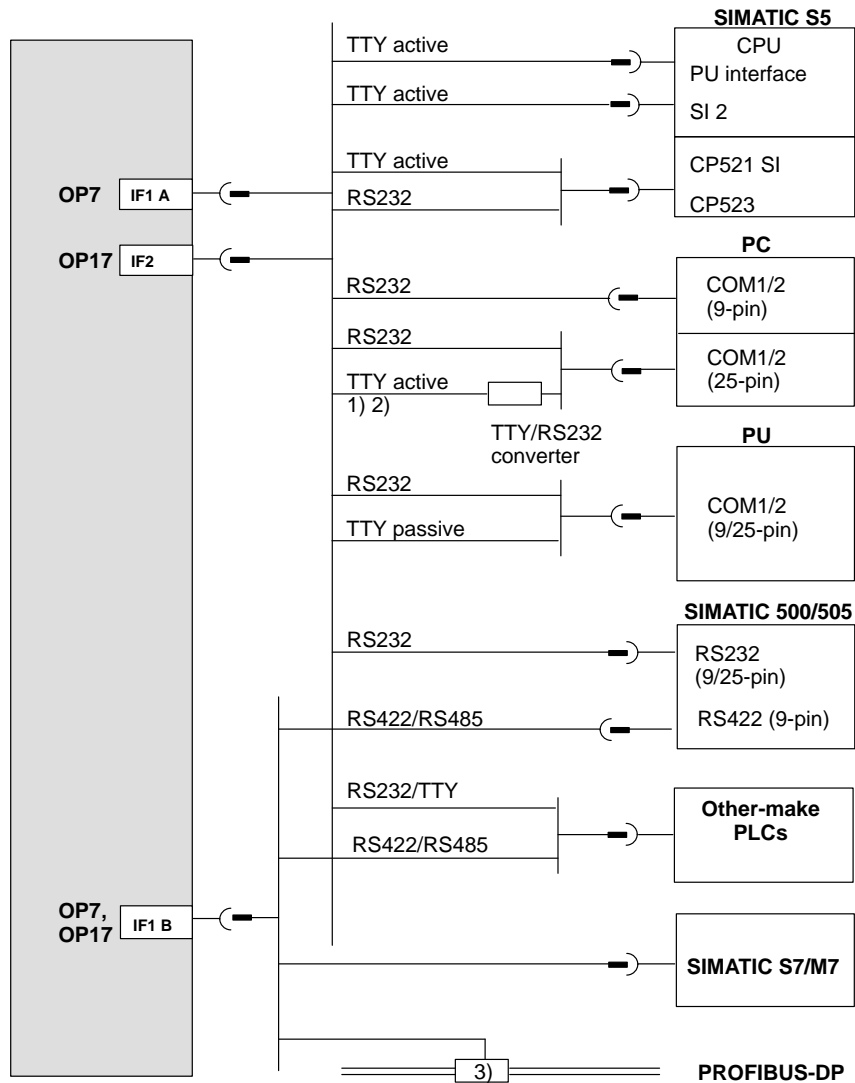

- 1) Not with OP7-DP and OP17-DP
- 2) Do not use the converter cable from Siemens for connecting via TTY, since OP7-DP and OP17-DP do not supply 20 mA.
- 3) Any PROFIBUS bus terminal (except FSK)

Figure 14-3 Connection Configuration Scheme for PLCs

Configuring interface IF1B

You can configure interface IF1B using the DIP switch at the rear of OP versions DP and DP-12. This involves changing over the RS422 receive data and the RTS signal. By default, the RTS signal is not required by the communicating peer.

The table shows the permissible settings for the DIP switch.

Communication via		Switch Position			
		1	2	3	4
RS422/RS485		OFF	ON	ON	OFF
PROFIBUS-DP	RTS at Pin 4 (default)	ON	OFF	OFF	OFF
	RTS at Pin 9 (as PG)	OFF	OFF	OFF	ON
	No RTS on connector	OFF	OFF	OFF	OFF

You will find the interface assignments of the different OP versions in appendix D of this manual.

14.2.4 Loop-Through Mode (OP17 only)

Connection Configuration Scheme

The IF1 interface of the OP17 is optionally available for the loop-through mode of a configuration computer (PU or PC). This enables communication between the PU or PC and the PLC via the OP17.

Standard cables are available for the connections in AS511 loop-through mode shown in Figure 14-4 (refer to the ST80.1 catalog).

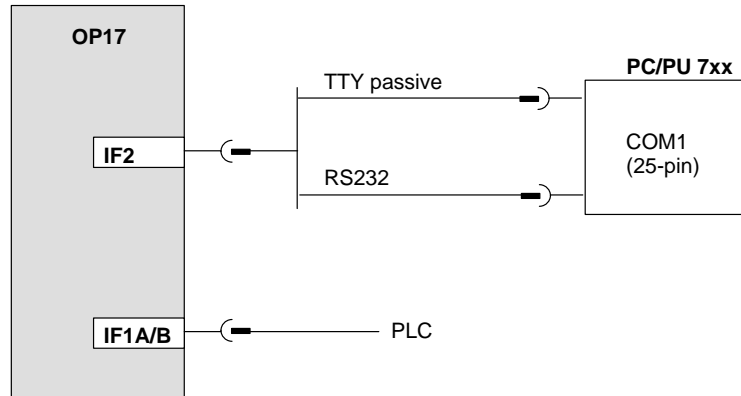

Figure 14-4 Connection Configuration Scheme for AS511 Loop-Through Mode

Constraints in loop-through mode

- Print functions of the looped-through OP cannot be used.
- The OP does not perform life-bit monitoring, i.e. it cannot detect whether the PLC is in Stop mode, for example. Life-bit monitoring continues to be performed on the PLC.
- System performance may deteriorate due to higher loading of the interface to the PLC.

Particularities for connection of a PU

If PU status functions are activated (message on PU: "Status processing in progress" – for example, for STATUS VAR, FORCE VAR),

- the following system message is displayed on the Operator Panel "\$340 Status in progress, loop- through mode",
- the OP can no longer be operated,
- communication between the OP and the PLC is stopped. There is therefore little sense in evaluating error number 115 of the standard FB on the PLC in this particular instance.

Upon termination of status functions by means of the ESC key on the PU, OP functions are resumed.

If "Apply" is pressed **once only** with Force VAR after a value has been entered, the value you entered is transferred to the PLC, and the status function of the PU is still not active. This value (for example, a message bit or an actual value) can still be read by the looped-through OP and processed (for example, display of the associated message or the actual value). Not until "Apply" is pressed a second time is the PU status function activated.

14.2.5 Connecting a Printer

Connection Configuration Scheme

Figure 14-5 shows you how to connect a printer to an OP7 and an OP17. A printer is always connected to the PU interface of the OP. To do this, disconnect the PU.

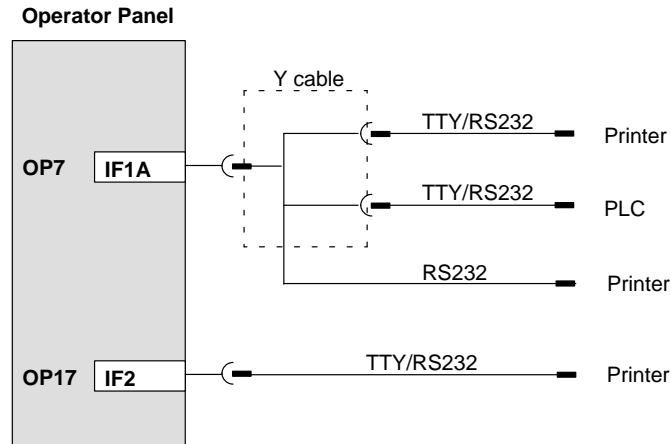

Figure 14-5 Connection Configuration Scheme for Printers

If the OP is connected to the PLC through a TTY or RS232 interface, a Y cable is required for simultaneous operation of a printer. The PLC and printer, in this case, are operated with physically different interfaces.

For attaching Siemens printers, there are standard cables available (refer to Catalog No. ST80.1). For other printers, you have to use the cables supplied or specially manufactured ones.

You will find the pin assignments of the plug connectors in appendix D of this manual.

Print functions

The OP makes the following print functions available:

- hardcopy
- printout of screens
- printout of alarm or event buffer
- direct message logging
- printout on buffer overload
- printout of data records
- printout of recipe directory
- printout of screen directory

Settings

The settings of parameters for the print functions, the printer interface and the printer are configured.

Section 10.2 describes how you can modify the default printer parameters in Online mode. You will find the requisite printer settings in the User's Manual for your printer.

Print function settings

You can configure headers and footers for the print functions in various configurations and text with different attributes – for example, underline, *italics*).

The text attributes have to be stored in ProTool for the different printers under *System* → *Printer* → *Settings* by using different control characters.

Commissioning

Diagrammatic representation

The commissioning guide which follows explains the different steps that have to be taken to commission the OP. Figure 15-1 shows the most important steps for initial commissioning, recommissioning and normal operation of the OP.

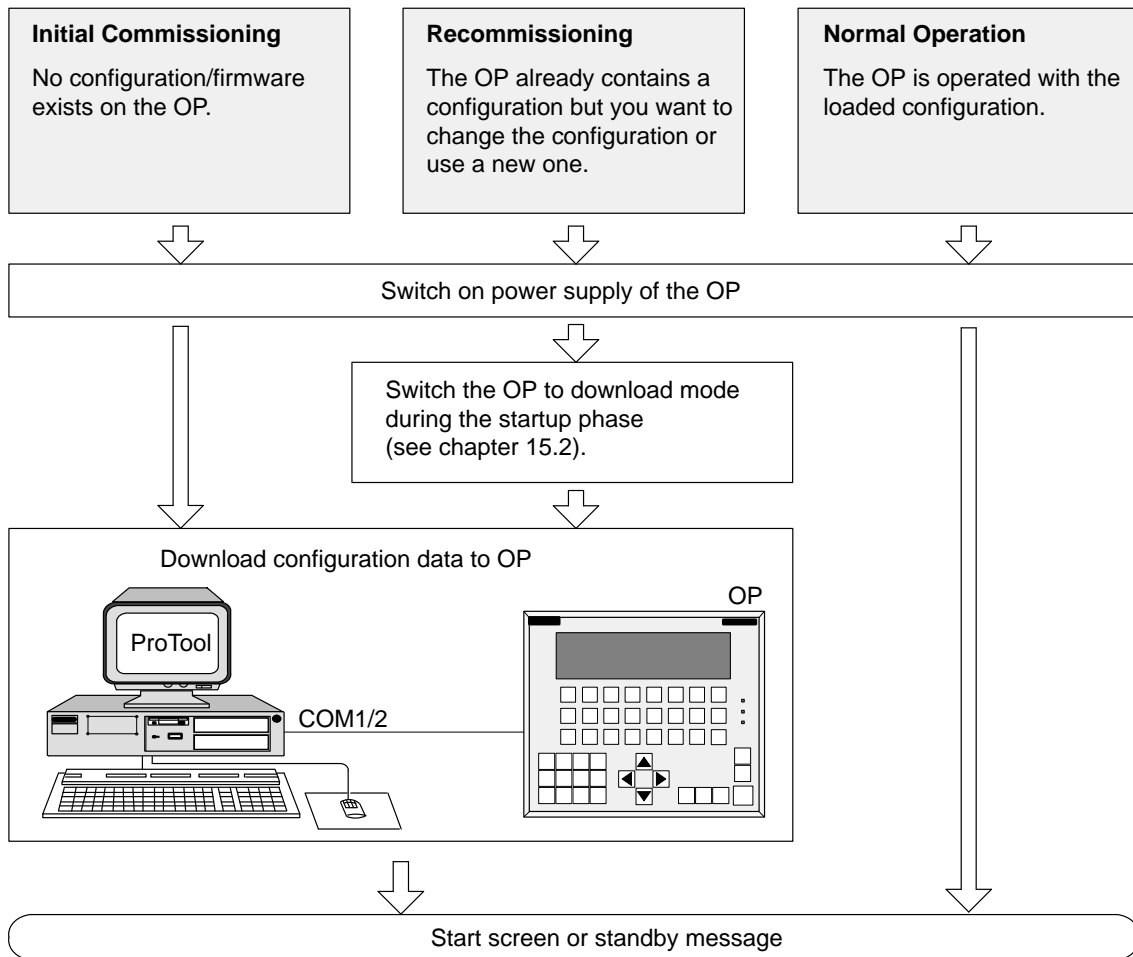

Figure 15-1 Commissioning Flowchart

Before commissioning



Before commissioning the OP, take note of the following:

Caution

- With the SIMATIC S5, compression of the internal program memory of the PLC (PU "Compress" function, integrated COMPR FB) is not allowed when an OP is connected. Compression modifies the absolute addresses of the blocks in the program memory. As the OP reads the address list only during start-up, it does not detect any address modifications and accesses the wrong memory areas.

If compression is inevitable during routine operation, turn off the OP prior to compression.

- Do not disconnect while circuit is live unless location is known to be nonhazardous.
-

15.1 Initial commissioning

Procedure

Initial commissioning comprises loading the firmware required to enable the OP to function and the configuration onto the OP. You do this as follows:

Step	Procedure
1	<p>Switch on the OP's power supply. ¹⁾</p> <p>Since a configuration has not yet been loaded at this point in time, the OP automatically switches to download mode and waits for data to be downloaded from the configuration computer (PC/PU).</p> <p>You are not able to operate the OP in this mode.</p>
2	<p>Using a suitable standard cable, connect the configuration computer to the interface of the OP:</p> <ul style="list-style-type: none"> • IF1A for OP7 • IF2 for OP17
3	<p>Start the download operation to the OP on the PC or PU.</p> <p>The OP checks the link to the PC or PU. If a link is not available or if it is not functioning properly, the OP issues a corresponding error message.</p> <p>If the link is in order, downloading of the configuration from the PC or PU is initiated to the OP.</p> <p>As long as data are not being downloaded to the OP, you can cancel Download mode by pressing </p>

¹⁾ Switch on the power supply **before** you connect the OP to the configuration computer. If you don't, the internal polarity reversal protection function of the OP can be rendered ineffective if the polarity of the power supply is reversed.

Note





Please refer to the *ProTool/Lite User's Guide* for the ProTool settings required for downloading.

Once the configuration has been successfully downloaded, the OP runs up again. If a start screen has been defined in the configuration, it is opened. If a start screen has not been defined, the OP displays the standby message.

15.2 Recommissioning

Procedure

If you want to replace a configuration already loaded on the OP with another one, proceed as follows:

Step	Procedure
1	Using a suitable standard cable, connect the configuration computer (PU or PC) to the interface of the OP: <ul style="list-style-type: none"> • IF1A for OP7 • IF2 for OP17
2	Switch on the power supply of the OP.
3	There are two ways to switch the OP to download mode: <ul style="list-style-type: none"> • While normal operation is in progress By calling the standard screen <i>System settings</i> → <i>OpMode</i> → <i>Download</i>. If necessary, enter the password for the required password level beforehand. • During the startup phase of the OP When switching on the power supply of the OP, press these three keys at the same time. <div style="display: inline-block; text-align: center; margin: 5px;">  +  +  </div> <p>This key combination ("overall reset") deletes the configuration memory.</p> <p>The OP then switches to download mode and waits for data to be downloaded from the PC/PU.</p>
4	Start the download operation to the OP on the PC or PU. The OP checks the link to the PC or PU. If a link is not available or if it is not functioning properly, the OP issues a corresponding error message. If the link is in order, downloading of the configuration from the PC or PU is initiated to the OP. In doing so, the present configuration on the OP is overwritten by the new one. As long as data are not being transferred between the PC/PU and the OP, you can cancel Download mode by pressing <div style="display: inline-block; text-align: center; margin-left: 20px;">  </div>

Once the configuration has been successfully downloaded, the OP runs up again. If a start screen has been defined in the configuration, it is opened. If a start screen has not been defined, the OP displays the standby message.

Fault diagnosis

Any fault occurring during commissioning or in operation is normally displayed by means of an error message on the display of the OP.

You will find an overview of the most important system messages together with notes on troubleshooting in an appendix to this manual.

15.3 Start-up Behavior

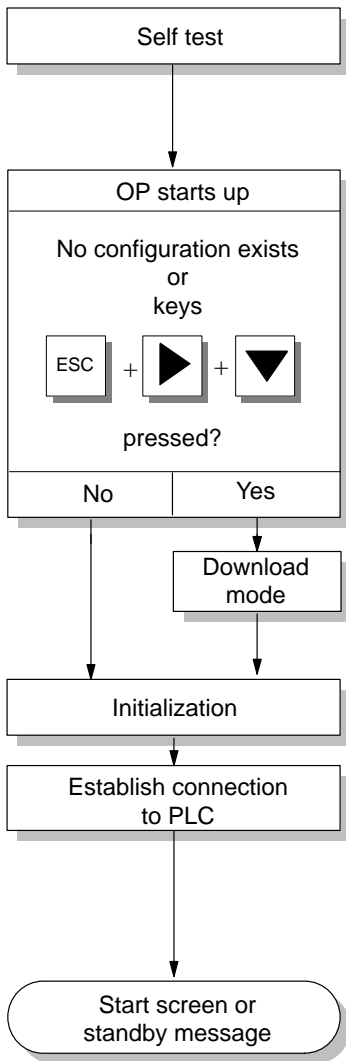

After the power supply has been turned on, the OP performs a self test. In the test, it checks the operability of the most important device components and displays the test results.

If there is not a configuration on the OP, the OP switches automatically to Download mode.

The OP then performs various internal initializations.

In this start-up phase, the OP attempts to establish a connection to the PLC.

If communication is not possible – for example, because the cable to the PLC has not been inserted – the OP displays a system message.

After start-up, the OP displays the configured start screen. If a start screen has not been defined, the standby message is displayed.

15.4 Testing the Configuration in OFFLINE Mode

Purpose

In *OFFLINE* mode, you can test the different functions and the configurations downloaded from the PC or PU independently of the PLC.

In OFFLINE mode, tags are not updated.

Procedure

Step	Procedure
1	Switch the OP to OFFLINE mode using the standard screen <i>System settings</i> → <i>OPMode</i> .
2	Check all configured screens for proper display.
3	Check the screen hierarchy.
4	Check the input fields.
5	Test the soft keys.
6	Check the different items of message text.
7	Test the function keys.

End of test

If errors occur when you perform the tests, you must download the configuration again.

15.5 Testing the Configuration in Conjunction with the PLC

Test with PLC connected

Once the tests in OFFLINE mode have been performed successfully, the OP is tested in conjunction with the PLC that you connected. This test determines whether the correct data areas have been configured.

Procedure

Step	Procedure
1	Connect the OP to the PLC.
2	Proper connection is indicated on the OP by a corresponding message.
3	Acknowledge this message.
4	Switch the OP to <i>ONLINE</i> mode by means of the standard screen <i>System settings</i> → <i>OPMode</i> . You can now test all items in your configuration for which communication with the PLC is necessary. Depending on the configuration, this might be <ul style="list-style-type: none">• event and alarm messages,• buffers for event messages and alarm messages,• print functions,• automatic message printout,• screen selection, etc.

Tip

The OP17 has the built-in "**loop-through mode**" function.

The loop-through mode facilitates testing with the PLC during commissioning since there is then no need to keep on plugging the configuration computer alternately into the PLC and the OP.

15.6 Testing Communication via the PROFIBUS-DP

Bus fault LED

Mounted on the rear side of unit variants DP and DP-12 is a bus fault LED (figure 15-2). When the OP is connected to SIMATIC S7, this LED indicates that communication between the OP and the PLC over PROFIBUS-DP is OK by lighting up constantly. If the LED is constantly OFF, communication is disturbed.

The LED can be used for rapid diagnosis of any problems that might occur during communication.

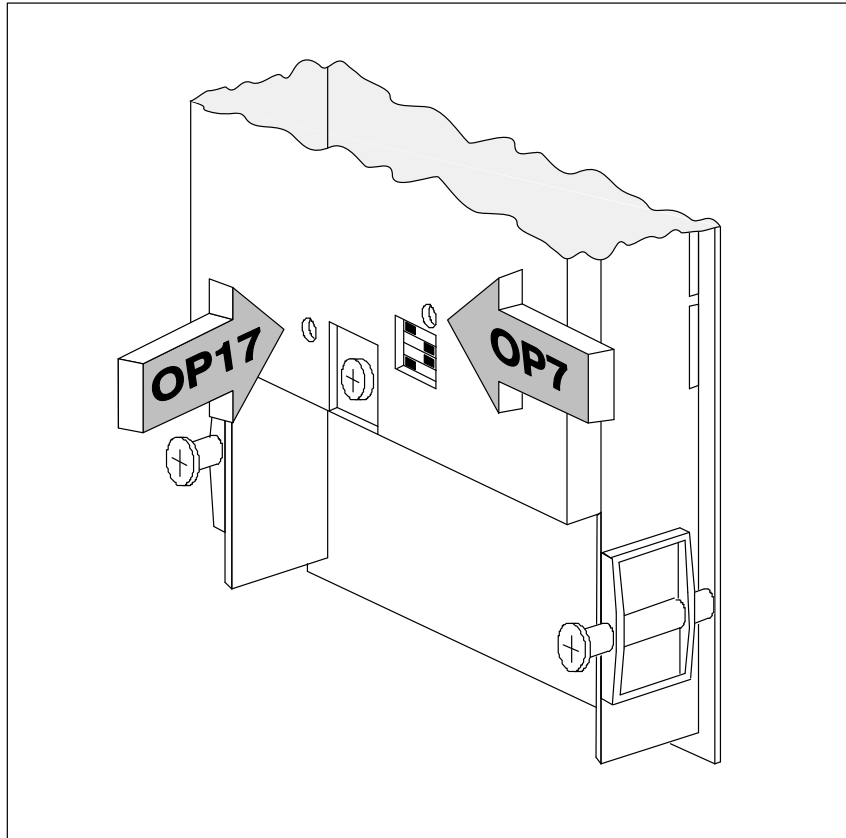

Figure 15-2 Location of the Bus Fault LED at the Rear of the OP

16

Device Description

In this chapter

This chapter describes the versions, dimension drawings and connection elements of Operator Panels OP7 and OP17.

16.1 OP7

Dimensions

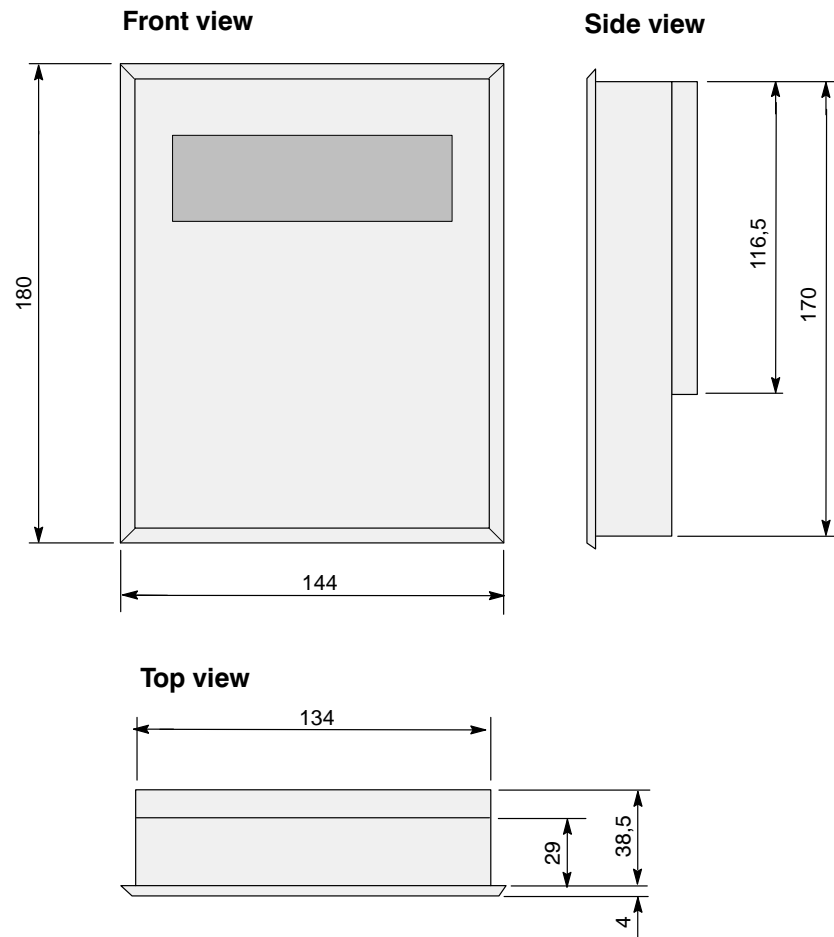

Mounting cutout

The OP7 requires the following mounting cutout (WxH):
135 ⁺¹ mm x 171 ⁺¹ mm.

Connection elements

The OP7 is available in versions PP, DP and DP-12. The versions differ only in as far as their communication options are concerned (refer to table 16-1). Figure 16-1 shows the connection elements on the underside of the OP7.

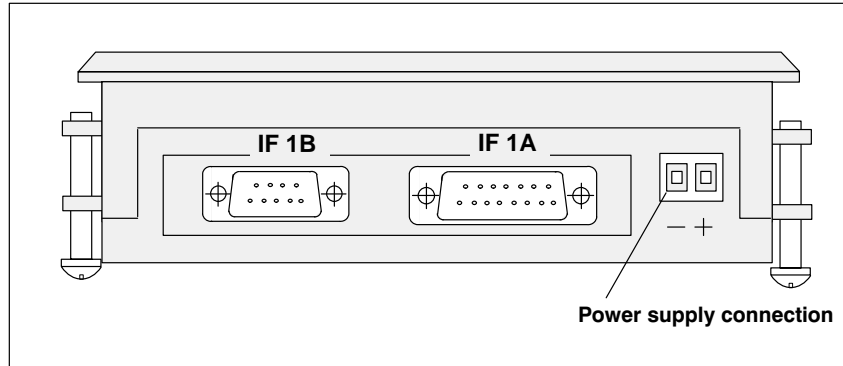

Figure 16-1 Locations of the Connection Elements on the Underside of the OP7

Table 16-1 Communication Options Featured by Different OP7 Versions

Connections	OP7		
	PP	DP	DP-12
SIMATIC S5			
– AS511 (TTY)	IF 1A	—	IF 1A
– FAP (TTY/RS232)	IF 1A	—	IF 1A
– PROFIBUS-DP up to 1.5 MBd	—	IF 1B	IF 1B
– PROFIBUS-DP up to 12 MBd	—	—	IF 1B
SIMATIC S7/M7			
– PPI	—	IF 1B	IF 1B
– MPI	—	IF 1B	IF 1B
– PROFIBUS-DP up to 1.5 MBd	—	IF 1B	IF 1B
– PROFIBUS-DP up to 12 MBd	—	—	IF 1B
SIMATIC 500/505			
– RS232	IF 1A	—	IF 1A
– RS422/RS485	IF 1B	—	IF 1B
Other PLCs			
– RS232/TTY	IF 1A	—	IF 1A
– RS422/RS485	IF 1B	—	IF 1B
PC/PU (TTY)	IF 1A	—	IF 1A
PC/PU (RS232)	IF 1A	IF 1A	IF 1A
Printer (TTY)	IF 1A	—	IF 1A
Printer (RS232)	IF 1A	IF 1A	IF 1A

16.2 OP17

Dimensions

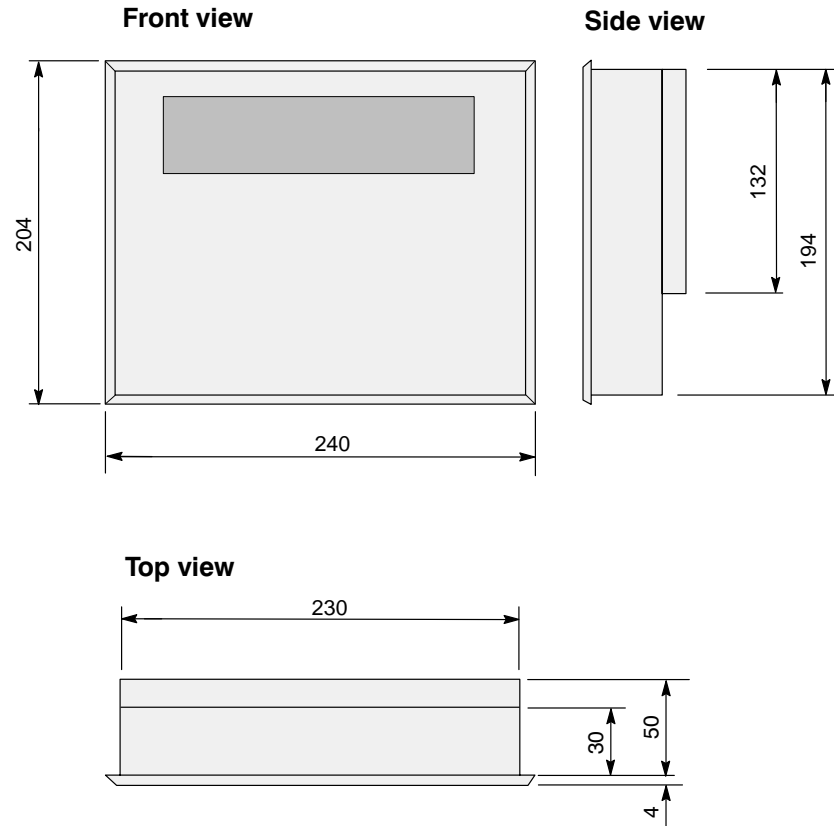

Mounting cutout

The OP17 requires the following mounting cutout (WxH):
231 ⁺¹ mm x 195 ⁺¹ mm.

Connection elements

The OP17 is available in versions PP, DP and DP-12. The versions differ only in as far as their communication options are concerned (refer to table 16-2). Figure 16-2 shows the connection elements on the lower side of the OP17.

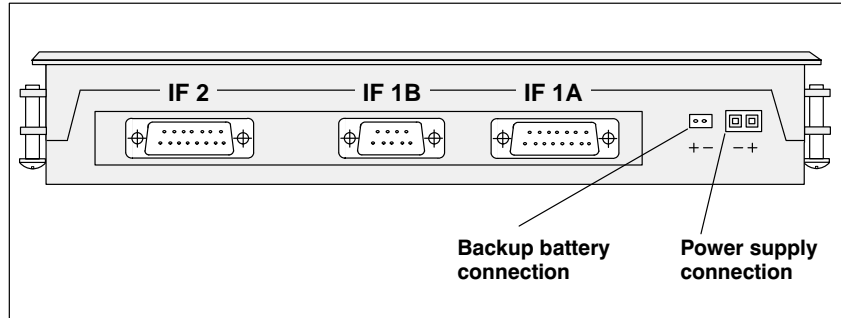

Figure 16-2 Locations of the Connection Elements on the Underside of the OP17

Table 16-2 Communications Options Featured by Different OP17 Versions

Connections	OP17		
	PP	DP	DP-12
SIMATIC S5			
– AS511 (TTY)	IF 1A	—	IF 1B
– FAP (TTY/RS232)	IF 1A	—	IF 1B
– PROFIBUS-DP up to 1.5 MBd	—	IF 1B	IF 1B
– PROFIBUS-DP up to 12 MBd	—	—	IF 1B
SIMATIC S7/M7			
– PPI	—	IF 1B	IF 1B
– MPI	—	IF 1B	IF 1B
– PROFIBUS-DP up to 1.5 MBd	—	IF 1B	IF 1B
– PROFIBUS-DP up to 12 MBaud	—	—	IF 1B
SIMATIC 500/505			
– RS232	IF 1A	—	IF 1A
– RS422/RS485	IF 1B	—	IF 1B
Other PLCs			
– RS232/TTY	IF 1A	—	IF 1A
– RS422/RS485	IF 1B	—	IF 1B
PC/PU (TTY/RS232)	IF 2	IF 2	IF 2
Printer (TTY/RS232)	IF 2	IF 2	IF 2

16.3 Labeling of the Function Keys

Situation on delivery

The function keys of the OP7 and OP17 are labeled as follows when delivered:

- **OP7:** F1 to F4 and K1 to K4.
- **OP17:** F1 to F8, K1 to K8 and K9 to K16.

Replacing labeling strips

All the function keys are labeled by means of labeling strips, which are inserted in the keyboard from the rear of the OP. For this purpose, the OP has been provided with an easy-to-use feed-in device. By replacing the labeling strips, you are in a position to customize the function keys on your OP for a given system.

Two labeling strips are provided for the OP7 and three for the OP17. Labeling strips should be replaced only when the OP has been disassembled. To replace labeling strips, proceed as follows:

1. Remove from the OP the labeling strips you wish to replace.
2. Insert the new strips from the rear of the OP into the corresponding slits located on the side of the OP.

Figure 16-3 illustrates, by way of an example, how to replace labeling strips on an OP7.

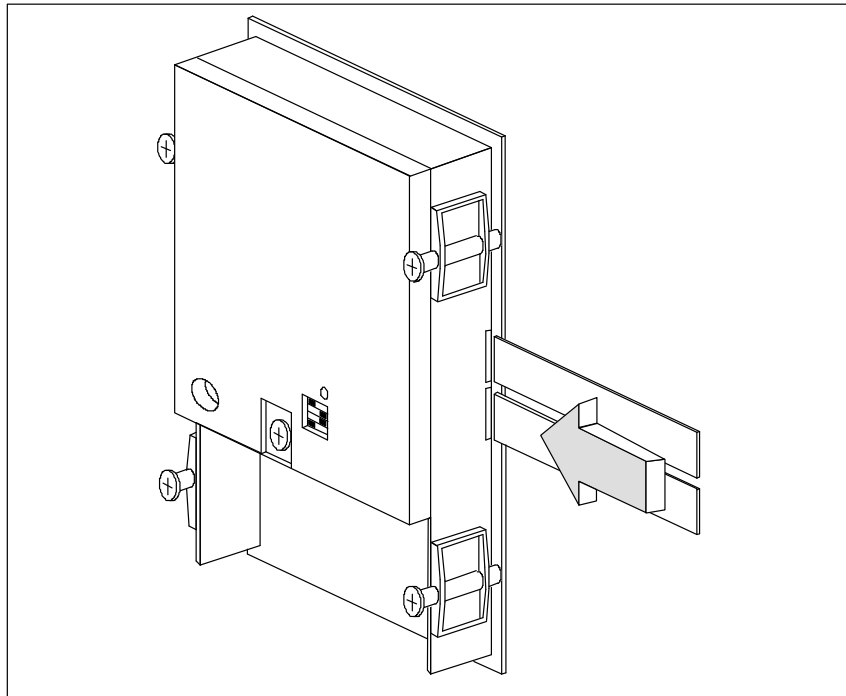

Figure 16-3 Replacing Labeling Strips (Shown Here for an OP7)

Note

Take note of the following points before you insert labeling strips:

- Labeling on strips must be smudge-proof before they can be inserted. If a keyboard overlay is soiled on the inside, it cannot be cleaned and has to be returned to the manufacturer for replacement.
- Protect the labeled side with transparent adhesive tape. In this way, you prevent the labeling from being worn out prematurely.

Making labeling strips

Make labeling strips from transparent foil so that the LEDs on function keys remain visible. Use a printer or a smudge-proof pen to label the foil. Cut strips as shown in the examples illustrated in figures 16-4 (OP17) and 16-5 (OP7).

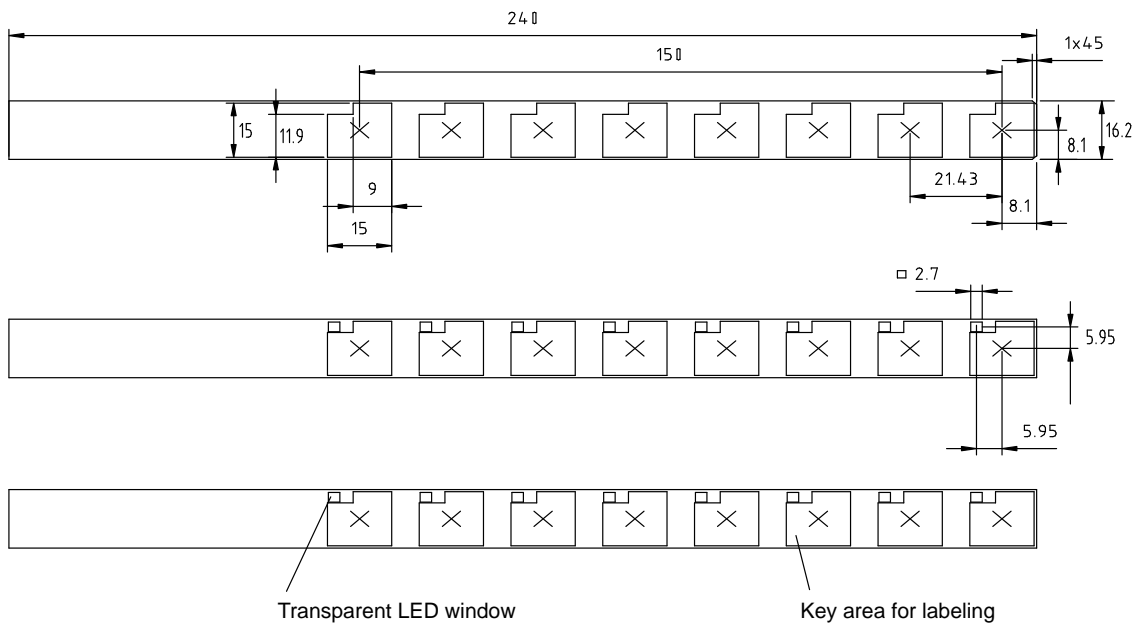

Figure 16-4 Dimensions of Labeling Strips for the OP17

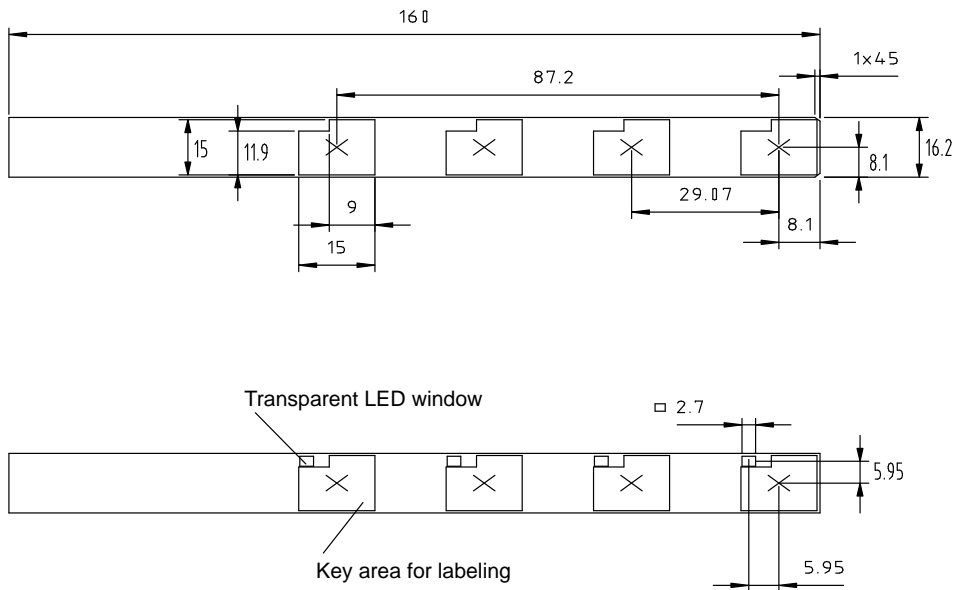

Figure 16-5 Dimensions of Labeling Strips for the OP7

File

Together with the ProTool configuration software in the PROTOOL\UTILITY folder the Word[™] files SLIDE_07.DOC and SLIDE_17.DOC are supplied. The files contain formatted samples of the labeling for function keys on the OP7 and OP17. This means that you can readily edit and print your own labeling strips.

16.4 Optional Backup Battery for the OP17

Function You can upgrade the OP17 with an optional backup battery. When the power supply is interrupted, the backup battery ensures that

- the operating data in the OP17 message buffer are retained and
- the hardware clock continues to run on its internal reserve power.

Source of supply You can obtain the backup battery from the Siemens spare parts service. It is shipped ready for installation with a cable and a plug connector. Please refer to our ST80.1 catalog for the order number.

Lifetime Under normal operating conditions, the battery has a typical lifetime of approximately four years. The discharge degree of the battery is not monitored by the OP17.

Installing the battery To install the battery, proceed as follows:

Step	Procedure
1	Remove the cover of the battery compartment at the rear of the OP17.
2	Insert the battery into the holding fixture. The snap-in plastic supports hold the battery in its compartment.
3	Insert the plug connector on the battery lead in the two-pin plug connector above the battery compartment. The plug connector is coded and is thus protected from accidental polarity reversal.
4	Stow any excess length of lead in the battery compartment and close the compartment again.

General information

Please comply with the safety information that is included with the battery and informs you how to handle and dispose of lithium batteries in the proper manner.



Warning

- Explosion hazard! There is a danger of the lithium battery exploding if it is not handled properly.
- Batteries
 - Never charge
 - Do not open
 - Do not short circuit
 - Do not reverse the polarity
 - Do not heat up to above 100°C
 - Protect against direct sunlight
- Never allow moisture to condense on batteries.
- If it becomes necessary to transport the batteries, always comply with the Dangerous Goods Ordinance for the mode of transport used (labeling obligation).
- Dead lithium batteries are classified as hazardous waste and must be disposed of accordingly. Wrap each battery separately in a sealed plastic bag before disposing of it along the approved lines.

16.5 Maintenance

Scope

Operator panels OP7 and OP17 are designed for low-maintenance operation. Maintenance of the OPs is limited to

- regular cleaning of the keyboard membrane and the display,
- changing the optional buffer battery of the OP17 (refer to Section 16.4).

Cleaning

Clean the keyboard overlay and the OP display at regular intervals with a damp cloth. The unit must be OFF when it is cleaned. In this way, you ensure that you don't unintentionally trigger any functions while wiping the keyboard overlay.

Use only water and commercially available washing-up liquid for dampening the cloth. Never use aggressive solvents or scouring agents.

Part V Appendix

Brief Description of
Standard Screens

A

System Messages

B

Technical Data

C

Interface Assignment

D

SIMATIC HMI Documentation

E

Siemens Worldwide

F

Brief Description of Standard Screens

A

The table below presents an overview of all the standard screens for Operating Panels OP7 and OP17. Apart from a brief comment on functions, mention is made of the requisite password level. The "Level 1" column lists the screens that you can choose from the basic screen. These screens allow you to make different calls, which are listed under "Level 2".

Level 1	Level 2	Function	Password Level
<i>Alarms</i> →	<i>View</i>	<ul style="list-style-type: none"> • Display alarm messages in alarm buffer • Display message text for message selected in alarm buffer. 	0
<i>Alarms</i> →	<i>Print</i>	Print alarm messages as history, i.e. all message events (arrive, depart, acknowledge) in chronological order of their occurrence.	2
<i>Alarms</i> →	<i>Number</i>	Display the messages entered in buffer, divided into 'messages over-all' and 'queuing messages'.	0
<i>Alarms</i> →	<i>Delete</i>	Delete all acknowledged and departed alarm messages from the buffer.	6
<i>Alarms</i> →	<i>Overflow</i>	Enable and disable a system message upon over flow of the alarm buffer.	4
<i>Alarms</i> →	<i>Text</i>	Display all text elements of alarm messages	0
<i>Events</i> →	<i>View</i>	<ul style="list-style-type: none"> • Display event messages in event buffer. • Display message text relating to a message selected in event buffer. 	0
<i>Events</i> →	<i>Print</i>	Print event messages as history, i.e. all message events (arrive, depart) in chronological order of their occurrence.	2
<i>Events</i> →	<i>Number</i>	Display messages entered in the buffer, divided into 'messages over-all' and 'queuing messages'.	0
<i>Events</i> →	<i>Delete</i>	Delete all event messages in the event buffer that have arrived and departed.	6
<i>Events</i> →	<i>Overflow</i>	Enable and disable system message upon overflow of event buffer.	4
<i>Events</i> →	<i>Text</i>	Display all text elements of event messages	0
<i>Screens</i> →	<i>Edit</i>	<ul style="list-style-type: none"> • Display directory for screens. • Display screens and edit fields 	0
<i>Screens</i> →	<i>Print</i>	<ul style="list-style-type: none"> • Display directory for screens. • Output selected screen to printer. 	2

Level 1	Level 2	Function	Password Level
<i>Record</i> →	<i>Edit</i>	<ul style="list-style-type: none"> • Display directories for recipes • Display and edit data records 	1
<i>Record</i> →	<i>Transfer</i>	<ul style="list-style-type: none"> • Copy data record • Transfer data record from PLC to OP • Fetch data record from PLC to OP 	1
<i>Record</i> →	<i>Print</i>	Print recipe with selected data record	2
<i>System settings</i> →	<i>OPMode</i>	Set OP operating modes: Online, Offline, Download, Loop-through	8
<i>System settings</i> →	<i>DispMsg</i>	Set whether the oldest (first) or latest (last) alarm message is displayed when there is more than one message waiting.	4
<i>System settings</i> →	<i>SysMsg</i>	Display system buffer.	0
<i>System settings</i> →	<i>Language</i>	Select language.	2
<i>System settings</i> →	<i>Dat/Time</i>	Set date and time	4
<i>System settings</i> →	<i>Printer</i>	Set printer parameters.	2
<i>System settings</i> →	<i>IF1A/RS232</i> <i>IF1A/TTY</i> <i>IF1B</i> <i>IF1A/B</i> <i>IF2</i>	OP7 only: Set interface parameters. OP17 only: Set interface parameters.	6
<i>StatVAR</i>		Display S5/S7 operands	0
<i>ForceVAR</i>		Display and modify S5/S7 operands.	8
<i>Password processing</i> →	<i>Login</i>	Log in a user by entering a password.	0
<i>Password processing</i> →	<i>Logout</i>	Log out a user and branches backward to message level.	0
<i>Password processing</i> →	<i>Edit</i>	<ul style="list-style-type: none"> • Display password list. • Allocate and modify passwords and password levels. • Delete passwords. 	9

System Messages

Error messages at OP startup

The following messages indicate a hardware failure on the memory module specified:

- **EPROM memory failure,**
- **RAM memory failure,**
- **Flash memory failure**

Message number

OP system messages can be subdivided into various categories.

The information as to which category a system message belongs to is contained in the message number as indicated below.

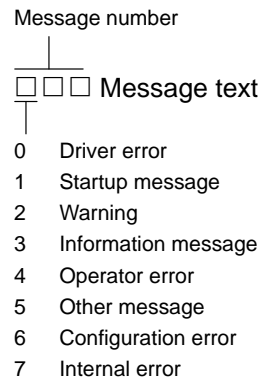

The message category enables you to identify the general area in which the cause of the fault is to be found.

Below you will find a selection of system messages listed together with details of under what circumstances they occur and, where applicable, how the cause of the fault can be eliminated.

Self-explanatory system messages are not included.

Note

System messages are displayed in the language selected in the configuration. If the OP does not have access to any configuration data, the messages are displayed in English.

**Procedure for
"internal errors"**

In the case of all system messages that relate to "internal errors", please follow the procedure outlined below.

- a) Switch off the OP, set the PLC to STOP mode and then restart both units.
- b) During startup, set the OP to download mode, download the configuration again and then restart the OP and PLC again.
- c) If the fault recurs, please contact your nearest Siemens representative.
When doing so, please quote the number of the error that has occurred and any variables referred to in the message.

Message	Cause	Remedy
Please wait	Mode change in progress or recipe function started.	
Ready for transfer	Waiting for data from PU/PC	
Data transfer	Data transfer between PU/PC and OP in progress	
Firmware not compatible	The firmware can not be used for the current configuration	
EPROM memory failure	Memory module defective or internal hardware fault	Send unit for repair quoting details of error message
RAM memory failure		
Flash memory failure	Memory module defective or transmission error	Retransfer configuration or send OP for repair

Message	Cause	Remedy:
005	<i>Internal error:</i> Error message returned if nothing configured for a system message	
006	Error during data transfer in download mode. Two variables are transferred with this message which contain information about the function in which the error has occurred (variable 1) and the cause of the error (variable 2). Variable 1: 0 Initialize function 1 Receive data 2 Send data 3 Send message block 4 Terminate function Variable 2: 1 Internal error 3 Timeout error 5 Parity error 6 Framing error 7 Overrun error 8 Break in line 9 Receive buffer overflow 10 Control character error when receiving 11 Logging error	Repeat data transfer after first checking the physical connection if necessary.
040	Driver error If FAP is set, the character delay time setting may be too short.	Check physical connection with PLC. Modify character delay time.
041	Fault in connection with PLC. Possible causes: – Fault on the transmission link, e.g. connecting cable defective – Incorrect interface parameters set on OP or on communication peer.	
045	No connection with PLC established.	Set different CPU under "PLC -> Parameters".
100	Restart due to RAM failure.	
101	Restart following termination of COM-UNI mode	
103	Startup following cancellation of COM-UNI mode	
104	Transfer cancelled by operator. Connection with OP is still open, the OP is waiting.	
105	Fault resulting in wait message has been eliminated.	
107	Restart following activation of COM-UNI mode	
108	OP is in download mode.	

Mes- sage	Cause	Remedy:
109	Restart after change of operating mode from of- line to online.	
110, 113	OP is in "normal" mode.	
114	PLC has been restarted.	
115	Establishment of logical link with PLC in pro- gress.	
117	Connection with PLC is OK again following a fault.	
119	Automatic restart.	
120	Restart after change of S5 protocol.	
124	Restart following selection of different language.	
129	SINEC L1 or SINEC L2 parameter has been changed	
130, 132	Startup due to loop-through operation when online.	
134	Restart due to offline operation.	
136	PLC not responding.	Check program sequence on PLC. Check physical connection.
138	Data block not available on PLC	Set up relevant memory area.
201	Hardware fault on timer module.	Send unit for repair.
202	Error reading date	Send unit for repair.
203	Error reading time	Send unit for repair.
204	Error reading day	Send unit for repair.
205	Printer not ready and internal storage of print jobs is no longer possible.	Make sure printer is ready or disable message logging.
206	Printer not ready. Print job placed in temporary storage.	Make sure printer is ready.
207	Buffer printout or print screen function cancelled.	Check printer, cable and connectors.
210	<i>Internal error</i> OP co-ordination area not receivable during star- tup.	Press restart button.
212	<i>Internal error</i> Bit for changing operating mode has been inver- ted erroneously.	Restart OP.
213	Offline mode not possible at present.	Try change of operating mode again later.
214	The job number sent by the PLC or configured in a function field is too large.	Check PLC program and configured screen.

Message	Cause	Remedy:
217, 218	Overlapping specified/actual values.	Check configuration of actual/specified values in the process link.
219	Hardware fault: relay or port could not be set.	Send unit for repair.
220	Print buffer overflow due to overload. Printout not possible.	Messages have been lost.
221	Print buffer overflow due to overload. Printout of overflow messages not possible.	Messages have been lost.
222	Warning: the event message buffer is full apart from the specified remaining buffer space.	Clear the buffer or configure a smaller figure for the remaining buffer space.
224	The event message buffer has overflowed.	If a printer is connected and buffer overflow has been configured, the overflow messages will automatically be printed out.
225	Warning: the alarm message buffer is full apart from the specified remaining buffer space.	Clear the buffer or configure a smaller figure for the remaining buffer space.
227	The alarm message buffer has overflowed.	If a printer is connected and buffer overflow has been configured, the overflow messages will automatically be printed out.
229	No keyboard connected (internal keyboard with ribbon cable).	
230	The minimum value is greater than the maximum value for variable limits.	Correct the limit settings.
231	The minimum value is equal to the maximum value for variable scales.	Correct the scale on the OP.
303	Fault in connection with PLC. S5: this error may occur when transferring large data records. In such cases the watchdog is activated.	Check PLC status. S5: set value in data word 98 to at least 2000.
304	Illegal S5 job number or job parameters in a function field.	
305	Data block number missing.	Set up data block or change configuration.
306	Incorrect CPU specified under "PLC -> Parameters".	Change configuration and retransfer.
307 ... 311	Variable not present on PLC	Check configuration of process link.
312	The printer is already processing a print job and can not accept this next job at present.	Wait until the printer is free again and repeat the print job.
313	Information message: print job completed.	

Mes- sage	Cause	Remedy:
314	S7 diagnostics buffer not present.	The CPU has no diagnostics buffer (hardware problem).
315	No information text available.	
317	Input is password protected.	Enter password.
318	Incorrect password entered when attempting to log in.	
319	An existing password was entered when editing the password.	Enter a different password.
320	You have attempted to alter the level of or delete the supervisor password.	
321	You have attempted to alter the level of an invalid password.	First enter the password then specify the level.
322	The password entered is too short.	Password must be at least three characters long.
323	You have pressed <- Statistics or Message Text -> on a buffer screen but there is no entry for the current message.	—
324	The entry number specified does not exist on the selected screen.	—
325	The FM/NC (= MPI peer) has no alarm messages buffer.	A node does not have the required functional capability.
326	You have attempted to collect a recipe number other than the active recipe number from the PLC.	Select the appropriate recipe number.
327	There is no recipe number when a recipe is selected.	Configure missing recipe or select a different one.
328	Recipe number >99 when selecting a recipe.	
329	The same number has been entered for source and destination on the "Data Record Transfer" screen.	Enter differing numbers.
330	Full details of source and destination not entered when initiating data record transfer function.	
331	The data record specified as the source does not exist.	
332	Data record number >99 when selecting a recipe screen.	
333	Data record number not present when selecting a recipe screen.	
335	Information message: alarm message will be suppressed.	
336	No process screens have been configured.	
337	No recipes have been configured.	

Mes- sage	Cause	Remedy:
338	OP can not establish a connection with the printer.	<ol style="list-style-type: none"> 1. Printer is not switched on, 2. Printer is not ready, 3. Connecting lead between printer <—> OP is not connected or defective, 4. No interface module inserted.
339	Startup completed.	Communication with PLC has been resumed.
340	Status processing in progress on PU/PC. The OP can not be used while this is going on.	
341	<i>Internal error</i> With non-Siemens connections: data block error	
342	Network node has illegal address.	Max. addresses: S7-MPI: 32 PROFIBUS-DP: 128
353	The minimum value is greater than the maximum value for variable scales.	Minimum and maximum values are being confused by OP. To prevent this, enter correct minimum and maximum values.
359	The CPU is in STOP mode.	System error message issued if S7 messages are not available.
366	<ul style="list-style-type: none"> – The mode you require is already active. – The CPU key-operated switch is not set to RUN-P. – The command is not supported by the CPU. 	
367	Set PLC parameters are incorrect.	
368	Communication error S7 module; error class and error number will be read out.	
369	The command cannot be executed in the S7 mode selected.	
392	<ul style="list-style-type: none"> – No alarm messages are queued on the NC. – Acknowledgement is not possible in the NC mode set. 	
393	The password is incorrect or you cannot enter a password in the NC mode set.	
394	Acknowledgement is not possible on the NC set.	
395	<ul style="list-style-type: none"> – No part programs have been configured. – The PLC specified (FM or NC) is not ready. 	
396	<ul style="list-style-type: none"> – The part program specified does not exist. – The PLC specified (FM or NC) is not ready; in the case of FM: no user data area has been created on the PLC. 	

Mes- sage	Cause	Remedy:
397	<ul style="list-style-type: none"> – The part program specified does not exist. – The record specified does not exist. – The PLC specified (FM or NC) is not ready. 	
398	<ul style="list-style-type: none"> – The command cannot be executed in the MCU mode selected. – The command is not supported by the MCU version. 	
399	<ul style="list-style-type: none"> – The PLC does not have a directory of tool corrections. – The tool correction specified does not exist. 	
400	Illegal key pressed.	
401	Value entered could not be converted.	
402	Operator error on STATUS VAR or FORCE VAR screen:	only 10 entries are permitted (after pressing INS if 10th line already used).
403	Incorrect time entered	
404	Incorrect date entered	
406	Operator error on STATUS VAR or FORCE VAR screen	Values can only be changed after update operation has been cancelled (BREAK key).
407	You have attempted to delete the only data record for a recipe.	
409	Lower limit violated: you have attempted to enter a setpoint that is below the configured lower limit.	Enter a value that is greater than or equal to the specified value. No limit is indicated for data of the type DOUBLE.
410	Upper limit violated: you have attempted to enter a setpoint that is above the configured upper limit.	Enter a value that is less than or equal to the specified value. No limit is indicated for data of the type DOUBLE.
411	Illegal screen selection because incorrect PLC type specified (external driver)	Change configured interface parameter.
500... 503	Scheduler, counter, date or time data can not be sent.	This error can occur if the PLC is temporarily overloaded or if the function block is not invoked for more than 1.5 s.
504	Free ASCII Protocol: operator input value could not be sent.	
505	The data record can not be sent as the recipe disable bit on the PLC is set or because transfer of a recipe is still in progress.	Try sending again later when the PLC has released the recipe mailbox.
506	Overload: too many message blocks with the same block number in transit.	This error occurs if the PLC sends too many jobs using 'collect message area' within a certain period of time.

Mes- sage	Cause	Remedy:
507	Transfer of the data record was not acknowledged by the PLC within a certain period.	Checking of data records by the user at the PLC end must be carried out more quickly (< 10 s).
509	Firmware version is different from standard FB version.	Please contact the SIMATIC Hotline.
510	Data record not present.	A process link with a non-existent data block has been configured in a recipe or the recipe data contains errors.
511	You have used a PLC job to select a recipe or a request data record that does not exist.	
512	Configured data block length is too short. The variable transferred with the message identifies the number of the data block.	Change configuration and retransfer.
516	SINEC L2 protocol configured but no interface module inserted.	Change configuration and retransfer.
518	Interface module inserted and protocol configured do not match.	Change configuration and retransfer.
520	Excessive number of saved returns has meant that maximum nesting level has been exceeded.	Go to Message Level (by pressing ESC key if necessary).
521, 522	Screen can not be constructed or selected because there is not enough memory available. Message 522 triggers a restart with memory optimization.	You can optimize memory availability by <ol style="list-style-type: none"> 1. Removing unused fields from the configuration 2. Configuring the screen with fewer fields, or splitting it into more than one screen 3. Creating fewer recipe data records
523	No text found.	
524	Object class does not exist.	
525	Illegal operand.	
526	Loop-through operation is set on the OP.	Change mode from "Loop-through operation" to "Normal operation".
527	Access to recipe data is not possible at present.	
528	Recipe does not exist.	
529	File does not exist.	
530	Data record not present.	
531	Data record can not be loaded.	
532	Information message: data record memory is full.	
533	Floppy connection unclear.	

Mes- sage	Cause	Remedy:
534	Information message: disk is full.	
535	Disk access error.	
536	Disk transfer error.	Check the physical connection.
537	Information message: disk is blank.	
538	Simultaneous accessing of data record by job and operator.	Repeat uncompleted accessing operation.
539	The data records in the RAM for recipe no. x contained errors and have been deleted.	If data records are stored in the Flash memory they will remain valid.
540	The maximum number of data records has already been created.	
541 ... 550	Specified variable not available on PLC	Change configuration and retransfer.
551	An MPI/PPI connection to the PLC cannot be established using the specified station address.	Check MPI station addresses and wiring.
570	Variable contains errors: variable name from Pro-Tool is used as parameter.	Check configuration. Frequently occurs with NC variables and when multiplexing.
571	S7 system diagnosis/ALARM_S returns error if OP logs on/off.	CPU operating system out of date.
600	Configuration error: overflow warning at basic setting 1	
601	Configuration error: message logging at basic setting 1	
602	Configuration of remaining buffer space incorrect.	Correct the remaining buffer space and retransfer configuration.
604	Message does not exist.	Configure message.
605	Process link is only configured symbolically.	Change configuration and retransfer.
606	Too many message variables configured.	
607	Data type configured does not exist.	
608	The process screen number does not exist.	Change configuration and retransfer.
609	Special object or operator object for message text does not exist or is not permissible.	
610	Operator object for header or footer does not exist or is not permissible.	
611	Special operator object for buffer printout does not exist or is not permissible.	If the fault is not corrected by performing a restart, please contact the SIMATIC Hotline.
613	Data block not available or too short.	
614	No entry present for log (header and footer not present).	Create data block of required length on the PLC.
		Configure log fully.

Message	Cause	Remedy:
615	The line to be output is larger than the amount of print memory reserved for it or the number of control sequences is too great.	Check configuration as regards logging.
616	<i>Internal error</i> Incorrect data format in process link.	Correct the data format.
617	<i>Internal error</i> Incorrect word length in process link.	Correct the word length.
618	Configuration error in actual control value (bit number > 15).	Bit number for actual control variable must be < 15.
619	Error presetting setpoint (error in data structures).	Change configuration and retransfer.
620	Illegal keyboard ID: module number too high or number of keys does not match keyboard ID.	Enter configuration to match hardware.
621	Incorrect parameter transferred: message type	Set required value by way of standard screen or PLC.
622	Configured recipe does not fit in recipe mailbox on PLC (> 512 data words).	Reduce configured size of recipe and retransfer configuration.
623	<i>Internal error</i> Screen object for "Send Recipe" is not a recipe type (fixed by COM TEXT).	If the fault is not corrected by performing a restart, please contact the SIMATIC Hotline.
624	No recipe entries found.	Set up area pointers and retransfer configuration.
625	Recipe number does not exist.	Reconfigure recipe.
626	No setpoints have been configured.	
627	<i>Internal error</i> Configured keyboard block number too high.	Correct the block number.
628	Recipe does not fit in mailboxes.	Increase configured size of recipe mailbox or succeeding recipe mailbox.
629	LED assignment area too small.	Increase size of LED assignment area according to bit numbers used.
630	Keyboard assignment area too small.	Increase size of keyboard assignment area according to bit numbers used.
631	Message configuration incomplete or incorrect. Variable x: 1, 2 Alarm message triggered not configured 3 Process link only created symbolically. 4 Actual-value field only created symbolically. 5, 6 Event message triggered not configured 7 Symbolic actual-value field only created symbolically. 21..24 Field texts for symbolic actual value do not exist 25 Illegal field type 8..20 Internal error	Complete configuration. If the fault is not corrected by performing a restart, please contact the SIMATIC Hotline.

Mes- sage	Cause	Remedy:
632	Configuration error: Variable x: 1, 4 Information text does not exist 2 Information text ID for messages does not exist 3, 6..8, Internal error 11, 13 5 Field only created symbolically. 9 Screen or recipe entry created symbolically only 12 Process screen or recipe does not contain any entries	Check the configuration. If the fault is not corrected by performing a restart, please contact the SIMATIC Hotline.
634	Configuration error: Variable x: 0..8, 34 Internal error 18 Screen or recipe title not configured	Screen or recipe title not configured If the fault is not corrected by performing a restart, please contact the SIMATIC Hotline.
635	Configuration error: Variable x: 1 Screen or recipe entry created symbolically only 3 Field only created symbolically. 6 Message, entry or information text not configured for current language 7..9, Internal error 19, 28, 41...43 18 Screen or recipe title not configured 20 Process link only created symbolically. 21 Information text only created symbolically. 22 Symbolic field only created symbolically. 23 Fewer than 2 field texts configured for symbolic field 24 Current field type for symbolic field not configured 25 Illegal data format for symbolic field (only KF and KY permissible) 26 Recipe setpoint configured with data format KC 33 Illegal data format for setpoint field 35 Data format for scheduler too short 36 Illegal data format for actual control value 44 With a permanently programmed Return to menu: menu item not present 45 With permanently programmed Return to screen: entry or field number not present 46 Too many control actual values on screen (no more than 200 allowed) 48 Too many fields on process screen 50 Process link for soft keys does not exist 51 Soft key number too high 53 Information text for soft key not configured or not configured in all languages 55 Soft key specified in entry does not exist	Check the configuration. If the fault is not corrected by performing a restart, please contact the SIMATIC Hotline.
636	Event message is not configured	Configure event message (-> message number) fully.

Message	Cause	Remedy:
637	Missing configuration for an event message	Configure event message (-> message number) fully.
638, 639	Actual value field for event message has only been created symbolically.	
640	Alarm message is not configured	Configure alarm message (-> message number).
641	Alarm message triggered is not configured	
642, 643	The actual value field for alarm message has only been created symbolically.	Reconfigure alarm message (-> message number).
645	<i>Internal error</i> PLC co-ordination area not receivable during startup.	Press key to restart. If the fault is not corrected by performing a restart, please contact the SIMATIC Hotline.
648	The driver number configured can not be interpreted.	
649	<i>Internal error</i> Driver number configured can not be interpreted.	If the fault is not corrected by performing a restart, please contact the SIMATIC Hotline.
650	Missing area pointer.	Configure an area pointer.
651	<i>Internal error</i> There is not at least one data record for every recipe.	If the fault is not corrected by performing a restart, please contact the SIMATIC Hotline.
652	Configuration is not compatible with S5	Change configuration and retransfer. If the fault is not corrected by performing a restart, please contact the SIMATIC Hotline.
653	The configured user version number does not match the version number stored on the PLC.	Change configuration and retransfer.
654	The PLC acknowledgement area has not been configured to follow on physically from the message area.	
655	PLC acknowledgement area does not physically follow on from the alarm messages area (-> no startup).	
656	Configured protocol is not possible.	Check protocol in configuration.
657	Configured PLC protocol is not possible.	Use current firmware version or configure different protocol.
658	Configured PLC protocol is not possible.	
659	Illegal process link in recipe, destination does not exist.	Change configuration and retransfer.
660	Invalid destination configured for return reference in menu.	Break key on OP; complete configuration and retransfer

Mes- sage	Cause	Remedy:
661	On process screen: recipe setpoint or previous value configured in recipe: field is neither recipe setpoint or previous value.	Change field type or remove field and retransfer configuration
662	Invalid destination configured for return reference in screen.	Change configuration and retransfer.
663	Data record memory full (during startup)	
664	Standard data records for the configured recipes require more than 20 Kbytes. Unit switches to COM TEXT mode.	Configure fewer or smaller recipes.
665	Configuration of interfaces incorrect, printer/PLC interfaces have same physical characteristics.	Check interface parameters.
667	<p>Configuration error:</p> <p>Variable x:</p> <p>1 Data type is not DB</p> <p>2 DB number is greater than 15</p> <p>3 DB length is greater than 1024</p> <p>4 DW is in data block header</p> <p>5 Actual value not in send block</p> <p>6 Setpoint not in receive block</p> <p>7 Setpoint/actual value not in receive block</p> <p>8 Initial value not in send block</p> <p>9 Data type is not DB</p> <p>10 DB number is greater than 15</p> <p>11 DB length is greater than 1024</p> <p>12 DW is in data block header</p> <p>13 Area is in wrong DB</p> <p>14 Sum of data blocks too great</p>	<p>x = 1..8: Change the configuration of the process link and retransfer.</p> <p>x = 9..13: Change configuration of area pointer and retransfer</p> <p>x = 14: Restrict configuration and retransfer.</p>
668	<p>Incorrect configuration.</p> <p>Meaning of variables:</p> <p>1: Incompatible PLC types configured</p> <p>2: No PLC configured</p> <p>3: Incorrect baud rate configured</p>	Change configuration and retransfer.
669	Too many actual values (> 512) have been configured for cyclic reading in a screen/variable.	
670	Too many variables requested simultaneously.	Lengthen standard clock pulse or configure fewer variables on screen.

Mes- sage	Cause	Remedy:
685	<p>Configuration error. Two tags that supply information about the faulty function (Tag 1) and the faulty parameter (Tag 2) are transferred together with this message.</p> <p>Variable 1: 535 Conversion, Linear 1 536 Conversion, Linear 2 537 Increment, variable 539 Increment current 545 Convert value</p> <p>Variable 2: This specifies the parameter of the function in which an error has arisen (e.g. Tag 2 = 3: parameter 3 of the Tag 1 function is faulty).</p>	<p>If you are dealing with a configuration error: delete the function and re-configure.</p> <p>Or if the OP tries to determine the value of a tag while no PLC is connected: connect a PLC.</p>
686	Too many variables.	
701	<i>Internal error</i> Incorrect assignment of "head -> res" when receiving variable.	
702	Job can not be executed.	Change interface or configure area pointer.
703	Flash memory full.	Restrict the configuration.
704	Incorrect CPU specified under "PLC -> Parameters".	Change configuration and retransfer.
705	An acknowledged message can not be entered in the buffer because the corresponding message or a message in the same acknowledgement group is missing.	
706	Recipe request will not be processed as another request is already active.	
707	<i>Internal error</i> S7 message task error.	
708	<i>Internal error</i> Incorrect mailbox type	
709	<i>Internal error</i> Invalid mailbox type.	
710	<i>Internal error</i> Incorrect mode.	
711	<i>Internal error</i> Display status invalid.	
712	No submenu configured.	
713	<i>Internal error</i> No special operator object configured.	

Mes- sage	Cause	Remedy:
714	<i>Internal error</i> Menu number invalid.	
715	<i>Internal error</i> Mailbox type of received message is incorrect.	
716	<i>Internal error</i> The setting for the maximum number of messages is too high (variable overflow).	
717	<i>Internal error</i> Incorrect message status when entering in statistics.	
718	<i>Internal error</i> Incorrect message status when entering in event message buffer.	
719	<i>Internal error</i> Incorrect message status when entering in alarm message buffer.	
720	<i>Internal error</i> Error reading messages from message buffer.	
721	<i>Internal error</i> Configuration message error	
722	<i>Internal error</i> Incorrect mailbox type received (OP15 -> OP5)	
723	<i>Internal error</i> OP5: more than 500 messages are specified in the area pointer lists.	Change area pointer list.
724	<i>Internal error</i> Mailbox type not implemented.	
725	<i>Internal error</i> Block number does not exist.	
726	<i>Internal error</i> Incorrect mailbox type	
727	<i>Internal error</i> Illegal screen type	
728	<i>Internal error</i> Return reference number incorrect	
729	<i>Internal error</i> Error in internal mailbox buffer management for direct message logging.	

Mes- sage	Cause	Remedy:
731	<i>Internal error</i> Transfer parameter LEDSTATUS is incorrect in RIO function "Change LED Status"	
732	<i>Internal error</i> Key number can not be higher than 7/15/23 (8-key/16-key/24-key keyboard)	
733	<i>Internal error</i> Key number must be less than 4 as a maximum of 4 keys is possible.	
734	<i>Internal error</i> The module number must be 0.	
735	<i>Internal error</i> Illegal RIO function.	The following are permissible: Read, Write (LEDs, outputs) and Initialize.
736	<i>Internal error</i> Keyboard driver error.	
737	<i>Internal error</i> Too many keyboard assignment areas (mailboxes) being transferred to PLC.	
738	<i>Internal error</i> Mailbox type of received message is incorrect.	
739	<i>Internal error</i> Key acknowledgement received when message already acknowledged.	
740	<i>Internal error</i> Message status not permitted for first alarm/event message.	
741	<i>Internal error</i> Buffer type different from event or alarm message buffer.	
742	<i>Internal error</i> Message type different from event or alarm message buffer.	
743	<i>Internal error</i> Configuration message error	
744	<i>Internal error</i> Incorrect mailbox type received.	
746	<i>Internal error</i> Actual control value and process link are identical on a screen.	In COM TEXT: change address

Message	Cause	Remedy:
747	<i>Internal error</i> Buffer type different from event or alarm message buffer.	
748	<i>Internal error</i> Message type different from event or alarm message buffer.	
749	<i>Internal error</i> Error in data structure of a buffer function screen.	
750	<i>Internal error</i> Error in data structure of the password function screen.	
751	<i>Internal error</i> Error in data structure of screen for setting time.	
752	<i>Internal error</i> Error in data structure of the Login screen.	
753	<i>Internal error</i> Error in data structure of other type of function screen.	In COM TEXT: IHV recipes affected
754	<i>Internal error</i> Error in data structure of "Average Statistics" screen.	
759	<i>Internal error</i> Error group (task ID) does not exist.	
760	<i>Internal error</i> The message number for this error group does not exist.	
761	<i>Internal error</i> Communication: Mailbox type of received message is incorrect.	
762	<i>Internal error</i> Configuration error: message for which there is no text expected. 761 received instead.	Occurs if, for example, new firmware is being used with old COM TEXT version.
763	<i>Internal error</i> Configuration error	
764, 765	<i>Internal error</i> There are two variables: Var. 1: Message number, Var. 2: Number for error location	
767, 769	<i>Internal error</i> With stop, TD10 – TD/OP20 different.	

Mes- sage	Cause	Remedy:
771	<i>Internal error</i> Error during communication (→ messages).	
773	<i>Internal error</i> Error reading area pointer	
774	Error on reading from “Basic Settings→ General parameters“	
775	<i>Internal error</i> Data record memory full	
776	<i>Internal error</i> Too many schedulers in transit	
779	<i>Internal error</i> Internal error during MPI download; possibly due to buffer problems.	Reset and repeat MPI download.
780	<i>Internal error</i> Undefined error from communication with PLC.	
781	An "Online Setter" function has been incorrectly defined in ProTool.	
783	<i>Internal error</i> Error in NC messages	

Technical Data



Housing	OP7			OP17		
	PP	DP	DP-12	PP	DP	DP-12
Overall dimensions W x H x D	144 mm x 180 mm x 42.5 mm			240 mm x 204 mm x 54 mm		
Mounting cutout B x H	135 mm x 171 mm			231 mm x 195 mm		
Mounting depth	38.5 mm			50 mm		
Degree of protection – front – rear	IP65 IP20					
Weight approx.	0.430 kg			0.960 kg		

Memory	OP7			OP17		
	PP	DP	DP-12	PP	DP	DP-12
Flash memory for configuration data and data records	128 kbytes			256 kbytes		

Display	OP7			OP17		
	PP	DP	DP-12	PP	DP	DP-12
Type	LCD with LED backlighting					
Number of lines	4			4 or 8 (configurable)		
Characters per line	20			20 or 40 (depending on number of lines)		
Font size	8 mm			11 mm or 6 mm (depending on number of lines)		

Keyboard	OP7			OP17		
	PP	DP	DP-12	PP	DP	DP-12
Type	Touch-sensitive keyboard					
Number of system keys	22					
Number of LEDs	7			19 (16 of which two two-color)		
Number of function keys of which soft keys	8 8			24 16		

Voltage supply	OP7			OP17		
	PP	DP	DP-12	PP	DP	DP-12
Rated voltage	+24 V DC					
Permissible range	+18 ... +30 V DC					
Max. perm. transients	35 V (500 ms)					
Time between two transients	min. 50 sec					
Power input (at 24 V) – typical – max. contin. current	190 mA 240 mA			340 mA 390 mA		
Fusing – internal – external	electronic fuse 1.6 A, quick-acting					

Buffering for OP17		OP17		
		PP	DP	DP-12
Internal	Message buffer Hardware clock	typ. 1 day at 40 °C ¹⁾ several days at 40 °C ¹⁾		
External backup battery ²⁾ (optional)	Type Voltage/capacity Message buffer/hardware clock	Lithium battery 3.6 V/approx. 1.5 Ah > 4 years		

- 1) The specified backup times apply only when the OP17 has been connected to the power supply for more than 12 hours
- 2) Subject to change

Interfaces	OP7			OP17		
	PP	DP	DP-12	PP	DP	DP-12
RS232	1	1	1	2	2	2
TTY	1	–	1	2	1	2
RS422/485	1	–	1	1	–	1
PPI/MPI/ PROFIBUS-DP (up to 1.5 Mbd)/ RS422/485	–	1	1	–	1	1
PPI/MPI/ PROFIBUS-DP (up to 12 Mbd)/ RS422/485	–	–	1	–	–	1

Ambient conditions	OP7			OP17		
	PP	DP	DP-12	PP	DP	DP-12
Operating temperature – vertical installation – horizontal installation Transportation, storage	0 °C ... 50 °C 0 °C ... 35 °C –25 °C ... 70 °C					
Relative humidity – operation – transportation, storage	≤ 95% no dew ≤ 95%					
Shock resistance – operation – transportation, storage	5 g/11 ms 25 g/6 ms					
Vibration – operation – transportation, storage	0.075 mm(10 Hz ... 58 Hz) 1 g (58 Hz ... 500 Hz) 3.5 mm (5 Hz ... 12 Hz) 1 g (12 Hz ... 500 Hz)					
Max. pressure difference (front, rear)	2 hPa					
Air pressure – operation – transportation, storage	706 ... 1030 hPa 581 ... 1030 hPa					

Noise immunity EN 50082-1	OP7			OP17		
	PP	DP	DP-12	PP	DP	DP-12
Static discharge (contact discharge)	EN 61000-4-2 class 3					
RF irradiation	ENV 50140 class 3					
Pulse modulation	ENV 50204 (900 MHz \pm 5 MHz)					
RF conduction	ENV 50141 class 3					
Burst interference	EN 61000-4-4 class 3					

Emitted interference	OP7			OP17		
	PP	DP	DP-12	PP	DP	DP-12
RFI suppression level in accordance with EN 55011	class A					

D

Interface Assignment

Overview

Table D-1 shows the interface configuration of the different OPs. Entries D-2 to D-5 refer to the corresponding pin assignments in Tables D-2 to D-5.

Table D-1 Interface assignment OP7 and OP17

Interface	OP version					
	OP7 PP	OP7 DP	OP7 DP-12	OP17 PP	OP17 DP	OP17 DP-12
IF1A	D-2	D-2	D-2	D-2	D-2	D-2
IF1B	D-3	D-4	D-5	D-3	D-4	D-5
IF2	–	–	–	D-2	D-2	D-2

Table D-2 Pin assignment 15-pin sub-D socket

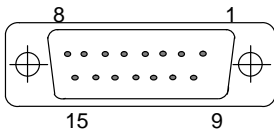

Pin	General	RS232	TTY
1	n.c.		
2			RxD–
3		RxD	
4		TxD	
5		CTS	
6			TxD+
7			TxD–
8	n.c.		
9			RxD+
10		RTS	
11			+20 mA ¹⁾
12	GND		
13			+20 mA ¹⁾
14	+5 V		
15	GND		

1) Not with IF2

Table D-3 Pin assignment 9-pin sub-D socket

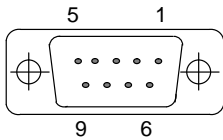

Pin	General	RS422	RS485
1	n.c. (GND) ¹⁾		
2			
3		TxD (B)	Data B
4		RxD (B)	
5	GND		
6	+5 V		
7	(P24-In) ¹⁾		
8		TxD (A)	Data A
9		RxD (A)	

Table D-4 Pin assignment 9-pin sub-D socket

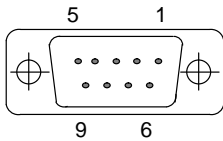

Pin	General	PROFIBUS-DP
1	n.c. (GND) ¹⁾	
2		
3		Data B
4		RTS ²⁾
5	GND (floating)	
6	+5 V (floating)	
7	(P24-In) ¹⁾	
8		Data A
9		RTS ²⁾

Table D-5 Pin assignment 9-pin sub-D socket

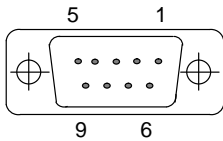

Pin	General	PROFIBUS-DP	RS422	RS485
1	n.c. (GND) ¹⁾			
2				
3		Data B	TxD (B)	Data B
4		RTS ²⁾	RxD (B) ²⁾	
5	GND (floating)			
6	+5 V (floating)			
7	(P24-In) ¹⁾			
8		Data A	TxD (A)	Data A
9		RTS ²⁾	RxD (A) ²⁾	

1) Reserved for future use. From current-limited source < 1A only.

2) Can be switched by means of the DIP switch (for switch settings refer to Section 14.2.3)

Target groups

This manual is part of the SIMATIC HMI documentation. The documentation is aimed at the following target groups:

- Newcomers
- Users
- Configurers
- Programmers
- Commissioning engineers

How the documentation is organized

The SIMATIC HMI documentation consists of the following components:

- User's Guides / User's Manuals for:
 - Configuration software
 - Runtime software
 - Communication between PLCs and operating units
- Equipment Manuals for the following operating units:
 - MP (Multi Panel)
 - OP (Operator Panel)
 - TP (Touch Panel)
 - TD (Text Display)
 - PP (Push Button Panel)
- Online Help on the configuration software
- Start-up Guides
- First Steps

Overview of complete documentation

The following table provides an overview of the SIMATIC HMI documentation and shows you when you require the different documents.

Documentation	Target Group	Content
First Steps with ProTool Product Brief	Newcomers	<p>This documentation guides you step by step through the configuration of</p> <ul style="list-style-type: none"> • a screen with various objects • changing from one screen to another • a message. <p>This documentation is available for:</p> <ul style="list-style-type: none"> • OP3, OP5, OP7, OP15, OP17 • OP25, OP27, OP35, OP37, TP27, TP37 • Windows-based systems
ProTool Configuring Windows-based Systems User's Guide	Configurers	<p>Provides information on working with the ProTool/Pro configuration software. It contains</p> <ul style="list-style-type: none"> • information on installation • basic principles of configuration • a detailed description of configurable objects and functions. <p>This documentation is valid for Windows-based systems.</p>
ProTool Configuring Graphics Displays User's Guide	Configurers	<p>Provides information on working with the ProTool configuration software. It contains</p> <ul style="list-style-type: none"> • information on installation • basic principles of configuration • a detailed description of configurable objects and functions. <p>This documentation is valid for graphic display operating units.</p>
ProTool Configuring Text-based Displays User's Guide	Configurers	<p>Provides information on working with the ProTool/Lite configuration software. It contains</p> <ul style="list-style-type: none"> • information on installation • basic principles of configuration • a detailed description of configurable objects and functions. <p>This documentation is valid for text-based display operating units.</p>
ProTool Online Help	Configurers	<p>Provides information on the configuration computer while working with ProTool. Online Help contains</p> <ul style="list-style-type: none"> • context-sensitive help • detailed instructions and examples • detailed information • all the information from the user guide.
ProTool/Pro Runtime User's Guide	Commissioning engineers, Users	<p>Provides information on working with ProTool/Pro Runtime software. It contains</p> <ul style="list-style-type: none"> • installation of the ProTool/Pro Runtime visualization software • commissioning and running the software on Windows-based systems.
Copy Protection Start-up Guide	Commissioning engineers, Users	<p>The ProTool/Pro Runtime visualization software is a copy-right product. This manual contains information on the installation, repair and uninstallation of authorizations.</p>

Documentation	Target Group	Content
Application Example Start-up Guide	Newcomers	ProTool is supplied with example configurations and the corresponding PLC programs. This documentation describes how you <ul style="list-style-type: none"> • load the examples onto the operating unit and PLC • run the examples and • upgrade the connection to the PLC to suit your own specific application.
MP270 Equipment Manual	Commissioning engineers, Users	Describes the hardware and the general operation of Multi Panel MP270. It contains <ul style="list-style-type: none"> • installation and commissioning instructions • a description of the equipment • operating instructions • instructions for connecting the PLC, printer and programming computer, • maintenance instructions.
OP37/Pro Equipment Manual	Commissioning engineers, Users	Describes the hardware, installation and inclusion of upgrades and options for the OP37/Pro.
TP27, TP37 Equipment Manual OP27, OP37 Equipment Manual OP25, OP35, OP45 Equipment Manual OP7, OP17 Equipment Manual OP5, OP15 Equipment Manual TD17 Equipment Manual	Commissioning engineers, Users	Describes the hardware and general operation. It contains <ul style="list-style-type: none"> • installation and commissioning instructions • operating unit description • connecting the PLC, printer and programming computer • operating modes • operation • description of the standard screens supplied with the operating unit and how to use them • fitting options • maintenance and fitting of spare parts.
OP3 Equipment Manual	Commissioning engineers, Users, Programmers	Describes the hardware of the OP3, its general operation and the connection to the SIMATIC S7.
PP7, PP17 Equipment Manual	Commissioning engineers, Users	Describes the hardware, installation and commissioning of push-button panels PP7 and PP17.
Communication User's Manual	Programmers	Provides information on connecting text-based and graphics displays to the following PLCs: <ul style="list-style-type: none"> • SIMATIC S5 • SIMATIC S7 • SIMATIC 500/505 • drivers for other PLCs This documentation describes the <ul style="list-style-type: none"> • configuration and parameters required for connecting the devices to the PLC and the network • user data areas used for exchanging data between operation unit and PLC.

Documentation	Target Group	Content
Communication for Windows-based Systems User's Manual	Programmers	Provides information on connecting Windows-based systems to the following PLCs: <ul style="list-style-type: none"> • SIMATIC S5 • SIMATIC S7 • SIMATIC 505 • Allen Bradley PLC 5/SLC 500 This documentation describes the <ul style="list-style-type: none"> • configuration and parameters required for connecting devices to the PLC and the network • user data areas used for exchanging data between operating unit and PLC.
Other PLCs Online Help	Programmers	Provides information on connecting devices to PLCs, such as: <ul style="list-style-type: none"> • Mitsubishi • Allen Bradley • Telemecanique • Modicon • Omron • SIMATIC WinAC When the drives are installed, the relevant Online Help is installed at the same time.
ProAgent for OP User's Manual	Configurers	Provides the following information about the ProAgent optional package (process diagnosis) for OPs <ul style="list-style-type: none"> • configuring system-specific process diagnosis • detecting, locating the cause of and eliminating process errors, • customizing standard diagnostic screens supplied with the software.

In this Appendix

In this appendix you will find a list of:

- All cities in the Federal Republic of Germany with Siemens Sales Offices and
- All European and non-European Siemens Companies and Representatives

Siemens Sales Offices in the Federal Republic of Germany

The following table lists all Siemens Sales Offices in the Federal Republic of Germany.

Aachen	Kassel
Augsburg	Kempten/Allg.
Bayreuth	Kiel
Berlin	Laatzen
Bielefeld	Leipzig
Bonn	Lingen
Bremen	Magdeburg
Brunswick	Mainz
Chemnitz	Mannheim
Coblenz	Munich
Cologne	Münster/Westf.
Constance	Nuremberg
Darmstadt	Osnabrück
Dortmund	Regensburg
Dresden	Rostock
Duisburg	Saarbrücken
Düsseldorf	Siegen
Erfurt	Stuttgart
Essen	Ulm
Frankfurt am Main	Wetzlar
Freiburg	Wilhelmshaven
Hamburg	Wuppertal
Heilbronn	Würzburg
Karlsruhe	

**European
Companies and
Representatives**

The following table lists all European Siemens Companies and Representatives.

Austria	Finland
Siemens AG Österreich	Siemens Oy
<ul style="list-style-type: none"> • Bregenz • Graz • Innsbruck • Linz • Salzburg • Vienna 	<ul style="list-style-type: none"> • Espoo, Helsinki
Belgium	France
Siemens S.A.	Siemens S.A.
<ul style="list-style-type: none"> • Brussels • Liège 	<ul style="list-style-type: none"> • Haguenau • Lille, Seclin • Lyon, Caluire-et-Cuire • Marseille • Metz • Paris, Saint-Denis • Strasbourg • Toulouse
Siemens N. V.	
<ul style="list-style-type: none"> • Antwerp 	Great Britain
Bosnia-Herzegovina	Siemens plc
Generalexport Predstavništvo Sarajevo	<ul style="list-style-type: none"> • Birmingham, Walsall • Bristol, Clevedon • Congleton • Edinburgh • Glasgow • Leeds • Liverpool • London, Sunbury-on-Thames • Manchester • Newcastle
<ul style="list-style-type: none"> • Sarajevo 	
Bulgaria	Greece
Siemens AG, Bulgaria Representative	Siemens A.E.
<ul style="list-style-type: none"> • Sofia 	<ul style="list-style-type: none"> • Athens, Amaroussio • Thessaloniki
Croatia	Hungaria
Siemens d. o. o.	Siemens Kft
<ul style="list-style-type: none"> • Zagreb 	<ul style="list-style-type: none"> • Budapest
Cyprus	Iceland
GEVO Ltd.	Smith & Norland H/F
or	<ul style="list-style-type: none"> • Reykjavik
Jolali Ltd.	Ireland
<ul style="list-style-type: none"> • Nicosia 	Siemens Ltd.
Czech Republic	<ul style="list-style-type: none"> • Dublin
Siemens AG	
<ul style="list-style-type: none"> • Brno • Mladá Boleslav • Prague 	
Denmark	
Siemens A/S	
<ul style="list-style-type: none"> • Copenhagen, Ballerup 	

Italy	Romania
Siemens S.p.A. <ul style="list-style-type: none"> • Bari • Bologna • Brescia • Casoria • Florence • Genoa • Milan • Padua • Rome • Turin 	Siemens birou de consultatii tehnice <ul style="list-style-type: none"> • Bukarest
Luxemburg	Russia
Siemens S.A. <ul style="list-style-type: none"> • Luxemburg 	Siemens AG or Mosmatic <ul style="list-style-type: none"> • Moscow Siemens AG <ul style="list-style-type: none"> • Ekaterinburg
Malta	Slovak Republic
J. R. Darmanin & Co. Ltd. <ul style="list-style-type: none"> • Valletta 	Siemens AG <ul style="list-style-type: none"> • Bratislava
Netherlands	Slovenia
Siemens Nederland N.V. <ul style="list-style-type: none"> • The Hague • Rijswijk 	Siemens d. o. o. <ul style="list-style-type: none"> • Ljubljana
Norway	Spain
Siemens A/S <ul style="list-style-type: none"> • Bergen • Oslo • Stavanger • Trondheim 	Siemens S.A. <ul style="list-style-type: none"> • Barcelona • Bilbao • Gijón • Granada • La Coruña • Las Palmas de Gran Canaria • León • Madrid • Málaga • Murcia • Palma de Mallorca • Pamplona • Sevilla • Valencia • Valladolid • Vigo • Zaragoza
Poland	Sweden
Siemens GmbH <ul style="list-style-type: none"> • Gdansk-Letnica • Katowice • Warsaw 	Siemens AB <ul style="list-style-type: none"> • Göteborg • Jönköping • Malmö • Sundsvall • Upplands Väsby, Stockholm
Portugal	
Siemens S.A. <ul style="list-style-type: none"> • Albufeira • Coímbra • Lisbon, Amadora • Matosinhos • Porto 	

Switzerland	Turkey
Siemens-Albis AG <ul style="list-style-type: none"> • Basel • Bern • Zürich Siemens-Albis S.A. <ul style="list-style-type: none"> • Renens, Lausanne 	SIMKO <ul style="list-style-type: none"> • Adana • Ankara • Bursa • Istanbul • Izmir • Samsun
	Ukraine
	Siemens AG <ul style="list-style-type: none"> • Kiev

Non-European Companies and Representatives

The following table lists all non-European Siemens Companies and Representatives of Siemens AG.

Africa

The following table lists all Siemens Companies and Representatives of Siemens AG in Africa.

Algeria	Morocco
Siemens Bureau d'Alger <ul style="list-style-type: none"> • Alger 	SETEL Société Electrotechnique et de Télécommunications S.A. <ul style="list-style-type: none"> • Casablanca
Angola	Mozambique
TECNIDATA <ul style="list-style-type: none"> • Luanda 	Siemens Liaison Office <ul style="list-style-type: none"> • Maputo
Bophuthatswana	Namibia
Siemens Ltd. <ul style="list-style-type: none"> • Mafekeng 	Siemens (Pty.) Ltd. <ul style="list-style-type: none"> • Windhoek
Egypt	Nigeria
Siemens Technical Office <ul style="list-style-type: none"> • Cairo-Mohandessin Siemens Technical Office <ul style="list-style-type: none"> • Alexandria EGEMAC S.A.E. <ul style="list-style-type: none"> • Cairo-Mattaria 	Electro Technologies Nigeria Ltd. (ELTEC) <ul style="list-style-type: none"> • Lagos
Ethiopia	Rwanda
Addis Electrical Engineering Ltd. <ul style="list-style-type: none"> • Addis Abeba 	Etablissement Rwandais <ul style="list-style-type: none"> • Kigali
Ivory Coast	Sambia
Siemens AG <ul style="list-style-type: none"> • Abidjan 	Electrical Maintenance Lusaka Ltd. <ul style="list-style-type: none"> • Lusaka
Libya	Simbabwe
Siemens AG, Branch Libya <ul style="list-style-type: none"> • Tripoli 	Electro Technologies Corporation (Pvt.) Ltd. (ETC) <ul style="list-style-type: none"> • Harare

South Africa	Swaziland
Siemens Ltd. <ul style="list-style-type: none"> • Cape Town • Durban • Johannesburg • Middelburg • Newcastle • Port Elizabeth • Pretoria 	Siemens (Pty.) Ltd. <ul style="list-style-type: none"> • Mbabane
Sudan	Tanzania
National Electrical & Commercial Company (NECC) <ul style="list-style-type: none"> • Khartoum 	Tanzania Electrical Services Ltd. <ul style="list-style-type: none"> • Dar-es-Salaam
	Tunesia
	Sitelec S.A. <ul style="list-style-type: none"> • Tunis
	Zaire
	SOFAMATEL S.P.R.L. <ul style="list-style-type: none"> • Kinshasa

America

The following table lists all Siemens Companies and Representatives of Siemens AG in America.

Argentina	Canada
Siemens S.A. <ul style="list-style-type: none"> • Bahía Blanca • Buenos Aires • Córdoba • Mendoza • Rosario 	Siemens Electric Ltd. <ul style="list-style-type: none"> • Montreal, Québec • Toronto
Bolivia	Chile
Sociedad Comercial é Industrial Hansa Ltda. <ul style="list-style-type: none"> • La Paz 	INGELSAC <ul style="list-style-type: none"> • Santiago de Chile
Brazil	Colombia
Siemens S.A. <ul style="list-style-type: none"> • Belém • Belo Horizonte • Brasilia • Campinas • Curitiba • Fortaleza • Pôrto Alegre • Recife • Rio de Janeiro • Salvador de Bahia • São Paulo • Vitória 	Siemens S.A. <ul style="list-style-type: none"> • Barranquilla • Bogotá • Cali • Medellín
	Costa Rica
	Siemens S.A. <ul style="list-style-type: none"> • Panama • San José
	Cuba
	Respresentación Consult iva EUMEDA <ul style="list-style-type: none"> • La Habana
	Ecuador
	Siemens S.A. <ul style="list-style-type: none"> • Quito

El Salvador	Paraguay
Siemens S.A. • San Salvador	Rieder & Cia. S.A.C.I. • Asunción
Guatemala	Peru
Siemens S.A. • Ciudad de Guatemala	Siemsa • Lima
Honduras	United States of America
Representaciones Electroindustriales S de R.L. - Relectro • Tegucigalpa	Siemens Industrial Automation Inc. Automation Division • Alpharetta, GA Numeric Motion Control • Elk Grove Village, Illinois
Mexico	Uruguay
Siemens S.A. de CV • Culiacán • Gómez Palacio • Guadalajara • León • México, D.F. • Monterrey • Puebla	Conatel S.A. • Montevideo
Nicaragua	Venezuela
Siemens S.A. • Managua	Siemens S.A. • Caracas • Valencia

Asia

The following table lists all Siemens Companies and Representatives of Siemens AG in Asia.

Bahrain	India
Transitec Gulf • Manama	Siemens Limited • Ahmedabad • Bangalore • Bombay • Calcutta • Madras • New Delhi • Secúnderabad
Bangladesh	Indonesia
Siemens Bangladesh Ltd. • Dhaka	P.T. Siemens Indonesia, P.T. Siemens Dian-Grana ElektriKA, Representative Siemens AG • Jakarta
Brunei	
• Brunei Darussalam	
Hong Kong	
Siemens Ltd. • Hong Kong	

Iraq	People's Republic of China
Samhiry Bros. Co. Limited or Siemens AG (Iraq Branch) • Baghdad	Siemens AG Representation • Beijing • Guangzhou • Shanghai
Iran	Philippine Islands
Siemens S.S.K. • Teheran	Maschinen & Technik Inc. (MATEC) • Manila
Japan	Qatar
Siemens K.K. • Tokyo	Trags Electrical Engineering and Air Conditioning Co. • Doha
Korea	Saudi Arabia
Siemens Ltd. • Changwon • Seoul • Ulsan	Arabia Electric Ltd. (Equipment) • Al-Khobar • Jeddah • Riyadh
Kuwait	Singapore
National & German Electrical and Electronic Services Co. (NGEECO) • Kuwait, Arabia	Siemens (Pte.) Ltd. • Singapore
Lebanon	Sri Lanka
Ets. F.A. Kettaneh S.A. • Beirut	Dimo Limited • Colombo
Malaysia	Syria
Siemens Electrical Engineering Sdn. Bhd. • Kuala Lumpur	Siemens AG, Branch (A.S.T.E.) • Damascus
Nepal	Taiwan
Amatya Enterprises (Pvt.) Ltd. • Kathmandu	Siemens Ltd., TELEUNION Engineering Ltd. or TAI Engineering Co., Ltd. • Taichung • Taipei
Oman	Thailand
Waleed Associates • Muscat	Berti Jucker Co. Ltd. • Bangkok
Pakistan	
Siemens Pakistan Engineering Co., Ltd. • Islamabad • Karachi • Lahore • Peshawar • Quetta	

United Arab Emirates	Vietnam
Electro Mechanical Co. or Siemens Resident Engineers <ul style="list-style-type: none"> • Abu Dhabi Scientech or Siemens Resident Engineers <ul style="list-style-type: none"> • Dubai 	OAV Representative Office <ul style="list-style-type: none"> • Hanoi Yemen (Arab. Republic) Tihama Tractors & Engineering Co., Ltd. or Siemens Resident Engineers <ul style="list-style-type: none"> • Sanaa

Australia

The following table lists all Siemens Companies and Representatives of Siemens AG in Australia

Australia	New Zealand
Siemens Ltd. <ul style="list-style-type: none"> • Adelaide • Brisbane • Melbourne • Perth • Sydney 	Siemens Ltd. <ul style="list-style-type: none"> • Auckland • Wellington

Glossary

A

Alarm message Draws attention to particularly urgent operating states; alarm messages have to be acknowledged for this reason.

Area pointer Required for enabling data transfer between the OP and the PLC. It contains details of the location and size of data areas in the PLC.

Arrival of a message The time at which a message is initiated by the PLC or OP.

C

Configuration Definition of system-specific basic settings, messages and screens using ProTool configuration software.

D

Departure of a message The time at which a message is withdrawn by the Programmable Logic PLC

Display function Function resulting in the contents of the display being changed – for example, "Display message level", "Display alarm buffer" and "Display screen".

Download mode Operating mode of the OP in which data are transferred from the Programming Unit to the OP.

Duration of display Time between the arrival of an event message and its departure.

E

Event message Draws attention to specific operating states in the machine or system connected to the PLC.

F

Fault time The time between the arrival and departure of an alarm message.

Flash memory Programmable memory which can be deleted quickly and then re-written.

Field "Placeholder" in configured or permanent text, used to output and/or input certain values.

Forced printout Automatic printouts of alarm or event messages that are deleted upon a buffer overflow.

H

Hardcopy Output of display contents to an attached printer.

Help text Additional, configurable information about messages, screens, screen entries and selection fields.

L

Loop-through mode Operating mode of OP17. Includes normal operation and also permits communication between the PU or PC and the PLC through the second interface of the OP17. This operating mode is possible only when the interface to the PLC is established by means of the AS511 protocol.

M

Message level OP control level at which initiated messages are displayed.

Message logging	Configurable printout of alarm and event messages concurrently with output on display.
N	
Normal mode	OP operating mode in which messages are displayed and screens can be manipulated.
O	
Output field	Field for displaying an actual value.
P	
Password Password level	To use a protected function, it is necessary to enter a Password identifying a given password level. A password level defines the permissions of an operator. The requisite password level is preset by means of configuration and can range from 1 (the lowest level) to 9 (the highest level).
PLC job	Initiation of a function by the PLC.
S	
Screen	Form of display for associated process data, which can be shown together on the OP and modified individually.
Screen entry	Element of a screen; consists of text, tags and soft keys.
Screen level	Editing level of the OP at which screens can be viewed and manipulated.
Selection field	Field for setting values of parameters (one of several defined values can be selected).
Soft key	Key that can be assigned with different functions (depending on displayed screen entry).

- Startup test** Check on the status of the central processing unit and memories each time the supply voltage is applied.
- System message** Draws attention to internal conditions on the OP and the PLC.

Index

A

- Access, 6-1
- Access protection, 6-1
- ACK key, 3-3, 4-2
- ACK-LED, 4-2
- Acknowledge key, 3-3, 4-2
- Acknowledging, alarm messages, 4-2, 7-4
- Acknowledgment area, 13-2
- Acknowledgment groups, 7-4
- Activating
 - message logging, 7-14
 - overflow warning, 7-12
- Additional information, 1-4
- Address, MPI/PPI, 9-1
- Address list, 15-2
- Adjust report, 2-3
- Adjusting, contrast, 3-5
- AEG/Modicon, 2-3
- Air pressure, C-3
- Alarm buffer, 7-3
- Alarm message buffer
 - deleting, 7-12
 - printing, 12-2
- Alarm message text, view, 7-9
- Alarm messages, 1-4, 4-3, 7-2
 - acknowledging, 4-2, 7-4
 - delete, A-1
 - deleting, 7-13
 - display, 4-2
 - display text, A-1
 - forced printout, 7-12
 - max. length, 2-1
 - max. number, 2-1
 - number, A-1
 - overflow, A-1
 - print, A-1
 - scrolling, 7-8
 - suppressing, 7-4
 - unacknowledged, 4-2
 - view, A-1
- Allen-Bradley, 2-3
- Alphanumeric input, example, 3-10
- Alphanumeric value input, 3-6, 3-8
- Ambient conditions, C-3

- Arrived message, 7-4
- Arrow keys, 3-4, 5-3
- AS511
 - connection, 16-2, 16-4
 - report, 2-3
- Assigning, password, 6-5
- Assigning the, password level, 11-2
- Assignment
 - global, 11-1
 - local, 11-1
 - soft key, 5-2
- Automatic login, on OP, 6-3
- Automatic printout, 7-12

B

- Back-lightning, 1-7, 1-9
- Backup battery, 1-9, C-2
 - upgrading, OP17, 16-8
- Back-up time, 10-3
- Backup time, 1-7, 1-9, 7-10
- Basic functions, 1-3
- Basic operations, 4-3
- Basic screen, 4-3, 4-5
- Battery, upgrading, OP17, 16-8
- Branch
 - in standard screens, 4-5
 - with soft keys, 11-1
- Branch backward, 3-4
- Branching, with softkeys, 4-5
- Brightness, 10-4
- Buffer overflow, 7-12, 7-13
 - alarm messages, 7-12
 - event messages, 7-12
- Bus Fault LED, 15-8

C

- Cable cross-section, 14-4
- Calling, help text, 3-14
- Cancel, 3-4
 - help text display, 3-4
 - transfer mode, 3-4, 15-3

- Canceling, download mode, 15-4
- Capacity, backup battery, C-2
- Category, System message, B-1
- Causes, System message, B-2
- Change of operating level, 4-2
- Change over, RTS signal, 14-7
- Changing
 - configuration, 15-4
 - data record, 8-3
 - lines, 9-4
 - memory addresses, 15-2
 - operating level, 4-5
 - screen hierarchy, 11-3
- Character, delete, 3-3
- Character height, 1-7, 1-9
- Character set, 1-5
 - extended, 3-5, 3-8
- Characters
 - move, 3-3
 - per line, 1-7, 1-9, C-1
- Characters A–F, input, 3-8
- Characters per line, 10-2
- Chassis ground, 14-4
- Choice, of screens, 5-3
- Chronological, 7-15
- Cleaning, keyboard and display, 16-9
- Color, LED, 13-1
- Colored LEDs, 1-9
- Combinations, keys, 3-5
- Combined I/O fields, 5-2
- Combined message display, 7-8
- Commissioning, 14-1, 15-1
- Communication
 - OP/PLC, 13-1
 - testing, online, 15-8
- Communication modes, 2-3
- Communication options
 - OP17, 16-4
 - OP7, 16-2
- Compatibility, 1-7, 1-9
- Components
 - screen, 5-1
 - screen entry, 5-2
- Components of a recipe, 8-2
- Computer, connecting, 1-7, 1-9
- Configurable languages, 2-2
- Configuration, 1-1
 - changing, 15-4
 - computer, 14-5, 14-6, 14-8
 - deleting, 15-4
 - download, 15-3, 15-4
 - IF 1B interface, 14-7
 - interfaces, D-1
 - loading, 4-1, 15-3
 - replacing, 15-4
 - testing, 15-6, 15-7
- Configuration computer, 15-3, 15-4
- Configuration phase, 1-1
- Configuration software, 1-1
- Configuring, password, 6-5
- Connecting, 14-5
 - configuration computer, 14-5
 - PC or PG, 16-4
 - PC/PU, 16-2
 - power supply, 14-4
 - printer, 16-2
- Connection
 - attaching a printer, 14-9
 - printer, 16-4
- Connection configuration scheme, 14-5, 14-6, 14-9
- Connection elements
 - OP17, 16-4, D-1
 - OP7, 16-2, D-1
- Connection types, 14-6
 - OP17, 16-4
 - OP7, 16-2
- Connections, electrical, 14-3
- Connector, computer, 14-5, 14-6, 14-8
- Connectors
 - OP17, 16-4, D-1
 - OP7, 16-2, D-1
- Continuous current, C-2
- Contrast, adjust, 3-5
- Control, functions, 1-3
- Control of the OP, via keyboard, 3-1
- Control value, 1-3
- Controlling, processes, 1-3
- Controlling the OP, from the PLC, 13-1
- Correcting, input, 3-9
- Correcting an input, 3-9

- Creating
 - data records, 8-3
 - labeling strips, 16-6
 - screen hierarchy, 11-3
- Creating an, LED image, 13-1
- Creating data areas, 1-1
- Critical machine state, 1-4
- Cross-jump destination, 3-4, 5-1
- Cross-jumps, 11-3
- Cross-section, connection cables, 14-4
- Cursor, 5-2
- Customizing, screen hierarchy, 11-3
- Cutting, labeling strips, 16-6
- Cyrillic characters, 1-5

D

- Data areas, 13-1
- Data buffer, 1-7, 1-9
- Data record, 1-4, 8-1
 - changing, 8-3
 - printing, 8-3, 12-2
 - processing, 8-3
 - transferring, 8-3
- Data record name, 8-2, 8-9
- Data records, 1-4, 4-3, 8-2
 - copying, 8-6
 - transferring, 8-7
 - creating, editing, 8-4
 - directory, deleting, 8-10
 - printing, 8-3, 12-2
 - storing, 8-5
- Data structure, 8-1
- Data updating, 2-3
- Date, 10-3, 13-2, A-2
- Deactivating
 - message logging, 7-14
 - overflow warning, 7-12
- Decimal point, 3-12
- Decimals, 3-7
- Default setting, Supervisor password, 6-2
- Degree of protection, C-1
- Delete
 - alarm messages, A-1
 - character, 3-3
 - event messages, A-1
 - system message buffer, 7-13
- Delete key, 3-3
- Delete mode, 3-3

- Deleting
 - alarm message, 7-13
 - alarm message buffer, 7-12
 - configuration, 15-4
 - data record, 8-3
 - event message, 7-13
 - event message buffer, 7-12
 - password, 6-6
- Departed message, 7-4
- Depth, housing, C-1
- Design
 - EMC, 14-3
 - OP17, 1-8
 - OP7, 1-6
- Design guidelines, 14-3
- Device description, 16-1
- DF1 report, 2-3
- Digits to the right of the decimal point, 3-12
- Dimensions
 - labeling strips, 16-6
 - OP17, 16-3, C-1
 - OP7, 16-1, C-1
- DIP switch, IF 1B interface, 14-7
- Direct adjustment, display contrast, 10-4
- Direct message logging, 7-14
- Directory, 5-1
 - recipes, 1-4
 - screens, 1-3, 5-3
- Discharge degree, of backup battery, 16-8
- Display
 - adjust contrast, 3-5
 - adjusting contrast, 10-4
 - alarm message, 4-2
 - messages, 7-7
 - priorities, 7-7, 7-8
 - type, C-1
- Display first message, 10-3
- Display functions, 1-3
- Display last message, 10-3
- Display priority, 1-4, 7-6
- Display sequences, 7-8
- Display time, 7-6
- Displaying
 - password list, 6-4
 - screen entry, 5-2
 - standby message, 15-3, 15-4
 - start screen, 15-3, 15-4
- Displaying first message, 7-7
- Displaying last message, 7-7

- Disposal, battery, 16-9
- Document associated reference, 1-2
- Documentation, E-1
- Download mode, 4-1, 10-5, 15-3, 15-5
 - canceling, 15-4
- Downloading
 - configuration, 15-3
 - firmware, 15-3
- Drivers, for additional PLCs, 2-3
- Driving
 - LED, 13-1
 - LEDs, 11-2

E

- Edit, screen, 5-4, A-1
- Edit password, 4-3
- Editing, data record, 8-3
- Electrical Connections, 14-3
- Electrical Installation, 14-3
- Electronic fuse, 1-7, 1-9
- EMC, design, 14-3
- Emission, radio interference, C-4
- Emitted interference, C-4
- Enter key, 3-3, 4-2
- Entering
 - alphanumeric value, 3-6, 3-8
 - numerical value, 3-6, 3-7
 - password, 4-6, 6-1, 6-3
 - special characters, 3-8
 - symbolic values, 3-6
 - timer value, 3-13
 - timer values, 3-6, 3-12
- Entering digits, 3-8
- Entering letters, 3-8
- Entering values, 9-4
 - alphanumeric, 3-6, 3-8
 - numerical, 3-6, 3-7
 - symbolic, 3-6
 - timer, 3-6, 3-12
- Entry text, 5-2
- EPROM failure, B-1
- Error handling, B-2
- Error messages, Memory, B-1
- Errors, internal, B-2
- ESC key, 3-4, 4-1, 4-2
- Escape key, 3-4, 4-1, 4-2
- Evaluation of screen number , 13-1
- Event buffer, 7-3
- Event message buffer
 - deleting, 7-12
 - printing, 12-2

- Event message text, view, 7-9
- Event messages, 1-3, 4-3, 7-2
 - delete, A-1
 - deleting, 7-13
 - display text, A-1
 - max. length, 2-1
 - max. number, 2-1
 - number, A-1
 - overflow, A-1
 - print, A-1
 - scrolling, 7-8
 - view, A-1
- Events, 7-3
 - indicating, 7-1
- Example
 - alphanumeric input, 3-10
 - labeling strips, 16-6
 - recipe, 8-1
 - scrolling through messages, 7-9
- Explanations, screen entry, 5-2
- Extended character set, 3-5, 3-8
- External PLC, connection, 16-2, 16-4

F

- FAP, 2-3
- FAP connection, 16-2, 16-4
- Fault description, 14-1
- Fault diagnosis, 15-4
- Fault on the, OP, 14-1
- Field inputs, canceling, 3-4
- Fields, 5-2
 - date, 5-2
 - I/O fields , 5-2
 - numerical, 3-7
 - PLC actual value, 5-2
 - PLC setpoint, 5-2
 - time, 5-2
 - timer, 3-12
- File, labeling strips, 16-7
- Firmware, 7-3
 - loading, 15-3
- Flash memory, C-1
- Flash memory failure, B-1
- Flashing, LED, 13-1
- Flashing cursor, 5-2
- Flashing display, 7-2
 - alarm messages, 1-4
- Foil, labeling strips, 16-6
- Font size, C-1
- Force tag, 4-3
- FORCE VAR, 9-1, A-2

- Forced printout, 7-12, 7-14
- Foreign languages, 1-5
- Front panel cutout
 - OP17, 16-3
 - OP7, 16-1
- Front view
 - OP17, 16-3
 - OP7, 16-1
- Full printout, 7-14
- Function keyboard
 - OP17, 1-9
 - OP7, 1-7
- Function keyboard image, 13-2
- Function keys, 3-1, 5-3, 11-1, C-2
 - global, 3-2
 - labeling, 16-5
 - LED, 11-2
 - local, 3-2
 - number, 2-2
- Functionality, 2-1
 - overview, 2-1
- Functions
 - calling, 4-6
 - data records, 8-3
 - keys, 3-3
 - of the OP, 2-1
- Fuse, 1-7, 1-9, C-2
- Fusing, C-2
- FX report, 2-3

G

- Global assignment, 11-1
- Global function assignment, 3-2
- Global function key, 3-2
- Glossary, Glossary-1
- Guidelines, interference immunity, 14-3

H

- Hardware clock, safeguarding, 16-8
- HELP key, 1-4
- Help LED, 3-3, 3-14
- Help text, 1-4, 2-2, 3-14
 - calling, 3-14
 - scrolling, 3-14
- Help text LED, 3-3
- Hiding
 - system message, 3-4
 - system messages, 4-2

- Housing, C-1
- Humidity, C-3

I

- I/O fields, 5-2
- Identification of recipes, 8-2
- IF 1B interface
 - configuring, 14-7
 - switch, 14-7
- Image, LED, 13-1
- Incorrect input, canceling, 3-6
- Index, password, 6-5
- Indicating, events and states, 7-1
- Information, assigning soft keys, 5-2
- Initial commissioning, 15-1, 15-3
- Initialization, 15-5
- Initiating, messages, 7-2
- Input
 - canceling, 3-4
 - characters A – F, 3-8
 - confirming, 3-3
 - left-aligned, 3-9
 - left-justified, 3-7
 - mixed, 3-8
 - right-aligned, 3-12
 - right-justified, 3-7
 - symbolic values, 3-11
- Input field for timer, 3-12
- Input fields, 5-2
- Insert, space, 3-3
- Insert key, 3-3
- Insert mode, 3-3
- Inserting
 - labeling strips, 16-5
 - lines, 9-4
- Inserting a space, 3-3
- Installation, 14-1, 14-2
 - electrical, 14-3
 - mechanical, 14-2
- Installing
 - battery, 16-8
 - OP, 14-2
- Integrated keyboard, 3-1
- Interface
 - PLC/computer, 1-7, 1-9
 - printer, 1-7, 1-9
- Interface assignment, D-1
- Interface parameters, 4-3
 - modify, 10-2

Interfaces, C-3

- IF 1B, 14-7
- MPI, 16-2, 16-4
- OP17, 1-9, 16-4
- OP7, 1-7, 16-2
- PPI, 16-2, 16-4
- RS232, 1-7, 1-9
- RS422, 1-7, 1-9
- RS485, 1-7, 1-9
- TTY, 1-7, 1-9

Internal errors, B-2

Interruption, power supply, 16-8

Interval, updating values, 5-2

K

Key

- ACK, 4-2
- Acknowledge, 3-3
- confirm input, 3-3
- contrast adjustment, 3-5
- Delete, 3-3
- Enter, 3-3, 4-2
- ESC, 4-1, 4-2
- Escape, 3-4
- HELP, 1-4
- Insert, 3-3
- second function, 3-3
- Shift, 3-3
- Key assignment, system keys, 3-2
- Key combinations, 3-5
 - overall reset, 15-4
- Key functions, 3-3
- Keyboard, 3-1, C-2
 - integrated, 3-1
- Keyboard overlay, 16-6
- Keys
 - arrow keys, 3-4
 - system keys, 3-2

L

- Labeling, function keys, 16-5
- Labeling example, function keys, 16-6
- Labeling strips, 16-5
- Language, A-2
- Language changing, 4-3
- Language selection, 10-1
- Languages, 1-5

LCD

- OP17, 1-9
- OP7, 1-7
- Technical Data, C-1
- LED, 1-4, 11-2
 - ACK, 4-2
 - acknowledgment, 3-3
 - alarm message, unacknowledged, 4-2
 - Bus Fault, 15-8
 - color, 13-1
 - driving, 11-2, 13-1
 - Help, 3-3
 - help text, 3-3
 - Shift, 3-3
 - state, 13-1
- LED control, 13-1
- LED image, 13-1
- LEDs, 1-9
 - number, C-2
- Left-aligned input, 3-9
- Left-justified input, 3-7
- Length, message, 7-8
- Lifetime, backup battery, 16-8
- Limit, 3-12
- Limit check, 3-12
- Limit value, 3-7
- Limit-value check, 3-7
- Lines
 - inserting, 9-4
 - number, 1-7, 1-9, C-1
- Lines per page, 10-2
- Linking screens, 4-1, 11-3
- List
 - languages, 10-1
 - passwords, 6-4
 - symbolic, scrolling, 3-5
 - System messages, B-1
- List of options, 3-11
- Literature, E-1
- Lithium battery, 1-9, C-2
- Loadable enhanced drivers, 2-3
- Loading
 - configuration, 4-1, 15-3
 - firmware, 15-3
- Local assignment, 11-1
- Local function assignment, 3-2
- Log, messages, 7-1
- Logging, upon overflow, 7-12
- Logging in, 6-3
- Logging out, 6-3

- Login, 4-3, 6-3, A-2
- Logo, 7-3
- Logout, 4-3, 6-3, A-2
- Loop-through mode, 10-5, 14-8, 15-7
 - constraints, 14-8
 - particularities, 14-8

M

- Machine diagnostics, 1-1
- Machine functions, 3-2
- Machine state, 1-3, 1-4
- Maintenance, 16-9
- Making, labeling strips, 16-6
- Mechanical installation, 14-2
- Memory, C-1
- Message
 - arrived, 7-4
 - chronological, 7-15
 - departed, 7-4
 - display priority, 7-8
 - together, 7-15
- Message bit procedure, 7-4
- Message buffer, 7-3
 - print, 7-15
 - viewing, 7-10
- Message buffers, 7-1, 7-10
- Message display, 10-3
 - separate, 7-8
 - together, 7-8
- Message length, 7-8
- Message level, 3-3, 4-1
- Message log, 7-14, 10-2
- Message number, B-1
- Message priorities, 7-7
- Message states, 7-1
- Message text, 7-9
- Message types, 7-1
- Messages, 7-1
 - alarm messages, 7-2
 - delete, 7-12
 - displaying, 7-7
 - event messages, 7-2
 - first, 7-7
 - last, 7-7
 - number of alarm messages, 7-11
 - number of event messages, 7-11
 - print, 7-14
 - scroll (message level), 7-8
 - system messages, 7-6
- Mitsubishi, 2-3
- Mixed input, 3-8

- Mixing station, 8-1
- Mixture, recipe, 8-1
- Modbus report, 2-3
- Mode, 4-3
 - Loop-through, 10-5
 - Offline, 10-5
- Modes, 10-5
- Modify
 - interface parameters, 10-2
 - screen, 5-4
- Modify settings, 4-3
- Modifying parameters, 10-2
- Modifying printer parameters, 10-2
- Moisture, 14-1
- Moisture condensation, 14-1
- Mounting conditions, 14-1
- Mounting cutout, 14-1, C-1
 - OP17, 16-3
 - OP7, 16-1
- Mounting depth, C-1
- Mounting dimensions
 - OP17, 16-3
 - OP7, 16-1
- Mounting location, 14-1
- Move, characters, 3-3
- Moving, screen segment, 4-6
- MPI
 - address, 9-1
 - connection, 16-2, 16-4
 - report, 2-3
- Multilinguality, 1-5

N

- NATIVE drivers, 2-3
- NITP report, 2-3
- Noise immunity, C-4
- Non-serious system messages, 7-6
- Normal operation, 15-1
- Notes to operators, 7-2
- Number
 - alarm messages, A-1
 - event messages, A-1
 - messages in alarm message buffer, 7-11
 - messages in event message buffer, 7-11
- Numeric keypad, 3-7, 3-12
- Numerical field, 3-7
- Numerical value input, 3-6, 3-7

O

- Offline, 10-5, 15-6
- Online mode, 10-5
- OP
 - functions, overview, 2-1
 - installing, 14-2
 - start-up, 4-1
- OP modes, A-2
- OP17
 - connection elements, 16-4
 - description, 16-3
 - design, 1-8
 - function keyboard, 1-9
 - interface assignment, D-1
 - interfaces, 1-9
 - LCD , 1-9
 - soft keys, 1-9
 - system keyboard, 1-9
 - versions, 1-8
- OP5 compatibility, 1-7
- OP7
 - connection elements, 16-2
 - description, 16-1
 - design, 1-6
 - function keyboard, 1-7
 - interface assignment, D-1
 - interfaces, 1-7
 - LCD , 1-7
 - soft keys, 1-7
 - system keyboard, 1-7
 - versions, 1-6
- Operand list, 9-2
- Operand value
 - displaying, 9-1
 - modifying, 9-1
- Operating data, saving, 16-8
- Operating level
 - changing, by key, 4-2
 - forced change, 4-2
- Operating levels, 4-1
- Operating mode, download, 15-3
- Operating modes, A-2
- Operating temperature, C-3
- Operator control and monitoring, 4-5, 5-1
- Operator guidance, 5-3
- Operator instructions, 1-4
- Operator prompting, process-dependent, 11-1
- Other PLCs, connection, 16-2, 16-4
- Output field, 5-2
- Overall dimensions, OP7, OP17, C-1
- Overall reset, 3-5, 15-4

- Overflow
 - alarm messages, A-1
 - event messages, A-1
 - message buffer, 7-12
- Overflow warning, 7-3, 7-12
 - message buffer, 7-12
- Overheating, prevention, 14-1

P

- Panel, 14-1
- Password
 - changing, 6-6
 - deleting, 6-6
 - edit, A-2
 - entry, 4-6
 - hierarchy, 6-1
- Password index, 6-5
- Password level, 4-6, A-1
 - assigning, 11-2
 - changing, 6-6
- Password levels, 6-1
- Password list, displaying, 6-4
- Password management, A-2
- Password protection, 6-1
- PC, 15-3, 15-4
- PC or PU, connecting, 16-4
- PC/PU, connecting, 16-2
- Plan view
 - OP17, 16-3
 - OP7, 16-1
- PLC
 - Allen–Bradley, 2-3
 - AEG/Modicon, 2-3
 - SIMATIC 500/505, 2-3
 - SIMATIC M7, 2-3
 - SIMATIC S5, 2-3
 - SIMATIC S7, 2-3
 - Telemecanique, 2-3
- PLC actual value, 5-2
- PLC job, 5-3, 10-5
- PLC jobs, 13-1
- PLC operands, 4-3
- PLC setpoint, 5-2
- PLCs
 - connecting, 1-7, 1-9
 - for use with
 - OP17, 16-4
 - OP7, 16-2
- Pocket calculator format, 3-7, 3-12
- Polarity reversal, battery connector, 16-8

- Polarity reversal protection, 14-3
- Power input, C-2
- Power supply, 14-4
 - backup battery, 16-8
 - connecting, 14-4
- PPI
 - address, 9-1
 - connection, 16-2, 16-4
 - report, 2-3
- Pressure difference, C-3
- Print
 - alarm message buffer, 12-2
 - alarm messages, A-1
 - data record, 12-2
 - event message buffer, 12-2
 - event messages, A-1
 - message buffer, 7-15
 - messages, 7-14
 - screens, 5-4, 12-2, A-1
- Print functions, 14-8, 14-9
- Print time, 7-14
- Printer
 - attaching, 1-7, 1-9
 - attaching a printer, 14-9
 - connecting, 16-2
 - connection, 16-4
 - set parameters, A-2
 - settings, 14-10
- Printer parameters, 4-3
- Printing
 - automatic printout, 7-12
 - data record, 8-3
 - forced printout, 7-12
- Printout, 1-4
 - upon overflow, 7-12
- Priorities, display, 7-8
- Priority
 - display priority, 7-7
 - message display, 1-4
 - message priority, 1-4
- Process, operator control and monitoring, 4-5
- Process control phase, 1-1
- Process state, 1-3
- Process values, 1-3, 1-4
 - viewing, 4-1
- Process-dependent operator prompting, 11-1
- Processing, data record, 8-3
- Product description, 1-1
- PROFIBUS-DP, 2-3, 16-2, 16-4
 - testing communication, 15-8
- Programming unit, 15-3, 15-4
- Prompting, process-dependent, 11-1

- Protection
 - against unauthorized access, 4-6
 - against unauthorized operation, 6-1
- ProTool, 1-1
- PU, 15-3, 15-4
- PU function, 4-3
- PU functions, 9-1
 - FORCE VAR, A-2
 - STATUS VAR, A-2

Q

- Queued messages, 7-11

R

- RAM failure, B-1
- Rated voltage, C-2
- Recipe directory, 8-3
- Recipe title, 8-2
- Recipes, 1-4, 2-2, 8-1
 - example, 8-1
- Recommissioning, 15-1, 15-4
- Relative humidity, C-3
- Remaining buffer space, 7-3
- Remedies, System message, B-2
- Repeat function, 3-4
- Replacing, configuration, 15-4
- Replacing labeling strips, 16-5
- Report
 - Adjust, 2-3
 - AS 511, 2-3
 - DF1, 2-3
 - FAP, 2-3
 - FX, 2-3
 - Modbus, 2-3
 - MPI, 2-3
 - NITP, 2-3
 - PPI, 2-3
 - PROFIBUS-DP, 2-3
 - Uni-Telway, 2-3
- Reserve power, hardware clock, 1-9
- Returning the OP, 14-1
- RF, conduction, C-4
- RF conduction, C-4
- RFI suppression level, C-4
- Right-aligned input, 3-12
- Right-justified input, 3-7
- Room temperature, 14-1

RS232
 connection, 16-2, 16-4
 interface, 1-7, 1-9
RS422
 connection, 16-2, 16-4
 interface, 1-7, 1-9
RS485
 connection, 16-2, 16-4
 Interface, 1-7
 interface, 1-9
RTS signal, changing over, 14-7

S

Safeguarding
 operating data, 16-8
 time, 16-8
Schedule times, 2-2
Scheduler, definition, 1-5
Schedulers, 12-1
 activated, 12-2
 changed, 12-2
 deactivated, 12-2
 functions, 12-2
 time, 12-2
Schedulers time, 1-5, 12-1
Screen, printing, 12-2
Screen components, 5-1
Screen entries, 5-1, 5-2
Screen entry
 components, 5-2
 displaying, 5-2
Screen hierarchy, 4-1, 11-3
 creating, 11-3
 defining, 11-3
Screen level, 3-3, 4-1
Screen number, 5-1
 evaluate, 13-1
Screen segment, moving, 4-5, 4-6
Screen selecting, 12-2
Screen title, 5-1
Screen updating, 5-2

Screens, 1-3, 4-3, 5-1
 directory, 1-3, 5-1
 edit, A-1
 editing, 5-4
 linking, 11-3
 max. number, 2-2
 print, A-1
 printing, 5-4
 selecting, 4-6, 5-3
Screw-type clamps, 14-2
Scroll function, 4-6
Scrolling
 in symbolic lists, 3-5
 screen segment, 4-6
Scrolling in
 directory, 5-3
 help text, 3-14
 messages, 3-4
 messages (message level), 7-8
Securing, OP, 14-2
Selection field, 5-2
Self test, 15-5
Self-healing fuse, 1-9
Serious system messages, 7-6
Setting bits, 11-2
Shift key, 3-3
Shock resistance, C-3
Side view
 OP17, 16-3
 OP7, 16-1
SIMATIC 500/505, 2-3
 connection, 16-2, 16-4
SIMATIC HMI documentation, E-1
SIMATIC M7, 2-3
 connection, 16-2, 16-4
SIMATIC S5, 2-3
 connection, 16-2, 16-4
SIMATIC S7, 2-3
 connection, 16-2, 16-4
 STATUS/FORCE VAR, 9-1
Single display, 7-8
Situation-specific operator prompting, 11-1

- Size
 - labeling strips, 16-6
 - OP17, 16-3
 - OP7, 16-1
- SLIDE.DOC, file, 16-7
- Soft key, setting bits, 11-2
- Soft keys, 3-2, 4-5, 5-2, 5-3, 11-1
 - assignment, 5-2
 - number, 2-2, C-2
 - OP17, 1-9
 - OP7, 1-7
- Source of supply, backup battery, 16-8
- Spare parts service, 16-8
- Special characters, 3-8
- Standard screen
 - alarm messages
 - number, 7-11
 - view, 7-10
 - event messages
 - number, 7-11
 - overflow, 7-12
 - view, 7-10
 - password
 - edit, 6-4
 - login, 6-3
 - records, 8-3
 - system settings
 - message display, 7-7
 - OP mode, Download, 15-4
 - printer, 7-14
 - system messages, 7-10
- Standard screens, 4-1, 4-3
 - branching in screen hierarchy, 4-5
- Standby message, 4-1, 7-3, 15-3, 15-4
- Start screen, 4-1, 11-3
- Start-up Behavior, 15-5
- Start-up of the OP, 4-1
- State
 - indicatiog, 7-1
 - LED, 13-1
- Static text, 1-2, 5-2
- Status messages, 7-2
- Status tag, 4-3
- STATUS VAR, 9-1, 14-8, A-2
- Storage conditions, C-3
- Stored energy time, 10-3
- Structure, data, 8-1
- Structure of the documentation, E-1
- Sum
 - alarm messages, 7-11
 - event messages, 7-11
- Superuser, 4-3, 6-1
- Supervisor, 6-4
 - password, 6-2
- Suppressing, alarm messages, 7-4
- Switching on, OP, 15-3, 15-4
- Switching over
 - message logging, 7-14
 - overflow warning, 7-12
- Symbolic
 - display, actual values, 5-2
 - list, scrolling, 3-5
 - value input, 3-6
- Synchronize, date and time, 13-2
- System, operator control and monitoring, 4-5
- System keyboard
 - OP17, 1-9
 - OP7, 1-7
- System keyboard image, 13-2
- System keys, 3-1, 3-2, C-2
 - entering, 3-7, 3-12
- System message, 7-6
 - hiding, 4-2
- System message buffer, 7-6
 - delete, 7-13
 - display, A-2
- System message display, hiding, 4-2
- System messages, 7-2
 - inhibit, 7-6
 - List of, B-1
- System settings, 4-3
 - display messages, A-2
 - interface parameters, A-2
 - OP mode, A-2
 - printer parameters, A-2
 - select language, A-2
 - set date and time, A-2

T

- Target groups, E-1
- Technical data, C-1
- Telemecanique, 2-3
- Temperature, C-3
- Template, labeling strips, 16-6
- Temporary storage, 7-14
- Terminal block, 14-4
- Test, communication, online, 15-8
- Testing the configuration
 - in Offline mode, 15-6
 - with PLC, 15-7

Text
 replaces value, 3-11
 static, 5-2
Text attributes, 14-10
Time, 10-3, 13-2
 safeguarding, 16-8
 set, A-2
Time response, updating data, 2-3
Timer, value input, 3-6, 3-12
Title, screen, 5-1
Together, 7-15
Touch-sensitive front, 1-6, 1-8
Transfer
 date, 13-2
 time, 13-2
Transfer mode, cancel, 3-4, 15-3
Transfer screen, 8-7
Transferring, data record, 8-3
Transferring data records, 8-3
Transients, C-2
Transportation conditions, C-3
TTY
 connection, 16-2, 16-4
 interface, 1-7, 1-9
Turning on the, OP, 14-1
Two-color LEDs, 1-9
Type
 backup battery, C-2
 display, C-1
 keyboard, C-2

U

Unauthorized access, 4-6
Unauthorized operation, 4-6
Uni-Telway report, 2-3
Updating
 PLC values, 5-2
 speeding up, 5-2
 values, 9-4

Upgrading, battery, 1-9, 16-8
Using OPs, 1-1

V

Value, input, 3-6
Values
 changing, 3-7, 3-8, 3-12
 updating, 5-2, 9-4
Variable text, 1-2
Versions
 OP17, 1-8
 OP7, 1-6
Vibration, C-3
View
 alarm message text, 7-9
 alarm messages, A-1
 event message text, 7-9
 event messages, A-1
Viewing
 message buffer, 7-10
 number of messages, 7-11
Visualization, 1-1
Visualizing, processes, 1-3
Visualizing and controlling processes, 1-3
Voltage, backup battery, C-2
Voltage supply, C-2

W

Warning, buffer overflow, 7-12
Weight, C-1

Y

Y cable, 14-9