

Equipment for special machines

WF 725/WF 726  
Positioning Modules

Installation Instructions Edition 10.92

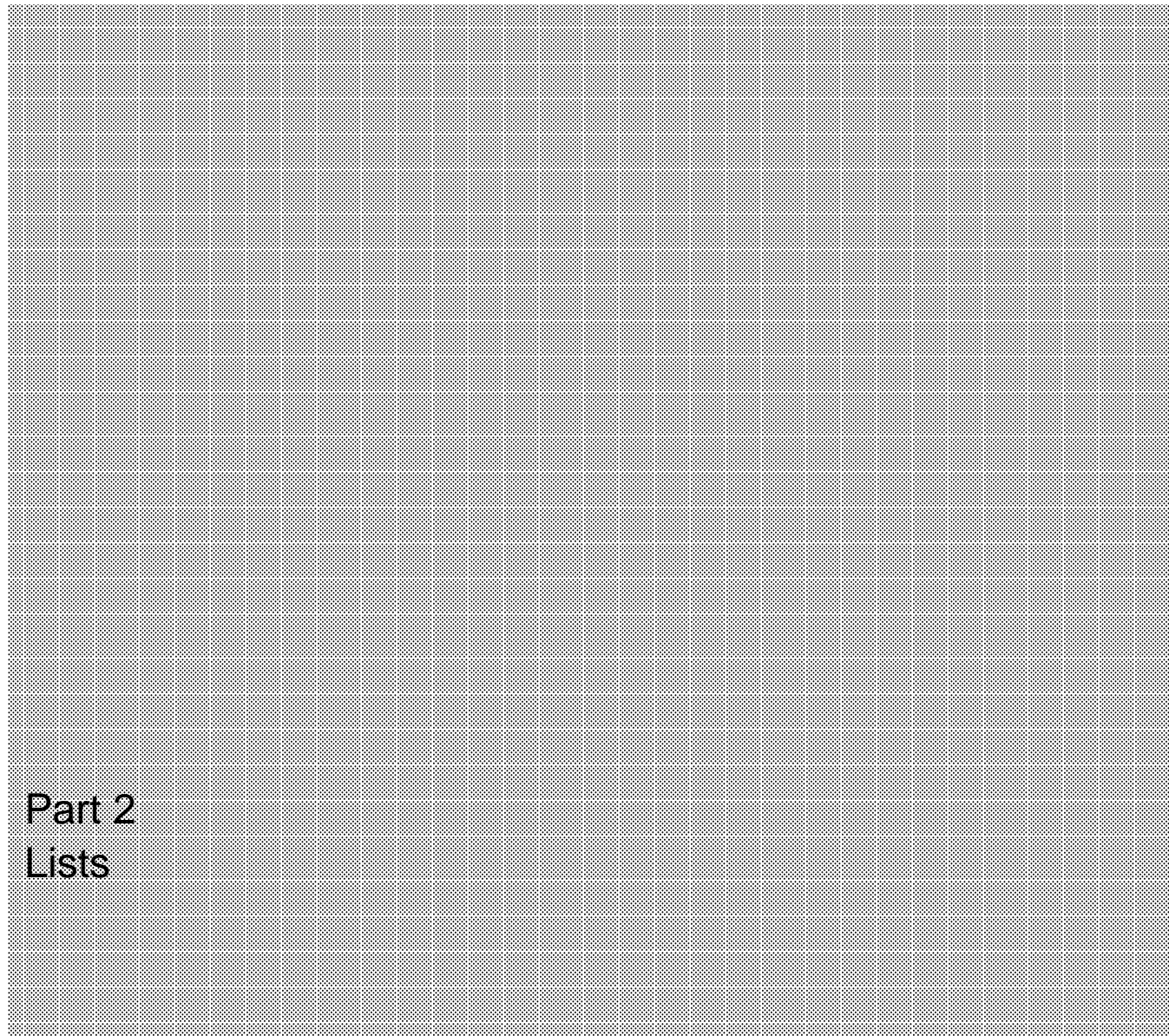

Part 2  
Lists



WF 725/WF 726  
Positioning Modules

Installation Instructions  
Part 2  
Lists

---

Flowchart for Start UP	2
Machine Data	3
STEP 5 Blocks and Parameter	4
Data and Data Interfaces	5
Error Messages	6

---

Valid for: WF 725 V1.12  
WF 726 V1.4  
Standard I V0.4 (V0.5 AG S5-115U)  
Standard III V0.5 (V0.6 AG S5-115U)  
Overlay V0.5

***Please note***

*As it was our aim to provide you with a concise manual for the product in hand, we have refrained from including every single detail about the product types available. It is therefore beyond the scope of this manual to discuss every situation that could arise when commissioning, running and servicing the product.*

*Should you require additional information, please do not hesitate to contact your nearest Siemens representative.*

*The contents of this product are not part of an earlier or current agreement, undertaking or contract, nor shall they supersede any such previous arrangements. The obligations of Siemens result from the sales contract in force which also describes the warranty conditions that are valid. The contractual warranty clause is neither extended nor restricted in any way by the contents of this manual.*

SIMATIC, SIMODRIVE, SINEC, SINUMERIK, STEP are registered trade marks of Siemens Aktiengesellschaft.

The remaining designations referred to in this manual may be trade marks whose use through third parties for their own purposes may infringe the rights of the owners of the trade mark.

This publication was produced on the Siemens 5800 Office System.

Subject to technical changes.

The reproduction, transmission or use of this document or of its contents is not permitted without express written authority. Offenders will be liable for damages. All rights, including rights supplied by patent grant or registration of a utility model or design, are reserved.

© Siemens AG 1993 All Rights Reserved

# Index

<b>1</b>	<b>Notes</b> .....	1 - 1
<b>2</b>	<b>Flowchart for Start Up</b> .....	2 - 1
<b>3</b>	<b>Machine Data</b> .....	3 - 1
3.1	WF 725 A: Open Loop with Incremental Encoders .....	3 - 1
3.2	WF 725 A: Closed Loop with Incremental Encoders .....	3 - 4
3.3	WF 725 B: Open Loop with Parallel Absolute Encoders .....	3 - 7
3.4	WF 725 B: Closed Loop with Parallel Absolute Encoders .....	3 - 9
3.5	WF 726 A/C: Open Loop with Incremental Encoders .....	3 - 12
3.6	WF 726 A/C: Closed Loop with Incremental Encoders .....	3 - 15
3.7	WF 726 B: Open Loop with Parallel Absolute Encoders .....	3 - 18
3.8	WF 726 B: Closed Loop with Parallel Absolute Encoders .....	3 - 21
3.9	WF 726 C: Closed Loop with Serial Absolute Encoders .....	3 - 24
3.10	WF 726 C: Open Loop with Serial Absolute Encoders .....	3 - 27
<b>4</b>	<b>STEP 5 Blocks and Parameter</b> .....	4 - 1
4.1	Start Up Function Blocks in OB 20, 21 and 22 .....	4 - 1
4.2	Start Up Function Blocks for Cyclic Operation in OB 1 .....	4 - 1
4.3	Data Blocks for Start Up and Cyclic Operation .....	4 - 2
4.4	Set Up Standard I and Standard III .....	4 - 3
4.5	Standard I with Comfort Version .....	4 - 4
4.6	Standard III (without memory Administration) .....	4 - 5

4.7	Memory administration of the SIMATIC S5 (together with Standard III) . . .	4 - 6
4.8	Standard WF 470 with Standard III . . . . .	4 - 7
4.9	Software Overlay . . . . .	4 - 8
4.10	Library Numbers . . . . .	4 - 9
<b>5</b>	<b>Data and Data Interfaces . . . . .</b>	<b>5 - 1</b>
5.1	MODE Selection - DBWF . . . . .	5 - 1
5.1.1	Traversing MODE . . . . .	5 - 1
5.1.2	Program Input/Output MODE . . . . .	5 - 1
5.1.3	Service MODE . . . . .	5 - 1
5.1.4	Machine Data Input/Output MODE . . . . .	5 - 1
5.2	Data Interface Traversing MODE . . . . .	5 - 2
5.2.1	Control and Feedback Bits in DB Axis . . . . .	5 - 2
5.2.1.1	Control Bits in DB Axis . . . . .	5 - 2
5.2.1.2	Feedback Bits in DB Axis . . . . .	5 - 2
5.2.2	Data Codes in DB Axis . . . . .	5 - 3
5.2.2.1	Input/Output of Data with Data Codes (DB Axis) Controlled by Strobe Signals . . . . .	5 - 7
5.2.2.2	Output of Data with Data Codes (DB Axis) Cyclical Read-out (only from RAM) . . . . .	5 - 7
5.2.3	Fast Block Input in the Operating Mode MDI with DPR 32 or DPR 64 (DB Axis) . . . . .	5 - 8
5.2.4	Reloading of Buffer with DPR 32 . . . . .	5 - 8
5.3	Data Interface MODE Program Data . . . . .	5 - 9
5.3.1	Interface for Traversing Blocks DBWF . . . . .	5 - 9
5.3.2	Structure of the Traversing Blocks . . . . .	5 - 10
5.3.3	Special routines . . . . .	5 - 11
5.3.3.1	Delete a block . . . . .	5 - 11
5.3.3.2	Delete a program . . . . .	5 - 11
5.3.3.3	Delete the block list . . . . .	5 - 11
5.3.3.4	Input of number of blocks . . . . .	5 - 12
5.3.3.5	Input of validity . . . . .	5 - 12
5.3.3.6	Output of existing block numbers . . . . .	5 - 13
5.3.3.7	Output of existing programs . . . . .	5 - 13
5.3.3.8	Output of software and hardware versions . . . . .	5 - 14
5.3.3.9	Output of number of blocks . . . . .	5 - 14
5.3.3.10	Output of validity . . . . .	5 - 15

5.4	Interface MODE machine data Input/output .....	5 - 16
5.4.1	Data channel machine data DB-Axis .....	5 - 16
<b>6</b>	<b>Error Messages</b> .....	<b>6 - 1</b>
6.1	Output of Error Messages .....	6 - 1
6.1.1	Errors in Traversing MODE .....	6 - 1
6.1.1.1	Errors During Traversing .....	6 - 1
6.1.1.2	Errors During Data Transfer .....	6 - 1
6.1.2	Errors in MODE Program Data .....	6 - 1
6.1.3	Errors in Mode Service .....	6 - 2
6.1.4	Errors in Mode Machine Data .....	6 - 2
6.1.5	Errors from S5-Program, Independent of MODE .....	6 - 2
6.2	Significance of the Error Numbers .....	6 - 3
6.2.1	WF-Messages in MODE Traversing .....	6 - 3
6.2.2	WF-Messages in MODE Program Input/Output .....	6 - 6
6.2.3	Messages from the STEP 5 Memory Administration .....	6 - 7
6.2.4	Messages from the Software Overlay .....	6 - 8





# 1 Notes

This manual, Start Up Instructions - Lists, contains the most important data, mostly in the form of lists, for the WF 725 and WF 726 positioning modules. Further information and detailed descriptions can be found in the other manuals. All available manuals are listed on the inside cover of this manual.

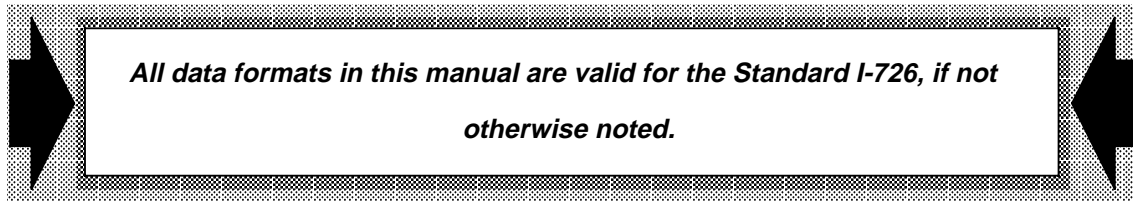

For operation and programming of the WF module with the Software Overlay or the Standard III, use the data format valid for the selected Standard. The information required for the individual data formats can be found in the following manuals:

- (1) WF 725/WF 726 Positioning Modules 6ZB5 440-0GK02-0AA1  
**Planning Instructions Part 2:**  
Interface Description of the Standard-Software-Overlay
  
- (2) WF 725/WF 726 Positioning Modules 6ZB5 440-0GL02-0AA3  
**Planning Instructions Part 3:**  
Interface Description of the Standard-Software-I-726, II-726 and III-726
  
- (3) WF 725/WF 726 Positioning Modules 6ZB5 440-0FX02-0AA1  
**Operation Instructions Part 1:**  
WF 470 Standard III

## Graphic Representation

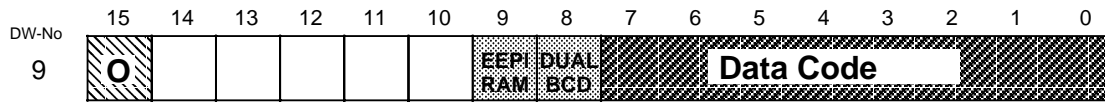

Is a certain bit or bit combination only active if it is ON (high), then it is shown, in this graphic representation, by a single letter or by plain text.

Bits with the same significance or similar function have the same type of background, e.g. all input bits have the same type of background. Bit combinations which belong together are represented with the same background.

If a bit has two functions, e.g. EEPROM or RAM, then the function active if the bit is OFF is shown in the lower part (e.g. RAM), it is shown in the upper part if the function is active if the bit is ON (e.g. EEPROM).

Each bit is precisely defined by a number like 9.15: The number before the decimal point defines the data word, the number after the decimal point defines the bit within that data word - bit 9.15 is therefore bit 15 in data word 9.

## 2 Flowchart for Start Up

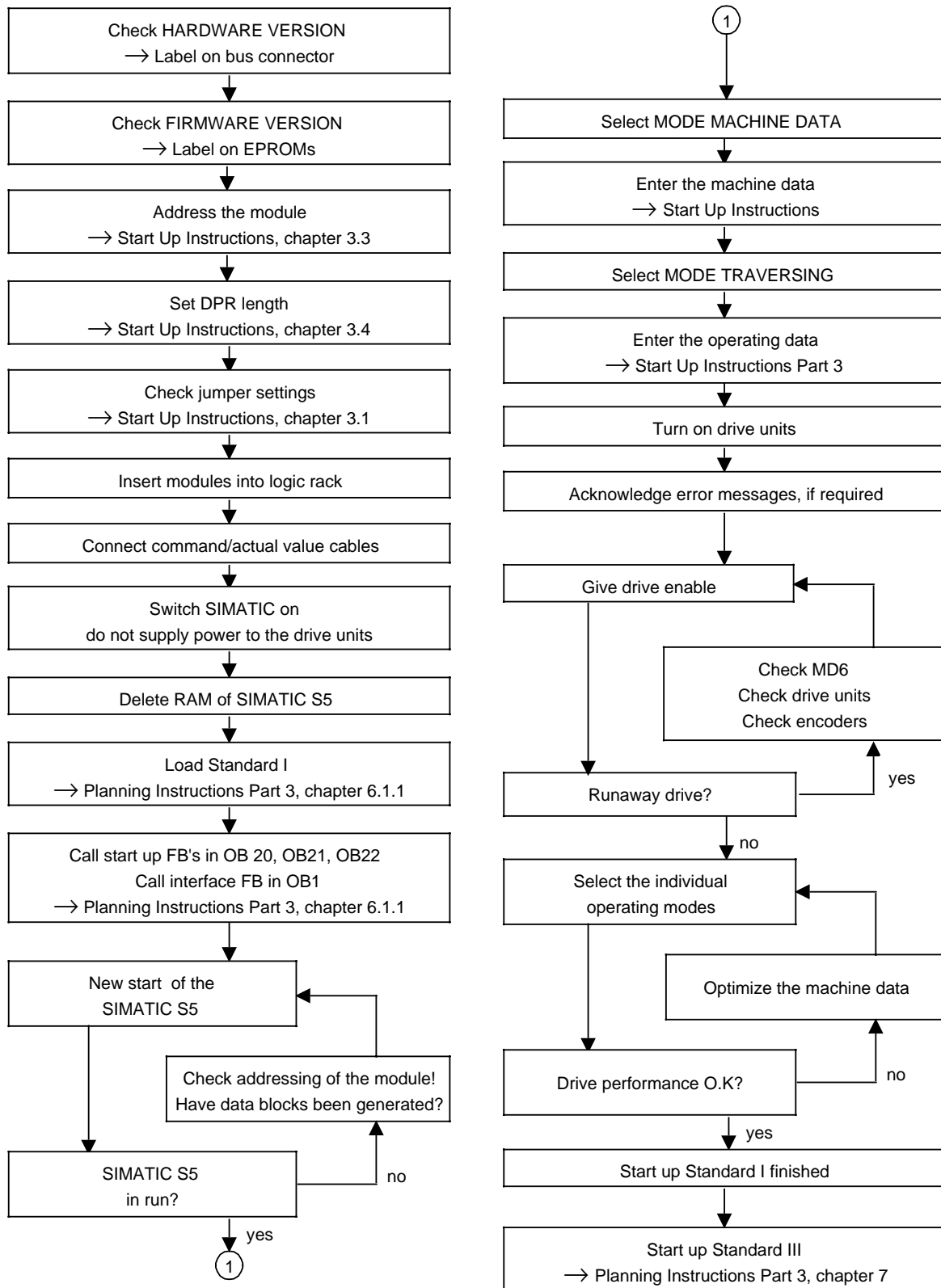



# 3 Machine Data

## 3.1 WF 725 A: Open Loop with Incremental Encoders

MD- No.	Name	Lower Limit	Upper Limit	Format in BCD				unit		
4	Type of control and encoder	X=3		0	0	0	0	—		
				0	0	0	X			
6	Assignment of trav.direction to command value		Voltage with positive movement	Count direction of the act. value					—	
		X=0	+	+	0	0	0	0		
		X=1	-	+	0	0	0	X		
		X=2	+	-						
X=3	-	-								
7	Reference point approach direction	X=1	Reference point is the zero mark to the right of the deceleration cam			0	0	0	0	—
		X=2	Reference point is the zero mark to the left deceleration cam			0	0	0	X	
8	Type of output M-Function	time controlled: 4	time controlled:65		0	0	0	10 <sup>4</sup>	ms	
		strobe controlled: 0			10 <sup>3</sup>	10 <sup>2</sup>	10 <sup>1</sup>	10 <sup>0</sup>		
9	Time of output M-Function	X=1	during positioning			0	0	0	0	—
		X=2	before positioning			0	0	0	X	
X=3	after positioning			0	0	0	X			
10	Fast outputs	O <sub>x</sub> =0	Output without function			0	0	O <sub>6</sub>	O <sub>5</sub>	—
		O <sub>x</sub> =1	Position reached and stop							
		O <sub>x</sub> =2	traversing direction +			O <sub>4</sub>	0	0	0	
		O <sub>x</sub> =3	traversing direction -							
O <sub>x</sub> =4	reserve									
O <sub>x</sub> =5	reserve									
O <sub>x</sub> =6	reserve									
O <sub>x</sub> =7	reserve									
O <sub>x</sub> =8	reserve									
O <sub>x</sub> =9	reserve									
					O <sub>1</sub> : enter 0 cut off point A O <sub>2</sub> : enter 0 cut off point B O <sub>3</sub> : enter 0 cut off point C					
11	Pre-limit-switch negative	greater than limit switch negative (MD 12)		smaller than pre-limit-switch positive (MD 13)	SI	10 <sup>7</sup>	10 <sup>6</sup>	10 <sup>5</sup>	10 <sup>4</sup>	μm
						10 <sup>3</sup>	10 <sup>2</sup>	10 <sup>1</sup>	10 <sup>0</sup>	
12	Limit switch negative	1 μm -79 999999 10 μm -79 999990 100 μm -79 999900		smaller than pre-limit-switch negative (MD 11)	SI	10 <sup>7</sup>	10 <sup>6</sup>	10 <sup>5</sup>	10 <sup>4</sup>	μm
						10 <sup>3</sup>	10 <sup>2</sup>	10 <sup>1</sup>	10 <sup>0</sup>	
13	Pre-limit-switch positive	greater than pre-limit-switch negative (MD 11)		greater than pre-limit-switch positive (MD 14)	SI	10 <sup>7</sup>	10 <sup>6</sup>	10 <sup>5</sup>	10 <sup>4</sup>	μm
						10 <sup>3</sup>	10 <sup>2</sup>	10 <sup>1</sup>	10 <sup>0</sup>	
14	Limit switch positive	greater than pre-limit-switch positive (MD 13)		1 μm +79 999999 10 μm +79 999990 100 μm +79 999900	SI	10 <sup>7</sup>	10 <sup>6</sup>	10 <sup>5</sup>	10 <sup>4</sup>	μm
						10 <sup>3</sup>	10 <sup>2</sup>	10 <sup>1</sup>	10 <sup>0</sup>	

**Machine data which becomes active only after a RESET is marked with a gray background.**

MD-No.	Name	Lower Limit	Upper Limit	Format in BCD				Unit	
15	Deceleration Cam	X=1	Deceleration signal over S5 bit	0	0	0	0	—	
		X=2	Dec.signal on I <sub>1</sub> ,I <sub>2</sub> ,I <sub>3</sub> on conn. X7	0	0	0	X		
16	Reference point coordinate	1 µm -79 999999	1 µm +79 999999	SI	10 <sup>7</sup>	10 <sup>6</sup>	10 <sup>5</sup>	10 <sup>4</sup>	µm
		10 µm -79 999990	10 µm +79 999990	10 <sup>3</sup>	10 <sup>2</sup>	10 <sup>1</sup>	10 <sup>0</sup>		
17	Zero marker shift	1 µm -65 535	1 µm +65 535	SI	0	10 <sup>6</sup>	10 <sup>5</sup>	10 <sup>4</sup>	µm
		10 µm -655 350	10 µm +655 350	10 <sup>3</sup>	10 <sup>2</sup>	10 <sup>1</sup>	10 <sup>0</sup>		
18	Linear-/ Rotary axis	0 or 1 ⇒ Linear axis		10 <sup>7</sup>	10 <sup>6</sup>	10 <sup>5</sup>	10 <sup>4</sup>	—	
		2   79 999999		10 <sup>3</sup>	10 <sup>2</sup>	10 <sup>1</sup>	10 <sup>0</sup>		
19	Pulse evaluation before the decimal point	0		9	0	0	0	0	—
		0		99 999999	0	0	0	10 <sup>0</sup>	
20	Pulse evaluation after the decimal point	0		99 999999	10 <sup>-1</sup>	10 <sup>-2</sup>	10 <sup>-3</sup>	10 <sup>-4</sup>	—
		0		99 999999	10 <sup>-5</sup>	10 <sup>-6</sup>	10 <sup>-7</sup>	10 <sup>-8</sup>	
21	Pulse multiplication	X=1	Enc. pulses multiplied with	} 1 2 = } Evaluation of the actual value	0	0	0	0	—
		X=2			X=4	0	0	0	
28	Coordinate of actual value	1 µm -79 999999	1 µm +79 999999	SI	10 <sup>7</sup>	10 <sup>6</sup>	10 <sup>5</sup>	10 <sup>4</sup>	µm
		10 µm -79 999990	10 µm +79 999990	10 <sup>3</sup>	10 <sup>2</sup>	10 <sup>1</sup>	10 <sup>0</sup>		
30	PEH positioning time out	0		9 999	0	0	0	0	ms
		0		9 999	10 <sup>3</sup>	10 <sup>2</sup>	10 <sup>1</sup>	10 <sup>0</sup>	
31	Backlash compensation	0		1 µm 65 535 10 µm 655 350 100 µm 6553 500	0	10 <sup>6</sup>	10 <sup>5</sup>	10 <sup>4</sup>	µm
		0		1 µm 65 535 10 µm 655 350 100 µm 6553 500	10 <sup>3</sup>	10 <sup>2</sup>	10 <sup>1</sup>	10 <sup>0</sup>	
32	Clamping tolerance	0		1 µm 65 535 10 µm 655 350 100 µm 6553 500	0	10 <sup>6</sup>	10 <sup>5</sup>	10 <sup>4</sup>	µm
		0		1 µm 65 535 10 µm 655 350 100 µm 6553 500	10 <sup>3</sup>	10 <sup>2</sup>	10 <sup>1</sup>	10 <sup>0</sup>	
33	PEH-Positioning tolerance	0		1 µm 65 535 10 µm 655 350 100 µm 6553 500	0	10 <sup>6</sup>	10 <sup>5</sup>	10 <sup>4</sup>	µm
		0		1 µm 65 535 10 µm 655 350 100 µm 6553 500	10 <sup>3</sup>	10 <sup>2</sup>	10 <sup>1</sup>	10 <sup>0</sup>	
34	Number of pulses/ Encoder revolut.	100		79 999999	10 <sup>7</sup>	10 <sup>6</sup>	10 <sup>5</sup>	10 <sup>4</sup>	—
		100		79 999999	10 <sup>3</sup>	10 <sup>2</sup>	10 <sup>1</sup>	10 <sup>0</sup>	
40	Simulation	X=0	no simulation		0	0	0	0	—
		X=1	simulation		0	0	0	X	
41	Masking of check routines	Cable break check		1	0	0	10 <sup>5</sup>	10 <sup>4</sup>	—
		Voltage check		2	0	0	10 <sup>5</sup>	10 <sup>4</sup>	
41	Masking of check routines	Pulse check		65 536	10 <sup>3</sup>	10 <sup>2</sup>	10 <sup>1</sup>	10 <sup>0</sup>	—
		Zero marker check		131 072	10 <sup>3</sup>	10 <sup>2</sup>	10 <sup>1</sup>	10 <sup>0</sup>	

**Machine data which becomes active only after a RESET, is marked with a gray background.**

MD- No.	Name	Lower Limit	Upper Limit	Format in BCD				Unit
42	Reduction speed 1	≥MD43	99	0	0	0	0	—
				0	0	10 <sup>1</sup>	10 <sup>0</sup>	
43	Reduction speed 2	≥MD44	≤MD42	0	0	0	0	—
				0	0	10 <sup>1</sup>	10 <sup>0</sup>	
44	Reduction speed 3	1	≤MD43	0	0	0	0	—
				0	0	10 <sup>1</sup>	10 <sup>0</sup>	
45	Travel difference 1	≥MD46	1 μm 79 999999 10 μm 79 999990 100 μm 79 999900	10 <sup>7</sup>	10 <sup>6</sup>	10 <sup>5</sup>	10 <sup>4</sup>	μm
				10 <sup>3</sup>	10 <sup>2</sup>	10 <sup>1</sup>	10 <sup>0</sup>	
46	Travel difference 2	≥MD47	≤MD45	10 <sup>7</sup>	10 <sup>6</sup>	10 <sup>5</sup>	10 <sup>4</sup>	μm
				10 <sup>3</sup>	10 <sup>2</sup>	10 <sup>1</sup>	10 <sup>0</sup>	
47	Travel difference 3	≥MD48	≤MD46	10 <sup>7</sup>	10 <sup>6</sup>	10 <sup>5</sup>	10 <sup>4</sup>	μm
				10 <sup>3</sup>	10 <sup>2</sup>	10 <sup>1</sup>	10 <sup>0</sup>	
48	Travel difference 4	0	≤MD47	10 <sup>7</sup>	10 <sup>6</sup>	10 <sup>5</sup>	10 <sup>4</sup>	μm
				10 <sup>3</sup>	10 <sup>2</sup>	10 <sup>1</sup>	10 <sup>0</sup>	
49	Basic resolution	X=1 X=2 X=3	1 μm 10 μm 100 μm	0	0	0	0	—
				0	0	0	X	

**Machine data which becomes active only after a RESET is marked with a gray background.**

### 3.2 WF 725 A: Closed Loop with Incremental Encoders

MD-No.	Name	Lower Limit	Upper Limit	Format in BCD				Unit			
1	Acceleration	1 $\mu\text{m}$	1	1 $\mu\text{m}$	20 000	0	0	$10^5$	$10^4$	$\text{mm/s}^2$	
		10 $\mu\text{m}$	10	10 $\mu\text{m}$	200 000	$10^3$	$10^2$	$10^1$	$10^0$		
2	Deceleration	1 $\mu\text{m}$	1	1 $\mu\text{m}$	20 000	0	0	$10^5$	$10^4$	$\text{mm/s}^2$	
		10 $\mu\text{m}$	10	10 $\mu\text{m}$	200 000	$10^3$	$10^2$	$10^1$	$10^0$		
3	Maximum feed rate	1 $\mu\text{m}$	10	1 $\mu\text{m}$	3 000 000	$10^7$	$10^6$	$10^5$	$10^4$	mm	
		10 $\mu\text{m}$	10	10 $\mu\text{m}$	30 000 000	$10^3$	$10^2$	$10^1$	$10^0$	100 min	
4	Type of control and encoder	X=1			0	0	0	0	0	—	
		X=1			0	0	0	X			
6	Assignment of trav. direction to command voltage		Voltage with positive movement	Count direction of the actual value						—	
		X=0	+	+		0	0	0	0		
		X=1	-	+		0	0	0	X		
		X=2	+	-							
7	Reference point approach direction	X=1	Reference point is the zero mark to the right of deceleration cam			0	0	0	0	—	
		X=2	Reference point is the zero mark to the left of deceleration cam			0	0	0	X		
8	Type of output of M-Function	time controlled: 4	time controll.: 65535		0	0	0	$10^4$	ms		
		strobe controlled: 0	strobe controlled: 3		$10^3$	$10^2$	$10^1$	$10^0$			
9	Time of output of M-Function	X=1	during positioning			0	0	0	0	—	
		X=2	before positioning			0	0	0	X		
10	Fast outputs	O <sub>x</sub> =0	output without function							—	
		O <sub>x</sub> =1	position reached and stop								
11	Pre-limit-switch negative	greater than limit switch negative (MD 12)	smaller than pre-limit-switch positive (MD 13)		SI	$10^7$	$10^6$	$10^5$	$10^4$	$\mu\text{m}$	
						$10^3$	$10^2$	$10^1$	$10^0$		
12	Limit switch negative	1 $\mu\text{m}$	-79 999999	smaller than pre-limit-switch negative (MD 11)		SI	$10^7$	$10^6$	$10^5$	$10^4$	$\mu\text{m}$
		10 $\mu\text{m}$	-79 999990			$10^3$	$10^2$	$10^1$	$10^0$		
13	Pre-limit-switch positive	greater than pre-limit-switch negative (MD 11)	smaller than limit switch positive (MD 14)		SI	$10^7$	$10^6$	$10^5$	$10^4$	$\mu\text{m}$	
						$10^3$	$10^2$	$10^1$	$10^0$		
14	Limit switch positive	greater than pre-limit-switch positive (MD 13)	1 $\mu\text{m}$ +79 999999		SI	$10^7$	$10^6$	$10^5$	$10^4$	$\mu\text{m}$	
						$10^3$	$10^2$	$10^1$	$10^0$		

Machine data which becomes active only after a RESET, is marked with a gray background.



MD- No.	Name	Lower Limit	Upper Limit	Format in BCD				Unit			
15	Deceleration Cam	X=1	Deceleration Signal over S5 bit	0	0	0	0	—			
		X=2	Dec.Signal on I <sub>1</sub> ,I <sub>2</sub> ,I <sub>3</sub> on conn. X7	0	0	0	X				
16	Reference point coordinate	1 µm	-79 999999	1 µm	+79 999999	SI	10 <sup>7</sup>	10 <sup>6</sup>	10 <sup>5</sup>	10 <sup>4</sup>	µm
		10 µm	-79 999990	10 µm	+79 999990						
		100 µm	-79 999900	100 µm	+79 999900		10 <sup>3</sup>	10 <sup>2</sup>	10 <sup>1</sup>	10 <sup>0</sup>	
17	Zero marker shift	1 µm	-65 535	1 µm	+65 535	SI	0	10 <sup>6</sup>	10 <sup>5</sup>	10 <sup>4</sup>	µm
		10 µm	-655 350	10 µm	+655 350						
		100 µm	-6553 500	100 µm	+6553 500		10 <sup>3</sup>	10 <sup>2</sup>	10 <sup>1</sup>	10 <sup>0</sup>	
18	Linear- / rotary axis	0 or 1 ⇒ Linear axis		10 <sup>7</sup>	10 <sup>6</sup>	10 <sup>5</sup>	10 <sup>4</sup>	—			
		2 79 999999		10 <sup>3</sup>	10 <sup>2</sup>	10 <sup>1</sup>	10 <sup>0</sup>				
19	Pulse evaluation before the decimal point	0 9		0	0	0	0	—			
				0	0	0	10 <sup>0</sup>				
20	Pulse evaluation after the decimal point	0 99 999999		10 <sup>-1</sup>	10 <sup>-2</sup>	10 <sup>-3</sup>	10 <sup>-4</sup>	—			
				10 <sup>-5</sup>	10 <sup>-6</sup>	10 <sup>-7</sup>	10 <sup>-8</sup>				
21	Pulse multiplication	X=1	Enc. pulses multiplied with	} 1 } 2 = } 4	Evaluation of the actual value	0	0	0	0	—	
		X=2				0	0	0	X		
22	K <sub>v</sub> -Factor	20 900		0	0	0	0	m/min			
				0	10 <sup>2</sup>	10 <sup>1</sup>	10 <sup>0</sup>	100 mm			
23	Maximum command value voltage	1000 10000		0	0	0	10 <sup>4</sup>	mV			
				10 <sup>3</sup>	10 <sup>2</sup>	10 <sup>1</sup>	10 <sup>0</sup>				
24	Maximum following error dynamic	0	1 µm	65 535	0	10 <sup>6</sup>	10 <sup>5</sup>	10 <sup>4</sup>	µm		
			10 µm	655 350							
			100 µm	6553 500		10 <sup>3</sup>	10 <sup>2</sup>	10 <sup>1</sup>		10 <sup>0</sup>	
25	Maximum following error in standstill	0	1 µm	65 535	0	10 <sup>6</sup>	10 <sup>5</sup>	10 <sup>4</sup>	µm		
			10 µm	655 350							
			100 µm	6553 500		10 <sup>3</sup>	10 <sup>2</sup>	10 <sup>1</sup>		10 <sup>0</sup>	
26	Minimum following error dynamic	0	1 µm	65 535	0	10 <sup>6</sup>	10 <sup>5</sup>	10 <sup>4</sup>	µm		
			10 µm	655 350							
			100 µm	6553 500		10 <sup>3</sup>	10 <sup>2</sup>	10 <sup>1</sup>		10 <sup>0</sup>	
28	Coordinate of actual value	1 µm	-79 999999	1 µm	+79 999999	SI	10 <sup>7</sup>	10 <sup>6</sup>	10 <sup>5</sup>	10 <sup>4</sup>	µm
		10 µm	-79 999990	10 µm	+79 999990						
		100 µm	-79 999900	100 µm	+79 999900		10 <sup>3</sup>	10 <sup>2</sup>	10 <sup>1</sup>	10 <sup>0</sup>	
30	PEH positioning timeout	0 9 999		0	0	0	0	ms			
				10 <sup>3</sup>	10 <sup>2</sup>	10 <sup>1</sup>	10 <sup>0</sup>				
31	Backlash compensation	0	1 µm	65 535	0	10 <sup>6</sup>	10 <sup>5</sup>	10 <sup>4</sup>	µm		
			10 µm	655 350							
			100 µm	6553 500		10 <sup>3</sup>	10 <sup>2</sup>	10 <sup>1</sup>		10 <sup>0</sup>	
32	Clamping tolerance	0	1 µm	65 535	0	10 <sup>6</sup>	10 <sup>5</sup>	10 <sup>4</sup>	µm		
			10 µm	655 350							
			100 µm	6553 500		10 <sup>3</sup>	10 <sup>2</sup>	10 <sup>1</sup>		10 <sup>0</sup>	

**Machine data which becomes active only after a RESET, is marked with a gray background.**

MD- No.	Name	Lower Limit	Upper Limit	Format in BCD				Unit		
33	PEH- Positioning tolerance	0	1 µm 10 µm 100 µm	65 535 655 350 6553 500	0	10 <sup>6</sup>	10 <sup>5</sup>	10 <sup>4</sup>	µm	
					10 <sup>3</sup>	10 <sup>2</sup>	10 <sup>1</sup>	10 <sup>0</sup>		
34	Number of pulses / encoder revolution	100		79 999999	10 <sup>7</sup>	10 <sup>6</sup>	10 <sup>5</sup>	10 <sup>4</sup>	—	
					10 <sup>3</sup>	10 <sup>2</sup>	10 <sup>1</sup>	10 <sup>0</sup>		
35	Drift compensation	1 µm	-255	1 µm	+255	SI	0	0	0	10 <sup>4</sup>
		10 µm	-2550	10 µm	+2550					
		100 µm	-25500	100 µm	+25500	10 <sup>3</sup>	10 <sup>2</sup>	10 <sup>1</sup>	10 <sup>0</sup>	µm
36	Acceleration correction	not active		BCD:	BINARY:					—
		Step 1	32 769	0	0	0	0	10 <sup>4</sup>		
		Step 2	32 770	8001	0	0	0	10 <sup>4</sup>		
		:	:	8002	10 <sup>3</sup>	10 <sup>2</sup>	10 <sup>1</sup>	10 <sup>0</sup>		
		Step 14	32 782	:						
Step 15	32 783	800E								
				800F						
40	Simulation	X=0	no simulation			0	0	0	0	—
		X=1	simulation			0	0	0	X	
41	Masking of check routines	Cable break check		1	0	0	10 <sup>5</sup>	10 <sup>4</sup>	—	
		Voltage check		2	0	0	10 <sup>5</sup>	10 <sup>4</sup>		
		Pulse check		65 536	10 <sup>3</sup>	10 <sup>2</sup>	10 <sup>1</sup>	10 <sup>0</sup>		
		Zero marker check		131 072	10 <sup>3</sup>	10 <sup>2</sup>	10 <sup>1</sup>	10 <sup>0</sup>		
42	Roller feed	X=0	no roll feed			0	0	0	0	—
		X=1	roll feed			0	0	0	X	
49	Basic resolution	X=1	1 µm			0	0	0	0	—
		X=2	10 µm			0	0	0	0	
		X=3	100 µm			0	0	0	X	

**Machine data which becomes active only after a RESET, is marked with a gray background.**

### 3.3 WF 725 B: Open Loop with Parallel Absolute Encoders

MD-No.	Name	Lower Limit	Upper Limit	Format in BCD				Unit	
4	Type of control and encoder	X=4		0	0	0	0	—	
				0	0	0	X		
5	Number of steps Absolute encoder	0	16 777 215	10 <sup>7</sup>	10 <sup>6</sup>	10 <sup>5</sup>	10 <sup>4</sup>	—	
				10 <sup>3</sup>	10 <sup>2</sup>	10 <sup>1</sup>	10 <sup>0</sup>		
6	Assignment of trav.direction to command value		Voltage with the positive movement	Count direction of the acr. value	0	0	0	0	—
		X=0 X=1	+	-	+	+	0	0	
7	Masked range of Absolute encoder	0	79 999999	10 <sup>7</sup>	10 <sup>6</sup>	10 <sup>5</sup>	10 <sup>4</sup>	—	
				10 <sup>3</sup>	10 <sup>2</sup>	10 <sup>1</sup>	10 <sup>0</sup>		
8	Type of output of M-Function	time controlled: 4	time controll.:65 535	0	0	0	10 <sup>4</sup>	ms	
		strobe controlled: 0	strobe controlled: 3	10 <sup>3</sup>	10 <sup>2</sup>	10 <sup>1</sup>	10 <sup>0</sup>		
9	Time of output of M-Function	X=1	during positioning before positioning after positioning	0	0	0	0	—	
		X=2 X=3		0	0	0	X		
10	Fast outputs	O <sub>x</sub> =0	Output without function Position reached and stop traversing direction + traversing direction - reserve reserve reserve reserve reserve reserve	0	0	O <sub>6</sub>	O <sub>5</sub>	—	
		O <sub>x</sub> =1 O <sub>x</sub> =2 O <sub>x</sub> =3 O <sub>x</sub> =4 O <sub>x</sub> =5 O <sub>x</sub> =6 O <sub>x</sub> =7 O <sub>x</sub> =8 O <sub>x</sub> =9		O <sub>4</sub>	0	0	0		
11	Pre-limit-switch negative	greater than limit switch negative (MD 12)	smaller than pre-limit-switch positive (MD 13)	SI	10 <sup>7</sup>	10 <sup>6</sup>	10 <sup>5</sup>	10 <sup>4</sup>	μm
					10 <sup>3</sup>	10 <sup>2</sup>	10 <sup>1</sup>	10 <sup>0</sup>	
12	Limit switch negative	1 μm -79 999999	smaller than pre-limit-switch negative (MD 11)	SI	10 <sup>7</sup>	10 <sup>6</sup>	10 <sup>5</sup>	10 <sup>4</sup>	μm
		10 μm -79 999990			10 <sup>3</sup>	10 <sup>2</sup>	10 <sup>1</sup>	10 <sup>0</sup>	
13	Pre-limit-switch positive	greater than pre-limit-switch negative (MD 11)	smaller than limit switch positive (MD 14)	SI	10 <sup>7</sup>	10 <sup>6</sup>	10 <sup>5</sup>	10 <sup>4</sup>	μm
					10 <sup>3</sup>	10 <sup>2</sup>	10 <sup>1</sup>	10 <sup>0</sup>	
14	Limit switch positive	greater than pre-limit-switch positive (MD 13)	1 μm +79 999999	SI	10 <sup>7</sup>	10 <sup>6</sup>	10 <sup>5</sup>	10 <sup>4</sup>	μm
			10 μm +79 999990		10 <sup>3</sup>	10 <sup>2</sup>	10 <sup>1</sup>	10 <sup>0</sup>	
17	Absolute encoder adjustment	1 μm -79 999999	1 μm +79 999999	SI	10 <sup>7</sup>	10 <sup>6</sup>	10 <sup>5</sup>	10 <sup>4</sup>	μm
		10 μm -79 999990			10 <sup>3</sup>	10 <sup>2</sup>	10 <sup>1</sup>	10 <sup>0</sup>	
18	Linear- / rotary axis	0 or 1 ⇒	Linear axis	10 <sup>7</sup>	10 <sup>6</sup>	10 <sup>5</sup>	10 <sup>4</sup>	—	
		2	79 999999	10 <sup>3</sup>	10 <sup>2</sup>	10 <sup>1</sup>	10 <sup>0</sup>		

**Machine data which becomes active only after a RESET, is marked with a gray background.**

MD-No.	Name	Lower Limit	Upper Limit	Format in BCD				Unit
19	Pulse evaluation before the decimal point	0	9	0	0	0	0	—
				0	0	0	10 <sup>0</sup>	
20	Pulse evaluation after the decimal point	0	99 999999	10 <sup>-1</sup>	10 <sup>-2</sup>	10 <sup>-3</sup>	10 <sup>-4</sup>	—
				10 <sup>-5</sup>	10 <sup>-6</sup>	10 <sup>-7</sup>	10 <sup>-8</sup>	
21	Absolute encoder parameter	X=0 X=1 X=2 X=3	BINARY-Code without parity bit BINARY-Code with parity bit GRAY-Code without parity bit GRAY-Code with parity bit	0	0	0	0	—
				0	0	0	X	
30	PEH positioning time-out	0	9 999	0	0	0	0	ms
				10 <sup>3</sup>	10 <sup>2</sup>	10 <sup>1</sup>	10 <sup>0</sup>	
32	Clamping tolerance	0	1 µm 65 535 10 µm 655 350 100 µm 6553 500	0	10 <sup>6</sup>	10 <sup>5</sup>	10 <sup>4</sup>	µm
			10 <sup>3</sup>	10 <sup>2</sup>	10 <sup>1</sup>	10 <sup>0</sup>		
33	PEH: Positioning tolerance	0	1 µm 65 535 10 µm 655 350 100 µm 6553 500	0	10 <sup>6</sup>	10 <sup>5</sup>	10 <sup>4</sup>	µm
			10 <sup>3</sup>	10 <sup>2</sup>	10 <sup>1</sup>	10 <sup>0</sup>		
34	Travel difference monitor	0	79 999999	10 <sup>7</sup>	10 <sup>6</sup>	10 <sup>5</sup>	10 <sup>4</sup>	—
				10 <sup>3</sup>	10 <sup>2</sup>	10 <sup>1</sup>	10 <sup>0</sup>	
40	Simulation	X=0 X=1	no simulation	0	0	0	0	—
			Simulation	0	0	0	X	
41	Masking of check routines	Cable break check Voltage check No multiple evaluation of actual value for encoders	1 2 4	0	0	10 <sup>5</sup>	10 <sup>4</sup>	—
			10 <sup>3</sup>	10 <sup>2</sup>	10 <sup>1</sup>	10 <sup>0</sup>		
42	Reduction speed 1	≥MD43	99	0	0	0	0	—
				0	0	10 <sup>1</sup>	10 <sup>0</sup>	
43	Reduction speed 2	≥MD44	≤MD42	0	0	0	0	—
				0	0	10 <sup>1</sup>	10 <sup>0</sup>	
44	Reduction speed 3	1	≤MD43	0	0	0	0	—
				0	0	10 <sup>1</sup>	10 <sup>0</sup>	
45	Travel difference 1	≥MD46	1 µm 79 999999 10 µm 79 999990 100 µm 79 999900	10 <sup>7</sup>	10 <sup>6</sup>	10 <sup>5</sup>	10 <sup>4</sup>	µm
			10 <sup>3</sup>	10 <sup>2</sup>	10 <sup>1</sup>	10 <sup>0</sup>		
46	Travel difference 2	≥MD47	≤MD45	10 <sup>7</sup>	10 <sup>6</sup>	10 <sup>5</sup>	10 <sup>4</sup>	µm
				10 <sup>3</sup>	10 <sup>2</sup>	10 <sup>1</sup>	10 <sup>0</sup>	
47	Travel difference 3	≥MD48	≤MD46	10 <sup>7</sup>	10 <sup>6</sup>	10 <sup>5</sup>	10 <sup>4</sup>	µm
				10 <sup>3</sup>	10 <sup>2</sup>	10 <sup>1</sup>	10 <sup>0</sup>	
48	Travel difference 4	0	≤MD47	10 <sup>7</sup>	10 <sup>6</sup>	10 <sup>5</sup>	10 <sup>4</sup>	µm
				10 <sup>3</sup>	10 <sup>2</sup>	10 <sup>1</sup>	10 <sup>0</sup>	
49	Basic resolution	X=1 X=2 X=3	1 µm 10 µm 100 µm	0	0	0	0	—
			0	0	0	X		

Machine data which becomes active only after a RESET, is marked with a gray background.

### 3.4 WF 725 B: Closed Loop with Parallel Absolute Encoders

MD-No.	Name	Lower Limit	Upper Limit	Format in BCD				Unit		
1	Acceleration	1 µm	1	1 µm	20 000	0	0	10 <sup>5</sup>	10 <sup>4</sup>	mm/s <sup>2</sup>
		10 µm	10	10 µm	200 000	10 <sup>3</sup>	10 <sup>2</sup>	10 <sup>1</sup>	10 <sup>0</sup>	
		100 µm	100	100 µm	200 000					
2	Deceleration	1 µm	1	1 µm	20 000	0	0	10 <sup>5</sup>	10 <sup>4</sup>	mm/s <sup>2</sup>
		10 µm	10	10 µm	200 000	10 <sup>3</sup>	10 <sup>2</sup>	10 <sup>1</sup>	10 <sup>0</sup>	
		100 µm	100	100 µm	200 000					
3	Maximum feed rate	1 µm	10	1 µm	3 000 000	10 <sup>7</sup>	10 <sup>6</sup>	10 <sup>5</sup>	10 <sup>4</sup>	mm
		10 µm	10	10 µm	30 000 000	10 <sup>3</sup>	10 <sup>2</sup>	10 <sup>1</sup>	10 <sup>0</sup>	100 min
		100 µm	100	100 µm	30 000 000					
4	Type of control and encoder	X=2			0	0	0	0	—	
					0	0	0	X		
5	Number of steps Absolute encoder	0		16 777 215		10 <sup>7</sup>	10 <sup>6</sup>	10 <sup>5</sup>	10 <sup>4</sup>	—
						10 <sup>3</sup>	10 <sup>2</sup>	10 <sup>1</sup>	10 <sup>0</sup>	
6	Assignment of trav.direction to command value		Voltage with positive movement	Count direction of the act. value		0	0	0	0	—
		X=0 X=1	+ -	+ +		0	0	0	X	
7	Masked range of Absolute encoder	0		79 999999		10 <sup>7</sup>	10 <sup>6</sup>	10 <sup>5</sup>	10 <sup>4</sup>	—
						10 <sup>3</sup>	10 <sup>2</sup>	10 <sup>1</sup>	10 <sup>0</sup>	
8	Type of output M-Function	time controlled:	4	time controll.:	65 535	0	0	0	10 <sup>4</sup>	ms
		strobe controlled:	0	strobe controlled:	3	10 <sup>3</sup>	10 <sup>2</sup>	10 <sup>1</sup>	10 <sup>0</sup>	
9	Time of output M-Function	X=1	during positioning			0	0	0	0	—
		X=2 X=3	before positioning after positioning			0	0	0	X	
10	Fast outputs	O <sub>x</sub> =0	output without function			0	0	O <sub>6</sub>	O <sub>5</sub>	—
		O <sub>x</sub> =1	Position reached and stop							
		O <sub>x</sub> =2	traversing direction +							
O <sub>x</sub> =3	traversing direction -			O <sub>4</sub>	O <sub>3</sub>	O <sub>2</sub>	O <sub>1</sub>			
O <sub>x</sub> =4	reserve									
O <sub>x</sub> =5	reserve									
O <sub>x</sub> =6	reserve									
O <sub>x</sub> =7	reserve									
O <sub>x</sub> =8	reserve									
O <sub>x</sub> =9	reserve									
11	Pre-limit-switch negative	greater than limit switch negative (MD 12)	smaller than pre-limit-switch positive (MD 13)	SI	10 <sup>7</sup>	10 <sup>6</sup>	10 <sup>5</sup>	10 <sup>4</sup>	µm	
					10 <sup>3</sup>	10 <sup>2</sup>	10 <sup>1</sup>	10 <sup>0</sup>		
12	Limit switch negative	1 µm -79 999999	smaller than pre-limit-switch negative (MD 11)	SI	10 <sup>7</sup>	10 <sup>6</sup>	10 <sup>5</sup>	10 <sup>4</sup>	µm	
		10 µm -79 999990 100 µm -79 999900				10 <sup>3</sup>	10 <sup>2</sup>	10 <sup>1</sup>		10 <sup>0</sup>
13	Pre-limit-switch positive	greater than pre-limit-switch negative (MD 11)	greater than pre-limit-switch positive (MD 14)	SI	10 <sup>7</sup>	10 <sup>6</sup>	10 <sup>5</sup>	10 <sup>4</sup>	µm	
					10 <sup>3</sup>	10 <sup>2</sup>	10 <sup>1</sup>	10 <sup>0</sup>		
14	Limit switch positive	greater than pre-limit-switch negative (MD 13)	1 µm +79 999999 10 µm +79 999990 100 µm +79 999900	SI	10 <sup>7</sup>	10 <sup>6</sup>	10 <sup>5</sup>	10 <sup>4</sup>	µm	
					10 <sup>3</sup>	10 <sup>2</sup>	10 <sup>1</sup>	10 <sup>0</sup>		

**Machine data which becomes active only after a RESET, is marked with a gray background.**

MD- No.	Name	Lower Limit	Upper Limit	Format in BCD				Unit			
17	Absolute encoder adjustment	1 $\mu\text{m}$	-79 999999	1 $\mu\text{m}$	+79 999999	SI	$10^7$	$10^6$	$10^5$	$10^4$	$\mu\text{m}$
		10 $\mu\text{m}$	-79 999990	10 $\mu\text{m}$	+79 999990		$10^3$	$10^2$	$10^1$	$10^0$	
18	Linear- / rotary axis	0 or 1 $\Rightarrow$ Linear axis					$10^7$	$10^6$	$10^5$	$10^4$	—
		2		79 999999			$10^3$	$10^2$	$10^1$	$10^0$	
19	Pulse evaluation before the decimal point	0		9			0	0	0	0	—
							0	0	0	$10^0$	
20	Pulse evaluation after the decimal point	0		99 999999			$10^{-1}$	$10^{-2}$	$10^{-3}$	$10^{-4}$	—
							$10^{-5}$	$10^{-6}$	$10^{-7}$	$10^{-8}$	
21	Absolute encoder parameter	X=0	BINARY-Code without parity bit				0	0	0	0	—
		X=1	BINARY-Code with parity bit				0	0	0	X	
22	$K_V$ -Factor	20		900			0	0	0	0	m/min
							0	$10^2$	$10^1$	$10^0$	100 mm
23	Maximum command value voltage	1000		10000			0	0	0	$10^4$	mV
							$10^3$	$10^2$	$10^1$	$10^0$	
24	Maximum following error dynamic	0	1 $\mu\text{m}$	65 535			0	$10^6$	$10^5$	$10^4$	$\mu\text{m}$
			10 $\mu\text{m}$	655 350			$10^3$	$10^2$	$10^1$	$10^0$	
25	Maximum following error in standstill	0	1 $\mu\text{m}$	65 535			0	$10^6$	$10^5$	$10^4$	$\mu\text{m}$
			10 $\mu\text{m}$	655 350			$10^3$	$10^2$	$10^1$	$10^0$	
26	Minimum following error dynamic	0	1 $\mu\text{m}$	65 535			0	$10^6$	$10^5$	$10^4$	$\mu\text{m}$
			10 $\mu\text{m}$	655 350			$10^3$	$10^2$	$10^1$	$10^0$	
32	Clamping tolerance	0		9 999			0	0	0	0	ms
							$10^3$	$10^2$	$10^1$	$10^0$	
30	PEH positioning timeout	0	1 $\mu\text{m}$	65 535			0	$10^6$	$10^5$	$10^4$	$\mu\text{m}$
			10 $\mu\text{m}$	655 350			$10^3$	$10^2$	$10^1$	$10^0$	
33	PEH: Positioning tolerance	0	1 $\mu\text{m}$	65 535			0	$10^6$	$10^5$	$10^4$	$\mu\text{m}$
			10 $\mu\text{m}$	655 350			$10^3$	$10^2$	$10^1$	$10^0$	
34	Travel difference monitor	0		79 999999			$10^7$	$10^6$	$10^5$	$10^4$	—
							$10^3$	$10^2$	$10^1$	$10^0$	
35	Drift-compensation	1 $\mu\text{m}$	-255	1 $\mu\text{m}$	+255	SI	0	0	0	$10^4$	$\mu\text{m}$
		10 $\mu\text{m}$	-2550	10 $\mu\text{m}$	+2550		$10^3$	$10^2$	$10^1$	$10^0$	

Machine data which becomes active only after a RESET, is marked with a gray background.

MD- No.	Name	Lower Limit	Upper Limit	Format in BCD				Unit	
36	Acceleration correction	not active	0	0					—
		Step 1	32 769	8001	0	0	0	10 <sup>4</sup>	
		Step 2	32 770	8002	10 <sup>3</sup>	10 <sup>2</sup>	10 <sup>1</sup>	10 <sup>0</sup>	
		Step 14	32 782	800E					
Step 15	32 783	800F							
40	Simulation	X=0	no simulation		0	0	0	0	—
		X=1	simulation		0	0	0	X	
41	Masking of check routines	Cable break check		1	0	0	10 <sup>5</sup>	10 <sup>4</sup>	—
		Voltage check		2					
		Pulse check		4	10 <sup>3</sup>	10 <sup>2</sup>	10 <sup>1</sup>	10 <sup>0</sup>	
		Zero marker check							
49	Basic resolution	X=1	1 µm		0	0	0	0	—
		X=2	10 µm						
		X=3	100 µm		0	0	0	X	

**Machine data which becomes active only after a RESET, is marked with a gray background.**

### 3.5 WF 726 A/C: Open Loop with Incremental Encoders

MD-No.	Name	Lower Limit	Upper Limit	Format in BCD				Unit		
1	Acceleration encoder for Voltage increment	0	65 535	0	0	0	10 <sup>4</sup>	mV/s <sup>2</sup>		
				10 <sup>3</sup>	10 <sup>2</sup>	10 <sup>1</sup>	10 <sup>0</sup>			
2	Acceleration encoder for Voltage decrement	0	65 535	0	0	0	10 <sup>4</sup>	mV/s <sup>2</sup>		
				10 <sup>3</sup>	10 <sup>2</sup>	10 <sup>1</sup>	10 <sup>0</sup>			
4	Type of control and encoder	X=3		0	0	0	0	—		
				0	0	0	X			
6	Assignment of trav. direction to command value		Voltage with positive movement	Count direction of the act. value					—	
		X=0	+	+	0	0	0	0		
		X=1	-	+	0	0	0	X		
		X=2	+	-	0	0	0	X		
7	Reference point approach direction	X=1	Reference point is the zero mark to the right of the deceleration cam			0	0	0	0	—
		X=2	Reference point is the zero mark to the left of the deceleration cam			0	0	0	X	
8	Type of output M-Function	time controlled: 4	time controll.:65 535	0	0	0	10 <sup>4</sup>	ms		
		strobe controlled: 0	strobe controlled: 3	10 <sup>3</sup>	10 <sup>2</sup>	10 <sup>1</sup>	10 <sup>0</sup>			
9	Time of output M-Function	X=1	during positioning before positioning	0	0	0	0	—		
		X=2		0	0	0	X			
10	Fast outputs	O <sub>x</sub> =0	Output without function					—		
		O <sub>x</sub> =1		Position reached and stop	0	0	O <sub>6</sub>		O <sub>5</sub>	
		O <sub>x</sub> =2	traversing direction +	O <sub>4</sub>	0	0	0			
		O <sub>x</sub> =3	traversing direction -	O <sub>1</sub> : enter 0 cut off point A						
		O <sub>x</sub> =4	reserve	O <sub>2</sub> : enter 0 cut off point B						
		O <sub>x</sub> =5	reserve	O <sub>3</sub> : enter 0 cut off point C						
		O <sub>x</sub> =6	reserve							
		O <sub>x</sub> =7	reserve							
		O <sub>x</sub> =8	reserve							
		O <sub>x</sub> =9	reserve							
11	Pre-limit-switch negative	greater than limit switch negative (MD 12)	smaller than pre-limit-switch positive (MD 13)	SI	10 <sup>7</sup>	10 <sup>6</sup>	10 <sup>5</sup>	10 <sup>4</sup>	μm	
					10 <sup>3</sup>	10 <sup>2</sup>	10 <sup>1</sup>	10 <sup>0</sup>		
12	Limit switch negative	1 μm -79 999999	smaller than pre-limit-switch negative (MD 11)	SI	10 <sup>7</sup>	10 <sup>6</sup>	10 <sup>5</sup>	10 <sup>4</sup>	μm	
		10 μm -79 999990			10 <sup>3</sup>	10 <sup>2</sup>	10 <sup>1</sup>	10 <sup>0</sup>		
13	Pre-limit-switch positive	greater than pre-limit-switch negative (MD 11)	greater than pre-limit-switch positive (MD 14)	SI	10 <sup>7</sup>	10 <sup>6</sup>	10 <sup>5</sup>	10 <sup>4</sup>	μm	
					10 <sup>3</sup>	10 <sup>2</sup>	10 <sup>1</sup>	10 <sup>0</sup>		
14	Limit switch positive	greater than pre-limit-switch positive (MD 13)	1 μm +79 999999	SI	10 <sup>7</sup>	10 <sup>6</sup>	10 <sup>5</sup>	10 <sup>4</sup>	μm	
			10 μm +79 999990		10 <sup>3</sup>	10 <sup>2</sup>	10 <sup>1</sup>	10 <sup>0</sup>		

**Machine data which becomes active only after a RESET, is marked with a gray background.**



MD-No.	Name	Lower Limit	Upper Limit	Format in BCD				Unit			
15	Fast inputs	$I_x=0$ $I_x=1$ $I_x=2$ $I_x=3$ $I_x=4$ $I_x=5$ $I_x=6$ $I_x=7$ $I_x=8$ $I_x=9$	Input without function Deceleration cam over S5 bit Dec. cam over $I_1, I_2$ and/or $I_3$ Input without function Input without function reserve reserve Input without function Input without function reserve	0	0	$I_6$	$I_5$	—			
				$I_4$	$I_3$	$I_2$	$I_1$				
				The fast inputs for the deceleration cam cannot be programmed on other inputs							
16	Reference point coordinate	1 $\mu\text{m}$	-79 999999	1 $\mu\text{m}$	+79 999999	SI	$10^7$	$10^6$	$10^5$	$10^4$	$\mu\text{m}$
		10 $\mu\text{m}$	-79 999990	10 $\mu\text{m}$	+79 999990		$10^3$	$10^2$	$10^1$	$10^0$	
17	Zero marker shift	1 $\mu\text{m}$	-65 535	1 $\mu\text{m}$	+65 535	SI	0	$10^6$	$10^5$	$10^4$	$\mu\text{m}$
		10 $\mu\text{m}$	-655 350	10 $\mu\text{m}$	+655 350		$10^3$	$10^2$	$10^1$	$10^0$	
18	Linear- / rotary axis	0 or 1 $\Rightarrow$ Linear axis		79 999999			$10^7$	$10^6$	$10^5$	$10^4$	—
		2 Rotary axis					$10^3$	$10^2$	$10^1$	$10^0$	
19	Pulse evaluation before the decimal point	0		9			0	0	0	0	—
							0	0	0	$10^0$	
20	Pulse evaluation after the decimal point	0		99 999999			$10^{-1}$	$10^{-2}$	$10^{-3}$	$10^{-4}$	—
							$10^{-5}$	$10^{-6}$	$10^{-7}$	$10^{-8}$	
21	Pulse multiplication	X=1	Enc. pulses multiplied with	1	Evaluation of the actual value		0	0	0	0	—
		X=2		2 =			0	0	0	X	
28	Coordinate of actual value	1 $\mu\text{m}$	-79 999999	1 $\mu\text{m}$	+79 999999	SI	$10^7$	$10^6$	$10^5$	$10^4$	$\mu\text{m}$
		10 $\mu\text{m}$	-79 999990	10 $\mu\text{m}$	+79 999990		$10^3$	$10^2$	$10^1$	$10^0$	
30	PEH positioning time out	0		9 999			0	0	0	0	ms
							$10^3$	$10^2$	$10^1$	$10^0$	
31	Backlash compensation	1 $\mu\text{m}$	65 535	1 $\mu\text{m}$	65 535		0	$10^6$	$10^5$	$10^4$	$\mu\text{m}$
		10 $\mu\text{m}$	655 350	10 $\mu\text{m}$	655 350		$10^3$	$10^2$	$10^1$	$10^0$	
32	Clamping tolerance	1 $\mu\text{m}$	65 535	1 $\mu\text{m}$	65 535		0	$10^6$	$10^5$	$10^4$	$\mu\text{m}$
		10 $\mu\text{m}$	655 350	10 $\mu\text{m}$	655 350		$10^3$	$10^2$	$10^1$	$10^0$	
33	PEH: Positioning tolerance	1 $\mu\text{m}$	65 535	1 $\mu\text{m}$	65 535		0	$10^6$	$10^5$	$10^4$	$\mu\text{m}$
		10 $\mu\text{m}$	655 350	10 $\mu\text{m}$	655 350		$10^3$	$10^2$	$10^1$	$10^0$	
34	Number of pulses/ Encoder revolut.	100		79 999999			$10^7$	$10^6$	$10^5$	$10^4$	—
							$10^3$	$10^2$	$10^1$	$10^0$	
40	Simulation	X=0	no simulation				0	0	0	0	—
		X=1	simulation				0	0	0	X	
41	Masking of check routines	Cable break check		1			0	0	$10^5$	$10^4$	—
		Voltage check		2			$10^3$	$10^2$	$10^1$	$10^0$	
		Pulse check		65 536							
		Zero marker check		131 072							

**Machine data which becomes active only after a RESET, is marked with a gray background.**

MD- No.	Name	Lower Limit	Upper Limit	Format in BCD				Unit
42	Reduction speed 1	≥MD43	99	0	0	0	0	—
				0	0	10 <sup>1</sup>	10 <sup>0</sup>	
43	Reduction speed 2	≥MD44	≤MD42	0	0	0	0	—
				0	0	10 <sup>1</sup>	10 <sup>0</sup>	
44	Reduction speed 3	1	≤MD43	0	0	0	0	—
				0	0	10 <sup>1</sup>	10 <sup>0</sup>	
45	Travel difference 1	≥MD46	1 μm 79 999999 10 μm 79 999990 100 μm 79 999900	10 <sup>7</sup>	10 <sup>6</sup>	10 <sup>5</sup>	10 <sup>4</sup>	μm
				10 <sup>3</sup>	10 <sup>2</sup>	10 <sup>1</sup>	10 <sup>0</sup>	
46	Travel difference 2	≥MD47	≤MD45	10 <sup>7</sup>	10 <sup>6</sup>	10 <sup>5</sup>	10 <sup>4</sup>	μm
				10 <sup>3</sup>	10 <sup>2</sup>	10 <sup>1</sup>	10 <sup>0</sup>	
47	Travel difference 3	≥MD48	≤MD46	10 <sup>7</sup>	10 <sup>6</sup>	10 <sup>5</sup>	10 <sup>4</sup>	μm
				10 <sup>3</sup>	10 <sup>2</sup>	10 <sup>1</sup>	10 <sup>0</sup>	
48	Travel difference 4	0	≤MD47	10 <sup>7</sup>	10 <sup>6</sup>	10 <sup>5</sup>	10 <sup>4</sup>	μm
				10 <sup>3</sup>	10 <sup>2</sup>	10 <sup>1</sup>	10 <sup>0</sup>	
49	Basic resolution	X=1 X=2 X=3	1 μm 10 μm 100 μm	0	0	0	0	—
				0	0	0	X	

Machine data which becomes active only after a RESET, is marked with a gray background.

### 3.6 WF 726 A/C: Closed Loop with Incremental Encoders

MD-No.	Name	Lower Limit	Upper Limit	Format in BCD				Unit			
1	Acceleration	1 µm	1	1 µm	20 000	0	0	10 <sup>5</sup>	10 <sup>4</sup>	mm/s <sup>2</sup>	
		10 µm	10	10 µm	200 000	10 <sup>3</sup>	10 <sup>2</sup>	10 <sup>1</sup>	10 <sup>0</sup>		
		100 µm	100	100 µm	200 000						
2	Deceleration	1 µm	1	1 µm	20 000	0	0	10 <sup>5</sup>	10 <sup>4</sup>	mm/s <sup>2</sup>	
		10 µm	10	10 µm	200 000	10 <sup>3</sup>	10 <sup>2</sup>	10 <sup>1</sup>	10 <sup>0</sup>		
		100 µm	100	100 µm	200 000						
3	Maximum feed rate	1 µm	10	1 µm	3 000 000	10 <sup>7</sup>	10 <sup>6</sup>	10 <sup>5</sup>	10 <sup>4</sup>	mm	
		10 µm	10	10 µm	30 000 000	10 <sup>3</sup>	10 <sup>2</sup>	10 <sup>1</sup>	10 <sup>0</sup>	100 min	
		100 µm	100	100 µm	30 000 000						
4	Type of control and encoder	X=1			0	0	0	0	—		
					0	0	0	X			
6	Assignment of trav. direction to command value		Voltage with positive movement.	Count direction of the actual value					—		
		X=0	+	+	0	0	0	0			
		X=1	-	+	0	0	0	X			
		X=2	+	-							
X=3	-	-									
7	Reference point approach direction	X=1	Reference point is the zero mark to the right of deceleration cam			0	0	0	0	—	
		X=2	Reference point is the zero mark to the left of deceleration cam			0	0	0	X		
8	Type of output of M-Function	time controlled: 4	time controll.:65 535			0	0	0	10 <sup>4</sup>	ms	
		strobe controlled: 0	strobe controlled: 3			10 <sup>3</sup>	10 <sup>2</sup>	10 <sup>1</sup>	10 <sup>0</sup>		
9	Time of output of M-Function	X=1	during positioning			0	0	0	0	—	
		X=2	before positioning			0	0	0	X		
X=3	after positioning										
10	Fast outputs	O <sub>x</sub> =0	output without function position reached and stop traversing direction + traversing direction - reserve reserve reserve reserve reserve reserve							—	
		O <sub>x</sub> =1									
		O <sub>x</sub> =2									
		O <sub>x</sub> =3									
O <sub>x</sub> =4					0	0	O <sub>6</sub>	O <sub>5</sub>			
O <sub>x</sub> =5					O <sub>4</sub>	O <sub>3</sub>	O <sub>2</sub>	O <sub>1</sub>			
O <sub>x</sub> =6											
O <sub>x</sub> =7											
O <sub>x</sub> =8											
O <sub>x</sub> =9											
11	Pre-limit-switch negative	greater than limit switch negative (MD 12)		smaller than pre-limit-switch positive (MD 13)	SI	10 <sup>7</sup>	10 <sup>6</sup>	10 <sup>5</sup>	10 <sup>4</sup>	µm	
						10 <sup>3</sup>	10 <sup>2</sup>	10 <sup>1</sup>	10 <sup>0</sup>		
12	Limit switch negative	1 µm -79 999999		smaller than pre-limit-switch negative (MD 11)	SI	10 <sup>7</sup>	10 <sup>6</sup>	10 <sup>5</sup>	10 <sup>4</sup>	µm	
		10 µm -79 999990					10 <sup>3</sup>	10 <sup>2</sup>	10 <sup>1</sup>		10 <sup>0</sup>
		100 µm -79 999900									
13	Pre-limit-switch positive	greater than pre-limit-switch negative (MD 11)		smaller than limit switch positive (MD 14)	SI	10 <sup>7</sup>	10 <sup>6</sup>	10 <sup>5</sup>	10 <sup>4</sup>	µm	
						10 <sup>3</sup>	10 <sup>2</sup>	10 <sup>1</sup>	10 <sup>0</sup>		
14	Limit switch positive	greater than pre-limit-switch positive (MD 13)		1 µm +79 999999	SI	10 <sup>7</sup>	10 <sup>6</sup>	10 <sup>5</sup>	10 <sup>4</sup>	µm	
				10 µm +79 999990			10 <sup>3</sup>	10 <sup>2</sup>	10 <sup>1</sup>		10 <sup>0</sup>
		100 µm +79 999900									

**Machine data which become sactive only after a RESET, is marked with a gray background.**

MD-No.	Name	Lower Limit	Upper Limit	Format in BCD				Unit			
15	Fast inputs on connector X7	I <sub>x</sub> =0 I <sub>x</sub> =1 I <sub>x</sub> =2 I <sub>x</sub> =3 I <sub>x</sub> =4 I <sub>x</sub> =5 I <sub>x</sub> =6 I <sub>x</sub> =7 I <sub>x</sub> =8 I <sub>x</sub> =9	Input without function Deceleration cam over S5 bit Dec. cam over I <sub>1</sub> , I <sub>2</sub> and/or I <sub>3</sub> Flying setting of actual value External read-in enable reserve reserve Alternative Start to Start from S5 Start only if also Start from S5 reserve	0	0	I <sub>6</sub>	I <sub>5</sub>	—			
				I <sub>4</sub>	I <sub>3</sub>	I <sub>2</sub>	I <sub>1</sub>				
				The fast inputs for the deceleration cam cannot be programmed on other inputs							
16	Reference point coordinate	1 μm	-79 999999	1 μm	+79 999999	SI	10 <sup>7</sup>	10 <sup>6</sup>	10 <sup>5</sup>	10 <sup>4</sup>	μm
		10 μm	-79 999990	10 μm	+79 999990						
		100 μm	-79 999900	100 μm	+79 999900		10 <sup>3</sup>	10 <sup>2</sup>	10 <sup>1</sup>	10 <sup>0</sup>	
17	Zero marker shift	1 μm	-65 535	1 μm	+65 535	SI	0	10 <sup>6</sup>	10 <sup>5</sup>	10 <sup>4</sup>	μm
		10 μm	-655 350	10 μm	+655 350						
		100 μm	-6553 500	100 μm	+6553 500		10 <sup>3</sup>	10 <sup>2</sup>	10 <sup>1</sup>	10 <sup>0</sup>	
18	Linear- / rotary axis	0 or 1 ⇒ Linear axis		2 ⇒ Rotary axis		10 <sup>7</sup>	10 <sup>6</sup>	10 <sup>5</sup>	10 <sup>4</sup>	—	
				79 999999		10 <sup>3</sup>	10 <sup>2</sup>	10 <sup>1</sup>	10 <sup>0</sup>		
19	Pulse evaluation before the decimal point	0		9		0	0	0	0	—	
						0	0	0	10 <sup>0</sup>		
20	Pulse evaluation after the decimal point	0		99 999999		10 <sup>-1</sup>	10 <sup>-2</sup>	10 <sup>-3</sup>	10 <sup>-4</sup>	—	
						10 <sup>-5</sup>	10 <sup>-6</sup>	10 <sup>-7</sup>	10 <sup>-8</sup>		
21	Pulse multiplication	X=1	Enc. pulses multiplied with	1	2 =	Evaluation of the actual value	0	0	0	0	—
		X=2					0	0	0	X	
22	K <sub>v</sub> -Factor	20		900		0	0	0	0	m/min	
						0	10 <sup>2</sup>	10 <sup>1</sup>	10 <sup>0</sup>	100 mm	
23	Maximum command value voltage	1000		10000		0	0	0	10 <sup>4</sup>	mV	
						10 <sup>3</sup>	10 <sup>2</sup>	10 <sup>1</sup>	10 <sup>0</sup>		
24	Maximum following error dynamic	1 μm	65 535	1 μm	65 535	0	10 <sup>6</sup>	10 <sup>5</sup>	10 <sup>4</sup>	μm	
		10 μm	655 350	10 μm	655 350						
		100 μm	6553 500	100 μm	6553 500	10 <sup>3</sup>	10 <sup>2</sup>	10 <sup>1</sup>	10 <sup>0</sup>		
25	Maximum following error in standstill	1 μm	65 535	1 μm	65 535	0	10 <sup>6</sup>	10 <sup>5</sup>	10 <sup>4</sup>	μm	
		10 μm	655 350	10 μm	655 350						
		100 μm	6553 500	100 μm	6553 500	10 <sup>3</sup>	10 <sup>2</sup>	10 <sup>1</sup>	10 <sup>0</sup>		
26	Minimum following error dynamic	1 μm	65 535	1 μm	65 535	0	10 <sup>6</sup>	10 <sup>5</sup>	10 <sup>4</sup>	μm	
		10 μm	655 350	10 μm	655 350						
		100 μm	6553 500	100 μm	6553 500	10 <sup>3</sup>	10 <sup>2</sup>	10 <sup>1</sup>	10 <sup>0</sup>		
28	Coordinate of actual value	1 μm	-79 999999	1 μm	+79 999999	SI	10 <sup>7</sup>	10 <sup>6</sup>	10 <sup>5</sup>	10 <sup>4</sup>	μm
		10 μm	-79 999990	10 μm	+79 999990						
		100 μm	-79 999900	100 μm	+79 999900		10 <sup>3</sup>	10 <sup>2</sup>	10 <sup>1</sup>	10 <sup>0</sup>	
29	Split-drive Tolerance	1 μm	65 535	1 μm	65 535	0	10 <sup>6</sup>	10 <sup>5</sup>	10 <sup>4</sup>	μm	
		10 μm	655 350	10 μm	655 350						
		100 μm	6553 500	100 μm	6553 500	10 <sup>3</sup>	10 <sup>2</sup>	10 <sup>1</sup>	10 <sup>0</sup>		
30	PEH positioning time-out	0		9 999		0	0	0	0	ms	
						10 <sup>3</sup>	10 <sup>2</sup>	10 <sup>1</sup>	10 <sup>0</sup>		

**Machine data which becomes active only after a RESET, is marked with a gray background.**

MD-No.	Name	Lower Limit	Upper Limit	Format in BCD				Unit			
31	Backlash compensation	0	1 µm	65 535	0	10 <sup>6</sup>	10 <sup>5</sup>	10 <sup>4</sup>	µm		
			10 µm	655 350	10 <sup>3</sup>	10 <sup>2</sup>	10 <sup>1</sup>	10 <sup>0</sup>			
32	Clamping tolerance	0	1 µm	65 535	0	10 <sup>6</sup>	10 <sup>5</sup>	10 <sup>4</sup>	µm		
			10 µm	655 350	10 <sup>3</sup>	10 <sup>2</sup>	10 <sup>1</sup>	10 <sup>0</sup>			
33	PEH: Positioning tolerance	0	1 µm	65 535	0	10 <sup>6</sup>	10 <sup>5</sup>	10 <sup>4</sup>	µm		
			10 µm	655 350	10 <sup>3</sup>	10 <sup>2</sup>	10 <sup>1</sup>	10 <sup>0</sup>			
34	Number of pulses / encoder revolution	100	79 999999		10 <sup>7</sup>	10 <sup>6</sup>	10 <sup>5</sup>	10 <sup>4</sup>	—		
					10 <sup>3</sup>	10 <sup>2</sup>	10 <sup>1</sup>	10 <sup>0</sup>			
35	Drift compensation	1 µm	-255	1 µm	+255	SI	0	0	10 <sup>4</sup>	µm	
		10 µm	-2550	10 µm	+2550	10 <sup>3</sup>	10 <sup>2</sup>	10 <sup>1</sup>	10 <sup>0</sup>		
36	Acceleration correction	not active	BCD: 0		DUAL: 0		0	0	0	10 <sup>4</sup>	—
		1 step	32 769	8001	10 <sup>3</sup>	10 <sup>2</sup>	10 <sup>1</sup>	10 <sup>0</sup>			
38	Jerk limit for acceleration	1 µm	0	1 µm	1 950	0	0	10 <sup>5</sup>	10 <sup>4</sup>	mm	
		10 µm	0	10 µm	19 500	10 <sup>3</sup>	10 <sup>2</sup>	10 <sup>1</sup>	10 <sup>0</sup>	s <sup>3</sup>	
39	Jerk limit for deceleration	1 µm	0	1 µm	1 950	0	0	10 <sup>5</sup>	10 <sup>4</sup>	mm	
		10 µm	0	10 µm	19 500	10 <sup>3</sup>	10 <sup>2</sup>	10 <sup>1</sup>	10 <sup>0</sup>	s <sup>3</sup>	
40	Simulation	X=0	no simulation			0	0	0	0	—	
		X=1	simulation			0	0	0	X		
41	Masking of check routines	Cable break check			1	0	0	10 <sup>5</sup>	10 <sup>4</sup>	—	
		Voltage check			2	10 <sup>3</sup>	10 <sup>2</sup>	10 <sup>1</sup>	10 <sup>0</sup>		
42	Roll feed	X=0	no roll feed			0	0	0	0	—	
		X=1	roll feed			0	0	0	X		
46	Approx. positioning tolerance 1	0	1 µm	65 535	0	10 <sup>6</sup>	10 <sup>5</sup>	10 <sup>4</sup>	µm		
			10 µm	655 350	10 <sup>3</sup>	10 <sup>2</sup>	10 <sup>1</sup>	10 <sup>0</sup>			
47	Approx. positioning tolerance 2	0	1 µm	65 535	0	10 <sup>6</sup>	10 <sup>5</sup>	10 <sup>4</sup>	µm		
			10 µm	655 350	10 <sup>3</sup>	10 <sup>2</sup>	10 <sup>1</sup>	10 <sup>0</sup>			
49	Basic resolution	X=1	1 µm		0	0	0	0	—		
		X=2	10 µm		0	0	0	X			
49	Basic resolution	X=3	100 µm		0	0	0	X	—		
				0	0	0	X				

**Machine data which becomes active only after a RESET, is marked with a gray background.**

### 3.7 WF 726 B: Open Loop with Parallel Absolute Encoders

MD-No.	Name	Lower Limit	Upper Limit	Format in BCD				Unit	
1	Acceleration encoder for Voltage increment	0	65 535	0	0	0	10 <sup>4</sup>	mV/s <sup>2</sup>	
				10 <sup>3</sup>	10 <sup>2</sup>	10 <sup>1</sup>	10 <sup>0</sup>		
2	Acceleration encoder for Voltage decrement	0	65 535	0	0	0	10 <sup>4</sup>	mV/s <sup>2</sup>	
				10 <sup>3</sup>	10 <sup>2</sup>	10 <sup>1</sup>	10 <sup>0</sup>		
4	Type of control and encoder	X=4		0	0	0	0	—	
				0	0	0	X		
5	Number of steps of the absolute encoder	0	16 777 215	10 <sup>7</sup>	10 <sup>6</sup>	10 <sup>5</sup>	10 <sup>4</sup>	—	
				10 <sup>3</sup>	10 <sup>2</sup>	10 <sup>1</sup>	10 <sup>0</sup>		
6	Assignment of trav.direction to command value		Voltage with positive movement	Count direction of the act. value	0	0	0	0	—
		X=0 X=1	+	+	0	0	0	X	
7	Masked range of Absolute encoder	0	79 999999	10 <sup>7</sup>	10 <sup>6</sup>	10 <sup>5</sup>	10 <sup>4</sup>	—	
				10 <sup>3</sup>	10 <sup>2</sup>	10 <sup>1</sup>	10 <sup>0</sup>		
8	Type of output M-Function	time controlled: 4	time controll.:65 535	0	0	0	10 <sup>4</sup>	ms	
		strobe controlled: 0	strobe controlled: 3	10 <sup>3</sup>	10 <sup>2</sup>	10 <sup>1</sup>	10 <sup>0</sup>		
9	Time of output M-Function	X=1	during positioning before positioning after positioning	0	0	0	0	—	
		X=2 X=3		0	0	0	X		
10	Fast outputs	O <sub>x</sub> =0	Output without function Position reached and stop traversing direction + traversing direction – reserve reserve reserve reserve reserve reserve	0	0	O <sub>6</sub>	O <sub>5</sub>	—	
		O <sub>x</sub> =1 O <sub>x</sub> =2 O <sub>x</sub> =3 O <sub>x</sub> =4 O <sub>x</sub> =5 O <sub>x</sub> =6 O <sub>x</sub> =7 O <sub>x</sub> =8 O <sub>x</sub> =9		O <sub>4</sub>	0	0	0		
11	Pre-limit-switch negative	greater than limit switch negative (MD 12)	smaller than pre-limit-switch positive (MD 13)	SI	10 <sup>7</sup>	10 <sup>6</sup>	10 <sup>5</sup>	10 <sup>4</sup>	μm
					10 <sup>3</sup>	10 <sup>2</sup>	10 <sup>1</sup>	10 <sup>0</sup>	
12	Limit switch negative	1 μm –79 999999 10 μm –79 999990 100 μm –79 999900	smaller than pre-limit-switch negative (MD 11)	SI	10 <sup>7</sup>	10 <sup>6</sup>	10 <sup>5</sup>	10 <sup>4</sup>	μm
					10 <sup>3</sup>	10 <sup>2</sup>	10 <sup>1</sup>	10 <sup>0</sup>	
13	Pre-limit-switch positive	greater than pre-limit-switch negative (MD 11)	smaller than limit switch positive (MD 14)	SI	10 <sup>7</sup>	10 <sup>6</sup>	10 <sup>5</sup>	10 <sup>4</sup>	μm
					10 <sup>3</sup>	10 <sup>2</sup>	10 <sup>1</sup>	10 <sup>0</sup>	
14	Limit switch positive	greater than pre-limit-switch positive (MD 13)	1 μm +79 999999 10 μm +79 999990 100 μm +79 999900	SI	10 <sup>7</sup>	10 <sup>6</sup>	10 <sup>5</sup>	10 <sup>4</sup>	μm
					10 <sup>3</sup>	10 <sup>2</sup>	10 <sup>1</sup>	10 <sup>0</sup>	

Machine data which becomes active only after a RESET, is marked with a gray background.

MD- No.	Name	Lower Limit	Upper Limit	Format in BCD				Unit	
17	Absolute encoder adjustment	1 µm -79 999999	1 µm +79 999999	SI	10 <sup>7</sup>	10 <sup>6</sup>	10 <sup>5</sup>	10 <sup>4</sup>	µm
		10 µm -79 999990	10 µm +79 999990		10 <sup>3</sup>	10 <sup>2</sup>	10 <sup>1</sup>	10 <sup>0</sup>	
18	Linear- / rotary axis	0 or 1 ⇒	Linear axis		10 <sup>7</sup>	10 <sup>6</sup>	10 <sup>5</sup>	10 <sup>4</sup>	—
		2	79 999999		10 <sup>3</sup>	10 <sup>2</sup>	10 <sup>1</sup>	10 <sup>0</sup>	
19	Pulse evaluation before the decimal point	0	9		0	0	0	0	—
					0	0	0	10 <sup>0</sup>	
20	Pulse evaluation after the decimal point	0	99 999999		10 <sup>-1</sup>	10 <sup>-2</sup>	10 <sup>-3</sup>	10 <sup>-4</sup>	—
					10 <sup>-5</sup>	10 <sup>-6</sup>	10 <sup>-7</sup>	10 <sup>-8</sup>	
21	Absolute encoder parameter	X=0	BINARY-Code without parity bit		0	0	0	0	—
		X=1	BINARY-Code with parity bit		0	0	0	X	
30	PEH positioning time-out	0	9 999		0	0	0	0	ms
					10 <sup>3</sup>	10 <sup>2</sup>	10 <sup>1</sup>	10 <sup>0</sup>	
32	Clamping tolerance	0	1 µm 65 535		0	0	0	0	µm
			10 µm 655 350		0	0	0	X	
33	PEH Positioning tolerance	0	1 µm 65 535		0	10 <sup>6</sup>	10 <sup>5</sup>	10 <sup>4</sup>	µm
			10 µm 655 350		10 <sup>3</sup>	10 <sup>2</sup>	10 <sup>1</sup>	10 <sup>0</sup>	
34	Travel difference monitor	0	79 999999		10 <sup>7</sup>	10 <sup>6</sup>	10 <sup>5</sup>	10 <sup>4</sup>	—
					10 <sup>3</sup>	10 <sup>2</sup>	10 <sup>1</sup>	10 <sup>0</sup>	
40	Simulation	X=0	no simulation		0	10 <sup>6</sup>	10 <sup>5</sup>	10 <sup>4</sup>	—
		X=1	simulation		10 <sup>3</sup>	10 <sup>2</sup>	10 <sup>1</sup>	10 <sup>0</sup>	
41	Masking of check routines	Cable break check		1	0	0	10 <sup>5</sup>	10 <sup>4</sup>	—
		Voltage check		2	10 <sup>3</sup>	10 <sup>2</sup>	10 <sup>1</sup>	10 <sup>0</sup>	
42	Reduction speed 1	≥MD43	99		0	0	0	0	—
					0	0	10 <sup>1</sup>	10 <sup>0</sup>	
43	Reduction speed 2	≥MD44	≤MD42		0	0	0	0	—
					0	0	10 <sup>1</sup>	10 <sup>0</sup>	
44	Reduction speed 3	1	≤MD43		0	0	0	0	—
					0	0	10 <sup>1</sup>	10 <sup>0</sup>	

**Machine data which becomes active only after a RESET, is marked with a gray background.**

MD- No.	Name	Lower Limit	Upper Limit	Format in BCD				Unit
45	Travel difference 1	≥MD46	1 μm 79 999999 10 μm 79 999990 100 μm 79 999900	10 <sup>7</sup>	10 <sup>6</sup>	10 <sup>5</sup>	10 <sup>4</sup>	μm
				10 <sup>3</sup>	10 <sup>2</sup>	10 <sup>1</sup>	10 <sup>0</sup>	
46	Travel difference 2	≥MD47	≤MD45	10 <sup>7</sup>	10 <sup>6</sup>	10 <sup>5</sup>	10 <sup>4</sup>	μm
				10 <sup>3</sup>	10 <sup>2</sup>	10 <sup>1</sup>	10 <sup>0</sup>	
47	Travel difference 3	≥MD48	≤MD46	10 <sup>7</sup>	10 <sup>6</sup>	10 <sup>5</sup>	10 <sup>4</sup>	μm
				10 <sup>3</sup>	10 <sup>2</sup>	10 <sup>1</sup>	10 <sup>0</sup>	
48	Travel difference 4	0	≤MD47	10 <sup>7</sup>	10 <sup>6</sup>	10 <sup>5</sup>	10 <sup>4</sup>	μm
				10 <sup>3</sup>	10 <sup>2</sup>	10 <sup>1</sup>	10 <sup>0</sup>	
49	Basic resolution	X=1 X=2 X=3	1 μm 10 μm 100 μm	0	0	0	0	—
				0	0	0	X	

**Machine data which becomes active only after a RESET, is marked with a gray background.**



### 3.8 WF 726 B: Closed Loop with Parallel Absolute Encoders

MD-No.	Name	Lower Limit	Upper Limit	Format in BCD				Unit			
1	Acceleration	1 µm	1	1 µm	20 000	0	0	10 <sup>5</sup>	10 <sup>4</sup>	mm/s <sup>2</sup>	
		10 µm	10	10 µm	200 000	10 <sup>3</sup>	10 <sup>2</sup>	10 <sup>1</sup>	10 <sup>0</sup>		
2	Deceleration	1 µm	1	1 µm	20 000	0	0	10 <sup>5</sup>	10 <sup>4</sup>	mm/s <sup>2</sup>	
		10 µm	10	10 µm	200 000	10 <sup>3</sup>	10 <sup>2</sup>	10 <sup>1</sup>	10 <sup>0</sup>		
3	Maximum feed rate	1 µm	10	1 µm	3 000 000	10 <sup>7</sup>	10 <sup>6</sup>	10 <sup>5</sup>	10 <sup>4</sup>	mm	
		10 µm	10	10 µm	30 000 000	10 <sup>3</sup>	10 <sup>2</sup>	10 <sup>1</sup>	10 <sup>0</sup>	100 min	
4	Type of control and Encoder	X=2				0	0	0	0	—	
						0	0	0	X		
5	Number of steps Absolute encoder	0		16 777 215		10 <sup>7</sup>	10 <sup>6</sup>	10 <sup>5</sup>	10 <sup>4</sup>	—	
						10 <sup>3</sup>	10 <sup>2</sup>	10 <sup>1</sup>	10 <sup>0</sup>		
6	Assignment direction to command voltage		Voltage with positive movement	Count direction of the actual value		0	0	0	0	—	
		X=0 X=1	+ -	+ +		0	0	0	X		
7	Masked range of Absolute encoder	0		79 999999		10 <sup>7</sup>	10 <sup>6</sup>	10 <sup>5</sup>	10 <sup>4</sup>	—	
						10 <sup>3</sup>	10 <sup>2</sup>	10 <sup>1</sup>	10 <sup>0</sup>		
8	Type of output M-Function	time controlled: 4	time controll.:65 535			0	0	0	10 <sup>4</sup>	ms	
		strobe controlled: 0	strobe controlled: 3			10 <sup>3</sup>	10 <sup>2</sup>	10 <sup>1</sup>	10 <sup>0</sup>		
9	Time of output M-Function	X=1	during positioning			0	0	0	0	—	
		X=2 X=3	before positioning after positioning			0	0	0	X		
10	Fast outputs	O <sub>x</sub> =0	output without function			0	0	O <sub>6</sub>	O <sub>5</sub>	—	
		O <sub>x</sub> =1	position reached and stop								
		O <sub>x</sub> =2	traversing direction +								
		O <sub>x</sub> =3	traversing direction -								
		O <sub>x</sub> =4	reserve								
		O <sub>x</sub> =5	reserve			O <sub>4</sub>	O <sub>3</sub>	O <sub>2</sub>	A <sub>1</sub>		
		O <sub>x</sub> =6	reserve								
		O <sub>x</sub> =7	reserve								
		O <sub>x</sub> =8	reserve								
		O <sub>x</sub> =9	reserve								
11	Pre-limit-switch negative	greater than limit switch negative (MD 12)		smaller than pre-limit-switch positive (MD 13)		SI	10 <sup>7</sup>	10 <sup>6</sup>	10 <sup>5</sup>	10 <sup>4</sup>	µm
							10 <sup>3</sup>	10 <sup>2</sup>	10 <sup>1</sup>	10 <sup>0</sup>	
12	Limit switch negative	1 µm	-79 999999	smaller than pre-limit-switch negative (MD 11)		SI	10 <sup>7</sup>	10 <sup>6</sup>	10 <sup>5</sup>	10 <sup>4</sup>	µm
		10 µm	-79 999990				10 <sup>3</sup>	10 <sup>2</sup>	10 <sup>1</sup>	10 <sup>0</sup>	
13	Pre-limit-switch positive	greater than pre-limit-switch negative (MD 11)		smaller than limit switch positive (MD 14)		SI	10 <sup>7</sup>	10 <sup>6</sup>	10 <sup>5</sup>	10 <sup>4</sup>	µm
							10 <sup>3</sup>	10 <sup>2</sup>	10 <sup>1</sup>	10 <sup>0</sup>	
14	Limit switch positive	greater than pre-limit-switch positive (MD 13)		1 µm	+79 999999	SI	10 <sup>7</sup>	10 <sup>6</sup>	10 <sup>5</sup>	10 <sup>4</sup>	µm
				10 µm	+79 999990		10 <sup>3</sup>	10 <sup>2</sup>	10 <sup>1</sup>	10 <sup>0</sup>	

Machine data which becomes active only after a RESET, is marked with a gray background.

MD-No.	Name	Lower Limit	Upper Limit	Format in BCD				Unit			
15	Fast inputs	I <sub>x</sub> =0 I <sub>x</sub> =1 I <sub>x</sub> =2 I <sub>x</sub> =3 I <sub>x</sub> =4 I <sub>x</sub> =5 I <sub>x</sub> =6 I <sub>x</sub> =7 I <sub>x</sub> =8 I <sub>x</sub> =9	Input without function Input without function Input without function Input without function external read-in enable reserve reserve Alternative Start to Start from S5 Start only if also Start from S5 reserve	0	0	I <sub>6</sub>	I <sub>5</sub>	—			
				I <sub>4</sub>	I <sub>3</sub>	I <sub>2</sub>	I <sub>1</sub>				
17	Absolute encoder adjustment	1 μm	-79 999999	1 μm	+79 999999	SI	10 <sup>7</sup>	10 <sup>6</sup>	10 <sup>5</sup>	10 <sup>4</sup>	μm
		10 μm	-79 999990	10 μm	+79 999990	10 <sup>3</sup>	10 <sup>2</sup>	10 <sup>1</sup>	10 <sup>0</sup>		
18	Linear- / rotary axis	0 or 1 ⇒ Linear axis		10 <sup>7</sup>	10 <sup>6</sup>	10 <sup>5</sup>	10 <sup>4</sup>	—			
		2	79 999999	10 <sup>3</sup>	10 <sup>2</sup>	10 <sup>1</sup>	10 <sup>0</sup>				
19	Pulse evaluation before the decimal point	0	9	0	0	0	0	—			
				0	0	0	10 <sup>0</sup>				
20	Pulse evaluation after the decimal point	0	99 999999	10 <sup>-1</sup>	10 <sup>-2</sup>	10 <sup>-3</sup>	10 <sup>-4</sup>	—			
				10 <sup>-5</sup>	10 <sup>-6</sup>	10 <sup>-7</sup>	10 <sup>-8</sup>				
21	Absolute encoder parameter	X=0 X=1 X=2 X=3	BINARY-Code without parity bit BINARY-Code with parity bit GRAY-Code without parity bit GRAY-Code with parity bit	0	0	0	0	—			
				0	0	0	X				
22	K <sub>v</sub> -Factor	20	900	0	0	0	0	m/min			
				0	10 <sup>2</sup>	10 <sup>1</sup>	10 <sup>0</sup>	100 mm			
23	Maximum command value voltage	1000	10000	0	0	0	10 <sup>4</sup>	mV			
				10 <sup>3</sup>	10 <sup>2</sup>	10 <sup>1</sup>	10 <sup>0</sup>				
24	Maximum following error dynamic	0	1 μm 65 535 10 μm 655 350 100 μm 6553 500	0	10 <sup>6</sup>	10 <sup>5</sup>	10 <sup>4</sup>	μm			
				10 <sup>3</sup>	10 <sup>2</sup>	10 <sup>1</sup>	10 <sup>0</sup>				
25	Maximum following error in standstill	0	1 μm 65 535 10 μm 655 350 100 μm 6553 500	0	10 <sup>6</sup>	10 <sup>5</sup>	10 <sup>4</sup>	μm			
				10 <sup>3</sup>	10 <sup>2</sup>	10 <sup>1</sup>	10 <sup>0</sup>				
26	Minimum following error dynamic	0	1 μm 65 535 10 μm 655 350 100 μm 6553 500	0	10 <sup>6</sup>	10 <sup>5</sup>	10 <sup>4</sup>	μm			
				10 <sup>3</sup>	10 <sup>2</sup>	10 <sup>1</sup>	10 <sup>0</sup>				
27	Definition of axes with split-drive	X=0 X=3 X=5	no permanent synchronization synchronization between A+B synchronization between A+C	0	0	0	0	—			
				0	0	0	X				
29	Tolerance of split-drive	0	1 μm 65 535 10 μm 655 350 100 μm 6553 500	0	10 <sup>6</sup>	10 <sup>5</sup>	10 <sup>4</sup>	μm			
				10 <sup>3</sup>	10 <sup>2</sup>	10 <sup>1</sup>	10 <sup>0</sup>				

**Machine data which becomes active only after a RESET, is marked with a gray background.**

MD-No.	Name	Lower Limit	Upper Limit	Format in BCD				Unit	
30	PEH positioning timeout	0	9 999	0	0	0	0	ms	
				$10^3$	$10^2$	$10^1$	$10^0$		
32	Clamping tolerance	0	1 $\mu\text{m}$ 65 535	0	$10^6$	$10^5$	$10^4$	$\mu\text{m}$	
			10 $\mu\text{m}$ 655 350	$10^3$	$10^2$	$10^1$	$10^0$		
33	PEH: Positioning tolerance	0	1 $\mu\text{m}$ 65 535	0	$10^6$	$10^5$	$10^4$	$\mu\text{m}$	
			10 $\mu\text{m}$ 655 350	$10^3$	$10^2$	$10^1$	$10^0$		
34	Travel difference monitor	0	79 999999	$10^7$	$10^6$	$10^5$	$10^4$	—	
				$10^3$	$10^2$	$10^1$	$10^0$		
35	Drift-compensation	1 $\mu\text{m}$ -255	1 $\mu\text{m}$ +255	SI	0	0	0	$10^4$	
		10 $\mu\text{m}$ -2550	10 $\mu\text{m}$ +2550	$10^3$	$10^2$	$10^1$	$10^0$	$\mu\text{m}$	
36	Acceleration correction	not active	BCD: 0	BINARY: 0	0	0	0	$10^4$	
		Step 1 32 769	8001	$10^3$	$10^2$	$10^1$	$10^0$	—	
38	Jerk limit for acceleration	1 $\mu\text{m}$ 0	1 $\mu\text{m}$ 1 950	0	0	$10^5$	$10^4$	mm	
		10 $\mu\text{m}$ 0	10 $\mu\text{m}$ 19 500	$10^3$	$10^2$	$10^1$	$10^0$	$\text{s}^3$	
39	Jerk limit for deceleration	1 $\mu\text{m}$ 0	1 $\mu\text{m}$ 1 950	0	0	$10^5$	$10^4$	mm	
		10 $\mu\text{m}$ 0	10 $\mu\text{m}$ 19 500	$10^3$	$10^2$	$10^1$	$10^0$	$\text{s}^3$	
40	Simulation	X=0	no simulation		0	0	0	0	—
		X=1	simulation		0	0	0	X	
41	Masking of check routines	Cable break check	1	0	0	$10^5$	$10^4$	—	
		Voltage check	2	$10^3$	$10^2$	$10^1$	$10^0$		
46	Approx. positioning tolerance 1	0	1 $\mu\text{m}$ 65 535	0	$10^6$	$10^5$	$10^4$	$\mu\text{m}$	
			10 $\mu\text{m}$ 655 350	$10^3$	$10^2$	$10^1$	$10^0$		
47	Approx. positioning tolerance 2	0	1 $\mu\text{m}$ 65 535	0	$10^6$	$10^5$	$10^4$	$\mu\text{m}$	
			10 $\mu\text{m}$ 655 350	$10^3$	$10^2$	$10^1$	$10^0$		
49	Basic resolution	X=1	1 $\mu\text{m}$	0	0	0	0	—	
		X=2	10 $\mu\text{m}$	0	0	0	X		
		X=3	100 $\mu\text{m}$						

**Machine data which becomes active only after a RESET, is marked with a gray background.**

### 3.9 WF 726 C: Closed Loop with Serial Absolute Encoders

MD-No.	Name	Lower Limit	Upper Limit	Format in BCD				Unit		
1	Acceleration	1 $\mu\text{m}$	1	1 $\mu\text{m}$	20 000	0	0	$10^5$	$10^4$	$\text{mm/s}^2$
		10 $\mu\text{m}$	10	10 $\mu\text{m}$	200 000	$10^3$	$10^2$	$10^1$	$10^0$	
2	Deceleration	1 $\mu\text{m}$	1	1 $\mu\text{m}$	20 000	0	0	$10^5$	$10^4$	$\text{mm/s}^2$
		10 $\mu\text{m}$	10	10 $\mu\text{m}$	200 000	$10^3$	$10^2$	$10^1$	$10^0$	
3	Maximum feed rate	1 $\mu\text{m}$	10	1 $\mu\text{m}$	3 000 000	$10^7$	$10^6$	$10^5$	$10^4$	mm
		10 $\mu\text{m}$	10	10 $\mu\text{m}$	30 000 000	$10^3$	$10^2$	$10^1$	$10^0$	100 min
4	Type of control and encoder	X=2			0	0	0	0	0	—
		Will change in next version			0	0	0	X		
5	Number of steps Absolute encoder	0		16 777 200		$10^7$	$10^6$	$10^5$	$10^4$	—
						$10^3$	$10^2$	$10^1$	$10^0$	
6	Assignment direction to command voltage		Voltage with positive movement	Count direction of the actual value		0	0	0	0	—
		X=0 X=1	+ -	+ +		0	0	0	X	
7	Number of steps per encoder revolution	0		4 096		0	0	0	0	—
						$10^3$	$10^2$	$10^1$	$10^0$	
8	Type of output M-Function	time controlled: 4	time controll.:65 535	0	0	0	$10^4$		ms	
		strobe controlled: 0	strobe controlled: 3	$10^3$	$10^2$	$10^1$	$10^0$			
9	Time of output M-Function	X=1	during positioning before positioning after positioning	0	0	0	0		—	
		X=2 X=3		0	0	0	X			
10	Fast outputs	O <sub>x</sub> =0	output without function position reached and stop traversing direction + traversing direction - reserve reserve reserve reserve reserve reserve	0	0	O <sub>6</sub>	O <sub>5</sub>	—		
		O <sub>x</sub> =1 O <sub>x</sub> =2 O <sub>x</sub> =3 O <sub>x</sub> =4 O <sub>x</sub> =5 O <sub>x</sub> =6 O <sub>x</sub> =7 O <sub>x</sub> =8 O <sub>x</sub> =9		O <sub>4</sub>	O <sub>3</sub>	O <sub>2</sub>	O <sub>1</sub>			
11	Pre-limit-switch negative	greater than limit switch negative (MD 12)	smaller than pre-limit-switch positive (MD 13)	SI	$10^7$	$10^6$	$10^5$	$10^4$	$\mu\text{m}$	
					$10^3$	$10^2$	$10^1$	$10^0$		
12	Limit switch negative	1 $\mu\text{m}$ -79 999999	smaller than pre-limit-switch negative (MD 11)	SI	$10^7$	$10^6$	$10^5$	$10^4$	$\mu\text{m}$	
		10 $\mu\text{m}$ -79 999990 100 $\mu\text{m}$ -79 999900		$10^3$	$10^2$	$10^1$	$10^0$			
13	Pre-limit-switch positive	greater than pre-limit-switch negative (MD 11)	smaller than limit switch positive (MD 14)	SI	$10^7$	$10^6$	$10^5$	$10^4$	$\mu\text{m}$	
					$10^3$	$10^2$	$10^1$	$10^0$		
14	Limit switch positive	greater than pre-limit-switch positive (MD 13)	1 $\mu\text{m}$ +79 999999 10 $\mu\text{m}$ +79 999990 100 $\mu\text{m}$ +79 999900	SI	$10^7$	$10^6$	$10^5$	$10^4$	$\mu\text{m}$	
					$10^3$	$10^2$	$10^1$	$10^0$		

Machine data which becomes active only after a RESET, is marked with a gray background.

MD-No.	Name	Lower Limit	Upper Limit	Format in BCD				Unit			
15	Fast inputs	I <sub>x</sub> =0	Inputs without function	0	0	I <sub>6</sub>	I <sub>5</sub>	—			
		I <sub>x</sub> =1	Inputs without function								
		I <sub>x</sub> =2	Inputs without function								
		I <sub>x</sub> =3	Inputs without function								
		I <sub>x</sub> =4	external read-in enable								
		I <sub>x</sub> =5	reserve	I <sub>4</sub>	I <sub>3</sub>	I <sub>2</sub>	I <sub>1</sub>				
		I <sub>x</sub> =6	reserve								
		I <sub>x</sub> =7	Alternative Start to Start from S5								
		I <sub>x</sub> =8	Start only if also Start from S5								
		I <sub>x</sub> =9	reserve								
17	Absolute encoder adjustment	1 µm	-79 999999	1 µm	+79 999999	SI	10 <sup>7</sup>	10 <sup>6</sup>	10 <sup>5</sup>	10 <sup>4</sup>	µm
		10 µm	-79 999990	10 µm	+79 999990	10 <sup>3</sup>	10 <sup>2</sup>	10 <sup>1</sup>	10 <sup>0</sup>		
		100 µm	-79 999900	100 µm	+79 999900						
18	Linear-/ rotary axis	0 or 1 ⇒ Linear axis		10 <sup>7</sup>	10 <sup>6</sup>	10 <sup>5</sup>	10 <sup>4</sup>	—			
		2   79 999999		10 <sup>3</sup>	10 <sup>2</sup>	10 <sup>1</sup>	10 <sup>0</sup>				
19	Pulse evaluation before the decimal point	0		0	0	0	0	—			
		9		0	0	0	10 <sup>0</sup>				
20	Pulse evaluation after the decimal point	0		10 <sup>-1</sup>	10 <sup>-2</sup>	10 <sup>-3</sup>	10 <sup>-4</sup>	—			
		99 999999		10 <sup>-5</sup>	10 <sup>-6</sup>	10 <sup>-7</sup>	10 <sup>-8</sup>				
21	Length of Telegram	X=1 :	24-Bit	0	0	0	0	—			
		X=4 :	21-Bit	0	0	0	X				
22	K <sub>v</sub> -Factor	20		0	0	0	0	m/min			
		900		0	10 <sup>2</sup>	10 <sup>1</sup>	10 <sup>0</sup>	100 mm			
23	Maximum command value voltage	1000		0	0	0	10 <sup>4</sup>	mV			
		10000		10 <sup>3</sup>	10 <sup>2</sup>	10 <sup>1</sup>	10 <sup>0</sup>				
24	Maximum following error dynamic	0		0	10 <sup>6</sup>	10 <sup>5</sup>	10 <sup>4</sup>	µm			
		1 µm 65 535		10 <sup>3</sup>	10 <sup>2</sup>	10 <sup>1</sup>	10 <sup>0</sup>				
		10 µm 655 350									
		100 µm 6553 500									
25	Maximum following error in standstill	0		0	10 <sup>6</sup>	10 <sup>5</sup>	10 <sup>4</sup>	µm			
		1 µm 65 535		10 <sup>3</sup>	10 <sup>2</sup>	10 <sup>1</sup>	10 <sup>0</sup>				
		10 µm 655 350									
		100 µm 6553 500									
26	Minimum following error dynamic	0		0	10 <sup>6</sup>	10 <sup>5</sup>	10 <sup>4</sup>	µm			
		1 µm 65 535		10 <sup>3</sup>	10 <sup>2</sup>	10 <sup>1</sup>	10 <sup>0</sup>				
		10 µm 655 350									
		100 µm 6553 500									
27	Definition of axes with split-drive	X=0	No permanent synchronization	0	0	0	0	—			
		X=3	Synchronisation between A+B	0	0	0	X				
		X=5	Synchronisation between A+C								
29	Tolerance of split-drive	1 µm	0	1 µm	65 535	0	10 <sup>6</sup>	10 <sup>5</sup>	10 <sup>4</sup>	µm	
		10 µm	0	10 µm	655 350						
		100 µm	0	100 µm	6553 500	10 <sup>3</sup>	10 <sup>2</sup>	10 <sup>1</sup>	10 <sup>0</sup>		

**Machine data which becomes active only after a RESET, is marked with a gray background.**

MD- No.	Name	Lower Limit	Upper Limit	Format in BCD				Unit	
30	PEH positioning time-out	0	9 999	0	0	0	0	ms	
				$10^3$	$10^2$	$10^1$	$10^0$		
32	Clamping tolerance	0	1 $\mu\text{m}$ 65 535	0	$10^6$	$10^5$	$10^4$	$\mu\text{m}$	
			10 $\mu\text{m}$ 655 350	$10^3$	$10^2$	$10^1$	$10^0$		
33	PEH: Positioning tole- rance	0	1 $\mu\text{m}$ 65 535	0	$10^6$	$10^5$	$10^4$	$\mu\text{m}$	
			10 $\mu\text{m}$ 655 350	$10^3$	$10^2$	$10^1$	$10^0$		
34	Travel difference monitor	0	79 999999	$10^7$	$10^6$	$10^5$	$10^4$	—	
				$10^3$	$10^2$	$10^1$	$10^0$		
35	Drift- compensation	1 $\mu\text{m}$ -255	1 $\mu\text{m}$ +255	SI	0	0	0	$10^4$	$\mu\text{m}$
		10 $\mu\text{m}$ -2550	10 $\mu\text{m}$ +2550	$10^3$	$10^2$	$10^1$	$10^0$		
36	Acceleration correction	not active	BCD: 0	BINARY: 0	0	0	0	$10^4$	—
		Step1	32 769	8001	$10^3$	$10^2$	$10^1$	$10^0$	
		Step2	32 770	8002					
		Step14	32 782	800E					
Step15	32 783	800F							
37	Length of cable / Baud rate	X=0	Cable length <150 m		0	0	0	0	—
		X=1	Baud rate : 125 kBit/s	Cable length <50 m		0	0	0	
38	Jerk limit for acceleration	1 $\mu\text{m}$ 0	1 $\mu\text{m}$ 1 950	0	0	$10^5$	$10^4$	mm	
		10 $\mu\text{m}$ 0	10 $\mu\text{m}$ 19 500	$10^3$	$10^2$	$10^1$	$10^0$	$\text{s}^3$	
39	Jerk limit for deceleration	1 $\mu\text{m}$ 0	1 $\mu\text{m}$ 1 950	0	0	$10^5$	$10^4$	mm	
		10 $\mu\text{m}$ 0	10 $\mu\text{m}$ 19 500	$10^3$	$10^2$	$10^1$	$10^0$	$\text{s}^3$	
40	Simulation	X=0	no simulation	0	0	0	0	—	
		X=1	simulation	0	0	0	X		
41	Masking of check routines	Cable break check	1	0	0	$10^5$	$10^4$	—	
		Voltage check	2	$10^3$	$10^2$	$10^1$	$10^0$		
46	Approx. position- ing tolerance 1	0	1 $\mu\text{m}$ 65 535	0	$10^6$	$10^5$	$10^4$	$\mu\text{m}$	
			10 $\mu\text{m}$ 655 350	$10^3$	$10^2$	$10^1$	$10^0$		
47	Approx. position- ing tolerance 2	0	1 $\mu\text{m}$ 65 535	0	$10^6$	$10^5$	$10^4$	$\mu\text{m}$	
			10 $\mu\text{m}$ 655 350	$10^3$	$10^2$	$10^1$	$10^0$		
49	Basic resolution	X=1	1 $\mu\text{m}$	0	0	0	0	—	
		X=2	10 $\mu\text{m}$	0	0	0	X		
		X=3	100 $\mu\text{m}$						

**Machine data which becomes active only after a RESET, is marked with a gray background.**

### 3.10 WF 726 C: Open Loop with Serial Absolute Encoders

MD- No.	Name	Lower Limit	Upper Limit	Format in BCD				Unit	
1	Acceleration encoder for increment	0	65 535	0	0	0	10 <sup>4</sup>	mV/s <sup>2</sup>	
				10 <sup>3</sup>	10 <sup>2</sup>	10 <sup>1</sup>	10 <sup>0</sup>		
2	Acceleration encoder for decrement	0	65 535	0	0	0	10 <sup>4</sup>	mV/s <sup>2</sup>	
				10 <sup>3</sup>	10 <sup>2</sup>	10 <sup>1</sup>	10 <sup>0</sup>		
4	Type of control and encoder	X=4		0	0	0	0	—	
				0	0	0	X		
5	Number of steps Absolute encoder	0	16 777 215	10 <sup>7</sup>	10 <sup>6</sup>	10 <sup>5</sup>	10 <sup>4</sup>	—	
				10 <sup>3</sup>	10 <sup>2</sup>	10 <sup>1</sup>	10 <sup>0</sup>		
6	Assignment of trav. direction to command voltage		Voltage with positive movement	Count direction of the actual value	0	0	0	0	—
		X=0 X=1	+	+	0	0	0	X	
7	Number of steps per encoder revolution	0	4 096	0	0	0	0	—	
				10 <sup>3</sup>	10 <sup>2</sup>	10 <sup>1</sup>	10 <sup>0</sup>		
8	Type of output M-Function	time controlled: 4	time controll.:65 535	0	0	0	10 <sup>4</sup>	ms	
		strobe controlled: 0	strobe controlled: 3	10 <sup>3</sup>	10 <sup>2</sup>	10 <sup>1</sup>	10 <sup>0</sup>		
9	Time of output M-Function	X=1	during positioning before positioning after positioning	0	0	0	0	—	
		X=2 X=3		0	0	0	X		
10	Fast outputs	O <sub>x</sub> =0	output without function position reached and stop traversing direction + traversing direction – reserve reserve reserve reserve reserve reserve	0	0	O <sub>6</sub>	O <sub>5</sub>	—	
		O <sub>x</sub> =1 O <sub>x</sub> =2 O <sub>x</sub> =3 O <sub>x</sub> =4 O <sub>x</sub> =5 O <sub>x</sub> =6 O <sub>x</sub> =7 O <sub>x</sub> =8 O <sub>x</sub> =9		O <sub>4</sub>	0	0	0		
11	Pre-limit- switch negative	greater than limit switch negative (MD 12)	smaller than pre-limit-switch positive (MD 13)	SI	10 <sup>7</sup>	10 <sup>6</sup>	10 <sup>5</sup>	10 <sup>4</sup>	μm
					10 <sup>3</sup>	10 <sup>2</sup>	10 <sup>1</sup>	10 <sup>0</sup>	
12	Limit switch negative	1 μm –79 999999	smaller than pre-limit-switch negative (MD 11)	SI	10 <sup>7</sup>	10 <sup>6</sup>	10 <sup>5</sup>	10 <sup>4</sup>	μm
		10 μm –79 999990			10 <sup>3</sup>	10 <sup>2</sup>	10 <sup>1</sup>	10 <sup>0</sup>	
13	Pre-limit- switch positive	greater than pre-limit-switch negative (MD 11)	smaller than limit switch positive (MD 14)	SI	10 <sup>7</sup>	10 <sup>6</sup>	10 <sup>5</sup>	10 <sup>4</sup>	μm
					10 <sup>3</sup>	10 <sup>2</sup>	10 <sup>1</sup>	10 <sup>0</sup>	
14	Limit switch positive	greater than pre-limit-switch positive (MD 13)	1 μm +79 999999	SI	10 <sup>7</sup>	10 <sup>6</sup>	10 <sup>5</sup>	10 <sup>4</sup>	μm
			10 μm +79 999990		10 <sup>3</sup>	10 <sup>2</sup>	10 <sup>1</sup>	10 <sup>0</sup>	

**Machine data which becomes active only after a RESET, is marked with a gray background.**

MD-No.	Name	Lower Limit	Upper Limit	Format in BCD				Unit	
17	Absolute encoder adjustment	1 $\mu\text{m}$ -79 999999	1 $\mu\text{m}$ +79 999999	SI	10 <sup>7</sup>	10 <sup>6</sup>	10 <sup>5</sup>	10 <sup>4</sup>	$\mu\text{m}$
		10 $\mu\text{m}$ -79 999990	10 $\mu\text{m}$ +79 999990		10 <sup>3</sup>	10 <sup>2</sup>	10 <sup>1</sup>	10 <sup>0</sup>	
18	Linear- / rotary axis	0 or 1 $\Rightarrow$	Linear axis		10 <sup>7</sup>	10 <sup>6</sup>	10 <sup>5</sup>	10 <sup>4</sup>	—
		2	79 999999		10 <sup>3</sup>	10 <sup>2</sup>	10 <sup>1</sup>	10 <sup>0</sup>	
19	Pulse evaluation before the decimal point	0	9	0	0	0	0	—	
				0	0	0	10 <sup>0</sup>		
20	Pulse evaluation after the decimal point	0	99 999999	10 <sup>-1</sup>	10 <sup>-2</sup>	10 <sup>-3</sup>	10 <sup>-4</sup>	—	
				10 <sup>-5</sup>	10 <sup>-6</sup>	10 <sup>-7</sup>	10 <sup>-8</sup>		
21	Length of Telegram	X=1 : 24-Bit		0	0	0	0	—	
		X=4 : 21-Bit		0	0	0	X		
30	PEH positioning time-out	0	9 999	0	0	0	0	ms	
				10 <sup>3</sup>	10 <sup>2</sup>	10 <sup>1</sup>	10 <sup>0</sup>		
32	Clamping tolerance	0	1 $\mu\text{m}$ 65 535	0	10 <sup>6</sup>	10 <sup>5</sup>	10 <sup>4</sup>	$\mu\text{m}$	
			10 $\mu\text{m}$ 655 350		10 <sup>3</sup>	10 <sup>2</sup>	10 <sup>1</sup>		10 <sup>0</sup>
33	PEH: Positioning tolerance	0	1 $\mu\text{m}$ 65 535	0	10 <sup>6</sup>	10 <sup>5</sup>	10 <sup>4</sup>	$\mu\text{m}$	
			10 $\mu\text{m}$ 655 350		10 <sup>3</sup>	10 <sup>2</sup>	10 <sup>1</sup>		10 <sup>0</sup>
34	Travel difference monitor	0	79 999999	10 <sup>7</sup>	10 <sup>6</sup>	10 <sup>5</sup>	10 <sup>4</sup>	—	
				10 <sup>3</sup>	10 <sup>2</sup>	10 <sup>1</sup>	10 <sup>0</sup>		
37	Length of cable / Baud rate	X=0	Cable length <150 m	0	0	0	0	—	
		X=1	Baud rate : 125 kBit/s Cable length <50 m Baud rate : 1 MBit/s		0	0	0		X
40	Simulation	X=0	no simulation	0	0	0	0	—	
		X=1	simulation		0	0	0		X
41	Masking of check routines	Cable break check		1	0	0	10 <sup>5</sup>	10 <sup>4</sup>	—
		Voltage check		2	10 <sup>3</sup>	10 <sup>2</sup>	10 <sup>1</sup>	10 <sup>0</sup>	
42	Reduction speed 1	$\geq$ MD43	99	0	0	0	0	—	
				0	0	10 <sup>1</sup>	10 <sup>0</sup>		
43	Reduction speed 2	$\geq$ MD44	$\leq$ MD42	0	0	0	0	—	
				0	0	10 <sup>1</sup>	10 <sup>0</sup>		
44	Reduction speed 3	1	$\leq$ MD43	0	0	0	0	—	
				0	0	10 <sup>1</sup>	10 <sup>0</sup>		

Machine data which becomes active only after a RESET, is marked with a gray background.



MD-No.	Name	Lower Limit	Upper Limit	Format in BCD				Unit
45	Travel difference 1	≥MD46	1 μm 79 999999 10 μm 79 999990 100 μm 79 999900	10 <sup>7</sup>	10 <sup>6</sup>	10 <sup>5</sup>	10 <sup>4</sup>	μm
				10 <sup>3</sup>	10 <sup>2</sup>	10 <sup>1</sup>	10 <sup>0</sup>	
46	Travel difference 2	≥MD47	≤MD45	10 <sup>7</sup>	10 <sup>6</sup>	10 <sup>5</sup>	10 <sup>4</sup>	μm
				10 <sup>3</sup>	10 <sup>2</sup>	10 <sup>1</sup>	10 <sup>0</sup>	
47	Travel difference 3	≥MD48	≤MD46	10 <sup>7</sup>	10 <sup>6</sup>	10 <sup>5</sup>	10 <sup>4</sup>	μm
				10 <sup>3</sup>	10 <sup>2</sup>	10 <sup>1</sup>	10 <sup>0</sup>	
48	Travel difference 4	0	≤MD47	10 <sup>7</sup>	10 <sup>6</sup>	10 <sup>5</sup>	10 <sup>4</sup>	μm
				10 <sup>3</sup>	10 <sup>2</sup>	10 <sup>1</sup>	10 <sup>0</sup>	
49	Basic resolution	X=1 X=2 X=3	1 μm 10 μm 100 μm	0	0	0	0	—
				0	0	0	X	

**Machine data which becomes active only after a RESET, is marked with a gray background.**



## 4 STEP 5 Blocks and Parameter

### 4.1 Start Up Function Blocks in OB 20, 21 and 22

Standard I	Standard I +Overlay	Standard I +Standard III +Overlay	Standard I +Standard III
Saving/loading of flags FB 209	Saving/loading of flags FB 209	Saving/loading of flags FB 209	Saving/loading of flags FB 209
Start up Standard I FB 211	Start up Standard I FB 211	Start up Standard I FB 211	Start up Standard I FB 211
		Start up Standard III FB 212	Start up Standard III FB 212

### 4.2 Start Up Function Blocks for Cyclic Operation in OB 1

Standard I	Standard I +Overlay	Standard I +Standard III +Overlay	Standard I +Standard III
<b>Standard I</b> FB 210	<b>Standard I</b> FB 210	<b>Standard I</b> FB 210	<b>Standard I</b> FB 210
<b>Comfort version</b> FB 179 FB 221 FB 222 FB 223 FB 218 FB 219 FB 229	<b>Overlay</b> FB 100 FB 101 FB 102	<b>Memory administration</b> <b>SIMATIC S5</b> FB 224 FB 225 FB 165	<b>Memory administration</b> <b>WF 785</b> FB 226 FB 227
		<b>Standard WF 470</b> FB S5-WF470 FB BILDLIST FB TAST	<b>Standard WF 470</b> FB S5-WF470 FB BILDLIST FB TAST
		<b>Standard III</b> FB 228	<b>Standard III</b> FB 228
		<b>Overlay</b> FB 100 FB 101 FB 102	

FB S5-WF470 includes the FB-numbers 248, 249, 251, 252, 253, 254, or 255, depending on type of SIMATIC; the function blocks of the Standard WF 470, the FB TAST (FB201) and the FB BILDLIST (FB220), must be renamed numerically!

### 4.3 Data Blocks for Start Up and Cyclic Operation

Standard I	Standard I +Overlay	Standard I +Standard II	Standard I +Standard II +Overlay	Standard I +Standard III +Overlay	Standard I +Standard II +Standard III	Standard I +Standard II +Standard III +Overlay
<b>DBZU</b> 1xper SIMATIC Length: 10 DW +2 DW per axis	<b>DBZU</b> 1xper SIMATIC Length: 10 DW +2 DW per axis	<b>DBZU</b> 1xperSIMATIC Length: 10 DW +2 DW per axis	<b>DBZU</b> 1xper SIMATIC Length: 10 DW +2 DW per axis	<b>DBZU</b> 1xper SIMATIC Length: 10 DW +2 DW per axis	<b>DBZU</b> 1xper SIMATIC Length: 10 DW +2 DW per axis	<b>DBZU</b> 1xper SIMATIC Length: 10 DW +2 DW per axis
<b>DBWF</b> 1xper WF 726 Length: 255 DW	<b>DBWF</b> 1xper WF 726 Length: 255 DW	<b>DBWF</b> 1xper WF 726 Length: 255 DW	<b>DBWF</b> 1xper WF 726 Length: 255 DW	<b>DBWF</b> 1xper WF 726 Length: 255 DW	<b>DBWF</b> 1xper WF 726 Length: 255 DW	<b>DBWF</b> 1xper WF 726 Length: 255 DW
<b>DB-Axis</b> 1xper axis Length: 63 DW	<b>DB-Axis</b> 1xper axis Length: 63 DW	<b>DB-Axis</b> 1xper axis Length: 63 DW	<b>DB-Axis</b> 1xper axis Length: 63 DW	<b>DB-Axis</b> 1xper axis Length: 63 DW	<b>DB-Axis</b> 1xper axis Length: 63 DW	<b>DB-Axis</b> 1xper axis Length: 63 DW
	<b>DB- . . . . .</b> nxper SIMATIC Length: ***		<b>DB- . . . . .</b> nxper SIMATIC Length: ***	<b>DB- . . . . .</b> nxper SIMATIC Length: ***		<b>DB- . . . . .</b> nxper SIMATIC Length: ***
		<b>DBAZ</b> 1xper SIMATIC Length: 17 DW	<b>DBAZ</b> 1xper SIMATIC Length: 17 DW		<b>DBAZ</b> 1xper SIMATIC Length: 17 DW	<b>DBAZ</b> 1xper SIMATIC Length: 17 DW
		<b>DBVZ</b> 1xper SIMATIC Length: 73 DW	<b>DBVZ</b> 1xper SIMATIC Length: 73 DW		<b>DBVZ</b> 1xper SIMATIC Length: 73 DW	<b>DBVZ</b> 1xper SIMATIC Length: 73 DW
		<b>DBPG</b> 1xper SIMATIC Length: 50 DW	<b>DBPG</b> 1xper SIMATIC Length: 50 DW		<b>DBPG</b> 1xper SIMATIC Length: 50 DW	<b>DBPG</b> 1xper SIMATIC Length: 50 DW
				<b>DB203</b> 1xper WF 470 Length: 255 DW	<b>DB203</b> 1xper WF 470 Length: 255 DW	<b>DB203</b> 1xper WF 470 Length: 255 DW
				<b>DB204</b> 1xper WF 470 Length: 255 DW	<b>DB204</b> 1xper WF 470 Length: 255 DW	<b>DB204</b> 1xper WF 470 Length: 255 DW
				<b>DBH</b> 1xper WF 470 Length: 15 DW	<b>DBH</b> 1xper WF 470 Length: 15 DW	<b>DBH</b> 1xper WF 470 Length: 15 DW
				<b>DBBL</b> 1xper WF 470 Length: 108 DW	<b>DBBL</b> 1xper WF 470 Length: 108 DW	<b>DBBL</b> 1xper WF 470 Length: 108 DW

\*\*\* Length depends on programming: - see Planning Instructions Part 2 Interface Description of the Standard Software Overlay

## 4.4 Set Up Standard I and Standard III

### OB 20, 21, 22

#### Saving of Flags

FB 209

1 x per SIMATIC S5

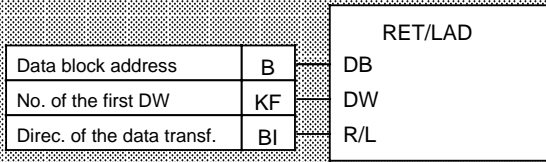

#### Set Up Standard I

FB 211

1 x per Module

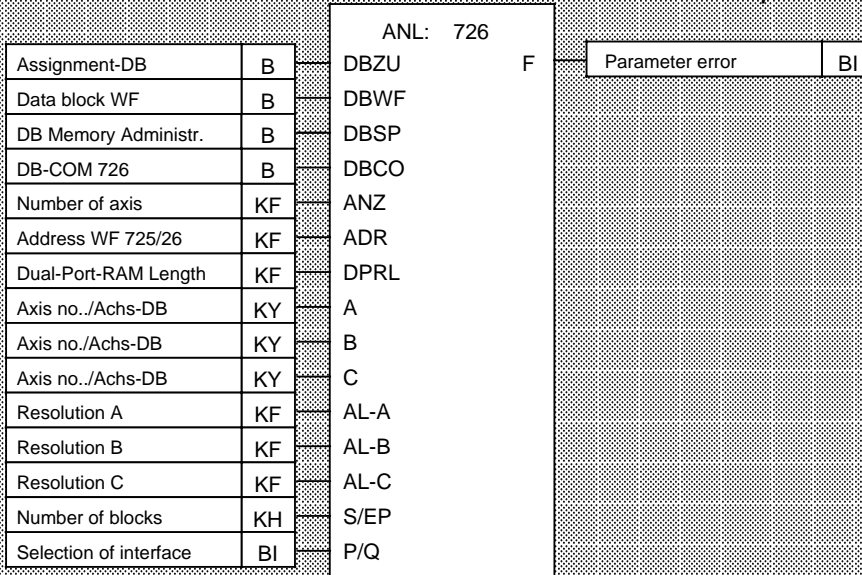

#### Set Up Standard III

FB 212

1 x per SIMATIC S5

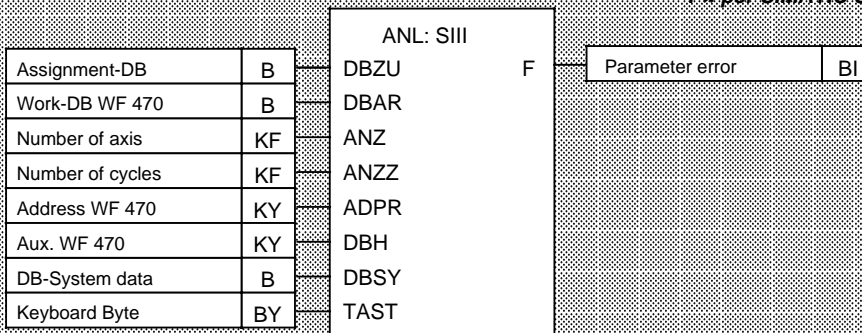

## 4.5 Standard I with Comfort Version

### OB 1

#### Standard I

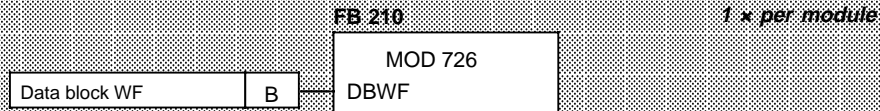

#### Comfort Version of Standard I

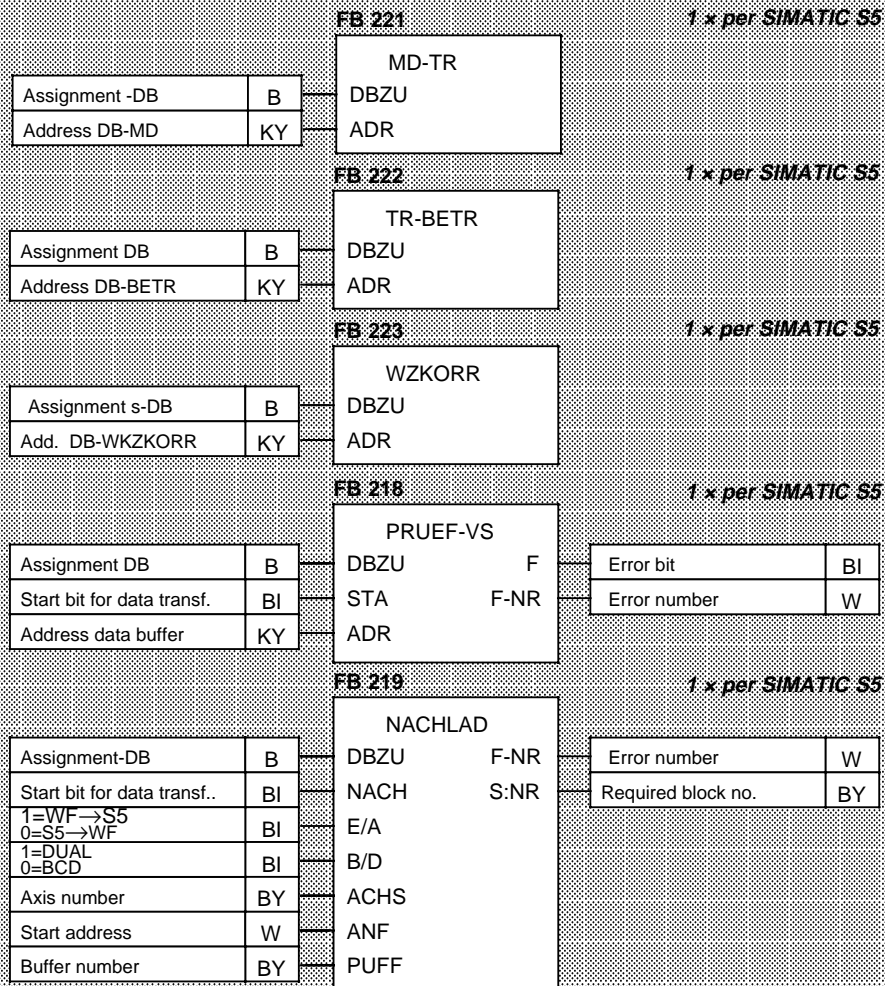

# OB 1

## Comfort Version of Standard I

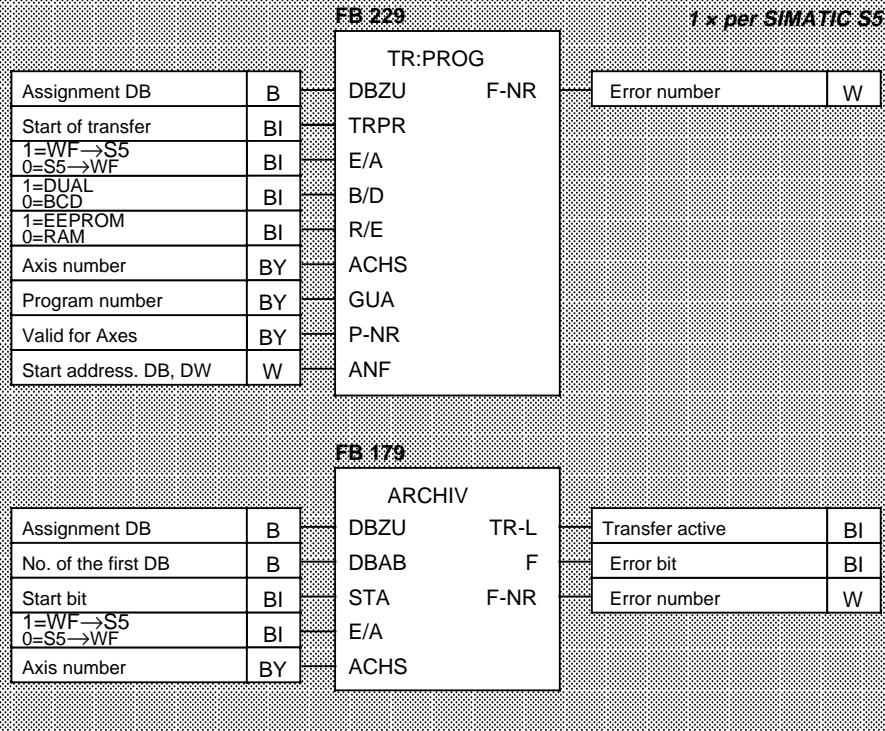

### 4.6 Standard III (without memory Administration)

# OB 1

## Standard III

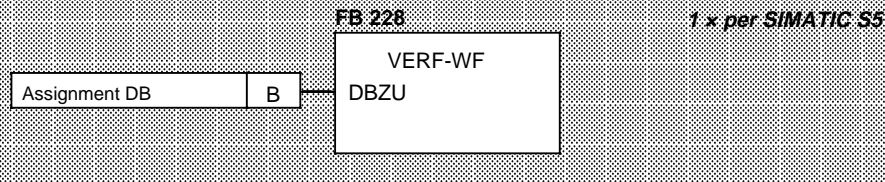

## 4.7 Memory administration of the SIMATIC S5 (together with Standard III)



### Memory Management SIMATIC S5

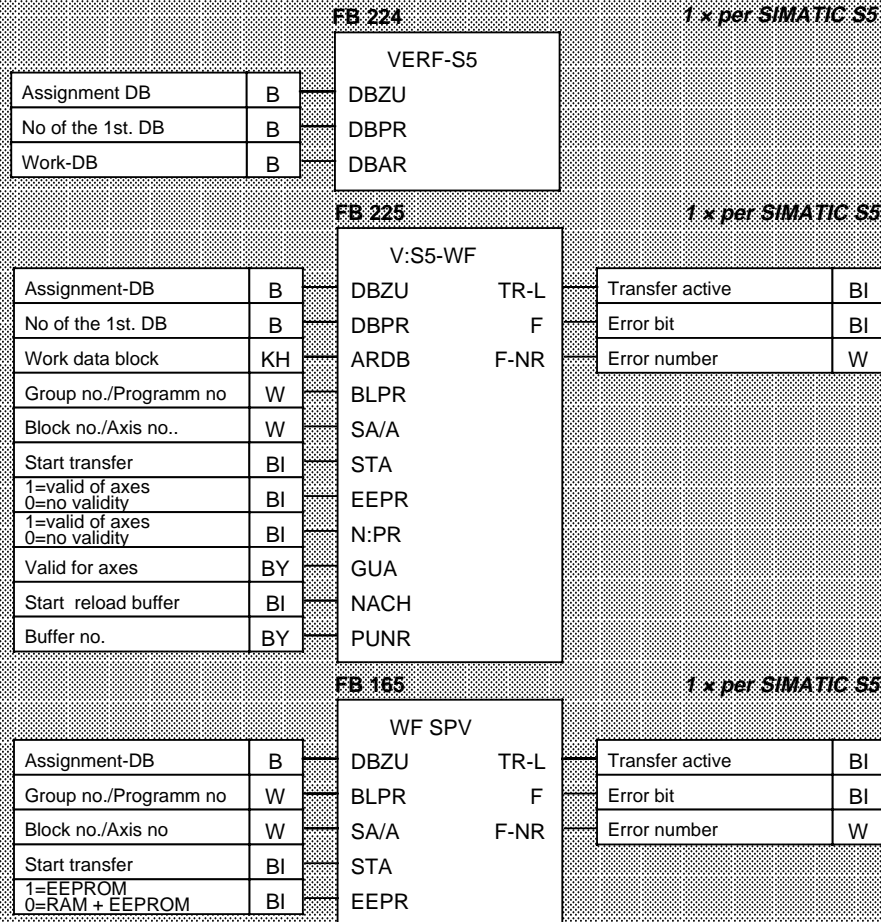



## 4.8 Standard WF 470 with Standard III

OB 1

### Standard WF 470

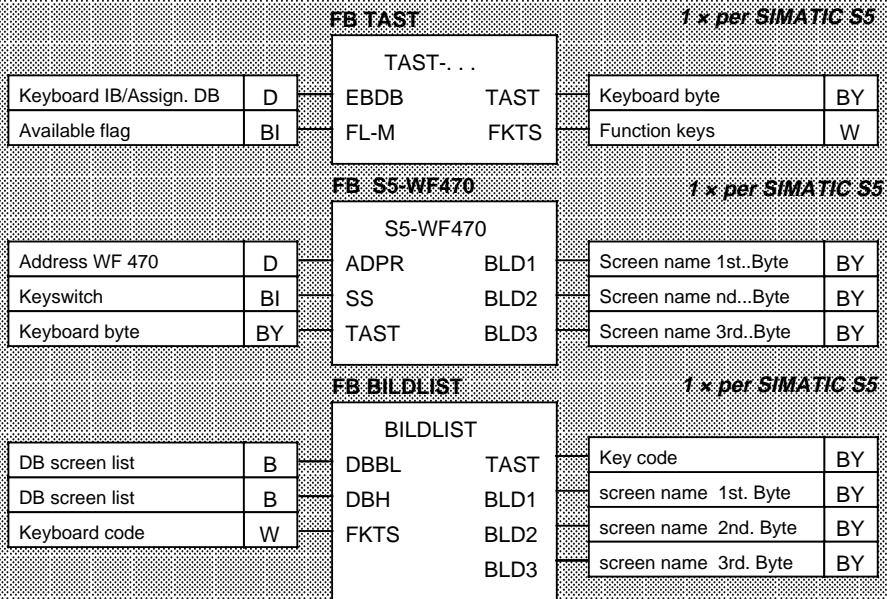

## 4.9 Software Overlay

### OB 1

#### Overlay

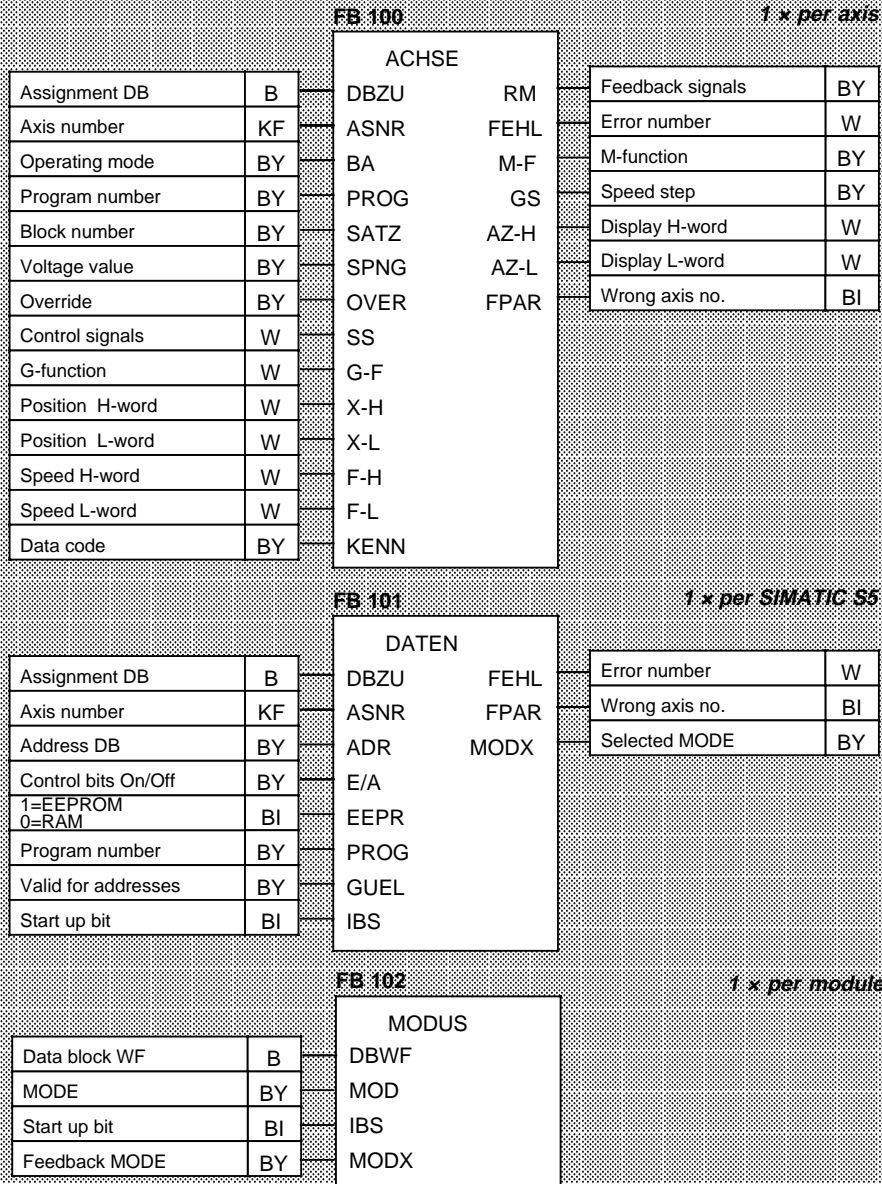

## 4.10 Library Numbers

Standard	SIMATIC S5-115U	SIMATIC S5-135U	SIMATIC S5-155U
<b>I-726</b>  FB 165 FB 179 FB 201 FB 202 FB 206 FB 207 FB 209 FB 210 FB 211 FB 215 FB 216 FB 217 FB 218 FB 219 FB 221 FB 222 FB 223 FB 224 FB 225 FB 229	<b>V0.4</b>  E88530-B 4174-A-50 E88530-B 4174-A-51 E88530-B 4174-A-51 E88530-B 4174-A-50 E88530-B 4174-A-51 E88530-B 4174-A-50 E88530-B 4174-A-50 E88530-B 4174-A-53 E88530-B 4174-A-52 E88530-B 4174-A-50 E88530-B 4174-A-52 E88530-B 4174-A-52 E88530-B 4174-A-52 E88530-B 4174-A-51 E88530-B 4174-A-50 E88530-B 4174-A-52 E88530-B 4174-A-52 E88530-B 4174-A-51	<b>V0.4</b>  E88530-B 4174-C-50 E88530-B 4174-C-51 E88530-B 4174-C-50 E88530-B 4174-C-50 E88530-B 4174-C-51 E88530-B 4174-C-50 E88530-B 4174-C-51 E88530-B 4174-C-52 E88530-B 4174-C-52 E88530-B 4174-C-50 E88530-B 4174-C-51 E88530-B 4174-C-51 E88530-B 4174-C-51 E88530-B 4174-C-50 E88530-B 4174-C-50 E88530-B 4174-C-50 E88530-B 4174-C-51 E88530-B 4174-C-51 E88530-B 4174-C-50	<b>V0.5</b>  E88530-B 4174-D-50 E88530-B 4174-D-51 E88530-B 4174-D-51 E88530-B 4174-D-51 E88530-B 4174-D-51 E88530-B 4174-D-51 E88530-B 4174-D-51 E88530-B 4174-D-52 E88530-B 4174-D-53 E88530-B 4174-D-50 E88530-B 4174-D-51 E88530-B 4174-D-51 E88530-B 4174-D-51 E88530-B 4174-D-50 E88530-B 4174-D-50 E88530-B 4174-D-50 E88530-B 4174-D-51 E88530-B 4174-D-51 E88530-B 4174-D-51
<b>III-726</b>  FB 166 FB 169 FB 200 FB 212 FB 228 FB 230 FB 231 FB 232 FB 233 FB 234 FB 235 FB 236	<b>V0.5</b>  E88530-B 4175-A-50 E88530-B 4175-A-50 E88530-B 4175-A-52 E88530-B 4175-A-53 E88530-B 4175-A-52 E88530-B 4175-A-51 E88530-B 4175-A-50 E88530-B 4175-A-52 E88530-B 4175-A-53 E88530-B 4175-A-53 E88530-B 4175-A-53 E88530-B 4175-A-53 E88530-B 4175-A-52	<b>V0.5</b>  E88530-B 4175-C-50 E88530-B 4175-C-51 E88530-B 4175-C-51 E88530-B 4175-C-52 E88530-B 4175-C-51 E88530-B 4175-C-51 E88530-B 4175-C-50 E88530-B 4175-C-51 E88530-B 4175-C-52 E88530-B 4175-C-51 E88530-B 4175-C-52 E88530-B 4175-C-51	<b>V0.6</b>  E88530-B 4175-D-51 E88530-B 4175-D-50 E88530-B 4175-D-52 E88530-B 4175-D-52 E88530-B 4175-D-51 E88530-B 4175-D-52 E88530-B 4175-D-51 E88530-B 4175-D-51 E88530-B 4175-D-51 E88530-B 4175-D-53 E88530-B 4175-D-52 E88530-B 4175-D-53 E88530-B 4175-D-51
<b>Overlay</b>  FB 100 FB 101 FB 102	<b>V0.5</b>  E88530-B 4188-A-54 E88530-B 4188-A-54 E88530-B 4188-A-53	<b>V0.5</b>  E88530-B 4188-A-54 E88530-B 4188-A-54 E88530-B 4188-A-53	<b>V0.5</b>  E88530-B 4188-A-54 E88530-B 4188-A-54 E88530-B 4188-A-53

E88530-B 4188-A-





# 5 Data and Data Interface

## 5.1 MODE-Selection - DBWF

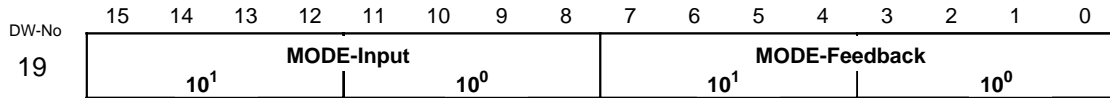

### 5.1.1 Traversing MODE

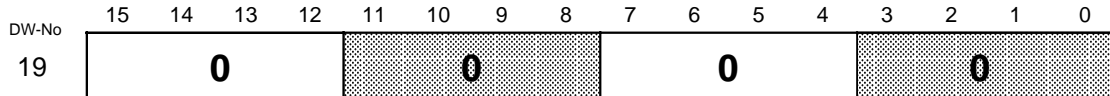

### 5.1.2 Program Input/Output MODE

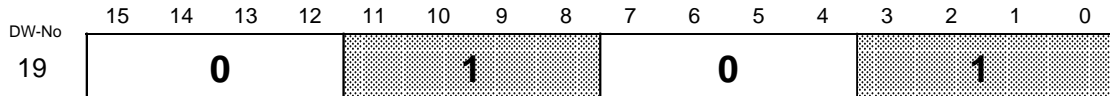

### 5.1.3 Service MODE

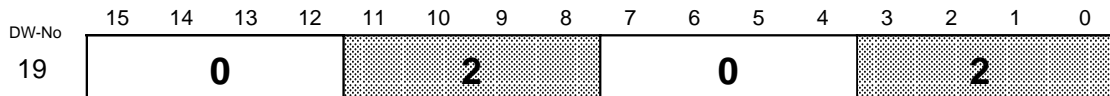

### 5.1.4 Machine Data Input/Output MODE

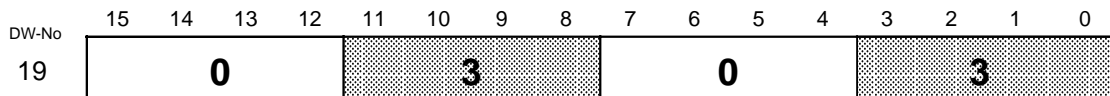

## 5.2 Data Interface Traversing MODE

### 5.2.1 Control and Feedback Bits in DB Axis

#### 5.2.1.1 Control Bits in DB Axis

DW-No	15	14	13	12	11	10	9	8	7	6	5	4	3	2	1	0
1									<b>Operating SUBMODE Selection to WF</b>				X1	X2	X3	re-served
2	<b>Program/Block number or Voltage Value</b>						SYTO	RESET	EEPR RAM	Ack. M-Fct.	Cancel Dist. to go	START STOP	X4	Drive Enable		
	<b>16<sup>1</sup></b>				<b>16<sup>0</sup></b>		SYAC	SYAB								

Operating submode Select. to WF (hexadecimal)	Operating Submode	X1	X2	X3	X4
0	no operating submode				
1	Set Up	Jog +	Fixed Speed 1/2	Jog –	
2	Homing	Direction +		Direction –	Deceleration Cam
3	Manual Data Input MDI	Direction + for Rotary Axis		Direction – for Rotary Axis	
4	Follow Up Mode				
5	Control	Positive Voltage	Unit of Voltage	Negative Voltage	
6	Clamping				
7	Preset				
8	Single Block	Direction + for Rotary Axis		Direction – for Rotary Axis	
9	Automatic Cycle	Direction + for Rotary Axis	Skip Block	Direction – for Rotary Axis	Read-In Enable
A	Automatic Single Step	Direction + for Rotary Axis	Skip Block	Direction – for Rotary Axis	Read-In Enable
B	Automatic Buffer				
C through F	no operating submode				

SYAB: Split-drive between A+B selected (valid only in axis A ⇒ MD 27 = 0)

SYAC: Split-drive between A+C selected (valid only in axis A ⇒ MD 27 = 0)

SYTO: Split-drive - monitor (bit 2.7=1: monitor active)

#### 5.2.1.2 Feedback Bits in DB Axis

DW-No	15	14	13	12	11	10	9	8	7	6	5	4	3	2	1	0	
3									M-Strobe	Axis Homed	Error Strobe	Y1	Y2	Axis moving backw.	Axis moving forw.	Position reached	
4	<b>Error/M-Function no/Speed Step</b>						<b>Operating SUBMODE Feedback from WF</b>						Execution active	Start Enable	Y3	Speed Step	
	<b>16<sup>1</sup></b>				<b>16<sup>0</sup></b>												

Y1: Limit switch reached

Y2: Pre-limit switch reached

Y3: D-Strobe/Dwell time in operating mode Automatic Cycle

## 5.2.2 Data Codes in DB Axis

Code (Hex)	Designation	Data Word		Format (BCD)													Unit		
		Input/	Output	15	14	13	12	11	10	9	8	7	6	5	4	3		2	1
01	Command value from interpolator	18	SI	10 <sup>7</sup>	10 <sup>6</sup>	10 <sup>5</sup>	10 <sup>4</sup>												μm
		19		10 <sup>3</sup>	10 <sup>2</sup>	10 <sup>1</sup>	10 <sup>0</sup>												
02	Actual value	18	SI	10 <sup>7</sup>	10 <sup>6</sup>	10 <sup>5</sup>	10 <sup>4</sup>												μm
		19		10 <sup>3</sup>	10 <sup>2</sup>	10 <sup>1</sup>	10 <sup>0</sup>												
03	Revolutions	18		10 <sup>7</sup>	10 <sup>6</sup>	10 <sup>5</sup>	10 <sup>4</sup>												1
		19		10 <sup>3</sup>	10 <sup>2</sup>	10 <sup>1</sup>	10 <sup>0</sup>												min
04	Tolerance band erroneous pulses	16	18	0	0	0	10 <sup>4</sup>												—
		17	19	10 <sup>3</sup>	10 <sup>2</sup>	10 <sup>1</sup>	10 <sup>0</sup>												
05	Actual following error	18	SI	10 <sup>7</sup>	10 <sup>6</sup>	10 <sup>5</sup>	10 <sup>4</sup>												μm
		19		10 <sup>3</sup>	10 <sup>2</sup>	10 <sup>1</sup>	10 <sup>0</sup>												
06	Fixed step 1 closed loop	16	18	10 <sup>7</sup>	10 <sup>6</sup>	10 <sup>5</sup>	10 <sup>4</sup>												mm
		17	19	10 <sup>3</sup>	10 <sup>2</sup>	10 <sup>1</sup>	10 <sup>0</sup>												100 min
06	Fixed step 1 open loop	16	18	0	0	0	0												—
		17	19	0	0	10 <sup>1</sup>	10 <sup>0</sup>												
07	Fixed step 2 closed loop	16	18	10 <sup>7</sup>	10 <sup>6</sup>	10 <sup>5</sup>	10 <sup>4</sup>												mm
		17	19	10 <sup>3</sup>	10 <sup>2</sup>	10 <sup>1</sup>	10 <sup>0</sup>												100 min
07	Fixed step 2 open loop	16	18	0	0	0	0												—
		17	19	0	0	10 <sup>1</sup>	10 <sup>0</sup>												
08	Homing speed 1	16	18	10 <sup>7</sup>	10 <sup>6</sup>	10 <sup>5</sup>	10 <sup>4</sup>												mm
		17	19	10 <sup>3</sup>	10 <sup>2</sup>	10 <sup>1</sup>	10 <sup>0</sup>												100 min
09	Homing speed 2	16	18	10 <sup>7</sup>	10 <sup>6</sup>	10 <sup>5</sup>	10 <sup>4</sup>												mm
		17	19	10 <sup>3</sup>	10 <sup>2</sup>	10 <sup>1</sup>	10 <sup>0</sup>												100 min
0A	Homing speed 3	16	18	10 <sup>7</sup>	10 <sup>6</sup>	10 <sup>5</sup>	10 <sup>4</sup>												mm
		17	19	10 <sup>3</sup>	10 <sup>2</sup>	10 <sup>1</sup>	10 <sup>0</sup>												100 min
0B	K <sub>v</sub> -Factor	18		0	0	0	0												m/min
		19		0	10 <sup>2</sup>	10 <sup>1</sup>	10 <sup>0</sup>												100 mm
0C	Acknowledge error	18		—	—	—	—												—
		19		—	—	—	—												
0D	Speed over-store	16	18	10 <sup>7</sup>	10 <sup>6</sup>	10 <sup>5</sup>	10 <sup>4</sup>												mm
		17	19	10 <sup>3</sup>	10 <sup>2</sup>	10 <sup>1</sup>	10 <sup>0</sup>												100 min
0E	Override	16	18	—	—	—	—												%
		17	19	10 <sup>3</sup>	10 <sup>2</sup>	10 <sup>1</sup>	10 <sup>0</sup>												
0F	Enter position into block list (TEACH IN)	16		16 <sup>1</sup>	Program number	16 <sup>0</sup>	16 <sup>1</sup>	Block number	16 <sup>0</sup>									—	
		17		—	—	—	—												

Code (Hex)	Designation	Data word Input/ Output	Format (BCD)														Unit		
			15	14	13	12	11	10	9	8	7	6	5	4	3	2		1	0
10	Drift- compensation	16	SI	10 <sup>7</sup>	10 <sup>6</sup>	10 <sup>5</sup>	10 <sup>4</sup>											μm	
		17		10 <sup>3</sup>	10 <sup>2</sup>	10 <sup>1</sup>	10 <sup>0</sup>												
11	reserved																		
12	reserved																		
13	Distance to go	18		10 <sup>7</sup>	10 <sup>6</sup>	10 <sup>5</sup>	10 <sup>4</sup>											μm	
		19		10 <sup>3</sup>	10 <sup>2</sup>	10 <sup>1</sup>	10 <sup>0</sup>												
14	Actual Sequence data	18	16 <sup>1</sup>	Block number	16 <sup>0</sup>	16 <sup>1</sup>	Program number	16 <sup>0</sup>											—
		19	16 <sup>1</sup>	Level	16 <sup>0</sup>	16 <sup>1</sup>	Residual no. of cyclers	16 <sup>0</sup>											
15	G-Function of the first G-Gruppe	16	10 <sup>1</sup>	G90 oor G91	10 <sup>0</sup>	—	—											only for MDI	
		17		—	—	—	—												
15	G-Functions of all G-Groups	11	16 <sup>1</sup>	Program number	16 <sup>0</sup>	16 <sup>1</sup>	Block number	16 <sup>0</sup>											—
		18	10 <sup>1</sup>	1st. G-Function	10 <sup>0</sup>	10 <sup>1</sup>	2nd. G-Funktion	10 <sup>0</sup>											
		19	10 <sup>1</sup>	3rd. G-Function	10 <sup>0</sup>	10 <sup>1</sup>	4th. G-Funktion	10 <sup>0</sup>											
16	G-Function of the second G-Group	16	10 <sup>1</sup>	G30 through G39	10 <sup>0</sup>	—	—											only for MDI	
		17		—	—	—	—												
16	G-Function of the second G-Group	11	16 <sup>1</sup>	Program number	16 <sup>0</sup>	16 <sup>1</sup>	Block number	16 <sup>0</sup>											—
		18	10 <sup>1</sup>	2nd. G-Function	10 <sup>0</sup>	—	—												
		19		—	—	—	—												
17	G-Function of the third G-Group	11	16 <sup>1</sup>	Program number	16 <sup>0</sup>	16 <sup>1</sup>	Block number	16 <sup>0</sup>											—
		18	10 <sup>1</sup>	3rd. G-Function	10 <sup>0</sup>	—	—												
		19		—	—	—	—												
18	G-Function of the fourth G-Group	11	16 <sup>1</sup>	Program number	16 <sup>0</sup>	16 <sup>1</sup>	Block number	16 <sup>0</sup>											—
		18	10 <sup>1</sup>	4th. G-Function	10 <sup>0</sup>	—	—												
		19		—	—	—	—												
19	Actual block position	16	SI	10 <sup>7</sup>	10 <sup>6</sup>	10 <sup>5</sup>	10 <sup>4</sup>											μm	
		17		10 <sup>3</sup>	10 <sup>2</sup>	10 <sup>1</sup>	10 <sup>0</sup>												
19	Block position from selected block	11	16 <sup>1</sup>	Program number	16 <sup>0</sup>	16 <sup>1</sup>	Block number	16 <sup>0</sup>											μm
		18	SI	10 <sup>7</sup>	10 <sup>6</sup>	10 <sup>5</sup>	10 <sup>4</sup>												
		19		10 <sup>3</sup>	10 <sup>2</sup>	10 <sup>1</sup>	10 <sup>0</sup>												
1A	Actual speed	16		10 <sup>7</sup>	10 <sup>6</sup>	10 <sup>5</sup>	10 <sup>4</sup>											mm	
		17		10 <sup>3</sup>	10 <sup>2</sup>	10 <sup>1</sup>	10 <sup>0</sup>											100 min	
1A	Speed from selected block	11	16 <sup>1</sup>	Program number	16 <sup>0</sup>	16 <sup>1</sup>	Block number	16 <sup>0</sup>											mm
		18		10 <sup>7</sup>	10 <sup>6</sup>	10 <sup>5</sup>	10 <sup>4</sup>												
		19		10 <sup>3</sup>	10 <sup>2</sup>	10 <sup>1</sup>	10 <sup>0</sup>												



Code (Hex)	Designation	Data Word Input/ Output		Format (BCD)												Unit		
				15	14	13	12	11	10	9	8	7	6	5	4		3	2
<b>1B</b>	1st., 2nd. and 3rd. M-Function D-Function		11	16 <sup>1</sup>	Program number	16 <sup>0</sup>	16 <sup>1</sup>	Block number	16 <sup>0</sup>									—
			18	10 <sup>1</sup>	1st. M-Function	10 <sup>0</sup>	10 <sup>1</sup>	2nd. M-Function	10 <sup>0</sup>									
			19	10 <sup>1</sup>	3rd. M-Function	10 <sup>0</sup>	10 <sup>1</sup>	D-Function	10 <sup>0</sup>									
<b>1C</b>	Second M-Function		11	16 <sup>1</sup>	Program number	16 <sup>0</sup>	16 <sup>1</sup>	Block number	16 <sup>0</sup>									—
			18	10 <sup>1</sup>	2nd. M-Function	10 <sup>0</sup>	—	—										
			19	—	—	—	—											
<b>1D</b>	Third M-Function		11	16 <sup>1</sup>	Program number	16 <sup>0</sup>	16 <sup>1</sup>	Block number	16 <sup>0</sup>									—
			18	10 <sup>1</sup>	3rd. M-Function	10 <sup>0</sup>	—	—										
			19	—	—	—	—											
<b>1E</b>	D-Function		11	16 <sup>1</sup>	Program number	16 <sup>0</sup>	16 <sup>1</sup>	Block number	16 <sup>0</sup>									—
			18	10 <sup>1</sup>	D-Function	10 <sup>0</sup>	—	—										
			19	—	—	—	—											
<b>1F</b>	Block search in main program	16	18	16 <sup>1</sup>	Block number	16 <sup>0</sup>	0	0									—	
		17	19	0	0	0	0											
<b>20</b>	Follow. error in fault condition		18	10 <sup>7</sup>	10 <sup>6</sup>	10 <sup>5</sup>	10 <sup>4</sup>									μm		
			19	10 <sup>3</sup>	10 <sup>2</sup>	10 <sup>1</sup>	10 <sup>0</sup>											
<b>21</b>	Maximum follow- ing error		18	10 <sup>7</sup>	10 <sup>6</sup>	10 <sup>5</sup>	10 <sup>4</sup>									μm		
			19	10 <sup>3</sup>	10 <sup>2</sup>	10 <sup>1</sup>	10 <sup>0</sup>											
<b>22</b>	Tool length offset	16		10 <sup>1</sup>	Correction number	10 <sup>0</sup>	SI	10 <sup>5</sup>	10 <sup>4</sup>									μm
		17		10 <sup>3</sup>	10 <sup>2</sup>	10 <sup>1</sup>	10 <sup>0</sup>											
<b>22</b>	Tool length offset		11	10 <sup>1</sup>	Correction number	10 <sup>0</sup>	0	0									μm	
			18	10 <sup>1</sup>	Correction number	10 <sup>0</sup>	SI	10 <sup>5</sup>	10 <sup>4</sup>									
			19	10 <sup>3</sup>	10 <sup>2</sup>	10 <sup>1</sup>	10 <sup>0</sup>											
<b>23</b>	Zero offset	16	18	SI	10 <sup>7</sup>	10 <sup>6</sup>	10 <sup>5</sup>	10 <sup>4</sup>									μm	
		17	19	10 <sup>3</sup>	10 <sup>2</sup>	10 <sup>1</sup>	10 <sup>0</sup>											
<b>24</b>	Command value DAC / ADC		18	16 <sup>1</sup>	Sign of DAC	16 <sup>0</sup>	0	DAC	16 <sup>2</sup>									—
			19	16 <sup>1</sup>	DAC	16 <sup>0</sup>	16 <sup>1</sup>	ADC	16 <sup>0</sup>									
<b>25</b>	Value ADC		11	0	10 <sup>0</sup>	0	0									—		
			18	16 <sup>1</sup>	ADC	16 <sup>0</sup>	0	0										
<b>26</b>	Block search in subprogram	16	18	16 <sup>1</sup>	Block no. level 1	16 <sup>0</sup>	10 <sup>1</sup>	Residual no. of cycles	10 <sup>0</sup>									—
		17	19	16 <sup>1</sup>	Block no. level 2	16 <sup>0</sup>	10 <sup>1</sup>	Residual no. of cycles	10 <sup>0</sup>									
<b>27</b>	switch actual value (ZOF)		16	0	10 <sup>0</sup>	0	0									—		
			17	0	0	0	0											
<b>28</b>	Override for all 3 axes		16	18	0	0	0	0									%	
			17	19	10 <sup>3</sup>	10 <sup>2</sup>	10 <sup>1</sup>	10 <sup>0</sup>										
<b>29</b>	Factor DAC		18	0	0	0	10 <sup>0</sup>									—		
			19	10 <sup>-1</sup>	10 <sup>-2</sup>	10 <sup>-3</sup>	10 <sup>-4</sup>											

Code (Hex)	Designation	Data Word Input/ Output		Format (BCD)												Unit			
				15	14	13	12	11	10	9	8	7	6	5	4		3	2	1
<b>2A</b>	Block deposition	18	SI	10 <sup>7</sup>	10 <sup>6</sup>	10 <sup>5</sup>	10 <sup>4</sup>											μm	
		19		10 <sup>3</sup>	10 <sup>2</sup>	10 <sup>1</sup>	10 <sup>0</sup>												
<b>2B</b>	Display of four error numbers	18		1st. error number				2nd. error number											
		19		3rd. error number				4th. error number											
<b>2C</b>	Number of blocks buffer	16	18	10 <sup>7</sup>	10 <sup>6</sup>	10 <sup>5</sup>	10 <sup>4</sup>											—	
		17	19	10 <sup>3</sup>	10 <sup>2</sup>	10 <sup>1</sup>	10 <sup>0</sup>												
<b>2D</b>	reserved			—	—	—	—											—	
				—	—	—	—												
<b>2E</b>	reserved			—	—	—	—											—	
				—	—	—	—												
<b>2F</b>	Delete buffer	16		0	Buffer no. 10 <sup>0</sup>	0	0											—	
		17		0	0	0	0												
<b>30</b>	Path difference synchronization	18	SI	10 <sup>7</sup>	10 <sup>6</sup>	10 <sup>5</sup>	10 <sup>4</sup>											μm	
		19		10 <sup>3</sup>	10 <sup>2</sup>	10 <sup>1</sup>	10 <sup>0</sup>												
<b>31</b>	Synchronization shift	16	18	SI	10 <sup>7</sup>	10 <sup>6</sup>	10 <sup>5</sup>	10 <sup>4</sup>											μm
		17	19		10 <sup>3</sup>	10 <sup>2</sup>	10 <sup>1</sup>	10 <sup>0</sup>											
<b>32</b>	Saved actual value	18	SI	10 <sup>7</sup>	10 <sup>6</sup>	10 <sup>5</sup>	10 <sup>4</sup>											μm	
		19		10 <sup>3</sup>	10 <sup>2</sup>	10 <sup>1</sup>	10 <sup>0</sup>												
<b>33</b>	Not used			—	—	—	—											—	
				—	—	—	—												
<b>34</b>	Not used			—	—	—	—											—	
				—	—	—	—												
<b>35</b>	Not used			—	—	—	—											—	
				—	—	—	—												
<b>36</b>	Not used			—	—	—	—											—	
				—	—	—	—												
<b>37</b>	Not used			—	—	—	—											—	
				—	—	—	—												
<b>38</b>	Not used			—	—	—	—											—	
				—	—	—	—												
<b>39</b>	Not used			—	—	—	—											—	
				—	—	—	—												

For error numbers see chapter 6

### 5.2.2.1 Input/Output of Data with Data Codes (DB Axis) Controlled by Strobe Signals

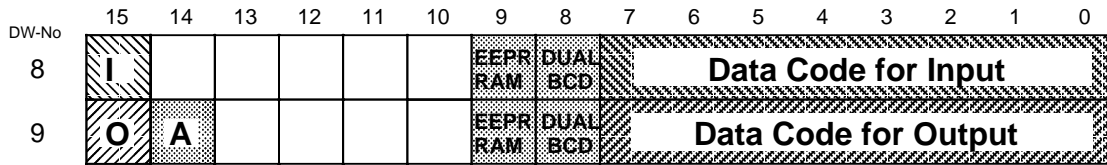

Explanation: Bit 8.8 and bit 9.8 "1": Information Binary  
 Bit 8.8 and bit 9.8 "0": Information BCD, Bit 8.9 and bit 9.9 "1": I/O in EEPROM  
 Bit 8.9 and bit 9.9 "0": I/O in RAM

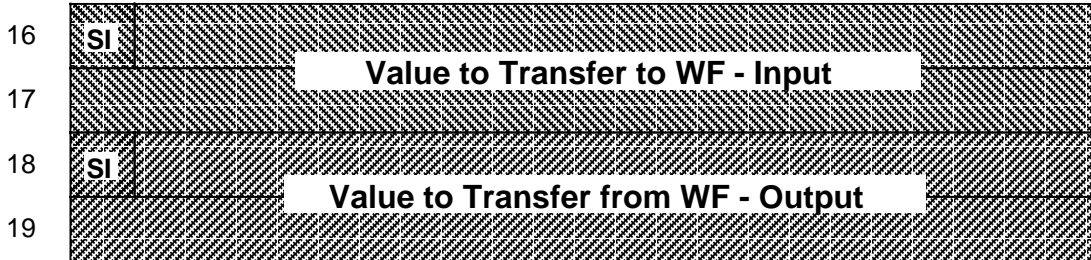

### 5.2.2.2 Output of Data with Data Codes (DB Axis) Cyclical Read-out (only from RAM)

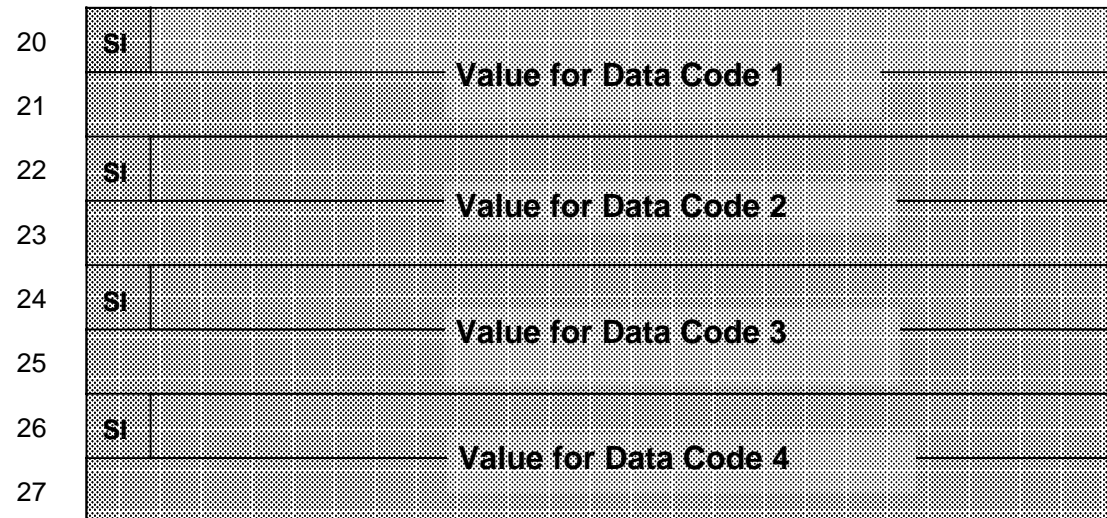
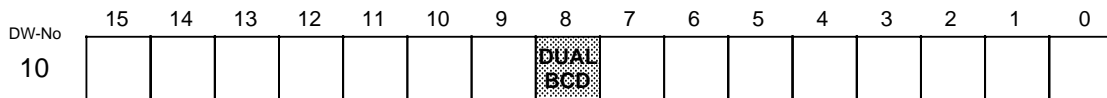

### 5.2.3 Fast Block Input in the Operating Mode MDI with DPR 32 or DPR 64 (DB Axis)

DW-No	15	14	13	12	11	10	9	8	7	6	5	4	3	2	1	0
28		I	DUAL BCD									G2		F	P	G1
29	G-Function 1st. G-Group								G-Function 2nd. G-Group							
30	SI	Position														
31																
32	Feed Rate															
33																

 WF 726 from software version V0.7

### 5.2.4 Reloading of Buffer with DPR 32

DW-No	15	14	13	12	11	10	9	8	7	6	5	4	3	2	1	0
192	DB-No. and DW-No. Block Transfer into Buffer															
193	O	I	DUAL BCD													A
194	In case of error 144, the next block number to be read-in is given here								Buffer Number							
195																
196									Block Number for Read-Out							
200 through 209	Blocks to be Read-Into Buffer (DPR 32)															
222 through 231	Blocks to Read-Out from Buffer (DPR 32)															

## 5.3 Data Interface MODE Program Data

### 5.3.1 Interface for Traversing Blocks DBWF

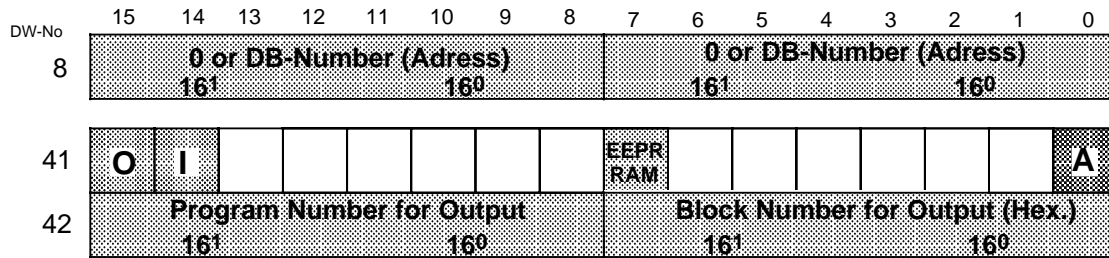

### 5.3.2 Structure of the Traversing Blocks

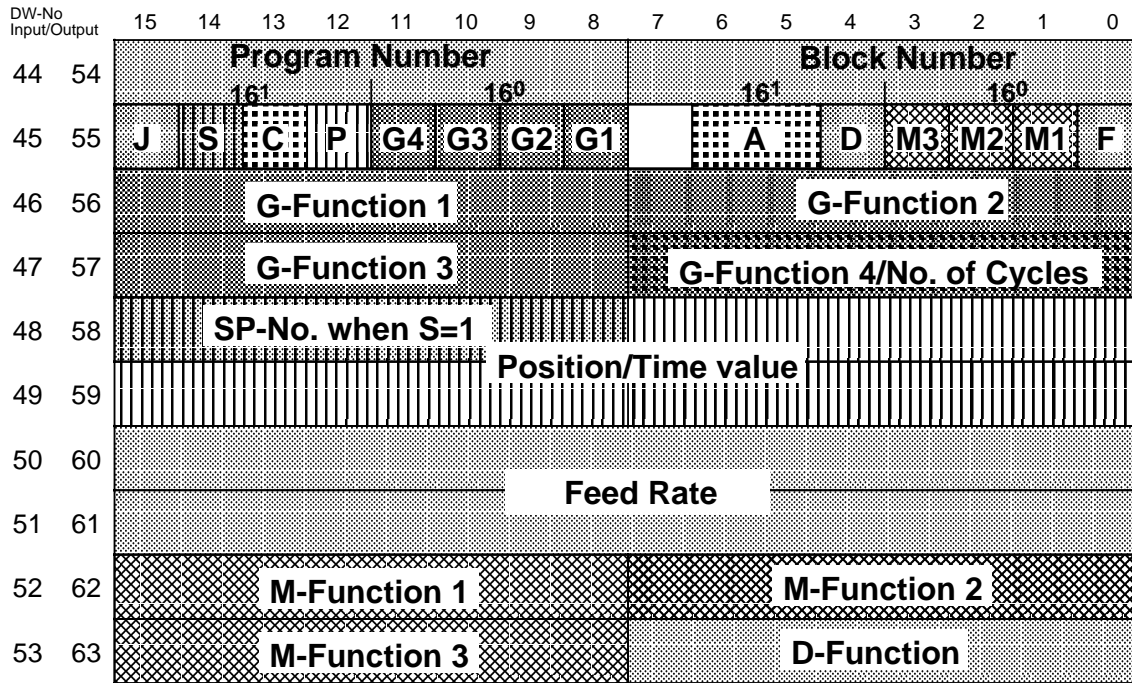

**Explanation of the Bits and Bit Combinations:**

Enable bits have to be set in data word 45 or 55, in order to validate the values in the subsequent data words.

- J** Skip block
- S** Subprogram coll
- C** Number of Cycles
- P** Position (or time value with)
- D** Tool length offset
- F** Feed rate
- A** Selection of axis number for which the block is valid (WF 726 only)
  - 0 0 = no Axis
  - 0 1 = Axis A,
  - 1 0 = Axis B
  - 1 1 = Axis C

- G-Function 1:**
  - 04 Dwell time
  - 90 Absolute programming
  - 91 Incremental programming
  - 92 Preset actual value
- G-Function 2:**
  - 30 100% of MD1/MD2
  - 31 10% of MD1/MD2
  - :
  - 39 90% of MD1/MD2
  - 53 Deselection of zero offset
  - 54 Selection of zero offset
  - 99 External read-in enable (MD 15)
- G-Function 3:**
  - 43 Tool length offset (+)
  - 44 Tool length offset (-)
  - 68 Endless loop negative
  - 69 Endless loop positive

- G-Function 4: (only WF 726)**
  - 07 Synchronization between A+B
  - 08 Synchronization between A+C
  - 17 Axes A and B (linear interpolation)
  - 18 Axes A and C (linear interpolation)
  - 19 Axes B and C (linear interpolation)
  - 21 Execute next block simultaneously
  - 23/73 next block, when A
  - 24/74 next block, when B
  - 25/75 next block, when A+B
  - 26/76 next block, when C
  - 27/77 next block, when A+C
  - 28/78 next block, when B+C
  - 29/79 next block, when A,B+C in tolerance window 1/2
- M-Functionen 1, 2 and 3:**
  - M00: Stop at block end
  - M11/ M12: Buffer-1/Buffer+1
  - M18: Endless cycle
  - M99: Synchronization of master-slave axes

### 5.3.3 Special routines (DBWF)

#### 5.3.3.1 Delete a block

DW-N°	15	14	13	12	11	10	9	8	7	6	5	4	3	2	1	0
65							EE P GK	EE P ANZ						EE CL SL	EE CL PP	EE CL N
66							E GK	E ANZ						CL SL	CL PP	CL N
70	Program Number for 'Delete block'						Block Number for 'Delete block'									
	16 <sup>1</sup>						16 <sup>0</sup>				16 <sup>1</sup>				16 <sup>0</sup>	

EE CL N: Memory selection for delete a block

"1" - EEPROM

"0" - RAM

CL N: Strobe bit for delete a block

#### 5.3.3.2 Delete a program

DW-N°	15	14	13	12	11	10	9	8	7	6	5	4	3	2	1	0		
65							EE P GK	EE P ANZ						EE CL SL	EE CL PP	EE CL N		
66							E GK	E ANZ						CL SL	CL PP	CL N		
71	Program-Number for 'Delete program'							internally used										
	16 <sup>1</sup>							16 <sup>0</sup>										

EE CL PP: Memory selection for delete a program

"1" - EEPROM

"0" - RAM

CL PP: Strobe bit for delete a program

#### 5.3.3.3 Delete the block list

DW-N°	15	14	13	12	11	10	9	8	7	6	5	4	3	2	1	0
65							EE P GK	EE P ANZ						EE CL SL	EE CL PP	EE CL N
66							E GK	E ANZ						CL SL	CL PP	CL N

EE CL SL: memory selection for delete the block list

"1" - EEPROM

"0" - RAM

CL SL: Strobe bit for delete the block list

### 5.3.3.4 Input number of blocks

DW-N°	15	14	13	12	11	10	9	8	7	6	5	4	3	2	1	0
65							EE P GK	EE P ANZ						EE CL SL	EE CL PP	EE CL N
66							E GK	E ANZ						CL SL	CL PP	CL N

EE P ANZ: Selection of memory (always "1")

E ANZ: Strobe bit for the transmission

### 5.3.3.5 Input of validity

DW-N°	15	14	13	12	11	10	9	8	7	6	5	4	3	2	1	0
65							EE P GK	EE P ANZ						EE CL SL	EE CL PP	EE CL N
66							E GK	E ANZ						CL SL	CL PP	CL N

96	Programnumber							Axis		
	16 <sup>1</sup>			16 <sup>0</sup>				C	B	A

EE P GK: Selection of memory for input of validity  
 "1" - EEPROM  
 "0" - RAM

E GK: Strobe bit for input of validity



### 5.3.3.6 Output of existing block numbers

DW-N°	15	14	13	12	11	10	9	8	7	6	5	4	3	2	1	0
67							A GK	A ANZ						A SW	A PP	A N
68	EEPR RAM								internally used							
69							Q GK	Q ANZ						Q SW	Q PP	Q N
94	Program number							Page number for output of existing blocks								
	$16^1$							$16^0$								
101	1. Block number							2. Block number								
	$16^1$							$16^0$								
102	3. Block number							4. Block number								
	$16^1$							$16^0$								
103	5. Block number							6. Block number								
	$16^1$							$16^0$								
104	7. Block number							8. Block number								
	$16^1$							$16^0$								

- A N: Strobe bit for output of existing block numbers  
 EEPR/RAM: Memory selection for output of existing block numbers  
 "1" - EEPROM; "0" - RAM  
 Q N: Acknowledgement-bit for output of existing block numbers

### 5.3.3.7 Output of existing programs

DW-N°	15	14	13	12	11	10	9	8	7	6	5	4	3	2	1	0
67							A GK	A ANZ						A SW	A PP	A N
68	EEPR RAM								internally used							
69							Q GK	Q ANZ						Q SW	Q PP	Q N
95	Page number															
	1	1	1	0	$16^0$											
101	1. Program number							2. Program number								
	$16^1$							$16^0$								
102	3. Program number							4. Program number								
	$16^1$							$16^0$								
103	5. Program number							6. Program number								
	$16^1$							$16^0$								
104	7. Program number							8. Program number								
	$16^1$							$16^0$								

- A PP: Strobe bit for output of existing programs  
 EEPR/RAM: Memory selection for output of existing programs  
 "1" - EEPROM; "0" - RAM  
 Q PP: Acknowledgement-bit for output of existing programs

### 5.3.3.8 Output of software and hardware versions

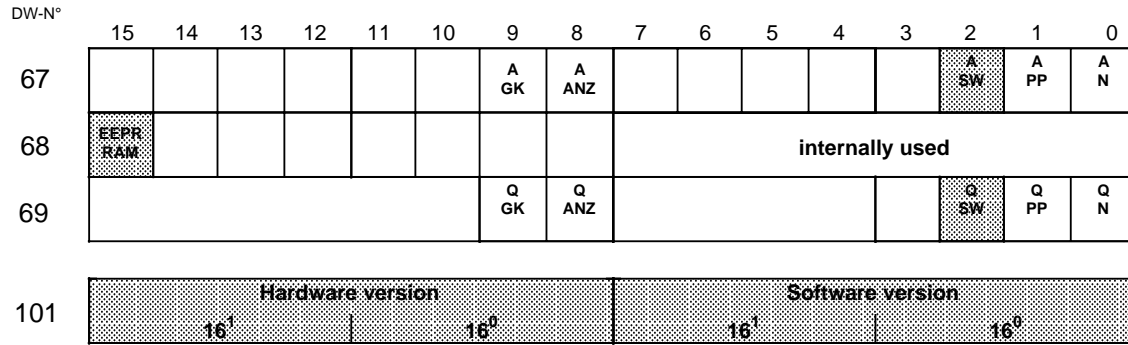

- A SW: Strobe bit for output of Hard- and Software version
- EEPR/RAM: Memory selection for output  
"1" - EEPROM  
"0" - RAM
- Q SW: Acknowledgement-Bit for output of Hard- and Software version

### 5.3.3.9 Output of number of blocks

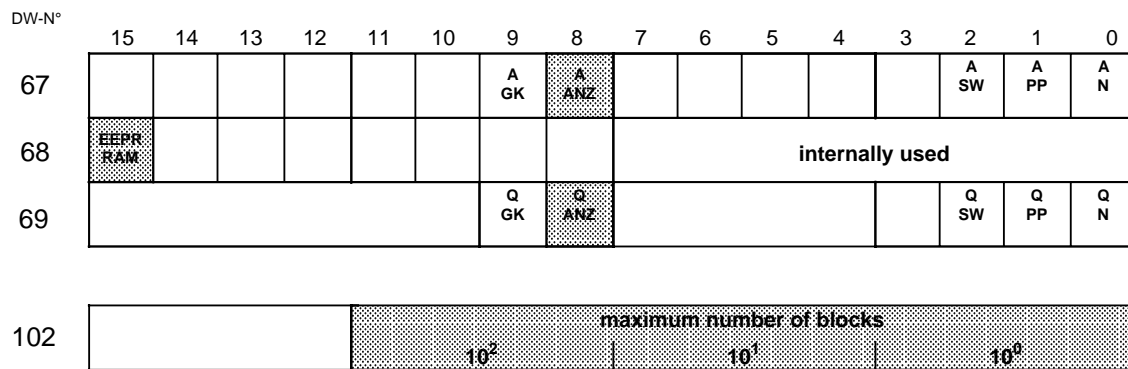

- A ANZ: Strobe bit for output of maximum number of blocks
- EEPR/RAM: Memory selection bit (always EEPROM)
- Q ANZ: Acknowledgement-Bit for output of maximum number of blocks

### 5.3.3.10 Output of validity

DW-Nr	15	14	13	12	11	10	9	8	7	6	5	4	3	2	1	0
67							A GK	A ANZ						A SW	A PP	A N
68	EEPR RAM								internally used							
69							Q GK	Q ANZ						Q SW	Q PP	Q N
97	Program number															
	16 <sup>1</sup>				16 <sup>0</sup>											
101	0				0		Axis									
							C	B	A							

- A GK: Strobe bit for output of validity
- EEPR/RAM: memory selection bit
- Q GK: Acknowledgement-Bit for output of validity

## 5.4 Interface MODE machine data input/output

### 5.4.1 Data channel machine data DB-Axis

Contents

DW No.	15	14	13	12	11	10	9	8	7	6	5	4	3	2	1	0
41	A	Q	DUAL BCD					EEPR RAM	10 <sup>1</sup>	MD number for output						10 <sup>0</sup>
42	E		DUAL BCD					EEPR RAM	10 <sup>1</sup>	MD number for output						10 <sup>0</sup>
43																
44	VZ	MD value to be transferred to WF (Input)														
45																
46	VZ	MD value to be transferred from WF (Output)														
47																

- RAM/EEPR    0 Transfer to RAM memory only  
                   1 Transfer to RAM and EEPROM
- BCD/DUAL    "0 MD value is in BCD  
                   1 MD value is in binary
- E             Strobe signal for transfer to WF, MD number must be BCD coded in DR 42
- A             Strobe signal for transfer from WF, MD number must be BCD coded in DR 41
- Q             Acknowledge bit
- SN            Sign bit for MD value (if applicable)

# 6 Error Messages

## 6.1 Output of Error Messages

### 6.1.1 Errors in Traversing MODE

DBWF

DW-No	15	14	13	12	11	10	9	8	7	6	5	4	3	2	1	0
19	<b>0</b>				<b>0</b>				<b>0</b>				<b>0</b>			

### 6.1.1.1 Errors During Traversing

DB Axis

DW-No	15	14	13	12	11	10	9	8	7	6	5	4	3	2	1	0
4	$16^1$				Error Number				$16^0$							

### 6.1.1.2 Errors During Data Transfer

DB Axis

DW-No	15	14	13	12	11	10	9	8	7	6	5	4	3	2	1	0				
40	$16^3$				$16^2$				Error Number				$16^1$				$16^0$			

### 6.1.2 Errors in MODE Program Data

DBWF

DW-No	15	14	13	12	11	10	9	8	7	6	5	4	3	2	1	0
19	<b>0</b>				<b>1</b>				<b>0</b>				<b>1</b>			

DBWF

DW-No	15	14	13	12	11	10	9	8	7	6	5	4	3	2	1	0				
40	$16^3$				$16^2$				Error Number				$16^1$				$16^0$			

### 6.1.3 Errors in Mode Service

DBWF

	15	14	13	12	11	10	9	8	7	6	5	4	3	2	1	0
DW-No 19	<b>0</b>				<b>2</b>				<b>0</b>				<b>2</b>			

DBCO

	15	14	13	12	11	10	9	8	7	6	5	4	3	2	1	0
DW-No 2	$16^3$				Error Number				$16^1$				$16^0$			
50																
51					Interface address											
52					Axis Number											



Data is transferred

### 6.1.4 Errors in Mode Machine Data

DBWF

	15	14	13	12	11	10	9	8	7	6	5	4	3	2	1	0
DW-No 19	<b>0</b>				<b>3</b>				<b>0</b>				<b>3</b>			

DB Axis

	15	14	13	12	11	10	9	8	7	6	5	4	3	2	1	0
DW-No 40	$16^3$				Error Number				$16^1$				$16^0$			

### 6.1.5 Errors from S5-Program, Independent of MODE

DBWF

	15	14	13	12	11	10	9	8	7	6	5	4	3	2	1	0
DW-No 39	$16^3$				Error Number				$16^1$				$16^0$			



## 6.2 Significance of the Error Numbers

### 6.2.1 WF-Messages in MODE Traversing

No.	Explanation	Version	A
01	System fault	1/5	
02	System fault	1/5	
03	System fault	1/5	
04	System fault	1/5	
05	System fault	1/5	
06	Stack overflow	1/5	
07	Cable break in the encoder cable	1/5	
08	Wrong impulse	1/5	
09	No zero mark	1/5	
0A			
0B	Voltage sensor error	1/5	
0C			
0D			
0E			
0F			
10	Following error in standstill	1/5	
11	Following error while traversing	1/5	
12			
13	Drive enable is missing (D 2.0)	1/5	
14	Drive not ready	1/5	
15	Range limit switch negative	1/5	
16	Range limit switch positive	1/5	
17	Drive enable went to data transfer/machine data zero in mode	1/5	
18			
19	Pulse evaluation factor (MD19 and MD20) = 0	1/5	
1A	Number of pulses per revolution = 0 not allowed	1/5	
1B	negative limit switch: Upper input limit exceeded	1/5	
1C	positive limit switch: Lower input limit exceeded	1/5	
1D			
1E			
1F			

No.	Explanation	Version	A
20	Max. traversing speed too fast	1/5	
21	Positioning (PEH) window left again	1/5	
22	Positioning (PEH) timeout	1/5	
23	Clamping tolerance exceeded	1/5	
24			
25	Synchronization tolerance exceeded	1/5	
26			
27			
28			
29			
30	Absolute encoder module does not exist	1/5	
31	Fault error	1/5	
32	Parity error	1/5	
33	Difference error	1/5	
34	Masking error	1/5	
35			
36			
37			
38	Zero mark faulty	1/5	
39	Watchdog error	1	
40	ADC error	1/5	
41	± 15V not within tolerance	1/5	
42	+ 15V not within tolerance	1/5	
43	- 15V not within tolerance	1/5	
44	5Vfuse defective	1/5	
45	24Vfuse defective	1/5	
46	Short circuit in command value	1/5	
47	Fault in back up battery	1/5	
48			
49	EEPROM defective	1/5	



- 1 = DB axis DW 4
- 2 = DB axis DW 40
- 3 = DBWF DW 40
- 4 = Memory administration
- 5 = Overlay parameter FEHL
- 6 = Blocks of the comfort version
- 7 = Memory administration

-  = Self acknowledging
-  = Acknowledgement with data code 800C<sub>Hex</sub>
-  = Reset





No.	Explanation	Version	A
50			
51	Current brake value = 0	1/5	
52			
53			
54			
55			
56			
57			
58			
59			
60			
61	No Block data	1/5	
62	Missing block data	1/5	
63			
64	Block number 0 not permitted	1/5	
65	MDI: No position	1/5	
66	MDI: No feed rate	1/5	
67	No block number	1/5	
68	Number of blocks per program not permitted	1/5	
69	Operating mode in slave axis 0	1/5	
6A	Fault in slave axis	1/5	
6B	Operating mode in slave axis 0	1/5	
6C	Program number changed	1/5	
6D	MD1 and/or MD2 are different during synchronous operation	1/5	
6E			
6F			



No.	Explanation	Version	A
70	Absolute programming with Roll feed	1/5	
71	Deceleration = 0	1/5	
72	Selected jog speed = 0	1/5	
73	Feed rate = 0 in the block data	1/5	
74	Reference point appr. speed 1 = 0	1/5	
75	Reference point appr. speed 2 = 0	1/5	
76	Reference point appr. speed 3 = 0	1/5	
77	Both directions selected (jog+/-)	1/5	
78	no direction selected (jog+-)	1/5	
79	direction selection changed (jog+-)	1/5	
7A	Open loop: 4th.G-Group not allowed	1/5	
7B			
7C			
80	Program number 0 not permitted	1/5	
81	No program number	1/5	
82	No block data available	1/5	
83	1st. G-Function not permitted	1/5	
84	2nd. G-Function not permitted	1/5	
85	3rd. G-Function not permitted	1/5	
86	4th. G-Function not permitted	1/5	
87	Deactivation of tool offset which was not active	1/5	
88	Last block in a program must not be skipped	1/5	
89	Deactivation of zero offset which was not active	1/5	
90	Program number not valid for this axis	1/5	
91	Subroutine level not permitted	1/5	
92	"Setting of act. value" already active	1/5	
93	"Setting of act. value" not yet active	1/5	
94			
95	Pre-limit switch negative (MD 11)	1/5	
96	Pre-limit switch positive (MD 13)	1/5	
97			
98			
99	Hardware version <2: simultaneous homing ist not possible	1/5	

- 1 = DB axis DW 4
- 2 = DB axis DW 40
- 3 = DBWF DW 40
- 4 = Memory administration
- 5 = Overlay parameter FEHL
- 6 = Blocks of the comfort version
- 7 = Memory administration



-  = Self acknowledging
-  = Acknowledgement with data code 800C<sub>Hex</sub>
-  = Reset



No.	Explanation	Version	A
A0			
A1			
A2			
A3			
A4			
A5			
A6			
A7			
A8			
A9			
AA			
AB			
AC			
AD			
AE			
AF			
B0	Buffer number not permitted	1/5	
B1	Buffer number not enabled	1/5	
B2	Buffer: M11 not permitted	1/5	
B3	Buffer: M12 not permitted	1/5	
B4			
B5			
B6			
B7			
B8			
B9	"Flying setting of actual value": MD15 not programmed	1/5	
BA			
BB			
BC			
BD			
BE			
BF			

No.	Explanation	Version	A
C0			
C1			
C2			
C3			
C4			
C5			
C6			
C7			
C8			
C9			
D0	Rate-of-change limiting for Acceleration to large	1/5	
D1	Rate-of-change limiting for Deceleration to large	1/5	
D2	Interpolation and Jerk limit not simultaneously possible	1/5	
D3			
D4			
D5			
D6			
D7			
D8			
D9			

- 1 = DB axis DW 4
- 2 = DB axis DW 40
- 3 = DBWF DW 40
- 4 = Memory administration
- 5 = Overlay parameter FEHL
- 6 = Blocks of the comfort version
- 7 = Memory administration



-  = Self acknowledging
-  = Acknowledgment with data code 800C<sub>Hex</sub>
-  = Reset

## 6.2.2 WF-Messages in MODE Program Input/Output

No.	Explanation	Version	A
100			
101	EEPROM: Addressing fault	2/3/5/6	
102	RAM: Addressing fault	2/3/5/6	
103			
104			
105	Memorization not possible	2/3/5/6	
106			
107			
108			
109			
110			
111	Read-In /Read-Out not possible simultaneously	2/3	
112	Data code 0 not valid	2	
113	Data code not valid	2/5	
114	Axis number = 0 not valid		
115			
116			
117			
118			
119			
120			
121	MD number not valid	2	
122			
123	Max. number of blocks stored	3/5/6/7	
124	Max. number of programs stored	3/5/6/7	
125	Program number 0 is not valid	3/5/6/7	
126	Block number not valid	3/5/6/7	
127	Program number not available	3/5/6	
128	Block number not available	3	
129	No block numbers available	3/5	

No.	Explanation	Version	A
130	Validity missing	3/5	
131	EEPROM socket empty	2/3	
132	EEPROM: Programming Error	2/3	
133			
134			
135	Teach-In: Program number 0 not valid	2	
136	Teach-In: Block number 0 not valid	2	
137	Teach-In: No program n° available	2	
138	Teach-In: Program memory full	2	
139			
140			
141			
142	Tool offset number not valid	2	
143	Reloading: block number not valid	2/7	
144	Reloading: Incorrect sequence	2/7	
145	Feed rate is zero in MDI mode/ invalid page number	2/3	
146	Reloading: No block data	3	
147	Invalid block number or > 50	2/7	
148	Diagnostic: invalid additional information		
149			
150			
151	invalid buffer number	2/7	
152	Reloading: Number of blocks per buffer > 50	2/7	
153			
154			
155	Reloading: No buffer number selected for uploading	2/7	
156			
157			
158			
159			
172			
173	Interpolation: missing block information	2/7	
174	Interpolation: G-Function 4 not valid	2/7	
175			
181	Interpolation: Sequence of Input not valid		
182			

- 1 = DB axis DW 4
- 2 = DB axis DW 40
- 3 = DBWF DW 40
- 4 = Memory administration
- 5 = Overlay parameter FEHL
- 6 = Blocks of the comfort version
- 7 = Memory administration



-  = Self acknowledging
-  = Acknowledgement with data code 800C<sub>Hex</sub>
-  = Reset

### 6.2.3 Messages from the STEP 5 Memory Administration

No.	Explanation	Version	A
200			
201	Wrong mode	4/5	
202	WF not ready	4/5	
203	Reloading not permitted	6	
204			
205			
206			
207			
208			
209			
210			
211	Invalid axis number	6	
212	Invalid parameter GUA	6	
213	Validity declaration missing		
214	Buffer number = 0 or does not conform to axis number	6	
215	Gaps in block numbers	7	
216			
217			
218			
219			
220	Wrong parameters in FB call	6	
221			
222			
223			
224			
225			
226			
227			
228			
229			

No.	Explanation	Version	A
230	Program number = 0	6	
231	Block number = 0	6	
232	G1 not valid	6	
233	G2 not valid	6	
234	G3 not valid	6	
235	G4 not valid	6	
236	G04 without time value	6	
237	Subroutine without number of cycles	6	
238	Subroutine + G function	6	
239	Number of tool length offset memory >20	6	
240	Number of cycles		
241	Selected program group, program or block not available	7	
242			
243			
244	Error during generation of DB, or DB does already exist	7	
245	No storage of block possible (all DB's are full)	7	
246			
247			
248			
249			
250			
251			
252			
253			
254			
255			
256			
257			
258			
259			

- 1 = DB axis DW 4
- 2 = DB axis DW 40
- 3 = DBWF DW 40
- 4 = Memory administration
- 5 = Overlay parameter FEHL
- 6 = Blocks of the comfort version
- 7 = Memory administration

-  = Self acknowledging
-  = Acknowledgement with data code 800C<sub>Hex</sub>
-  = Reset



Siemens AG

AUT V 22  
Postfach 4848  
D-91080 Erlangen  
Fed. Rep.of Germany

**Corrections**

For Publication/Manual:

WF 725/WF 726  
Positioning Modules

Installations Instructions - Lists  
Order-No.: 6ZB5 440-0JQ02-0AA2  
Edition: October 1992

**From:**

Name \_\_\_\_\_

Company/Dept. \_\_\_\_\_

Address \_\_\_\_\_

Telephone \_\_\_\_\_ /

If you find any printing errors when reading this publication, please let us know, using this form. We also welcome any suggestions to improve the manual.

**Suggestions and/or corrections**

# Equipment for special machines

WS 725/WF 726

## Manual

Siemens AG  
Automation Group  
Automation Systems  
for Machine Tools, Robots  
and Special-Purpose Machines  
P.O. Box 31 80, 91050 Erlangen  
Federal Republic of Germany

© Siemens AG 1994 All Rights Reserved  
Subject to change without prior notice  
570 093 300 117

---

Siemens Aktiengesellschaft

Order No. 6ZB5 440-0JQ02-0AA2  
Printed in the Fed. Rep. of Germany  
RGWE/640102 IA 03960.1