

Power Supply Modules for AC Drives

Selection and Dimensioning Manual

DOK-POWER*GENEREL****-AUS1-EN-P



<i>Title</i>	Power Supply Modules for AC Drives
<i>Type of documentation</i>	Selection and Dimensioning Manual
<i>Documenttype</i>	DOK-POWER*-GENEREL****-AUS1-EN-E1,44 • 10.96
<i>Internal file reference</i>	<ul style="list-style-type: none"> • Mappe 6 • Versg-AW.pdf • 209-0049-4301-01
<i>Purpose of documentation</i>	<p>This document is to be used for:</p> <ul style="list-style-type: none"> • Selecting power supply modules based on functional considerations • Selecting auxiliary components • Calculating the data needed to make proper selections • Selecting supply modules based on the performance requirements of individual drives • Determining the line connection power

Change procedures

Designation of documentation up to present edition	Release-date	Comments
209-0049-4301-00 EN/09.94	Sep./94	First Edition
209-0049-4301-01 EN/03.95	Mär./95	Revision
DOK-POWER*-GENEREL****-AUS1-EN-E1,44	Okt./96	Introduction of document type

Copyright © INDRAMAT GmbH, 1994

Copying this document, and giving it to others and the use or communication of the contents thereof without express authority, are forbidden. Offenders are liable for the payment of damages. All rights are reserved in the event of the grant of a patent or the registration of a utility model or design (DIN 34-1)

The electronic documentation (E-doc) may be copied as often as needed if such are to be used by the consumer for the purpose intended.

Validity All rights are reserved with respect to the contents of this documentation and the availability of the product.

Published by INDRAMAT GmbH • Bgm.-Dr.-Nebel-Straße 2 • D-97816 Lohr
Telephone 09352/40-0 • Tx 689421 • Fax 09352/40-4885
Dept. ENA (DE, FS)

Table of Contents	Page
1. Configuration of the Modular INDRAMAT AC Drive System	5
1.1. Function of the Power Supply Module	5
2. Applications and Power Characteristics	6
2.1. Selection Data	7
2.2. TVM 2.4 Power Supply Module	9
2.3. TVD 1.2 Power Supply Module	12
2.4. TVR 3.1 Power Supply Module	15
2.5. KDV 2.3 Power Supply Module	18
2.6. KDV 4.1 Power Supply Module	22
2.7. KVR 1.2 Power Supply Module	26
3. Calculations and Selecting the Correct Power Supply	30
3.1. DC Bus Continuous Power	31
3.2. DC Bus Peak Power	34
3.3. Regenerated Energy	34
3.4. Continuous Regenerated Power	36
3.5. Peak Regenerated Power	37
3.6. Power Requirements	38
3.7. Power Requirements for Motor and Heat Sink Blowers	39
3.8. Power for the Electronic Circuits	39
4. Index	41
5. Additional Documentation	43

1. Configuration of the Modular INDRAMAT AC Drive System

The modular INDRAMAT AC Drive System consists of the power supply module, the drives and the motors. Several drives of various power requirements can be powered by a single power supply module.

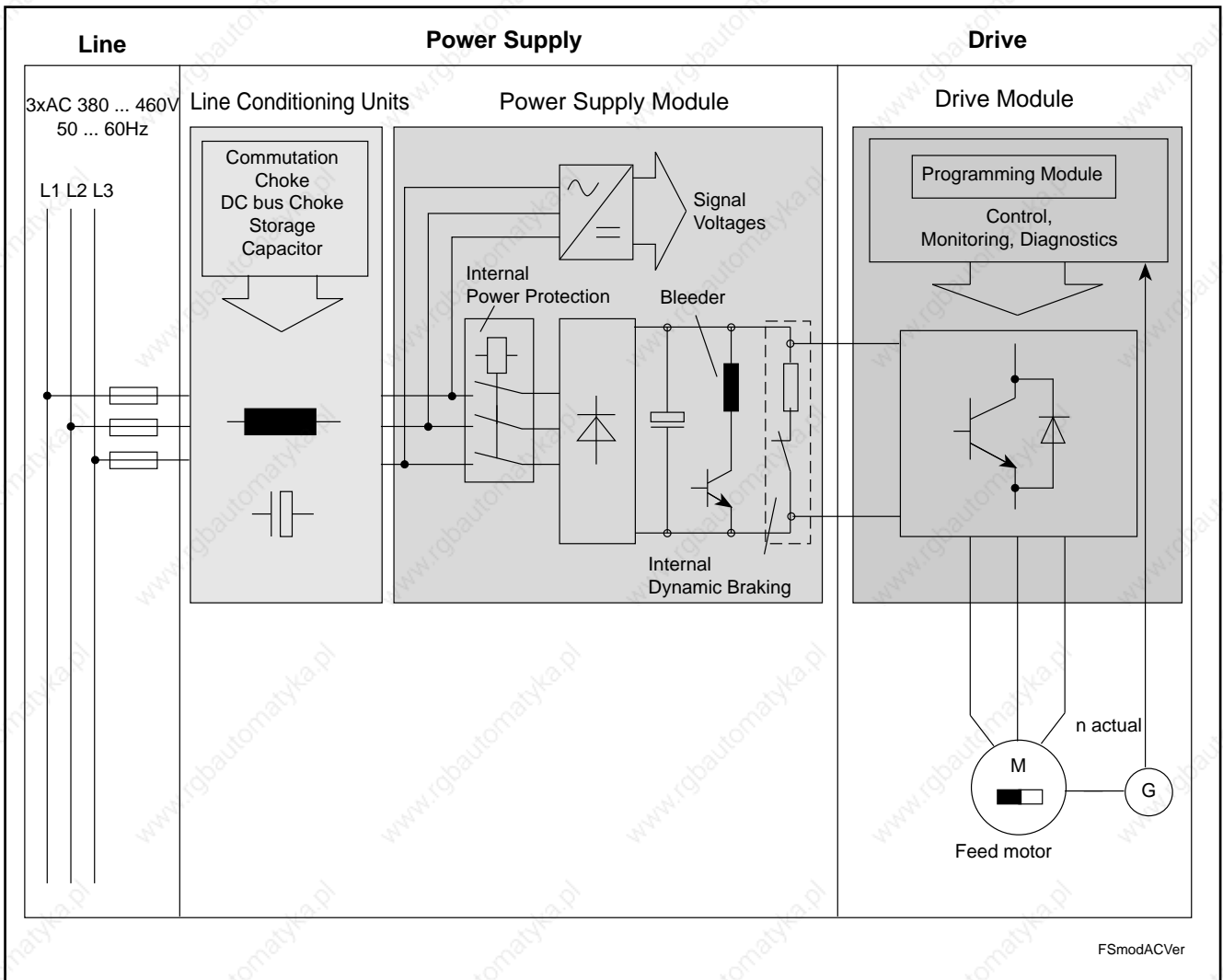

Fig. 1.1. Example of a modular AC drive system.

1.1. Function of the Power Supply Module

The power rectifier in the power supply module converts the AC line voltage and provides a DC bus voltage for supplying power to the drives. When the drives are operating as generators, the regenerated energy is either fed back into the electrical power system or it is absorbed by a bleeder resistor.

The signal voltage is supplied to all the drives via a wire-ribbon cable.

The power supply module is equipped with an extensive array of monitoring functions. It communicates with the drives by means of the wire-ribbon cable. In the event of trouble, the supply of power to the drives is cut off.

2. Applications and Power Characteristics

The power supply modules are designed to be operated with modular INDRAMAT AC drives. Modular AC drives can be used for continuous mechanical power requirements up to 24 kW. The appropriate power supply unit is available for all drive requirements within this power range.

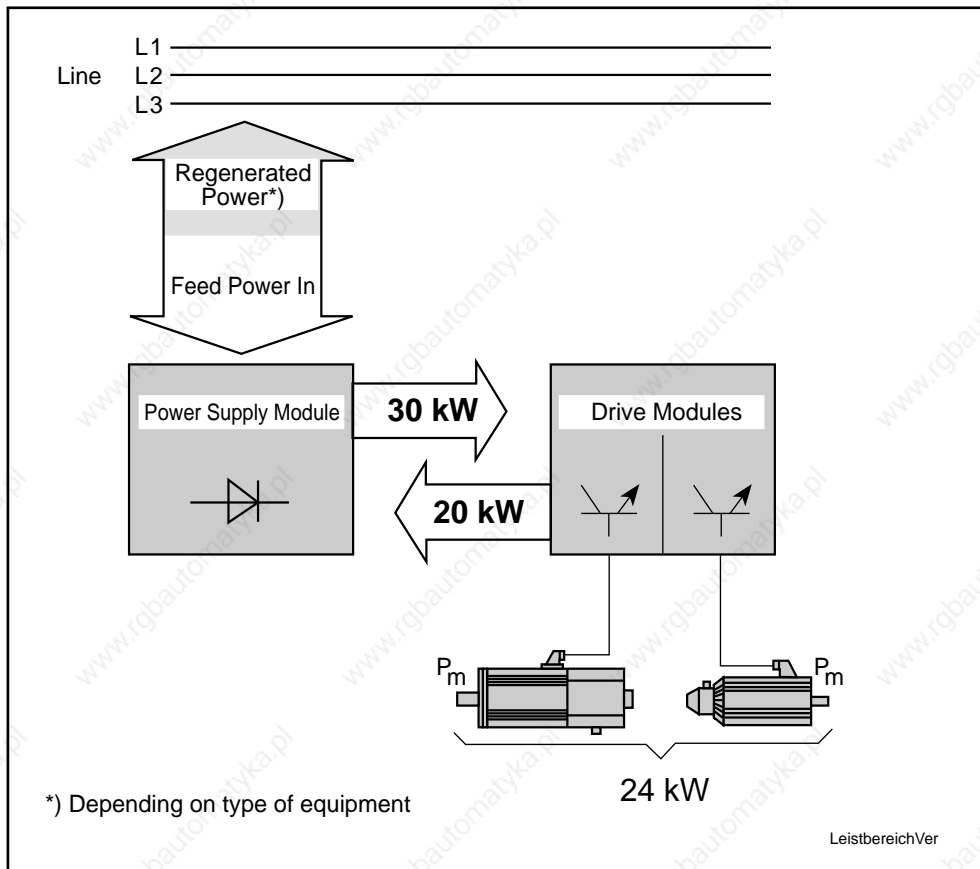

Fig. 2.1. Power ranges of modular drives.

2.1. Selection Data

Output Power		Regen Power		Continuous Mechanical Power	Max. Regen Energy	Line Connection - AC Power Input 3x AC	Power Supply Module				
DC Bus Continuous Power P_{DC}	DC Bus Peak Power P_{KB-03}	Continuous Power P_R	Bleeder Max. Power P_{BM}				Accessories				
				P_m	W_{max}						
							TVM 2.4-50-220/300-W1/.../...				
							Transformer Power		Aux. Bleeder Module		
7,5 kW	60 kW	0,45 kW	10 kW	4,1 kW	14 kW		7,9 kVA		---		
7,5 kW	60 kW	2,25 kW	50 kW	4,1 kW	114 kW	220V	7,9 kVA		TBM 1.2-040-W1/24		
							TVD 1.2-08-3				
							Line Connection Module		Aux. Bleeder Module		
7,5 kW	22,5 kW	0,5 kW	20 kW	6 kW	30 kW	380...460V	NAM 1.2-08		---		
7,5 kW	22,5 kW	1,5 kW	60 kW	6 kW	130 kW		NAM 1.2-08		TBM 1.2-040-W1/24		
							TVD 1.2-15-3				
							Line Connection Module		Aux. Bleeder Module		
15 kW	45 kW	1 kW	40 kW	12 kW	60 kW	380...460V	NAM 1.2-15		---		
15 kW	45 kW	2 kW	80 kW	12 kW	160 kW		NAM 1.2-15		TBM 1.2-040-W1/24		
							TVR 3.1-W015-03				
							DC Bus		Bridge Capacitance Mod.	Commutation Choke	
							Choke	Capacit. Mod.			
15 kW	45 kW	7,5 kW	40 kW	12 kW	60 kW	380...480V	GLD 17	---	---	KD 23	
							KDV 2.3-100-220/300-000				
							DC Bus		Transformer Power		
							Choke	Capacit. Mod.			
15 kW	90 kW	2 kW	40 kW	12 kW	100 kW	220V	GLD 13	---	15,8 kVA		
22 kW	90 kW	2 kW	40 kW	17,6 kW			GLD 12	CZ 1.02	23,1 kVA		
30 kW	90 kW	2 kW	40 kW	24 kW			GLD 12	TCM 1.1-04	31,5 kVA		
							KDV 4.1-30-3				
							DC Bus		Commutation Choke		
							Choke	Capacit. Mod.			
14 kW	48 kW	14 kW	40 kW	11,2 kW	100 kW	380...460V	GLD 14	---	KD 19		
22 kW	48 kW	20 kW	40 kW	17,6 kW			GLD 15	CZ 1.02	KD 20		
30 kW	48 kW	20 kW	40 kW	24 kW			GLD 15	TCM 1.1-04	KD 20		
							KVR 1.2-30-3				
							DC Bus		Bridge Capacitance Mod.	Commutation Choke	
							Choke	Capacit. Mod.			
15 kW	60 kW	10 kW	40 kW	12 kW	100 kW	380...460V	GLD 17	---	---	KD 23	
25 kW	90 kW	13 kW	40 kW	20 kW			GLD 18	---	CZ 1.2 -01-7	KD 24	
30 kW	90 kW	15 kW	40 kW	24 kW			GLD 19	CZ 1.02	TCM 2.1-02-7	KD 25	

Fig. 2.2. Selection Data.

Overview of Functional Characteristics

Power Supply Module	Phase Monitoring	Soft-start	Regen to Line	Braking Upon Power Outage	Dynamic Braking, Internal	Line Protection, Internal	DC Bus Choke
TVM 2.4-50-220/300-W1	---	---	---	With ZK ¹⁾	---	---	---
TVD 1.2-.-3	yes	yes	---	regulated	yes	yes	yes
TVR 3.1-W15-3	yes	yes	yes	regulated	yes	yes	yes
KDV2.3-100-220/300-000	yes	yes	---	regulated	---	---	yes
KDV 4.1-30-3	yes	yes	yes	regulated	---	---	yes
KVR 1.2-30-3	yes	yes	yes	regulated	yes	yes	yes
¹⁾ ZK = Dynamic Braking							

Fig. 2.3. Functional characteristics of the supply modules.

2.2. TVM 2.4 Power Supply Module

Modular power supply for more than one servo drive (typically 6)

Application

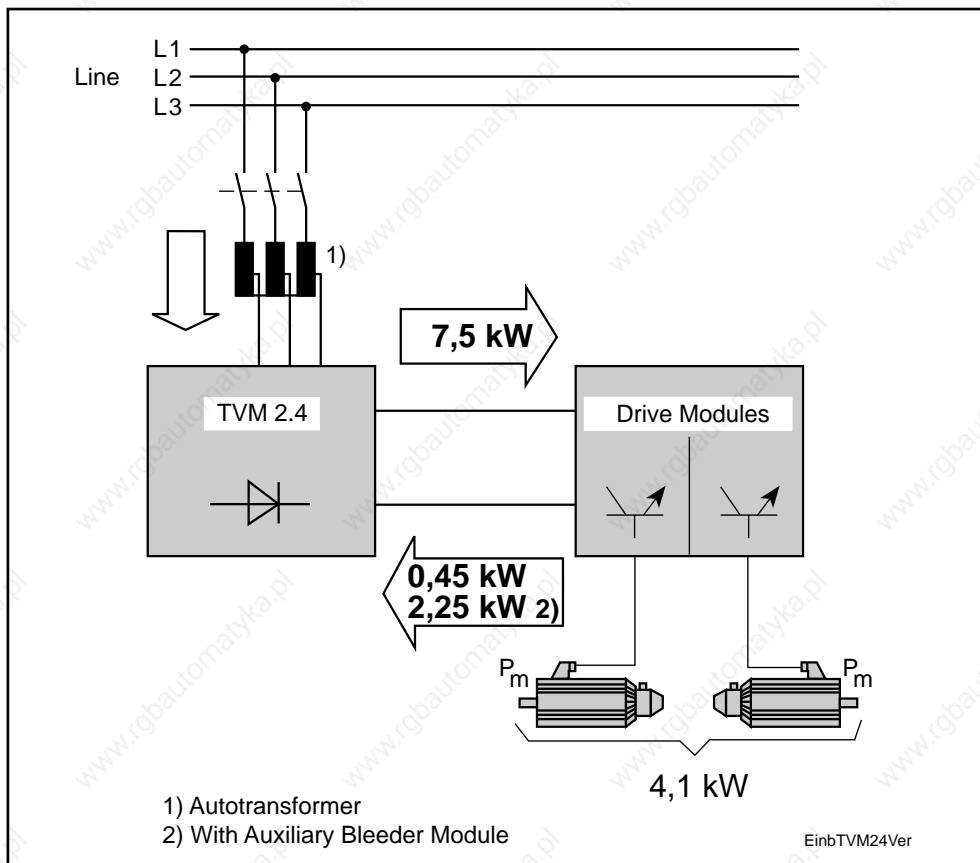

Fig. 2.4. TVM 2.4 service range.

Continuous mechanical power: 4.1 kW

Line voltage: 3 x 220V AC (+/- 15%)
3 x 230V AC (+ 10% /- 15%)

DC bus continuous power: 7.5 kW

Continuous regen power: 450 W
2.25 kW with auxiliary bleeder module

Dimensions

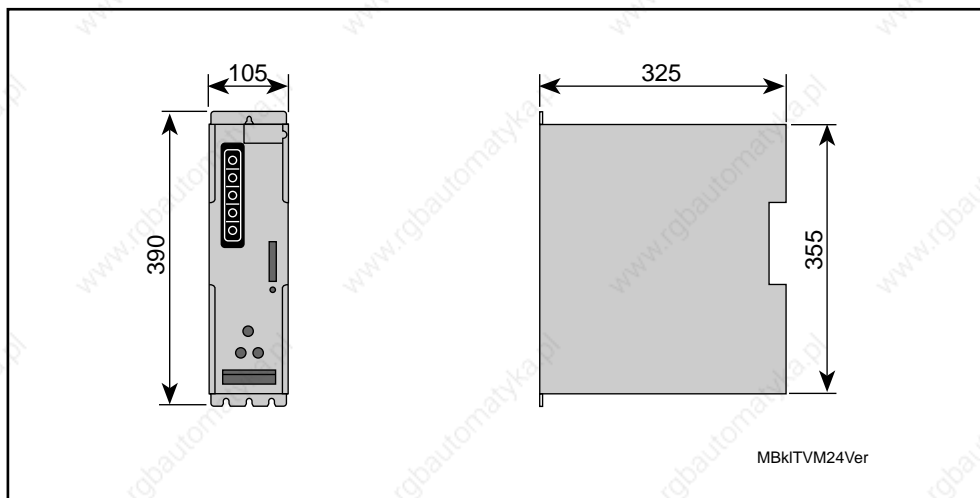

Fig. 2.5. Dimensional drawing of TVM 2.4 power supply module.

Front View

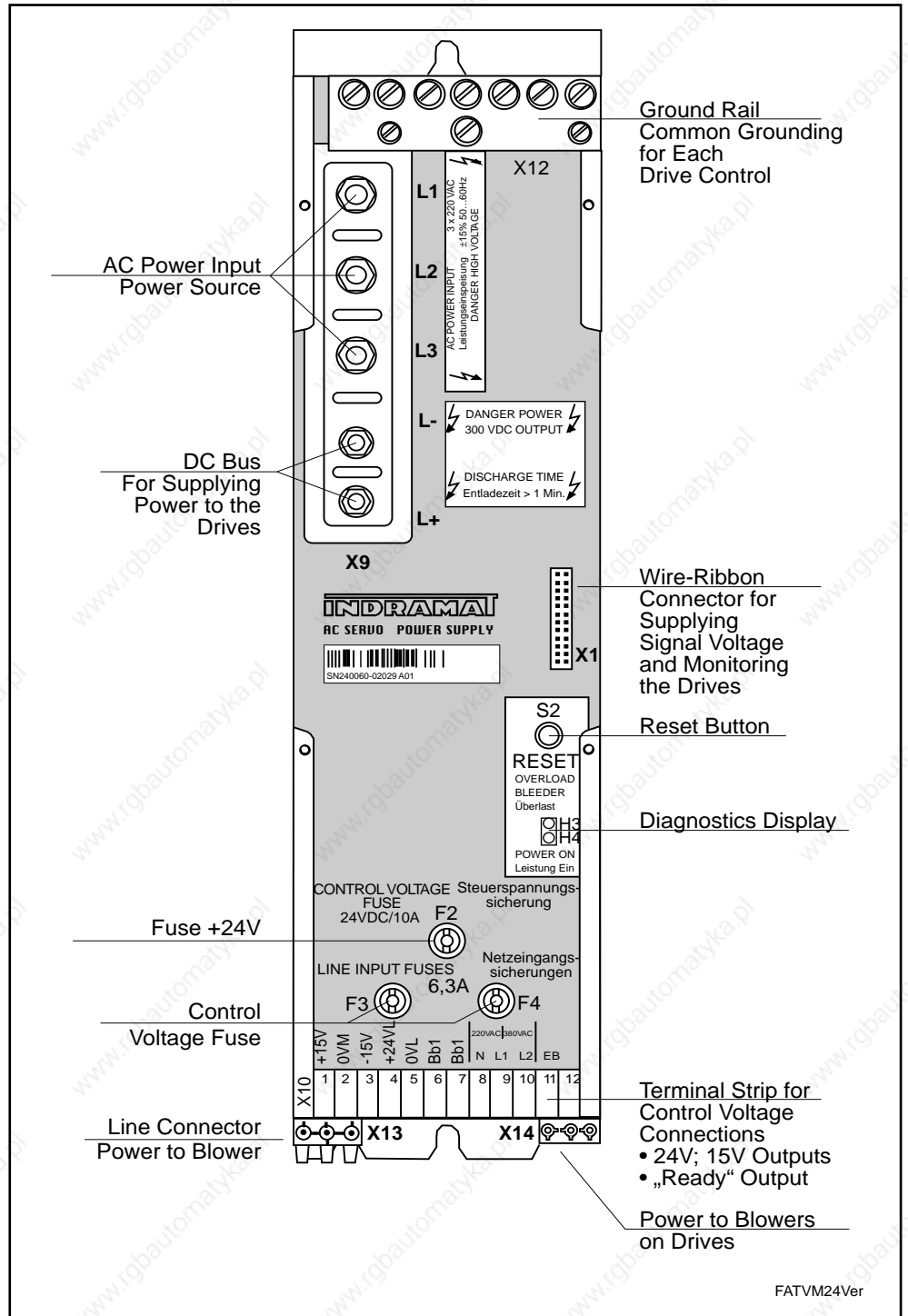

Fig. 2.6. Front view of TVM 2.4 supply module.

*Functional
Characteristics:*

Power Supply The primary application of the TVM is to supply power to servo drives which have a total continuous output (mechanical) of up to 4.1 kW.

In most applications (AC power with ground), the line voltage can be adapted to the TVM connection voltage by means of an autotransformer. The line input connection can be protected with circuit breakers or fuses. Semiconductor fuses are not required.

Regenerated Energy When the drives are running in generator mode, the regenerated energy is absorbed by a bleeder resistor. The TVM may be combined with the TBM 1.2 auxiliary bleeder module to increase the continuous and peak regenerated power rating.

*Auxiliary Capacitance
Modules* TCM 1 Auxiliary Capacitance Modules can be connected to the TVM. When the drives are being braked, the drive energy is stored in the DC bus circuit so that it can be reused for acceleration. Heat losses in the enclosure and energy consumption are therefore minimal. Approximately 30 Ws can be stored per mF auxiliary capacitance.

Dynamic braking A dynamic braking feature can be installed so that motors whose field is produced by a permanent magnet can be braked if a fault occurs in the drive electronic system. If there is trouble in the drive electronic system or in the system installation (feedback line), the dynamic braking feature is activated by the ready-state contact (Bb) on the TVM, causing the drives to brake to a stop.

*Supply of Power to the
Electronic Circuits* The signal voltage is supplied to all drives via a wire-ribbon cable.

Monitoring Functions The TVM is equipped with an extensive range of monitoring functions. It communicates with the drives by means of the wire-ribbon cable. Monitored parameters include: motor feedback, current and temperature of the drives, and the load on the bleeder resistor.

If trouble is encountered, the ready-state contact (Bb) on the TVM causes the power supplied to the drives to be shut off immediately.

LED displays provide for rapid trouble shooting.

2.3. TVD 1.2 Power Supply Module

Modular power supply for more than one servo drive (typically 10)

Application

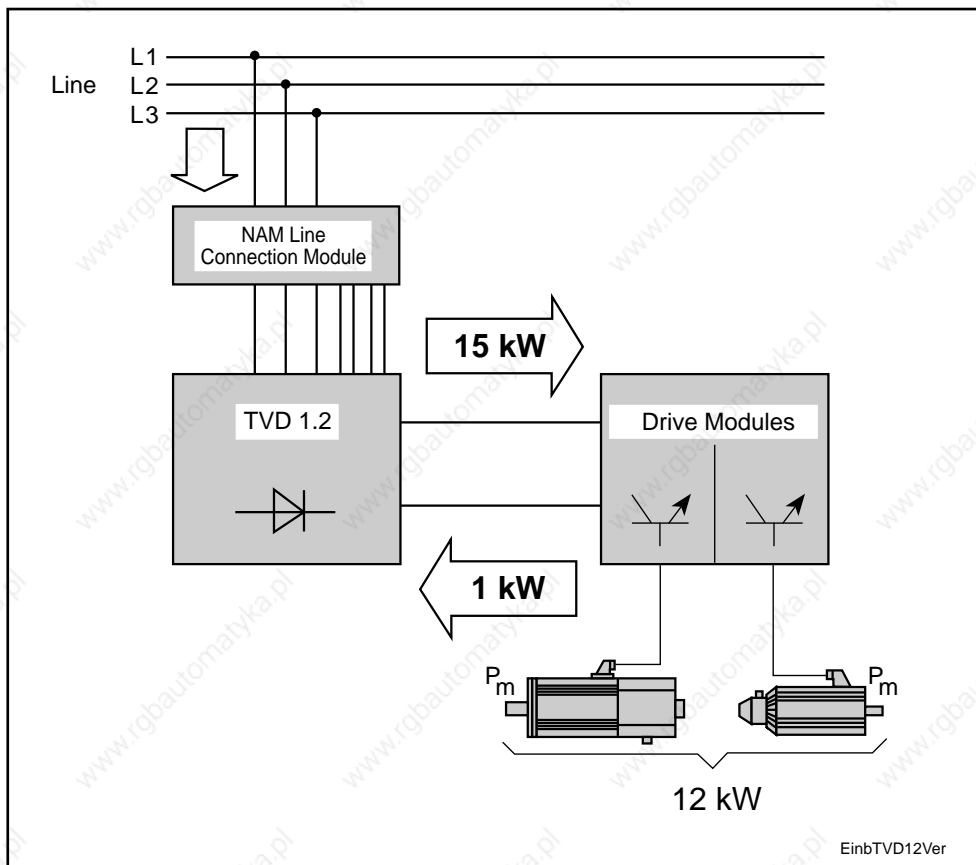

Fig. 2.7. TVD 1.2 service range.

Continuous mechanical power: 6 kW ③ TVD 1.2-08
 12 kW ③ TVD 1.2-15

Line voltage: 3 x 380...460V AC (± 10%)

DC bus continuous power: 7.5 kW ③ TVD 1.2-08
 15 kW ③ TVD 1.2-15

Continuous regen power: 0.5 kW ③ TVD 1.2-08
 1.0 kW ③ TVD 1.2-15

Dimensions

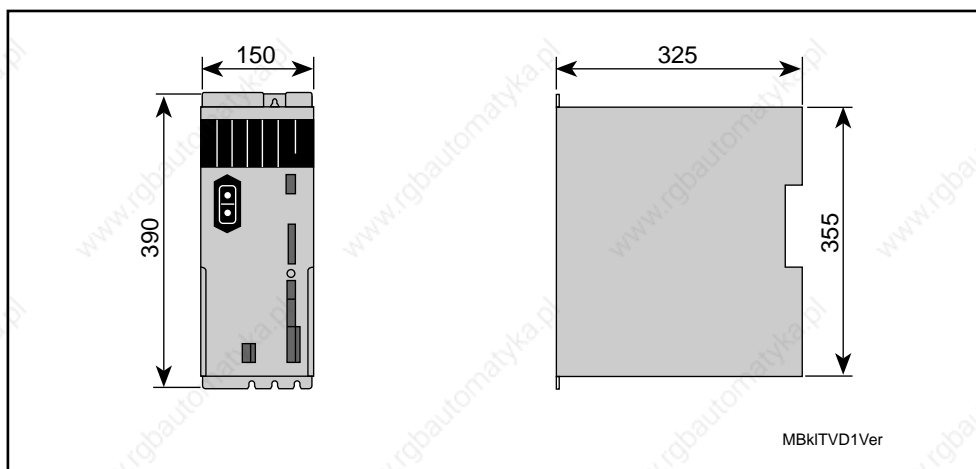

Fig. 2.8. Dimensional drawing of TVD 1.2 power supply module.

Front View

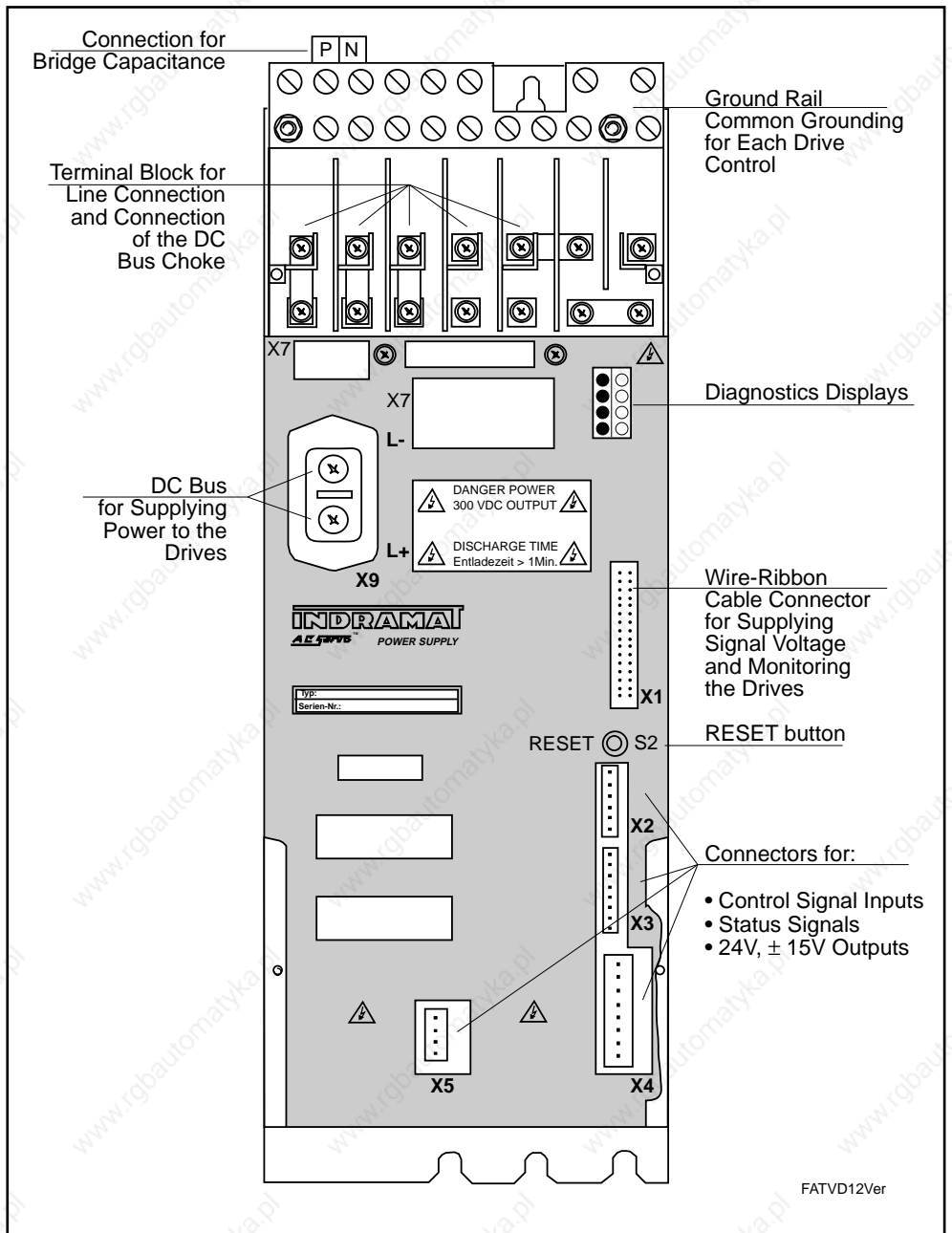

Fig. 2.9. Front view of TVD 1.2 supply module.

Functional Characteristics:

- AC Power Input** The TVD is available in two power levels. It can be used to supply power to main and servo drives having an overall continuous mechanical power output of either 6 kW or 12 kW.
- Direct Connection to Line Power** The TVD can be connected directly to 380 ... 460 V, 50 ... 60 Hz three-phase power systems without the need for transformers. A power protection circuit is built in to isolate the drive equipment from the AC power system.
- Soft-start** A soft-start circuit in the TVD prevents high inrush current spikes so that the line connection protection devices do not need to be oversized. Line connections can be protected by circuit breakers or slow-blow fuses. Semiconductor-type circuit protection devices are not needed.
- Regulated DC Bus** The TVD DC bus voltage is regulated so that variations in the line voltage have no effect on drive dynamics. In many cases this permits higher drive speeds to be achieved.
- Line Reaction** The TVD is always operated with a line filter. Thus, it causes virtually no line reaction. The NAM line conditioning module makes the TVD and the necessary filter components easy to install.
- Regenerated Power** When the drives are running in generator mode, the regenerated energy is absorbed by a bleeder resistor. The TVD may be combined with the TBM 1.2 Auxiliary Bleeder Module to increase the continuous and peak regenerated power rating.
- Auxiliary Capacitance Modules** TCM 1 Auxiliary Capacitance Modules can be connected to the TVD. When the drives are being braked, the drive energy is stored in the DC bus so that it can be reused for acceleration. Heat losses in the enclosure and energy consumption are therefore minimal. Approximately 30 Ws can be stored per mF auxiliary capacitance.
- Dynamic braking** A dynamic braking feature is provided on the TVD so that motors whose field is produced by a permanent magnet can even be braked if a fault occurs in the drive electronic system. If there is trouble in the drive electronic system or in the system installation (feedback line), the dynamic braking feature is activated by the ready-state contact (Bb) on the TVD, causing the drives to brake to a stop.
- Supply of Power to the Electronic Circuits** The signal voltage is supplied to all drives via a wire-ribbon cable. In the event of a power failure, the electronic circuitry is supplied with power from the DC bus. The drives can therefore be stopped under velocity or position regulation when power failures occur. The line connections for supplying power to the drives and to electronic circuits are jumpered on the unit. Thus, an additional line connection for supplying power to the electronic circuits is not required.
- Monitoring Functions** The TVD is equipped with an extensive range of monitoring functions. It communicates with the drives by means of the wire-ribbon cable. Monitored parameters include: motor feedback, current and temperature of the drives, the load on the bleeder resistor, and line voltage. If trouble is encountered, the ready-state contact on the TVD causes the power supplied to the drives to be shut off immediately. LED displays provide for rapid trouble shooting.

2.4. TVR 3.1 Power Supply Module

Modular power supply for multiple main and servo drives (typically 10)

Application

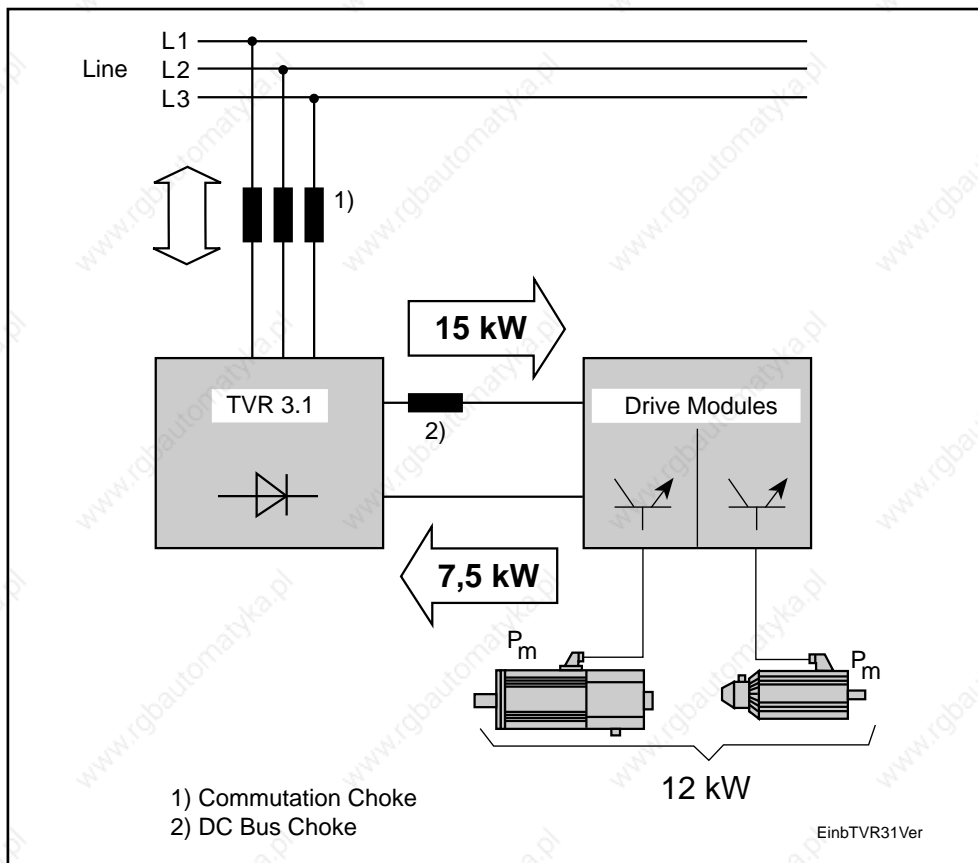

Fig. 2.10. TVR 3.1 service range.

Continuous mechanical power: 12 kW

Line voltage: 3 x 380...480 V AC (± 10 %)

DC bus continuous power: 15 kW

Continuous regen power: 7.5 kW

Dimensions

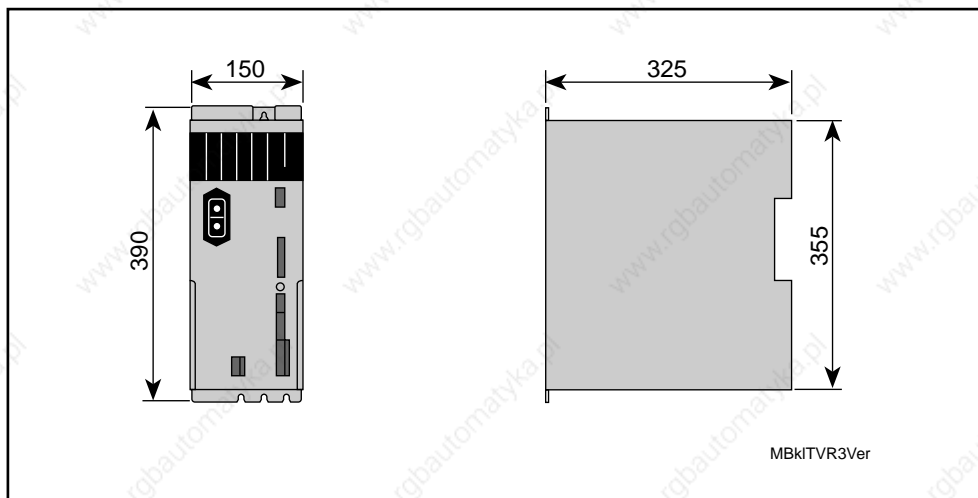

Fig. 2.11. Dimensional drawing of TVR 3.1 power supply module.

Front View

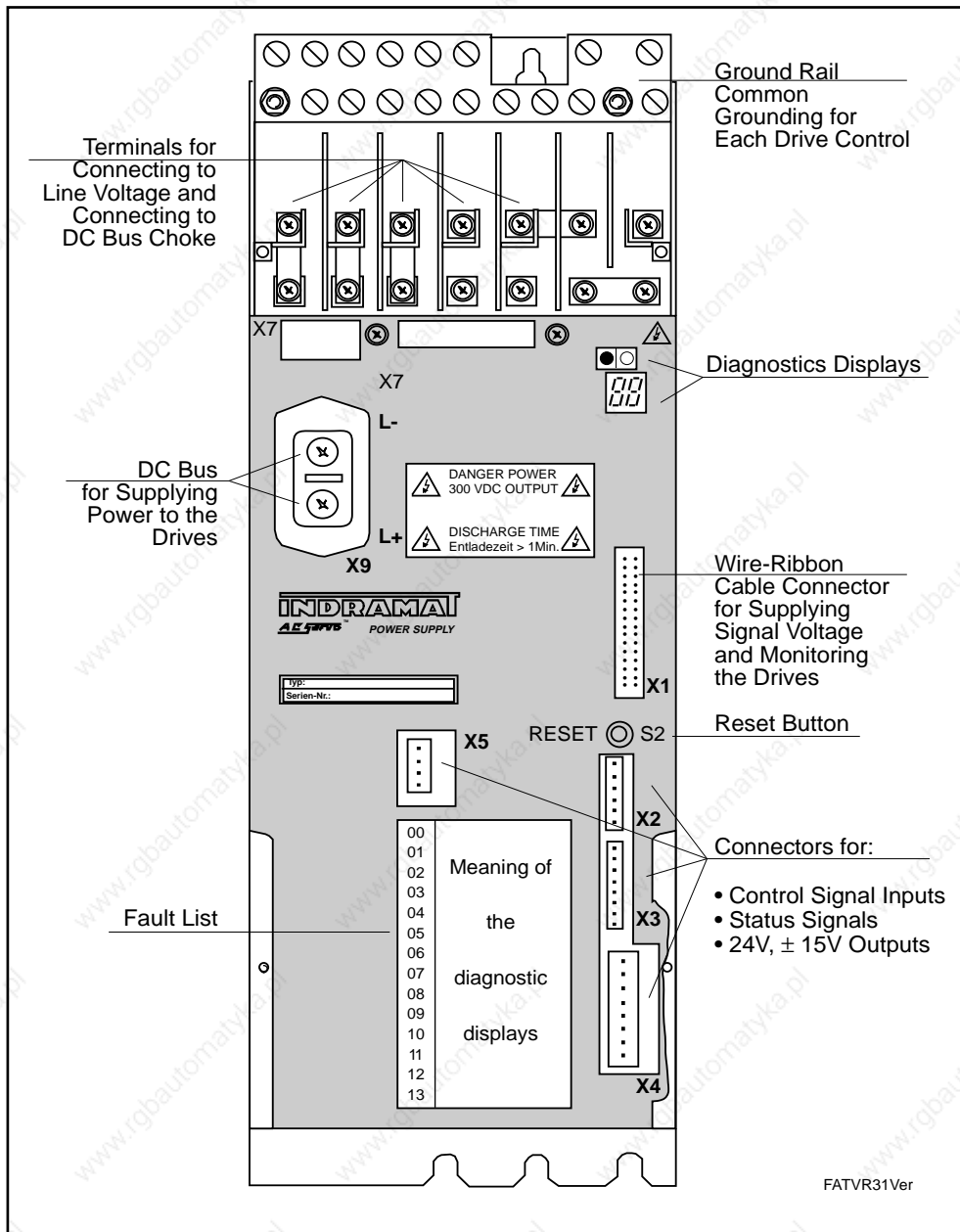

Fig. 2.12. Front view of TVR 3.1 supply module.

Functional Characteristics:

<i>AC Power Input</i>	The TVR 3.1 can be used to supply power to main and servo drives having an overall continuous mechanical power output of up to 12 kW.
<i>Direct Connection to Line Power</i>	The TVR 3.1 can be connected directly to 380 ... 460 V, 50 ... 60 Hz three-phase power systems without the need for transformers. A power protection circuit is built in to isolate the drive equipment from the AC power system.
<i>Soft-start</i>	A soft-start circuit in the TVR 3.1 prevents high inrush current spikes so that the line connection protection devices do not need to be oversized. Line connections can be protected by circuit breakers or slow-blow fuses. Semiconductor-type circuit protection devices are not needed.
<i>Regulated DC Bus</i>	The TVR DC bus voltage is regulated so that variations in the line voltage have no effect on drive dynamics. In many cases, this permits higher drive speeds to be achieved.
<i>Line Reaction</i>	The TVR always operates with a line filter in use. Thus, it causes virtually no line reaction.
<i>Regenerated Power</i>	When the drives are running in generator mode, the energy from the drives is regenerated to the AC power system with low losses. In order to permit continued braking in the event of line trouble or outages, the TVR 3.1 is provided with a bleeder resistor as standard equipment. Thus a delayed power shutoff is not necessary in the event of an emergency stop.
<i>Auxiliary Capacitance Modules</i>	Auxiliary Capacitance Modules can be connected to the TVR. These units store energy in the DC bus and can be used, for example, to perform a retraction move in the event of a power failure.
<i>Dynamic braking</i>	A dynamic braking feature is provided on the TVR so that motors whose field is produced by a permanent magnet can even be braked if a fault occurs in the drive electronic system. If there is trouble in the drive electronic system or in the system installation (feedback line), the dynamic braking feature is activated by the ready-state contact (Bb) on the TVR, causing the drives to brake to a stop.
<i>Supply of Power to the Electronic Circuits</i>	The signal voltage is supplied to all drives via a wire-ribbon cable. In the event of a power failure, the electronic circuitry is supplied with power from the DC bus. The drives can therefore be stopped under velocity or position regulation when power failures occur.
<i>Monitoring Functions</i>	The TVR is equipped with an extensive range of monitoring functions. It communicates with the drives by means of the wire-ribbon cable. Monitored parameters include: motor feedback, current and temperature of the drives, the load on the bleeder resistor, and line voltage. If trouble is encountered, the ready-state contact (Bb) on the TVR causes the power supplied to the drives to be shut off immediately. LED displays provide for rapid trouble shooting.

2.5. KDV 2.3 Power Supply Module

Modular power supply for multiple main and servo drives (typically 10)

Application

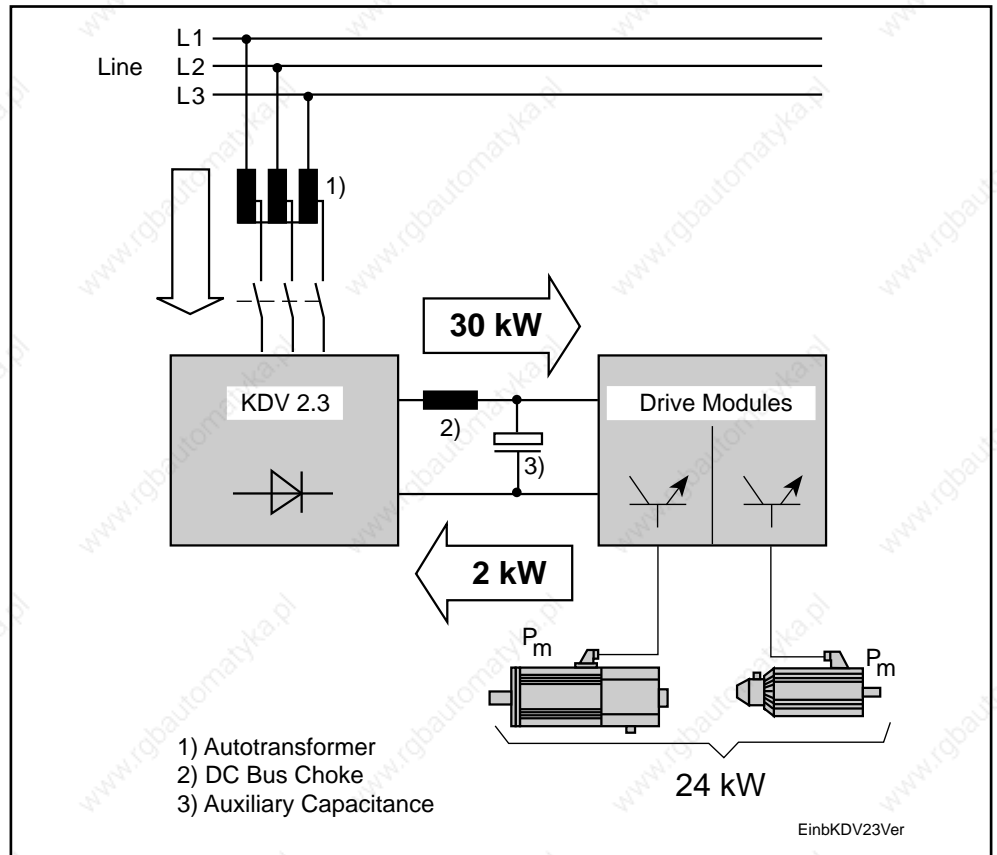

Fig. 2.13. KDV 2.3 service range.

Continuous mechanical power: 24 kW

Line voltage: 3 x 220 V AC (+15% / -10%)
3 x 230 V AC (+10% / -15%)

DC bus continuous power: 30 kW

Continuous regen power: 2 kW

Dimensions

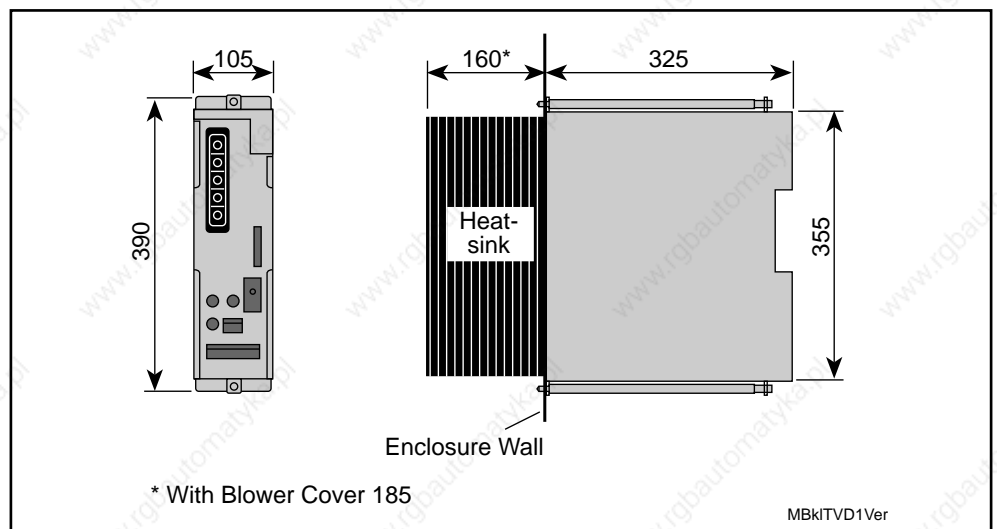

Fig. 2.14. Dimensional drawing of KDV 2.3 power supply module.

Front View

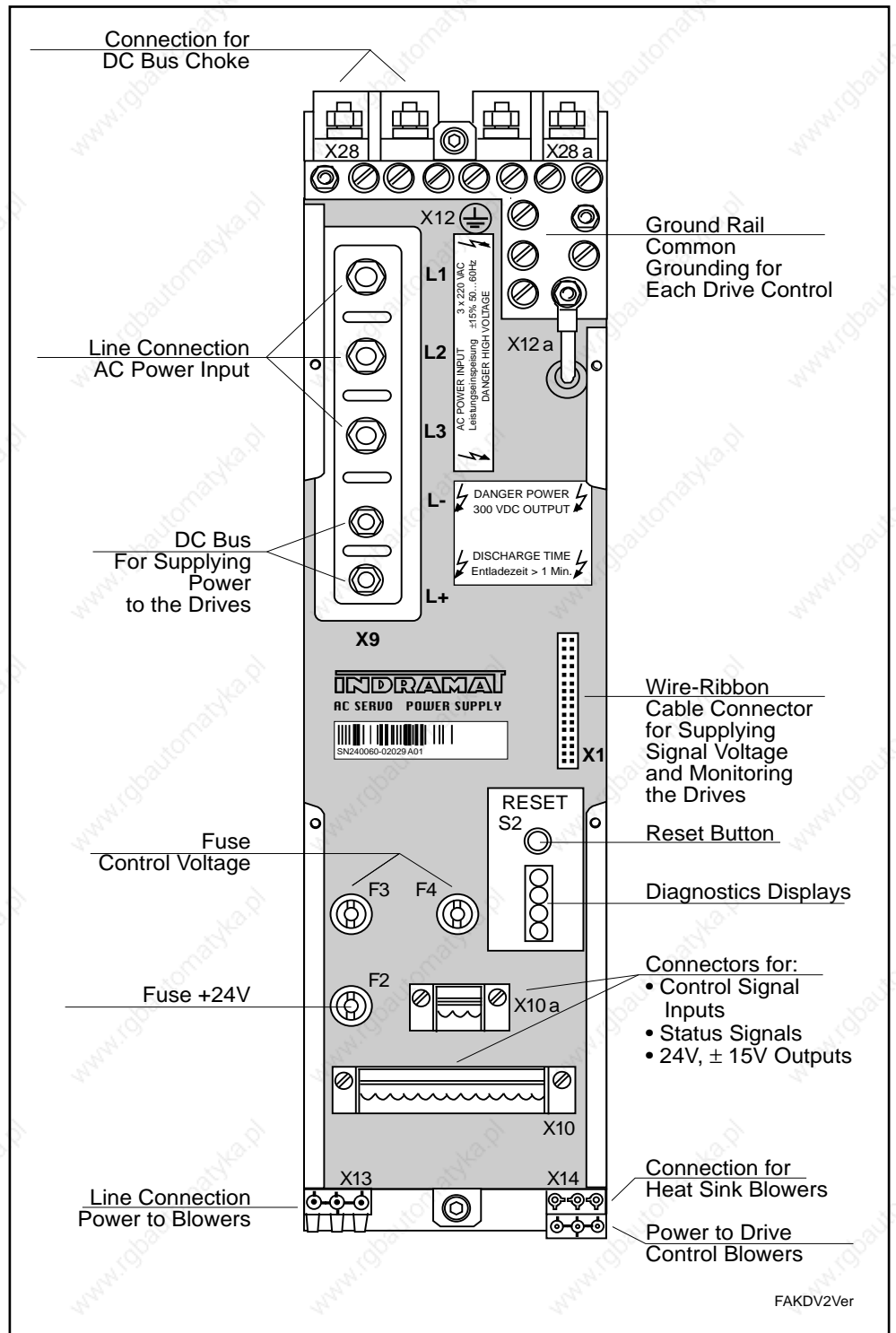

Fig. 2.15. Front view of KDV 2.3 supply module.

Functional Characteristics:

AC Power Input The KDV 2.3 can be used to supply power to main and servo drives having an overall continuous mechanical power output of up to 24 kW. The actual effective output depends on the smoothing and commutation chokes, auxiliary capacitance modules and transformers used with the power supply. This permits the unit to be adapted to meet the needs of the given application.

In many applications (AC power system with ground) the KDV 2.3 power supply can be adapted to the line voltage by using an autotransformer.

Heat Losses in the Enclosure:

The KDV 2.3 achieves a high continuous output with low heat losses in the enclosure. The unit is designed to be installed with the heatsink extending through an opening in the back panel of the enclosure. Only about 20% of the total heat loss remains in the enclosure. The installation kit provided with the unit can be used to seal off the opening to achieve an IP 65 protection classification.

The costs of enclosing ventilation and cooling are significantly reduced when K-series power supplies are used.

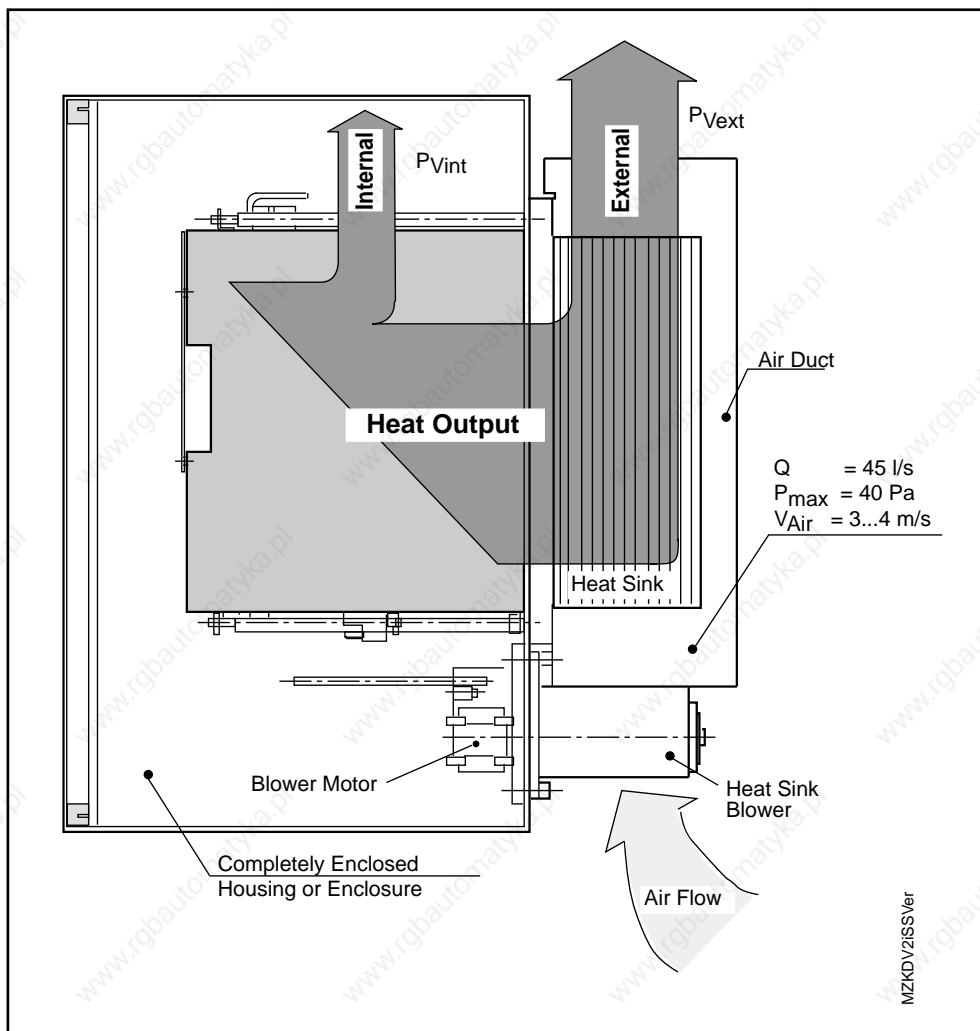

Fig. 2.16. Installation of KDV power supply modules in enclosures.

Soft-start A soft-start circuit in the KDV 2.3 prevents high inrush current spikes so that the line connection protection devices do not need to be oversized. Line connections can be protected by circuit breakers or slow-blow fuses. Semiconductor-type circuit protection devices are not needed.

Regenerated Power When the drives are running in generator mode, the energy from the drives is absorbed by a bleeder resistor.

Auxiliary Capacitance Modules Auxiliary Capacitance Modules can be connected to the KDV 2.3 for applications in which it must produce a maximum continuous output. With 14 ... 22 kW, a 2-mF auxiliary capacitance module is used. With 22 ... 30 kW, a 4-mF auxiliary capacitance module is used.

These units store energy from the DC bus and can be used, for example, to perform a retraction move in the event of a power failure.

Dynamic braking A dynamic braking feature can be installed on the TVR so that motors whose field is produced by a permanent magnet can even be braked if a fault occurs in the drive electronic system. If there is trouble in the drive electronic system or in the system installation (feedback line), the dynamic braking feature is activated by the ready-state contact (Bb) on the KDV 2.3, causing the drives to brake to a stop.

Supply of Power to the Electronic Circuits The signal voltage is supplied to all drives via a wire-ribbon cable. In the event of a power failure, the electronic circuitry is supplied with power from the DC bus. The drives can therefore be stopped under velocity or position regulation when power failures occur.

Monitoring Functions The KDV 2.3 is equipped with an extensive range of monitoring functions. It communicates with the drives by means of the wire-ribbon cable. Monitored parameters include: motor feedback, current and temperature of the drives, the load on the bleeder resistor, and line voltage.

If trouble is encountered, the ready-state contact (Bb) on the KDV 2.3 causes the power supplied to the drives to be shut off immediately.

LED displays provide for rapid trouble shooting.

2.6. KDV 4.1 Power Supply Module

Modular power supply for multiple main and servo drives (typically 10)

Application

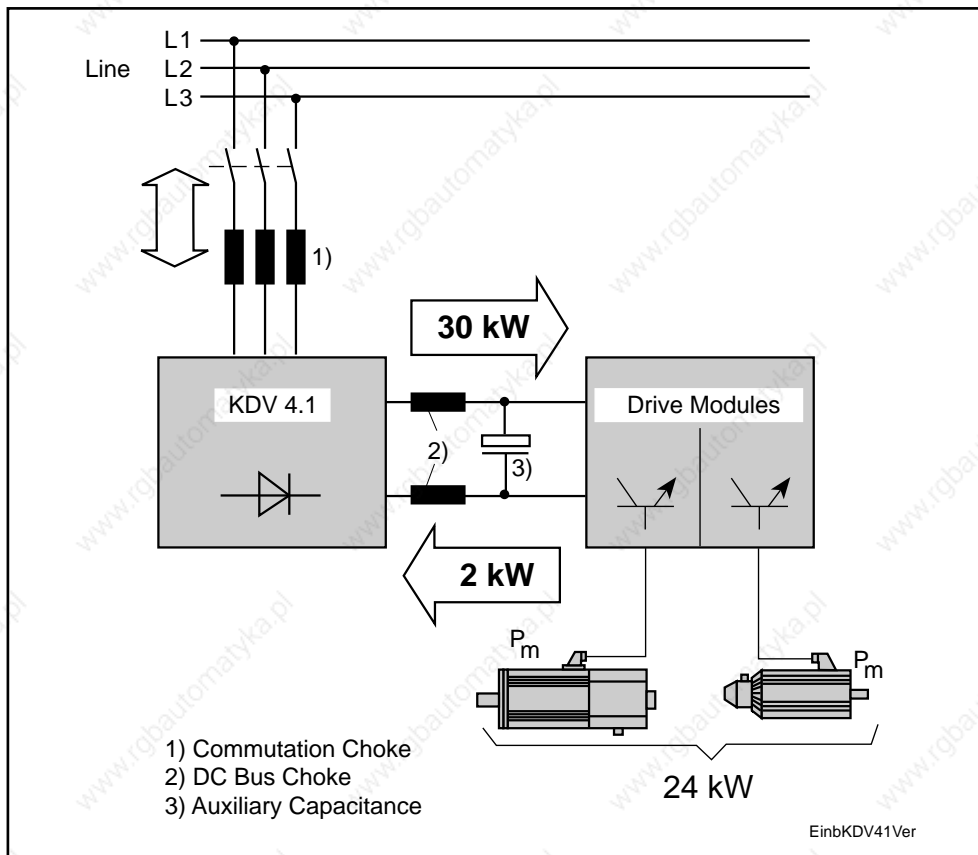

Fig. 2.17. KDV 4.1 service range.

Continuous mechanical power: 24 kW

Line voltage: 3 x 380 ... 460 V AC ($\pm 10\%$)

DC bus continuous power: 30 kW

Continuous regen power: 20 kW

Dimensions

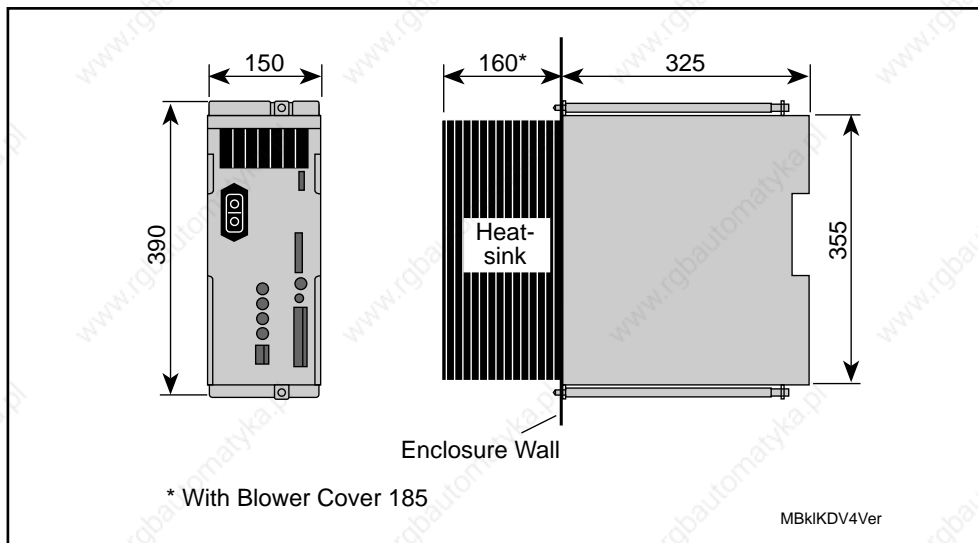

Fig. 2.18. Dimensional drawing of KDV 4.1 power supply module.

Front View

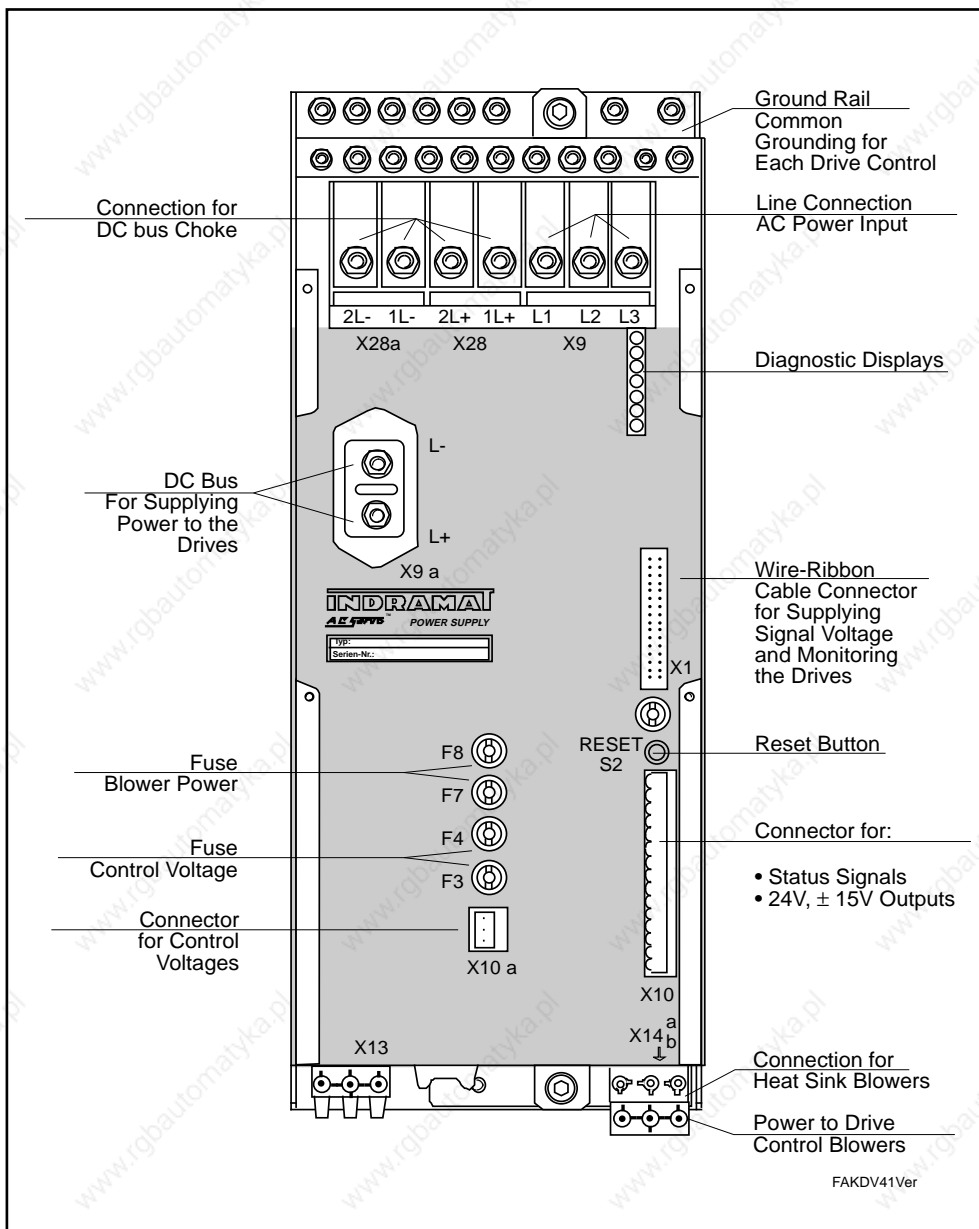

Fig. 2.19. Front view of KDV 4.1 supply module.

Functional Characteristics:

- AC Power Input** The KDV 4.1 can be used to supply power to main and servo drives having an overall continuous mechanical power output of up to 24 kW. The actual effective output depends on the smoothing and commutation chokes, auxiliary capacitance modules and transformers used with the power supply. This permits the unit to be adapted to meet the needs of the given application.
- Direct Connection to Line Voltage** The unit can be connected directly to 380 ... 460 V, 50 ... 60 Hz three-phase power systems without using transformers.
- Heat Losses in the Enclosure:** The KDV 4.1 achieves a high continuous output with low heat losses in the enclosure. The unit is designed to be installed with the heatsink extending through an opening in the back panel of the enclosure. Only about 20% of the total heat loss remains in the enclosure. The installation set provided with the unit can be used to seal off the opening to achieve an IP 65 protection classification. The costs of enclosing ventilation and cooling are significantly reduced when K-series power supplies are used. (See Fig. 2.16.)
- Soft-start** A soft-start circuit in the KDV 4.1 prevents high inrush current spikes so that the line connection protection devices do not need to be oversized. Line connections can be protected by circuit breakers or slow-blow fuses. Semiconductor-type circuit protection devices are not needed.
- Regulated DC Bus** The KDV 4.1 DC bus voltage is regulated so that variations in the line voltage have no effect on drive dynamics. In many cases, this permits higher drive speeds to be achieved.
- Regenerated Power** When the drives are running in generator mode, the energy from the drives is regenerated to the AC power system with low losses.
- In order to permit the braking in the event of line trouble or outages, the KDV 4.1 is provided with a bleeder resistor as standard equipment. Thus a delayed power shutoff is not necessary in the event of an emergency stop.
- Auxiliary Capacitance Modules** Auxiliary Capacitance Modules can be connected to the KDV 4.1 for applications in which it must produce a maximum continuous output. With 14 ... 22 kW, a 2-mF auxiliary capacitance module is used. With 22 ... 30 kW, a 4-mF auxiliary capacitance module is used.
- These units store energy in the DC bus and can be used, for example, to perform a retraction move in the event of a power failure.
- Dynamic braking** A dynamic braking feature can be connected to the KDV so that motors whose field is produced by a permanent magnet can even be braked if a fault occurs in the drive electronic system. If there is trouble in the drive electronic system or in the system installation (feedback line), the dynamic braking feature is activated by the ready-state contact (Bb) on the KDV 4.1, causing the drives to brake to a stop.

Supply of Power to the Electronic Circuits

The signal voltage is supplied to all drives via a wire-ribbon cable. In the event of a power failure, the electronic circuitry is supplied with power from the DC bus. The drives can therefore be stopped in a controlled manner when power failures occur.

Monitoring Functions

The KDV 4.1 is equipped with an extensive range of monitoring functions. It communicates with the drives by means of the wire-ribbon cable. Monitored parameters include: motor feedback, current and temperature of the drives, the load on the bleeder resistor, and line voltage.

If trouble is encountered, the ready-state contact on the KDV 4.1 causes the power supplied to the drives to be shut off immediately.

LED displays provide for rapid trouble shooting.

2.7. KVR 1.2 Power Supply Module

Modular power supply for multiple main and servo drives (typically 10)

Application

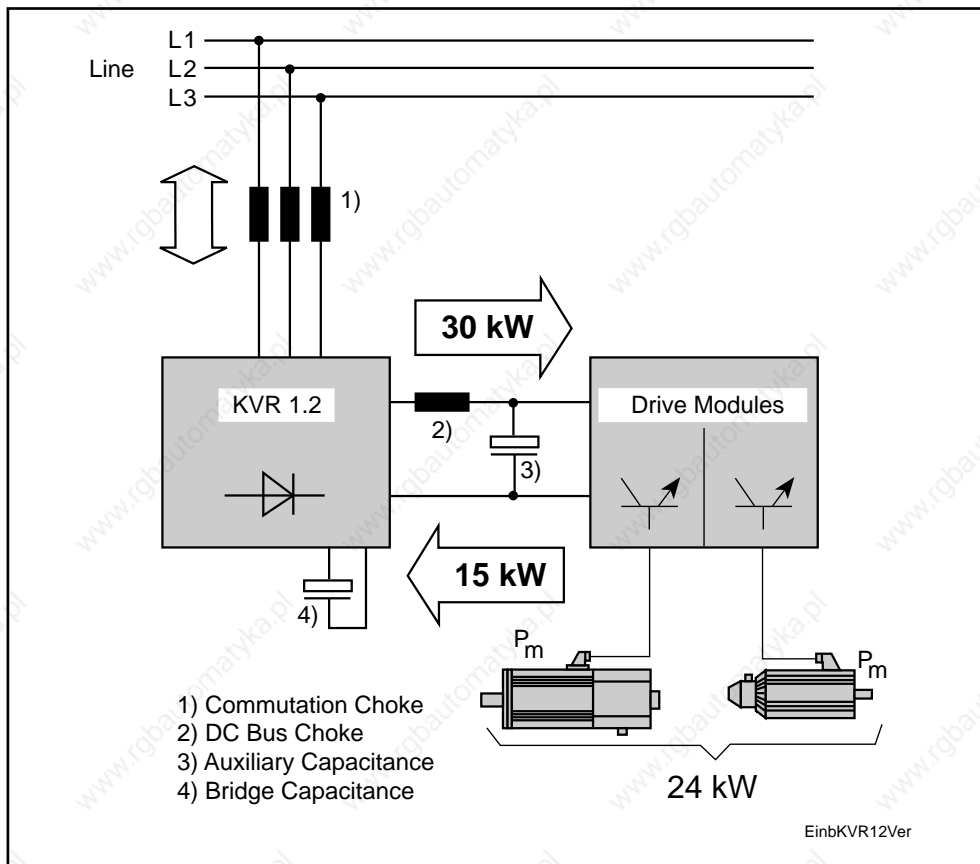

Fig. 2.20. KVR 1.2 service range.

Continuous mechanical power:	24 kW
Line voltage:	3 x 380 ... 460 V AC ($\pm 10\%$)
DC bus continuous power:	30 kW
Continuous regen power:	15 kW

Dimensions

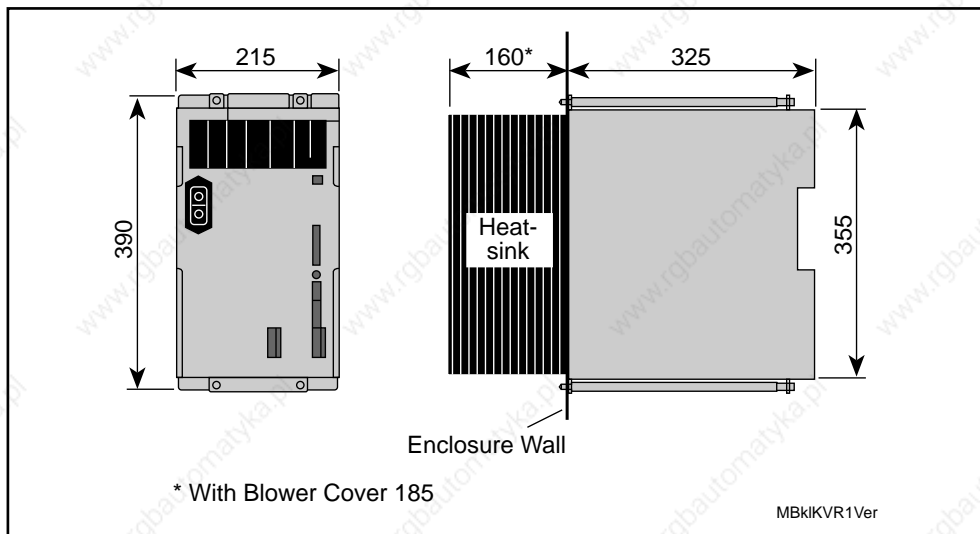

Fig. 2.21. Dimensional drawing of KVR 1.2 power supply module.

Front View

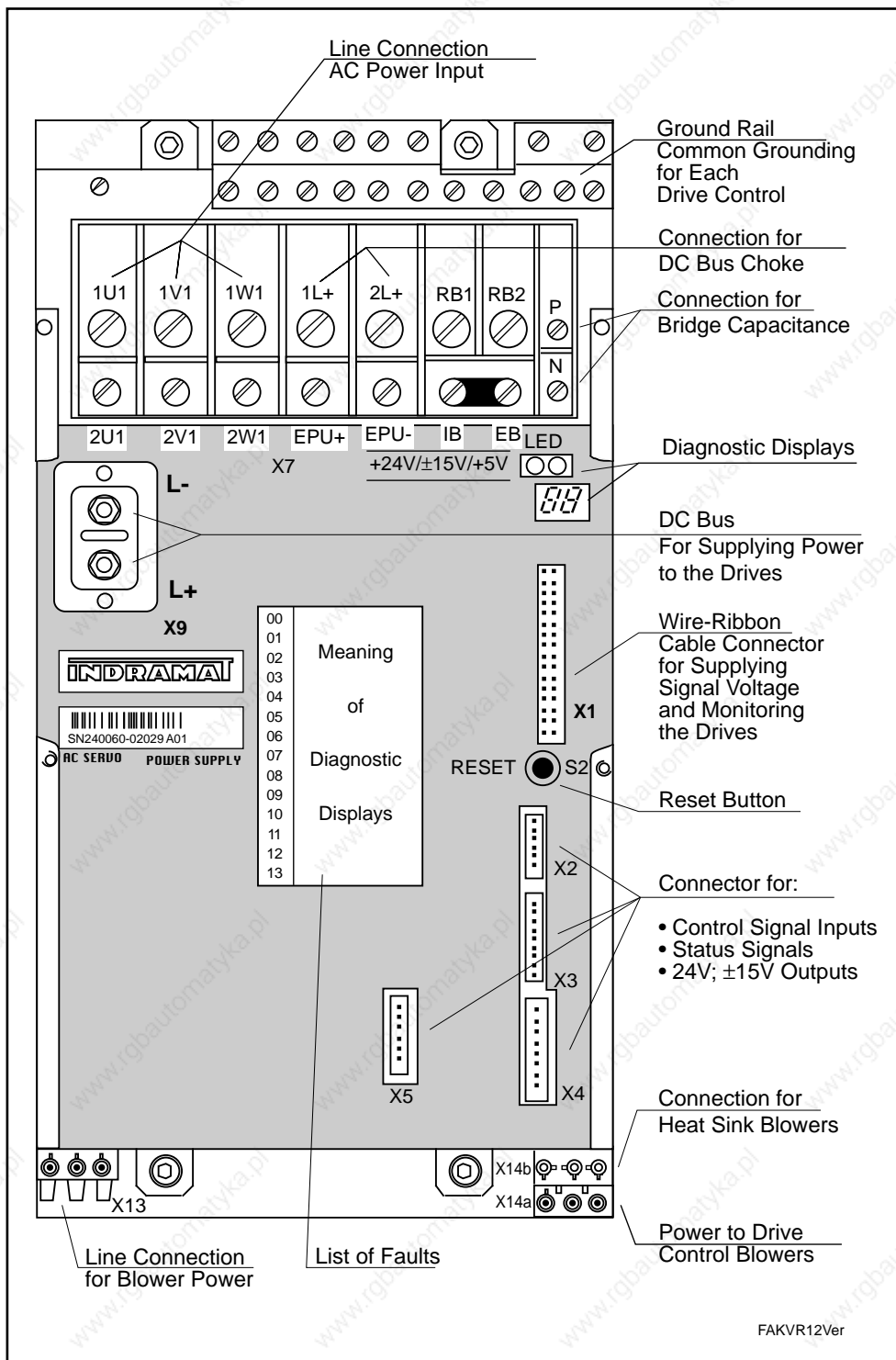

Fig. 2.22. Front view of KVR 1.2 supply module.

Functional Characteristics:

- AC Power Input** The KVR 1.2 can be used to supply power to main and servo drives having an overall continuous mechanical power output of up to 24 kW. The actual effective output depends on the smoothing and commutation chokes, auxiliary capacitance modules and transformers used with the power supply. This permits the unit to be adapted to meet the needs of the given application.
- Direct Connection to Line Voltage** The KVR 1.2 can be connected directly to 380 ... 460 V, 50 ... 60 Hz three-phase power systems without using transformers. A power protection device to isolate the drive equipment from the AC power system is built in.
- Heat Losses in the Enclosure:** The KVR 1.2 achieves a high continuous output with low heat losses in the enclosure. The unit is designed to be installed with the heatsink extending through an opening in the back panel of the enclosure. Only about 20% of the total heat loss remains in the enclosure. The installation kit provided with the unit can be used to seal off the opening to achieve an IP 65 protection classification. The costs of enclosing ventilation and cooling are significantly reduced when K-series power supplies are used. (See Fig. 2.16.)
- Soft-start** A soft-start circuit in the KVR 1.2 prevents high inrush current spikes so that the line connection protection devices do not need to be oversized. Line connections can be protected by circuit breakers or slow-blow fuses. Semiconductor-type circuit protection devices are not needed.
- Regulated DC Bus** The KVR DC bus voltage is regulated so that variations in the line voltage have no effect on drive dynamics. In many cases, this permits higher drive speeds to be achieved.
- Line Reaction** When used in combination with the chokes and capacitance modules supplied with the unit, the KVR operates without causing significant line reaction.
- Regenerated Power** When the drives are running in generator mode, the energy from the drives is returned to the AC power system with low losses.
- In order to permit the braking in the event of line trouble or outages, the KVR 1.2 is provided with a bleeder resistor as standard equipment. Thus, a delayed power shutoff is not necessary in the event of an emergency stop.
- Auxiliary Capacitance Modules** Auxiliary Capacitance Modules can be connected to the KVR 1.2 for applications which require the maximum continuous DC bus output. With 25 ... 30 kW, a 2-mF auxiliary capacitance module is used.
- These units store energy in the DC bus and can be used, for example, to perform a retraction move in the event of a power failure.
- Dynamic braking** An dynamic braking feature can be connected to the KVR so that motors whose field is produced by a permanent magnet can even be braked if a fault occurs in the drive electronic system. If there is trouble in the drive electronic system or in the system installation (feedback line), the dynamic braking feature is activated by the ready-state contact (Bb) on the KVR, causing the drives to brake to a stop.

Supply of Power to the Electronic Circuits

The signal voltage is supplied to all drives via a wire-ribbon cable. In the event of a power failure, the electronic circuitry is supplied with power from the DC bus. The drives can therefore be stopped in a controlled manner when power failures occur.

Monitoring Functions

The KVR 1.2 is equipped with an extensive range of monitoring functions. It communicates with the drives by means of the wire-ribbon cable. Monitored parameters include: motor feedback, current and temperature of the drives, the load on the bleeder resistor, and line voltage.

If trouble is encountered, the ready-state contact (Bb) on the KVR 1.2 causes the power supplied to the drives to be shut off immediately.

LED displays provide for rapid trouble shooting.

3. Calculations and Selecting the Correct Power Supply

The power supply for an AC drive system consists mainly of the power supply module. Additional transformers, chokes, auxiliary capacitance modules and bleeder modules may be used depending on the purpose for which the drives are being used, the design of the power supply module and the service conditions.

The power supply must provide the DC bus continuous power needed to operate the drives and the DC bus peak power needed for accelerations. When motors are operated in generator mode, the power supply must be able to handle the duration of power return and the peak return power. The power supply module also provides the signal voltages used to power the electronic circuitry on the drives.

The motors and drives which will be used must be identified before selecting the power supply module and accessory components.

It is recommended that the calculations described in 3.1 ... 3.8 be performed to ensure that the proper power supply configuration is used.

3.1. DC Bus Continuous Power

The DC bus continuous power is calculated based on the mechanical power taking into account motor and drive efficiencies and synchronization factors.

Mechanical Output

$$P_m = M \cdot \omega = \frac{M \cdot 2\pi n}{60} \tag{3.1}$$

P_m = Mech. Power in W M = Torque in Nm
 ω = Angular velocity in rad/s n = Speed in RPM

or $P_m = \frac{M \cdot n}{9550}$ P_m = mech. Power in kW

Continuous Mechanical Power for Servo Drives

The **effective motor torque** and the **average motor speed** are used to calculate the continuous mechanical power of a servo drive.

The **effective motor torque** can be taken over from the servo drive calculation.

Mean motor speed:



For servo drive functions on conventional NC machine tools the average motor speed is about 20% of the rapid traverse speed.

In certain cases it may be necessary to calculate the average motor speed exactly.

Calculate the average motor speed:

If the time during which the drive is operated at a constant RPM is significantly higher than the ramp-up or braking time:

Average Speed Without Taking Ramp-Up and Braking Time into Account

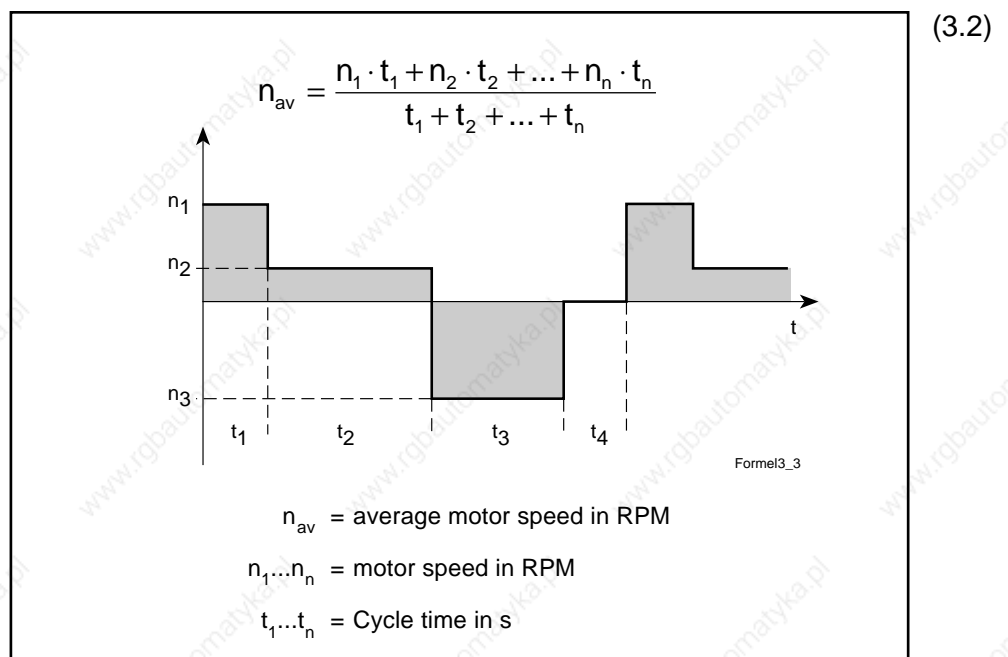

In dynamic applications with short cycle times, for example roller feeders and nibble machines, ramp-up and braking times are taken into account.

Average Speed Taking Ramp-Up and Braking Time Into Account

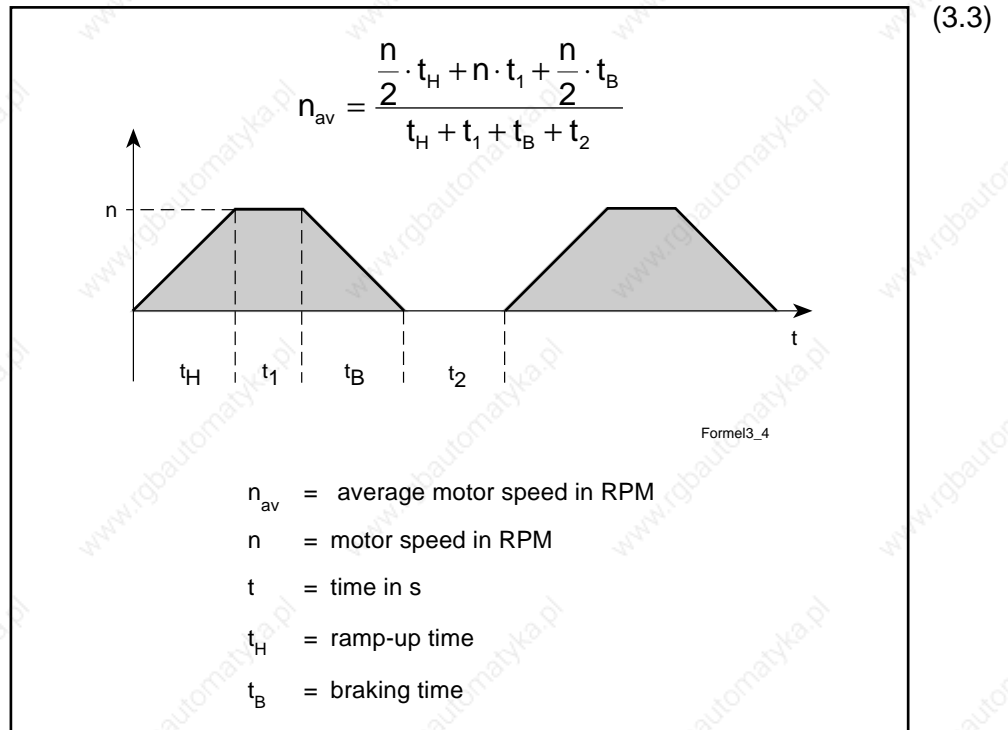

Mechanical Power for Servo Drives

(3.4)

$$P_{mS} = \frac{M_{eff} \cdot n_{av}}{9550}$$

P_{mS} = mech. continuous power for servo drives in kW
 M_{eff} = effective motor torque in Nm
 n_{av} = average motor torque in RPM

Mechanical Power for Main Drives

The mechanical power of the main drives can be calculated or determined from performance curves.

(3.5)

$$P_{mH} = \frac{M_n \cdot n_n}{9550}$$

P_{mH} = mechanical rated power for main drive (shaft output) in kW
 M_n = torque in Nm
 n_n = rated motor speed in RPM

DC Bus Continuous Power for Servo Drives

The power supply module must supply the DC bus power for all servo drives. However only in a very small number of applications are all the drives equally loaded. Thus, only the simultaneous power requirements need to be taken into account.

Simultaneity Factors

In actual practice the following simultaneity factors have been found to be an accurate reflection of conditions encountered in typical NC feed axes.

Number of Axes	1	2	3	4	5	6
Simultaneity Factor	1	1.15	1.32	1.75	2.0	2.25

$$P_{DCS} = \frac{(P_{mS1} + P_{mS2} + \dots + P_{mSn}) \cdot K1}{F_G} \tag{3.6}$$

Meaning of symbols: See 3.8.

DC Bus

The selection of transformers, chokes and auxiliary capacitance modules is based on the actual required DC bus continuous power. It is determined by the rated power of the main drives. When selecting the power supply modules be certain that their maximum DC bus continuous power is not limited by the short-term operating power of the main drives.

If more than one main drive is to be operated on an DC bus, add together the simultaneously required powers.

$$P_{DCH} = P_{mH} \cdot K1 \tag{3.7}$$

Meaning of symbols: See 3.8 for

DC Bus Continuous Power for Main and Servo Drives

Add together the simultaneously required powers.

For Machine Tools

On typical NC machine tools the main drive primarily determines the required DC bus power.

$$P_{DC} = [P_{mH} + 0.3(P_{mS1} + P_{mS2} + \dots + P_{mSn})] \cdot K1 \tag{3.8}$$

0.3 = Empirical value for standard machine tools
 F_G = Simultaneity factor
 K1 = Constant for motor and drive efficiency and current waveform factor
 K1 = 1.25 with TVD 1.2, TVR 3, KDV 2.3, KDV 4.1 (with DC bus choke)
 K1 = 1.8 with TVM (without DC bus choke)

P_{DC} = DC bus continuous power in kW
 P_{DCH} = DC bus continuous power for main drives in kW
 P_{DCS} = DC bus continuous power for servo drives in kW
 P_{mS1} = Continuous mechanical power of servo drive 1 in kW
 P_{mH} = Rated power for main drive (shaft output) in kW

3.2. DC Bus Peak Power

The total of the peak outputs of all drives which accelerate simultaneously must not be greater than the peak output of the power supply module.

The DC bus peak power is required of the power supply module when, for example, a number of axis accelerate simultaneously to their rapid-traverse speeds and traverse to the workpiece.

*DC Bus Peak Power
per Drive*

$$P_{\text{peak}} = \frac{(M_{\text{NC}} \pm M_{\text{G}}) \cdot n_{\text{eil}} \cdot K1}{9550} \quad (3.9)$$

*Total of DC Bus Peak
Powers*

$$\sum P_{\text{peak}} \leq P_{\text{KB-03}} \quad (3.10)$$

$K1$ = Constant for motor and drive efficiency and current waveform factor
 **$K1 = 1.2$ with power supplies
with DC bus choke**
 **$K1 = 1.2$ with power supplies
without DC bus choke**

M_{NC} = Acceleration torque in NC operation in Nm

M_{G} = Weight torque with vertical axes in Nm

n_{eil} = RPM in rapid traverse

P_{peak} = DC bus peak power in kW

$P_{\text{KB-03}}$ = DC bus peak power of the power supply module in kW

3.3. Regenerated Energy

The energy content of all main and servo drives which in the worst case brake at the same time must not exceed the maximum regenerated energy of the power supply module per data sheet. If this is not taken into account in the design of the system, the bleeder resistor in the power supply may be overloaded.

*Regen Energy
per Drive*

$$W_{\text{rot}} = \frac{J_{\text{g}}}{2} \left(n_{\text{eil}} \times \frac{2\pi}{60} \right)^2 \quad (3.11)$$

Total Regen Energies

$$\sum W_{\text{rot}} \leq W_{\text{max}} \quad (3.12)$$

W_{rot} = Rotational energy in Ws

W_{max} = Max. permissible regenerated energy of the power supply module in kW

n_{eil} = RPM in rapid traverse

J_{g} = Inertial torque (motor + load) in kgm²

Auxiliary Capacitance for Energy Storage

In servo drive applications in which a high number of acceleration and deceleration operations are common, for example in nibble machines and roll feed units, auxiliary capacitance modules can be connected to the DC bus. This prevents the bleeder resistor from being activated in the power supply module when the drives are braked, which significantly reduces the heat losses generated in the enclosure. The stored energy can be used for acceleration, reducing the energy consumed by the system.

$$W_{ZW} = \frac{C_{ZW}}{2} (U_B^2 - U_N^2) \quad (3.13)$$

W_{ZW} = Energy which can be stored in the DC bus

C_{ZW} = DC bus capacitance in F

U_B = Bleeder response threshold ca. 425 V

U_N = Rated voltage

— 320 V with TVD, TVR, KVR and KDV 4

— 345 V with TVM and KDV 2
(300 V + 15% overvoltage)

The auxiliary capacitance modules must be designed so that they can store the rotational drive energy.

$$C_{Zu} \geq \frac{2W_{rot}}{(U_B^2 - U_N^2)} \cdot 1000 - 2mF \quad (3.14)$$

C_{Zu} = Auxiliary capacitance in mF

W_{rot} = rotational energy in Ws



Approximately 40 Ws can be stored per mF auxiliary capacitance on power supply modules equipped with a regulated DC bus voltage (TVD, TVR, KVR, KDV 4)

It is recommended that with power supply modules which are not equipped with a regulated DC bus (TVM, KDV 2) the auxiliary capacitances be designed for 15% overvoltage. If this is done, approx. 30 Ws can be stored per mF auxiliary capacitance.

3.4. Continuous Regenerated Power

The total of the continuous regenerated power from all drives averaged over time must not exceed the continuous regenerated power.

With servo drive applications on typical NC machine tools, the machining time is relatively large compared to the total cycle time. The continuous regenerated power is low. In general, it cannot be calculated exactly. It is sufficient, however, if the peak regenerated power calculated per section 3.5 is not exceeded.

An exact calculation is necessary in certain circumstances. Such circumstances can be:

- Servo drive applications having a high number of acceleration and braking operations, for example on nibble machines and roll feeds.
- Machine tools having a modular main drive
- Applications in which relatively large masses must be lowered, for example on load crane and in storage and material handling technology

To calculate the continuous regenerated power, the rotational energy of the drives and the potential energy on nonbalanced masses must be known.

Rotational Energy

$$W_{\text{rot}} = \frac{J_g}{2} \left(n_{\text{eil}} \cdot \frac{2\pi}{60} \right)^2 \cdot z \quad (3.15)$$

W_{rot} = Rotational energy in Ws

n_{eil} = RPM during rapid traverse

J_g = Inertial torque (motor + load) in kgm^2

z = Number of braking operations per cycle

Potential Energy

$$W_{\text{pot}} = m \cdot g \cdot h \cdot z \quad (3.16)$$

m = Load mass in kg

g = Descent acceleration in 9.81m/s^2

h = Descent height in m

W_{pot} = Potential energy in Ws

z = Number of lowering operations per cycle

Continuous Regenerated Power

$$P_{\text{RD}} = \frac{W_{\text{rotg}} + W_{\text{potg}}}{t_z} \quad (3.17)$$

P_{RD} = Continuous regenerated power in kW

t_z = Cycle time in s

W_{potg} = Total of potential energies in kW

W_{rotg} = Total of rotational energies in kW

*Individual
Lowering Operation
Within a Cycle*

If a load is lowered over a time greater than 10 s, the regenerated power cannot be greater than the maximum continuous regenerated power of the power supply module.

$$\frac{W_{\text{pot}}}{t_{\text{ab}}} = F \cdot v \leq P_{\text{RD}} \quad (3.18)$$

If the lowering operations are less than 10 s, the regenerated power can be greater, however, the continuous regenerated power of the power supply module cannot be exceeded in average time periods of 10 s.

$$\frac{W_{\text{pot}}}{10\text{s}} = F \cdot v \cdot \frac{t_{\text{ab}}}{10\text{s}} \leq P_{\text{RD}} \quad (3.19)$$

F	=	Weight force in N
v	=	Velocity in m/s
t _{ab}	=	Duration of lowering in s
P _{RD}	=	Continuous regenerated power in W
W _{pot}	=	Potential energy in Js

3.5. Peak Regenerated Power

Peak regenerated power is usually encountered if an emergency stop is triggered and all axes brake simultaneously.



The total of the peak regenerated power from all servos which potentially can brake simultaneously must not exceed the power supply module's peak bleeder power. If this requirement is not taken into account in designing the drive, the DC bus voltage can increase to too high a level upon emergency stop and damage the drive equipment.

$$\sum P_{\text{RS}} \leq P_{\text{BM}} \quad (3.20)$$

The peak regenerated power of the servo drives may be found in the motor selection documents.

As a rule of thumb, the peak regenerated power can be calculated as follows:

$$P_{\text{RS}} = \frac{M_{\text{max}} \cdot n_{\text{max}}}{9550 \cdot 1,25} \quad (3.21)$$

M _{max}	=	Max. drive torque in Nm
n _{max}	=	Max. NC useful speed in RPM
P _{RS}	=	Peak regenerated power in kW
P _{BM}	=	Peak bleeder power in kW

3.6. Power Requirements

The power requirements are calculated so that transformers, commutation chokes, AC power protection and conductor cross sections can be properly specified.

The power requirements depend on the continuous power of the drives and on the operating principle used by the power supply module.

*Power for
TVM 2 and KDV 2*

Power requirements for power supply modules having a connection voltage of 3 x 220 V (TVM 2, KDV 2).

$$S_{An} = P_{DC} \cdot 1.05 \quad (3.22)$$

or

without DC bus choke

$$S_{AN} = P_m \cdot 1.89 \quad (3.23)$$

with DC bus choke

$$S_{An} = P_m \cdot 1.31 \quad (3.24)$$

The line transformer power must be at least twice as large as the calculated connection power.

*Power for
KDV 4*

$$S_{An} = \frac{P_{DC} \cdot \sqrt{2} \cdot U_N}{320V} \quad (3.25)$$

*Power for
TVD, TVR and KVR*

$$S_{AN} = \frac{P_{DC} \cdot \sqrt{3} \cdot U_N}{25.5} \quad (3.26)$$

*AC Current from the
Mains Power System*

$$I_N = \frac{S_{An} \cdot 1000}{\sqrt{3} \cdot U_N} \quad (3.27)$$

S_{An} = Connection power in kVA
 P_{DC} = DC bus continuous power in kW
 P_m = Continuous mechanical power in kW
 U_N = Line voltage in V
 I_N = Line current in A

3.7. Power Requirements for Motor and Heat Sink Blowers

The blowers on the servo drive motors and the heat sink blowers for equipment from the „K series“ are available for connection to 230 V AC and 115 V AC. If line voltages differ from these voltages, an auto-transformer can be used for adaptation purposes. The connection of the individual blowers is stated in the following table.

Equipment Blower	Connection Power
Heat sink blower for KDV, KVR, KDS and KDA	70 VA
MAC 63 motor blower	22 VA
MAC 71 motor blower	31 VA
MAC 90, MAC 93, MAV 112, MAC 115 motor blowers	55 VA
MAC 132 motor blower	80 VA
Axial blower for MDD 65 and MDD 71	30 VA
Axial blower for MDD 90, MDD 112 and MDD 115	58 VA

Fig. 3.1. Connection power for motor and heat sink blowers.

3.8. Power for the Electronic Circuits

The +24 V, ± 15 V control voltage outputs must not be overloaded by the processing of drive control signals. If the control voltages are used outside the drive system, for example to supply voltage to auxiliary relays, this must be taken into account.

Loading Capacity of Control Voltages

Power Supply Module	Power to Electronic Circuits				
	Line Connection		Capacity		
	Connection Voltage	Connection Power	+24V	+15V	-15V
TVM 2.4-50-220/300-W1	115/230V or 230/400V	550 VA	8A	1,3A	1A
TVD 1.2-.-3	3 x 380-460V AC	300 VA	7,5A	2,5A	1,5A
TVR 3.1-W15-3	3 x 380-480V AC	500 VA	11A	2A	2A
KDV2.3-100-220/300-000	230 V	500 VA	12A	2A	2A
KDV 4.1-30-3	230 V	500 VA	11,5A	2A	2A
KVR 1.2-30-3	3 x 380-460V AC	500 VA	11A	2A	2A

Fig. 3.2. Loading capacity of the control voltages.

*Power Consumption
for Processing Signals*

Equipment Designation	24V _L in mA	+15V _M in mA	-15V _M in mA
Servo Drives TDM 1.2 and TDM 1.3			
TDM 1..-30-300-W0	250	140	60
TDM 1..-30-300-W1-000	350		
TDM 1..-50-300-W1-000	350		
TDM 1..-100-300-W1-000	400		
Servo Drives TDM 3.2, TDM 3.3, TDM 4.1 and TDM 4.3			
TDM 3..-20-300-W0	400	120	50
TDM 3..-30-300-W1	800	125	55
TDM 4..-20-300-W0	400	150	60
TDM 4..-30-300-W1	800		
Servo Drives KDS 1.1			
KDS 1.1-030-300-W0	750	140	50
KDS 1.1-050-300-W1	950		
KDS 1.1-100-300-W1	1450		
KDS 1.1-150-300-W1	1950		
MAC tachometer feedback			
	- - -	24	3
Servo Drives DDS 2.1			
DDS 2.1-...-DA01-00	670	180	180
DDS 2.1-...-DA02-00	700		
DDS 2.1-...-DA03-00	710		
DDS 2.1-...-DS01-00	710	150	150
DDS 2.1-...-DS03-00	890		
DDS 2.1-...-DS04-00	840	190	190
DDS 2.1-...-DS05-00	1040	150	150
DDS 2.1-...-RA01-00	570	200	180
DDS 2.1-...-RA02-00	570		
DDS 2.1-...-RS01-00	610	150	150
DDS 2.1-...-RS03-00	760	170	150
DDS 2.1-...-RS04-00	740	190	190
Main Spindle Drives KDA 3.2 and TDA 1.1			
KDA 3.2-050-300-...-W1	1200	160	160
KDA 3.2-100-300-...-W1	1400		
KDA 3.2-150-300-...-W1	1600		
TDA 1.1-050-3-...	1200		
TDA 1.1-100-3-...	1400		

Fig. 3.3. Power consumption for signal processing.

4. Index

A

AC Drive System 5
AC power system protection 38
Acceleration 34
Applications area 6
Auxiliary bleeder module 11, 14
Auxiliary capacitance module 14, 21, 24
Auxiliary capacitances 11, 14, 17, 21, 24, 28
auxiliary capacitances 33
Average motor speed 31

B

Bleeder peak power 37
Bleeder resistor 5, 17, 35

C

Calculations 30
Capacitances 35
Chokes 33
Commutation chokes 38
Conductor cross sections 38
Connection power 38
Connection voltage 11
Control voltages 39

D

DC Bus Continuous Power 31, 33
DC Bus Peak Power 34
DC bus voltage 5
Dimensions 9, 12, 15, 18, 22, 26
Direct connection to AC power 14, 17, 24, 28
Drives 5
Dynamic braking 11, 14, 17, 21, 24, 28

E

Effective motor torque 31
Electronic circuits, power to 11, 14, 17, 21, 25, 29, 39
Energy content 34
Energy requirements 35
Energy Storage 35

F

Fault correction 17, 29
Fault diagnostics 11, 14, 21, 25
Front View 10, 13, 16, 19, 23, 27
Functional Characteristics 8
Fuses 11

H

Heat loss in enclosure 20, 24, 28

I

Inrush current, peak 14, 17, 24, 28
Installation 20, 24, 28

K

KDV 2.3 18
KDV 4.1 22
KVR 1.2 26

L

Line conditioning module NAM 14
Line connection 24
Line current 38
Line voltage 11
Line voltage failure 14

M

Machine Tools 33
Mechanical output 32
Monitors 11, 14, 17, 25, 29
Motor and Heat Sink Blowers 39
Motors 5

P

Performance Characteristics 6
Potential Energy 36
Power Consumption 40
Power failure 17, 21, 29
Power protection 14, 17, 28
Power range 6
Power rectifier 5
Power Supply Module 5
Power system reaction 14, 17, 28

R

Ready-state contact 11
Regenerated energy 5, 11, 14, 21, 34
Regenerated power 11, 14, 17, 24, 28
Regenerated power, continuous 36
Regenerated power, peak 37
Regulated DC Bus 14, 17, 24, 28
Rotational drive energy 35
Rotational energy 36

S

Selection Data 7
Signal voltage bus 5
Simultaneity Factors 33
Soft-start 14, 17, 21, 24, 28
Supply of power 5, 11, 14, 17, 20, 24, 28, 38
Supply of signal voltage 5

T

Transformers 33, 38
TVD 1.2 12
TVM 2.4 9
TVR 3.1 15

5. Additional Documentation

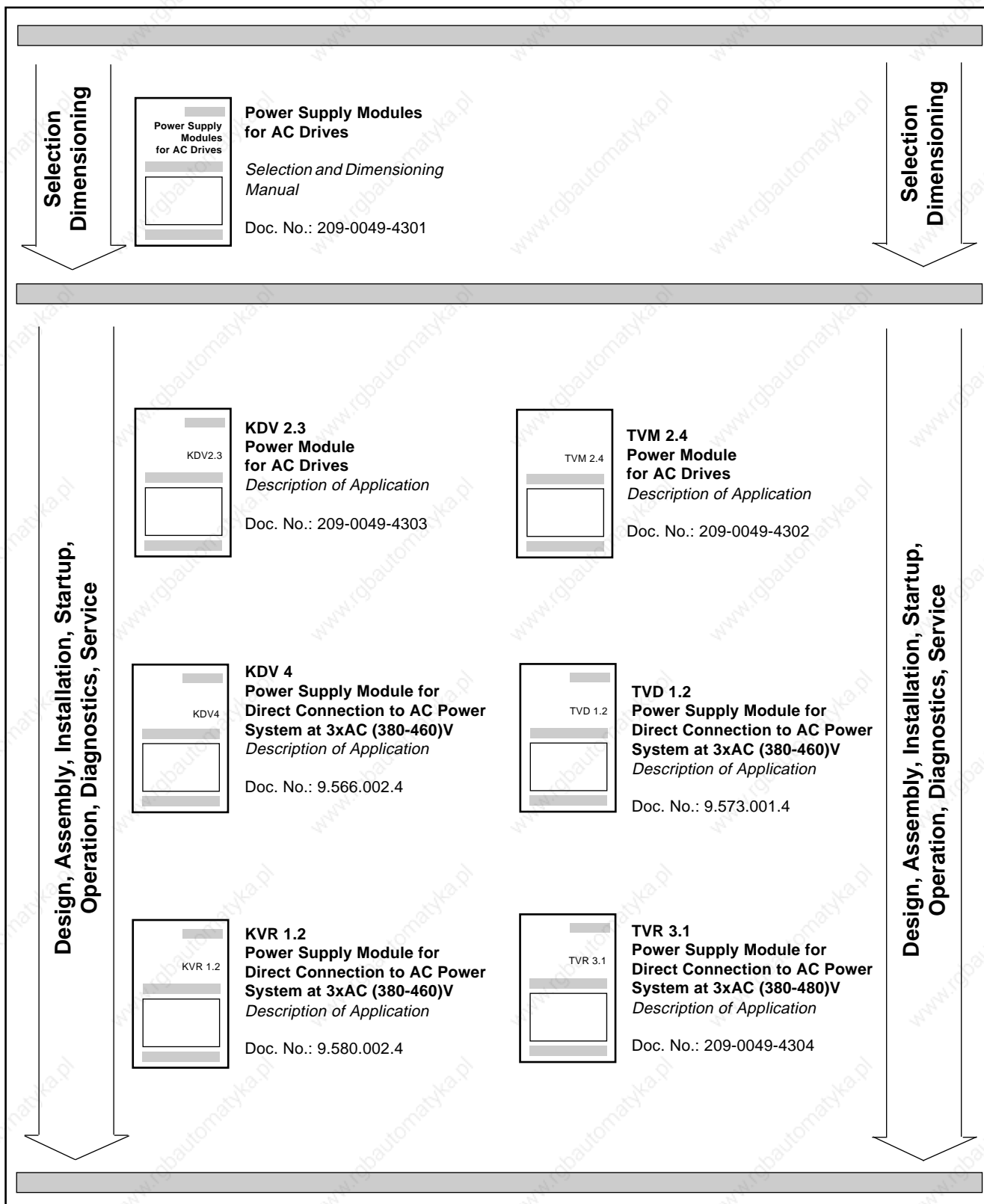

Fig. 5.1. Available power supply module documentation.

