

# SIEMENS



## SIMATIC HMI Panels

Operator panels to suit all demands

SIMATIC HMI

Brochure

Edition  
November  
2012

Answers for industry.

# SIMATIC HMI Panels

Operator panels to suit all demands

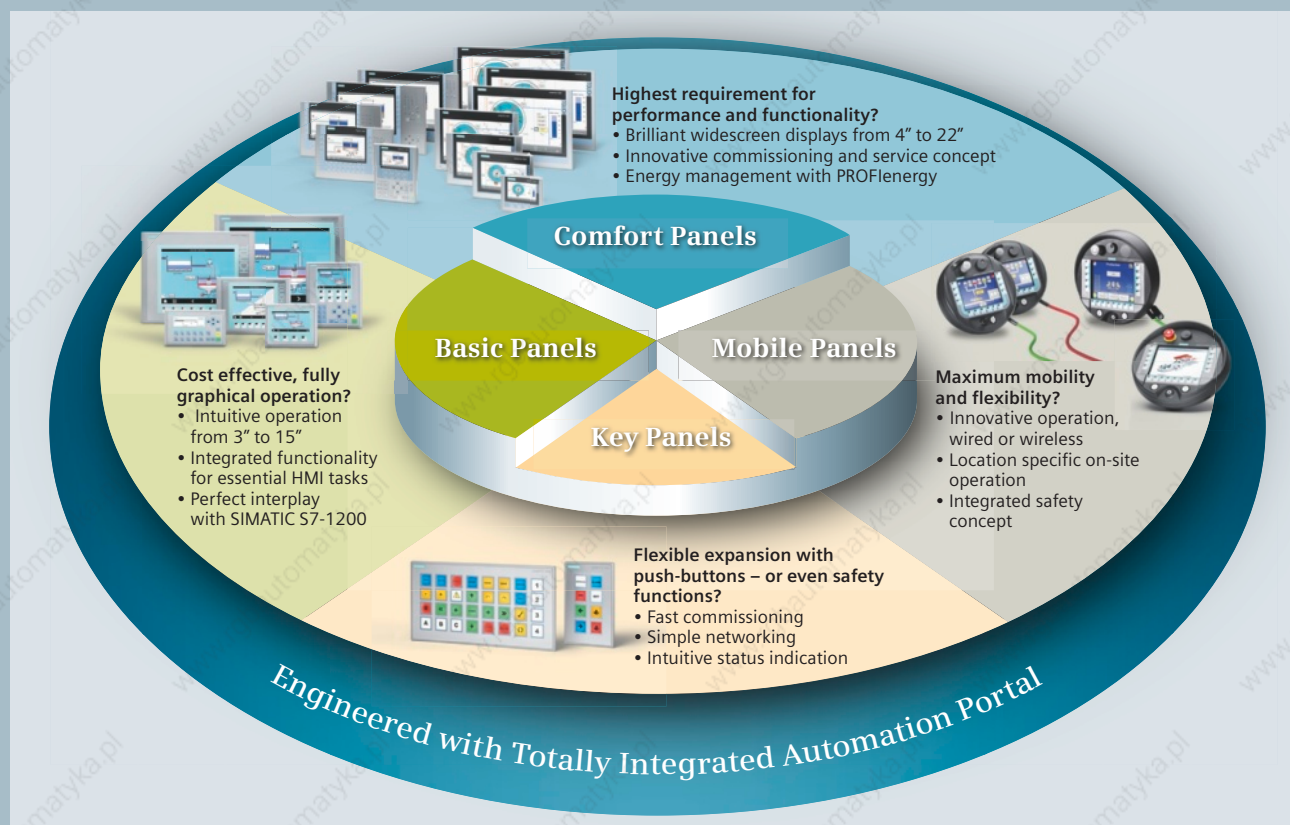

SIMATIC Panels have been proving their value in many different applications in all industrial sectors for many years now.

They do not only have an innovative design and provide high performance. One unique feature is the configuration via SIMATIC WinCC in the TIA Portal with a previously unknown degree of engineering efficiency.

## Integrated functionality across all display sizes

The portfolio of the SIMATIC Panels is clearly structured:

- **SIMATIC HMI Basic Panels** offer basic functions for simple HMI applications.
- **SIMATIC HMI Comfort Panels** are suitable for complex applications.

The functionality of the hardware is identical within a family of devices. You select the optimal display size for your application and decide whether to operate it by means of a touch screen and/or keys.

The software is scalable. This means you can start out small but, for example, are able to increase the number of tags at any time and without problems.

**SIMATIC HMI Key Panels**, the innovative operator panels, are pre-assembled and ready-to-install. Compared to conventional wiring, this results in time savings of up to 60%.

## Mobile operator control and monitoring – wireless and with complete safety functionality

For plants that are very extensive or are difficult to monitor visually, portable operator panels bring important advantages. SIMATIC HMI Mobile Panels can be wired or wireless. Complete safety functionality via IWLAN, to date this is only available for SIMATIC HMI Mobile Panels.

## Unique energy efficiency

SIMATIC Panels can be intuitively configured with SIMATIC WinCC in the TIA Portal. An increased degree of engineering efficiency is achieved in the Totally Integrated Automation Portal if additional Totally Integrated Automation components such as SIMATIC Controllers are used. The perfect interaction with STEP 7 prevents multiple entries and guarantees data consistency.

## Contents

### Totally Integrated Automation – new productivity standards for constant competitive advantages

As a response to increasing international competitive pressures, it is more important today than ever to consistently tap all the potential for optimization over the complete lifecycle of a machine or plant. Optimized processes reduce the total cost of ownership, shorten the time to market, and improve quality.

Totally Integrated Automation is optimized for all requirements and is open for international standards and third-party systems. With its special system characteristics, Totally Integrated Automation supports the complete lifecycle of a machine or plant.

SIMATIC, the core part of Totally Integrated Automation, includes numerous standardized, flexible, and scalable products – such as the SIMATIC Operator Panels presented in this brochure.

#### Highlights of SIMATIC HMI Panels

- Different display sizes both for simple and for complex HMI tasks
- Mobile operator control and monitoring – even wireless and with complete safety functionality
- Intuitive configuring
- Increased engineering efficiency with the simultaneous use of additional Totally Integrated Automation components
- Customer-specific solutions with the same quality standard are available

<b>SIMATIC HMI Panels –</b>	
Operator panels to suit every requirement . . . . .	4
<b>SIMATIC HMI Panels – Product range . . . . .</b>	<b>5</b>
SIMATIC HMI Key Panels . . . . .	5
SIMATIC HMI Basic Panels . . . . .	6
SIMATIC HMI Comfort Panels . . . . .	8
SIMATIC HMI Mobile Panels . . . . .	10
Device versions for special requirements . . . . .	13
Customized Automation . . . . .	14
<b>WinCC engineering software (TIA Portal) . . . . .</b>	<b>16</b>
Maximum configuration efficiency for all HMI applications . . . . .	16
<b>Accessories, starter packages, and promotion packages . . . . .</b>	<b>18</b>
SIMATIC Operator Panels at an introductory price . . . . .	18
Accessories for SIMATIC Operator Panels . . . . .	23



# SIMATIC HMI Panels

## Operator panels to suit all demands

### Rugged for use at the machine level

With IP65/NEMA 4 degree of protection on the front side, high EMC and extreme vibration resistance, the SIMATIC HMI Operator Panels are ideally suited for use at the machine level in harsh industrial environments.

Approvals for many different industries/applications are the proof ([www.siemens.com/simatic/certificates](http://www.siemens.com/simatic/certificates)).

### Selection of possible operating modes

SIMATIC Panels are available with keys and with touch screen operation. Some offer both at the same time.

### Everything at a glance on brilliant displays

All SIMATIC Panels have bright and high-contrast displays for optimal operator control and monitoring.

Displays can be selected in sizes from 3" to 22" depending on your requirements. Devices with widescreen displays give you up to 40 % more visualization area. The long service life of the backlit display is exemplary in any case.

### Diverse connection options

As standard, SIMATIC Panels communicate over PROFINET/Ethernet and/or PROFIBUS. Other I/O devices, such as printers, can be connected through additional interfaces such as USB ports.

### Perfectly suited for worldwide use

Approvals for the most important export countries are available. SIMATIC WinCC in the TIA Portal is multi-lingual (six languages). You can choose configuration interfaces in German, English, French, Spanish, Italian, and Chinese (simplified). Multi-language configuration is supported by text export and text import functions. Up to 32 languages can be administered in one project.

### Open for a wide variety of automation systems

Different interfacing options for SIMATIC S7, drivers for non-Siemens controllers, and vendor-independent communication over OPC ensure correct connection for many different automation solutions.

### Always the right choice

If you are looking for exactly the right operator panel for your application, we recommend you use the TIA Selection Tool. At [www.siemens.com/tia-selection-tool](http://www.siemens.com/tia-selection-tool) you can find the most up-to-date device range.

### Highlights of SIMATIC HMI Panels

- Integrated configuration, data management, and communication
- Designed for harsh industrial environments
  - Rugged and compact
  - Reliable and ergonomic operation by means of touch screens or keypads
  - Brilliant displays for excellent readability – also in widescreen format
- Open and easy to extend
  - Cross-manufacturer OPC communication
  - Controllers from the most diverse manufacturers can be connected
  - TCP/IP via PROFINET/Ethernet
  - Innovative HMI concepts: Traceability/easy validation, service, and diagnostics via the Internet
  - Worldwide application with extensive language support, including Asian languages
- Most devices are also available as SIPLUS extreme components for an extended temperature range and corrosive atmosphere/condensation. [www.siemens.com/siplus-extreme](http://www.siemens.com/siplus-extreme)
- Maximum energy efficiency due to integration in the Totally Integrated Automation Portal (TIA Portal)
- Selection, comparison, and configuration via the TIA Selection Tool



# SIMATIC HMI Key Panels

The innovative operator panels for up to 60% time savings during installation

**SIMATIC HMI Key Panels replace conventional operator panels. They are compact and pre-assembled ready-to-install, but significantly more cost-effective. Thus up to 60% time savings can be achieved during installation.**

## Key Panels KP8, KP8F, and KP32F

Key Panels are operator panels with large keys with LED backlighting. The user can set five colors (blue, green, red, yellow, white) and the brightness of the keys via the STEP 7 hardware configuration. The keys can be easily and individually labeled using slide-in labels and feature tactile feedback. Thus they can be reliably operated even when wearing gloves.

The KP8 is available in two versions: The standard version KP8 and the device with failsafe functionality (KP8F). Both devices have 8 digital inputs/outputs. The KP8F has 4 additional fail-safe inputs. The KP32F has 32 keys and provides 16 digital inputs/outputs and an additional 16 digital inputs, non-isolated.

## Communication options

The connection to the controller is made via PROFINET. A 2-port Ethernet switch permits the operation of linear and ring topologies.

The SIMATIC HMI Key Panels have a redundancy mechanism, which allows you to bridge any faults that may occur. By means of the Media Redundancy Protocol (MRP) for networks in a ring topology, a cable break or component failure is compensated for by means of a switch that opens a second communication path through the network. In the event of a data cable failure, the communication is diverted to this alternative path in real time, thus guaranteeing continuous and reliable communication among the components.

## Ideal expansion for fully enclosed HMI devices

The format of the KP8/KP8F is selected so that it is also ideally suited for installation into the extension units of the fully enclosed HMI PRO devices (see page 13). On the front, the Key Panels achieve degree of protection IP65.

## Fail-safe versions

With the help of the integrated PROFIsafe communication, the KP8F and the KP32F can be used for fail-safe operation with SIMATIC S7-300F/400F for simple emergency stop applications. The 4 additional fail-safe, 24 V-capable digital inputs of the KP8F can be used for sensors with isolated contacts, e.g. an SIL2 emergency stop button. The KP32F has 8 fail-safe, 24 V-capable digital inputs for sensors with isolated contacts.

## Highlights of the Key Panels

- Large, freely configurable keys with tactile feedback for reliable working - even with gloves
- LED backlight with five selectable colors for displaying the machine status
- Integrated Ethernet switch for the setup of linear and ring topologies
- Space-saving alternatives to operator panels with a time savings of up to 60% for the wiring
- A fail-safe version is available for the connection of one to four emergency stop buttons or other fail-safe signals

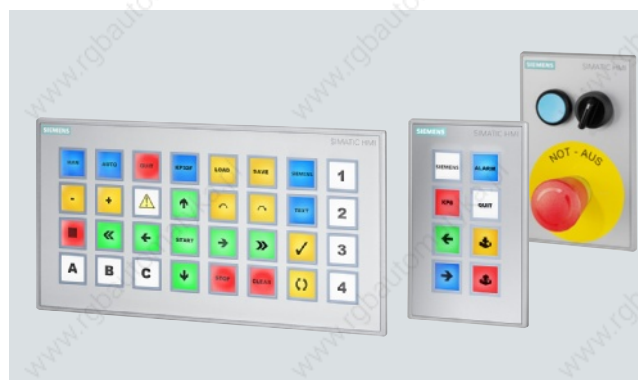

The family of SIMATIC HMI Key Panels



SIMATIC HMI IPC477C PRO with KP8

# SIMATIC HMI Basic Panels

## Low-cost operator control and monitoring for simple HMI applications

The process quality can be significantly improved with visualization even in the case of compact machines or smaller applications. The human machine interface option has until now frequently remained unused for cost reasons. SIMATIC HMI Basic Panels offer HMI basic functions at an attractive price and open up new possibilities for mechanical engineering.

### Brilliant displays in different sizes

SIMATIC HMI Basic Panels are available with display sizes from 3" to 15". They can thus be optimally adapted to the individually required visualization area and the available space on site. The 4" and 6" devices can also be configured for upright mounting, which results in even greater flexibility.

### Operator control via touch display and/or keys

The 4", 6" and 10" devices have touch screens and additional, freely configurable control keys. The 4" device is available with high-resolution widescreen color displays and in a more cost-effective monochrome version.

The 15" device is suitable for displaying large or especially detailed process screens. In this case, the application is exclusively controlled via the touch screen.

The KP300 Basic mono PN rounds off the portfolio of the Basic Panels at the lower end with a 3" display.

### Robust design for harsh environments

With an IP65 degree of protection (on the front), SIMATIC HMI Basic Panels are also suitable for use in harsh environments.

The keys provide tactile feedback and can also be operated easily while wearing gloves.

### Integrated functionality – universal for all display sizes

Regardless of the display size, all of the Basic Panels provide the same functions: The signaling system, recipe management, trend curve functionality, and trend and language selection can be used with any device.

### Highlights of the Basic Panels

- Ideal for less complex visualization tasks
- Integrated, uniform functionality for all display sizes
- Displays with touch functionality for intuitive operator control
- Freely configurable keys with tactile feedback
- Versions for connecting to PROFINET or PROFIBUS
- Projects are upward-compatible and can be transferred to SIMATIC HMI Comfort Panels



Different display sizes – identical functionality



### Different communication options

As standard, Basic Panels communicate over PROFINET. The 6" and 10" devices are also available as a PROFIBUS version.

A large number of drivers support the communication with controllers from other manufacturers.

### Upgradability is ensured

Projects that were created for a Basic Panel with WinCC in the TIA Portal can easily be transferred to a higher-performance Comfort Panel, Mobile Panel, or a PC. Thus, you can continue to use and supplement existing projects after an upgrade.

### Perfect interaction with SIMATIC S7-1200

Basic Panels can be used in a variety of ways. An especially high added value results from the visualization of applications of a modular compact S7-1200 controller. WinCC Basic is automatically included in the scope of delivery of the new SIMATIC STEP 7 Basic engineering system.

The shared Engineering Framework "Totally Integrated Automation Portal" allows integrated engineering for Basic Panels and S7-1200 controllers. Task-oriented and intuitive editors ensure maximum user-friendliness and energy efficiency.

### SIMATIC HMI KP300 Basic mono PN

#### Fast and intuitive process control via keys

If a small display is sufficient and the process is only to be controlled via keys, the KP300 Basic mono PN is the perfect choice.

In addition to a high-resolution monochrome 3" display, it has 10 freely configurable function keys. The keypad with the design of a mobile telephone keypad allows intuitive and fast entry of numbers and words.

#### The color of the backlight is freely selectable

The choices for the color of the LED backlight are white, green, red, and yellow.

The colors can be assigned to individual alarms. This KP300 Basic can thus also be used as an alternative to an alarm indicator lamp.

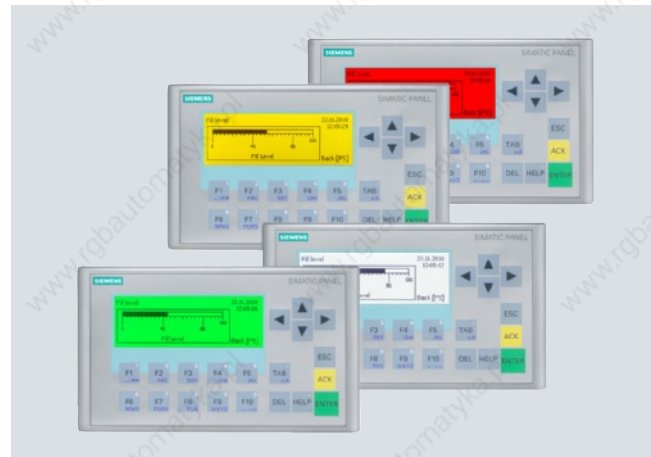

SIMATIC HMI KP300 Basic mono PN with colored LED backlight

### SIMATIC HMI KP400 Basic color PN and KTP400 Basic color PN

#### Pixel-graphics widescreen color displays

The high-resolution widescreen color displays complete the range of Basic Panels in the 4" segment.

#### KP400 Basic color PN key device

In addition to 8 function keys, the KP400 Basic color PN features a numerical keypad with innovative alphanumeric data entry mechanism.



SIMATIC HMI KP400 Basic color PN and KTP400 Basic color PN

# SIMATIC HMI Comfort Panels

## for demanding HMI tasks

All SIMATIC HMI Comfort Panels universally provide the same high-end functionality. With high-resolution widescreen displays from 4" to 22", optionally available with touch operation or control keys, they can be optimally adapted to any application. One of the numerous innovations compared to previous SIMATIC Panels is the capability of coordinating and centrally shutting down the device displays via PROFlenergy during break times in order to reduce energy consumption.

### Brilliant displays in widescreen format

The widescreen format provides up to 40% more visualization area and thus expanded display capabilities for complex operating screens. This format also allows a clear division between the sections for application monitoring and application operation. SIMATIC HMI Comfort Panels are available with 4", 7", 9", 12", 15", 19", and 22" widescreen displays.

The high resolution with 16 million colors allows a detailed process display and optimal readability. This is also supported by the wide viewing angle of 170°.

The brightness of the displays can be dimmed 100% and can therefore be optimally adapted to the requirements of the respective application – this is, for example, important for use on ships and reduces the energy consumption.

### Integrated high-end functionality

SIMATIC HMI Comfort Panels are characterized by high performance. This means, for example, a short display generation time. Regardless of the size of the display, all of the Comfort Panels have archives, VB scripts and various viewers for displaying plant documentation (e.g. as PDFs) and Internet pages.

The system diagnostic capabilities in interaction with SIMATIC Controllers are a new feature. Diagnostic information, which previously required a programming device, can be read via the Comfort Panel.



### Efficient energy management

The standardized PROFlenergy protocol enables loads that are no longer required to be switched off centrally and in a coordinated manner, and measured energy values can be recorded. Thus, the displays of the Comfort Panels can be shut down for short break periods in order to reduce energy consumption. PROFINET as standard allows easy integration into existing plant structures and provides reliable investment protection.

### Optimum selection

SIMATIC HMI Comfort Panels can be optimally adapted to the available space on-site and to the required visualization area. Widescreen displays are available in sizes of 4" to 22". Depending on the application or available space, the touch devices can also be operated upright. As an alternative to touch screen operation, devices with freely configurable keys are available.



Widescreen display with touch operation



### 100 percent data security in the event of a power failure

The integrated protection against voltage failure of the Comfort Panels cost-effectively safeguards all data in the event of a power failure – no additional uninterruptible power supply is required. It is also guaranteed for recipes and archives in RDB format if they are stored on a SIMATIC HMI Memory Card.

### Wide range of communication options

#### Integrated interfaces

SIMATIC HMI Comfort Panels are suitable for integration into PROFINET and PROFIBUS networks and they offer interfaces for connecting USB peripherals.

A 2-port Ethernet switch is available for devices with 7" displays or larger. For devices with 15" displays or larger, a Gigabit PROFINET interface is also available.

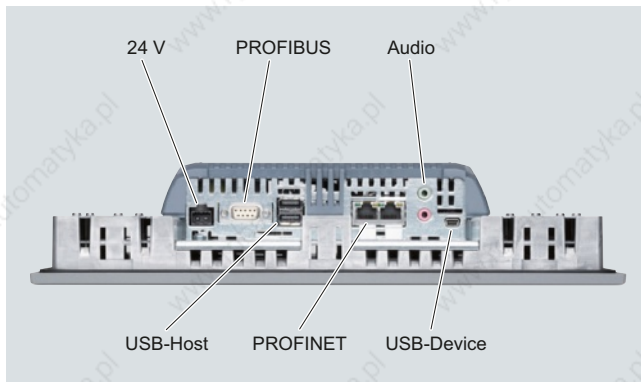

Connection options for the 7" to 12" devices

### Simplified project transfer



Standard cables can be used for loading HMI projects via PROFINET/Ethernet or USB – no special cables are needed. Device settings are set during configuration. Additional settings on the device itself are not required. This simplifies commissioning.

The project data and device settings are saved and automatically updated on a system card in the device. This system card can be used for transferring a project to another device.

### Suitable for harsh environments

SIMATIC HMI Comfort Panels are robust and have several approvals for international usage and for use in sectors with increased requirements.

As standard, the Comfort Panels feature durable aluminum die-cast fronts starting with the 7-inch model. They are certified according to ATEX for Ex zones 2 and 22 and can therefore be used in hazardous areas. Marine approvals will be available soon for all Comfort Panels.

### Ergonomic key operation

The intuitive operator control of the key devices corresponds to that of the tried and tested mobile telephone keypads and permits easy, quick entries. All function keys are equipped with LEDs.

Visual signals for the respective keys to be operated facilitate the operator guidance. For additional reliability, all of the keys provide tactile feedback when pressed.

### Highlights of the Comfort Panels

- All panels with the same integrated high-end functionality
- Widescreen displays from 4" to 22", optionally available with touch operation or control keys
- 4" to 15" as touch or key panel  
19" and 22" as touch panel
- Efficient energy management
  - The brightness of the displays can be dimmed 100%
  - Displays can be switched off even during short breaks
- 100 percent data security in the event of a power failure
- Wide range of communication options
- Simplified project transfer using a system card
- Can be used in hazardous areas
- Option package: printer driver for PDF printing/HTML printing/PostScript printing/Brother QL-650TD

# SIMATIC HMI Mobile Panels

## Maximum mobility for operator control and monitoring

Regardless of the industry or application, if mobility is required for on-site control and monitoring of machines and plants, mobile panels offer some crucial advantages: The machine operators or commissioning engineers are able to work exactly where they have the best view of the workpiece or process.



Device with 10" touch display for clear representation of complex process pictures

### Compact and ergonomic design

With its low weight and handy, compact structure, the Mobile Panel is easy to handle. It permits different holding and gripping positions and can be easily operated for longer periods both by right-handed and left-handed people.

### Rugged design for industrial use

Thanks to the double-walled structure and the rounded enclosure, SIMATIC HMI Mobile Panels are extremely shock-resistant. For example, they can survive a fall from a height of more than one meter without damage. The STOP button in particular is protected with a "protective collar". This minimizes the possibility of unintentional triggering of the safety function or the risk of damage when the device is dropped. SIMATIC HMI Mobile Panels are completely dust-proof and splash-proof (IP65 degree of protection). The high requirement for ruggedness also comprises the connection box and cable.



Mobile Panel 177 (left) or 277 (right) – the right model for every application – also with PROFINET/Ethernet connection

### Highlights of the Mobile Panels

- Rugged design for industrial use
- Ergonomic, compact and light-weight
- Flexible thanks to hot swapping
- Insertion and removal without interrupting the emergency stop circuit (with Plus connection box)
- Reliable operation with sophisticated safety concept
- Connection point detection
- Integrated interfaces: Serial, MPI, PROFIBUS or PROFINET/Ethernet
- Short device startup time after docking

### Reliable and secure operation

Operation takes place intuitively via the touch screen or membrane keys, which provide perceptible and thus reliable feedback – even when the operator is wearing gloves.

For time-critical operation and control processes with very short response times the membrane keys and touch screen can also be connected directly to the distributed I/O. Even the additional operator controls can be configured as direct keys.

With the optional wall bracket, the Mobile Panel can be securely stored or used as a stationary terminal.

### Innovative connection solutions

The Mobile Panel is simply plugged into the connection box wherever it is needed on the machine and is immediately ready for use. The rugged and safe connection box with degree of protection IP65 can be installed anywhere. The Connection Box Plus ensures fault-free hot-swapping.

### Fast device startup

The Mobile Panels are characterized by a fast device startup after plugging them into the connection boxes. By using an optional bridging battery, the startup time of the Mobile Panel – after a short period of separation from the connection box – can again be significantly reduced.

### Connection point detection

The SIMATIC HMI Mobile Panel can be configured such that the user interface changes according to the connection point. The connection point is unambiguously detected when the Mobile Panel is plugged into the connection box. This enables machine-specific HMI authorizations or actions to be performed depending on the selected connection point.

### Integrated interfaces

Mobile Panels are available with PROFIBUS and PROFINET/Ethernet connection. Connecting cables up to 25 m in length are available. The interfaces are already integrated and a variety of drivers – even for non-Siemens PLCs – are also included in the scope of supply. The PROFINET connection boxes can be connected in series with integrated switches.

### Sophisticated safety concept

SIMATIC HMI Mobile Panels offer the option of making safety functions available on a mobile basis at any point of a machine or plant. They have two acknowledgement buttons with three switching stages which ensure the protection of personnel and machines in critical situations (dead man's switch). The acknowledgement buttons are integrated into the handle on the back.

Device versions with an additional STOP button can be integrated into the emergency stop circuit of a machine or plant by means of the connection boxes.

In this way, the STOP button offers the functionality of an emergency stop button, but differs visually from conventional emergency stop devices due to its gray color to avoid confusion. STOP and acknowledgement buttons are designed with dual circuits according to the safety regulations (EN 60204-1). This means it is possible to achieve Safety Category 3 according to EN 954-1.

### Connection at one point of the machine

The "Basic" connection box is used for connecting SIMATIC HMI Mobile Panels with STOP button to one point of the plant. The disconnection of the device in this case causes an opening of the emergency stop circuit and thus triggers the emergency stop.

### Variable connection to different stations of a machine or plant

If you use a Mobile Panel with STOP button together with a connection box "Plus", a configuration can be set up in which the Mobile Panel can be used at different connection points.

When the Mobile Panel is connected, the device is looped into the emergency stop circuit. The emergency stop circuit remains closed regardless of whether the Mobile Panel is plugged in or disconnected. If the Mobile Panel is disconnected during operation, the emergency stop circuit in the Plus connection box is automatically closed which prevents triggering of the emergency stop circuit.

The Plus connection box is also available in a SIPLUS extreme version for extreme environmental conditions (e.g. use in corrosive atmosphere/with condensation).

Further information: [www.siemens.com/siplus-extreme](http://www.siemens.com/siplus-extreme)

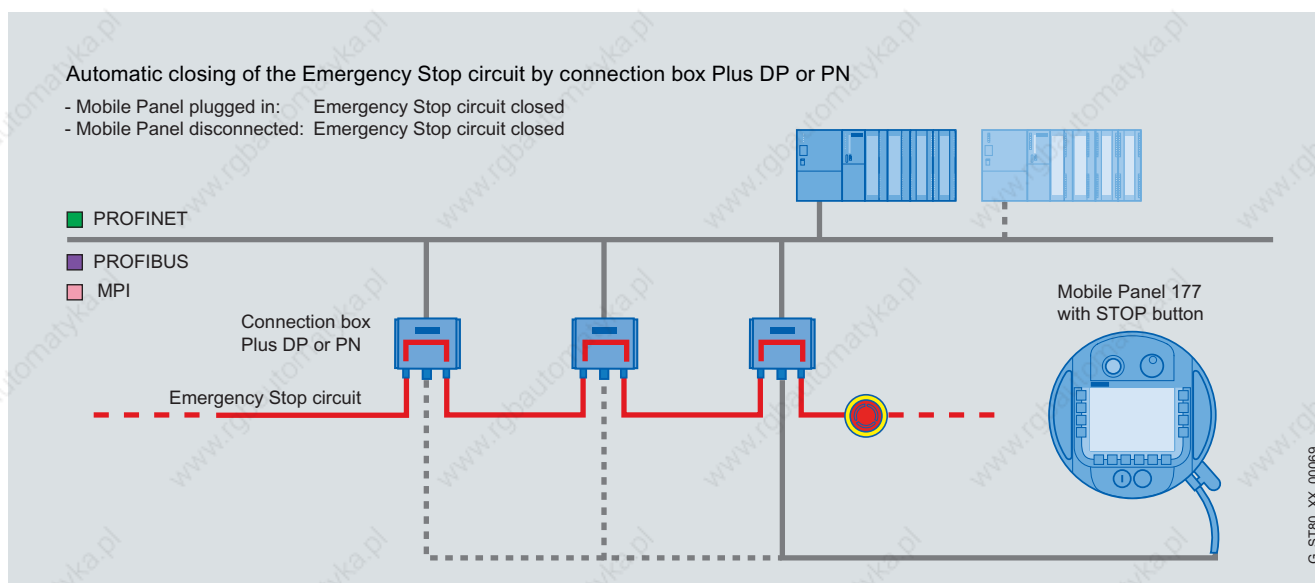

Variable connection to different stations, using the Mobile Panel 177 on the PROFIBUS as an example



## Maximum mobility in operator control and monitoring – wireless and with complete safety functionality

The SIMATIC HMI Mobile Panel 277(F) IWLAN is a world-wide novelty in the field of operator control and monitoring: a wireless operator panel with full HMI functionality. Two versions are available: one device for wireless operator control and monitoring without safety functionality and one with safety functionality. In addition there is the option of using the SIMATIC HMI Mobile Panel 277 (F) IWLAN for SIMOTION applications as well.

### Certified safety

The SIMATIC HMI Mobile Panel 277F IWLAN has two acknowledgement buttons and one red/yellow emergency stop button. A fail-safe SIMATIC F-CPU with Distributed Safety must be used to be able to utilize the safety functions. For industrial plants, the use of SIMATIC Industrial Wireless LAN is recommended. The suitability of the device for particularly high safety requirements was tested and certified by TÜV (SIL 3, PL e). The necessary radio approvals already exist for worldwide use.

### Definite effective ranges

The SIMATIC WinCC engineering software in the TIA Portal can be used to define ranges from which the machine with acknowledgement buttons can be operated. Within these "effective ranges", the device is identified by means of transponders or in an additional version by means of economical RFID tags (MOBY D Smart Cards). This ensures reliable operation and the clear assignment of suitable operating screens and operator authorizations from any point in the plant.

Location-dependent behavior can also be defined for the SIMATIC HMI Mobile Panel 277 IWLAN (without safety function). Here the transponder can generate zones where specific functions are configured, e.g. an automatic screen selection or operator authorizations for specific persons.

### Rugged for tough industrial environments

With its IP65 degree of protection and a drop height of over one meter, the device can be optimally used in tough industrial environments. The powerful batteries can be replaced without interrupting operation. This ensures trouble-free operation.

### WLAN area and effective range

The WLAN area is the area in the plant where the operator panel communicates with an access point over a wireless local area network.

As soon as the PROFINET communication between the controller and operator panel is established in the WLAN area, the emergency stop button on the operator panel becomes active.

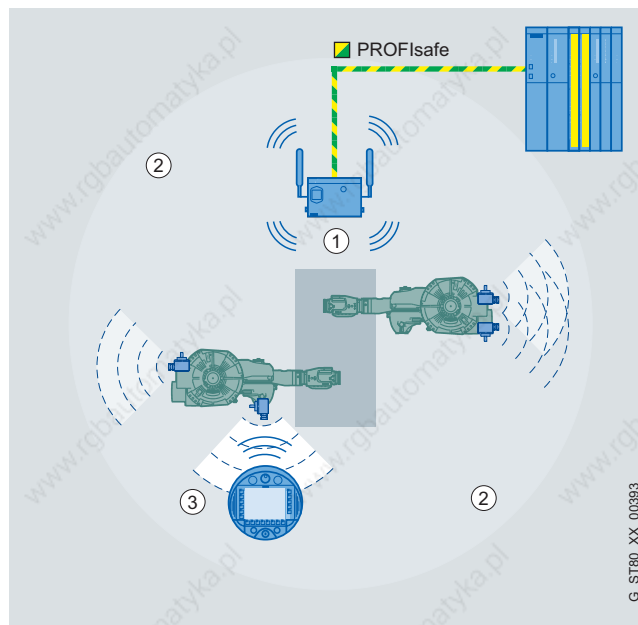

- 1 Access point as network gateway from WLAN to the PROFINET
- 2 WLAN area in which communication with the SCALANCE W access point is possible
- 3 Mobile Panel in the effective range/zone

Fail-safe operation of the plant with the acknowledgement buttons only becomes possible if the operator panel is logged on in an effective range (defined by transponders or RFID tags) within the WLAN area. Due to its high safety standard, the device satisfies safety category SIL 3 or performance level PL e.

### Rapid Roaming

The Mobile Panel 277F IWLAN communicates by means of the extended WLAN access procedure iPCF-MC (industrial point coordination function with management channel). This procedure – also known as "rapid roaming" – ensures almost uninterrupted handover of the wireless signals between the individual access points.



Mobile Panel 277F IWLAN (left) and 277 IWLAN (right)

# Device versions for special requirements

## Fully enclosed SIMATIC HMI devices

The fully enclosed SIMATIC HMI devices supplement the portfolio of the tried and tested built-in units with especially rugged operator panels in an attractive design. The devices are dimensioned for support bracket or stand assembly and offer complete IP65 protection.

The series is technically based on available built-in devices:

- SIMATIC HMI IPC477C PRO 15" and 19"
- SIMATIC Flat Panel Monitor PRO 15" and 19"
- SIMATIC Thin Client PRO 15"
- SIMATIC MP 377 15" PRO

The devices can be mounted on various support bracket and stand systems via a flexible mechanical system. Thus they can be optimally used on machines without requiring a control cabinet. This facilitates ergonomic operation at various locations in plants or production lines. The devices are connected to support bracket systems from different manufacturers by means of adapters, optionally on the top or bottom of the device. Both options are provided as standard.

Due to their low weight, the fully enclosed SIMATIC HMI devices can be mounted easily and quickly. The backplane can be removed easily – e.g. for subsequent installation of cables or replacing memory cards – and thus ensures a high degree of service friendliness even when the device is already mounted on the machine.

The fully enclosed SIMATIC HMI devices offer modular expansion capability. The corresponding expansion units can be attached on the left or right side of the operator panels.

This way, the system can be easily expanded with plant-specific mechanical buttons or other add-on units (e.g. emergency stop) and thus adjusted to many different requirements. The IP65 degree of protection is retained for the entire system even after installation.

### Expansion via Key Panels

The new SIMATIC HMI Key Panels KP8 and KP8F are ideally suited for installing into the expansion units. With their colored backlit keys (5 configurable colors), they are especially well suited for displaying machine statuses.

### Advantages at a glance

- Operator panels with complete IP65 protection for mounting on support brackets or stands
- Removable backplane hood for optimum service friendliness
- Maximum compactness and low weight for easy mounting
- Easy adjustability to changing requirements thanks to modular expansions



SIMATIC Flat Panel Monitor PRO 19" and HMI IPC477C PRO 15" with expansion units including SIMATIC HMI Key Panels



SIMATIC Multi Panel 377 15" PRO on the support arm

# Customized Automation

## Perfectly tailored to individual requirements

**Customer-specific products from the SIMATIC portfolio provide you with the individual adaptations and add-ons in the quality that you know from our standard products.**

For the proven standard SIMATIC products (e.g. HMI, IPC, and S7), we carry out the modifications that are necessary in order to meet your requirements. This ranges from minor design modifications, hardware modifications, customer-specific tests and certifications, to changes in the service, support and logistics. Depending on the extent of the modifications, we distinguish between customer-specific design, OEM solutions, and turn-key products.

### Customized products – individual in design and functionality

#### Customized design

with visual adaptation of SIMATIC products for integration into your individual machine and system design, e.g. by modifying the company logo, membrane color, or enclosure color. The design products are exactly the same as the standard products in terms of technology and functionality.

With the aid of the new digital Express Design, all of the SIMATIC HMI Touch Panels can be provided with photo-realistic front design. If at least three units are ordered, the devices will be available with your own corporate design at short notice.



Comfort Panel with express design

#### Product modifications for OEM customers

go beyond a design change. OEM products are individual solutions based on SIMATIC standard products.

The adaptations of the scope of delivery and the functionality of the OEM products are coordinated, specified, and implemented with the customer on an individual basis. They range from minor supplementations of the products to a completely individually designed device with TIA integration. Adaptations can be implemented by combining standard SIMATIC components all the way to individual components and software adaptations.

#### Customer-specific turnkey products

are ready-to-install and ready-to-use products, which you can obtain from us as the single-source supplier. They are combined, assembled, wired and pre-installed, ready-to-use according to your specifications and corresponding to the specific technical requirements of the standard products.

#### Sector products

For use in special sectors, customer-specific SIMATIC products are optimally equipped with additional features. We can offer customized products for the following sectors:

- Renewable energies such as solar/photovoltaic plants and wind turbines
- General mechanical engineering, e.g. printing machines, drilling, milling and honing machines, brake test stands, injection molding machines, or bakery ovens
- Automotive industry, e.g. body construction, robot stations, operator stations at the production line, paint shops, or in the warehousing and logistics sector
- Food and beverage industry, pharmaceutical industry, e.g. stainless steel operating stations in the hygiene sector or quality control for production and packaging
- Oil & Gas, chemical industry and shipbuilding, e.g. operator stations in hazardous areas, in control centers of drilling towers, or outdoors.



### Examples of sector products

#### SIMATIC HMI Panels with stainless steel front

Panels with touch screen and stainless steel front are designed for operator control and monitoring with the highest safety and hygiene requirements, e.g. for food processing machines in the food and beverage industry.

They are based on DIN EN 1672-2 "Food processing machinery – Safety and hygiene requirements".

Available with stainless steel front:

- TP 177B color PN/DP INOX
- MP 277 10" Touch INOX
- MP 377 15" Touch INOX
- HMI IPC677C INOX

#### SIMATIC Multi Panel 377 15" Touch daylight readable

The SIMATIC Multi Panel 377 15" Touch daylight readable features a special display and touch technology. This allows operator control and monitoring even in very bright environments.

This means you can use the panel in control cabins for drilling rigs and in control stations onboard ships. You can even operate the operator panel outdoors if it is installed in a suitable control cabinet. The necessary, extended ambient temperature range during operation can be created with the help of active heating and cooling in the control cabinet. The Temperature Extension Kit is available for this purpose.



### High quality standards

Customer-specific products are developed and produced like our standard products in accordance with the highest quality standards based on an individual product agreement with you. Further information:

[www.siemens.com/customized-automation](http://www.siemens.com/customized-automation)

E-mail: [customized.automation@siemens.com](mailto:customized.automation@siemens.com)

### Customer-specific software products

Individual software packages may include:

- Remote Operate solutions with HMI software for industrial remote control based on Ethernet
- Special KNX/EIB257 interfaces for communication between different automation levels, e.g. SIMATIC S7 and building automation components
- Softnet/Linux and Softbus/Linux
- S7-Open ModbusTCP

### Service for customized products

With special service and support concepts we provide you with comprehensive support from A to Z. The portfolio covers the entire product lifecycle and includes pre-sales and after-sales support, such as:

- Requirements analysis, concept creation, solution generation
- Competent project support from the offer through to delivery and beyond
- Individual repair concepts and a global service network
- 24-hour product support over the SIMATIC Hotline.

### Logistics for customized products

With individual logistics solutions for customer-specific products, you will receive agreements that are ideally tailored to your needs and which provide you with maximum planning security.

### Examples of individual customer-specific services

- Customer-specific certification and approval
- Configuration and design freeze: individual availability agreements for unchanged hardware and software versions of the products with image compatibility
- Individual labeling: On the device and/or product packaging, e.g. customized item/device/inventory numbers, warehouse barcodes or packing and safety instructions
- Rolling planning with the customer allows the needs-based production and stocking of warehouses so that the products can be requested at the precise moment when they are needed in the production sequence or in the logistics chain.
- Set creation allows the delivery of a customer-specific combination (package) of customer-specific and standard products in one packaging unit, e.g. suitable for the respective machine type.

# SIMATIC WinCC (TIA Portal)

## Maximum configuration efficiency for all HMI applications – WinCC engineering software in the Totally Integrated Automation Portal

The WinCC engineering software (TIA Portal) allows integrated configuring of all SIMATIC Operator Panels right up to PC-based visualization workstations.

The integration into the Totally Integrated Automation Portal results in a clear increase in configuration efficiency compared to the predecessor product WinCC flexible, particularly if SIMATIC Controller applications are being operated and monitored.

### Totally Integrated Automation Portal – Engineering Framework for more efficient engineering

#### Uniform look and feel

The shared Engineering Framework into which the software products are integrated standardizes all shared functions – also in their on-screen representation.

Uniform operation of different editors saves on training costs and makes it easy for users to concentrate on essentials.

#### Integrated intelligence

Intelligent editors are context-sensitive and show precisely what operators require for the task at hand: Functions, properties, libraries. Split-screen technology makes it possible to open several editors simultaneously and to exchange data between them. Data is exchanged using drag and drop.

#### Maximum data transparency

All data only has to be entered once, even when it is used in different editors. Transparency is also gained from an object-oriented approach. Thus, archives and alarms are directly configured with the tags.

The shared database ensures absolute consistency throughout the entire automation project. This reduces the probability of error, and compact and transparent projects are created.

#### Reusable solutions

Supplied and proprietary program blocks and faceplates, as well as off-the-shelf modules and devices, are managed in structured libraries. These blocks can be re-used or centrally modified at any time – project-wide or for individual machines. The central modifiability of the blocks ensures consistency.

Blocks or entire projects created with predecessor versions of the software products integrated into the TIA Portal can also be reused in the TIA Portal.

Reuse saves on engineering costs and simultaneously increases the quality of the solution.

#### Uniform configuration of all SIMATIC Operator Panels

SIMATIC WinCC (TIA Portal) stands for maximum configuration efficiency: Libraries with off-the-shelf objects, re-usable faceplates, intelligent tools right up to multi-language projects. WinCC (TIA Portal) is available in different versions graded according to price and performance. They are based on each other and are optimally tailored to the individual classes of operator panel. The larger software package always includes the configuration options of the smaller package. Existing projects can simply continue to be used after a changeover to a more powerful SIMATIC HMI operator panel.

#### Minimizing configuration costs by means of function block technology

Reusable objects can be centrally stored in a structured format in libraries. Part of the makeup of WinCC (TIA Portal) is a large number of scalable, dynamizable objects from which faceplates can be compiled.

Changes to the faceplates only have to be performed at one central location. They then become effective wherever the faceplate is used. This not only saves time, but also ensures data consistency.

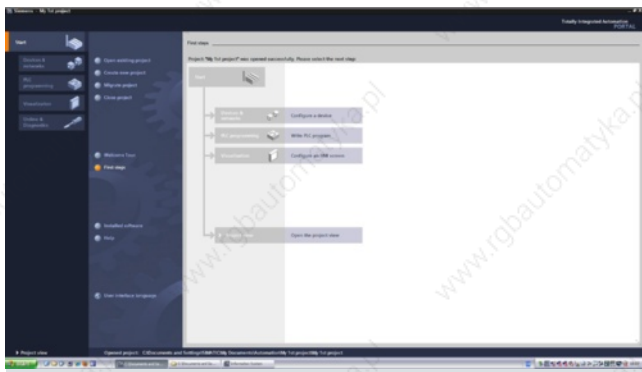

Start screen with clear operator prompting

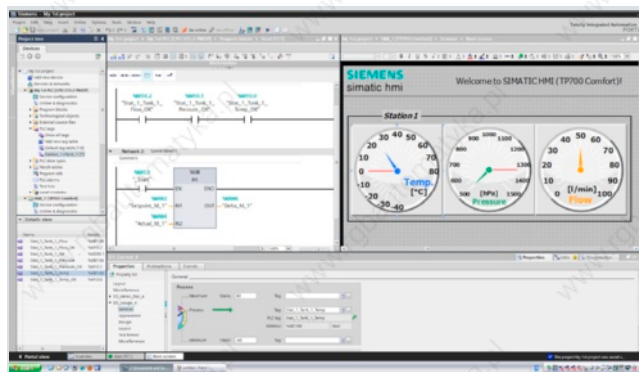

Shared user interface for WinCC and STEP 7 in the TIA Portal

### Intelligent tools for efficient configuration

Table-based editors simplify the generation and processing of similar types of object, e.g. for tags, texts or messages. Complex configuration tasks such as the definition of motion paths or the setup of the fundamental operator prompting system are simplified by means of graphical configuration.

### SIMATIC WinCC (TIA Portal) – operating and display options in runtime mode

The Windows-compliant user interface is made up of parameterizable screen objects and project-specifically created faceplates.

#### Alarms

Alarms can be generated as discrete alarms, analog alarms, and alarms via the event-controlled Alarm\_S procedure with SIMATIC S7. User-defined alarm classes can be used to define acknowledgement functions and the visualization of the respective alarm.

#### Logs and reports

Time and event-driven output of logs and reports.

#### Password protection

Access protection can be activated, if required. Administrators can create user groups who have specific privileges.

#### Logging of process data and alarms

Process data and alarm archiving with WinCC/Logging is used to record and evaluate process data and alarms. Process sequences are documented, the capacity utilization or the quality of products is monitored and recurring fault conditions are logged.

#### Management of recipes

WinCC Recipes is used to manage recipes that contain associated machine or production data.

Recipe data can be imported into the engineering system.

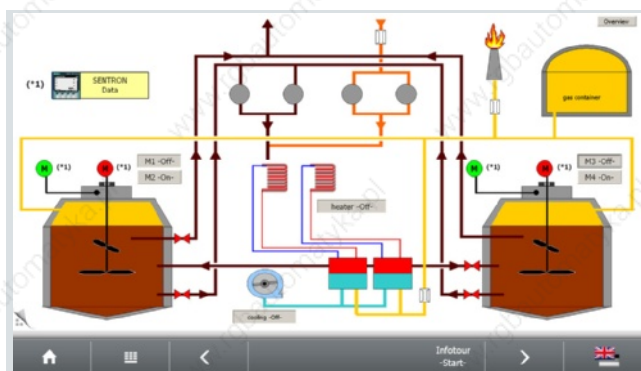

Larger visualization area in widescreen format

### Highlights of SIMATIC WinCC (TIA Portal)

- More energy efficiency in the Totally Integrated Automation Portal
- Innovative configuration interface based on the latest software technologies
- Function block libraries: Variable blocks are freely definable and reusable, and they can be modified centrally
- Intelligent tools, such as configuration in layers and graphical configuration of object movements
- User-friendly creation and administration of mass data
- Access protection with user ID and password
- Recipe management
- Report system
- Language support for worldwide use:
  - Manage 32 languages in one project
  - Simple import/export of texts for translation

#### OPC for vendor-independent communication

An OPC client and OPC server are part of WinCC (TIA Portal). OPC-capable applications such as MES, ERP or office applications can access the data and SIMATIC HMI Panels are capable of communicating with any OPC-compatible application via Ethernet using TCP/IP.

#### Remote maintenance simplifies service and support

An e-mail can be sent automatically from the operator panel to the maintenance personnel via an SMTP (Simple Mail Transfer Protocol) server. When using an e-mail/SMS gateway, access is gained to standard networks and, in critical situations, a text message can be sent to a mobile phone. The option WinCC Sm@rtServer also permits access to SIMATIC HMI Panels from a PC via Internet Explorer.

#### Traceability and easy validation

The WinCC Audit option covers essential requirements outlined by GMP (Good Manufacturing Practice) and the FDA (Food and Drug Administration) in accordance with 21 CFR (Code of Federal Regulations), Part 11, for applications subject to validation.



# SIMATIC Operator Panels at an introductory price

## Starter kits for SIMATIC HMI Panels



KTP400 Basic Starter Kit with S7-1200

### Easy entry at a minimum price:

You can save up to **40%** compared to purchasing the products individually.

Up-to-date information on the starter kits can be found on the Internet at:

[www.siemens.com/comfort-panels-starter-kits](http://www.siemens.com/comfort-panels-starter-kits)



[www.siemens.com/basic-panels-starter-kits](http://www.siemens.com/basic-panels-starter-kits)







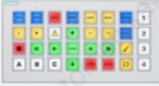

[www.siemens.com/mobile-panels](http://www.siemens.com/mobile-panels)

Starter kits consisting of			
Panel	Engineering software (TIA Portal)	Cable	Miscellaneous
<b>SIMATIC HMI Basic Panels</b>			
KP300 Basic mono PN	STEP 7 Basic with integrated WinCC Basic	Industrial Ethernet (2 m)	SIMATIC CPU S7-1200
KTP400 Basic color PN	STEP 7 Basic with integrated WinCC Basic	Industrial Ethernet (2 m)	SIMATIC CPU S7-1200
KTP600 Basic color PN	STEP 7 Basic with integrated WinCC Basic	Industrial Ethernet (2 m)	SIMATIC CPU S7-1200
<b>SIMATIC HMI Comfort Panels</b>			
KTP400 Comfort	WinCC Comfort	Industrial Ethernet (2 m)	1 SIMATIC HMI Memory Card 2 GB, 10 protective films
TP700 Comfort	WinCC Comfort	Industrial Ethernet (2 m)	1 SIMATIC HMI Memory Card 2 GB, 10 protective films
TP900 Comfort	WinCC Comfort	Industrial Ethernet (2 m)	1 SIMATIC HMI Memory Card 2 GB, 10 protective films
TP1200 Comfort	WinCC Comfort	Industrial Ethernet (2 m)	1 SIMATIC HMI Memory Card 2 GB, 10 protective films
TP1500 Comfort	WinCC Comfort	Industrial Ethernet (2 m)	1 SIMATIC HMI Memory Card 2 GB, 10 protective films
TP1900 Comfort	WinCC Comfort	Industrial Ethernet (2 m)	1 SIMATIC HMI Memory Card 2 GB, 10 protective films
TP2200 Comfort	WinCC Comfort	Industrial Ethernet (2 m)	1 SIMATIC HMI Memory Card 2 GB, 10 protective films
KP400 Comfort	WinCC Comfort	Industrial Ethernet (2 m)	1 SIMATIC HMI Memory Card 2 GB
KP700 Comfort	WinCC Comfort	Industrial Ethernet (2 m)	1 SIMATIC HMI Memory Card 2 GB
KP900 Comfort	WinCC Comfort	Industrial Ethernet (2 m)	1 SIMATIC HMI Memory Card 2 GB
KP1200 Comfort	WinCC Comfort	Industrial Ethernet (2 m)	1 SIMATIC HMI Memory Card 2 GB
KP1500 Comfort	WinCC Comfort	Industrial Ethernet (2 m)	1 SIMATIC HMI Memory Card 2 GB
<b>SIMATIC HMI Mobile Panels</b>			
Mobile Panel 277 IWLAN 8", Touch + Key	WinCC Comfort	–	1 charging station, 1 additional battery
Mobile Panel 277F IWLAN 8", Touch + Key	WinCC Comfort	–	3 transponders, 1 charging station, 1 additional battery

The documentation is supplied on a CD-ROM.

# Technology at a glance

Key Panels			
The innovative operator panels			
			
KP8 PN	KP8F PN	KP32F PN	
<b>Type of operation</b>			
Function keys (programmable)	8	8	32
<b>Output type</b>			
LED color modes	5 (green, red, yellow, blue, white)		
<b>Typical service life</b>			
Short-stroke keys (in number of switching cycles)	1 500 000		
Light-emitting diodes (ON period in %)	100 %		
<b>Interfaces</b>			
Digital inputs/outputs <sup>1)</sup>	8	8	16
Additional digital inputs	-	4 fail-safe	16 + 8 fail-safe
PROFINET	2	2	2
<b>Functionality</b>			
Pushbutton and lamp test	•		
<b>Type of protection</b>			
Front / rear	IP65 / IP20		
<b>Connection to controller</b>			
SIMATIC S7, WinAC	S7-1200, S7-300, S7-400	S7-300 (F), S7-400 (F)	
SIMATIC S5	-		
SINUMERIK	•		
SIMOTION	•		
<b>Engineering software</b>			
Configuration	STEP 7 Basic V11		
<b>Environmental conditions</b>			
Mounting position	Vertical in portrait or landscape format		
Max. permissible angle of inclination without forced ventilation (in °)	+/- 30		
Max. relative humidity (in %)	90		
<b>Temperature</b>			
Operation (vertical installation) in °C	0...+55		
Operation (max. angle of inclination) in °C	0...+45		
<b>Dimensions</b>			
Enclosure front (W x H in mm)	98 x 155	98 x 155	295 x 155
Installation cutout/device depth (W x H / D in mm)	68 x 129 / 49	68 x 129 / 49	275 x 135 / 39
<b>Order No. *)</b>	<b>6AV3688-3AY36-0AX0</b>	<b>6AV3688-3AF37-0AX0</b>	<b>6AV3688-3EH47-0AX0</b>

	Basic Panels								
	Low-cost operator control and monitoring of simple applications								
									
	KP300 Basic mono PN	KTP400 Basic mono PN	KTP400 Basic color PN	KP400 Basic color PN	KTP600 Basic mono PN	KTP600 Basic color DP / PN	KTP1000 Basic color DP / PN	TP1500 Basic color PN	
	<b>3.6" Key</b>	<b>4" Touch + Key</b>	<b>4" Touch + Key</b>	<b>4" Key</b>	<b>6" Touch + Key</b>	<b>6" Touch + Key</b>	<b>10" Touch + Key</b>	<b>15" Touch</b>	
<b>Display</b>	FSTN LCD monochrome	STN liquid crystal display (LCD), 4 gray levels	TFT liquid crystal display (LCD), 256 colors	TFT liquid crystal display (LCD), 256 colors	TFT liquid crystal display (LCD), 256 colors	TFT liquid crystal display (LCD), 256 colors	TFT liquid crystal display (LCD), 256 colors	TFT liquid crystal display (LCD), 256 colors	
Size (in inches)	3.6"	3.8"	4.3"	4.3"	5.7"	5.7"	10.4"	15.1"	
Resolution (W x H in pixels)	240 x 80	320 x 240	480 x 272	480 x 272	320 x 240	320 x 240	640 x 480	1024 x 768	
MTBF <sup>10)</sup> of backlight (in h)	50,000	30,000	50,000	50,000	50,000	50,000	50,000	50,000	
Front dimensions (in mm)	165 x 97	140 x 116	140 x 116	150 x 186	214 x 158	214 x 158	335 x 275	400 x 310	
<b>Operator controls</b>	Membrane keypad	Touch screen and 4 tactile keys	Touch screen and 4 tactile keys	Membrane keypad and 8 tactile keys	Touch screen and 6 tactile keys	Touch screen and 6 tactile keys	Touch screen and 8 tactile keys	Touch screen	
Function keys (programmable) / System keyboard	10 / 10	4 / -	4 / -	8 / 26	6 / -	6 / -	8 / -	- / -	
<b>Usable memory</b>									
User memory	512 KB	512 KB	512 KB	512 KB	512 KB	512 KB	1024 KB	1024 KB	
Memory for options / recipes <sup>7)</sup>	- / 40 KB	- / 40 KB	- / 40 KB	- / 40 KB	- / 40 KB	- / 40 KB	- / 40 KB	- / 40 KB	
Message buffer	•	•	•	•	•	•	•	•	
<b>Interfaces</b>									
Serial / MPI / PROFIBUS DP / PROFINET (Ethernet)	- / - / - / •	- / - / - / •	- / - / - / •	- / - / - / •	- / - / - / •	- / - / • / - or - / - / - / •	- / - / • / - or - / - / - / •	- / - / - / •	
USB host / USB device	-	-	-	-	-	-	-	-	
Slot for CF / Multi Media / SD	- / - / -	- / - / -	- / - / -	- / - / -	- / - / -	- / - / -	- / - / -	- / - / -	
<b>Functionality (if configured with WinCC V12)</b>									
Signaling system (number of messages/message classes)	200 / 32	200 / 32	200 / 32	200 / 32	200 / 32	200 / 32	200 / 32	200 / 32	
Process pictures	50	50	50	50	50	50	50	50	
Variables	250	250	500	500	500	500	500	500	
Vector graphics	•	•	•	•	•	•	•	•	
Bar graphs / curve diagrams	• / •	• / •	• / •	• / •	• / •	• / •	• / •	• / •	
Faceplates	-	-	-	-	-	-	-	-	
Recipes	5	5	5	5	5	5	5	5	
Archiving / Visual Basic Scripts	- / -	- / -	- / -	- / -	- / -	- / -	- / -	- / -	
Programming device functions	-	-	-	-	-	-	-	-	
<b>Connection to controller</b>									
SIMATIC S7 / SIMATIC WinAC	• / •	• / •	• / •	• / •	• / •	• / •	• / •	• / •	
SIMATIC S5 / SIMATIC 505	- / -	- / -	- / -	- / -	- / -	- / -	- / -	- / -	
SINUMERIK / SIMOTION	- / -	- / -	- / -	- / -	- / -	- / -	- / -	- / -	
Allen Bradley / Mitsubishi	• / •	• / •	• / •	• / •	• / •	• / •	• / •	• / •	
Modicon/Omron	• / -	• / -	• / -	• / -	• / -	• / • or • / -	• / • or • / -	• / -	
<b>Engineering software</b>									
Configuration	WinCC Basic V11 or higher	WinCC Basic V10.5 or higher, WinCC flex. Compact	WinCC Basic V11 or higher	WinCC Basic V11 or higher	WinCC Basic V10.5 or higher, WinCC flex. Compact	WinCC Basic V11 or higher, WinCC flex. Compact	WinCC Basic V11 or higher, WinCC flex. Compact	WinCC Basic V10.5 or higher, WinCC flex. Compact	
<b>Options, application</b>									
Sm@rtServer / Audit / Logon	- / - / -	- / - / -	- / - / -	- / - / -	- / - / -	- / - / -	- / - / -	- / - / -	
OPC server / Internet Explorer	- / -	- / -	- / -	- / -	- / -	- / -	- / -	- / -	
<b>Order No. *)</b>	<b>6AV6647-0AH11-3AX0</b>	<b>6AV6647-0AA11-3AX0</b>	<b>6AV6647-0AK11-3AX0</b>	<b>6AV6647-0AJ11-3AX0</b>	<b>6AV6647-0AB11-3AX0</b>	<b>6AV6647-0AC11-3AX0</b> <b>6AV6647-0AD11-3AX0</b>	<b>6AV6647-0AE11-3AX0</b> <b>6AV6647-0AF11-3AX0</b>	<b>6AV6647-0AG11-3AX0</b>	

\*) Current ordering data and terms and conditions of sales and delivery can be found in the Catalog ST 80 / ST PC and on the Internet at [www.siemens.com/industrymall](http://www.siemens.com/industrymall)

<sup>1)</sup> User-configurable <sup>2)</sup> Device version <sup>3)</sup> Device version DP <sup>4)</sup> PN/DP version <sup>5)</sup> RS232 with adapter <sup>6)</sup> Only via PROFIBUS DP <sup>7)</sup> Integrated Flash, expandable via memory card

Comfort Panels							Mobile Panels					
High-end functionality for demanding HMI tasks							Maximum mobility for operator control and monitoring					
KTP400 Comfort KP400 Comfort	TP700 Comfort KP700 Comfort	TP900 Comfort KP900 Comfort	TP1200 Comfort KP1200 Comfort	TP1500 Comfort KP1500 Comfort	TP1900 Comfort	TP2200 Comfort	Mobile Panel 177	Mobile Panel 277	Mobile Panel 277 (F) IWLAN V2	Mobile Panel 277		
4" Touch + Key 4" Key	7" Touch 7" Key	9" Touch 9" Key	12" Touch 12" Key	15" Touch 15" Key	19" Touch	22" Touch	6" Touch + Key	8" Touch + Key	8" Touch + Key	10" Touch		
Widescreen TFT, 16 million colors, LED backlighting								STN liquid crystal display (LCD), 256 colors	TFT liquid crystal display (LCD) 64K colors	TFT liquid crystal display (LCD) 64K colors	TFT liquid crystal display (LCD) 64K colors	<b>Display</b>
4.3"	7.0"	9.0"	12.1"	15.4"	18.5"	21.5"	5.7"	7.5"	7.5"	10.4"	Size (in inches)	
480 x 272	800 x 480	800 x 480	1280 x 800	1280 x 800	1366 x 768	1920 x 1080	320 x 240	640 x 480	640 x 480	800 x 600	Resolution (W x H in pixels)	
80,000	80,000	80,000	80,000	80,000	50,000	30,000	50,000	50,000	50,000	50,000	MTBF <sup>10)</sup> of backlight (in h)	
140 x 116 152 x 188	214 x 158 308 x 204	274 x 190 362 x 230	330 x 241 454 x 289	415 x 310 483 x 310	483 x 337	560 x 380	Diameter 245	Diameter 290	Diameter 290	Diameter 350	Front dimensions (in mm)	
Touch screen and membrane keypad or membrane keypad	Touch screen or membrane keypad	Touch screen or membrane keypad	Touch screen or membrane keypad	Touch screen or membrane keypad	Touch screen	Touch screen	Membrane keypad and touch screen	Membrane keypad and touch screen	Membrane keypad and touch screen	Touch screen	<b>Operator controls</b>	
4 (w. LED) / - 8 (w. LED) / •	- / - 24 (w. LED) / •	- / - 26 (w. LED) / •	- / - 34 (w. LED) / •	- / - 36 (w. LED) / •	- / -	- / -	14 / -	18 / -	18 / -	- / -	Function keys (programmable) / System keyboard	
											<b>Usable memory</b>	
4 MB	12 MB	12 MB	12 MB	24 MB	24 MB	24 MB	2 MB	6 MB	6 MB	6 MB	User memory	
4 MB / 512 KB	12 MB / 2 MB	12 MB / 2 MB	12 MB / 2 MB	24 MB / 4 MB	24 MB / 4 MB	24 MB / 4 MB	- / 32 KB	1024 KB / 64 KB	1024 KB / 64 KB	1024 KB / 64 KB	Memory for options / recipes <sup>7)</sup>	
•	•	•	•	•	•	•	•	•	•	•	Message buffer	
											<b>Interfaces</b>	
• <sup>5)</sup> / • / • / 1	• <sup>5)</sup> / • / • / 2	• <sup>5)</sup> / • / • / 2	• <sup>5)</sup> / • / • / 2	• <sup>5)</sup> / • / • / 3	• <sup>5)</sup> / • / • / 3	• <sup>5)</sup> / • / • / 3	• / • <sup>3)</sup> / • <sup>3)</sup> / • <sup>2)</sup>	• / • / • / •	- / - / - / (• via IWLAN)	• / • / • / •	Serial / MPI / PROFIBUS DP / PROFINET (Ethernet)	
1 / 1	2 / 1	2 / 1	2 / 1	2 / 1	2 / 1	2 / 1	- / -	• / -	• / -	• / -	USB host / USB device	
- / • / •	- / • / •	- / • / •	- / • / •	- / • / •	- / • / •	- / • / •	- / • / -	- / • / •	- / • / •	- / • / •	Slot for CF / Multi Media / SD	
											<b>Functionality (if configured with WinCC V12)</b>	
2000 / 32	4000 / 32	4000 / 32	4000 / 32	6000 / 32	6000 / 32	6000 / 32	2000 / 32	4000 / 32	4000 / 32	4000 / 32	Signaling system (number of messages/message classes)	
500	500	500	500	750	750	750	500	500	500	500	Process pictures	
1024	2048	2048	2048	4096	4096	4096	1024	2048	2048	2048	Variables	
•	•	•	•	•	•	•	•	•	•	•	Vector graphics	
• / f (t), f (x)	• / f (t), f (x)	• / f (t), f (x)	• / f (t), f (x)	• / f (t), f (x)	• / f (t), f (x)	• / f (t), f (x)	• / f (t)	• / f (t)	• / f (t)	• / f (t)	Bar graphs / curve diagrams	
•	•	•	•	•	•	•	-	•	•	•	Faceplates	
100	300	300	300	500	500	500	100	300	300	300	Recipes	
10 / 50	50 / 100	50 / 100	50 / 100	200 / 200	200 / 200	200 / 200	- / -	• / •	• / •	• / •	Archiving / Visual Basic Scripts	
STATUS/CONTROL, diagnostics viewer	STATUS/CONTROL, diagnostics viewer	STATUS/CONTROL, diagnostics viewer	STATUS/CONTROL, diagnostics viewer	STATUS/CONTROL, diagnostics viewer	STATUS/CONTROL, diagnostics viewer	STATUS/CONTROL, diagnostics viewer	STATUS/CONTROL	STATUS/CONTROL	STATUS/CONTROL	STATUS/CONTROL	Programming device functions	
											<b>Connection to controller</b>	
• / •	• / •	• / •	• / •	• / •	• / •	• / •	• / •	• / •	• / •	• / •	SIMATIC S7 / SIMATIC WinAC	
- / -	- / -	- / -	- / -	- / -	- / -	- / -	• <sup>3)</sup> / • <sup>3)</sup> / • <sup>3)</sup>	• <sup>6)</sup> / •	-	• <sup>6)</sup> / •	SIMATIC S5 / SIMATIC 505	
- / -	- / -	- / -	- / -	- / -	- / -	- / -	• / •	• / •	- / • (not Safety version)	• / •	SINUMERIK / SIMOTION	
• / •	• / •	• / •	• / •	• / •	• / •	• / •	• <sup>3)</sup> / • <sup>3)</sup>	• / •	- / -	• / •	Allen Bradley / Mitsubishi	
• / •	• / •	• / •	• / •	• / •	• / •	• / •	• <sup>3)</sup> / • <sup>3)</sup>	• / •	- / -	• / •	Modicon/Omron	
											<b>Engineering software</b>	
WinCC Comfort V11 or higher	WinCC Comfort V11 or higher	WinCC Comfort V11 or higher	WinCC Comfort V11 or higher	WinCC Comfort V11 or higher	WinCC Comfort V11 or higher	WinCC Comfort V11 or higher	WinCC Comfort V11 or higher, WinCC flexible Compact, Standard, Advanced	WinCC Comfort V11 or higher, WinCC flexible Standard, Advanced	WinCC Comfort V11 or higher, WinCC flexible Standard, Advanced	WinCC Comfort V11 or higher, WinCC flexible Standard	Configuration	
											<b>Options, application</b>	
• / • / •	• / • / •	• / • / •	• / • / •	• / • / •	• / • / •	• / • / •	• <sup>2)</sup> / - / •	• / • / •	• / • / - <sup>9)</sup>	• / - / -	Sm@rtServer / Audit / Logon	
• / •	• / •	• / •	• / •	• / •	• / •	• / •	- / -	• / •	• / •	• / •	OPC server / Internet Explorer	
6AV2124-2DC01-0AX0 6AV2124-1DC01-0AX0	6AV2124-0GC01-0AX0 6AV2124-1GC01-0AX0	6AV2124-0JC01-0AX0 6AV2124-1JC01-0AX0	6AV2124-0MC01-0AX0 6AV2124-1MC01-0AX0	6AV2124-0QC02-0AX0 6AV2124-1QC02-0AX0	6AV2124-0UC02-0AX0	6AV2124-0XC02-0AX0	6AV6645-0AA01-0AX0 6AV6645-0BA01-0AX0	6AV6645-0CA01-0AX0	6AV6645-0DD01-0AX1	6AV6645-0BE02-0AX0	Order No. <sup>7)</sup>	

<sup>8)</sup> Configuration with WinCC flexible 2008 <sup>9)</sup> Only monitoring mode for Mobile Panel 277F IWLAN <sup>10)</sup> Reduction of brightness by 50%, can be extended by dimming and ProfiEnergy.



# Accessories for SIMATIC Operator Panels

## Memory media



Data such as image updates, projects, etc. can be saved and transferred via various types of standard storage media.

The selection of storage media for SIMATIC HMI ranges from CompactFlash Cards and Multi Media Cards to the SD Card. SIMATIC USB flash drives are approved for all Multi Panels, Comfort Panels, and Mobile Panels with Windows CE 5.0 or higher.

## Converters/adapters



Converters and adapters expand the physical possibilities for connecting SIMATIC Operator Panels.

This makes it possible, for example, to externally convert from RS422 to RS232. Furthermore, this allows SIMATIC S5 controllers and non-Siemens controllers to be connected. Using angled adapters, the connector outlet can be rotated by 90°.

## Industrial Hub 4



The active industrial USB Hub 4 has 4 USB V1.1 ports. These are arranged such that up to four standard USB flash drives, for example, can be securely attached. When installed, the four ports can be accessed simultaneously from the front via an IP65 flap and from the control cabinet at the back.

The USB Hub 4 can also be optionally mounted direct on a standard mounting rail. All USB products approved for panels or PCs can be connected.

## Cover foils



Protective films protect the display against dirt and scratching during operation and use.

All protective films are anti-glare films. This is a real advantage during long monitoring periods and in poor lighting conditions.

For complete protection of the front side in harsh environments, protective covers are also available for some devices.

## Connector



For PROFIBUS and PROFINET, there is a comprehensive range of connection plugs and plug-in connectors with various connection methods available.

The bus connector is available in several versions for various cable outlets. Integrated terminating resistors can easily be connected from outside. 24 V DC power supply connectors can also be ordered.

## Service kits

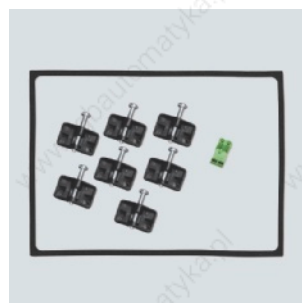

Service kits for SIMATIC Operator Panels are available for all loose parts for the respective panel, e.g. mounting wrench, mounting seal, and connection plug.

## Get more information:

[www.siemens.com/simatic-hmi](http://www.siemens.com/simatic-hmi)

[www.siemens.com/simatic-panels](http://www.siemens.com/simatic-panels)

[www.siemens.com/tia-portal](http://www.siemens.com/tia-portal)

SIPLUS extreme – Hardening and Finishing:

[www.siemens.com/siplus-extreme](http://www.siemens.com/siplus-extreme)

SIMATIC Guide manuals:

[www.siemens.com/simatic-docu](http://www.siemens.com/simatic-docu)

Further publications on the topic of SIMATIC at:

[www.siemens.com/simatic/printmaterial](http://www.siemens.com/simatic/printmaterial)

Service & Support Portal:

[www.siemens.com/automation/support](http://www.siemens.com/automation/support)

SIMATIC contacts:

[www.siemens.com/automation/partner](http://www.siemens.com/automation/partner)

Electronic ordering via the Internet with the Industry Mall:

[www.siemens.com/industrymall](http://www.siemens.com/industrymall)

SIMATIC HMI –  
take a look!



Siemens AG  
Industry Sector  
Industrial Automation Systems  
Postfach 4848  
90026 NÜRNBERG  
GERMANY

Subject to change without prior notice  
Order No.: 6ZB5370-0CJ02-0BB5  
MP.R1.AS.0000.29.3.02 / 26100  
BR 1112 3. ROT 24 En  
Printed in Germany  
© Siemens AG 2012

The information provided in this brochure contains descriptions or characteristics of performance which in case of actual use do not always apply as described or which may change as a result of further development of the products. An obligation to provide the respective characteristics shall only exist if expressly agreed in the terms of contract. Availability and technical specifications are subject to change without notice.

All product designations may be trademarks or product names of Siemens AG or supplier companies whose use by third parties for their own purposes could violate the rights of the owners.

[www.siemens.com/automation](http://www.siemens.com/automation)