

600V / 15A 6 in one-package

■ Features

- Compact Single in -line package

■ Applications

- Inverter for Motor drive
- AC and DC Servo drive amplifier
- Uninterruptible power supply
- Industrial machines, such as Welding machines

■ Maximum ratings and characteristics

● Absolute maximum ratings (at Tc=25°C unless otherwise specified)

Item	Symbol	Rating	Unit
Collector-Emitter voltage	V _{CES}	600	V
Gate-Emitter voltage	V _{GES}	±20	V
Collector current	Continuous	I _C	15 A
	1ms	I _C pulse	30 A
		-I _C	15 A
	1ms	-I _C pulse	30 A
Max. power dissipation	P _C	60	W
Operating temperature	T _j	+150	°C
Storage temperature	T _{stg}	-40 to +125	°C
Isolation voltage	V _{is}	AC 2000 (1min.)	V
Screw torque	Mounting *1	1.7	N·m

*1 : Recommendable value : 1.3 to 1.7 N·m (M4)

● Electrical characteristics (at Tj=25°C unless otherwise specified)

Item	Symbol	Characteristics			Conditions	Unit
		Min.	Typ.	Max.		
Zero gate voltage collector current	I _{CES}	–	–	1.0	V _{GE} =0V, V _{CES} =600V	mA
Gate-Emitter leakage current	I _{GES}	–	–	0.1	V _{CE} =0V, V _{GE} =±20V	µA
Gate-Emitter threshold voltage	V _{GE(th)}	5.5	–	8.5	V _{CE} =20V, I _C =15mA	V
Collector-Emitter saturation voltage	V _{CE(sat)}	–	–	2.8	V _{GE} =15V, I _C =15A	V
Input capacitance	C _{ies}	–	975	–	V _{GE} =0V	pF
Output capacitance	C _{oes}	–	225	–	V _{CE} =10V	
Reverse transfer capacitance	C _{res}	–	54	–	f=1MHz	
Turn-on time	t _{on}	–	–	1.2	V _{CC} =300V	µs
	t _r	–	–	1.0	I _C =15A	
Turn-off time	t _{off}	–	–	1.0	V _{GE} =±15V	
	t _f	–	–	0.35	R _G =150ohm	
Diode forward on voltage	V _F	–	–	3.0	I _F =15A, V _{GE} =0V	V
Reverse recovery time	t _{rr}	–	–	0.3	I _F =15A, -di/dt=45A/µs, V _{GE} =-10V	µs

● Thermal resistance characteristics

Item	Symbol	Characteristics			Conditions	Unit
		Min.	Typ.	Max.		
Thermal resistance	R _{th(j-c)}	–	–	2.08	IGBT	°C/W
	R _{th(j-c)}	–	–	3.0	Diode	°C/W
	R _{th(c-f)*2}	–	0.06	–	the base to cooling fin	°C/W

*2 : This is the value which is defined mounting on the additional cooling fin with thermal compound



■ Equivalent Circuit Schematic

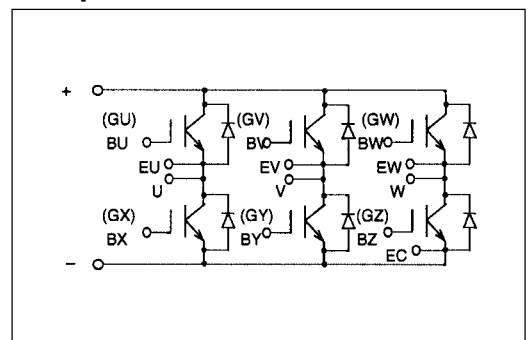

Characteristics (Representative)

Collector current vs. Collector-Emitter voltage
T_J=25°C

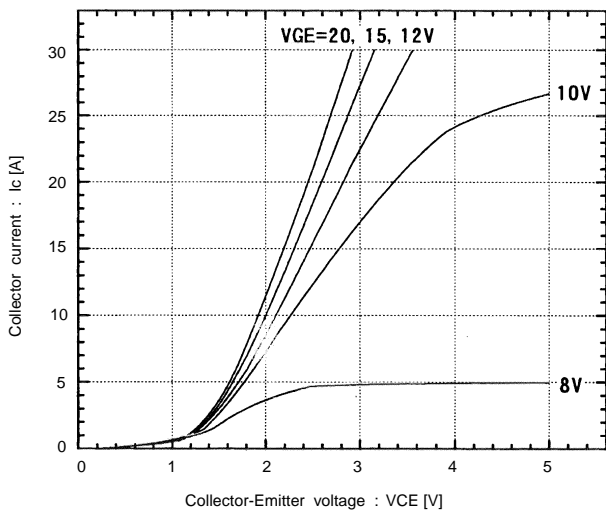

Collector current vs. Collector-Emitter voltage
T_J=125°C

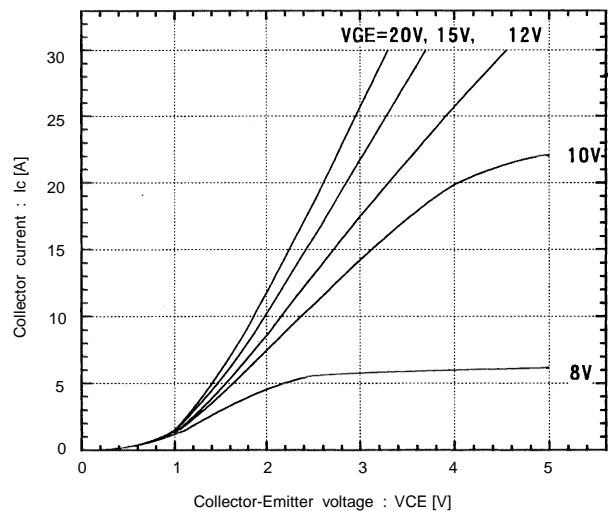

Collector-Emitter vs. Gate-Emitter voltage
T_J=25°C

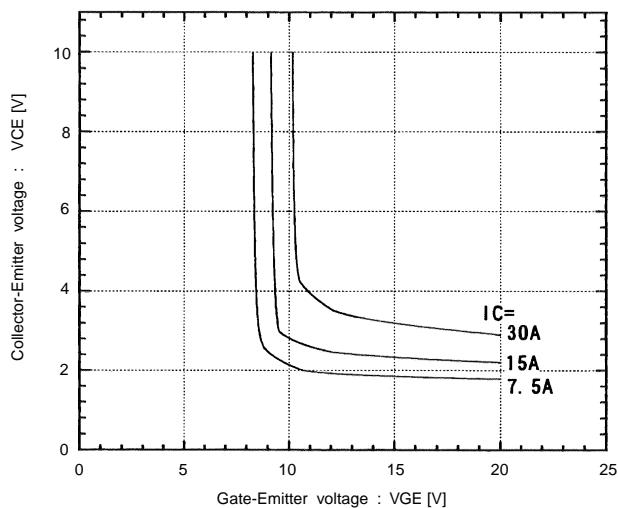

Collector-Emitter vs. Gate-Emitter voltage
T_J=125°C

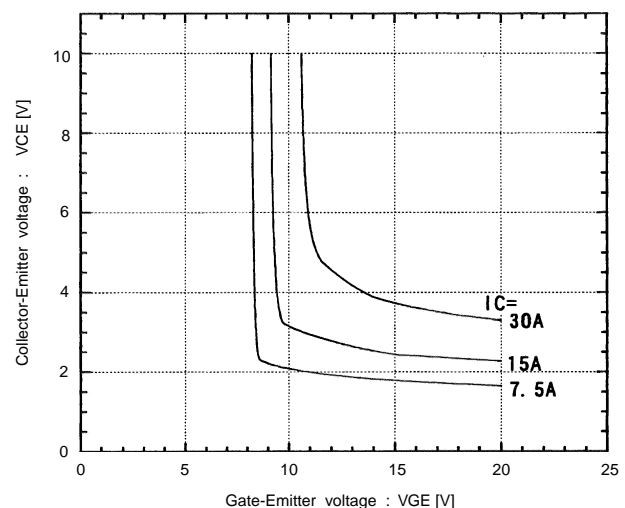

Switching time vs. Collector current
V_{CC}=300V, R_G=150 ohm, V_{GE}=±15V, T_J=25°C

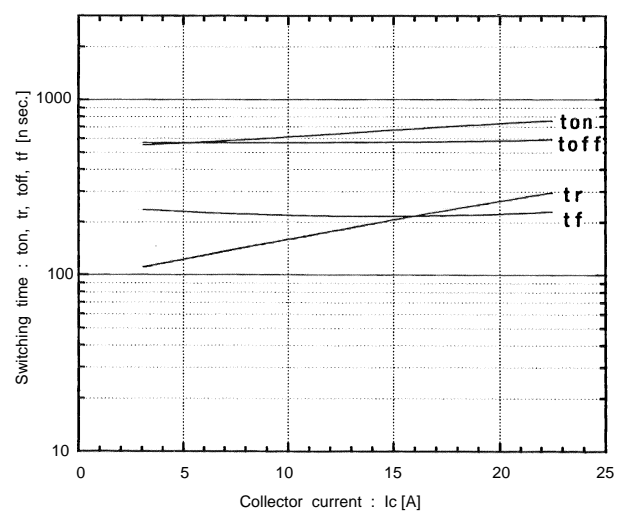

Switching time vs. Collector current
V_{CC}=300V, R_G=150 ohm, V_{GE}=±15V, T_J=125°C

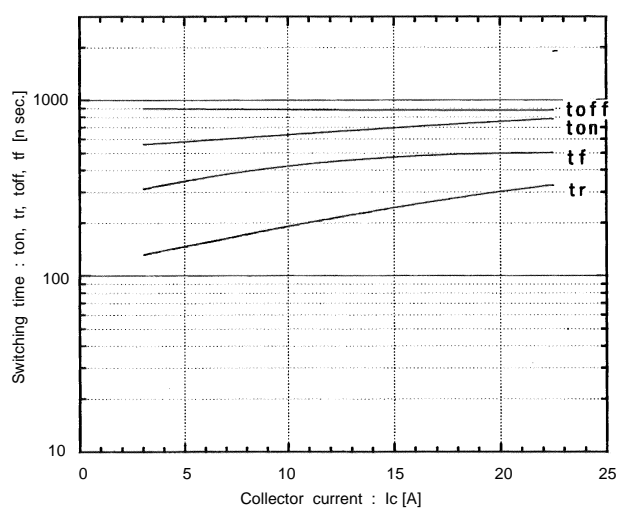

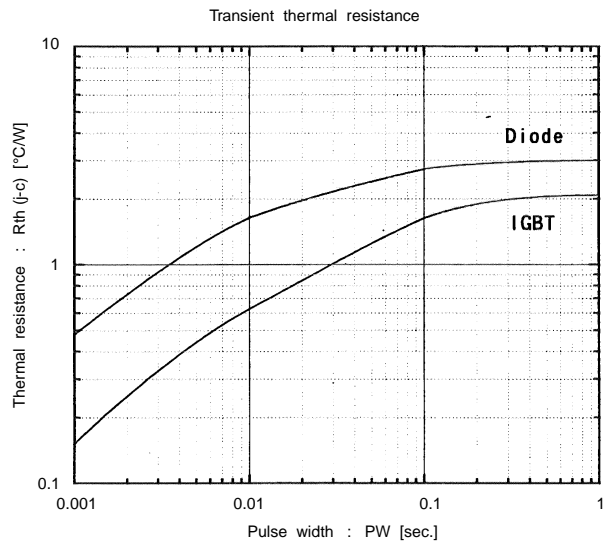
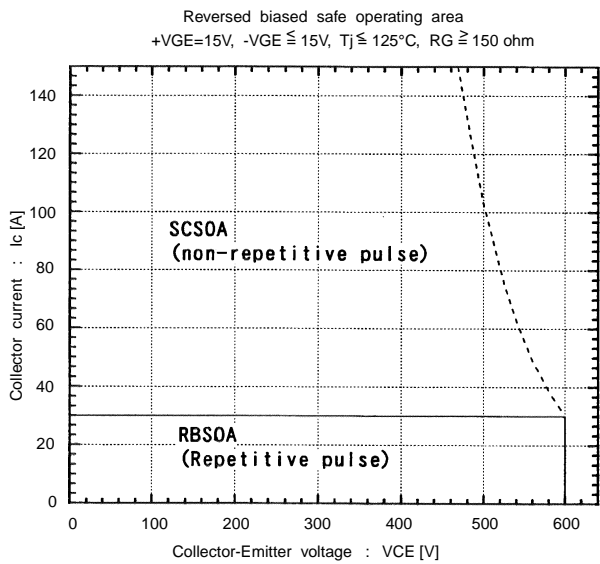
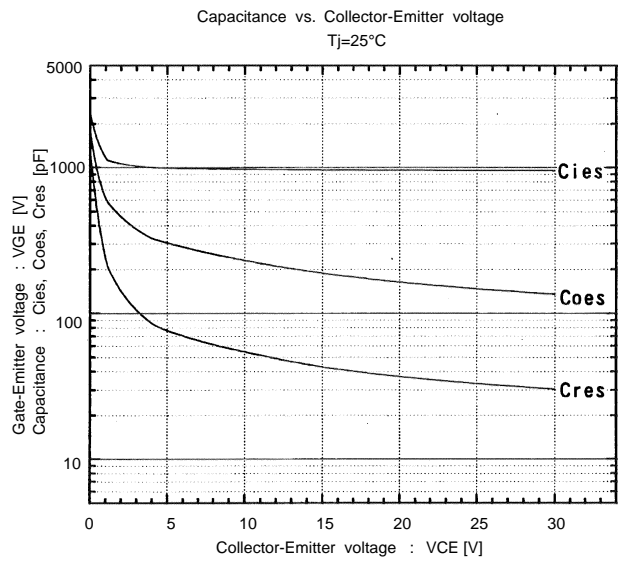
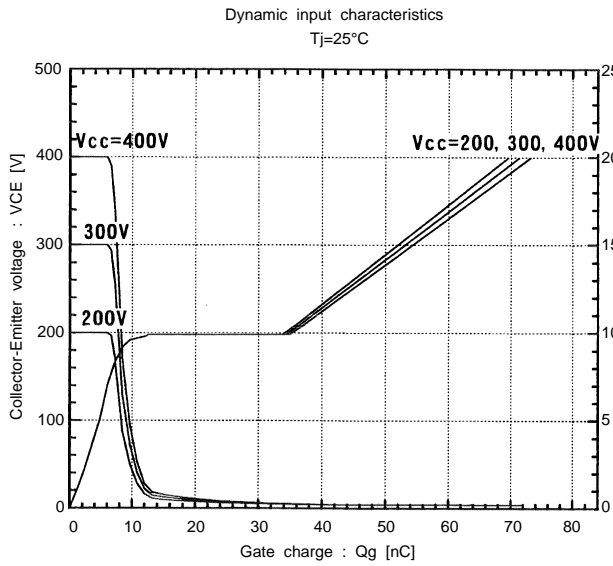
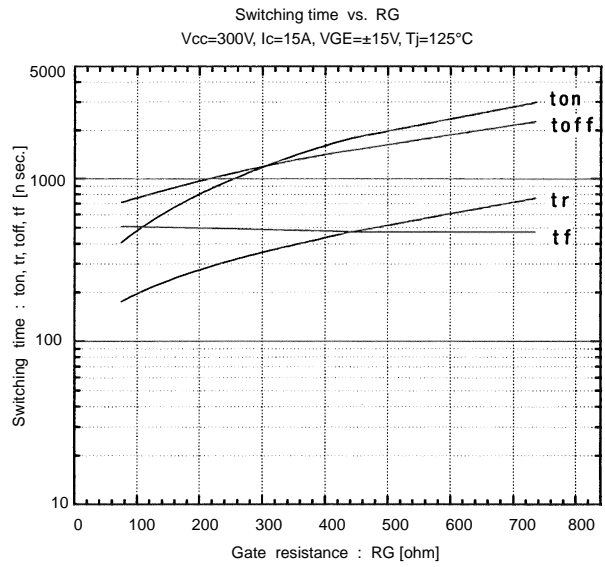
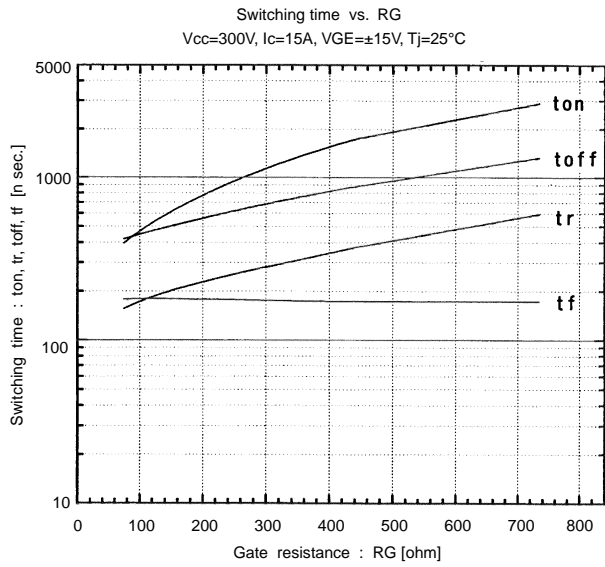

Switching loss vs. Collector current
 $V_{cc}=300V, R_G=150\ \text{ohm}, V_{GE}=\pm 15V, T_j=125^\circ\text{C}$

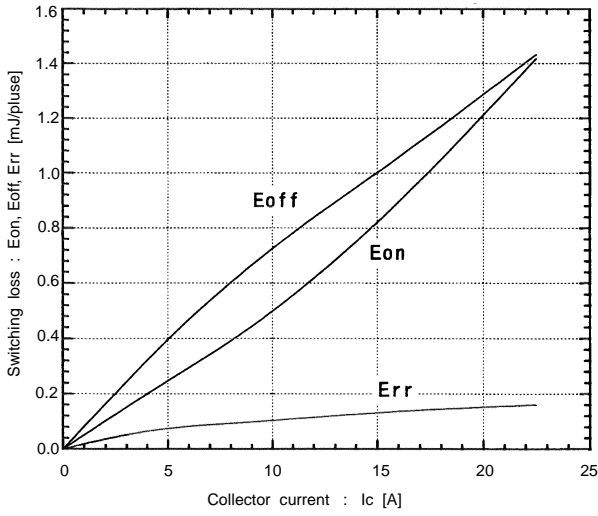

Switching loss vs. Gate resistance
 $V_{cc}=300V, I_c=15A, V_{GE}=\pm 15V, T_j=125^\circ\text{C}$

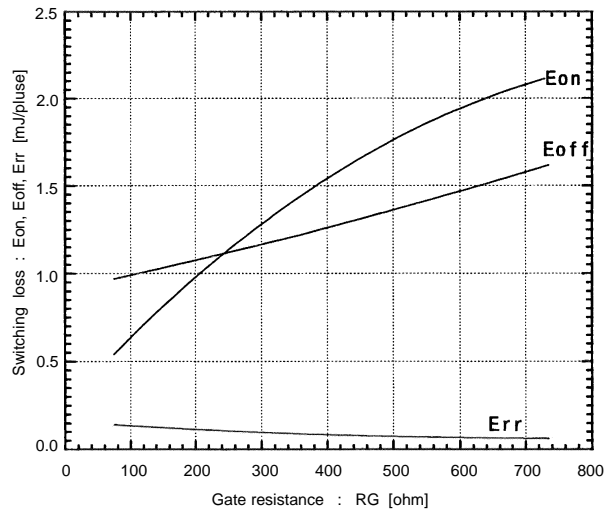

Forward current vs. Forward voltage

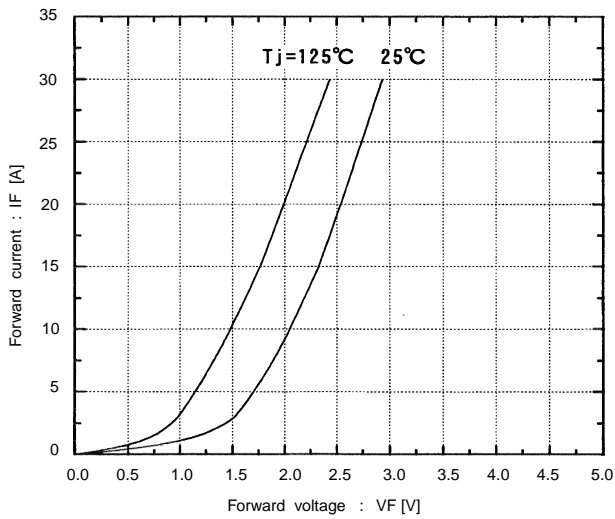

Reverse recovery characteristics
 t_{rr}, I_{rr} , vs. I_F

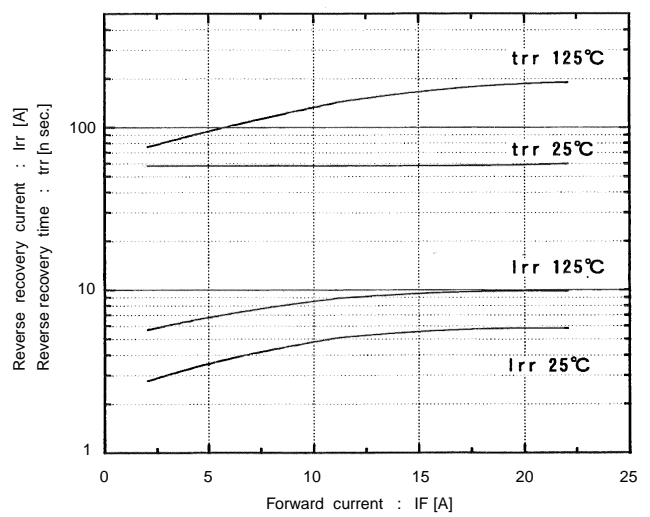

■ Outline Drawings, mm

