

LDC15F

LD C 15 F -1 -□

① ② ③ ④ ⑤ ⑥



RoHS

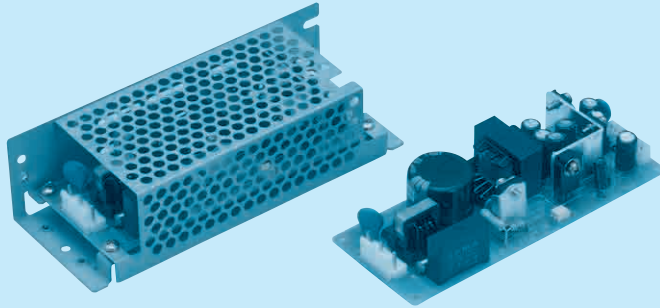

- ① Series name
- ② Multiple output
- ③ Output wattage
- ④ Universal input
- ⑤ Output voltage combination
- ⑥ Optional *4
 C :with Coating
 G :Low leakage current
 S :with Chassis
 SN :with Chassis & cover
 Y :with Potentiometer

LDC

| MODEL | LDC15F-1 | | LDC15F-2 | |
|-----------|----------|---------------------|---------------------|--|
| DC OUTPUT | V1 | +5V 2.0(Peak 3.0)A | +5V 2.0(Peak 3.0)A | |
| | V2 | +12V 0.3(Peak 0.6)A | +15V 0.3(Peak 0.6)A | |
| | V3 | -12V 0.2(Peak 0.3)A | -15V 0.2(Peak 0.3)A | |

SPECIFICATIONS

| | MODEL | LDC15F-1 | | | LDC15F-2 | | | |
|------------------------------------|--|--|--------------------|--------------------|--------------------|--------------------|--------------------|--------|
| INPUT | VOLTAGE[V] | AC85 - 264 1 φ or DC110 - 370 | | | | | | |
| | CURRENT[A] | ACIN 100V | 0.4typ (Io=100%) | | | | | |
| | FREQUENCY[Hz] | 47 - 440 or DC | | | | | | |
| | EFFICIENCY[%] | ACIN 100V | 70typ (Io=100%) | | | | | |
| | INRUSH CURRENT[A] | ACIN 100V | 25typ (Io=100%) | | | | | |
| | | ACIN 200V | 50typ (Io=100%) | | | | | |
| LEAKAGE CURRENT[ma] | 0.75max (60Hz, According to UL, CSA, VDE and DEN-AN) | | | | | | | |
| OUTPUT | VOLTAGE[V] | +5 | +12 | -12 | +5 | +15 | -15 | |
| | CURRENT[A] | *1 0 - 2.0 (Peak 3.0) | 0 - 0.3 (Peak 0.6) | 0 - 0.2 (Peak 0.3) | 0 - 2.0 (Peak 3.0) | 0 - 0.3 (Peak 0.6) | 0 - 0.2 (Peak 0.3) | |
| | LINE REGULATION[mV] | 20max | 48max | 48max | 20max | 60max | 60max | |
| | LOAD REGULATION[mV] | 100max | 120max | 120max | 100max | 150max | 150max | |
| | RIPPLE[mVp-p] | 0 to +50°C *2 | 100max | 120max | 120max | 100max | 120max | 120max |
| | | -10 - 0°C *2 | 140max | 160max | 160max | 140max | 160max | 160max |
| | RIPPLE NOISE[mVp-p] | 0 to +50°C *2 | 120max | 150max | 150max | 120max | 150max | 150max |
| | | -10 - 0°C *2 | 160max | 180max | 180max | 160max | 180max | 180max |
| | TEMPERATURE REGULATION[mV] | 0 to +50°C | 50max | 350max | 350max | 50max | 350max | 350max |
| | | -10 to +50°C | 60max | 420max | 420max | 60max | 420max | 420max |
| | DRIFT[mV] | *3 20max | — | — | 20max | — | — | |
| | START-UP TIME[ms] | 100max (ACIN 85V, Io=100%) | | | | | | |
| | HOLD-UP TIME[ms] | 10typ (ACIN 85V, Io=100%), 20typ (ACIN 100V, Io=100%), 100typ (ACIN 200V, Io=100%) | | | | | | |
| OUTPUT VOLTAGE ADJUSTMENT RANGE[V] | Fixed | Fixed | Fixed | Fixed | Fixed | Fixed | | |
| OUTPUT VOLTAGE SETTING[V] | 4.9 to 5.3 | 11.4 to 12.6 | -11.4 to -12.6 | 4.9 to 5.3 | 14.25 to 15.75 | -14.25 to -15.75 | | |
| PROTECTION CIRCUIT AND OTHERS | OVERCURRENT PROTECTION | Works over 105% of rating and recovers automatically | | | | | | |
| | OVERVOLTAGE PROTECTION | Works over 115% of rating by zener diode clamping (+5V only) | | | | | | |
| | OPERATING INDICATION | Not provided | | | | | | |
| | REMOTE SENSING | Not provided | | | | | | |
| ISOLATION | REMOTE ON/OFF | Not provided | | | | | | |
| | INPUT-OUTPUT | AC3,000V 1minute, Cutoff current = 10mA, DC500V 50MΩ min (At Room Temperature) | | | | | | |
| | INPUT-FG | AC2,000V 1minute, Cutoff current = 10mA, DC500V 50MΩ min (At Room Temperature) | | | | | | |
| | OUTPUT-FG | AC500V 1minute, Cutoff current = 100mA, DC500V 50MΩ min (At Room Temperature) | | | | | | |
| ENVIRONMENT | OUTPUT-OUTPUT(V1-V2,V3) | AC100V 1minute, Cutoff current = 100mA, DC100V 10MΩ min (At Room Temperature) | | | | | | |
| | OPERATING TEMP.,HUMID.AND ALTITUDE | -10 to +60°C, 20 - 90%RH (Non condensing) (Refer to DERATING CURVE), 3,000m (10,000feet) | | | | | | |
| | STORAGE TEMP.,HUMID.AND ALTITUDE | -20 to +75°C, 20 - 90%RH (Non condensing), 9,000m (30,000feet) | | | | | | |
| | VIBRATION | 10 - 55Hz, 19.6m/s ² (2G), 3minutes period, 60minutes each along X, Y and Z axis | | | | | | |
| SAFETY AND NOISE REGULATIONS | IMPACT | 196.1m/s ² (20G), 11ms, once each X, Y and Z axis | | | | | | |
| | AGENCY APPROVALS | UL60950-1, EN60950-1, EN50178, CSA C22.2 No.60950-1 Complies with DEN-AN and IEC60950-1 | | | | | | |
| | CONDUCTED NOISE | Complies with FCC-B, CISPR22-B, EN55022-B, VCCI-B | | | | | | |
| OTHERS | CASE SIZE/WEIGHT | 50 X 26 X 127mm [1.97 X 1.02 X 5 inches] (W X H X D) /150g max (with chassis & cover : 300g max) | | | | | | |
| | COOLING METHOD | Convection | | | | | | |

*1 Peak load for 10sec. or less is acceptable if the total wattage is less than the rated wattage(-1: 16W, -2: 17.5W).When the load of +5V is OA, other output can be drawn by 80% of rated current.
 *2 Measured by 20MHz oscilloscope or Ripple-Noise meter (equivalent to KEISOKU-GIKEN:RM101).
 *3 Drift is the change in DC output for an eight hour period after a half-hour warm-up at 25°C with the input voltage held constant at the rated input/output.
 *4 Please contact us about safety approvals for the model with option.
 * Avoid prolonged use under over-load.
 * Derating is required when operated with chassis and cover.

External view

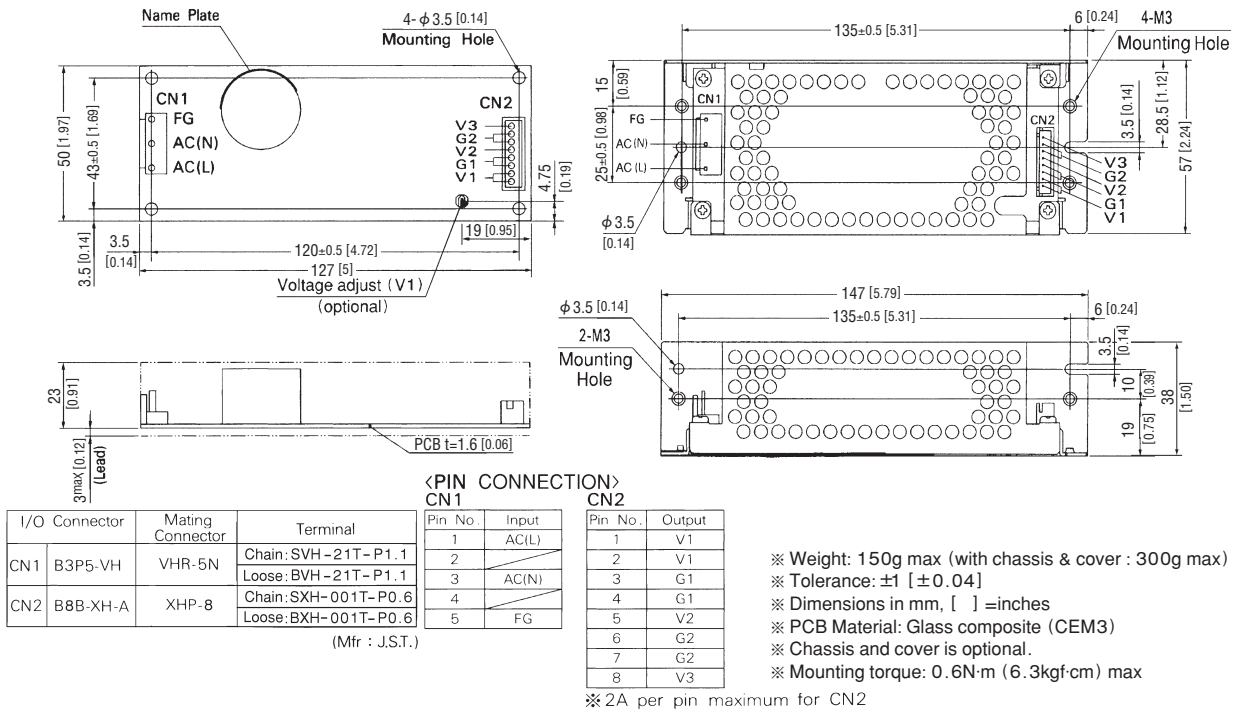

Performance data

■ STATIC CHARACTERISTICS (LDC15F-1)

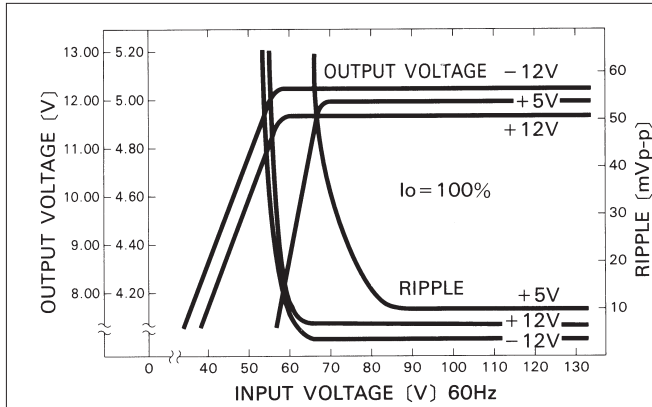

■ RISE TIME & FALL TIME (LDC15F-1)

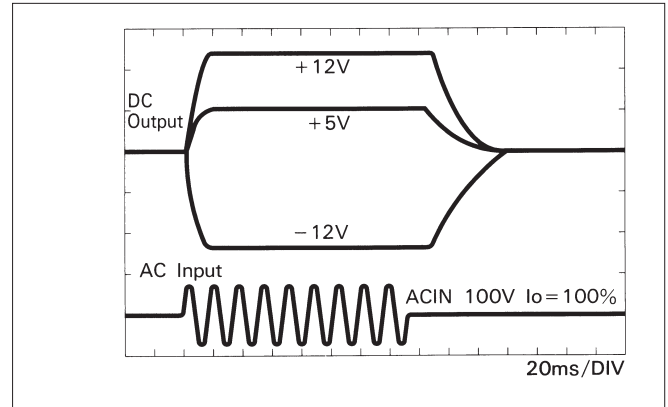

■ OVERCURRENT CHARACTERISTICS (LDC15F-1)

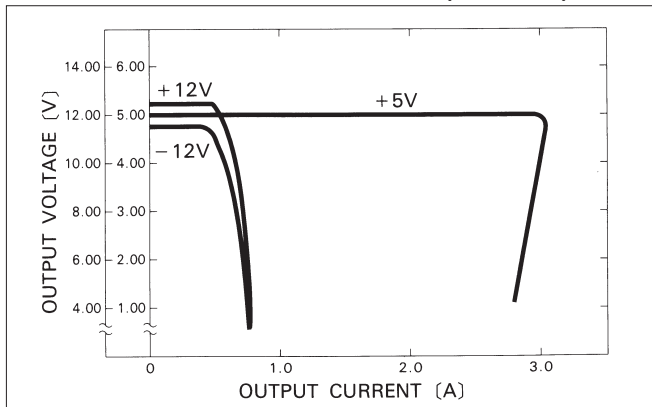

■ DERATING CURVE

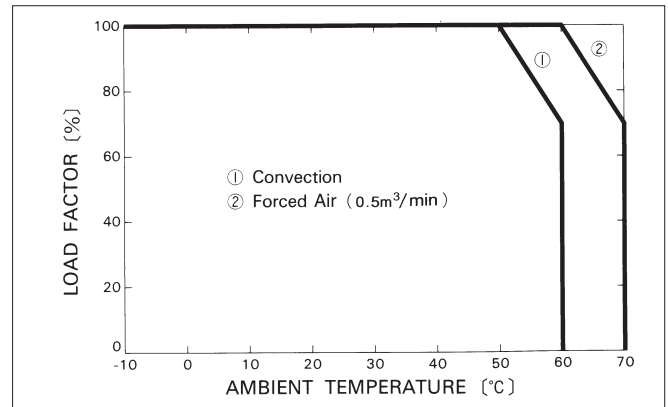

LDC30F

LD C 30 F -1 -□

① ② ③ ④ ⑤ ⑥

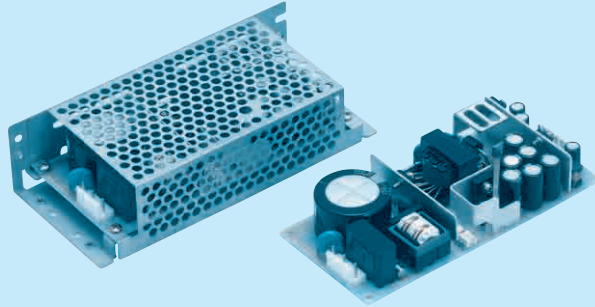

- ① Series name
 - ② Multiple output
 - ③ Output wattage
 - ④ Universal input
 - ⑤ Output voltage combination
 - ⑥ Optional *4
- C :with Coating
 G :Low leakage current
 S :with Chassis
 SN :with Chassis & cover
 Y :with Potentiometer

LDC

| MODEL | LDC30F-1 | LDC30F-2 |
|-----------|--|---|
| DC OUTPUT | V1 +5V 3.0(Peak 4.5)A V2 +12V 1.2(Peak 2.0)A V3 -12V 0.3(Peak 0.45)A | +5V 3.0(Peak 4.5)A +15V 1.0(Peak 2.0)A -15V 0.3(Peak 0.45)A |

SPECIFICATIONS

| | MODEL | LDC30F-1 | LDC30F-2 | | | | | |
|-------------------------------|------------------------------------|--|--|---------------------|--------------------|--------------------|---------------------|--------|
| INPUT | VOLTAGE[V] | AC85 - 264 1 φ or DC110 - 370 | | | | | | |
| | CURRENT[A] | ACIN 100V | 0.8typ (Io=100%) | | | | | |
| | FREQUENCY[Hz] | | 47 - 440 or DC | | | | | |
| | EFFICIENCY[%] | ACIN 100V | 72typ (Io=100%) | | | | | |
| | INRUSH CURRENT[A] | ACIN 100V | 25typ (Io=100%) (At cold start) | | | | | |
| | | ACIN 200V | 50typ (Io=100%) (At cold start) | | | | | |
| | LEAKAGE CURRENT[ma] | | 0.75max (60Hz, According to UL, CSA, VDE and DEN-AN) | | | | | |
| OUTPUT | VOLTAGE[V] | +5 | +12 | -12 | +5 | +15 | -15 | |
| | CURRENT[A] | *1 0 - 3.0 (Peak 4.5) | 0 - 1.2 (Peak 2.0) | 0 - 0.3 (Peak 0.45) | 0 - 3.0 (Peak 4.5) | 0 - 1.0 (Peak 2.0) | 0 - 0.3 (Peak 0.45) | |
| | LINE REGULATION[mV] | 20max | 48max | 48max | 20max | 60max | 60max | |
| | LOAD REGULATION[mV] | 100max | 120max | 150max | 100max | 120max | 150max | |
| | RIPPLE[mVp-p] | 0 to +50°C *2 | 100max | 120max | 120max | 100max | 120max | 120max |
| | | -10 - 0°C *2 | 150max | 160max | 160max | 150max | 160max | 160max |
| | RIPPLE NOISE[mVp-p] | 0 to +50°C *2 | 120max | 150max | 150max | 120max | 150max | 150max |
| | | -10 - 0°C *2 | 170max | 180max | 180max | 170max | 180max | 180max |
| | TEMPERATURE REGULATION[mV] | 0 to +50°C | 50max | 350max | 350max | 50max | 350max | 350max |
| | | -10 to +50°C | 60max | 420max | 420max | 60max | 420max | 420max |
| | DRIFT[mV] | *3 20max | — | — | 20max | — | — | |
| | START-UP TIME[ms] | 100max (ACIN 85V, Io=100%) | | | | | | |
| | HOLD-UP TIME[ms] | 10typ (ACIN 85V, Io=100%), 20typ (ACIN 100V, Io=100%), 100typ (ACIN 200V, Io=100%) | | | | | | |
| | OUTPUT VOLTAGE ADJUSTMENT RANGE[V] | Fixed | Fixed | Fixed | Fixed | Fixed | Fixed | |
| OUTPUT VOLTAGE SETTING[V] | 4.9 to 5.3 | 11.4 to 12.6 | -11.4 to -12.6 | 4.9 to 5.3 | 14.25 to 15.75 | -14.25 to -15.75 | | |
| PROTECTION CIRCUIT AND OTHERS | OVERCURRENT PROTECTION | Works over 105% of rating and recovers automatically | | | | | | |
| | OVERVOLTAGE PROTECTION | Works at 115 - 140% of rating (+5V only) | | | | | | |
| | OPERATING INDICATION | Not provided | | | | | | |
| | REMOTE SENSING | Not provided | | | | | | |
| ISOLATION | REMOTE ON/OFF | Not provided | | | | | | |
| | INPUT-OUTPUT | AC3,000V 1minute, Cutoff current = 10mA, DC500V 50MΩ min (At Room Temperature) | | | | | | |
| | INPUT-FG | AC2,000V 1minute, Cutoff current = 10mA, DC500V 50MΩ min (At Room Temperature) | | | | | | |
| | OUTPUT-FG | AC500V 1minute, Cutoff current = 100mA, DC500V 50MΩ min (At Room Temperature) | | | | | | |
| ENVIRONMENT | OUTPUT-OUTPUT(V1-V2,V3) | AC100V 1minute, Cutoff current = 100mA, DC100V 10MΩ min (At Room Temperature) | | | | | | |
| | OPERATING TEMP.,HUMID.AND ALTITUDE | -10 to +60°C, 20 - 90%RH (Non condensing) (Refer to DERATING CURVE), 3,000m (10,000feet) | | | | | | |
| | STORAGE TEMP.,HUMID.AND ALTITUDE | -20 to +75°C, 20 - 90%RH (Non condensing), 9,000m (30,000feet) | | | | | | |
| | VIBRATION | 10 - 55Hz, 19.6m/s ² (2G), 3minutes period, 60minutes each along X, Y and Z axis | | | | | | |
| SAFETY AND NOISE REGULATIONS | IMPACT | 196.1m/s ² (20G), 11ms, once each X, Y and Z axis | | | | | | |
| | AGENCY APPROVALS | UL60950-1, EN60950-1, EN50178, CSA C22.2 No.60950-1 Complies with DEN-AN and IEC60950-1 | | | | | | |
| | CONDUCTED NOISE | Complies with FCC-B, CISPR22-B, EN55022-B, VCCI-B | | | | | | |
| OTHERS | CASE SIZE/WEIGHT | 65 x 26 x 140mm [2.56 x 1.02 x 5.51 inches] (W x H x D) / 220g max (with chassis & cover : 400g max) | | | | | | |
| | COOLING METHOD | Convection | | | | | | |

*1 Peak load for 10sec. or less is acceptable if the total wattage is less than the rated wattage(-1: 33W, -2: 34.5W).When the load of +5V is OA, other output can be drawn by 80% of rated current.
 *2 Measured by 20MHz oscilloscope or Ripple-Noise meter (equivalent to KEISOKU-GIKEN:RM101).
 *3 Drift is the change in DC output for an eight hour period after a half-hour warm-up at 25°C with the input voltage held constant at the rated input/output.
 *4 Please contact us about safety approvals for the model with option.
 * Avoid prolonged use under over-load.
 * Derating is required when operated with chassis and cover.

External view

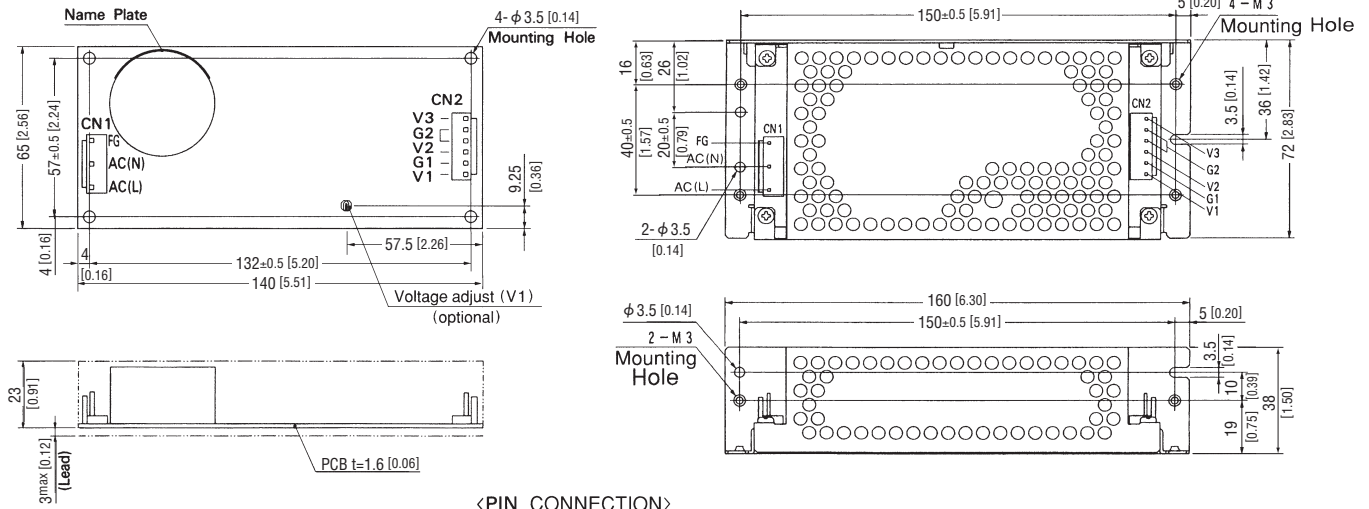

LDC

<PIN CONNECTION>

| I/O Connector | Mating Connector | Terminal | |
|---------------|------------------|----------|--------------------|
| CN1 | B3P5-VH | VHR-5N | Chain:SVH-21T-P1.1 |
| | | | Loose:BVH-21T-P1.1 |
| CN2 | B6P-VH | VHR-6N | Chain:SVH-21T-P1.1 |
| | | | Loose:BVH-21T-P1.1 |

(Mfr : J.S.T.)

| CN1 | |
|---------|-------|
| Pin No. | Input |
| 1 | AC(L) |
| 2 | |
| 3 | AC(N) |
| 4 | |
| 5 | FG |

| CN2 | |
|---------|--------|
| Pin No. | Output |
| 1 | V3 |
| 2 | G2 |
| 3 | G2 |
| 4 | V2 |
| 5 | G1 |
| 6 | V1 |

- ※ Weight: 220g max (with chassis & cover : 400g max)
- ※ Tolerance: ±1 [±0.04]
- ※ Dimensions in mm, [] =inches
- ※ PCB Material: Glass composite (CEM3)
- ※ Chassis and cover is optional.
- ※ Mounting torque: 0.6N·m (6.3kgf·cm) max

Performance data

■STATIC CHARACTERISTICS (LDC30F-1)

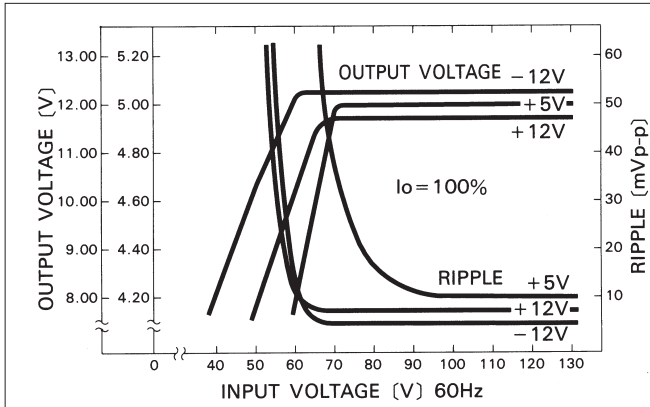

■RISE TIME & FALL TIME (LDC30F-1)

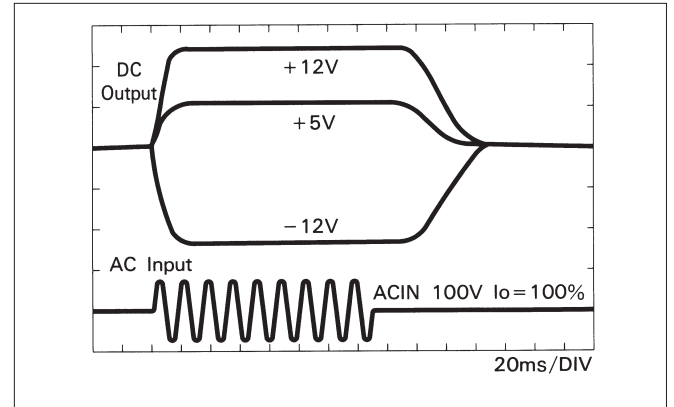

■OVERCURRENT CHARACTERISTICS (LDC30F-1)

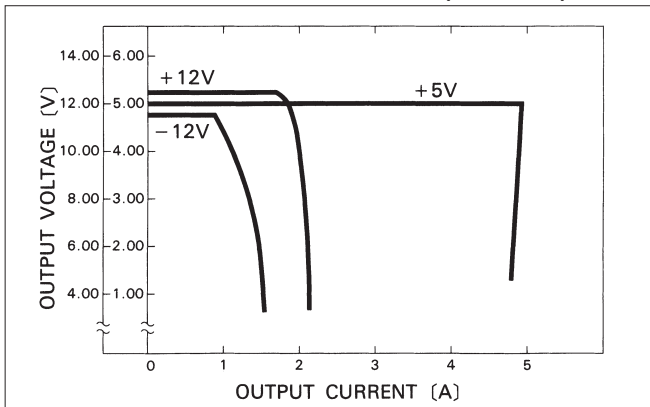

■DERATING CURVE

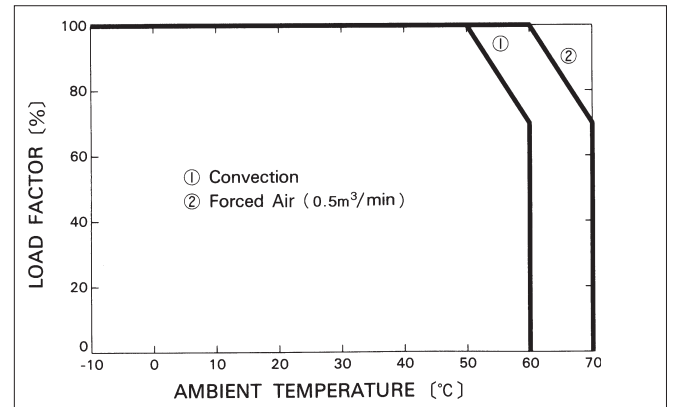

LDC60F

LD C 60 F -1 -□

① ② ③ ④ ⑤ ⑥

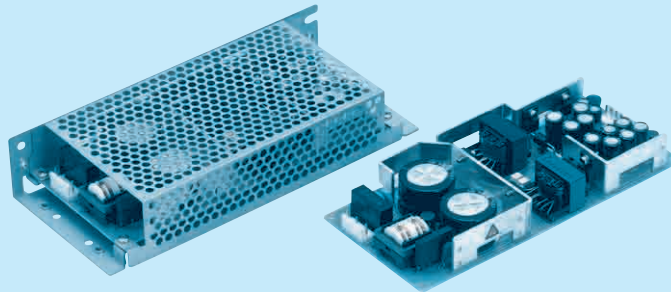

- ① Series name
- ② Multiple output
- ③ Output wattage
- ④ Universal input
- ⑤ Output voltage combination
- ⑥ Optional *4
 C :with Coating
 G :Low leakage current
 S :with Chassis
 SN :with Chassis & cover
 Y :with Potentiometer

LDC

| MODEL | LDC60F-1 | | LDC60F-2 | |
|-----------|----------|---------------------|---------------------|--|
| DC OUTPUT | V1 | +5V 5.0(Peak 7.0)A | +5V 5.0(Peak 7.0)A | |
| | V2 | +12V 2.5(Peak 3.5)A | +15V 2.0(Peak 3.5)A | |
| | V3 | -12V 0.5(Peak 0.7)A | -15V 0.5(Peak 0.7)A | |

SPECIFICATIONS

| | MODEL | LDC60F-1 | | | LDC60F-2 | | | |
|------------------------------------|--|--|---------------------------------|--------------------|--------------------|--------------------|--------------------|--------|
| INPUT | VOLTAGE[V] | AC85 - 264 1φ or DC110 - 370 | | | | | | |
| | CURRENT[A] | ACIN 100V | 1.4typ (Io=100%) | | | | | |
| | FREQUENCY[Hz] | 47 - 440 or DC | | | | | | |
| | EFFICIENCY[%] | ACIN 100V | 72typ (Io=100%) | | | | | |
| | INRUSH CURRENT[A] | ACIN 100V | 30typ (Io=100%) (At cold start) | | | | | |
| | | ACIN 200V | 60typ (Io=100%) (At cold start) | | | | | |
| LEAKAGE CURRENT[ma] | 0.75max (60Hz, According to UL, CSA, VDE and DEN-AN) | | | | | | | |
| OUTPUT | VOLTAGE[V] | +5 | +12 | -12 | +5 | +15 | -15 | |
| | CURRENT[A] | *1 0 - 5.0 (Peak 7.0) | 0 - 2.5 (Peak 3.5) | 0 - 0.5 (Peak 0.7) | 0 - 5.0 (Peak 7.0) | 0 - 2.0 (Peak 3.5) | 0 - 0.5 (Peak 0.7) | |
| | LINE REGULATION[mV] | 20max | 48max | 48max | 20max | 60max | 60max | |
| | LOAD REGULATION[mV] | 100max | 150max | 150max | 100max | 150max | 150max | |
| | RIPPLE[mVp-p] | 0 to +50°C *2 | 100max | 120max | 120max | 100max | 120max | 120max |
| | | -10 - 0°C *2 | 150max | 160max | 160max | 150max | 160max | 160max |
| | RIPPLE NOISE[mVp-p] | 0 to +50°C *2 | 120max | 150max | 150max | 120max | 150max | 150max |
| | | -10 - 0°C *2 | 170max | 180max | 180max | 170max | 180max | 180max |
| | TEMPERATURE REGULATION[mV] | 0 to +50°C | 50max | 350max | 350max | 50max | 350max | 350max |
| | | -10 to +50°C | 60max | 420max | 420max | 60max | 420max | 420max |
| | DRIFT[mV] | *3 20max | — | — | 20max | — | — | |
| | START-UP TIME[ms] | 200max (ACIN 85V, Io=100%) | | | | | | |
| | HOLD-UP TIME[ms] | 10typ (ACIN 85V, Io=100%), 20typ (ACIN 100V, Io=100%), 100typ (ACIN 200V, Io=100%) | | | | | | |
| OUTPUT VOLTAGE ADJUSTMENT RANGE[V] | Fixed | Fixed | Fixed | Fixed | Fixed | Fixed | | |
| OUTPUT VOLTAGE SETTING[V] | 4.9 to 5.3 | 11.4 to 12.6 | -11.4 to -12.6 | 4.9 to 5.3 | 14.25 to 15.75 | -14.25 to -15.75 | | |
| PROTECTION CIRCUIT AND OTHERS | OVERCURRENT PROTECTION | Works over 105% of rating and recovers automatically | | | | | | |
| | OVERVOLTAGE PROTECTION | Works over 115% of rating by zener diode clamping (only available with V1, V2) | | | | | | |
| | OPERATING INDICATION | Not provided | | | | | | |
| | REMOTE SENSING | Not provided | | | | | | |
| ISOLATION | REMOTE ON/OFF | Not provided | | | | | | |
| | INPUT-OUTPUT | AC3.000V 1minute, Cutoff current = 10mA, DC500V 50MΩ min (At Room Temperature) | | | | | | |
| | INPUT-FG | AC2.000V 1minute, Cutoff current = 10mA, DC500V 50MΩ min (At Room Temperature) | | | | | | |
| | OUTPUT-FG | AC500V 1minute, Cutoff current = 100mA, DC500V 50MΩ min (At Room Temperature) | | | | | | |
| ENVIRONMENT | OUTPUT-OUTPUT(V1-V2,V3) | AC100V 1minute, Cutoff current = 100mA, DC100V 10MΩ min (At Room Temperature) | | | | | | |
| | OPERATING TEMP.,HUMID.AND ALTITUDE | -10 to +60°C, 20 - 90%RH (Non condensing) (Refer to DERATING CURVE), 3,000m (10,000feet) | | | | | | |
| | STORAGE TEMP.,HUMID.AND ALTITUDE | -20 to +75°C, 20 - 90%RH (Non condensing), 9,000m (30,000feet) | | | | | | |
| | VIBRATION | 10 - 55Hz, 19.6m/s ² (2G), 3minutes period, 60minutes each along X, Y and Z axis | | | | | | |
| SAFETY AND NOISE REGULATIONS | IMPACT | 196.1m/s ² (20G), 11ms, once each X, Y and Z axis | | | | | | |
| | AGENCY APPROVALS | UL60950-1, EN60950-1, EN50178, CSA C22.2 No.60950-1 Complies with DEN-AN and IEC60950-1 | | | | | | |
| | CONDUCTED NOISE | Complies with FCC-B, CISPR22-B, EN55022-B, VCCI-B | | | | | | |
| OTHERS | CASE SIZE/WEIGHT | 83 x 26 x 185mm [3.27 x 1.02 x 7.28 inches] (W x H x D) / 300g max (with chassis & cover : 550g max) | | | | | | |
| | COOLING METHOD | Convection | | | | | | |

*1 Peak load for 10sec. or less is acceptable if the total wattage is less than the rated wattage(-1: 61W, -2: 62.5W).When the load of +5V is OA, other output can be drawn by 80% of rated current.
 *2 Measured by 20MHz oscilloscope or Ripple-Noise meter (equivalent to KEISOKU-GIKEN:RM101).
 *3 Drift is the change in DC output for an eight hour period after a half-hour warm-up at 25°C with the input voltage held constant at the rated input/output.
 *4 Please contact us about safety approvals for the model with option.
 * Avoid prolonged use under over-load.
 * Derating is required when operated with chassis and cover.

External view

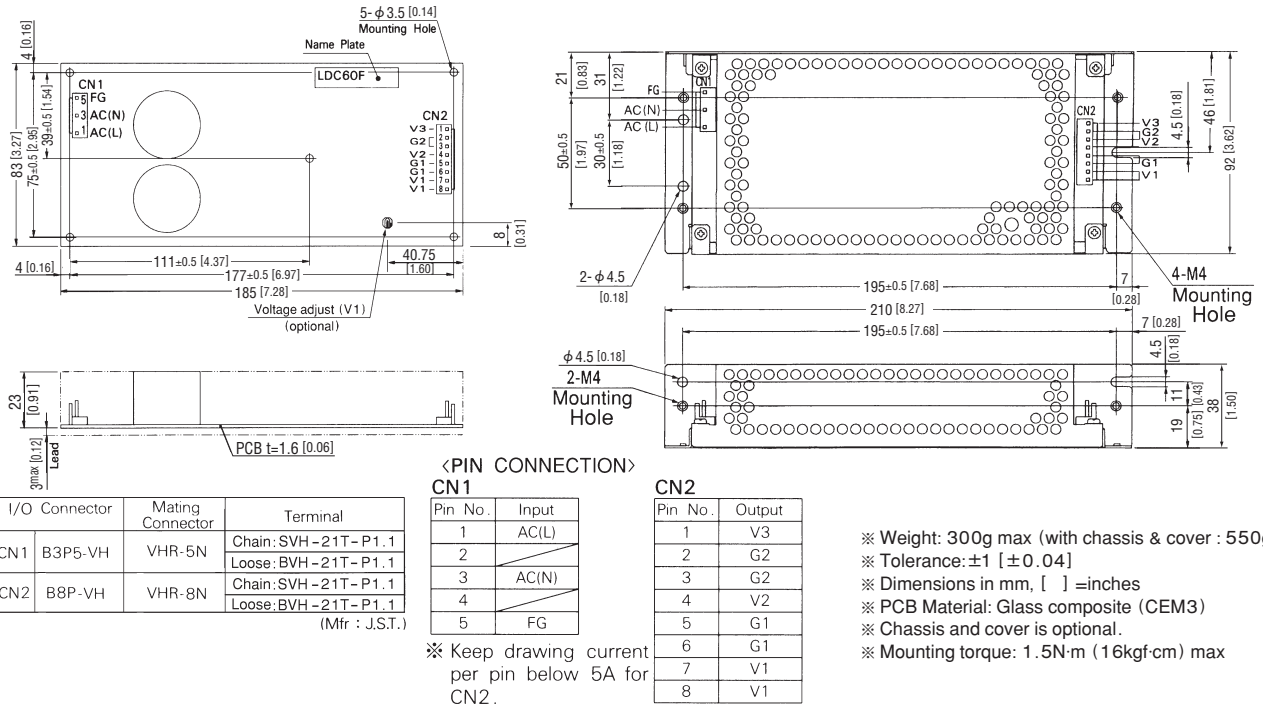

LDC

Performance data

■STATIC CHARACTERISTICS (LDC60F-1)

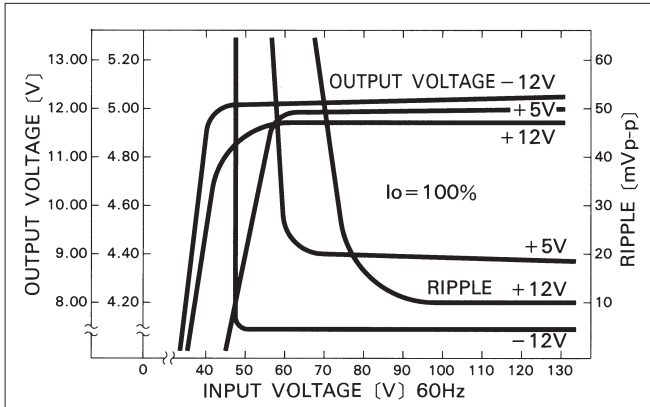

■RISE TIME & FALL TIME (LDC60F-1)

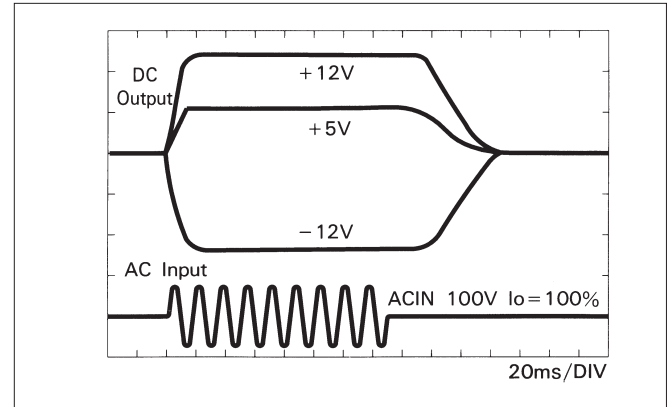

■OVERCURRENT CHARACTERISTICS (LDC60F-1)

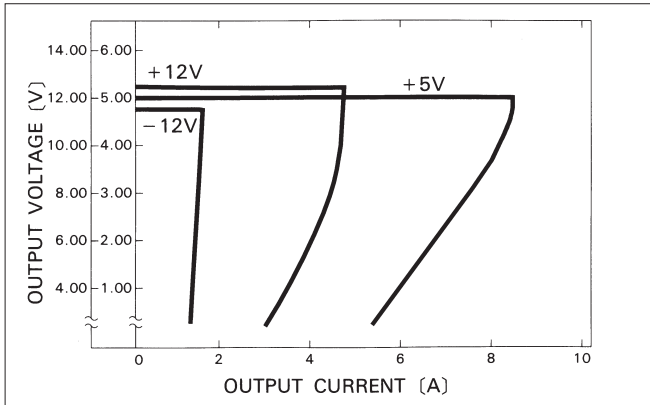

■DERATING CURVE

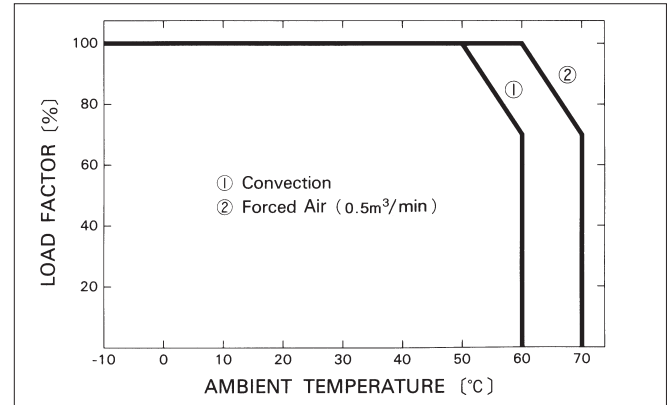

Mouser Electronics

Authorized Distributor

Click to View Pricing, Inventory, Delivery & Lifecycle Information:

Cosel:

[LDC60F-1-S](#) [S-LDC30](#) [LDC15F-1-SN](#) [LDC30F-1-S](#) [LDC30F-1-C](#) [LDC15F-2-G](#) [LDC15F-2-SY](#) [LDC15F-1](#)
[LDC15F-1-Y](#) [LDC30F-1-SY](#) [LDC30F-2-SNC](#) [LDC60F-1-SNCY](#) [LDC30F-2-SNY](#) [LDC60F-2-SN](#) [N-LDC15](#) [LDC15F-1-](#)
[S](#) [LDC60F-2-G](#) [LDC30F-1-SNG](#) [LDC15F-2-SG](#) [LDC15F-2-SNY](#) [LDC30F-2-SNG](#) [LDC30F-1-SNY](#) [LDC30F-2-C](#)
[LDC60F-2-SNY](#) [LDC60F-2-CY](#) [LDC60F-1-Y](#) [LDC30F-2-SN](#) [LDC30F-1-SNCY](#) [LDC30F-2-Y](#) [LDC60F-1-Q](#) [LDC60F-1-](#)
[CY](#) [LDC15F-1-SY](#) [LDC30F-1](#) [LDC15F-1-G](#) [LDC60F-2-S](#) [LDC15F-2-C](#) [LDC60F-1-SNC](#) [LDC30F-1-SNC](#) [LDC15F-2-](#)
[SNG](#) [N-LDC60](#) [LDC60F-1-GY](#) [LDC60F-2-C](#) [LDC60F-2-SNC](#) [LDC15F-2-S](#) [LDC15F-1-SC](#) [S-LDC60](#) [LDC60F-2](#)
[LDC60F-1-SNY](#) [LDC60F-2-SNCY](#) [LDC60F-1-C](#) [LDC30F-2](#) [LDC15F-2](#) [LDC30F-2-SNCY](#) [LDC30F-2-G](#) [LDC15F-1-](#)
[SG](#) [LDC30F-2-S](#) [LDC60F-2-Y](#) [LDC15F-1-SNY](#) [LDC30F-1-GY](#) [LDC15F-2-SC](#) [S-LDC15](#) [LDC60F-1-SY](#) [LDC15F-2-Y](#)
[LDC15F-1-C](#) [LDC60F-1](#) [LDC15F-2-SN](#) [LDC30F-1-SNGY](#) [LDC60F-2-Q](#) [N-LDC30](#) [LDC30F-1-Y](#) [LDC60F-2-SY](#)
[LDC60F-1-G](#) [LDC15F-1-SNC](#) [LDC30F-2-SY](#) [LDC30F-1-G](#) [LDC60F-1-SN](#) [LDC30F-1-SN](#)