

Elektrische Eigenschaften / Electrical properties

Höchstzulässige Werte / Maximum rated values

Diode Gleichrichter/ Diode Rectifier

| | | | | |
|---|---|-------------|------------|------------------|
| Periodische Rückw. Spitzenspernung repetitive peak reverse voltage | | V_{RRM} | 1600 | V |
| Durchlaßstrom Grenzeffektivwert RMS forward current per chip | | I_{FRMSM} | 40 | A |
| Dauergleichstrom DC forward current | $T_C = 80^\circ C$ | I_d | 15 | A |
| Stoßstrom Grenzwert surge forward current | $t_p = 10 \text{ ms}, T_{vj} = 25^\circ C$ $t_p = 10 \text{ ms}, T_{vj} = 150^\circ C$ | I_{FSM} | 300 230 | A A |
| Grenzlastintegral I^2t - value | $t_p = 10 \text{ ms}, T_{vj} = 25^\circ C$ $t_p = 10 \text{ ms}, T_{vj} = 150^\circ C$ | I^2t | 450 260 | A^2s A^2s |

Transistor Wechselrichter/ Transistor Inverter

| | | | | |
|--|--|-----------------------|----------|--------|
| Kollektor-Emitter-Spernung collector-emitter voltage | | V_{CES} | 1200 | V |
| Kollektor-Dauergleichstrom DC-collector current | $T_C = 80^\circ C$ $T_C = 25^\circ C$ | $I_{C,nom.}$ I_C | 15 35 | A A |
| Periodischer Kollektor Spitzenstrom repetitive peak collector current | $t_p = 1 \text{ ms}, T_C = 80^\circ C$ | I_{CRM} | 30 | A |
| Gesamt-Verlustleistung total power dissipation | $T_C = 25^\circ C$ | P_{tot} | 180 | W |
| Gate-Emitter-Spernung gate-emitter peak voltage | | V_{GES} | +/- 20V | V |

Diode Wechselrichter/ Diode Inverter

| | | | | |
|--|---|-----------|-----|--------|
| Dauergleichstrom DC forward current | $T_C = 80^\circ C$ | I_F | 15 | A |
| Periodischer Spitzenstrom repetitive peak forw. current | $t_p = 1 \text{ ms}$ | I_{FRM} | 30 | A |
| Grenzlastintegral I^2t - value | $V_R = 0V, t_p = 10\text{ms}, T_{vj} = 125^\circ C$ | I^2t | 125 | A^2s |

Transistor Brems-Chopper/ Transistor Brake-Chopper

| | | | | |
|--|--|-----------------------|----------|--------|
| Kollektor-Emitter-Spernung collector-emitter voltage | | V_{CES} | 1200 | V |
| Kollektor-Dauergleichstrom DC-collector current | $T_C = 80^\circ C$ $T_C = 25^\circ C$ | $I_{C,nom.}$ I_C | 10 20 | A A |
| Periodischer Kollektor Spitzenstrom repetitive peak collector current | $t_p = 1 \text{ ms}, T_C = 80^\circ C$ | I_{CRM} | 20 | A |
| Gesamt-Verlustleistung total power dissipation | $T_C = 25^\circ C$ | P_{tot} | 100 | W |
| Gate-Emitter-Spernung gate-emitter peak voltage | | V_{GES} | +/- 20V | V |

Diode Brems-Chopper/ Diode Brake-Chopper

| | | | | |
|--|----------------------|-----------|----|---|
| Dauergleichstrom DC forward current | $T_C = 80^\circ C$ | I_F | 10 | A |
| Periodischer Spitzenstrom repetitive peak forw. current | $t_p = 1 \text{ ms}$ | I_{FRM} | 20 | A |

| | |
|-----------------------------|--------------------------------|
| prepared by: Andreas Schulz | date of publication:29.03.2001 |
| approved by: Robert Severin | revision: 6 |

Technische Information / Technical Information

IGBT-Module
IGBT-Modules

BSM15GP120

eupec



Modul Isolation/ Module Isolation

| | | | | |
|--|--|-------------------|-----|----|
| Isolations-Prüfspannung insulation test voltage | RMS, f = 50 Hz, t = 1 min. NTC connected to Baseplate | V _{ISOL} | 2,5 | kV |
|--|--|-------------------|-----|----|

Elektrische Eigenschaften / Electrical properties

Charakteristische Werte / Characteristic values

Diode Gleichrichter/ Diode Rectifier

| | | | min. | typ. | max. | |
|--|--|--------------------|------|------|------|----|
| Durchlaßspannung forward voltage | T _{vj} = 150°C, I _F = 15 A | V _F | - | 0,95 | 1 | V |
| Schleusenspannung threshold voltage | T _{vj} = 150°C | V _(TO) | - | - | 0,8 | V |
| Ersatzwiderstand slope resistance | T _{vj} = 150°C | r _T | - | - | 10,5 | mΩ |
| Sperrstrom reverse current | T _{vj} = 150°C, V _R = 1600 V | I _R | - | 2 | - | mA |
| Modul Leitungswiderstand, Anschlüsse-Chip lead resistance, terminals-chip | T _C = 25°C | R _{AA+CC} | - | 8 | - | mΩ |

Transistor Wechselrichter/ Transistor Inverter

| | | | min. | typ. | max. | |
|--|--|---------------------|------|------|------|-----|
| Kollektor-Emitter Sättigungsspannung collector-emitter saturation voltage | V _{GE} = 15V, T _{vj} = 25°C, I _C = 15 A | V _{CE sat} | - | 2,2 | 2,55 | V |
| | V _{GE} = 15V, T _{vj} = 125°C, I _C = 15 A | | - | 2,5 | - | V |
| Gate-Schwellenspannung gate threshold voltage | V _{CE} = V _{GE} , T _{vj} = 25°C, I _C = 0,6 mA | V _{GE(TO)} | 4,5 | 5,5 | 6,5 | V |
| Eingangskapazität input capacitance | f = 1MHz, T _{vj} = 25°C V _{CE} = 25 V, V _{GE} = 0 V | C _{ies} | - | 1,0 | - | nF |
| Kollektor-Emitter Reststrom collector-emitter cut-off current | V _{GE} = 0V, T _{vj} = 25°C, V _{CE} = 1200 V | I _{CES} | - | 1,0 | 500 | μA |
| | V _{GE} = 0V, T _{vj} = 125°C, V _{CE} = 1200 V | | - | 1,2 | - | mA |
| Gate-Emitter Reststrom gate-emitter leakage current | V _{CE} = 0V, V _{GE} = 20V, T _{vj} = 25°C | I _{GES} | - | - | 300 | nA |
| Einschaltverzögerungszeit (ind. Last) turn on delay time (inductive load) | I _C = I _{Nenn} , V _{CC} = 600 V | t _{d,on} | - | 65 | - | ns |
| | V _{GE} = ±15V, T _{vj} = 25°C, R _G = 47 Ohm | | | | | |
| | V _{GE} = ±15V, T _{vj} = 125°C, R _G = 47 Ohm | | | | | |
| Anstiegszeit (induktive Last) rise time (inductive load) | I _C = I _{Nenn} , V _{CC} = 600 V | t _r | - | 65 | - | ns |
| | V _{GE} = ±15V, T _{vj} = 25°C, R _G = 47 Ohm | | | | | |
| | V _{GE} = ±15V, T _{vj} = 125°C, R _G = 47 Ohm | | | | | |
| Abschaltverzögerungszeit (ind. Last) turn off delay time (inductive load) | I _C = I _{Nenn} , V _{CC} = 600 V | t _{d,off} | - | 370 | - | ns |
| | V _{GE} = ±15V, T _{vj} = 25°C, R _G = 47 Ohm | | | | | |
| | V _{GE} = ±15V, T _{vj} = 125°C, R _G = 47 Ohm | | | | | |
| Fallzeit (induktive Last) fall time (inductive load) | I _C = I _{Nenn} , V _{CC} = 600 V | t _f | - | 50 | - | ns |
| | V _{GE} = ±15V, T _{vj} = 25°C, R _G = 47 Ohm | | | | | |
| | V _{GE} = ±15V, T _{vj} = 125°C, R _G = 47 Ohm | | | | | |
| Einschaltverlustenergie pro Puls turn-on energy loss per pulse | I _C = I _{Nenn} , V _{CC} = 600 V | E _{on} | - | 2 | - | mWs |
| | V _{GE} = ±15V, T _{vj} = 125°C, R _G = 47 Ohm | | | | | |
| | L _S = 75 nH | | | | | |
| Abschaltverlustenergie pro Puls turn-off energy loss per pulse | I _C = I _{Nenn} , V _{CC} = 600 V | E _{off} | - | 1,7 | - | mWs |
| | V _{GE} = ±15V, T _{vj} = 125°C, R _G = 47 Ohm | | | | | |
| | L _S = 75 nH | | | | | |
| Kurzschlußverhalten SC Data | t _P ≤ 10μs, V _{GE} ≤ 15V, R _G = 47 Ohm T _{vj} ≤ 125°C, V _{CC} = 720 V di/dt = 1200 A/μs | I _{SC} | - | 90 | - | A |



Elektrische Eigenschaften / Electrical properties

Charakteristische Werte / Characteristic values

| | | min. | typ. | max. | | | |
|--|---|--------------|------|-------------|--------|-------------|--|
| Modulinduktivität stray inductance module | | L_{GCE} | - | - | 100 nH | | |
| Modul Leitungswiderstand, Anschlüsse-Chip lead resistance, terminals-chip | $T_C = 25^\circ C$ | R_{CC+EE} | - | 11 | mΩ | | |
| Diode Wechselrichter/ Diode Inverter | | min. | | typ. | | max. | |
| Durchlaßspannung forward voltage | $V_{GE} = 0V, T_{vj} = 25^\circ C, I_F = 15 A$ $V_{GE} = 0V, T_{vj} = 125^\circ C, I_F = 15 A$ | V_F | - | 1,75 | 2,2 | V | |
| Rückstromspitze peak reverse recovery current | $I_F = I_{Nenn}, -di_F/dt = 1000A/\mu s$ $V_{GE} = -10V, T_{vj} = 25^\circ C, V_R = 600 V$ $V_{GE} = -10V, T_{vj} = 125^\circ C, V_R = 600 V$ | I_{RM} | - | 22 | - | A | |
| Sperrverzögerungsladung recovered charge | $I_F = I_{Nenn}, -di_F/dt = 1000A/\mu s$ $V_{GE} = -10V, T_{vj} = 25^\circ C, V_R = 600 V$ $V_{GE} = -10V, T_{vj} = 125^\circ C, V_R = 600 V$ | Q_r | - | 1,6 | - | μAs | |
| Abschaltenergie pro Puls reverse recovery energy | $I_F = I_{Nenn}, -di_F/dt = 1000A/\mu s$ $V_{GE} = -10V, T_{vj} = 25^\circ C, V_R = 600 V$ $V_{GE} = -10V, T_{vj} = 125^\circ C, V_R = 600 V$ | E_{RO} | - | 0,5 | - | mWs | |
| | | | - | 1,2 | - | mWs | |
| Transistor Brems-Chopper/ Transistor Brake-Chopper | | min. | | typ. | | max. | |
| Kollektor-Emitter Sättigungsspannung collector-emitter saturation voltage | $V_{GE} = 15V, T_{vj} = 25^\circ C, I_C = 10,0 A$ $V_{GE} = 15V, T_{vj} = 125^\circ C, I_C = 10,0 A$ | $V_{CE sat}$ | - | 2,4 | 2,85 | V | |
| Gate-Schwellenspannung gate threshold voltage | $V_{CE} = V_{GE}, T_{vj} = 25^\circ C, I_C = 0,35mA$ | $V_{GE(TO)}$ | 4,5 | 5,5 | 6,5 | V | |
| Eingangskapazität input capacitance | $f = 1MHz, T_{vj} = 25^\circ C$ $V_{CE} = 25 V, V_{GE} = 0 V$ | C_{ies} | - | 0,6 | - | nF | |
| Kollektor-Emitter Reststrom collector-emitter cut-off current | $V_{GE} = 0V, T_{vj} = 25^\circ C, V_{CE} = 1200 V$ $V_{GE} = 0V, T_{vj} = 125^\circ C, V_{CE} = 1200 V$ | I_{CES} | - | 0,5 | 500 | μA | |
| Gate-Emitter Reststrom gate-emitter leakage current | $V_{CE} = 0V, V_{GE} = 20V, T_{vj} = 25^\circ C$ | I_{GES} | - | - | 300 | nA | |
| Diode Brems-Chopper/ Diode Brake-Chopper | | min. | | typ. | | max. | |
| Durchlaßspannung forward voltage | $T_{vj} = 25^\circ C, I_F = 10,0 A$ $T_{vj} = 125^\circ C, I_F = 10,0 A$ | V_F | - | 2,2 | 2,55 | V | |
| | | | - | 2,1 | - | V | |
| NTC-Widerstand/ NTC-Thermistor | | min. | | typ. | | max. | |
| Nennwiderstand rated resistance | $T_C = 25^\circ C$ | R_{25} | - | 5 | - | kΩ | |
| Abweichung von R_{100} deviation of R_{100} | $T_C = 100^\circ C, R_{100} = 493 \Omega$ | $\Delta R/R$ | -5 | | 5 | % | |
| Verlustleistung power dissipation | $T_C = 25^\circ C$ | P_{25} | | | 20 | mW | |
| B-Wert B-value | $R_2 = R_1 \exp [B(1/T_2 - 1/T_1)]$ | $B_{25/50}$ | | 3375 | | K | |

Technische Information / Technical Information

IGBT-Module
IGBT-Modules

BSM15GP120

eupec

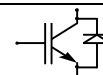

Thermische Eigenschaften / Thermal properties

| | | | min. | typ. | max. | |
|--|--------------------------------|----------------------------|------|------|------|-----|
| Innerer Wärmewiderstand thermal resistance, junction to case | Gleicher. Diode/ Rectif. Diode | R_{thJC} | - | - | 1 | K/W |
| | Trans. Wechr./ Trans. Inverter | | - | - | 0,7 | K/W |
| | Diode Wechr./ Diode Inverter | | - | - | 1,2 | K/W |
| | Trans. Bremse/ Trans. Brake | | - | - | 1,2 | K/W |
| | Diode Bremse/ Diode Brake | | - | - | 2,3 | K/W |
| Übergangs-Wärmewiderstand thermal resistance, case to heatsink | Gleicher. Diode/ Rectif. Diode | R_{thCK} | - | 0,08 | - | K/W |
| | Trans. Wechr./ Trans. Inverter | $\lambda_{paste}=1W/m^2K$ | - | 0,04 | - | K/W |
| | Diode Wechr./ Diode Inverter | $\lambda_{grease}=1W/m^2K$ | - | 0,08 | - | K/W |
| Höchstzulässige Sperrschichttemperatur maximum junction temperature | | T_{vj} | - | - | 150 | °C |
| Betriebstemperatur operation temperature | | T_{op} | -40 | - | 125 | °C |
| Lagertemperatur storage temperature | | T_{stg} | -40 | - | 125 | °C |

Mechanische Eigenschaften / Mechanical properties

| | | | | | |
|--|--|---|--|-----------------|----|
| Innere Isolation internal insulation | | | | Al_2O_3 | |
| CTI comperative tracking index | | | | 225 | |
| Anzugsdrehmoment f. mech. Befestigung mounting torque | | M | | 3 $\pm 10\%$ | Nm |
| Gewicht weight | | G | | 180 | g |



Ausgangskennlinienfeld Wechselr. (typisch)

$I_C = f(V_{CE})$

Output characteristic Inverter (typical)

$V_{GE} = 15\text{ V}$

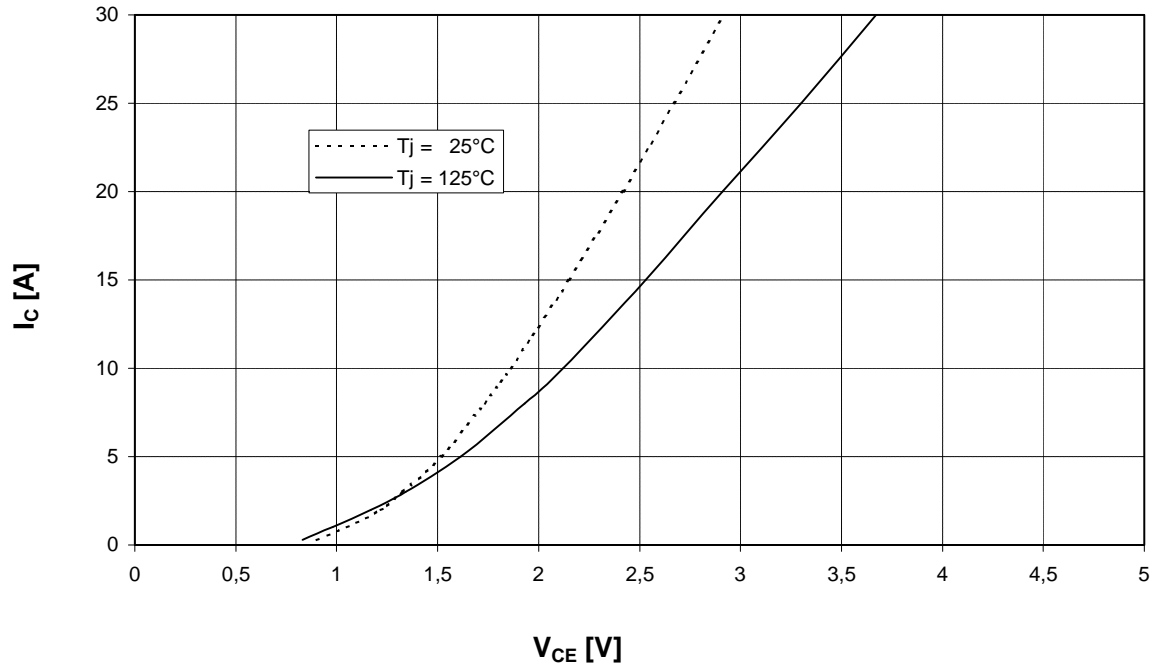

Ausgangskennlinienfeld Wechselr. (typisch)

$I_C = f(V_{CE})$

Output characteristic Inverter (typical)

$T_{vj} = 125^\circ\text{C}$

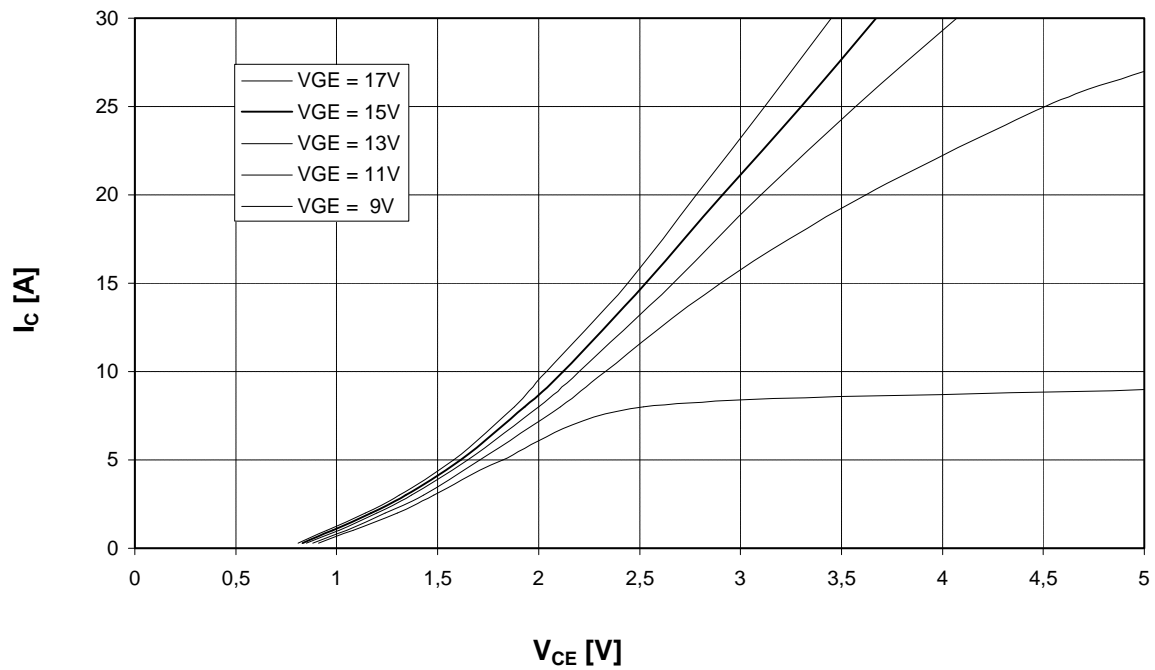



Übertragungscharakteristik Wechselr. (typisch)

$I_C = f(V_{GE})$

Transfer characteristic Inverter (typical)

$V_{CE} = 20\text{ V}$

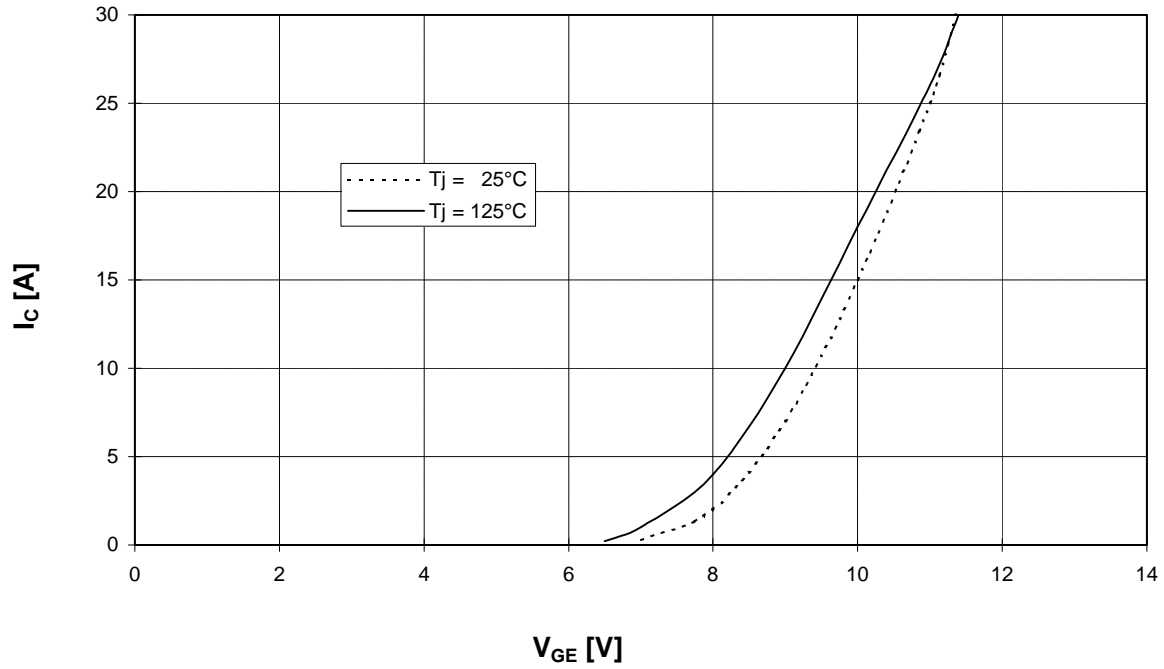

Durchlaßkennlinie der Freilaufdiode Wechselr. (typisch)

$I_F = f(V_F)$

Forward characteristic of FWD Inverter (typical)

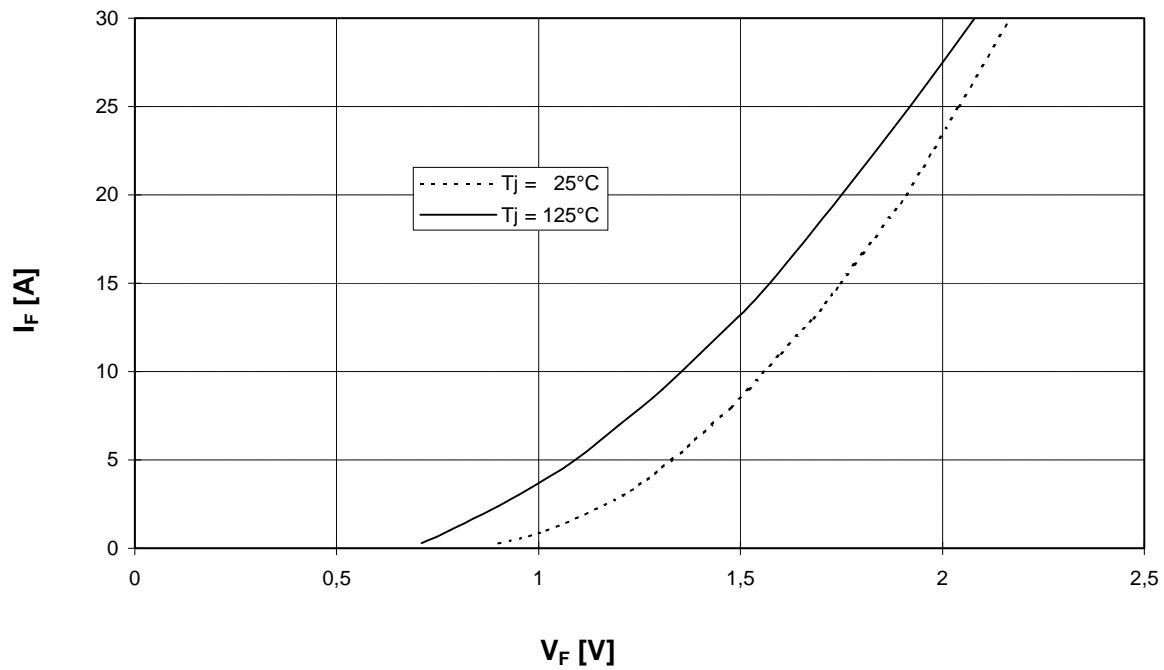

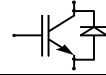

Schaltverluste Wechselr. (typisch) $E_{on} = f(I_C), E_{off} = f(I_C), E_{rec} = f(I_C)$ $V_{CC} = 600\text{ V}$
 Switching losses Inverter (typical) $T_j = 125^\circ\text{C}, V_{GE} = \pm 15\text{ V}, R_{Gon} = R_{Goff} = 47\text{ Ohm}$

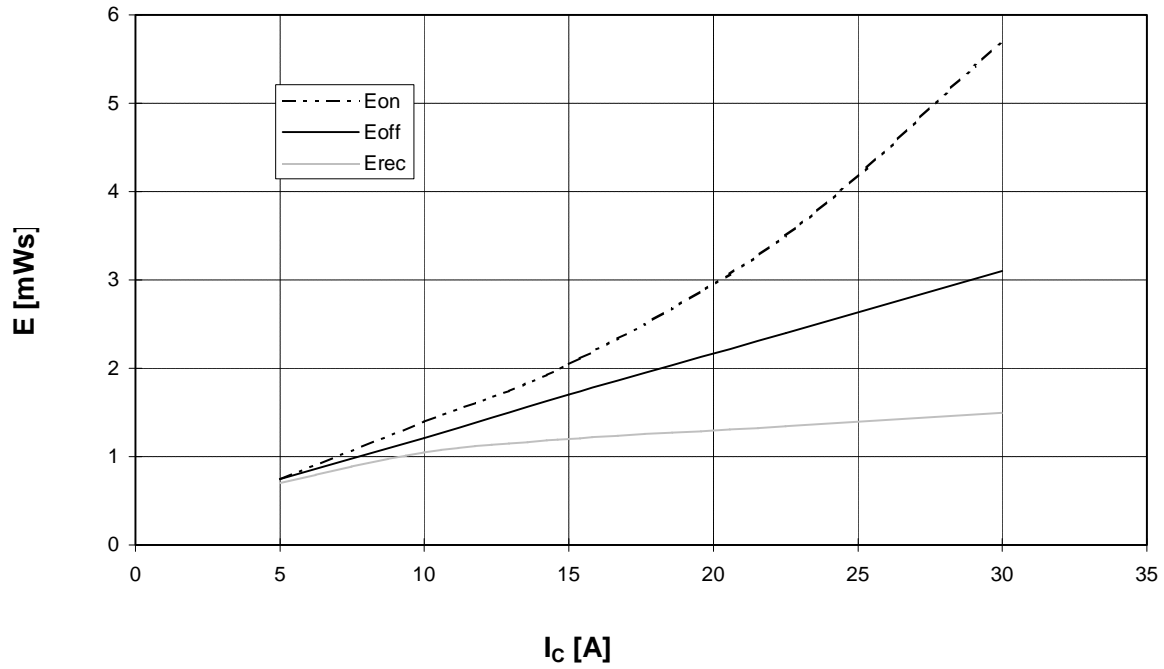

Schaltverluste Wechselr. (typisch) $E_{on} = f(R_G), E_{off} = f(R_G), E_{rec} = f(R_G)$
 Switching losses Inverter (typical) $T_j = 125^\circ\text{C}, V_{GE} = \pm 15\text{ V}, I_C = I_{nenn}, V_{CC} = 600\text{ V}$

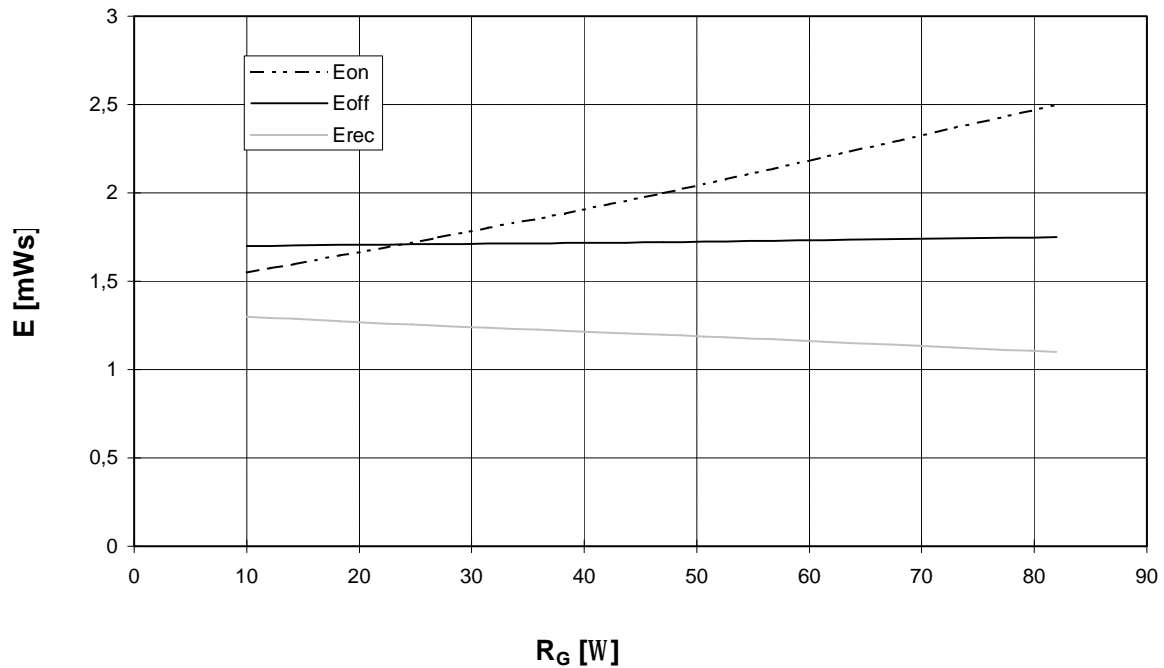



Transienter Wärmewiderstand Wechsler.
Transient thermal impedance Inverter

$Z_{thJC} = f(t)$

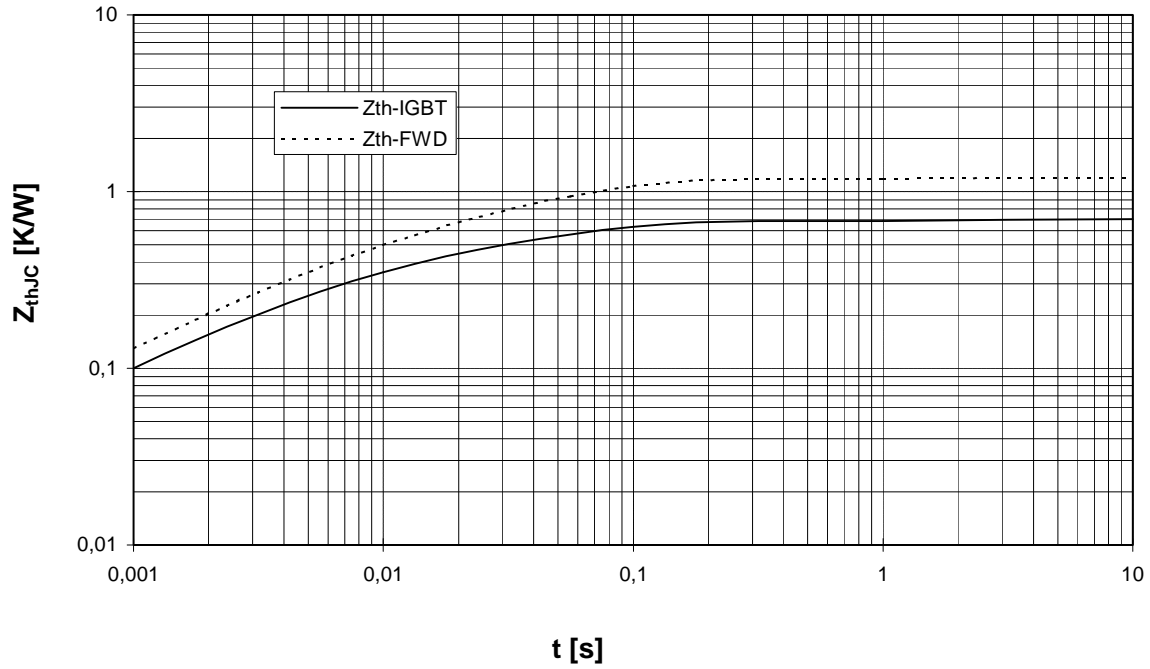

Sicherer Arbeitsbereich Wechsler. (RBSOA)

$I_C = f(V_{CE})$

Reverse bias safe operating area Inverter (RBSOA) $T_{vj} = 125^\circ\text{C}$, $V_{GE} = \pm 15\text{V}$, $R_G = 47 \text{ Ohm}$

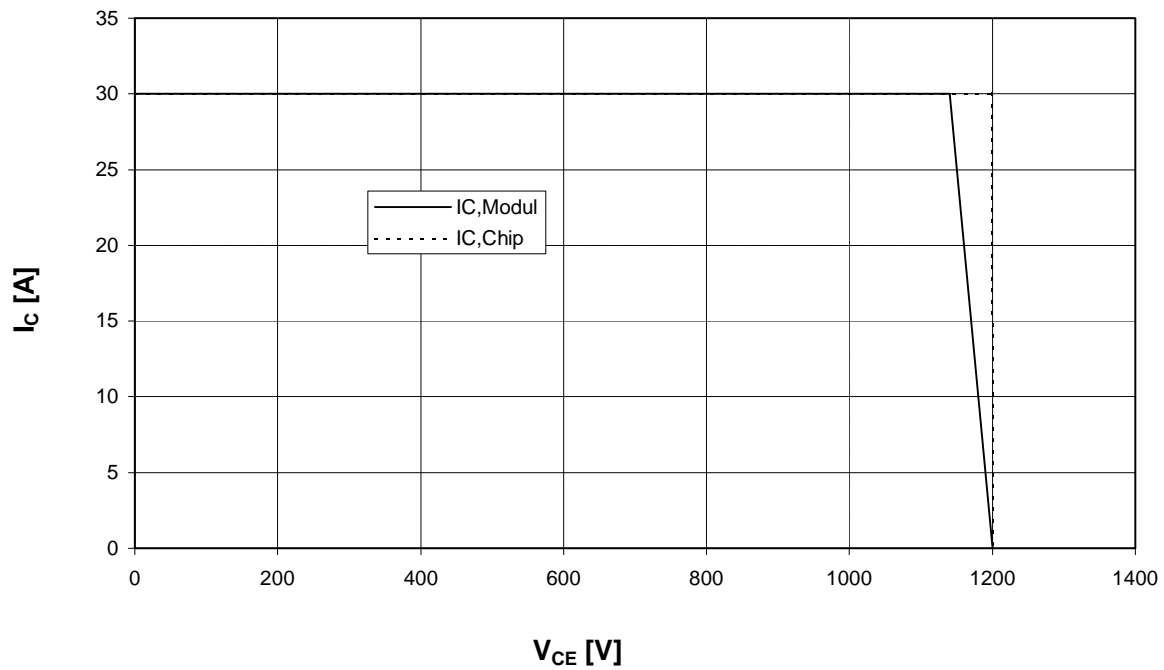

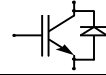

Ausgangskennlinienfeld Brems-Chopper-IGBT (typisch)

Output characteristic brake-chopper-IGBT (typical)

$I_C = f(V_{CE})$

$V_{GE} = 15\text{ V}$

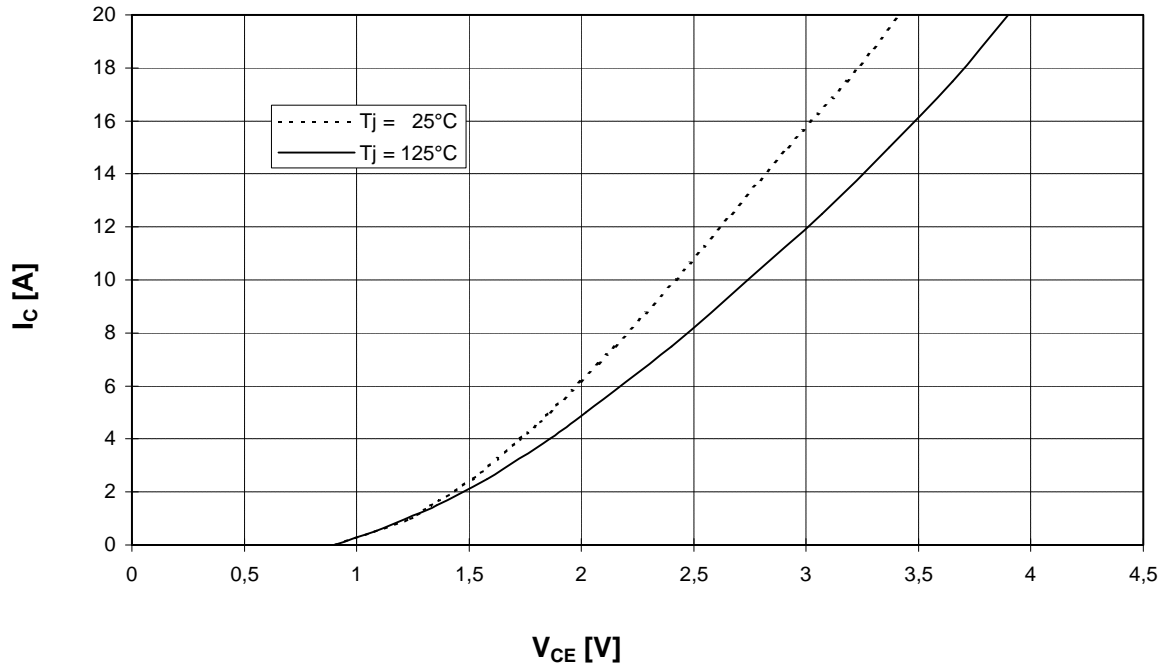

Durchlaßkennlinie der Brems-Chopper-Diode (typisch)

Forward characteristic of brake-chopper-FWD (typical)

$I_F = f(V_F)$

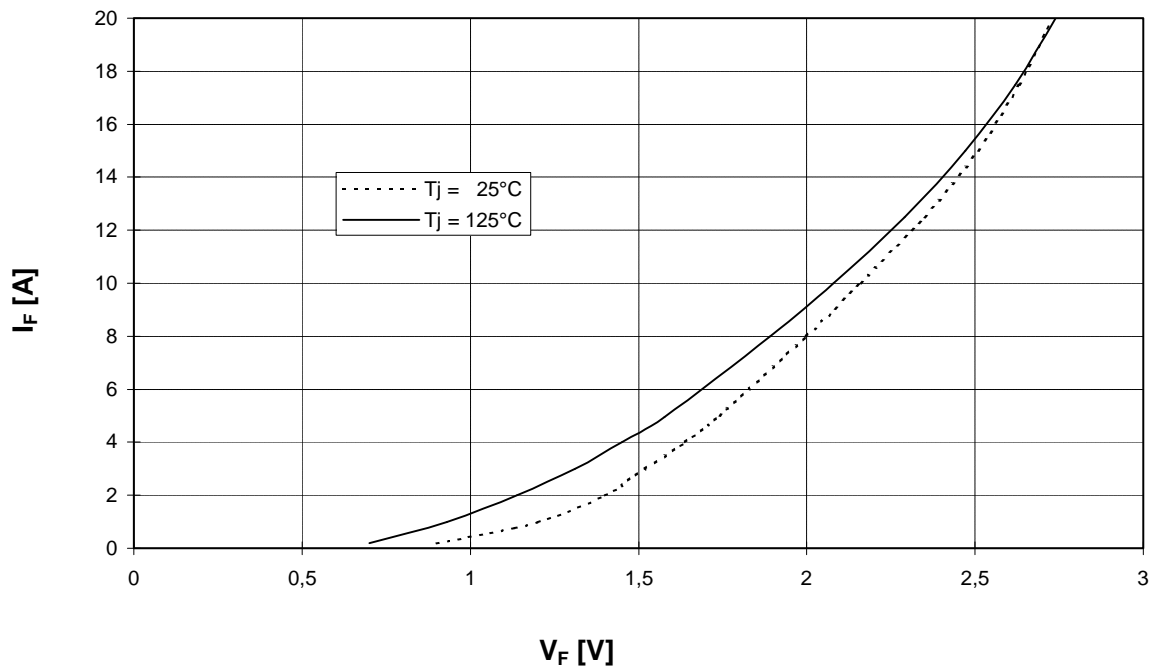



Durchlaßkennlinie der Gleichrichterdiode (typisch) $I_F = f(V_F)$
Forward characteristic of Rectifier Diode (typical)

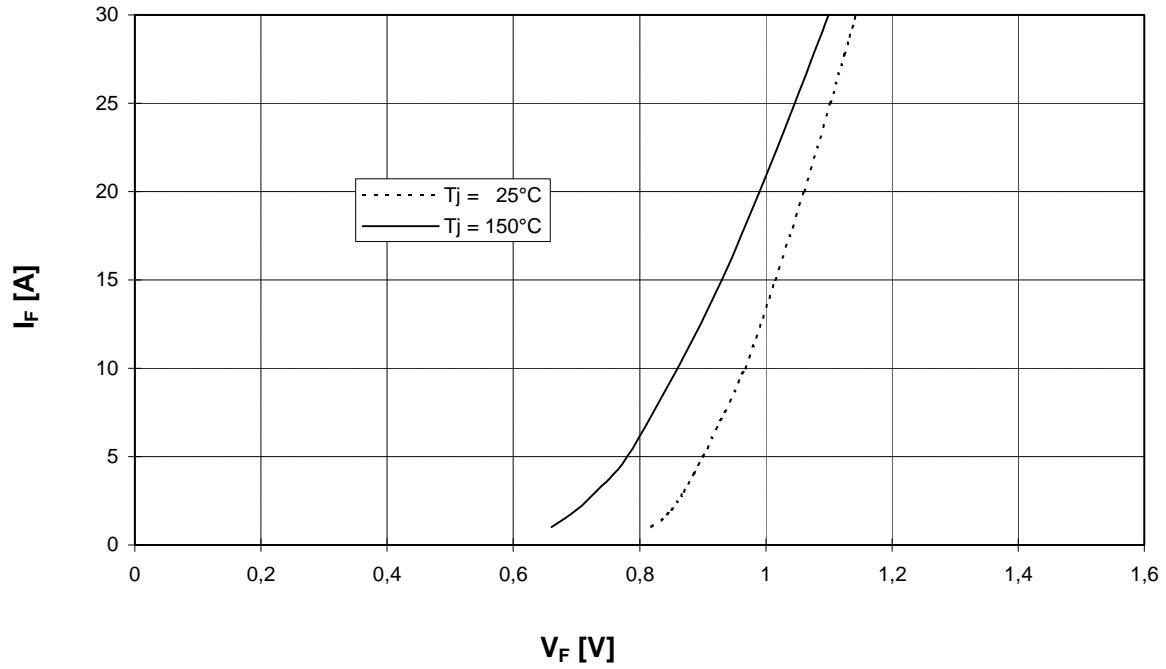

NTC- Temperaturkennlinie (typisch) $R = f(T)$
NTC- temperature characteristic (typical)

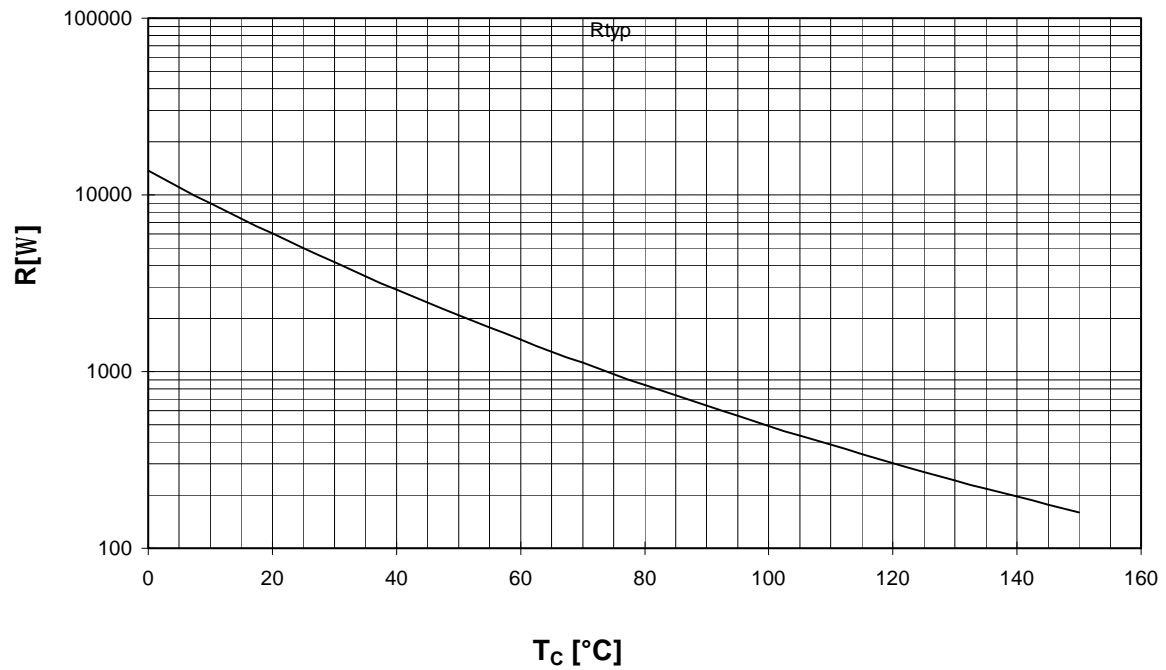

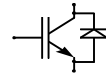

Schaltplan/ Circuit diagram

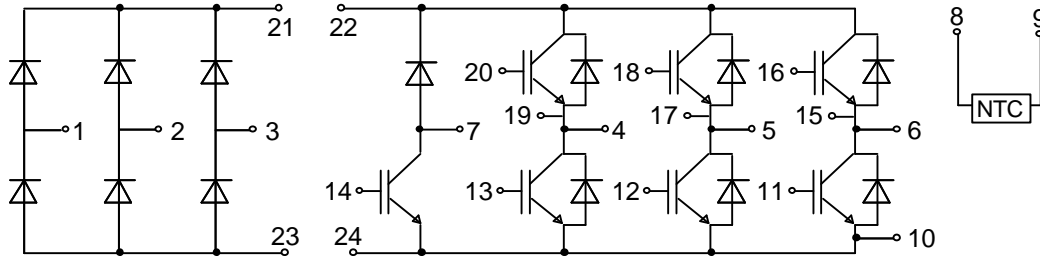

Gehäuseabmessungen/ Package outlines

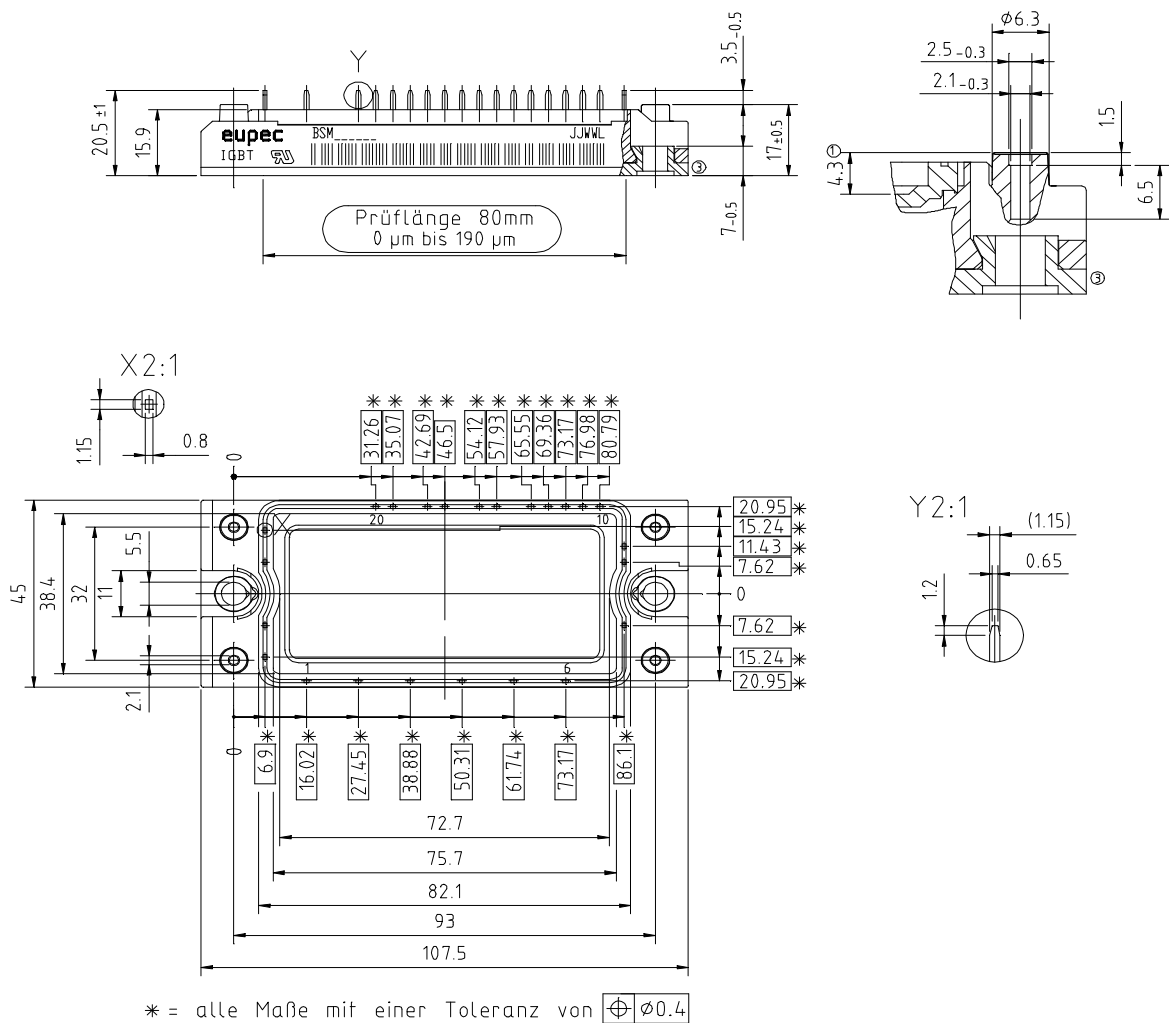

Mit dieser technischen Information werden Halbleiterbauelemente spezifiziert, jedoch keine Eigenschaften zugesichert. Sie gilt in Verbindung mit den zugehörigen Technischen Erläuterungen.

This technical information specifies semiconductor devices but promises no characteristics. It is valid in combination with the belonging technical notes.