

ABB Line

A Line

Contactors
DLA starters
Overload relays
Control relays

AC 1030



Registered by UL to
ISO 9002

ABB Control Inc.



The A Line family

Contactors

- A9 - A110, 3 & 4 pole
- Maximum UL/CSA HP ratings
- Includes NEMA sizes 00 - 3
- Compact, space saving design
- AC & DC operated
- Additional auxiliary contacts available
- Snap-on front mounted accessories
- NEMA, UL, IEC, CSA, VDE & most other international standards



DLA starters

- Mounting plate, including a built-in Line contactor, is designed to integrate an ABB manual motor starter, Type MS325
- Four DLA starter sizes, DLA9 - DLA26
- Suitable for use with 3 phase motors up to 25 FLA
- UL Listed and CSA certified for 1200A group motor installation with fuses or breaker
- UL, IEC, CSA, VDE & most other international standards

Overload relays

- Available for starter construction with A Line contactors and separate panel mounting
- Designed for close couple mounting for 11 contactors, A9 - A110
- Class 10 adjustable overload relays are standard with all ABB Line starters
- UL Listed & CSA Approved



Control relays

- AC or DC operated
- DIN rail or panel mounting
- 600 V heavy duty design, A600-10A, Q300-5A
- Snap-on accessories
- Coils are easily interchangeable
- Fixed contacts are double break type for positive contact on low current applications
- NEMA, UL, IEC, CSA, VDE & most other international standards



A Line
Contactors
DLA starters
Overload relays
Control relays

• Table of contents	II
• Alphanumeric price guide	III - IV

Contactors	1.1 - 1.41
------------------	------------

Contactors

DLA starters	2.1 - 2.7
--------------------	-----------

DLA starters

Overload relays	3.1 - 3.12
-----------------------	------------

Overload relays

Control relays	4.1 - 4.12
----------------------	------------

Control relays

Terms, Worldwide approvals, CE Mark	5.1
-------------------------------------------	-----

This catalog is published for information purposes only and is not all inclusive. For additional information on products or technical information, consult ABB Control Inc. The installation and use of ABB Control Inc. products should be in accordance with the provisions of the U.S. National Electrical Code and/or other local codes or industry standards that are pertinent to the particular end use. Installation or use not in accordance with these codes and standards could be hazardous to personnel and/or equipment.

Table of contents

Item	Product category	Page No.	Subject	Product category	Page No.
A			L		
Accessories	Control relays	4.5	Latches, mechanical	Contactors	1.10
Accessories	Contactors	1.9 - 1.17	Lead terminals, auxiliary	Contactors	1.9
Accessories	Overload relays	3.5 - 3.6	M		
Accessory combinations, possible	Contactors	1.18	Manual motor starters, MS325	DLA starters	2.2
Accessory mounting information	Contactors	1.19	Marker, identification	Contactors	1.10
Accessory mounting information	Control relays	4.6 - 4.7	Mechanical interlocks	Contactors	1.9
Adapter, shaft	DLA starters	2.4	Mechanical interlocks	Control relays	4.5
Additional terminal block	Contactors	1.15	Mechanical latches	Contactors	1.10
Approvals	All products	V	Mechanically interlocked contactors	Contactors	1.6
Auxiliary contact blocks	DLA starters	2.4	Motor data	Contactors	1.29
Auxiliary contact blocks	Contactors	1.9	Mounting positions	Contactors	1.20
Auxiliary control blocks	Control relays	4.5	O		
Auxiliary lead terminals	Contactors	1.9	Overload relay dimensions	Overload relays	3.11 - 3.12
B			Overload relay technical data	Overload relays	3.7 - 3.9
Bell alarm contact blocks	DLA starters	2.4	Overload relay tripping curves	Overload relays	3.10
Busbars	DLA starters	2.4	Overload relays, Type TA	Overload relays	3.4
C			P		
Capacitive switching contactors	Contactors	1.8	Padlocking devices	DLA starters	2.4
CE Mark	All products	5.2	Phase to phase connection kits	Contactors	1.14
Coil voltages & codes	Contactors	1.13	Pneumatic timers	Contactors	1.9
Coils	Contactors	1.13	Pneumatic timers	Control relays	4.5
Coils	Control relays	4.5	Possible accessory combinations	Contactors	1.18
Connection kits for phase to phase	Contactors	1.14	R		
Connection kits for reversing contactors	Contactors	1.14	Relay, interface	Contactors	1.10
Connection kits for wye-delta starters	Contactors	1.14	Reversing contactor connection kits	Contactors	1.14
Contact blocks, auxiliary	Contactors	1.9	Reversing contactors	Contactors	1.7
Contact blocks, auxiliary	DLA starters	2.4	S		
Contact blocks, bell alarm	DLA starters	2.4	Selection guide, overload relay	Overload relays	3.3
Contact accessories	Contactors	1.9 - 1.17	Shaft adapter	DLA starters	2.4
Contact dimensions	Contactors	1.30 - 1.40	Shunt trips	DLA starters	2.4
Contact technical data	Contactors	1.18 - 1.28	Supporting terminal	DLA starters	2.4
Contactors for capacitive switching	Contactors	1.8	Surge suppressors	Contactors	1.9
Contactors, mechanically interlocked	Contactors	1.6	Surge suppressors	Control relays	4.5
Contactors, non-reversing	Contactors	1.4 - 1.5	T		
Contactors, reversing	Contactors	1.7	Technical data	DLA starters	2.4
Control blocks, auxiliary	Control relays	4.5	Technical data	Control relays	4.8 - 4.10
Control relays, Type N & KC	Control relays	4.4	Technical data	Contactors	1.18 - 1.28
Control relay accessories	Control relays	4.5	Technical data	Overload relays	3.7 - 3.9
Control relay dimensions	Control relays	4.11 - 4.12	Terminal block, additional	Contactors	1.15
Control relay technical data	Control relays	4.8 - 4.10	Terminal blocks	DLA starters	2.4
D			Terminal marking & positioning	Contactors	1.16 - 1.17
Description, contactors	Contactors	1.2 - 1.3	Terminal, supporting	DLA starters	2.4
Description, control relays	Control relays	4.1 - 4.3	Terminals, auxiliary lead	Contactors	1.9
Description, overload relay	Overload relays	3.1 - 3.2	Terms & conditions	Terms & conditions	5.1
Dimensions	Overload relays	3.11 - 3.12	Timers, electronic	Contactors	1.11
Dimensions	Control relays	4.11 - 4.12	Timers, pneumatic	Contactors	1.9
Dimensions	Contactors	1.30 - 1.40	Timers, pneumatic	Control relays	4.5
DLA starter dimensions	DLA starters	2.7	Tripping curves	Overload relays	3.10
DLA starters	DLA starters	2.2	Type KC control relay	Control relays	4.4
Door mounting kits	DLA starters	2.4	Type N control relay	Control relays	4.4
E			Type TA overload relays	Overload relays	3.4
Electrical interlocks	Contactors	1.9	U		
Electrical interlocks	Control relays	4.5	Undervoltage trip	DLA starters	2.4
Electronic timers	Contactors	1.11	W		
F			Wye-delta starter connection kits	Contactors	1.14
Features	DLA starters	2.1			
Features	Contactors	1.1			
Four pole contactors	Contactors	1.5			
G					
General information	DLA starters	2.3			
I					
Identification markers	Contactors	1.10			
Identification markers	Control relays	4.5			
IEC coordination tables	DLA starters	2.4			
Interface relay	Contactors	1.10			
Interlocks, electrical	Contactors	1.9			
Interlocks, electrical	Control relays	4.5			
Interlocks, mechanical	Contactors	1.9			
Interlocks, mechanical	Control relays	4.5			
K					
Kits, door mounting	DLA starters	2.4			

Alphanumeric price guide

MS325-16 to ZLT75

Catalog number	List price	Disc. sched.	Pg. no.	Catalog number	List price	Disc. sched.	Pg. no.	Catalog number	List price	Disc. sched.	Pg. no.	Catalog number	List price	Disc. sched.	Pg. no.
MS325-16	\$ 128.00	MA	2.2	MS325-UA24	\$ 55.00	MA	2.4	TA25DU0.4	\$ 63.00	AA	3.4	TP40IA	\$ 108.00	AA	1.9
MS325-2.5	\$ 110.00	MA	2.2	MS325-UA400	\$ 55.00	MA	2.4	TA25DU0.63	\$ 63.00	AA	3.4	UA110-30-00-84	\$ 525.00	AA	1.8
MS325-20	\$ 141.00	MA	2.2	MS325-UA415	\$ 55.00	MA	2.4	TA25DU1.0	\$ 63.00	AA	3.4	UA110-30-11-84	\$ 570.00	AA	1.8
MS325-25	\$ 149.00	MA	2.2	MS325-UA48	\$ 55.00	MA	2.4	TA25DU1.4	\$ 63.00	AA	3.4	UA26-30-10-84	\$ 225.00	AA	1.8
MS325-2BB	\$ 16.00	MA	2.4	MS325-UA480	\$ 55.00	MA	2.4	TA25DU1.8	\$ 63.00	AA	3.4	UA40-30-10-84	\$ 338.00	AA	1.8
MS325-2BB1	\$ 20.00	MA	2.4	MS325-UA60	\$ 55.00	MA	2.4	TA25DU11	\$ 63.00	AA	3.4	UA50-30-00-84	\$ 345.00	AA	1.8
MS325-2BB2	\$ 20.00	MA	2.4	N22E-84	\$ 60.00	AA	4.4	TA25DU14	\$ 63.00	AA	3.4	UA50-30-11-84	\$ 375.00	AA	1.8
MS325-4.0	\$ 110.00	MA	2.2	N31E-84	\$ 60.00	AA	4.4	TA25DU19	\$ 63.00	AA	3.4	UA75-30-00-84	\$ 450.00	AA	1.8
MS325-4BB	\$ 22.00	MA	2.4	N40E-84	\$ 60.00	AA	4.4	TA25DU2.4	\$ 63.00	AA	3.4	UA75-30-11-84	\$ 480.00	AA	1.8
MS325-4BB1	\$ 25.00	MA	2.4	N44E-84	\$ 120.00	AA	4.4	TA25DU25	\$ 63.00	AA	3.4	UA95-30-00-84	\$ 465.00	AA	1.8
MS325-4BB2	\$ 25.00	MA	2.4	N53E-84	\$ 120.00	AA	4.4	TA25DU3.1	\$ 63.00	AA	3.4	UA95-30-11-84	\$ 495.00	AA	1.8
MS325-6.3	\$ 110.00	MA	2.2	N62E-84	\$ 120.00	AA	4.4	TA25DU32	\$ 63.00	AA	3.4	VE5-1	\$ 45.00	AA	1.9
MS325-9.0	\$ 128.00	MA	2.2	N71E-84	\$ 120.00	AA	4.4	TA25DU4.0	\$ 63.00	AA	3.4	VE5-2	\$ 45.00	AA	1.9
MS325-AS	\$ 10.00	MA	2.4	N80E-84	\$ 120.00	AA	4.4	TA25DU5.0	\$ 63.00	AA	3.4	VM5-1	\$ 21.00	AA	1.9
MS325-BB1	\$ 17.00	MA	2.4	RA30	\$ 75.00	AA	1.10	TA25DU6.5	\$ 63.00	AA	3.4	WB75A-*	\$ 84.00	AA	1.10
MS325-H	\$ 52.00	MA	2.4	RA5	\$ 75.00	AA	1.10	TA25DU8.5	\$ 63.00	AA	3.4	ZA110-*	\$ 60.00	AA	1.13
MS325-HES	\$ 52.00	MA	2.4	RC5-1/133	\$ 30.00	AA	1.9	TA42DU25	\$ 78.00	AA	3.4	ZA16-*	\$ 24.00	AA	1.13
MS325-HG	\$ 60.00	MA	2.4	RC5-1/250	\$ 30.00	AA	1.9	TA42DU32	\$ 78.00	AA	3.4	ZA40-*	\$ 30.00	AA	1.13
MS325-HGES	\$ 60.00	MA	2.4	RC5-1/440	\$ 30.00	AA	1.9	TA42DU42	\$ 78.00	AA	3.4	ZA75-*	\$ 57.00	AA	1.13
MS325-HK02	\$ 22.00	MA	2.4	RC5-1/50	\$ 30.00	AA	1.9	TA75DU25	\$ 102.00	AA	3.4	ZAE110-*	\$ 90.00	AA	1.13
MS325-HK11	\$ 22.00	MA	2.4	RC5-2/133	\$ 30.00	AA	1.9	TA75DU32	\$ 102.00	AA	3.4	ZAE75-*	\$ 57.00	AA	1.13
MS325-HK20	\$ 22.00	MA	2.4	RC5-2/250	\$ 30.00	AA	1.9	TA75DU42	\$ 102.00	AA	3.4	ZL110	\$ 255.00	AA	1.15
MS325-NT	\$ 5.00	MA	2.4	RC5-2/440	\$ 30.00	AA	1.9	TA75DU52	\$ 102.00	AA	3.4	ZL50	\$ 113.00	AA	1.15
MS325-SA	\$ 25.00	MA	2.4	RC5-2/50	\$ 30.00	AA	1.9	TA75DU63	\$ 102.00	AA	3.4	ZL63	\$ 135.00	AA	1.15
MS325-SA1	\$ 10.00	MA	2.4	RV-BC6/250	\$ 26.00	AA	4.5	TA75DU80	\$ 102.00	AA	3.4	ZL75	\$ 158.00	AA	1.15
MS325-SA3	\$ 25.00	MA	2.4	RV-BC6/380	\$ 26.00	AA	4.5	TA80DU42	\$ 135.00	AA	3.4	ZL95	\$ 225.00	AA	1.15
MS325-SK01	\$ 22.00	MA	2.4	RV-BC6/60	\$ 26.00	AA	4.5	TA80DU52	\$ 135.00	AA	3.4	ZLT45	\$ 150.00	AA	1.15
MS325-SK10	\$ 22.00	MA	2.4	RV5/133	\$ 30.00	AA	1.9	TA80DU63	\$ 135.00	AA	3.4	ZLT50	\$ 150.00	AA	1.15
MS325-SM1	\$ 16.00	MA	2.4	RV5/250	\$ 30.00	AA	1.9	TA80DU80	\$ 135.00	AA	3.4	ZLT75	\$ 210.00	AA	1.15
MS325-ST110	\$ 55.00	MA	2.4	RV5/440	\$ 30.00	AA	1.9	TE5S-115	\$ 120.00	AA	1.11				
MS325-ST230	\$ 55.00	MA	2.4	RV5/50	\$ 30.00	AA	1.9	TE5S-230	\$ 120.00	AA	1.11				
MS325-ST24	\$ 55.00	MA	2.4	TA110DU110	\$ 165.00	AA	3.4	TE5S-24	\$ 120.00	AA	1.11				
MS325-ST3	\$ 55.00	MA	2.4	TA110DU90	\$ 165.00	AA	3.4	TP180DA	\$ 108.00	AA	1.9				
MS325-UA110	\$ 55.00	MA	2.4	TA25DU0.16	\$ 63.00	AA	3.4	TP180IA	\$ 108.00	AA	1.9				
MS325-UA230	\$ 55.00	MA	2.4	TA25DU0.25	\$ 63.00	AA	3.4	TP40DA	\$ 108.00	AA	1.9				



A9 – A110

- Maximum UL/CSA horsepower ratings
- Includes NEMA sizes 00 – 3
- CE mark
- Compact space saving design
- Standard auxiliary contact configurations:
A9 – A40 1 N.O. or 1 N.C.
A50 – A110 1 N.O. and 1 N.C.
Can be supplied without auxiliaries
- Additional auxiliary contact blocks are available
- D.C. ratings & D.C. control operation available
- Fast, snap-on DIN rail mounting
- Double break contact design
- Snap-on front mounted accessories include mechanical latch, pneumatic timer, and 1 & 4 pole auxiliary contact blocks
- Common accessories for A9 – A110 contactors
- Complete range of 4 pole contactors 21A – 105A
- Easy coil change
- Captive terminal screws
- NEMA, UL, IEC, CSA, VDE and most other international standards
- UL File No: E39231 (A9 – A75)
- UL File No: E79416 (A95 – A110)
- CSA File No: LR56745 (A9 – A75)
- CSA File No: LR19700 (A95 – A110)
- Touch safe design: All connection terminals are protected against accidental touch
- Terminals supplied open for ease of wiring
- Operates over an extended voltage range of 85% to 110% of rated control voltage
- Screwdriver guide holes

Index

• Features	1.1
• Description	1.2 – 1.3
• Non-reversing	1.4 – 1.5
• Mechanically interlocked	1.6
• Reversing	1.7
• For capacitor switching	1,8
• Accessories	1.9 – 1.17
• Technical data	1.18 – 1.28
• Motor data	1.29
• Approximate dimensions	1.30 – 1.40

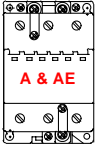

Description for A & AE contactors

Application

A Line contactors are mainly used for controlling 3-phase motors and for controlling power circuits corresponding to their operating characteristics up to 690 and even 1000 VAC. and 440 VDC.

Description of 3 pole and 4 pole contactors: A9 – A110

All A and AE contactors can be assembled side by side.

The add-on or built-in auxiliary contacts are suitable for low level currents.

When mounted with a 4-pole CA5 auxiliary contact block, A9 – A16 contactors ensure positive safety between their auxiliary contacts.

Control circuit types

- A & UA types: AC operated with laminated magnetic circuit.
- AE types: with laminated magnetic circuit and double-winding coil fed from DC supply via a CDL5 insertion contact mounted on the device. The CDL5 has an N.C. lagging contact for insertion of the second winding.

Quick mounting on DIN rail: EN 50022 and EN 50023 standards:

- 35 x 7.5 mm for A9 – A40,
- 35 x 15 mm for A9 – A75,
- 75 mm for A45 – A110.

Location of side mounted accessories: on right or left hand side. Factory mounted on:

- left hand side for CAL5 on A50 – A110-30-11,
- right hand side for CDL5/CCL5 on AE45 – AE110.

Holes for screw mounting (screws not supplied). Distance between holes according to EN 50003.

Terminals delivered in open position with captive screws (screws of unused terminals must be tightened).

Screwdriver guidance for all terminals makes it possible to use motorized screwdrivers.

All terminals provide protection against accidental direct contact with live parts according to VDE0106 – Part. 100.

All A9 – A40 contactor terminals as well as A45 – A110 contactor auxiliary contact and coil terminals ensure IP20 degree of protection according to IEC 947-1.

Contact types

- 3 pole contactors with N.O. or N.C. built in auxiliary contact for A9 – A40 contactors — with or without side mounted, factory assembled auxiliary contacts for A50 – A110 contactors
- 4 pole contactors: 4 N.O. or 2 N.O. & 2 N.C. without any auxiliary contacts.

Contactors for specific applications

- UA type for 3 phase capacitor switching.

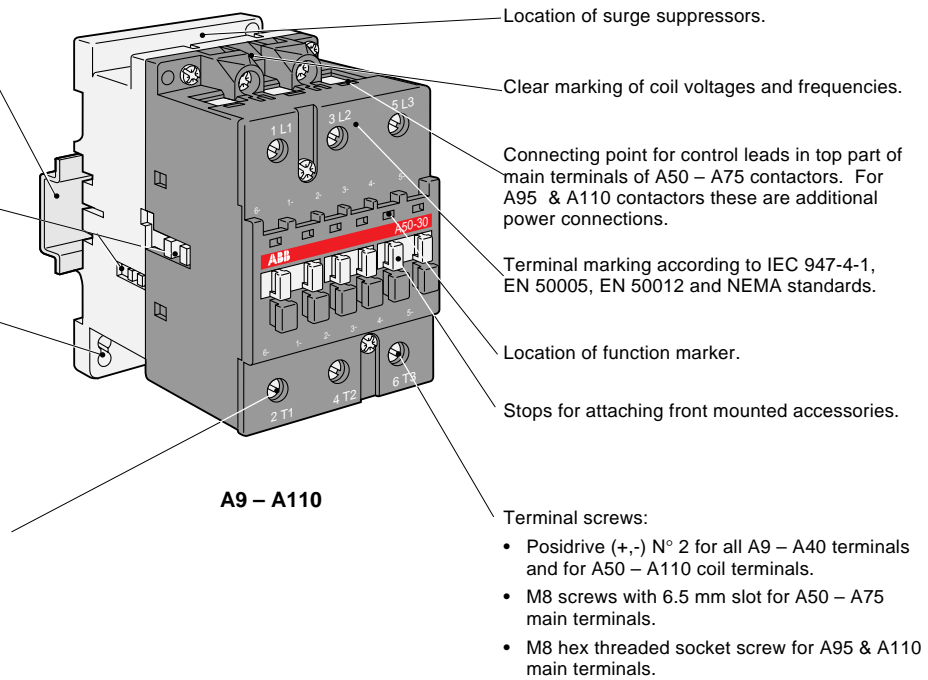

A9 – A110

Catalog number explanation

A9-30-10-84

Frame size

Power pole

- 30 = 3 N.O.
- 40 = 4 N.O.
- 22 = 2 N.O. & 2 N.C.

Coil voltage

(see coil voltage selection chart)

Auxiliary contacts

- 10 = 1 N.O. & 0 N.C.
- 01 = 0 N.O. & 1 N.C.
- 11 = 1 N.O. & 1 N.C.
- 00 = No auxiliary provided

Coil voltage selection chart

Hz	Cntr type	Volts															
		12	24	48	110	120	125	208	220	240	277	380	415	440	480	500	600
60	A		81	83	84	84		34	75	80	42	48	86	86	51	53	55
50	A		81	83	84			80				85	86				
DC	BC	07	01	16	04		27	05	33								
DC	AE	80	81	83	86		87	88	89								

For other voltages, see page 1.13

Description for BC contactors

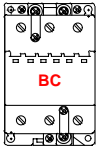

Application

BC contactors are used for controlling 3 phase motors and for controlling power circuits corresponding to their operating characteristics up to 690 VAC and 440 VDC

Description of 3 pole or 4 pole contactors: BC9 – BC30

For BC type contactors make sure that the mounting distance is maintained as described below.

The add-on or built in auxiliary contacts are suitable for low level currents.

Type of magnetic circuit

- Solid magnetic circuit with DC powered coil.

Contact types

- 3 pole contactors with built in N.O. or N.C. auxiliary contact for BC9 – BC25 contactors.
- 4 pole contactors: 4 N.O. or 2 N.O. & 2 N.C. without any auxiliary contacts.

Contactors for specific applications

- DC operated TBC-types with large voltage range specific to the traction industry are not given in this catalog. Please consult factory.

Mounting distance required between BC contactors

A dim	B dim	Ambient temperature °C	Max. switching frequency operating cycles/hr
2	20	≤20	1200
5	20	≤55	1200

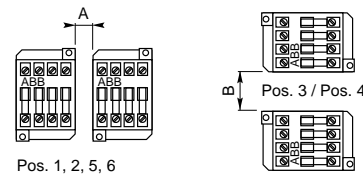

Quick mounting on mounting rail according to IEC 715 and EN 50022 standards:

- 35 x 7.5 mm
- 35 x 15 mm

Terminal screw types:

- Posidrive (+,-) N° 2; M3.5 for all BC9 and BC16 terminals and BC18 – BC30 coil terminals.
- Posidrive (+,-) N° 2; M4 for BC18 and BC25 main terminals.
- Posidrive (+,-) N° 2; M5 for BC30 main terminals.

Holes for screw mounting (screws not supplied). Distance between holes according to EN 50003.

Stops for attaching front mounted accessories.

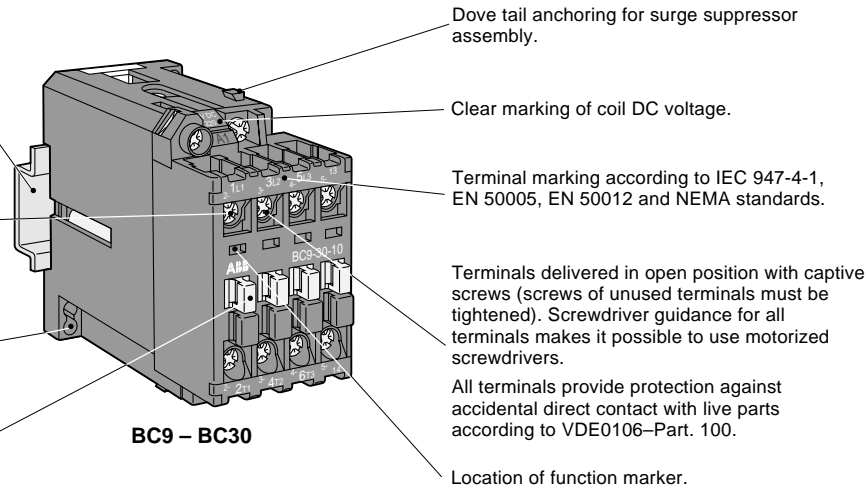

Dove tail anchoring for surge suppressor assembly.

Clear marking of coil DC voltage.

Terminal marking according to IEC 947-4-1, EN 50005, EN 50012 and NEMA standards.

Terminals delivered in open position with captive screws (screws of unused terminals must be tightened). Screwdriver guidance for all terminals makes it possible to use motorized screwdrivers.

All terminals provide protection against accidental direct contact with live parts according to VDE0106-Part. 100.

Location of function marker.

Catalog number explanation

BC9-30-10-04

Frame size

Power pole

- 30 = 3 N.O.
- 40 = 4 N.O.
- 22 = 2 N.O. & 2 N.C.

Coil voltage (see coil voltage selection chart)

Auxiliary contacts

- 10 = 1 N.O. & 0 N.C.
- 01 = 0 N.O. & 1 N.C.
- 11 = 1 N.O. & 1 N.C.
- 00 = No auxiliary provided

Coil voltage selection chart

Hz	Cntr type	Volts															
		12	24	48	110	120	125	208	220	240	277	380	415	440	480	500	600
60	A		81	83	84	84		34	75	80	42	48	86	86	51	53	55
50	A		81	83	84			80				85	86			55	
DC	BC	07	01	16	04		27		05	33							
DC	AE	80	81	83	86		87		88	89							

For other voltages, see page 1.13

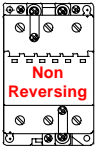

Non-reversing contactors

3 pole, AC & DC operated



A9-30-10



A26-30-10



A50-30-00



A95-30-00

Contactors

General purpose current			Maximum motor horsepower ratings ^{UL} ^{CS}				Standard Aux. contacts		AC operated		DC operated	
AC oper.	DC oper.	Motor switching current	208V	240V	480V	575/600V	N.O.	N.C.	Catalog number	List price	Catalog number	List price
AC1	AC1	AC3	UL rated									
21	—	9	2	2	5	7.5	1 0	0 1	A9-30-10-84 A9-30-01-84	\$ 78	BC9-30-10-04 BC9-30-01-04	\$ 123
25	—	11	3	3	7.5	10	1 0	0 1	A12-30-10-84 A12-30-01-84	84	—	—
30	21	17	5	5	10	15	1 0	0 1	A16-30-10-84 A16-30-01-84	102	BC16-30-10-04 BC16-30-01-04	147
40	33	28	7.5	10	20	25	1 0	0 1	A26-30-10-84 A26-30-01-84	183	BC25-30-10-04 BC25-30-01-04	228
50	45	32	10	10	25	30	1 0 0 2	0 1 0 2	A30-30-10-84 A30-30-01-84 — —	252 — — —	— — BC30-30-00-04 BC30-30-22-04	— — 267 297
60	—	41	10	15	30	40	1 0	0 1	A40-30-10-84 A40-30-01-84	297	—	—
80	—	54	15	20	40	50	0 1	0 1	A50-30-00-84 A50-30-11-84	300 330	AE50-30-00-04 AE50-30-11-04	345 375
90	—	65	20	25	50	60	0 1	0 1	A63-30-00-84 A63-30-11-84	342 372	AE63-30-00-04 AE63-30-11-04	447 477
105	—	80	25	30	60	75	0 1	0 1	A75-30-00-84 A75-30-11-84	383 413	AE75-30-00-04 AE75-30-11-04	488 518
125	—	95	30	30	60	75	0 1	0 1	A95-30-00-84 A95-30-11-84	420 450	AE95-30-00-04 AE95-30-11-04	525 555
140	—	110	30	40	75	100	0 1	0 1	A110-30-00-84 A110-30-11-84	450 480	AE110-30-00-04 AE110-30-11-04	660 690

NEMA rated

NEMA size	Continuous current	1.5	1.5	2	2	1	0				
00	9	1.5	1.5	2	2	1	0	A9N00-30-10-84	\$ 78	BC9N00-30-10-04	\$ 123
0	18	3	3	5	5	1	0	A16N0-30-10-84	102	BC16N0-30-10-04	147
1	27	7.5	7.5	10	10	1	0	A26N1-30-10-84	183	BC25N1-30-10-04	228
2	45	10	15	25	25	1	1	A50N2-30-11-84	330	AE50N2-30-11-04	375
3	90	25	30	50	50	1	1	A75N3-30-11-84	413	AE75N3-30-11-04	518

Coil voltage selection

All AC operated catalog numbers include a 120VAC coil. All DC operated catalog numbers include a 110VDC coil. To select other coil voltages, substitute the code from the Coil Voltage Selection Chart for the two digits after the last dash in the catalog number.

Ex.: A 240V coil is required for an A75 contactor: A75-30-00-80

Auxiliary contact blocks

For additional auxiliary contact blocks, see catalog number explanation on page 1.2. Add \$ 20 to list price for each additional auxiliary, and see page 1.18 for available combinations.

Coil voltage selection chart

Hz	Cntr type	Volts															
		12	24	48	110	120	125	208	220	240	277	380	415	440	480	500	600
60	A		81	83	84	84		34	75	80	42	48	86	86	51	53	55
50	A		81	83	84				80				85	86			55
DC	BC	07	01	16	04		27		05	33							
DC	AE	80	81	83	86		87		88	89							

For other voltages, see page 1.13

Non-reversing contactors

4 pole, AC & DC operated

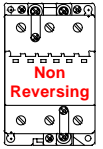

A9-40-00



A26-40-00

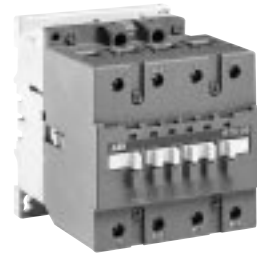

A75-40-00

4 Pole

UL general purpose current		Standard		AC operated		DC operated	
AC operated	DC operated	Auxiliary contacts		Catalog number	List price	Catalog number	List price
21	—	0	0	A9-40-00-84	\$ 120	BC9-40-00-04	\$ 165
30	21	0	0	A16-40-00-84	165	BC16-40-00-04	210
40	30	0	0	A26-40-00-84	228	BC25-40-00-04	273
65	—	0	0	A45-40-00-84	360	AE45-40-00-04	420
80	—	0	0	A50-40-00-84	413	AE50-40-00-04	473
105	—	0	0	A75-40-00-84	525	AE75-40-00-04	570

4 Pole – 2 N.O. & 2 N.C. power poles

UL general purpose current		Standard		AC operated		DC operated	
AC operated	DC operated	Auxiliary contacts		Catalog number	List price	Catalog number	List price
21	—	0	0	A9-22-00-84	\$ 120	BC9-22-00-04	\$ 165
30	21	0	0	A16-22-00-84	165	BC16-22-00-04	210
40	30	0	0	A26-22-00-84	228	BC25-22-00-04	273
65	—	0	0	A45-22-00-84	360	AE45-22-00-04	420
105	—	0	0	A75-22-00-84	525	AE75-22-00-04	570

Coil voltage selection

All AC operated catalog numbers include a 120VAC coil. All DC operated catalog numbers include a 110VDC coil. To select other coil voltages, substitute the code from the Coil Voltage Selection Chart for the two digits after the last dash in the catalog number.

Ex.: A 240V coil is required for an A75 contactor:

A75-22-00-**80**

Auxiliary contact blocks

For additional auxiliary contact blocks, see catalog number explanation on page 1.2. Add \$20 to list price for each additional auxiliary, and see page 1.18 for available combinations.

Coil voltage selection chart

Hz	Cntr type	Volts															
		12	24	48	110	120	125	208	220	240	277	380	415	440	480	500	600
60	A	81	83	84	84		34	75	80	42	48	86	86	51	53	55	
50	A	81	83	84				80			85	86				55	
DC	BC	07	01	16	04		27		05	33							
DC	AE	80	81	83	86		87		88	89							

For other voltages, see page 1.13

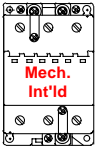

Mechanically interlocked contactors

3 pole, AC & DC operated

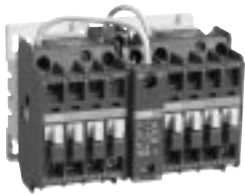

A12M-30-10-84

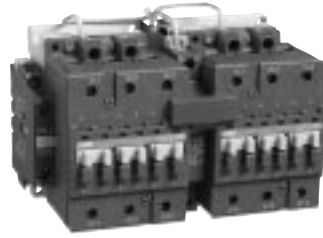

A75M-30-11-84



AE110M-30-11-84

Contactors

General purpose current		Motor switching current	Maximum motor horsepower ratings ^{UL} ^{CS}				Standard		AC operated		DC operated	
AC oper.	DC oper.		208V	240V	480V	575/600V	Auxiliary contacts each contactor		Catalog number	List price	Catalog number	List price
AC1	AC1	AC3	UL rated									
21	—	9	2	2	5	7.5	1 0	0 1	A9M-30-10-84 A9M-30-01-84	\$ 255	BC9M-30-10-04 BC9M-30-01-04	\$ 345
25	—	11	3	3	7.5	10	1 0	0 1	A12M-30-10-84 A12M-30-01-84	315	— —	— —
30	21	17	5	5	10	15	1 0	0 1	A16M-30-10-84 A16M-30-01-84	345	BC16M-30-10-04 BC16M-30-01-04	435
40	33	28	7.5	10	20	25	1 0	0 1	A26M-30-10-84 A26M-30-01-84	405	BC25M-30-10-04 BC25M-30-01-04	495
50	45	32	10	10	25	30	1 0	0 1	A30M-30-10-84 A30M-30-01-84	548	BC30M-30-10-04 BC30M-30-01-04	668
60	—	41	10	15	30	40	1 1	0 1	A40M-30-10-84 A40M-30-11-84	639	— —	— —
80	—	54	15	20	40	50	1	1	A50M-30-11-84	713	AE50M-30-11-04	803
90	—	65	20	25	50	60	1	1	A63M-30-11-84	870	AE63M-30-11-04	1080
105	—	80	25	30	60	75	1	1	A75M-30-11-84	1155	AE75M-30-11-04	1365
125	—	95	30	30	60	75	1	1	A95M-30-11-84	1230	AE95M-30-11-04	1440
145	—	110	30	40	75	100	1	1	A110M-30-11-84	1365	AE110M-30-11-04	1785

NEMA rated

NEMA size	Continuous current											
00	9	1.5	1.5	2	2	1 0	0 1	A9N00M-10-84 A9N00M-01-84	\$ 255	BC9N00M-10-04 BC9N00M-01-04	\$ 345	
0	18	3	3	5	5	1 0	0 1	A16N0M-10-84 A16N0M-01-84	345	BC16N0M-10-04 BC16N0M-01-04	435	
1	27	7.5	7.5	10	10	1 0	0 1	A26N1M-10-84 A26N1M-01-84	405	BC25N1M-10-04 BC25N1M-01-04	495	
2	45	10	15	25	25	1	1	A50N2M-11-84	713	AE50N2M-11-04	803	
3	90	25	30	50	50	1	1	A75N3M-11-84	1155	AE75N3M-11-04	1365	

Description

Mechanically interlocked contactors are designed for reversing, 2 speed, reduced voltage, etc. type starter applications. The complete assembly consists of two mechanically and electrically interlocked contactors mounted as follows with line and load terminals:

- A9 – A16 – mounted on 35mm DIN rail
- A26 – A110 – mounted on common baseplate

Power wiring is **not included**.

The N.C. electrical interlock is provided with the mechanical interlock.

A95 & A110 contactors have the N.C. electrical interlocks provided in the mechanical interlock.

Auxiliary contact blocks

For additional auxiliary contact blocks, see catalog number explanation on page 1.2. Add \$20 to list price for each additional auxiliary, and see page 1.18 for available combinations.

Coil voltage selection

All AC operated catalog numbers include a 120VAC coil. All DC operated catalog numbers include a 110VDC coil. To select other coil voltages, substitute the code from the Coil Voltage Selection chart for the two digits after the last dash in the catalog number.

Ex.: A 240V coil is required for an A75N3M-11 contactor: A75N3M-11-80

Coil voltage selection chart

Hz	Cntr type	Volts															
		12	24	48	110	120	125	208	220	240	277	380	415	440	480	500	600
60	A		81	83	84	84		34	75	80	42	48	86	86	51	53	55
50	A		81	83	84				80			85	86			55	
DC	BC	07	01	16	04		27		05	33							
DC	AE	80	81	83	86		87		88	89							

For other voltages, see page 1.13

Reversing contactors

3 pole, AC & DC operated

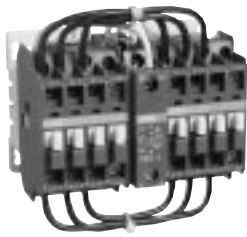
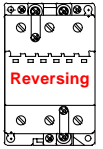

A16R-30-01-83

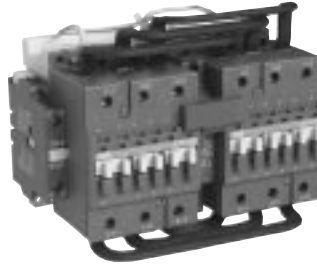

A75R-30-00-83

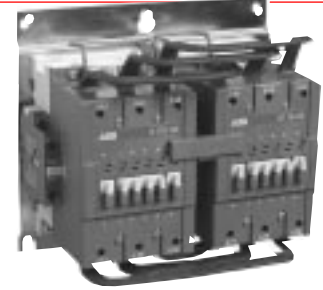

AE110R-30-11-83

General purpose current		Motor switching current	Maximum motor horsepower ratings ^{UL} ^{CS}				Standard		AC operated		DC operated	
AC oper.	DC oper.		208V	240V	480V	575V	Auxiliary contacts each contactor		Catalog number	List price	Catalog number	List price
AC1	AC1	AC3	UL rated									
21	—	9	2	2	5	7.5	1 0	0 1	A9R-30-10-84 A9R-30-01-84	\$ 315	BC9R-30-10-04 BC9R-30-01-04	\$ 405
25	—	11	3	3	7.5	10	1 0	0 1	A12R-30-10-84 A12R-30-01-84	375	— —	— —
30	21	17	5	5	10	15	1 0	0 1	A16R-30-10-84 A16R-30-01-84	413	BC16R-30-10-04 BC16R-30-01-04	503
40	33	28	7.5	10	20	25	1 0	0 1	A26R-30-10-84 A26R-30-01-84	480	BC25R-30-10-04 BC25R-30-01-04	570
50	45	32	10	10	25	30	1 0	0 1	A30R-30-10-84 A30R-30-01-84	623	BC30R-30-10-04 BC30R-30-01-04	743
60	—	41	10	15	30	40	1 1	0 1	A40R-30-10-84 A40R-30-11-84	750	— —	— —
80	—	54	15	20	40	50	1	1	A50R-30-11-84	810	AE50R-30-11-04	930
90	—	65	20	25	50	60	1	1	A63R-30-11-84	1013	AE63R-30-11-04	1208
105	—	80	25	30	60	75	1	1	A75R-30-11-84	1298	AE75R-30-11-04	1493
125	—	95	30	30	60	75	1	1	A95R-30-11-84	1425	AE95R-30-11-04	1635
140	—	110	30	40	75	100	1	1	A110R-30-11-84	1628	AE110R-30-11-04	2048
NEMA rated												
NEMA size	Continuous current											
00	9	1.5	1.5	2	2	1 0	0 1	A9N00R-10-84 A9N00R-01-84	\$ 315	BC9N00R-10-04 BC9N00R-01-04	\$ 405	
0	18	3	3	5	5	1 0	0 1	A16N0R-10-84 A16N0R-01-84	413	BC16N0R-10-04 BC16N0R-01-04	503	
1	27	7.5	7.5	10	10	1 0	0 1	A26N1R-10-84 A26N1R-01-84	480	BC25N1R-10-04 BC25N1R-01-04	570	
2	45	10	15	25	25	1	1	A50N2R-11-84	810	AE50N2R-11-04	930	
3	90	25	30	50	50	1	1	A75N3R-11-84	1298	AE75N3R-11-04	1493	

Contactors

Description

Reversing contactors are designed for reversing type starter applications. The complete assembly consists of two mechanically and electrically interlocked contactors mounted as follows with line and load terminals:

- A9 – A16 — mounted on 35mm DIN rail
- A26 – A110 — mounted on common baseplate

The N.C. electrical interlock is provided with the mechanical interlock.

A95 & A110 contactors have the N.C. electrical interlocks provided in the mechanical interlock.

Auxiliary contact blocks

For additional auxiliary contact blocks, see catalog number explanation on page 1.2. Add \$20 to list price for each additional auxiliary, and see page 1.18 for available combinations.

Coil voltage selection

All AC operated catalog numbers include a 120VAC coil. All DC operated catalog numbers include a 110VDC coil. To select other coil voltages, substitute the code from the Coil Voltage Selection chart for the first digit after the last dash in the catalog number.

Ex.: A 240V coil is required for an A75N3R-11 contactor: A75N3R-11-80

Coil voltage selection chart

Hz	Cntr type	Volts															
		12	24	48	110	120	125	208	220	240	277	380	415	440	480	500	600
60	A		81	83	84	84		34	75	80	42	48	86	86	51	53	55
50	A		81	83	84				80			85	86			55	
DC	BC	07	01	16	04		27		05	33							
DC	AE	80	81	83	86		87		88	89							

For other voltages, see page 1.13

AC 1030 – 6/98

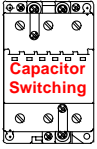

Contactors

for 3 phase capacitor switching

3 pole, AC operated



UA75-30-00-84



UA95-30-00-84

240V	Max kvar switching capacity			Standard auxiliary contacts		Catalog number	List price
	480V	575/600V		N.O.	N.C.		
12.5	25	30		1	0	UA26-30-10-84	\$ 225
16	32	40		1	0	UA30-30-10-84	338
20	40	50		0	0	UA50-30-00-84	345
				1	1	UA50-30-11-84	375
27.5	55	70		0	0	UA75-30-00-84	450
				1	1	UA75-30-11-84	480
35	70	75		0	0	UA95-30-00-84	465
				1	1	UA95-30-11-84	495
40	80	85		0	0	UA110-30-00-84	525
				1	1	UA110-30-11-84	570

For 3 phase capacitors carrying out single bank or stepped bank compensation.

Max. peak current \hat{I} : 100 times the capacitor nominal r.m.s. current at $U_e \leq 500V$ or 90 times for $U_e > 500V$

Electrical durability: 100,000 operating cycles.

Contactor type	Power in kvar 50/60 Hz															Max. permissible peak current \hat{I} (kA)	
	220/240V			380/400/415V			440V			500/550V			660/690V			$U_e \leq 500V$	$U_e > 50C$
	40° C	55° C	70° C	40° C	55° C	70° C	40° C	55° C	70° C	40° C	55° C	70° C	40° C	55° C	70° C		
UA26	12	11	9	20	16.5	14.5	22	22	17	22	22	19.5	30	30	26	3	2.7
UA30	16	16	11	27.5	27.5	19	30	30	20	32	32	23.5	40	40	35	3.5	3.1
UA50	20	20	20	33	32	32	36	35	35	37.5	37.5	37.5	51	51	51	5	4.5
UA75	30	30	25	50	50	40	55	54.5	44	62.5	58.5	47.5	86	80	65	7.5	6.75
UA95	35	35	30	60/65*	60/65*	50/55*	65	65	55	70	70	60	75	75	65	9.3	8
UA110	40	40	35	75	65	60/65*	75	75	70	80	80	75	90	90	85	10.5	9

* Use these values for $U_e = 415V$

Coil voltage selection

All AC operated catalog numbers include a 120VAC coil. All DC operated catalog numbers include a 110VDC coil. To select other coil voltages, substitute the code from the Coil Voltage Selection Chart for the two digits after the last dash in the catalog number.

Ex.: A 240V coil is required for a UA110 contactor: UA110-30-00-80

Auxiliary contact blocks

For additional auxiliary contact blocks, see catalog number explanation on page 1.2. Add \$20 to list price for each additional auxiliary, and see page 1.18 for available combinations.

Coil voltage selection chart

Hz	Cntr type	Volts																	
		12	24	48	110	120	125	208	220	240	277	380	415	440	480	500	600		
60	A	81	83	84	84		34	75	80	42	48	86	86	51	53	55			
50	A	81	83	84				80			85	86			55				

For other voltages, see page 1.13

Accessories for A, AE & BC contactors

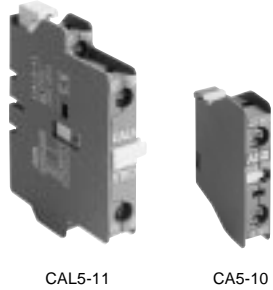
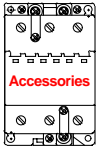

CAL5-11

CA5-10



TP40DA



VE5-1



RV5/50

RC5-1/50



LK75-A

LK75-A1

LK110

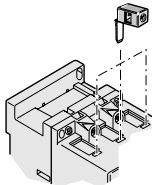

Auxiliary contact blocks

Positioning	Maximum number of contact blocks	Contact Description	Catalog number	List price
Front mounting (single pole)	4 blocks: A9 – A26 BC9 – BC30 5 blocks: A30, A40 6 blocks: A45 – A110 AE45 – AE110	1 N.O. 1 N.C. 1 N.O. Early make 1 N.C. Late break	CA5-10 CA5-01 CC5-10 CC5-01	\$ 15
Front mounting (4 pole)	1 block: A9 – A26-40-00 A30 – A110 AE45 – AE110 BC9 – BC25-40-00 BC30-30-00	4 N.O. 3 N.O. & 1 N.C. 2 N.O. & 2 N.C. 4 N.C. 2 N.O./2 N.C.Ⓞ	CA5-40E CA5-31E CA5-22E CA5-04E CA5-11/11E	30
	1 block: A9 – A40-30-10 BC9 – BC25-30-10	3 N.O. & 1 N.C. 2 N.O. & 2 N.C. 4 N.C. 2 N.O./2 N.C.Ⓞ	CA5-31M CA5-22M CA5-04M CA5-11/11M	
Side mounting (2 pole)	2 blocks: A9 – A110, N 1 block: AE45 – AE110	1 N.O. & 1 N.C.	CAL5-11	

Pneumatic timers

Mounting on	Timing range	Contacts N.O. N.C.	Catalog number	List price
A9 – A75	On delay 0.1 – 40 s	1 1	TP40DA	\$ 108
	On delay 10 – 180 s	1 1	TP180DA	
	Off delay 0.1 – 40 s	1 1	TP40IA	
	Off delay 10 – 180 s	1 1	TP180IA	

Interlocks

Feature	Mounting on	Contacts N.O. N.C.	Catalog number	List price
Mechanical/electrical Mechanical	A9 – A40	— 2	VE5-1	\$ 45
	A50 – A110	— 2	VE5-2	45
	A9 – A40	— —	VM5-1	21

Note: Use type VE 5-2 for mechanical and electrical interlocking between contactors A40 and A50.

Surge suppression device

Feature	Mounting on	Voltage range	Catalog number	List price
Varistor	A9 – A110	24 – 50 VAC	RV5/50	\$ 30
		50 – 133 VAC	RV5/133	
		110 – 250 VAC	RV5/250	
		250 – 440 VAC	RV5/440	
RC	A9 – A40	24 – 50 VAC/DC	RC5-1/50	\$ 30
		50 – 133 VAC/DC	RC5-1/133	
		110 – 250 VAC/DC	RC5-1/250	
		250 – 440 VAC/DC	RC5-1/440	
RC	A45 – A110	24 – 50 VAC/DC	RC5-2/50	\$ 30
		50 – 133 VAC/DC	RC5-2/133	
		110 – 250 VAC/DC	RC5-2/250	
		250 – 440 VAC/DC	RC5-2/440	

Auxiliary lead terminals

Connections	Mounting on	Catalog number	List price
Connects from side Connects from top Connects from side	A50 – A75	LK75-A	\$ 15
	A50 – A75	LK75-A1	15
	A95 – A110	LK110	23

Ⓞ Includes 1 N.O. & 1 N.C. overlapping

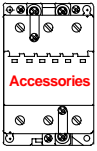

Accessories for A, AE & BC, BE contactors



RA5



RA5 mounted on A75 contactor



RA30 mounted on BC16 contactor



BA5-50



WB75A-04

Interface relay

Mounting on	Coil voltage	Catalog number	List price
A9 – A110	24 VDC	RA5	\$ 75
BC9 – BC30	24 VDC	RA30	

Identification marker

Mounting on	Coil voltage	Catalog number	List price
A9 – A110	Pack of 50	BA5-50	\$ 15

Mechanical latches

For contactors	Catalog number	List price
A, AE & BC, BE [Ⓞ]	WB75A-★	\$ 84

★ - Coil voltage suffix. Refer to Coil Voltage Selection chart and substitute the desired coil voltage suffix for the ★.

Coil voltage selection chart — mechanical latches for B, BC, BE & A, AE contactors

50 Hz	60 Hz	Voltage code
24	24 - 28	01
42	42 - 48	02
48	48 - 55	03
110	110 - 127	04
220 - 230	220 - 255	06
230 - 240	230 - 277	05
380 - 415	380 - 440	07
415 - 440	440 - 480	08

Range: WB75A for contactors A9 – A75, BC9 – BC30, AE45 – AE75 and control relays N and KC.

Description: WB75A block: contains a mechanical latching device with electromagnetic impulse unlatching (AC or DC) or manual unlatching. Captive screw type connecting terminals, built-in cable clamps, M 3.5 (=, -) posidrive 1 screw with screwdriver guidance, delivered untightened and protected against accidental direct contact.

Operation: After closing, the contactor continues to be held in the closed position by the latching mechanism should the supply voltage fail at the contact coil terminals. Contactor opening can be controlled:

Operation: After closing, the contactor continues to be held in the closed position by the latching mechanism should the supply voltage fail at the contact coil terminals. Contactor opening can be controlled:

- electrically by an impulse* (AC or DC) on the WB75A block coil. The coil is not designed to permanently energized.
- manually by pressing the pushbutton on the front face of the WB75A block.

Mounting: WB75A is clipped onto the front face of the contactor.

[Ⓞ] Excludes A(E)95 & A(E)110.

Accessories for A contactors TE5S Electronic Timer for Wye-Delta starters



TE5S-*

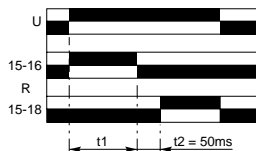

Chart

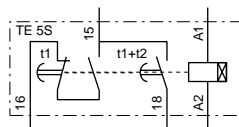

Equivalent diagram

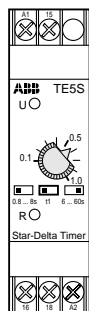

Front face

Electronic timer

For contactors	Rated control voltage U_c V	Packing piece	Unit weight kg	Catalog number	List price
A9 – A110	24 AC/DC	1	0.080	TE5S-24	\$ 120
	110 – 115 AC	1	0.080	TE5S-115	
	220 – 230 AC	1	0.080	TE5S-230	

Application

Utilization

When used in wye-delta starters, the **TE5S** lags the wye connection and provides a lapse of 50 ms before the switchover to the delta connection.

Description

According to the type of device chosen, the electronic circuit has a 24 VAC/VDC, 110 – 120 VAC or 220 – 230 VAC supply. An output relay with reversing contact ensures high current switching. A two-position switch allows selection of one of the two time delay ranges: 0.8 to 8 s or 6 to 60 s. The 0.1 to 1.0 adjustable knob allows an initial setting without steps within the previously selected range which can then be adjusted using a stopwatch.

Note: We recommend that you allow for temperature drift for the final adjustment of the time delay setting. Drift: -0.2% per $^{\circ}\text{C}$. For example, a setting made at 20°C will yield a time delay shorter by 7% at 55°C in an enclosure. (-0.2% per $^{\circ}\text{C}$ i.e. $-0.2 \times 35 = -7\%$).

The **TE5S**, which is not affected by these settings, establishes a fixed “lapse” of 50 ms between the opening of contact 15 – 16 and the closing of contact 15 – 18. It is this time delay that prevents from arc short-circuit during wye to delta switching.

Operation

On energization, the green U indicator light (voltage applied) comes on. Contact 15 – 16 then immediately moves to the closed position.

Count-down of the programmed time immediately commences.

When the time delay has elapsed, contact 15 – 16 opens and at the same time the 50 ms lapse, t_2 , begins after which contact 15 – 18 moves to the closed position. The yellow R indicator light comes on.

On de-energization, the U and R indicator lights go out and, after the 250 ms resetting time, the device is ready for a new cycle.

Mounting

Mounts on 35mm DIN rail.

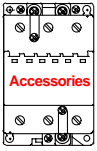

Accessories for A contactors TE5S Electronic Timer for Wye-Delta starters

Technical data

Type	TE5S-24	TE5S-115	TE5S-230
Compliance with standards	IEC 947-5-1, EN 60947-5-1 and VDE 0435		
Rated insulation voltage U_i according to IEC 947-5-1	V 250		
Rated supply voltage U_c	VDC 24 VAC 24	— 110 – 115	— 220 – 230
Rated frequency limits	Hz 48 – 63		
Supply voltage range	0.85 – 1.1 U_c		
Overtoltage protection	Built-in varistor		
Load factor	% 100		
Average consumption	in DC in AC W VA	— 3.5	— 6.5
Time delay range (t_1) selected by switch	S 0.8 – 8 and 6 – 60		
Temperature drift	% per °C - 0.2		
Mechanical setting accuracy	± 15% of the setting range		
On-load reiteration accuracy under constant conditions	± 2% after 1 million operations		
Minimum time lapse (t_2)	ms 50		
Min. time lapse after 1 million operations	ms 40		
Resetting time (maximum)	ms 250		
Front panel display:	green indicator light yellow indicator light	Energization Output relay activated	
Rated operational voltage U_o acc. to IEC 947-5-1	VDC 24 VAC 24 – 230		
Conventional free air thermal current I_{th}	A 10		
Rated operational current I_o acc. to IEC 947-5-1			
DC-13	24 VDC	A 4	
AC-15	24 – 115 VAC 220 – 230 VAC	A 5 A 4	
Permissible air temperature			
for operation	°C	-25 ... +60	
for storage	°C	-40 ... +85	
Mechanical durability in millions of operations	5		
Electrical durability in millions of operations	1		
On-load maximum switching frequency	ops./h 720		
Shock and vibration withstand	on request		
Fixing on mounting rail according to EN 50022	35 x 7.5 or 35 x 15		
Connecting terminals	(+, -) pozidriv 1 screw		
Tightening torque	N.m 0.6 – 0.8 max.		
Connecting capacity			
Rigid solid	1 or 2 x mm²	1 – 2.5	
Flexible without cable end	1 or 2 x mm²	0.75 – 2.5	
Degree of protection acc. to IEC 529, IEC 947-1 and EN 60 529			
Housing	IP 50		
Terminals	IP 20		

Accessories

for A, AE, BC contactors & KC control relays

Coils & coil voltage codes

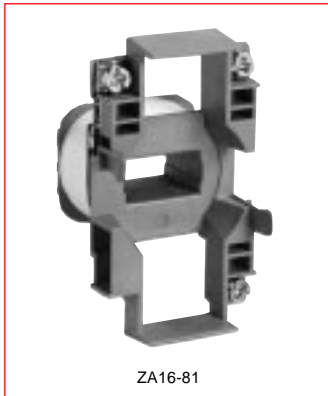
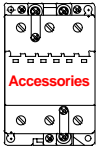

Coils — AC operated

For contactors	Catalog number	List price
A9 – A16	ZA16-★	\$ 24
A26 – A40	ZA40-★	30
A45 – A75	ZA75-★	57
A95 – A110	ZA110-★	60

Coils — DC operated

KC and BC9 – BC30	KBC30G-★	36
AE45 – AE75	ZAE75-★	57
AE95 – AE110	ZAE110-★	90
Auxiliary including an insertion contact and a varistor for DC operated contactors	CDL5-01 AE45 – AE75 AE95 – AE110	45

★ – Coil voltage suffix. Refer to Coil Voltage Selection charts below and substitute the desired coil voltage code for the ★.

Coil voltage selection — AC Operated

for A9 – A110; UA26 – UA95

VAC (50Hz)	VAC (60Hz)	Voltage Code
24	24	81
26	28	16
28	32	17
42	42	82
48	48	83
60	60	73
100	100 – 110	74
110	110 – 120	84
110 – 115	115 – 127	89
120	140	29
125 – 127	150	30
175	208	34
190	220	36

VAC (50Hz)	VAC (60Hz)	Voltage Code
200	200 – 220	75
220 – 230	230 – 240	80
230 – 240	240 – 260	88
230 – 240	277	42
230/400 ^①	—	62
—	230/400 ^①	63
—	380	48
380 – 400	400 – 415	85
400 – 415	415 – 440	86
—	480	51
440	500	53
500	600	55
550	—	56
660 – 690	—	58

Coil voltage selection — DC Operated

for AE & BC contactors; KC control relays

VDC	Voltage code	
	KC Control relays BC Contactors	AE Contactors
12	07	80
24	01	81
42	02	82
48	16	83
50	17	21
60	03	84

VDC	Voltage code	
	KC Control relays BC Contactors	AE Contactors
75	22	85
110	04	86
125	27	87
220	05	88
240	33	89
250	34	38

^① Dual voltage coil for N, A9 - A16 only.

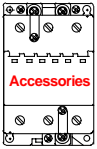

Accessories for A & BC contactors

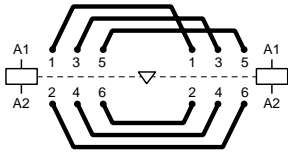

BEM circuit diagram

Connection kits for reversing

Mounting on 3 pole contactors	Catalog number	List price
A9 – A16 A26 A30, A40 A50 – A75 A95, A110	BEM16-30 BEM26-30 BEM40-30 BEM75-30 BEM110-30	\$ 23 30 45 165 180
BC9, BC16 BC25 BC30	BSM16-30 BSM25-30BC BSM30-30BC	23 30 45

Application

Connections between the main poles of **two 3 pole contactors** mounted side by side so that they operate as reversing contactors.

Description

The sets are made up of three reversing connections and three phase to phase connections.

- BEM16-30** — Insulated, solid, rigid copper wires
- BEM26 and 40-30** — Insulated, stranded, rigid copper wires
- BEM75 and 110-30** — Insulated, solid copper bars
- BSM16-30, BSM25 and 30-30BC** — Insulated, solid, rigid copper wires

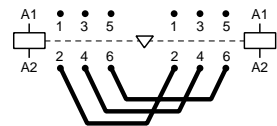

BES110 connection diagram

Connection kits for phase to phase

Mounting on 3 pole contactors	Catalog number	List price
A(E)50, A(E)75 A(E)95, A(E)110	BES75-30 BES110-30	\$ 75 90

Description

This set is made up of three phase to phase bus bars.

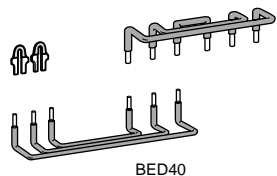

BED40

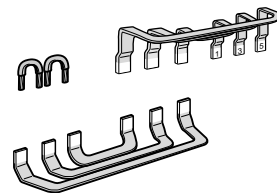

BED75

Connection kits for wye-delta starters

Mounting on contactors		Catalog number	List price
Line and delta contactor	Wye contactor		
A30 A40	A26 A26	BED40	\$ 53
A50 A63	A30 A40	BED50	165
A75	A50	BED75	180
A95	A75	BED95	195
A110	A95	BED110	225

Application

Connections between the main poles of a wye-delta starter.

Description

These sets are made up of:

- Three line contactor/wye contactor connections — line side.
- Three wye contactor/delta contactor connections — load side.
- The shorting connection for the "S" contactor.

- BED40** — Insulated, stranded, rigid copper wires.
- BED50 – BED110** — Insulated, solid copper bars.

The above connection sets allow a mechanical interlock unit to be mounted between the wye and delta contactors if required.

Accessories for A & AE contactors

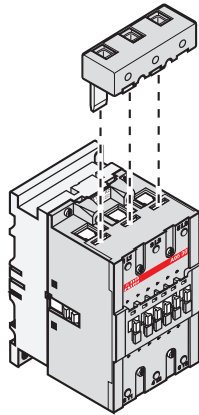
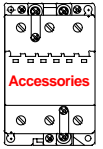

LD110

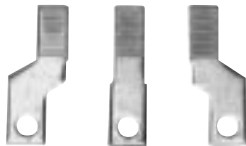

BEXT-75

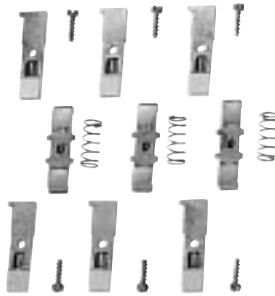

ZL75

Additional terminal block

Mounting on 3 pole contactors	Catalog number	List price
A(E)95 and A(E)110	LD-110	\$ 30

Application

The LD110 terminal block is designed to increase the connection capacity of the contactor on which it is mounted: A(E)95 or A(E)110.

Description

Block housing three connectors: 1 per phase. Each connector is equipped with an HC, M8 socket head screw and has the following connection details:

- Stranded conductor (1) 6–2/0 OR (2) 4–1/0
- Busbar max. width 12 mm

Mounting

The LD110 terminal block can be mounted in the terminal slots located on line or load side of contactor.

Terminal extensions

Mounting on contactors	Dimensions		Catalog number	List price
	Hole Ø mm	Bar mm		
A50 – A75	6.5	12X3	BEXT-75	\$ 15
A(E)95, A(E)110	6	15x3	LW-110	

Application

They are designed to increase the width of the contactor terminal pads to allow larger connectors to be mounted.

Description

Terminal extension sets contain 3 bars.

Contact kits

For contactors	Catalog number	List price
3 Pole		
A/AE	ZL50	\$ 113
A/AE	ZL63	135
A/AE	ZL75	158
A/AE95-30	ZL95	225
A/AE110-30	ZL110	255
4 Pole		
A/AE45-40	ZLT45	150
A/AE50-40	ZLT50	150
A/AE75-40	ZLT75	210

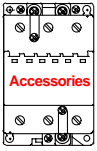

Terminal marking & positioning for A & UA contactors

Standard devices without addition of auxiliary contacts

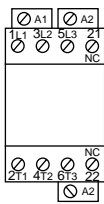

A9 - A40-30-01

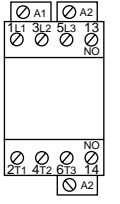

A9 - A40-30-10

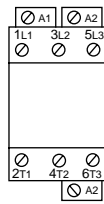

A50 - A110-30-00
UA50 - UA110-30-00

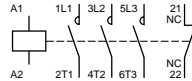

A9 - A40-30-01

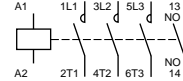

A9 - A40-30-10

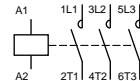

A50 - A110-30-00
UA50 - UA110-30-00

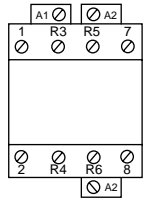

A9 - A26-22-00
A45 - A75-22-00

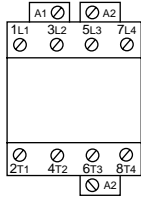

A9 ... A26-40-00
A45 ... A75-40-00

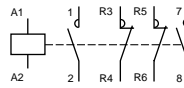

A9 - A26-22-00
A45 - A75-22-00

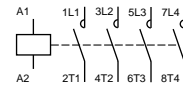

A9 - A26-40-00
A45 - A75-40-00

Standard 3 pole devices with factory mounted auxiliary contacts

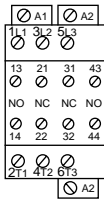

A9 - A16-30-22

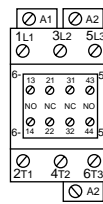

A50 - A110-30-22

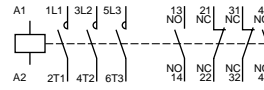

A9 - A16-30-22
A50 - A110-30-22

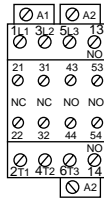

A9 - A40-30-32

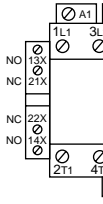

A50 ... A110-30-11
UA50 ... UA110-30-11

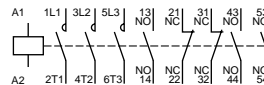

A9 - A40-30-32

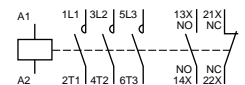

A50 - A110-30-11
UA50 - UA110-30-11

Other possible contact combinations with auxiliary contacts added by the user

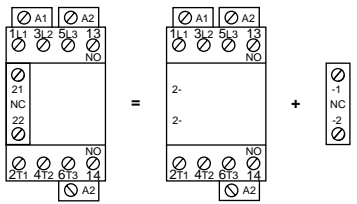

Combination 11 = A9 - A40-30-10 + CA5-01

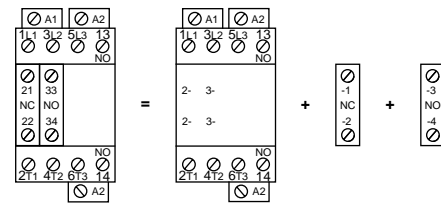

Combination 21 = A9 - A40-30-10 + CA5-01 + CA5-10

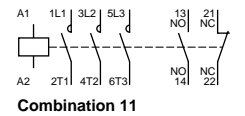

Combination 11

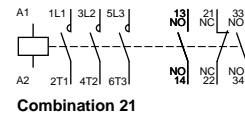

Combination 21

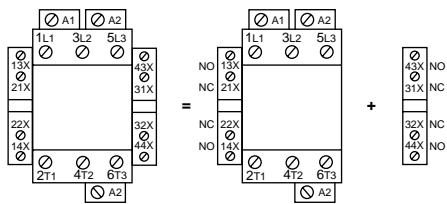

Combination 22 = A50 - A75-30-11 + CAL5-11

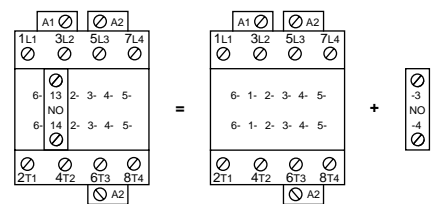

Combination 10 = A45 - A75-40-00 + CA5-10

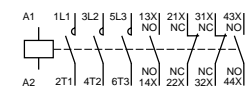

Combination 22

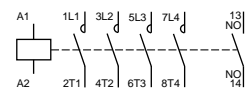

Combination 10

Terminal marking & positioning for AE & BC contactors

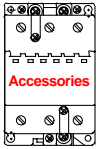

AE Contactors — D.C. Operated

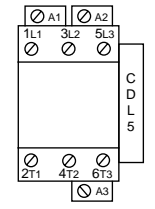

AE50 - AE75-30-00

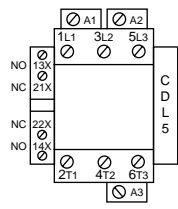

AE50 - AE75-30-11

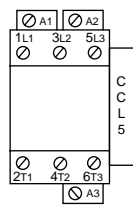

AE95 - AE110-30-00

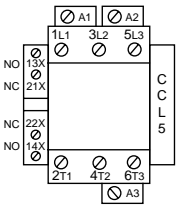
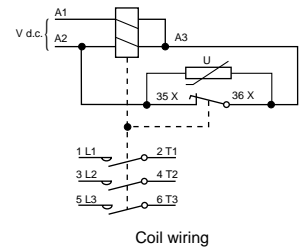
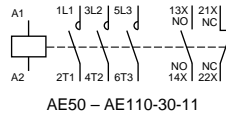
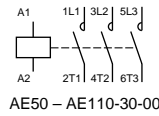

AE95 - AE110-30-11

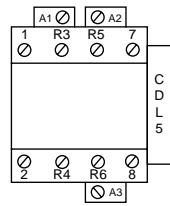

AE45 - AE75-22-00

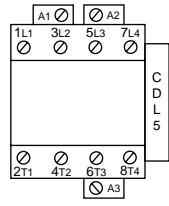

AE45 - AE75-40-00

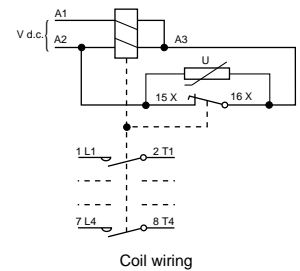
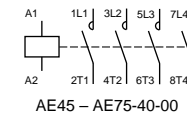
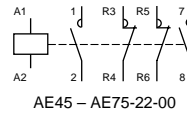

BC Contactors — D.C. Operated

Standard devices without addition of auxiliary contacts

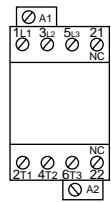

BC9 - BC25-30-01

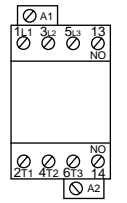

BC9 - BC25-30-10

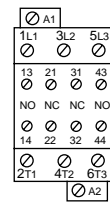

BC30-30-22

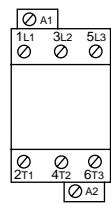
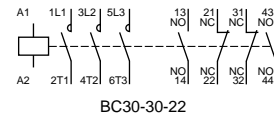
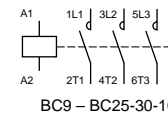
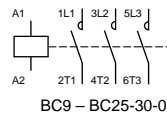

BC30-30-00

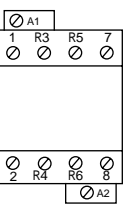

BC9 - BC25-22-00

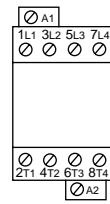

BC9 - BC25-40-00

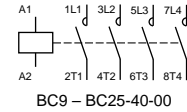
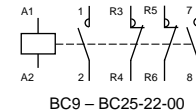
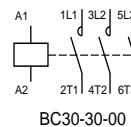

Other possible contact combinations with auxiliary contacts added by the user

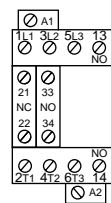

Combination 21

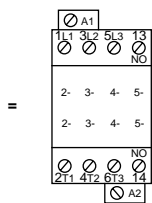

BC9 - BC25-30-10



CA5-01



CA5-10

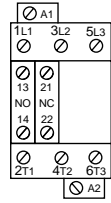

Combination 11

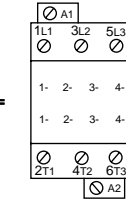

BC30-30-00



CA5-10



CA5-01

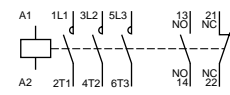
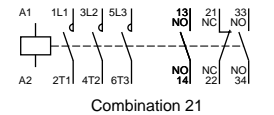

AC 1030 - 6/98

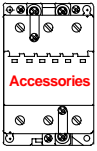

Possible accessory combinations for A contactors & N, KC control relays

Positioning	Accessories — Front face mounting		Accessories — Side mounting		
	Auxiliary contacts 1 – pole	Auxiliary contacts 4 – pole	Pneumatic timers	Auxiliary contacts	Electrical or mechanical interlock ^①
	CA5-10 or CA5-01	CA5-40 or CA5-22 or CA5-31	TP – D or TP – I	CAL 5-11	VE5-1 or VM 5-1 VE 5-2

Configurations of accessories are different depending on whether front or side mounted.

Type	Main poles	Built-in auxiliary contacts	Accessories — Front mounting		Accessories — Side mounting		
			Auxiliary contact blocks 1-pole CA5-	Auxiliary contact blocks 4-pole CA5-	TP - A Pneumatic timer block	Auxiliary contact Blocks 2-pole CAL5-11	Interlock units ● mechanical VM5- ● mech. + elec. VE5-
N	2	2 E	1 to 4 CA5-1-pole blocks	or 1 CA5-4-pole block	or 1 TP - A block	+ 1 to 2 CAL5-11 blocks	or 1 VM ^M /E5-1 block + 1 CAL5-11 block
N	3	1 E	—	—	—	—	—
N	4	0 E	—	—	—	—	—
N	4	4 E	—	—	—	—	—
N	5	3 E	—	—	—	—	—
N	6	2 E	—	—	—	—	—
N	7	1 E	—	—	—	—	—
N	8	0 E	—	—	—	—	—
A9 – A26	– 3 0 – 1 0	—	1 to 4 CA5-1-pole blocks	or 1 CA5-4-pole block	or 1 TP - A block	+ 1 to 2 CAL5-11 blocks	or 1 VM ^M /E 5-1 block + 1 CAL5-11 block
A9 – A26	– 3 0 – 0 1	—	—	—	—	—	—
A9 – A26	– 4 0 – 0 0	—	—	—	—	—	—
A9 – A26	– 2 2 – 0 0	—	—	—	—	—	—
A9 – A16	– 3 0 – 2 2	—	—	—	—	—	—
A9 – A26	– 3 0 – 3 2	—	—	—	—	—	—
A30, A40	– 3 0 – 1 0	—	1 to 5 CA5-1-pole blocks	or 1 CA5-4-pole block + 1 CA5-1-pole block	or 1 TP - A block + 1 CA5-1-pole block	+ 1 to 2 CAL5-11 blocks	or 1 VM ^M /E 5-1 block + 1 CAL5-11 block
A30, A40	– 3 0 – 0 1	—	—	—	—	—	—
A30, A40	– 3 0 – 3 2	—	1 CA5-1-pole block	—	—	+ 1 to 2 CAL5-11 blocks	or 1 VM ^M /E 5-1 block + 1 CAL5-11 block
A50 – A75	– 3 0 – 0 0	—	1 to 6 CA5-1-pole blocks	or 1 CA5-4-pole block or + 2 CA5-1-pole blocks	or 1 TP - A block + 2 CA5-1-pole blocks	+ 1 to 2 CAL5-11 blocks	or 1 VE5-2 block + 1 CAL5-11 block
A45 – A75	– 4 0 – 0 0	—	—	—	—	—	—
A45, A75	– 2 2 – 0 0	—	—	—	—	—	—
A95, A110	– 3 0 – 0 0	—	—	—	—	—	—
A50 – A75	– 3 0 – 2 2	—	2 CA5-1-pole blocks	—	—	+ 1 to 2 CAL5-11 blocks	or 1 VE5-2 block + 1 CAL5-11 block
A95, A110	– 3 0 – 2 2	—	—	—	—	—	—
AE50 – AE75	– 3 0 – 0 0	—	1 to 6 CA5-1-pole blocks	or 1 CA5-4-pole block or + 2 CA5-1-pole blocks	or 1 TP - A block + 2 CA5-1-pole blocks	+ 1 CAL5-11 block	or 1 VE5-2 block
AE45 – AE75	– 4 0 – 0 0	—	—	—	—	—	—
AE45, AE75	– 2 2 – 0 0	—	—	—	—	—	—
AE95, AE110	– 3 0 – 0 0	—	—	—	—	—	—
A50 – A75	– 3 0 – 1 1	—	1 to 6 CA5-1-pole blocks	or 1 CA5-4-pole block or + 2 CA5-1-pole blocks	or 1 TP - A block + 2 CA5-1-pole blocks	+ 1 CAL5-11 block + 1 CAL5-11 block	or 1 VE5-2 block or 1 VE5-2 block
AE50, AE75	– 3 0 – 1 1	—	—	—	—	—	—
A95, A110	– 3 0 – 1 1	—	—	—	—	—	—
AE95, AE110	– 3 0 – 1 1	—	—	—	—	—	—

Contactor mounting configurations (standard from factory)

Auxiliary contacts are mounted on the contactor in the following order:

- Left – 1st
- Right – 2nd
- Top – 3rd (L to R)

① In mounting position 5 (see page 1.20), there should be no more than 2 "N.C." front-mounted auxiliary contacts – The CAL 5-11 side-mounted blocks offer additional "N.C." contacts.

② Whatever the mounting position (see page 1.20), there should be no more than 2 "N.C." front-mounted auxiliary contacts – The CAL 5-11 side-mounted blocks offer additional "N.C." contacts.

Accessory mounting information for A & AE contactors

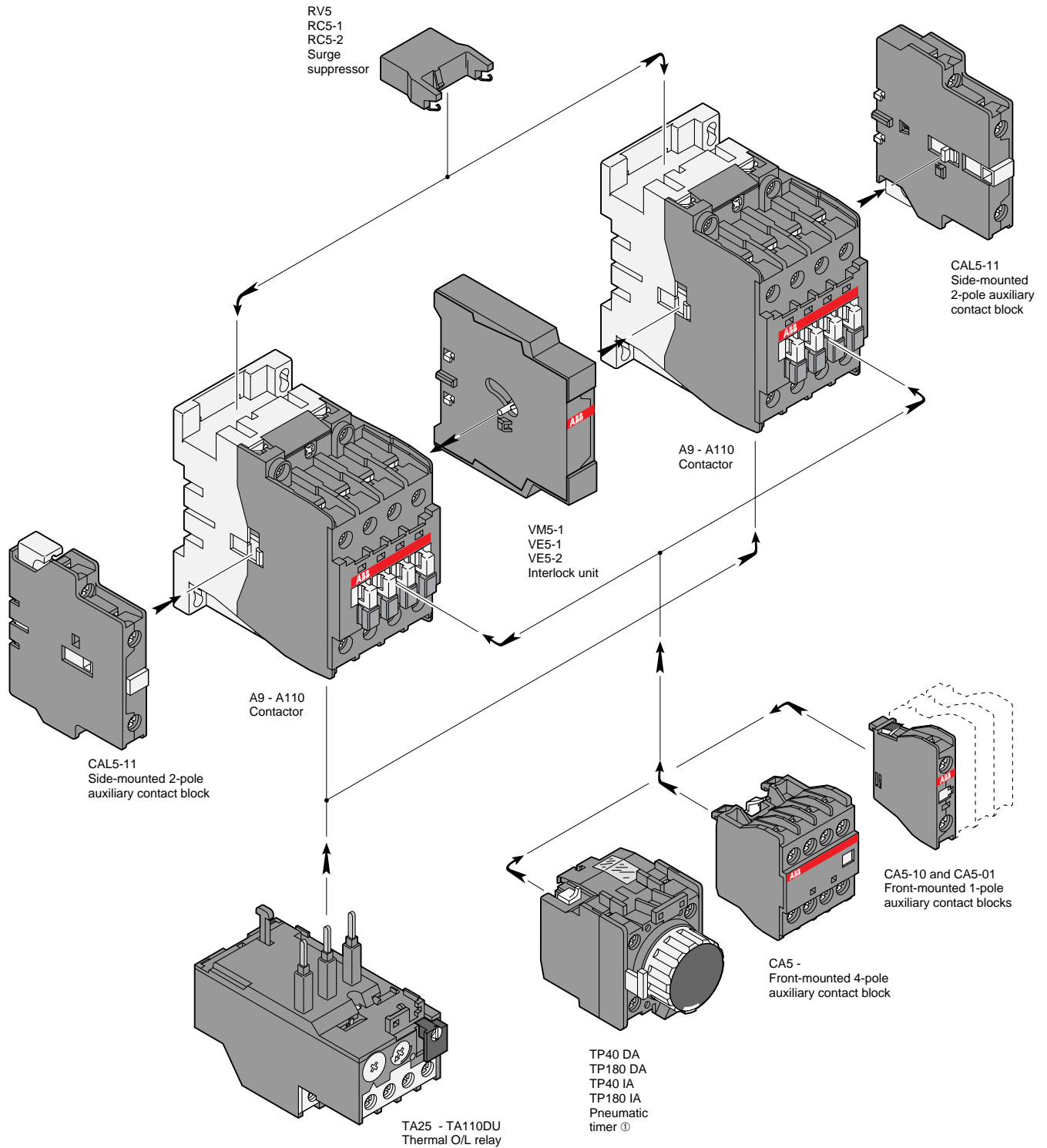
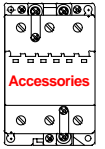

Contactors

AC 1030 - 6/98

① Not for use with A95 & A110 contactors.

CONTACTORS: Description: 1.1 - 1.3 Selection: 1.4 - 1.8 Accessories: 1.9 - 1.19 Technical data: 1.20 - 1.30 Motor data: 1.31 Dimensions: 1.32 - 1.42

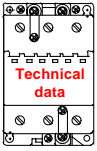

UL & CSA Technical data for AC operated A contactors Mounting positions

Contactors

ABB contactor frame size	A9	A12	A16	A26	A30	A40	A45	A50	A63	A75	A95	A110
NEMA size	00	—	0	1	1P	—	—	2	—	3	—	—
Number of poles	3 or 4	3	3 or 4	3 or 4	3	3	4	3 or 4	3	3 or 4	3	3
A.C. rating information												
NEMA cont. amp rating (thermal current)	9	—	18	27	36	—	—	45	—	90	—	—
NEMA maximum H.P. ratings (1 phase)												
115VAC	1/3	.75	1	2	3	—	—	3	—	—	—	—
230VAC	2	2	3	3	7.5	—	—	10	—	—	—	—
NEMA maximum H.P. ratings (3 phase)												
200VAC	1.5	—	3	7.5	—	—	—	10	—	25	—	—
230VAC	1.5	—	3	7.5	—	—	—	15	—	30	—	—
460/575VAC	2	—	5	10	—	—	—	25	—	50	—	—
U.L. general purpose current (40°C)	A 21	25	30	40	50	60	65	80	90	105	125	140
U.L. max 3 Ph. switching motor loads	A 9	11	17	28	32	41	—	54	65	80	95	110
U.L. maximum H.P. ratings (1 phase)												
115 VAC	1/2	3/4	1	2	3	3	—	3	5	7.5	7.5	10
230 VAC	2	2	3	5	7.5	7.5	—	7.5	10	15	20	25
U.L. maximum H.P. ratings (3 phase)												
200 - 208 VAC	2	3	5	7.5	10	10	—	15	20	25	30	30
220 - 240 VAC	2	3	5	10	10	15	—	20	25	30	30	40
440 - 480 VAC	5	7.5	10	20	20	30	—	40	50	60	60	75
550 - 600 VAC	7.5	10	15	25	30	40	—	50	60	75	75	100
Lighting-ballast and incand., 600 VAC	15	15	20	35	50	60	65	65	85	105	—	—
Resistive heating applications, 600 VAC	15	15	20	35	50	60	65	65	85	105	—	—
Auxiliary contacts												
NEMA rating, AC												
AC rated voltage, VAC	A600	A600	A600	A600	A600	A600	—	A600	A600	A600	A600	A600
AC thermal rated current, A	600	600	600	600	600	600	—	600	600	600	600	600
AC maximum volt-ampere making, VA	10	10	10	10	10	10	—	10	10	10	10	10
AC maximum volt-ampere breaking, VA	7200	7200	7200	7200	7200	7200	—	7200	7200	7200	7200	7200
NEMA rating, DC												
DC rated voltage, VDC	P600	P600	P600	P300	P300	P300	—	P300	P300	P300	P300	P300
DC thermal rated current, A	600	600	600	600	600	600	—	600	600	600	600	600
DC maximum make-break	5	5	5	5	5	5	—	5	5	5	5	5
	A 0.2	0.2	0.2	0.2	0.2	0.2	—	0.2	0.2	0.2	0.2	0.2
Approximate weight												
Contactors	Lbs.	0.7	0.7	0.7	1.01	1.2	2.25	2.25	2.25	2.25	3.5	5
Starters	Lbs.	1.04	1.04	1.04	1.35	1.54	3	—	3	3	6	7
Wire range												
Number of wires per phase	AWG	18 - 10	18 - 10	18 - 10	12 - 8	8 - 4	8 - 4	8 - 1	8 - 1	8 - 1	8 - 1	6 - 2/0
Tightening torque, lb. in.		2	2	2	2	2	2	1	1	1	1	1
		9	9	9	15	20	20	40	40	40	50	50

Mounting positions

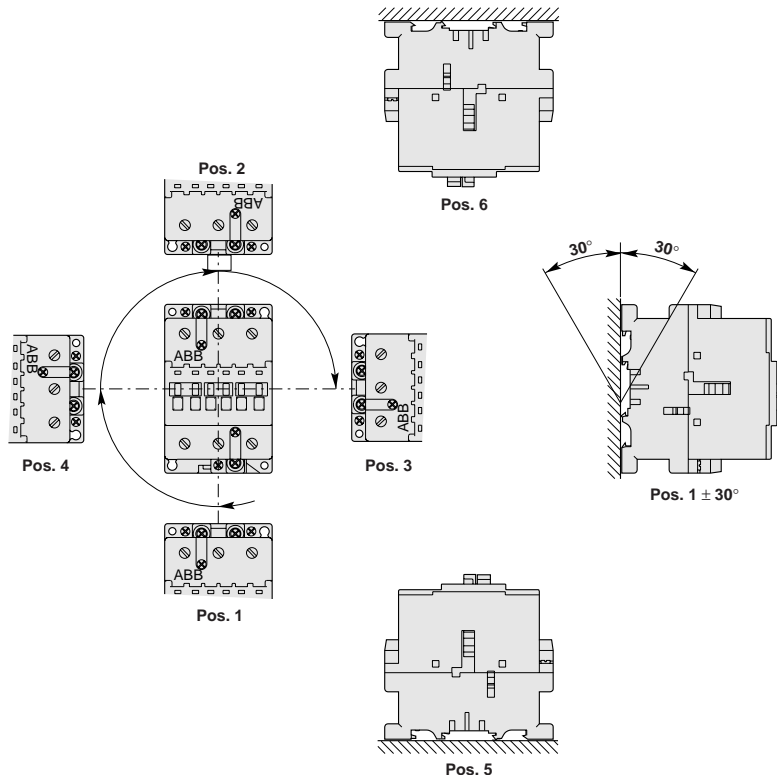

IEC Technical data for AC operated A contactors

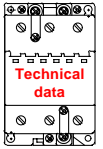

Type	A9	A12	A16	A26	A30	A40	A45	A50	A63	A75	A95	A110																																																																																																				
Number of poles	3 or 4	3	3 or 4	3 or 4	3	3	4	3 or 4	3	3 or 4	3	3																																																																																																				
Insulation characteristics																																																																																																																
Rated insulation voltage U_i acc. to IEC947-4-1 and VDE0110 (Gr. C)	V							1000																																																																																																								
according to UL/CSA	V							600																																																																																																								
Rated impulse withstand voltage U_{imp}								8 kV																																																																																																								
Main pole utilization characteristics																																																																																																																
Rated operational voltage U_e	V	690			690			1000			1000																																																																																																					
Conventional free-air thermal current I_{th} acc. to IEC947-4-1, open contactors $\theta \leq 40^\circ\text{C}$	A	26	28	30	45	65	65	100	100	125	125	145	160																																																																																																			
with conductor cross-sectional area	mm ²	4	4	4	6	16	16	35	35	50	50	50	70																																																																																																			
Rated operational current $I_e/AC-1$ for air temperature close to contactor		<table border="0"> <tr> <td rowspan="3" style="font-size: 2em; vertical-align: middle;">}</td> <td>$\theta \leq 40^\circ\text{C}$</td> <td>A</td> <td>25</td> <td>27</td> <td>30</td> <td>45</td> <td>55</td> <td>60</td> <td>70</td> <td>100</td> <td>115</td> <td>125</td> <td>145</td> <td>160</td> </tr> <tr> <td>$\theta \leq 55^\circ\text{C}$</td> <td>A</td> <td>22</td> <td>25</td> <td>27</td> <td>40</td> <td>55</td> <td>60</td> <td>60</td> <td>85</td> <td>95</td> <td>105</td> <td>135</td> <td>145</td> </tr> <tr> <td>$\theta \leq 70^\circ\text{C}$</td> <td>A</td> <td>18</td> <td>20</td> <td>21</td> <td>32</td> <td>39</td> <td>42</td> <td>50</td> <td>70</td> <td>80</td> <td>85</td> <td>115</td> <td>130</td> </tr> </table>												}	$\theta \leq 40^\circ\text{C}$	A	25	27	30	45	55	60	70	100	115	125	145	160	$\theta \leq 55^\circ\text{C}$	A	22	25	27	40	55	60	60	85	95	105	135	145	$\theta \leq 70^\circ\text{C}$	A	18	20	21	32	39	42	50	70	80	85	115	130																																																								
}	$\theta \leq 40^\circ\text{C}$	A	25	27	30	45	55	60	70	100	115	125	145		160																																																																																																	
	$\theta \leq 55^\circ\text{C}$	A	22	25	27	40	55	60	60	85	95	105	135		145																																																																																																	
	$\theta \leq 70^\circ\text{C}$	A	18	20	21	32	39	42	50	70	80	85	115	130																																																																																																		
with conductor cross sectional area	mm ²	2.5	4	4	6	10	16	25	35	50	50	50	70																																																																																																			
Utilization category AC-3 for air temperature close to contactor $\leq 55^\circ\text{C}$																																																																																																																
Rated operational current $I_e/AC-3 (1)$		<table border="0"> <tr> <td rowspan="8" style="vertical-align: middle;">3-phase Motors </td> <td>220-230-240 V</td> <td>A</td> <td>9</td> <td>12</td> <td>17</td> <td>26</td> <td>33</td> <td>40</td> <td>40</td> <td>53</td> <td>65</td> <td>75</td> <td>96</td> <td>110</td> </tr> <tr> <td>380-400 V</td> <td>A</td> <td>9</td> <td>12</td> <td>17</td> <td>26</td> <td>32</td> <td>37</td> <td>37</td> <td>50</td> <td>65</td> <td>75</td> <td>96</td> <td>110</td> </tr> <tr> <td>415 V</td> <td>A</td> <td>9</td> <td>12</td> <td>17</td> <td>26</td> <td>32</td> <td>37</td> <td>37</td> <td>50</td> <td>65</td> <td>72</td> <td>96</td> <td>110</td> </tr> <tr> <td>440 V</td> <td>A</td> <td>9</td> <td>12</td> <td>16</td> <td>26</td> <td>32</td> <td>37</td> <td>37</td> <td>45</td> <td>65</td> <td>70</td> <td>93</td> <td>100</td> </tr> <tr> <td>500 V</td> <td>A</td> <td>9</td> <td>12</td> <td>14</td> <td>22</td> <td>28</td> <td>33</td> <td>33</td> <td>45</td> <td>55</td> <td>65</td> <td>80</td> <td>100</td> </tr> <tr> <td>690 V</td> <td>A</td> <td>7</td> <td>9</td> <td>10</td> <td>17</td> <td>21</td> <td>25</td> <td>25</td> <td>35</td> <td>43</td> <td>46</td> <td>65</td> <td>82</td> </tr> <tr> <td>1000 V</td> <td>A</td> <td>—</td> <td>—</td> <td>—</td> <td>—</td> <td>—</td> <td>—</td> <td>—</td> <td>23</td> <td>25</td> <td>28</td> <td>30</td> <td>30</td> </tr> </table>												3-phase Motors 	220-230-240 V	A	9	12	17	26	33	40	40	53	65	75	96	110	380-400 V	A	9	12	17	26	32	37	37	50	65	75	96	110	415 V	A	9	12	17	26	32	37	37	50	65	72	96	110	440 V	A	9	12	16	26	32	37	37	45	65	70	93	100	500 V	A	9	12	14	22	28	33	33	45	55	65	80	100	690 V	A	7	9	10	17	21	25	25	35	43	46	65	82	1000 V	A	—	—	—	—	—	—	—	23	25	28	30	30
3-phase Motors 	220-230-240 V	A	9	12	17	26	33	40	40	53	65	75	96		110																																																																																																	
	380-400 V	A	9	12	17	26	32	37	37	50	65	75	96		110																																																																																																	
	415 V	A	9	12	17	26	32	37	37	50	65	72	96		110																																																																																																	
	440 V	A	9	12	16	26	32	37	37	45	65	70	93		100																																																																																																	
	500 V	A	9	12	14	22	28	33	33	45	55	65	80		100																																																																																																	
	690 V	A	7	9	10	17	21	25	25	35	43	46	65		82																																																																																																	
	1000 V	A	—	—	—	—	—	—	—	23	25	28	30		30																																																																																																	
	Rated operational power AC-3 (1)		<table border="0"> <tr> <td rowspan="8" style="vertical-align: middle;">3-phase Motors </td> <td>220-230-240 V</td> <td>kW</td> <td>2.2</td> <td>3</td> <td>4</td> <td>6.5</td> <td>9</td> <td>11</td> <td>11</td> <td>15</td> <td>18.5</td> <td>22</td> <td>25</td> <td>30</td> </tr> <tr> <td>380-400 V</td> <td>kW</td> <td>4</td> <td>5.5</td> <td>7.5</td> <td>11</td> <td>15</td> <td>18.5</td> <td>18.5</td> <td>22</td> <td>30</td> <td>37</td> <td>45</td> <td>55</td> </tr> <tr> <td>415 V</td> <td>kW</td> <td>4</td> <td>5.5</td> <td>9</td> <td>11</td> <td>15</td> <td>18.5</td> <td>18.5</td> <td>25</td> <td>37</td> <td>40</td> <td>55</td> <td>59</td> </tr> <tr> <td>440 V</td> <td>kW</td> <td>4</td> <td>5.5</td> <td>9</td> <td>15</td> <td>18.5</td> <td>22</td> <td>22</td> <td>25</td> <td>37</td> <td>40</td> <td>55</td> <td>59</td> </tr> <tr> <td>500 V</td> <td>kW</td> <td>5.5</td> <td>7.5</td> <td>9</td> <td>15</td> <td>18.5</td> <td>22</td> <td>22</td> <td>30</td> <td>37</td> <td>45</td> <td>55</td> <td>59</td> </tr> <tr> <td>690 V</td> <td>kW</td> <td>5.5</td> <td>7.5</td> <td>9</td> <td>15</td> <td>18.5</td> <td>22</td> <td>22</td> <td>30</td> <td>37</td> <td>40</td> <td>55</td> <td>75</td> </tr> <tr> <td>1000 V</td> <td>kW</td> <td>—</td> <td>—</td> <td>—</td> <td>—</td> <td>—</td> <td>—</td> <td>—</td> <td>30</td> <td>33</td> <td>37</td> <td>40</td> <td>40</td> </tr> </table>												3-phase Motors 	220-230-240 V	kW	2.2	3	4	6.5	9	11	11	15	18.5	22	25	30	380-400 V	kW	4	5.5	7.5	11	15	18.5	18.5	22	30	37	45	55	415 V	kW	4	5.5	9	11	15	18.5	18.5	25	37	40	55	59	440 V	kW	4	5.5	9	15	18.5	22	22	25	37	40	55	59	500 V	kW	5.5	7.5	9	15	18.5	22	22	30	37	45	55	59	690 V	kW	5.5	7.5	9	15	18.5	22	22	30	37	40	55	75	1000 V	kW	—	—	—	—	—	—	—	30	33	37	40
3-phase Motors 	220-230-240 V	kW	2.2	3	4	6.5	9	11	11	15	18.5	22	25	30																																																																																																		
	380-400 V	kW	4	5.5	7.5	11	15	18.5	18.5	22	30	37	45	55																																																																																																		
	415 V	kW	4	5.5	9	11	15	18.5	18.5	25	37	40	55	59																																																																																																		
	440 V	kW	4	5.5	9	15	18.5	22	22	25	37	40	55	59																																																																																																		
	500 V	kW	5.5	7.5	9	15	18.5	22	22	30	37	45	55	59																																																																																																		
	690 V	kW	5.5	7.5	9	15	18.5	22	22	30	37	40	55	75																																																																																																		
	1000 V	kW	—	—	—	—	—	—	—	30	33	37	40	40																																																																																																		
	Rated frequency limits	Hz	25 – 400																																																																																																													
Mechanical durability in millions of operating cycles		10										10																																																																																																				
Max. mechanical switching frequency	cycles/h	3600																																																																																																														
Max. electrical switching frequency		<table border="0"> <tr> <td>for AC-1</td> <td>cycles/h</td> <td>600</td> <td>600</td> <td>600</td> <td>600</td> <td>600</td> <td>600</td> <td>600</td> <td>600</td> <td>600</td> <td>600</td> <td>600</td> <td>300</td> <td>300</td> </tr> <tr> <td>for AC-3</td> <td>cycles/h</td> <td>1200</td> <td>1200</td> <td>1200</td> <td>1200</td> <td>1200</td> <td>1200</td> <td>600</td> <td>600</td> <td>600</td> <td>600</td> <td>600</td> <td>300</td> <td>300</td> </tr> <tr> <td>for AC-2, AC-4</td> <td>cycles/h</td> <td>300</td> <td>300</td> <td>300</td> <td>300</td> <td>300</td> <td>300</td> <td>150</td> <td>150</td> <td>150</td> <td>150</td> <td>150</td> <td>150</td> <td>150</td> </tr> </table>												for AC-1	cycles/h	600	600	600	600	600	600	600	600	600	600	600	300	300	for AC-3	cycles/h	1200	1200	1200	1200	1200	1200	600	600	600	600	600	300	300	for AC-2, AC-4	cycles/h	300	300	300	300	300	300	150	150	150	150	150	150	150																																																						
for AC-1	cycles/h	600	600	600	600	600	600	600	600	600	600	600	300	300																																																																																																		
for AC-3	cycles/h	1200	1200	1200	1200	1200	1200	600	600	600	600	600	300	300																																																																																																		
for AC-2, AC-4	cycles/h	300	300	300	300	300	300	150	150	150	150	150	150	150																																																																																																		
Electrical durability																																																																																																																
Rated making capacity AC-3 according to IEC947-4-1		10 x I_e AC-3										12 x I_e AC-3																																																																																																				
Rated breaking capacity AC-3 according to IEC947-4-1		8 x I_e AC-3										8 x I_e AC-3																																																																																																				
Max. breaking capacity $\cos \varphi = 0.45$	at 440 V	A	250	250	250	420	820	820	900	900	900	900	1160	1160																																																																																																		
($\cos \varphi = 0.35$ for $I_e > 100$ A)	at 690 V	A	100	100	100	170	340	340	490	490	490	490	800	800																																																																																																		
Short-circuit protection for contactors without thermal O/L relays - Motor protection excluded^①																																																																																																																
$U_e \leq 500$ V a.c. – gG (gl) type fuses	A	25	32	32	50	63	63	80	100	125	160	160	200																																																																																																			
Rated short-time withstand current I_{sw}		<table border="0"> <tr> <td>1 s</td> <td>A</td> <td>250</td> <td>280</td> <td>300</td> <td>400</td> <td>600</td> <td>600</td> <td>1000</td> <td>1000</td> <td>1000</td> <td>1000</td> <td>1320</td> <td>1320</td> </tr> <tr> <td>10 s</td> <td>A</td> <td>100</td> <td>120</td> <td>140</td> <td>210</td> <td>400</td> <td>400</td> <td>650</td> <td>650</td> <td>650</td> <td>650</td> <td>800</td> <td>800</td> </tr> <tr> <td>30 s</td> <td>A</td> <td>60</td> <td>70</td> <td>80</td> <td>110</td> <td>225</td> <td>225</td> <td>370</td> <td>370</td> <td>370</td> <td>370</td> <td>500</td> <td>500</td> </tr> <tr> <td>1 min</td> <td>A</td> <td>50</td> <td>55</td> <td>60</td> <td>90</td> <td>150</td> <td>150</td> <td>250</td> <td>250</td> <td>250</td> <td>250</td> <td>350</td> <td>350</td> </tr> <tr> <td>15 min</td> <td>A</td> <td>26</td> <td>28</td> <td>30</td> <td>45</td> <td>65</td> <td>65</td> <td>100</td> <td>100</td> <td>100</td> <td>100</td> <td>160</td> <td>175</td> </tr> </table>												1 s	A	250	280	300	400	600	600	1000	1000	1000	1000	1320	1320	10 s	A	100	120	140	210	400	400	650	650	650	650	800	800	30 s	A	60	70	80	110	225	225	370	370	370	370	500	500	1 min	A	50	55	60	90	150	150	250	250	250	250	350	350	15 min	A	26	28	30	45	65	65	100	100	100	100	160	175																													
1 s	A	250	280	300	400	600	600	1000	1000	1000	1000	1320	1320																																																																																																			
10 s	A	100	120	140	210	400	400	650	650	650	650	800	800																																																																																																			
30 s	A	60	70	80	110	225	225	370	370	370	370	500	500																																																																																																			
1 min	A	50	55	60	90	150	150	250	250	250	250	350	350																																																																																																			
15 min	A	26	28	30	45	65	65	100	100	100	100	160	175																																																																																																			
Heat dissipation per pole		<table border="0"> <tr> <td>$I_e/AC-1$</td> <td>W</td> <td>0.8</td> <td>1</td> <td>1.2</td> <td>1.8</td> <td>2.5</td> <td>3</td> <td>2.5</td> <td>5</td> <td>6.5</td> <td>7</td> <td>6.5</td> <td>7.5</td> </tr> <tr> <td>$I_e/AC-3$</td> <td>W</td> <td>0.1</td> <td>0.2</td> <td>0.35</td> <td>0.6</td> <td>0.9</td> <td>1.3</td> <td>0.65</td> <td>1.3</td> <td>1.5</td> <td>2</td> <td>2.7</td> <td>3.6</td> </tr> </table>												$I_e/AC-1$	W	0.8	1	1.2	1.8	2.5	3	2.5	5	6.5	7	6.5	7.5	$I_e/AC-3$	W	0.1	0.2	0.35	0.6	0.9	1.3	0.65	1.3	1.5	2	2.7	3.6																																																																							
$I_e/AC-1$	W	0.8	1	1.2	1.8	2.5	3	2.5	5	6.5	7	6.5	7.5																																																																																																			
$I_e/AC-3$	W	0.1	0.2	0.35	0.6	0.9	1.3	0.65	1.3	1.5	2	2.7	3.6																																																																																																			

Contactors

AC 1030 – 6/98

① Please consult us for the protection of motor starters against short circuits.

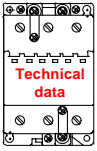

IEC Technical data for AC operated A contactors

Type	A9	A12	A16	A26	A30	A40	A45	A50	A63	A75	A95	A110
Number of poles	3 or 4	3	3 or 4	3 or 4	3	3	4	3 or 4	3	3 or 4	3	3

General technical data

Standards	Devices complying with international standards IEC947-1 / 947-4-1 and European standards EN60 947-1 / 60 947-4-1 Electromagnetic compatibility (EMC) according to amendment A11 to IEC947-1; EN60 947-1 and amendment 2 to IEC947-4-1
-----------	------------------------------------------------------------------------------------------------------------------------------------------------------------------------------------------------------------------------------------------

Certifications – approvals	See page V
----------------------------	------------

Air temperature close to contactor			
— fitted with thermal O/L relay	°C	— 25 to + 55 (0.85 – 1.1 U _e)	— 25 to +55 (0.85 – 1.1U _e)
— without thermal O/L relay	°C	— 40 to + 55 (0.85 – 1.1 U _e) / – 40 to + 70 (U _e)	— 25 to +70 (0.85 – 1.1U _e)
— for storage	°C	— 60 to + 80	— 40 to +70

Climatic withstand	acc. to IEC 68-2-30 and 68-2-11 – UTE C 63-100 specification II	acc. to IEC 68-2-30
--------------------	-----------------------------------------------------------------	---------------------

Mounting positions: (see diagram, page 1.20)	Positions 1 to 5	— Ambient temperature ≤ 55°C and control voltage 0.85 – 1.1 U _e — Ambient temperature 55 – 70°C and control voltage equal to U _e
	Position 6	— Ambient temperature ≤ 55°C and control voltage 0.95 – 1.1 U _e — Ambient temperature > 55°C unauthorized

Operating altitude	m	≤ 3000
--------------------	---	--------

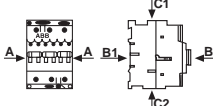
Shock withstand acc. to IEC68-2-27 and EN60068-2-27 Mounting position 1 (See page 1.20)		1/2 sinusoidal shock for 11ms: no change in contact position Shock direction: A, C1, C2 : 20 g B1 : 5 g B2 : 15 g
		Note: only on plate for A95 and A110

Mounting	• on mounting rail	acc. to IEC715 and EN50 022 35 x 7.5 mm 35 x 15 mm	acc. to IEC715 35 x 15 EN50 022 75 x 25 EN50 023	acc. to IEC715 and EN50 023 75 x 25
	• by screws (not supplied)	2 x M4	2 x M6	

Connecting terminals (delivered in open position)	— Main poles	(+,-) pozidriv 2screw			M 8 slotted screw head with single connector 13 x 10 mm	HC, M 8 hexagon socket screw with single connector 14 x 14 mm
		M 3.5 with cable clamp	M 4 with clamp	M 5 with 2x(5.6x6.5mm) double connect.		
	— Coil terminals	M 3.5 (+,-) pozidriv 2 screws with cable clamp				
	— Built in aux. terminals	(+,-) pozidriv 2 screw and cable clamp				
		M 3.5	M 4	M 3.5		

Connecting capacity						
Main conductors (poles)		min. – max.	min.– max.	min. – max.	min. – max.	min. – max.
Rigid solid (≤4 mm ²) / rigid stranded (≥6 mm ²)	1 x mm ² 2 x mm ²	1 – 4 1 – 4	1.5 – 6 1.5 – 6	2.5 – 16 2.5 – 16	6 – 50 6 – 25	6 – 95 6 – 35
Flexible without cable end	1 x mm ² 2 x mm ²	0.75 – 2.5 0.75 – 2.5	1 – 4 1 – 4	2.5 – 10 2.5 – 10	6 – 35 6 – 16	6 – 70 6 – 35
Bars or lugs:	max. width hole Ø	mm ≤ mm >	8 3.7	10 4.2	— —	30 6

Auxiliary conductors (built in aux. terminals + coil terminals)		min. - max.				
Rigid solid	1 or 2 x mm ²	1 - 4				0.75 – 2.5
Flexible without cable end	1 x mm ² 2 x mm ²	0.75 – 2.5 0.75 – 2.5	⊙ ⊙	0.75 – 2.5 0.75 – 2.5	1 – 2.5 0.75 – 2.5	0.75 – 2.5 0.75 – 2.5

Degree of protection acc. to IEC529, IEC947-1 and EN60529	— Main terminals	Protection against direct contact acc. to VDE0106 — Part. 100	
	— Coil terminals	IP20	IP10
	— Auxiliary terminals		IP20 IP20

⊙ 1 or 2 times 0.75 – 2.5mm² but with 0.75 and 1 mm² cable end.

IEC Technical data for AC operated A contactors

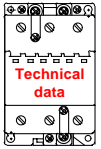

Magnet system characteristics

Type	A9	A12	A16	A26	A30	A40	A45	A50	A63	A75	A95	A110
Number of poles	3 or 4	3	3 or 4	3 or 4	3	3	4	3 or 4	3	3 or 4	3	3
Coil operating limits acc. to IEC947-4-1: $0.85 - 1.1 \times U_c$	$\theta \leq 55^\circ\text{C}$										$\theta \leq 70^\circ\text{C}$	
Drop out voltage in % of U_c	roughly 40 – 65 %											
Coil consumption												
Average pull in value	— 50 Hz — 60 Hz	VA VA	70 80		120 140			180 210				350 450
Average holding value	— 50/60 Hz ^① — 50 Hz — 60 Hz — 50/60 Hz ^①	VA/VA VA/W VA/W VA/W	74/70 8/2 8/2 8/2		125/120 12/3 12/3 12/3			190/180 18/5.5 18/5.5 18/5.5				410 / 365 22 / 6.5 26 / 8 27 / 7.5
Rated control circuit voltage U_c												
	at 50 Hz at 60 Hz	V V						20 – 690 24 – 600				
Operating time												
	Between coil energization and: — N.O. contact closing — N.C. contact opening	ms ms	10 – 26 7 – 21		8 – 21 6 – 18			8 – 27 7 – 22				10 – 25 7 – 22
	Between coil deenergization and: — N.O. contact opening — N.C. contact closing	ms ms	4 – 11 9 – 16		4 – 11 7 – 14			4 – 11 7 – 14				7 – 15 10 – 18

Characteristics of A9 – A40 contactor built in auxiliary contacts (for additional auxiliary contact blocks: see page 1.17)

Rated operational voltage U_e	V	690		
Conventional free air thermal current $I_{th} - \theta \leq 40^\circ\text{C}$	16			
Rated operational current	24 – 127 V 220 – 240 V 380 – 440 V 500 V 690 V	50/60 Hz 50/60 Hz 50/60 Hz 50/60 Hz 50/60 Hz	A A A A A	6 4 3 2 2
I_e / AC-15 acc. to IEC947-5-1				
I_e / DC-13 acc. to IEC947-5-1	24 V 48 V 72 V 125 V 250 V	d.c. d.c. d.c. d.c. d.c.	A/W A/W A/W A/W A/W	6 / 144 2.8 / 134 2 / 144 1.1 / 138 0.55 / 138
Operational current frequency	Hz	25 – 400		
Rated making capacity	acc. to IEC 947-5-1	10 x I_e / AC-15		
Rated breaking capacity	acc. to IEC 947-5-1	10 x I_e / AC-15		
Short circuit protection – gG (gl) type fuses	A	10		
Rated short time withstand current I_{ew}	for 1.0 s for 0.1 s	100A 140A		
Insulating resistance at 500 V d.c.		after durability test: 5M Ω		
Min. switching capacity		17V/ 5 mA		
Non overlapping time between N.O. and N.C. contacts	ms	≥ 2		
Heat dissipation per pole at 6 A	W	0.10		

Electrical durability
Max. switching frequency 1200 cycles/h
 AC-15 according to IEC947-5-1
 making current: $10 \times I_e$ with $\cos \varphi = 0.7$ and U_e
 breaking current: I_e with $\cos \varphi = 0.4$ and U_e

The curve opposite shows the electrical durability of the built in auxiliary contacts with respect to the breaking current.

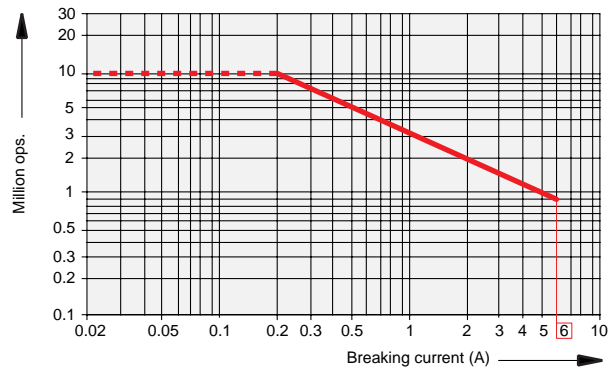

This curve has been drawn for resistive and inductive loads up to 690 V, 40 - 60 Hz.

① 50/60 Hz coils: voltage codes 80 to 88, see page 1.13.

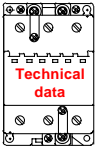

IEC Technical data for DC operated A contactors

Contactors

Type		BC9	BC16	BC25	BC30	AE45	AE50	AE63	AE75	AE95	AE110	
Number of poles		3 or 4	3 or 4	3 or 4	3	4	3 or 4	3	3 or 4	3	3	
Insulation characteristics												
Rated insulation voltage U_i according to IEC947-4-1 and VDE0110 (Gr. C) according to UL/CSA	V	690			1000		1000			1000		
	V	600			600		600			600		
Rated impulse withstand voltage U_{imp}		6 kV				8 kV				8 kV		
Main pole utilization characteristics												
Rated operational voltage U_e	V	690			690		1000			1000		
Conventional free air thermal current I_{th} acc. to IEC947-4-1, open contactors $\theta \leq 40^\circ\text{C}$	A	26	28	45	65	100	100	125	125	145	160	
	with conductor cross sectional area mm ²	4	4	6	10	35	35	50	50	50	70	
Rated operational current $I_e/AC-1$ for air temperature close to contactor	$\left\{ \begin{array}{l} \theta \leq 40^\circ\text{C} \\ \theta \leq 55^\circ\text{C} \\ \theta \leq 70^\circ\text{C} \end{array} \right.$	A	22	28	45	55	70	100	115	125	145	160
		A	20	25	40	45	60	85	95	105	135	145
		A	17	23	32	36	50	70	80	85	115	130
		with conductor cross sectional area mm ²	2.5	4	6	6	25	35	50	50	50	70
Utilization category AC-3 for air temperature close to contactor $\leq 55^\circ\text{C}$												
Rated operational current $I_e/AC-3 (1)$ 3 phase motors	220 – 230 – 240 V	A	9	16	25	33 ^①	40	53	65	75	96	110
	380 – 400 V	A	9	16	25	30	37	50	65	75	96	110
	415 V	A	9	16	25	30	37	50	65	72	96	110
	440 V	A	9	16	20	27	37	45	65	70	93	100
	500 V	A	7	13	17	23	33	45	55	65	80	100
	690 V	A	6	8	13	18	25	35	43	46	65	82
	1000 V	A	—	—	—	—	—	23	25	28	30	30
Rated operational power AC-3 (1) 1500 r.p.m. – 50 Hz or 1800 r.p.m. – 60 Hz 3 phase motors	220 – 230 – 240 V	kW	2.2	4	6.5 ^②	9	11	15	18.5	22	25	30
	380-400 V	kW	4	7.5	11	15	18.5	22	30	37	45	55
	415 V	kW	4	7.5	11	15	18.5	25	37	40	55	59
	440 V	kW	4	7.5	11	15	22	25	37	40	55	59
	500 V	kW	4	7.5	11	15	22	30	37	45	55	59
	690 V	kW	4	5.5	11	15	22	30	37	40	55	75
	1000 V	kW	—	—	—	—	—	30	33	37	40	40
Rated frequency limits	Hz	25 – 400										
Mechanical durability in millions of operating cycles		10			10			10			10	
	Max. mechanical switching frequency cycles/h	6000			3000			3600			3600	
Max. electrical switching frequency	for AC-1	cycles/h			600			300			300	
	for AC-3	cycles/h			1200			300			300	
	for AC-2, AC-4	cycles/h			300			150			150	
Electrical durability see page 1.27 – 1.30												
Rated making capacity AC-3 according to IEC947-4-1		10 x I_e / AC-3									12 x I_e / AC-3	
Rated breaking capacity AC-3 according to IEC947-4-1		8 x I_e / AC-3									8 x I_e / AC-3	
Max. breaking capacity with $\cos \phi = 0.45$ ($\cos \phi = 0.35$ for $I_e > 100$ A)	at 440V	A	200			315		380			900	
	at 690V	A	120			210		290		490		
Short-circuit protection for contactors without thermal O/L relay – Motor protection excluded ^③												
$U_e \leq 500$ V a.c. – gG (gl) type fuses	A	25	32/35	50	63	80	100	125	160	160	200	
Rated short-time withstand current I_{sw} at 40°C ambient temperature, in free air, from cold state	1 s	A	200	280	350	400	1000	1000	1000	1000	1320	1320
	10 s	A	90	130	200	250	650	650	650	650	800	800
	30 s	A	50	70	110	150	370	370	370	370	500	500
	1 min	A	40	50	90	120	250	250	250	250	350	350
	15 min	A	22	28	45	55	100	100	115	125	160	175
Heat dissipation per pole	$I_e/AC-1$	W	0.55	1.5	2.4	2.2	2.5	5	6.5	7	6.5	7.5
	$I_e/AC-3$	W	0.10	0.4	0.6	0.6	0.65	1.3	1.5	2	2.7	3.6

① 32 A at 240V

② 7.5 kW at 240V

③ For the protection of motor starters against short circuits, please consult us.

IEC Technical data for DC operated A contactors

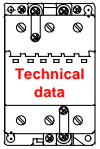

Type	BC9	BC16	BC25	BC30	AE45	AE50	AE63	AE75	AE95	AE110
Number of poles	3 or 4	3 or 4	3 or 4	3	4	3 or 4	3	3 or 4	3	3
General technical data										
Standards	Devices complying with international standards IEC947-1 / 947-4-1 and European standards EN60 947-1 / 60 947-4-1 Electromagnetic compatibility (EMC) according to amendment A11 to IEC947-1; EN60 947-1 and amendment 2 to IEC947-4-1									
Certifications – approvals	See pg V									
Air temperature close to contactor	°C		-25 to +50 (0.85 to 1.1 U _e)			-25 to +50 (0.85 to 1.1 U _e)			-25 to +55 (0.85 to 1.1U _e)	
– with a thermal O/L relay mounted	°C		-40 to +55 (0.85 to 1.1 U _e) / +55 to +70 (U _e)			-40 to +55 (0.85 to 1.1 U _e) / +55 to +70 (U _e)			-25 to +70 (0.85 to 1.1U _e)	
– without thermal O/L relay mounted	°C		-60 to +80			-60 to +80			-40 to +70	
– for storage										
Climatic withstand	according to IEC 68-2-30 and 68-2-11 – UTE C 63-100 specification II									
Mounting positions: (see drawing page 1.20)	Positions 1,3,4	-θ ≤ 55 °C: 0.85 to 1.1 U _e -θ = 55 to 70 °C: — U _e				Positions 1 to 5	-θ ≤ 55 °C: 0.85 to 1.1 U _e -θ = 55 to 70 °C: — U _e			
	Positions 2,6	-θ ≤ 55 °C: 0.95 to 1.1 U _e -θ > 55 °C: not acceptable				Position 6	-θ ≤ 55 °C: 0.95 to 1.1 U _e -θ > 55 °C: not acceptable			
	Position 5:	see tables p. 1.19								
Operating altitude	m	≤ 3000								
Shock withstand acc. to IEC68-2-27 and EN60068-2-27 Mounting position 1 (See page 1.20)	1/2 sinusoidal shock for 11ms: no change in contact position									
	Shock direction: A, C1, C2: 20 g B1 : 5 g B2 : 15 g									
	Note: only on plate for A95 and A110									
Mounting	• on mounting rail	according to IEC715 and EN50 022 35 x 7.5 mm 35 x 15 mm			according to IEC715 35 x 15 EN50 022 75 x 25 EN50 023			acc. to IEC715 and EN 50 023 75 x 25		
	• by screws (not supplied)	2 x M 4			2 x M 6					
Connecting terminals (delivered in open position)	– Main poles	(+, -) pozidriv 2 screw with cable clamp			M8 slotted screw head with single connector 13 x 10 mm			HC, M8, hexagon socket screw with single connector 14 x 14 mm		
	– Coil terminals	M 3.5 (+, -) pozidriv 2 screw with cable clamp								
	– Built in aux. terminals	(+, -) pozidriv 2 screw with cable clamp								
		M 3.5			M 4					
Connecting capacity										
Main conductors (poles)		min. – max.	min. – max.	min. – max.	min. – max.			min. – max.		
Rigid solid (≤ 4 mm ²) / rigid stranded (≥ 6 mm ²)	1 x mm ² 2 x mm ²	1 – 4 1 – 4	1.5 – 6 1.5 – 6	2.5 – 10 2.5 – 10	6 – 50 6 – 25			6 – 95 6 – 35		
Flexible without cable end	1 x mm ² 2 x mm ²	1 – 2.5 0.75 – 2.5	1.5 – 4 1.5 – 4	2.5 – 6 2.5 – 6	6 – 35 6 – 16			6 – 70 6 – 35		
Bars or lugs:	max. width hole Ø	mm ≤ mm >	8 3.7	10 4	13 5			— 30 — 6		
Auxiliary conductors (built in auxiliary terminals + coil terminals)		min. – max.							min. – max.	
Rigid solid	1 or 2 x mm ²	1 – 4							0.75 – 2.5	
Flexible without cable end ^①	1 x mm ² 2 x mm ²	1 – 2.5 0.75 – 2.5							min. – max. 0.75 – 2.5	
Degree of protection acc. to IEC529, IEC947-1 and EN60529	Protection against direct contact according to VDE 0106 – Part. 100									
– Main terminals	IP10			IP10				IP10		
– Coil terminals	IP20			IP20				IP20		
– Auxiliary terminals	IP10			IP10				IP20		

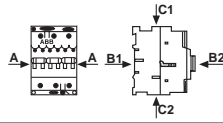

Contactors

① Except auxiliary built into BC 25: 0.75 – 4 mm²

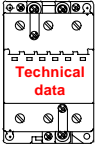

IEC Technical data for DC operated A contactors

Magnet system characteristics

Type		BC9	BC16	BC25	BC30	AE45	AE50	AE63	AE75	AE95	AE110			
Number of poles		3 or 4	3 or 4	3 or 4	3	4	3 or 4	3	3 or 4	3	3			
Coil operating limits acc. to IEC947-4-1: 0.85 to $1.1 \times U_c$		$\theta \leq 55^\circ\text{C}$								$\theta \leq 70^\circ\text{C}$				
Drop out voltage % of U_c		roughly 15 – 40 %												
Coil consumption (average value)	— pull in, from cold state	W				200				400				
	— holding, from warm state	W				4				2.4				
Rated control circuit voltage U_c	V	6 – 250				12 – 250				12 – 250				
Operating time	Between coil energization and:	— N.O. contact closing	ms				50 – 75				13 – 30		15 – 25	
		— N.C. contact opening	ms				45 – 70				10 – 27		12 – 22	
	Between coil de-energization and:	— N.O. contact opening	ms				15 – 30*				5 – 15*		15 – 20*	
		— N.C. contact closing	ms				17 – 32*				8 – 18*		18 – 23*	
*The use of surge suppressors increases the opening time on a scale of 1.1 to 1.5 for a varistor suppressor and on a scale of 4 to 8 for a diode suppressor.														

Characteristics of BC9 – BC25 contactor built in auxiliary contacts

Rated operational voltage U_e	V			690	
Conventional free air thermal current I_{th}	A			10	
Rated operational current I_e /AC-15 acc. to IEC947-5-1	24 – 127 V	50/60 Hz	A	6	
	220 – 240 V	50/60 Hz	A	4	
	380 – 440 V	50/60 Hz	A	3	
	500 V	50/60 Hz	A	2	
	690 V	50/60 Hz	A	2	
I_e /DC-13 acc. to IEC947-5-1	24 V	d.c.	A/W	6 / 144	
	48 V	d.c.	A/W	2.8 / 134	
	72 V	d.c.	A/W	2 / 144	
	125 V	d.c.	A/W	1.1 / 138	
	250 V	d.c.	A/W	0.55 / 138	
Operational current frequency	Hz			25 – 400	
Rated making capacity		acc. to IEC947-5-1		10 x I_e /AC – 15	
Rated breaking capacity		acc. to IEC947-5-1		10 x I_e /AC – 15	
Short circuit protection – gG (gl) type fuses	A			10	
Rated short time withstand current I_{cw}		for 1.0 s		50 A	
		for 0.1 s		100 A	
Insulation resistance at 500 V d.c.				after durability test: 5 M Ω	
Min. switching capacity				24V / 5 mA	
Non overlapping time between N.O. and N.C. contacts	ms			≥ 2	
Heat dissipation per pole at 6 A	W			0.15	

Electrical durability
Max. switching frequency 1200 cycles/h
 AC-15 according to IEC947-5-1
 making current: $10 \times I_e$ with $\cos \varphi = 0.7$ and U_e
 breaking current: I_e with $\cos \varphi = 0.4$ and U_e

The curve opposite shows the electrical durability of the built in auxiliary contacts with respect to the breaking current.

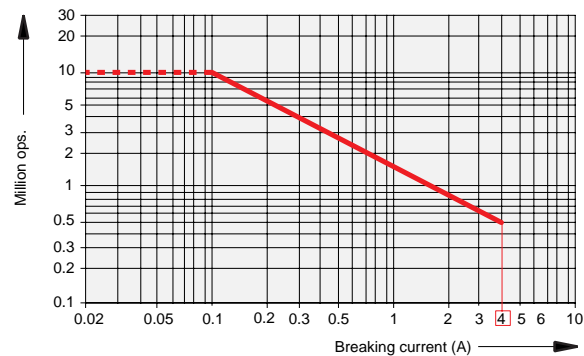

This curve has been drawn for resistive and inductive loads up to 690 V, 40 – 60 Hz.

Contactors utilization categories & electrical durability

AC-1

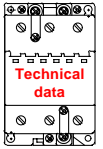

Electrical durability for AC-1 utilization category, ambient temperature $\leq 55^{\circ}\text{C}$

Switching non-inductive or slightly inductive loads. The breaking current I_b for AC-1 is equal to the rated operational current of the load.

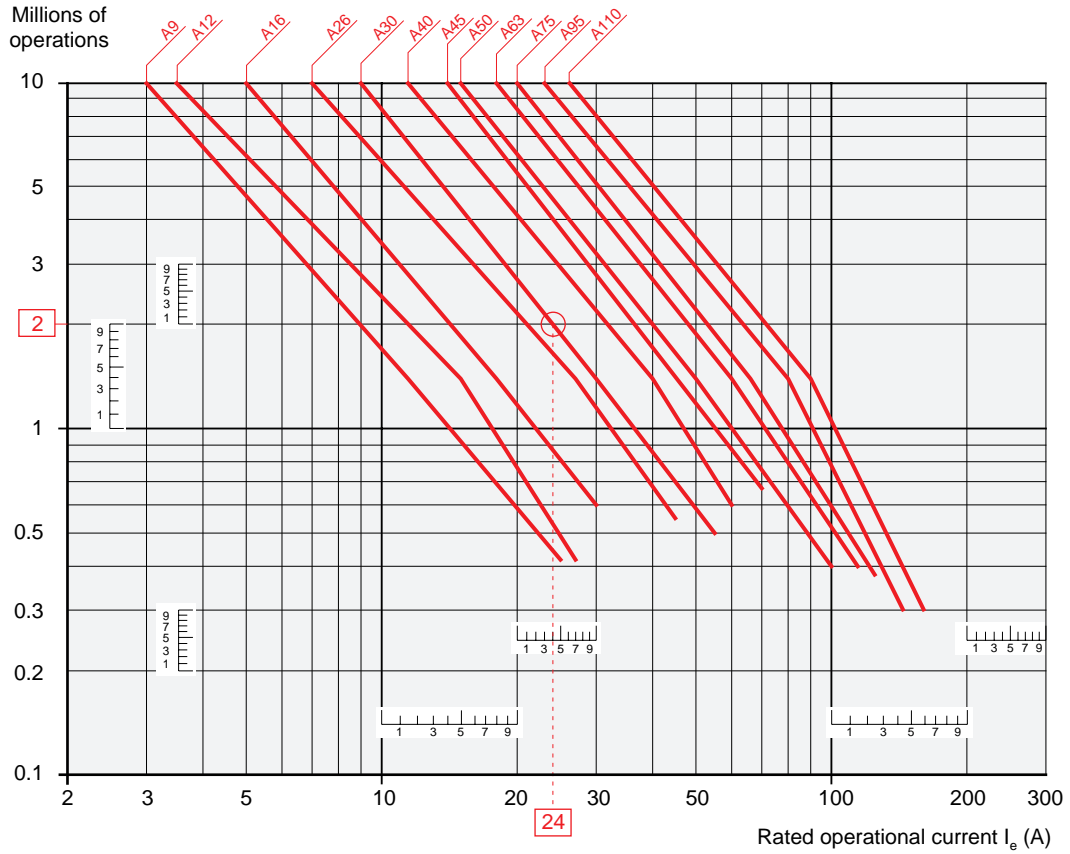

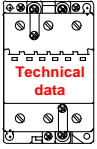

Contactor utilization categories & electrical durability

AC-3

Electrical durability for utilization category AC-3 - $U_e \leq 440V$

Switching cage motors; starting and switching off running motors. The breaking current I_b for AC-3 is equal to the rated operational current I_e , (I_e = motor full load current)

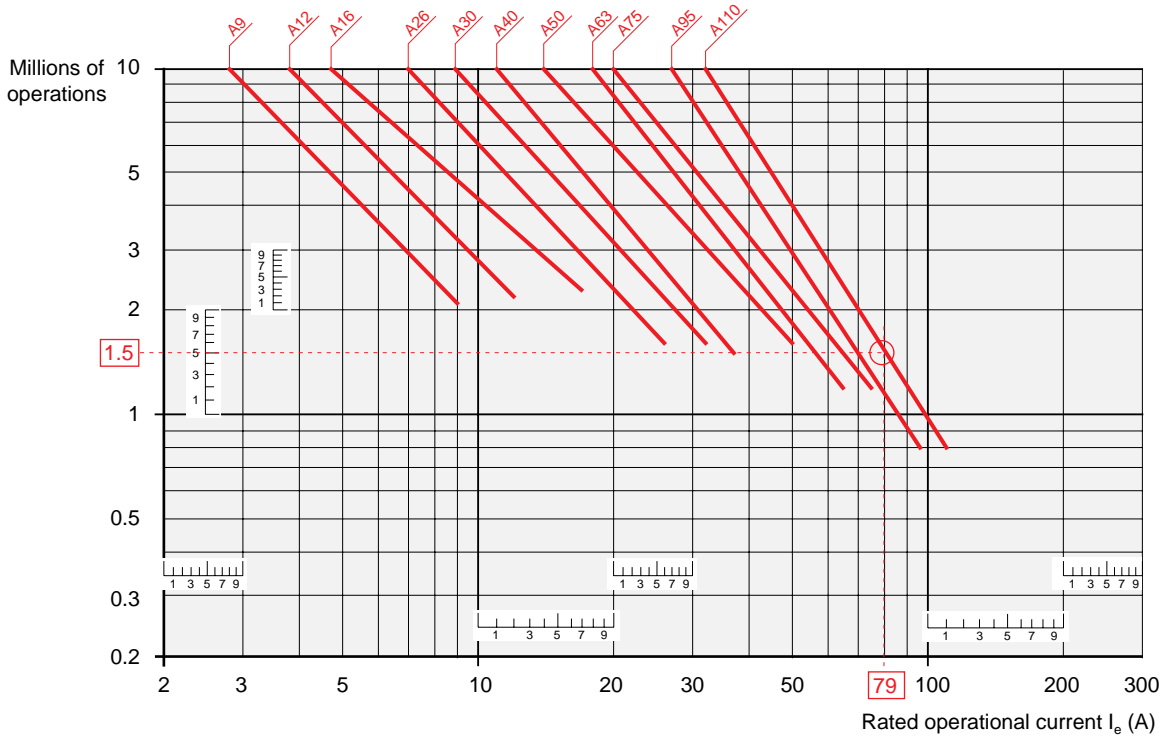

Electrical durability for utilization category AC-3 - $440V < U_e \leq 690V$

Switching cage motors; starting and switching off running motors. The breaking current I_b for AC-3 is equal to the rated operational current I_e , (I_e = motor full load current)

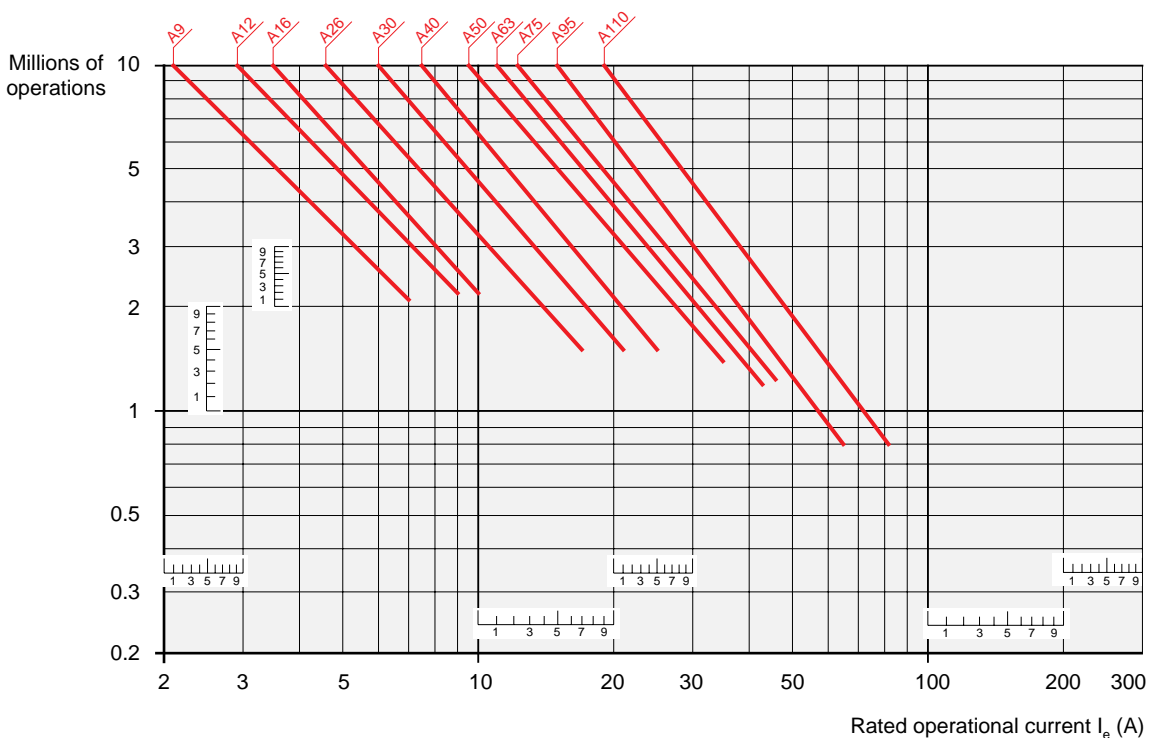

Contactor utilization categories & electrical durability AC-4

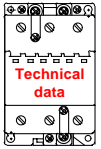

Electrical durability for utilization category AC-4 - $U_e \leq 440V$

Maximum number of AC-4 operations: 300 per hour for A9 - A110 contactors

Switching cage motors; starting, reverse operation and step-by-step operation. The breaking current I_b is equal to $6 \times I_e$, where I_e is the motor rated operational current (I_e = motor full load current)

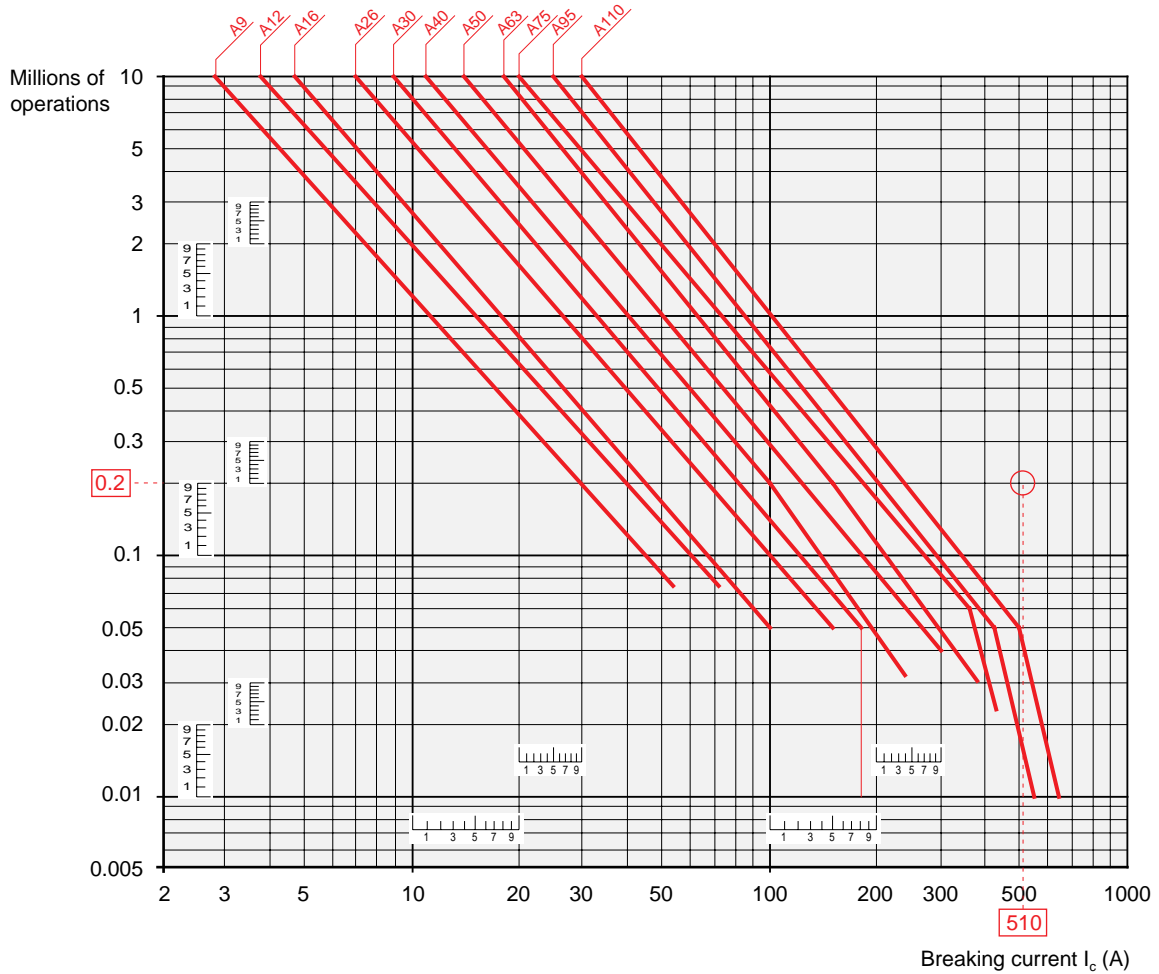

Contactors

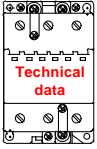

Contactor utilization categories & electrical durability

AC-4

Electrical durability for utilization category AC-4 - $440V < U_e \leq 690V$

Maximum number of AC-4 operations: 300 per hour for A9 - A110 contactors

Switching cage motors; starting, reverse operation and step-by-step operation. The breaking current I_b is equal to $6 \times I_e$, where I_e is the motor rated operational current (I_e = motor full load current)

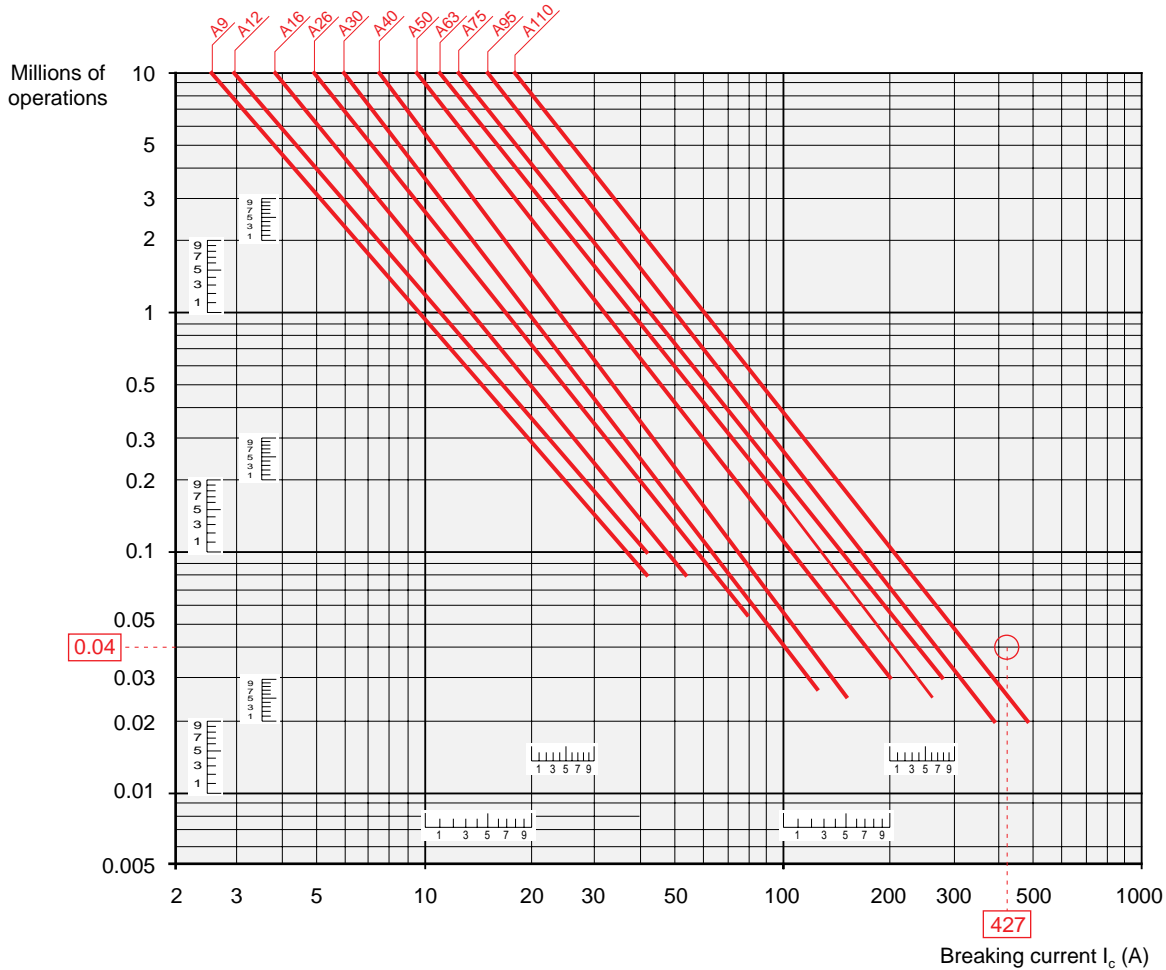

Contactors

Motor data

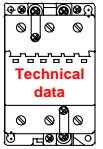

Ampere ratings of 3 phase, AC induction motors^①

Horse power	110 – 120V			220 – 240V			380 – 415V ^②		440 – 480V			550 – 600V		
	Single phase	Two phase	Three phase	Single phase	Two phase	Three phase	Single phase	Three phase	Single phase	Two phase	Three phase	Single phase	Two phase	Three phase
1/10	3.0	—	—	1.5	—	—	1.0	—	—	—	—	—	—	—
1/8	3.8	—	—	1.9	—	—	1.2	—	—	—	—	—	—	—
1/6	4.4	—	—	2.2	—	—	1.4	—	—	—	—	—	—	—
1/4	5.8	—	—	2.9	—	—	1.8	—	—	—	—	—	—	—
1/3	7.2	—	—	3.6	—	—	2.3	—	—	—	—	—	—	—
1/2	9.8	4.0	4.4	4.9	2.0	2.2	3.2	1.3	2.5	1.0	1.1	2.0	0.8	0.9
3/4	13.8	4.8	6.4	6.9	2.4	3.2	4.5	1.8	3.5	1.2	1.6	2.8	1.0	1.3
1	16.0	6.4	8.4	8.0	3.2	4.2	5.1	2.3	4.0	1.6	2.1	3.2	1.3	1.7
1 1/2	20.0	9.0	12.0	10.0	4.5	6.0	6.4	3.3	5.0	2.3	3.0	4.0	1.8	2.4
2	24.0	11.8	13.6	12.0	5.9	6.8	7.7	4.3	6.0	3.0	3.4	4.8	2.4	2.7
3	34.0	16.6	19.2	17.0	8.3	9.6	10.9	6.1	8.5	4.2	4.8	6.8	3.3	3.9
5	56.0	26.4	30.4	28.0	13.2	15.2	17.9	9.7	14.0	6.6	7.6	11.2	5.3	6.1
7 1/2	80.0	38.0	44.0	40.0	19.0	22.0	27.0	14.0	21.0	9.0	11.0	16.0	8.0	9.0
10	100.0	48.0	56.0	50.0	24.0	28.0	33.0	18.0	26.0	12.0	14.0	20.0	10.0	11.0
15	135.0	72.0	84.0	68.0	36.0	42.0	44.0	27.0	34.0	18.0	21.0	27.0	14.0	17.0
20	—	94.0	108.0	88.0	47.0	54.0	56.0	34.0	44.0	23.0	27.0	35.0	19.0	22.0
25	—	118.0	136.0	110.0	59.0	68.0	70.0	44.0	55.0	29.0	34.0	44.0	24.0	27.0
30	—	138.0	160.0	136.0	69.0	80.0	87.0	51.0	68.0	35.0	40.0	54.0	28.0	32.0
40	—	180.0	208.0	176.0	90.0	104.0	112.0	66.0	88.0	45.0	52.0	70.0	36.0	41.0
50	—	226.0	260.0	216.0	113.0	130.0	139.0	83.0	108.0	56.0	65.0	86.0	45.0	52.0
60	—	—	—	—	133.0	154.0	—	103.0	—	67.0	77.0	—	53.0	62.0
75	—	—	—	—	166.0	192.0	—	128.0	—	83.0	96.0	—	66.0	77.0
100	—	—	—	—	218.0	248.0	—	165.0	—	109.0	124.0	—	87.0	99.0
125	—	—	—	—	—	312.0	—	208.0	—	135.0	156.0	—	108.0	125.0
150	—	—	—	—	—	360.0	—	240.0	—	156.0	180.0	—	125.0	144.0
200	—	—	—	—	—	480.0	—	320.0	—	208.0	240.0	—	167.0	192.0
250	—	—	—	—	—	602.0	—	403.0	—	—	302.0	—	—	242.0
300	—	—	—	—	—	—	—	482.0	—	—	361.0	—	—	289.0
350	—	—	—	—	—	—	—	560.0	—	—	414.0	—	—	336.0
400	—	—	—	—	—	—	—	636.0	—	—	477.0	—	—	382.0
500	—	—	—	—	—	—	—	786.0	—	—	590.0	—	—	472.0

Contactors

AC 1030 – 6/98

^① To obtain full load currents for 200V and 208V motors, increase corresponding 220 – 240V ratings by 15 percent and 10 percent.
^② To obtain full load currents for 265V and 277V motors, decrease corresponding 220 – 240V ratings by 13 percent and 17 percent.

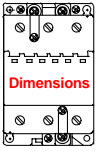

Approximate dimensions for 3 pole, AC operated A contactors & starters A9 – A16

← 00.00 → Inches
00.00 → Millimeters

A9 – A16 — Contactor, 3 pole, AC operated

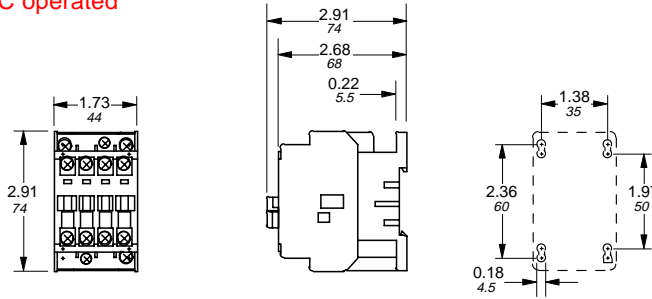

A9 – A16 + VM5 or VE5 — Mechanically interlocked contactor, 3 pole, AC operated

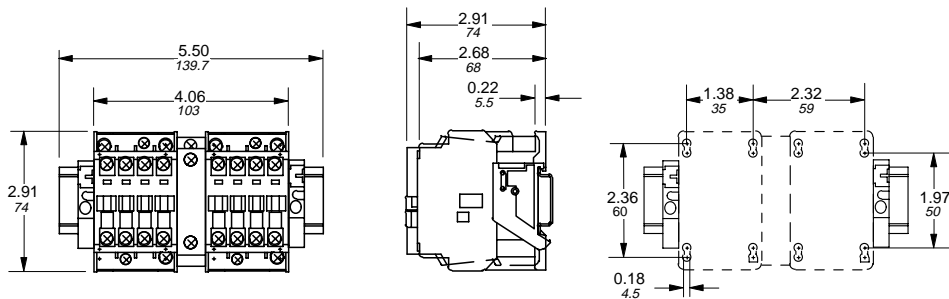

A9 – A16 + TA25 — Starter, 3 pole, AC operated

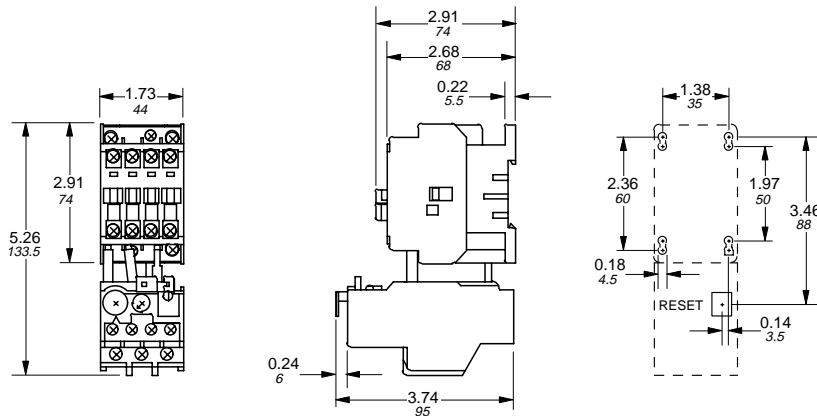

A9 – 16 + VM5 or VE5 + TA25 — Reversing starter, 3 pole, AC operated

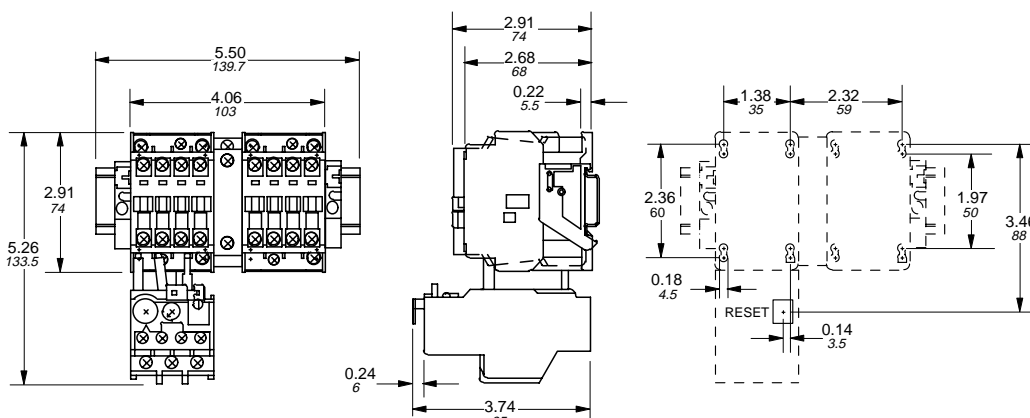

Approximate dimensions for 3 pole, AC operated A contactors & starters A26

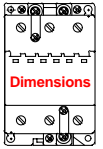

00.00 Inches
00.00 Millimeters

A26 — Contactor, 3 pole, AC operated

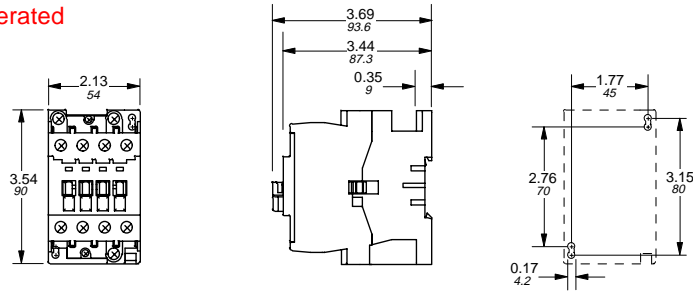

A26 + VM5 or VE5 — Mechanically interlocked contactor, 3 pole, AC operated

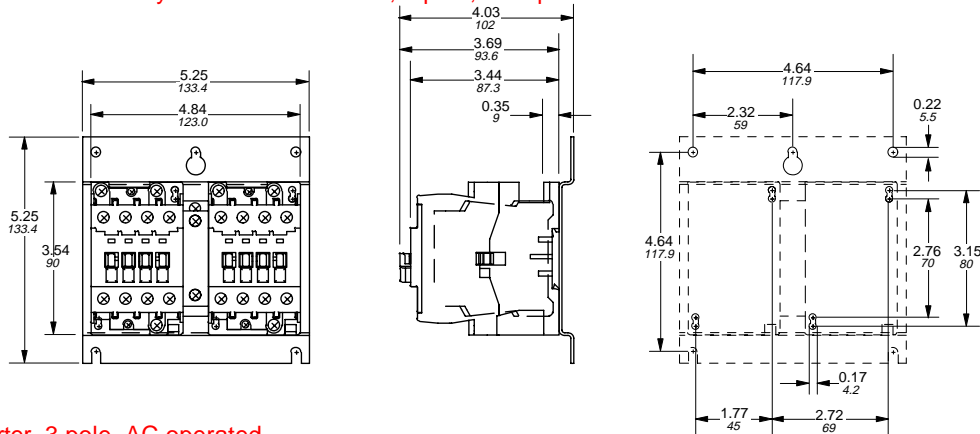

A26 + TA25 — Starter, 3 pole, AC operated

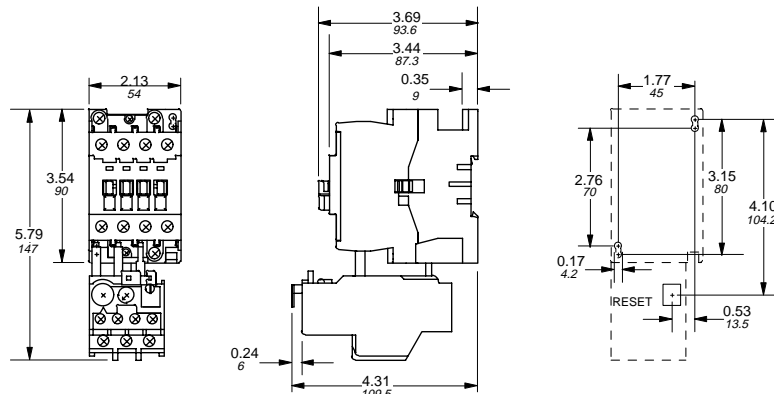

A26 + VM5 or VE5 + TA25 — Reversing starter, 3 pole, AC operated

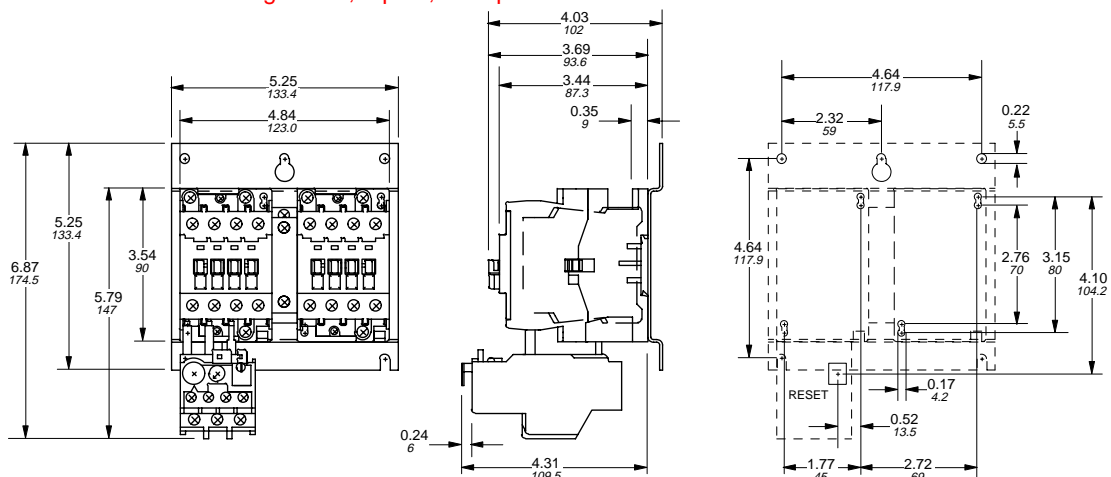

Contactors

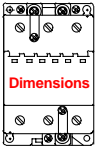

Approximate dimensions for 3 pole, AC operated A contactors & starters A30 & A40

00.00 — Inches
00.00 — Millimeters

A30 & A40 — Contactor, 3 pole, AC operated

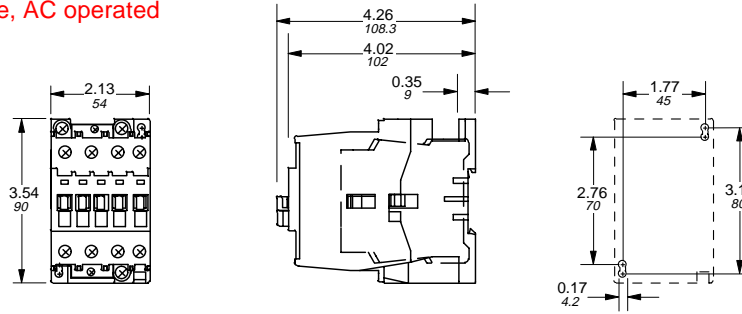

A30 & A40 + VM5 or VE5 — Mechanically interlocked contactor, 3 pole, AC operated

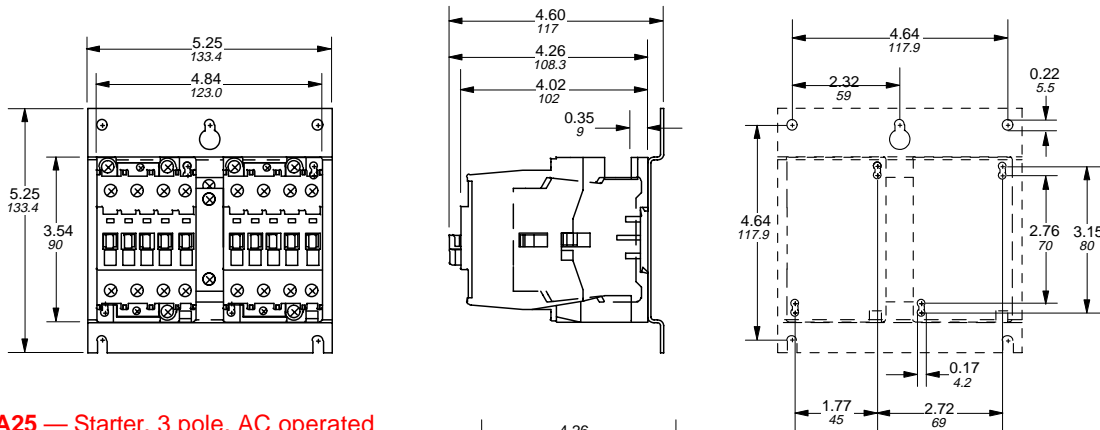

A30 & A40 + TA25 — Starter, 3 pole, AC operated

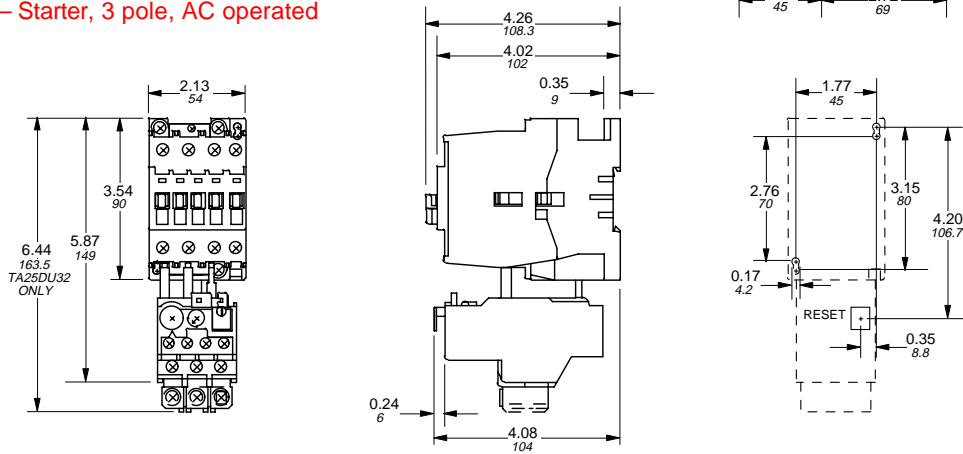

A30 & A40 + TA42 — Starter, 3 pole, AC operated

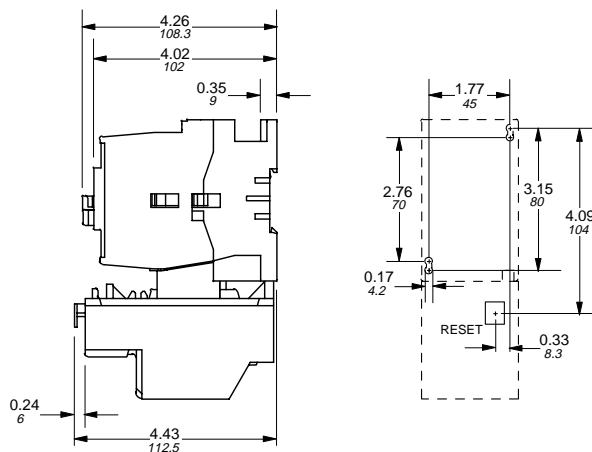

Contactors

Approximate dimensions for 3 pole, AC & DC operated A contactors & starters A30 – A(E)75

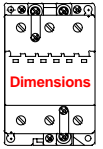

← 00.00 Inches
00.00 Millimeters →

A30 & A40 + VM5 or VE5 + TA25 — Reversing starter , 3 pole, AC operated

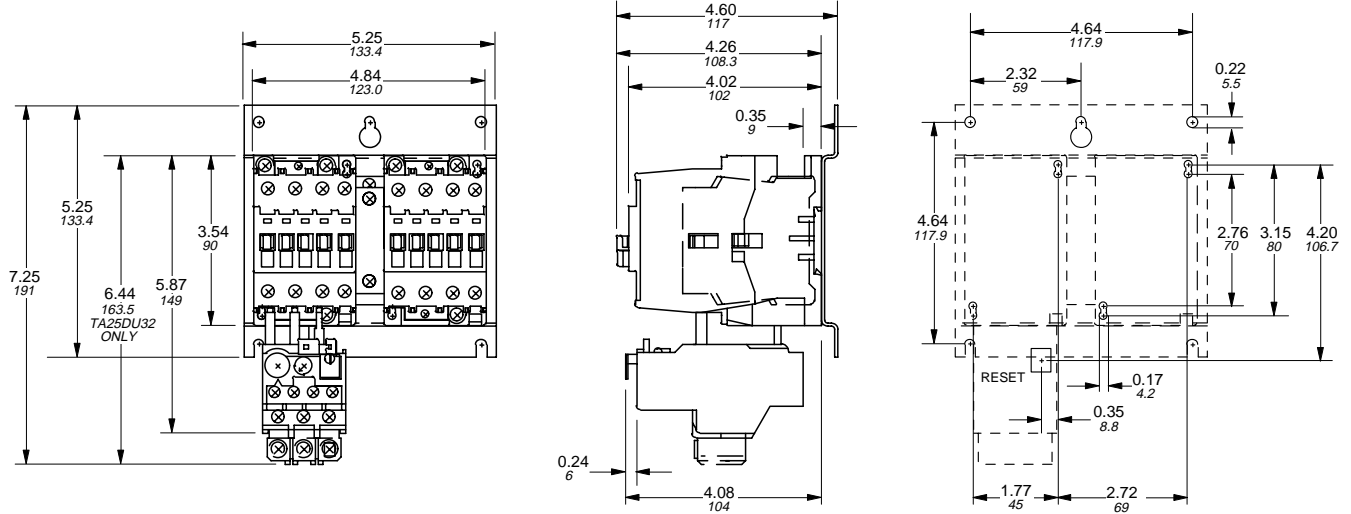

A30 & A40 + VM5 or VE5 + TA42 — Reversing starter , 3 pole, AC operated

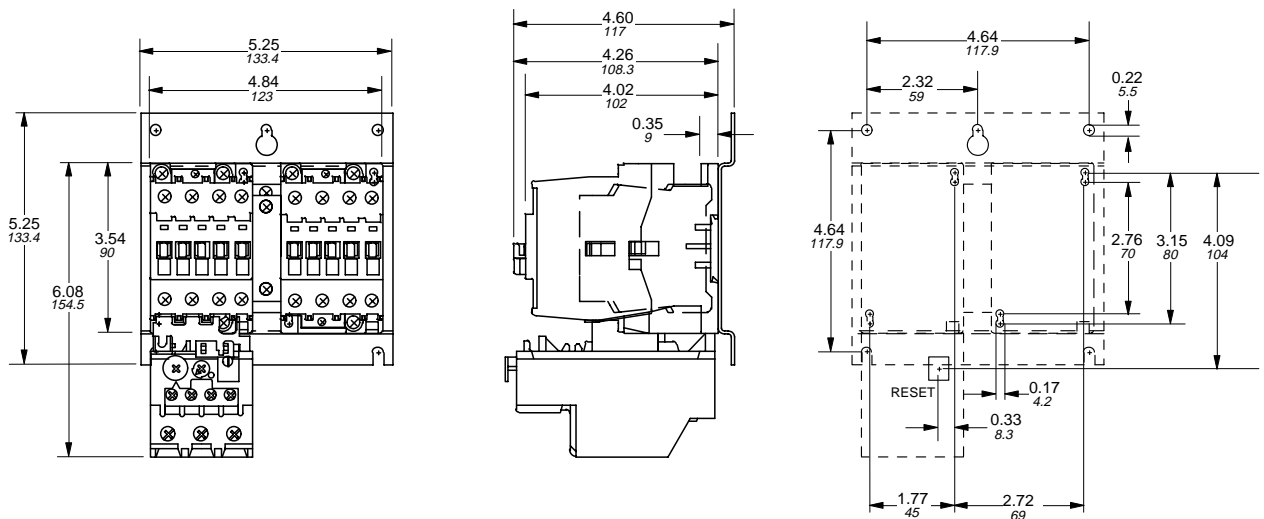

A(E)50 – A(E)75 — Contactor, 3 pole, AC & DC operated

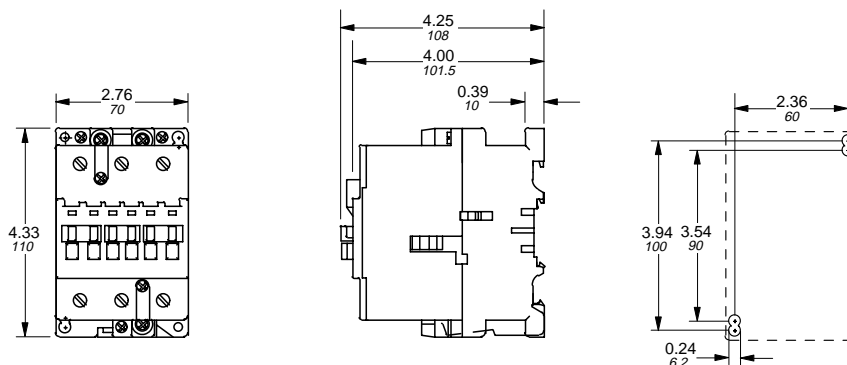

Contactors

AC 1030 – 6/98

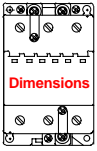

Approximate dimensions for 3 pole, AC & DC operated A contactors & starters A(E)50 – A(E)75

← 00.00 → Inches
00.00 → Millimeters

A(E)50 – A(E)75 + VM5 or VE5 — Mechanically interlocked contactor, 3 pole, AC & DC operated

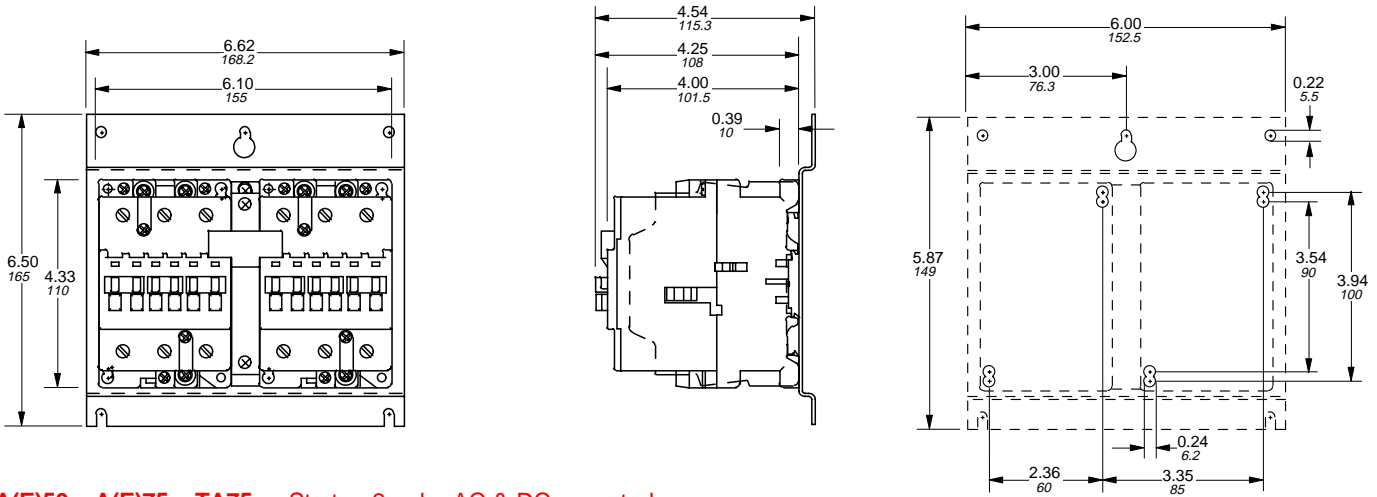

A(E)50 – A(E)75 + TA75 — Starter, 3 pole, AC & DC operated

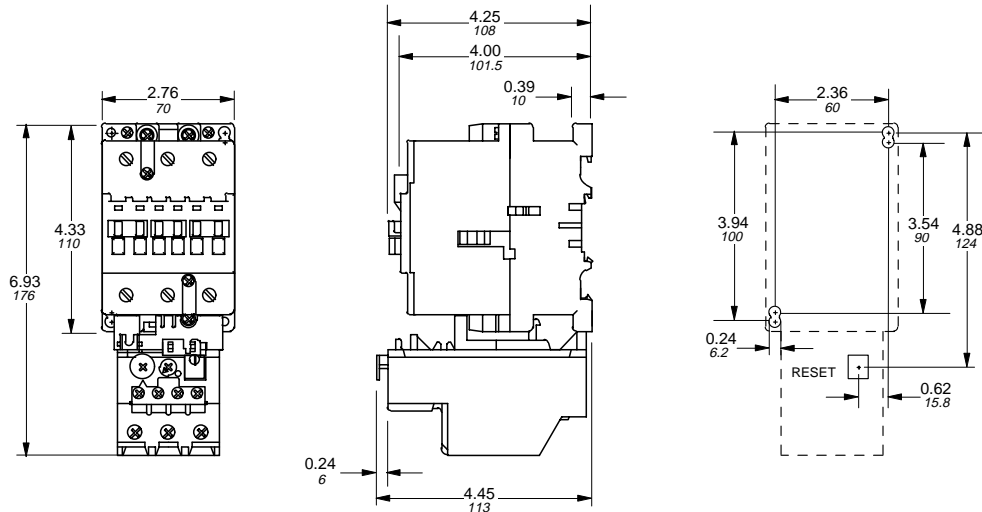

A(E)50 – A(E)75 + VM5 or VE5 + TA75 — Reversing starter, 3 pole, AC & DC operated

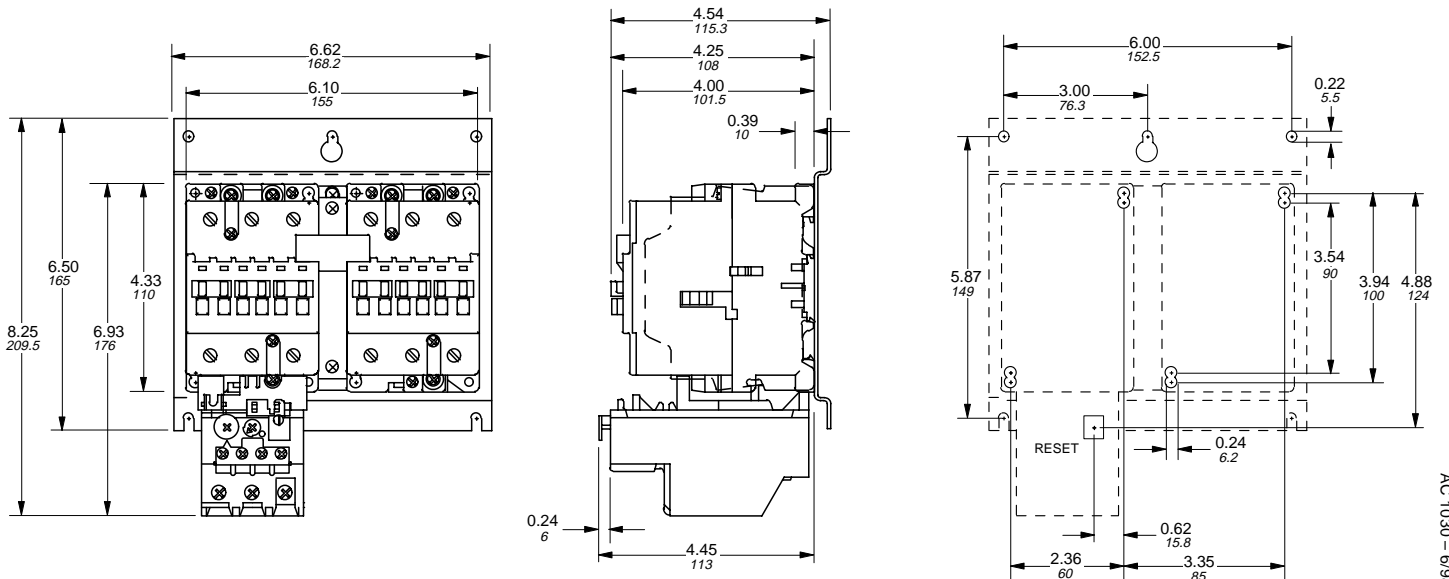

AC 1030 – 698

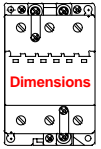

Approximate dimensions for 3 pole, AC & DC operated A contactors & starters A(E)95 & A(E)110

← 00.00 — Inches
00.00 — Millimeters →

A(E)95 & A(E)110 — Contactor, 3 pole, AC & DC operated

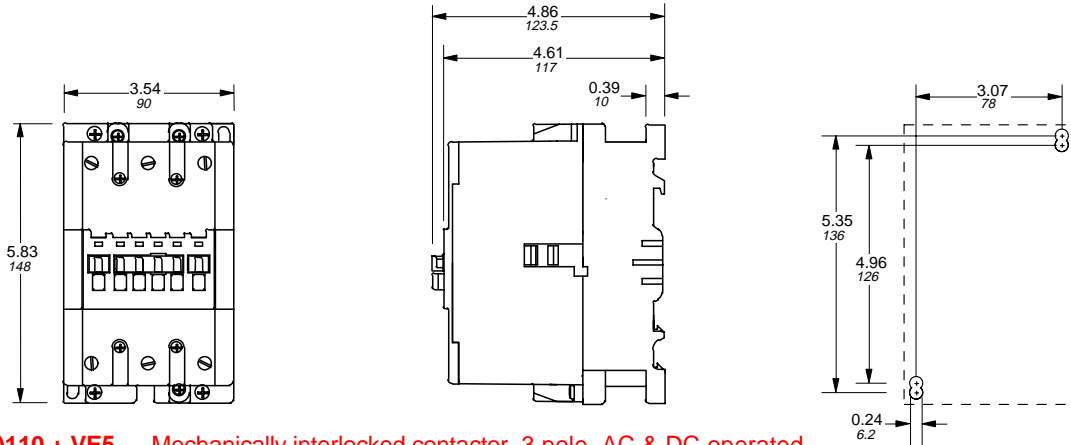

A(E)95 & A(E)110 + VE5 — Mechanically interlocked contactor, 3 pole, AC & DC operated

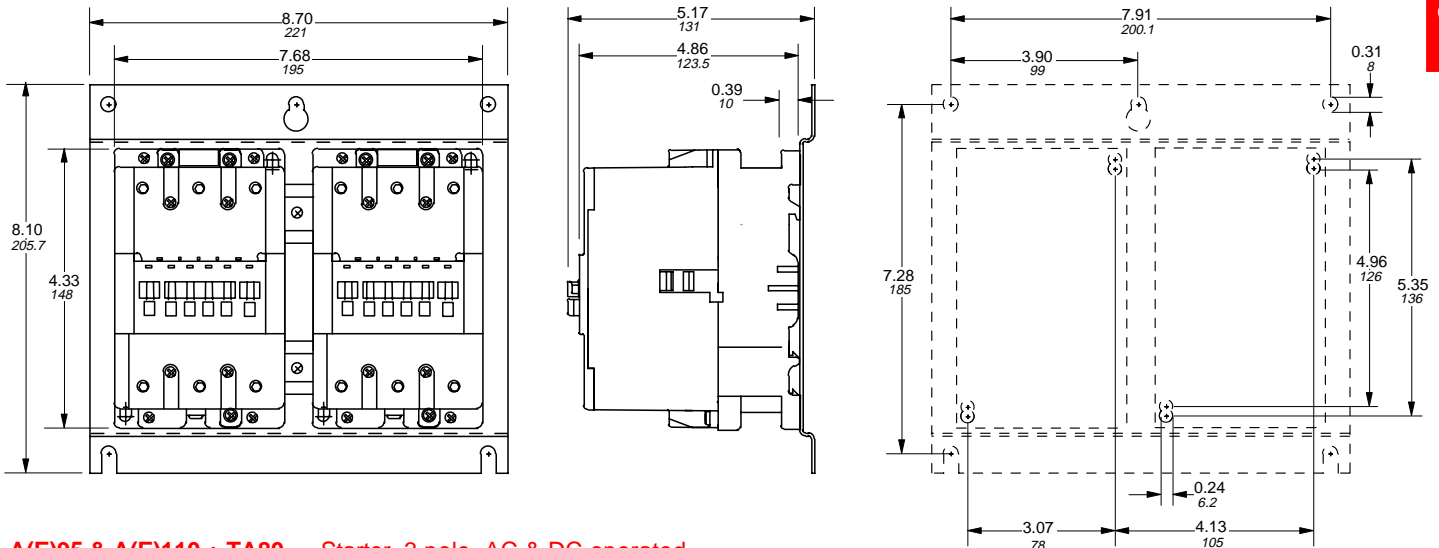

A(E)95 & A(E)110 + TA80 — Starter, 3 pole, AC & DC operated

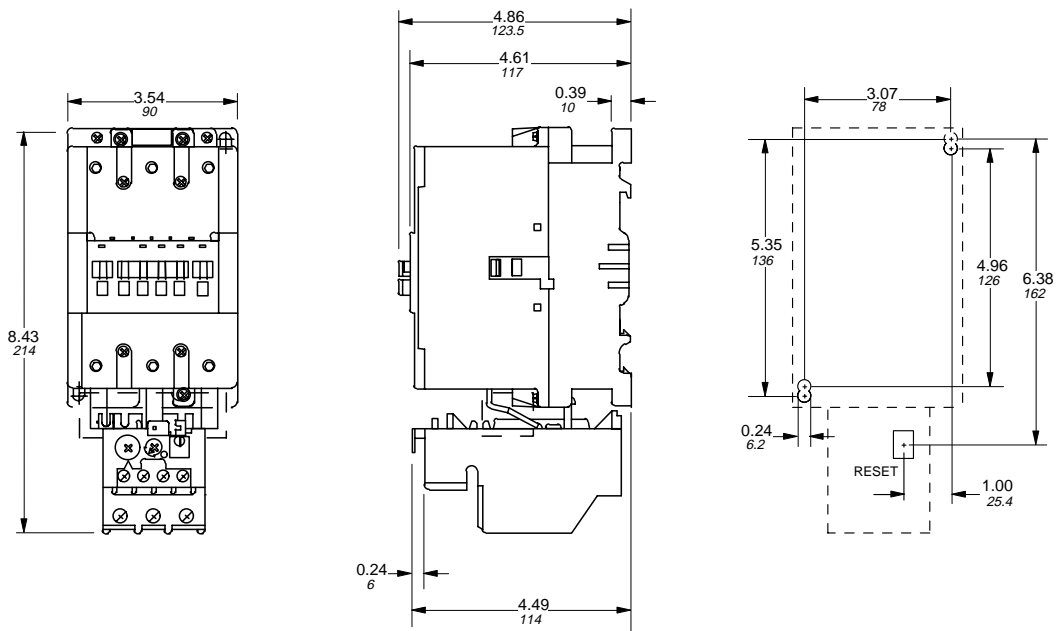

Contactors

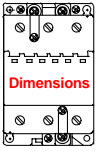

Approximate dimensions for 3 pole, AC & DC operated A contactors & starters A(E)95 & A(E)110

← 00.00 Inches
00.00 Millimeters →

A(E)95 & A(E)110 + TA110 — Starter, 3 pole, AC & DC operated

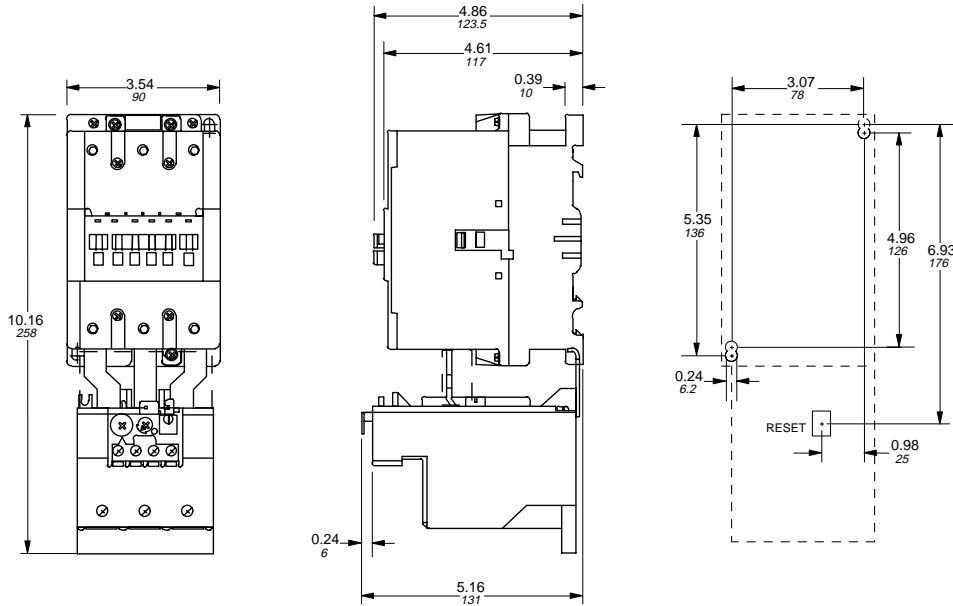

A(E)95 & A(E)110 + VE5 + TA80 — Reversing starter, 3 pole, AC & DC operated

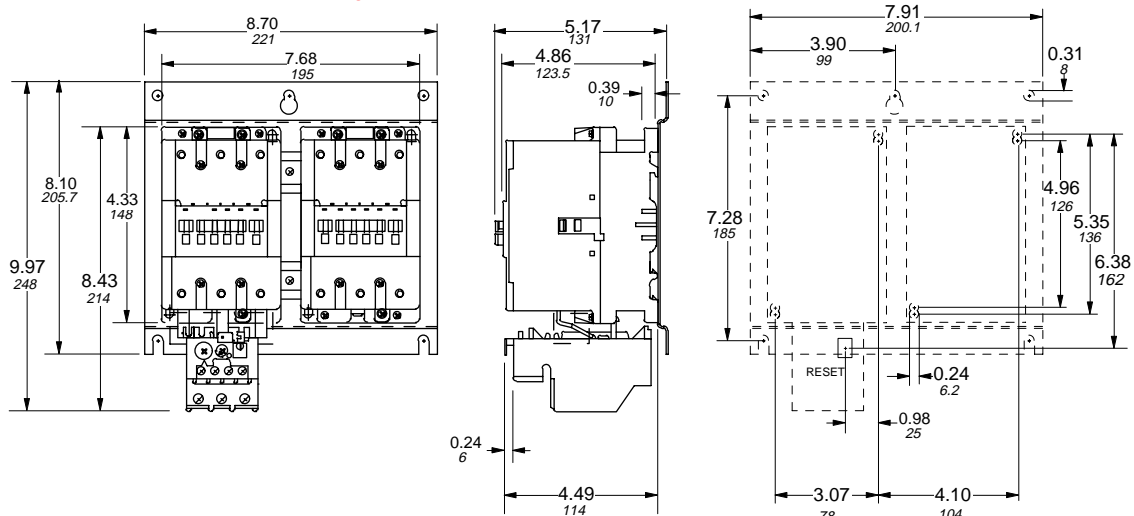

A(E)95 & A(E)110 + VE5 + TA110 — Reversing starter, 3 pole, AC & DC operated

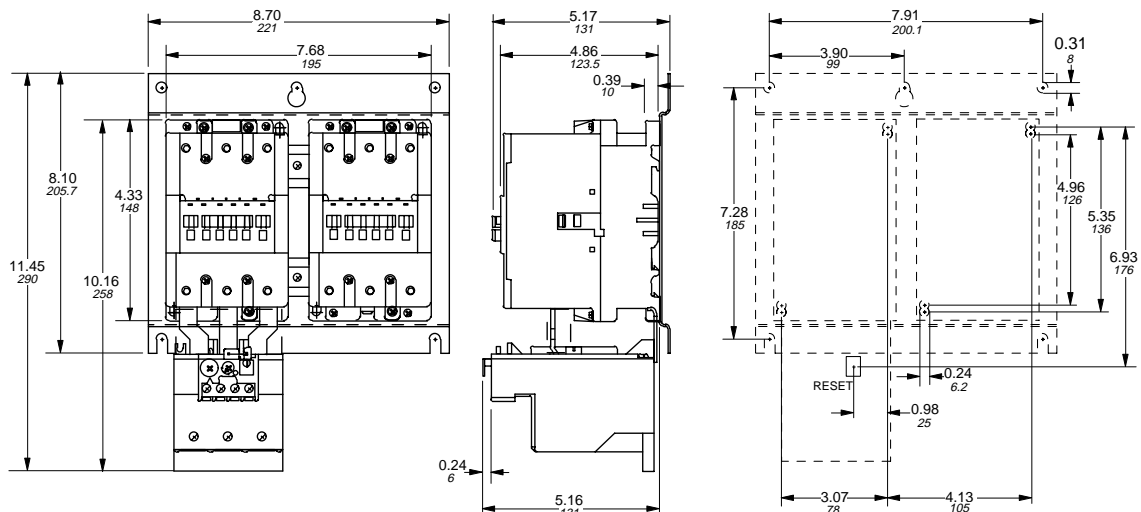

Approximate dimensions for 4 pole, AC & DC operated A contactors & starters A9 – A(E)75

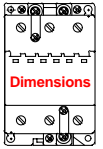

00.00 Inches
00.00 Millimeters

A9 – A16 — Contactor, 4 pole, AC operated

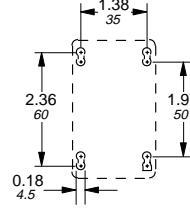
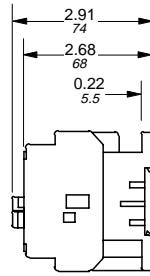
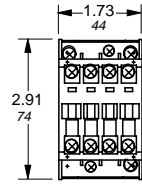

A26 — Contactor, 4 pole, AC operated

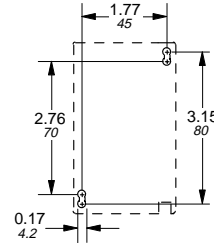
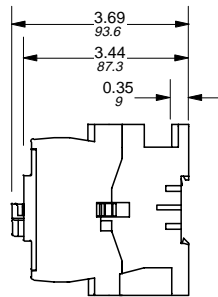
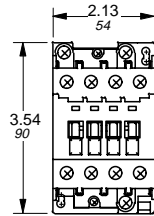

A(E)45 — Contactor, 4 pole, AC & DC operated

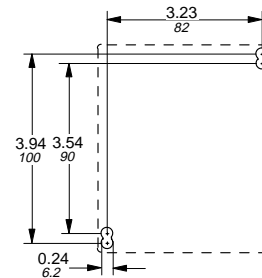
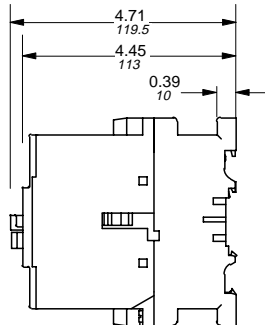
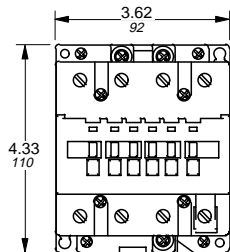

A(E)50 – A(E)75 — Contactor, 4 pole, AC & DC operated

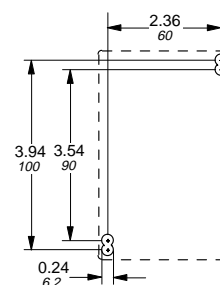
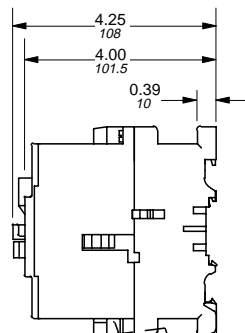
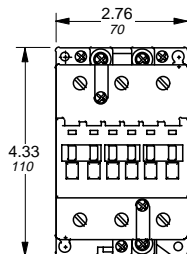

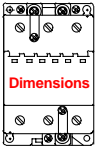

Approximate dimensions for 3 & 4 pole, DC operated BC contactors BC9 – BC30

← 00.00 → Inches
00.00 → Millimeters

BC9 & BC16 — Contactor, 3 & 4 pole, DC operated

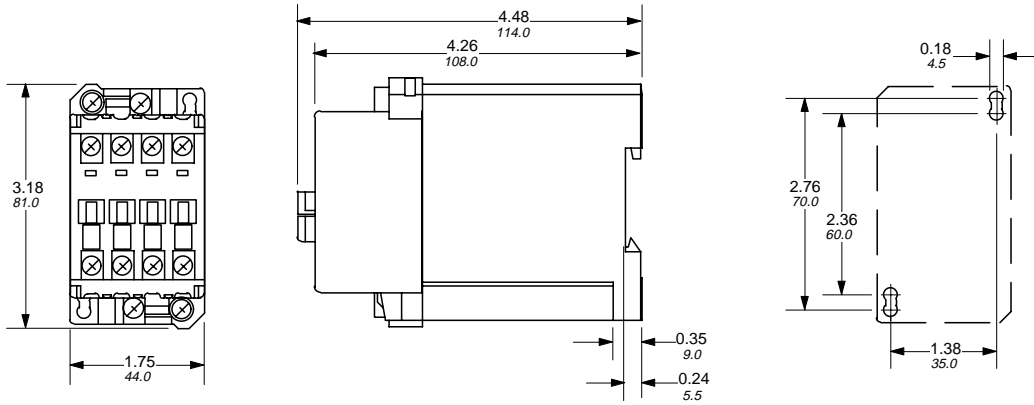

BC25 — Contactor, 3 & 4 pole, DC operated

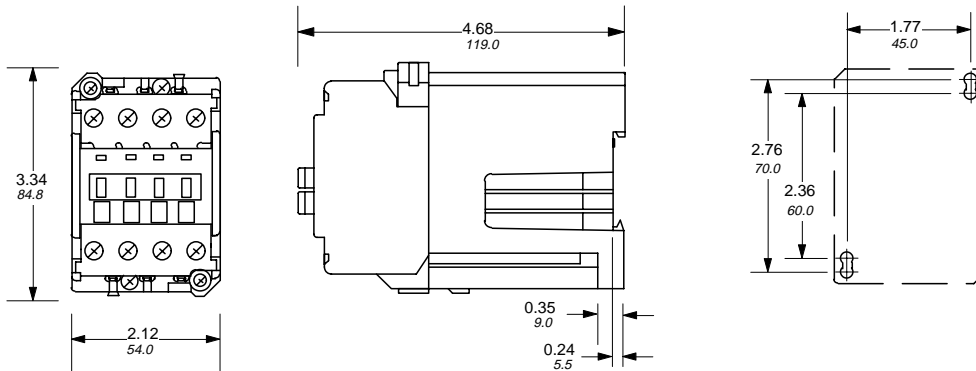

BC30 — Contactor, 3 pole, DC operated

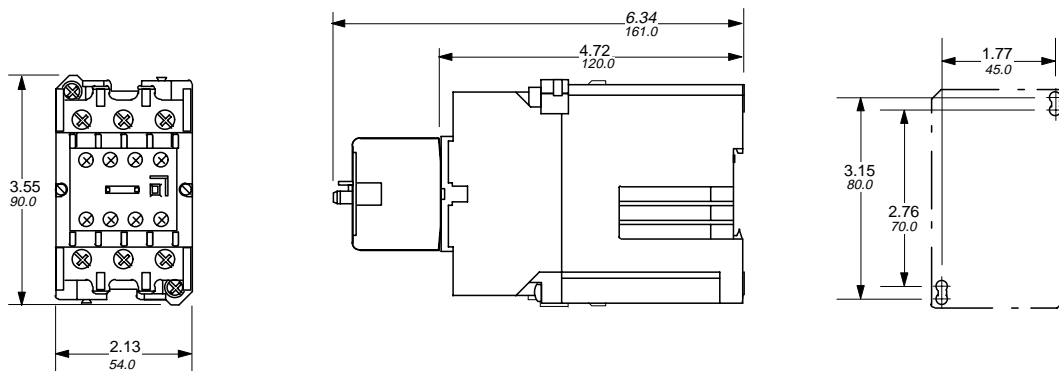

Approximate dimensions for A & BC contactors Accessories for A9 – A(E)110; BC9 – BC30

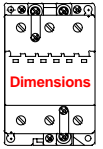

00.00 — Inches
00.00 — Millimeters

A9 - A(E)110 BC9 - BC30

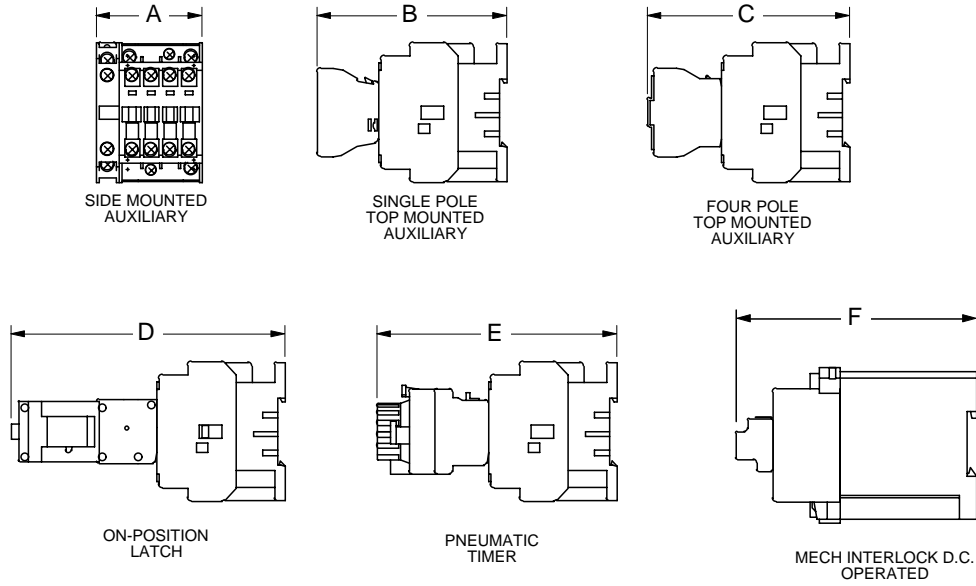

TYPE		A	B	C	D	E	F
A9-16	IN MM	2.20 56	3.96 100.5	4.21 107	5.71 145	5.00 127	— —
A26	IN MM	2.20 56	4.72 119.8	4.97 126.3	6.47 164.3	5.76 146.3	— —
A30-40	IN MM	2.20 56	5.30 134.5	5.55 141	7.05 179	6.34 161	— —
A50-75 AE50-75	IN MM	3.23 82	5.27 133.9	5.52 140.3	7.03 178.5	6.32 160.4	— —
A45	IN MM	4.09 104	5.73 145.5	5.98 152	7.48 190	6.77 172	— —
A95-110 AE95-110	IN MM	4.02 102	5.91 150	6.16 156.5	— —	— —	— —
BC9, BC16	IN MM	— —	5.53 140.5	5.79 147	7.28 185	6.58 167	5.04 128
BC25	IN MM	— —	5.77 146.5	6.02 153	7.52 191	6.81 173	5.28 134
BC30	IN MM	— —	— —	— —	— —	— —	5.51 140

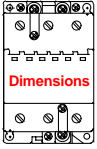

Notes

← 00.00 → Inches
00.00 → Millimeters



DLA starters

General information

The construction of DLA starters is based on ABB A Line contactors. The mounting plate, including a built-in A contactor, is designed to integrate an ABB manual motor starter type MS325.

Starters can be easily made with protection against overloads and short-circuits (Type I or Type II coordination).

The technical characteristics of these devices are identical to A Line contactors.

The advantages are as follows:

Simplified installation:

- DLA starters mount onto 35 x 15 mm exclusively DIN rail (EN 50022)
- Direct mounting of manual motor starter MS 325
- Contactor coil terminals accessible on lower side.

High performance as a result of the combination of the MS325 manual motor starter with high breaking capacity and the new A Line contactor ensuring high electrical durability.

Accessory types:

- on manual motor starter: set of bus bars, external operating mechanism, padlock holder, auxiliary contact, undervoltage coil, shunt trip, etc.

Manual motor starters

General information

Type MS325

- Suitable for use with 3-phase motors up to 25 FLA
- UL listed & CSA certified for 1200A group motor installation with fuses or breaker
- 14 setting ranges from 0.1 to 25 amps
- Up to 30kA or 85kA with no backup fuse required
- 35mm DIN rail snap-on mounting
- Terminals supplied in the open position
- High vibration resistance
- Compact size
- Wide range of accessories
- Easy field wiring for single phase applications
- Internal magnetic trips
- Screwdriver guide holes
- Touch safe design: All connection terminals are protected against accidental touch
- Adjustable ambient compensated Class 10 overload relay (-20°C to +55°C open, -20°C to +45°C enclosed)
- Enclosures with the following accessories
 - Padlock attachment
 - Pilot light
- Meets UL, CSA, VDE & IEC international standards
- Modular design
- Accessories include:
 - Additional auxiliary contact block (1 N.O. & 1 N.C.)
 - Undervoltage trip
 - Three phase connecting bus bars
 - Through the door operator
 - Shunt trip

Types of coordination

IEC standard 947-4-1 (EN 60 947-4-1) defines two types of coordination according to the anticipated level of service continuity. The admissible damage limits for the control gear are defined.

- Coordination Type I:

In the event of a short-circuit, the contactor or starter causes no danger to persons or facilities, and cannot function thereafter without repairs being made or parts being replaced.

- Coordination Type II:

In the event of a short-circuit, the contactor or starter causes no danger to persons or facilities, and must be able to function thereafter. Light welding of contacts is possible.

Index

• DLA Starter general information	2.1
• Selection	2.2
• MS325 General information	2.3
• MS325 Accessories	2.4
• MS325 Technical data	2.5
• Approximate dimensions	2.6



DLA starters

Type MS325 manual motor starter & DLA9 – DLA 26 module

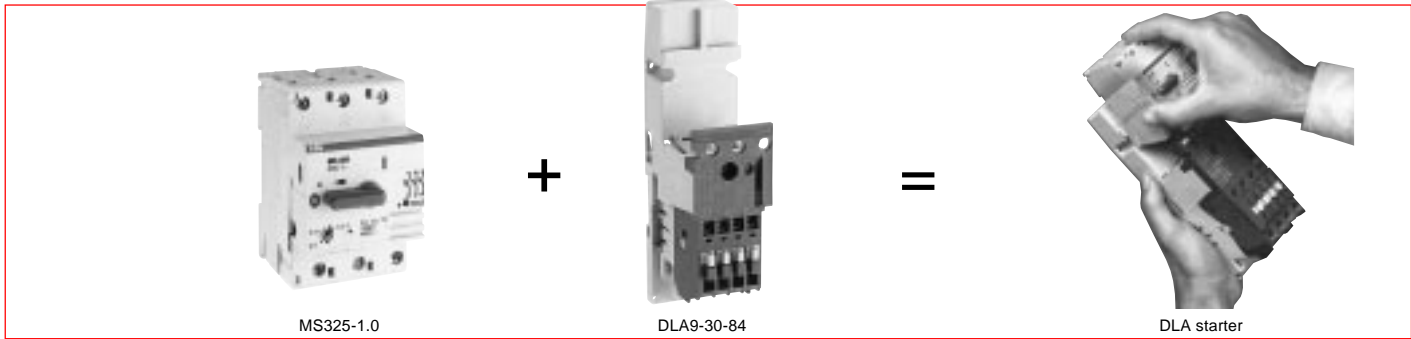

Manual motor starters

Thermal setting range (amps)	Single-phase horsepower ratings ^①		3-phase horsepower ratings			Branch CPD ^②		Catalog number	List price	DLA module catalog number	List price
	120V	240V	240V	480V	600V	Maximum fuse size	Maximum MCCB size				
MS325											
0.10 – 0.16	—	—	—	—	—	1600A	1200A	MS325-0.16	\$ 96	DLA9-30-84	\$ 117
0.16 – 0.25	—	—	—	—	—	1600A	1200A	MS325-0.25			
0.25 – 0.40	—	—	—	—	—	1600A	1200A	MS325-0.40			
0.40 – 0.63	—	—	—	—	—	1600A	1200A	MS325-0.63			
0.63 – 1.0	—	—	—	1/2	1/2	1600A	1200A	MS325-1.0	110	DLA9-30-84	\$ 117
1.0 – 1.6	—	1/10	—	3/4	3/4	1600A	1200A	MS325-1.6			
1.6 – 2.5	—	1/6	1/2	1	1.5	1600A	1200A	MS325-2.5			
2.5 – 4.0	1/8	1/3	1	2	3	1600A	1200A	MS325-4.0			
4.0 – 6.3	1/4	1/2	1.5	3	5	1600A	1200A	MS325-6.3			
6.3 – 9.0	1/3	1	2.5	5	7.5	1600A	1200A	MS325-9.0			
9.0 – 12.5	1/2	2	3	7.5	10	1600A	1200A	MS325-12.5	128	DLA12-30-84	131
12.5 – 16	1	2.5	5	10	10	1600A	1200A	MS325-16		DLA16-30-84	153
16 – 20	1.5	3	5	10	15	1600A	1200A	MS325-20	141	DLA16-30-84	153
20 – 25	2	3	7.5	15	20	1600A	1200A	MS325-25	149	DLA26-30-84	234

Coil voltage selection

All AC operated catalog numbers include a 120VAC coil. All DC operated catalog numbers include a 110VDC coil. To select other coil voltages, substitute the code from the Coil Voltage Selection chart for the two digits after the last dash in the catalog number.

Ex.: A 240V coil is required for a DLA9 starter: DLA9-30-**80**

Ordering instructions: MS325 manual motor starters & DLA module must be ordered separately and assembled by customer.

Coil voltage selection chart

Hz	Volts															
	12	24	48	110	120	125	208	220	240	277	380	415	440	480	500	600
60		81	83	84	84		34		80	42	48		86	51		55
50		81	83	84				80			85	86				55

For other voltages, see page 1.13

Ordering instructions

The MS325 manual motor starters and the DLA module must be ordered separately and assembled by customer.

Accessories for DLA starters

Accessories for DLA starters are the same as accessories for the corresponding A contactor size:

- DLA9 — same accessories as A9 contactors
- DLA12 — same accessories as A12 contactors
- DLA16 — same accessories as A16 contactors
- DLA28 — same accessories as A28 contactors

① Single phase motor ratings are based upon wiring all three poles in series.
 ≠ In group motor applications, use the lowest maximum fuse or MCCB size.

General information

MS325 Manual motor starters



Group motor applications

The need for individual short circuit protective devices such as fuses is eliminated with group motor applications, saving installation expense and panel space. ABB Line manual motor starters are UL Listed and can be used in group installations of motors.

Single motor applications

ABB Line manual motor starters provide overload protection as required by Article 430 of the National Electrical Code. Control is provided by manual operation of the contacts; overload protection is provided by an adjustable bi-metallic trip mechanism.

Selection

Group installation is an approach to building multi-motor control systems in accordance with Section 430-53 of the National Electrical Code. The selection of components used in group installations is a simple process which consists of several steps.

- First is the selection of the appropriate fuse as Branch Circuit Protective Device (BCPD).
- Second is the selection of the appropriate motor starter and protector.
- Third, the selected MS325 must be checked for UL listing with the selected BCPD and the available short circuit current at the application location.

1. Fused disconnect

Calculate maximum fuse size according to NEC 430-53 (c). I_{max} (fuse size) = $175\% \times FLC$ (full load current for largest motor) + the sum of FLC (full load current for largest motor) + the sum of FLC values for other motors on that

branch using NEC Table 430-150 on the right. Select fuse from NEC Table 240-6 below. Where I_{max} falls between two fuse ampere ratings NEC 430-53 (c) permits going to the next high ampere rating.

2. Motor starter & protector selection

Select the proper MS325 catalog number for each motor load from page 2.2 based on the actual motor full load current (FLA) using the "Thermal setting range" column for reference.

3. MS325 Interruption ratings

Using the Interruption ratings table on page 2.5, identify the system application voltage and interrupting capacity for the type of fuse selected in step 1 above.

NEC 240-6 Standard fuse amperes

15, 20, 25, 30, 40, 45, 50, 60, 70, 80, 90, 110, 125, 150, 175, 200, 225, 250, 300, 350, 400, 450, 500, 600, 700, 800, 1000, 1200, 1600

Examples: Select components for protecting the following 3-phase, 460VAC, squirrel cage induction motors. The nameplate data are:

1/2 HP, 1.0 FLA; 3 HP, 4.8 FLA; 5 HP, 7.6 FLA; 7.5 HP, 11 FLA; 10 HP, 14 FLA

Example: Using fused disconnect

- $I_{max} = 175\% \times 14 + (11 + 7.6 + 4.8 + 1) = 48.9A$
- Fuse rating using Table NEC 240-6 = 50A
- Minimum disconnect size = $115\% \times \text{Total FLA}$
- NEC 430-150 table = $115\% \times (14 + 11 + 7.6 + 4.8 + 1) = 44.16$

Disconnect for 50A fuses is ok.

Note: Refer to NEC 310-1 and NEC 430-53(d) for cable sizing.

For full load currents of 208 and 200 volt motors, increase the corresponding 230 volt motor full-load current by 10% and 15%, respectively.

MS325 data

Motor rating at 460V		MS325	Contactor
Horsepower	FLA, AC3		
1/2	1.0	MS325-1.0	B9C
3	4.8	MS325-6.3	B9C
5	7.6	MS325-9.0	B9C
7.5	11	MS325-12.5	B12C
10	14	MS325-16	B16C

NEC Table 430-150 full load current, 3ph AC motor

Horsepower	Induction type squirrel cage & wound rotor ^①		
	230V amps	460V amps	575V amps
1/2	2	1	.8
3/4	2.8	1.4	1.1
1	3.6	1.8	1.4
1.5	5.2	2.6	2.1
2	6.8	3.4	2.7
3	9.6	4.8	3.9
5	15.2	7.6	6.1
7.5	22	11	9
10	28	14	11
15	42	21	17
20	54	27	22
25	68	34	27

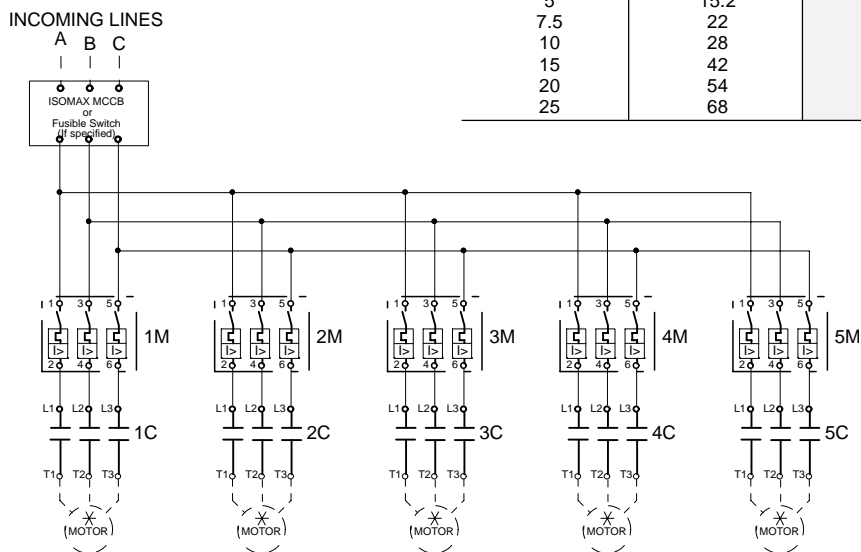

① These values of full-load current are for motors running at speeds usual for belted motors and motors with normal torque characteristics. Motors built for especially low speeds or high torques may require more running current, and multispeed motors will have full-load current varying with speed, in which case the nameplate current rating shall be used.

The voltages listed are rated motor voltages. The currents listed shall be permitted for system voltage ranges of 110 to 120, 220 to 240, 440 to 480, and 550 to 600 volts.



Accessories for MS325 manual motor starters



DLA starters

Undervoltage trip

Item description	Catalog number	List price
24V	MS325-UA24	\$ 55
48V	MS325-UA48	
60V	MS325-UA60	
110V	MS325-UA110	
230V	MS325-UA230	
400V	MS325-UA400	
415V	MS325-UA415	
480V	MS325-UA480	

Shunt trips

Item description	Catalog number	List price
110 – 127V, 60 Hz	MS325-ST110	\$ 55
208V, 60 Hz	MS325-ST230	
440 – 480V, 60 Hz	MS325-ST3	
24VAC	MS325-ST24	

Auxiliary contact blocks

Item description	Catalog number	List price
1 N.O. & 1 N.C.	MS325-HK11	\$ 22
2 N.O.	MS325-HK20	
2 N.C.	MS325-HK02	

Supporting terminal

Item description	Catalog number	List price
for UA or as N/LS clamp	MS325-AS	\$ 10

Padlocking devices

Item description	Catalog number	List price
Adapter for padlock type SA1	MS325-SA1	\$ 10
Complete padlock device SA3	MS325-SA3	25

Door mounting kits

Item description	Catalog number	List price
Handle & front gray plate	MS325-H	\$ 52
Emergency red OFF handle, yellow front plate	MS325-HES	52
Neutral terminal, 8 AWG, blue	MS325-NT	5
Gray handle, black flange	MS325-HG	60
Emergency OFF red handle, yellow flange	MS325-HGES	60

Terminal blocks

Item description	Catalog number	List price
For 4 AWG wire	MS325-SM1	\$ 16
For busbar	MS325-BB1	17

Busbars

Item description	Catalog number	List price
2 MS 325, without auxiliary contacts	MS325-2BB	\$ 16
2 MS 325, with 1 auxiliary contacts	MS325-2BB1	20
2 MS 325, with 2 auxiliary contacts	MS325-2BB2	20
4 MS 325, without auxiliary contacts	MS325-4BB	22
4 MS 325, with 1 auxiliary contacts	MS325-4BB1	25
4 MS 325, with 2 auxiliary contacts	MS325-4BB2	25

Bell alarm contact blocks

Item description	Catalog number	List price
1 N.O.	MS325-SK10	\$ 22
1 N.C.	MS325-SK01	

Shaft adapter

Item description	Catalog number	List price
For use with non-fused switch handle Type OT	MS325-SA	\$ 25

Technical data for MS325 manual motor starters ①



General data

Rated voltage	600 V
Rated current	25 A (14 setting ranges, 0.1 to 25A)
Rated frequency	50 – 60 Hz
Electrical and mechanical life endurance	100,000 operations
Mounting position	Optional
Ambient temperature	-25°C to +50°C
Temperature compensation	-25°C to + 50°C
Wire range	14 – 8 AWG
Standards	
	<ul style="list-style-type: none"> • IEC 157-1, 292-1, 337-1 • VDE 0660 part 101, 104, 106, 200 • SEV 1090-1, 1092-1, 1093-1

Approvals

- UL: E137861 (MS 325); E90353 (Auxiliary contact blocks)
- CSA: LR 15332
- NEMKO, DEMKO, FI, SEV, KEMA, KEUR

Tripping values

Thermal tripping setting ranges (A)	Magnetic tripping operating current (A)
0.1 - 0.16	1.6
0.16 - 0.25	2.5
0.25 - 0.40	4.0
0.4 - 0.63	6.3
0.63 - 1.0	12
1 - 1.6	19
1.6 - 2.5	30
2.5 - 4.0	48
4 - 6.3	75
6.3 - 9.0	108
9 - 12.5	150
12.5 - 16	192
16 - 20	240
20 - 25	300

Low voltage trip

Rated voltage	400V
Rated frequency	50 – 60 Hz
Rated power	0.9 W
Operating voltage	
• Drop out (% of nominal control voltage)	10% – 75%
• Pull in	80% – 110%

Auxiliary and pilot contacts

Rated voltage	400V
Rated current	6 A
• I_{th}	2 A, 200 V
• AC 11	2 x 14 AWG
Connection cross sections	

Maximum switching capacity for DC loads using 3 main current paths in series

DC Load	Voltage	Amps
DC 1	60V	25
	110V	25
	220V	25
	440V	25
DC 2/3	60V	25
	110V	25
	220V	25
	440V	25
DC 4/5	60V	25
	110V	25
	220V	25
	440V	25

Auxiliary leads

Type load	Voltage	Amps
Carrying capacity of aux. contacts		
Thermal permanent current I_{th}		6
Rated operating for current I_e	AC11 up to	
	220VAC	2
	380VAC	1.5
500VAC	1.2	
DC11 up to	60VDC	1.5
	110VDC	1
	220VDC	0.3
	440VDC	0.1

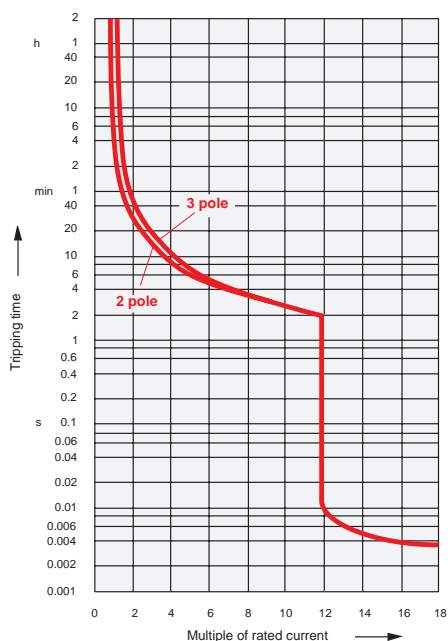

AC 1030 – 6/98

① For contactor technical data, see pages 1.20 – 1.30

DLA starters



Technical data for IEC coordination tables



DLA 9-30

DLA 26

DLA starters

Coordination tables

The tables below show the MS 325 manual motor starter and DLA starter combinations according to the type of coordination and motor current.

Motor power AC-3 and rated current three-phase cage motor, 1500 rpm		MS 325 manual motor starter		DLA starter type (120V coil shown)	Copper cable Minimum cross- section mm ²	Max. authorized current for combination A
		Type	Setting range			
380 V 400 V kW	A		A – A			A

Coordination type I, 400 V – 50 Hz, 50 kA, normal starting

0.37	1.2	MS 325 – 1.6	1.0 – 1.6	DLA 9-30-84	1.5	1.6
0.55	1.5	MS 325 – 1.6	1.0 – 1.6	DLA 9-30-84	1.5	1.6
0.75	2	MS 325 – 2.5	1.6 – 2.5	DLA 9-30-84	1.5	2.5
1.1	2.6	MS 325 – 4	2.5 – 4.0	DLA 9-30-84	1.5	4
1.5	3.5	MS 325 – 4	2.5 – 4.0	DLA 9-30-84	1.5	4
2.2	5	MS 325 – 6.3	4.0 – 6.3	DLA 9-30-84	1.5	6.3
3	6.6	MS 325 – 9	6.3 – 9.0	DLA 9-30-84	1.5	9
4	8.5	MS 325 – 9	6.3 – 9.0	DLA 9-30-84	1.5	9
5.5	11.5	MS 325 – 12.5	9.0 – 12.5	DLA 12-30-84	1.5	12
7.5	15.2	MS 325 – 16	12.5 – 16.0	DLA 16-30-84	2.5	16
11	22	MS 325 – 25	16.0 – 25.0	DLA 26-30-84	2.5	25

* Ambient temperature ≤ 30 °C

Coordination type II, 400 V – 50 Hz, 25 kA, normal starting

0.37	1.2	MS 325 – 1.6	1.0 – 1.6	DLA 9-30-84	1.5	1.6
0.55	1.5	MS 325 – 1.6	1.0 – 1.6	DLA 9-30-84	1.5	1.6
0.75	2	MS 325 – 2.5	1.6 – 2.5	DLA 9-30-84	1.5	2.5
1.1	2.6	MS 325 – 4	2.5 – 4.0	DLA 12-30-84	1.5	4
1.5	3.5	MS 325 – 4	2.5 – 4.0	DLA 26-30-84	1.5	4
2.2	5	MS 325 – 6.3	4.0 – 6.3	DLA 26-30-84	1.5	6.3
3	6.6	MS 325 – 9	6.3 – 9.0	DLA 26-30-84	1.5	9
4	8.5	MS 325 – 9	6.3 – 9.0	DLA 26-30-84	1.5	9
5.5	11.5	MS 325 – 12.5	9.0 – 12.5	DLA 26-30-84	1.5	12.5
7.5	15.2	MS 325 – 16	12.5 – 16.0	DLA 26-30-84	2.5	16
11	22	MS 325 – 25	16.0 – 25.0	DLA 26-30-84	2.5	25

* Ambient temperature ≤ 30 °C

Approximate dimensions for DLA starters DLA9 – DLA26



DLA 9 – DLA 16

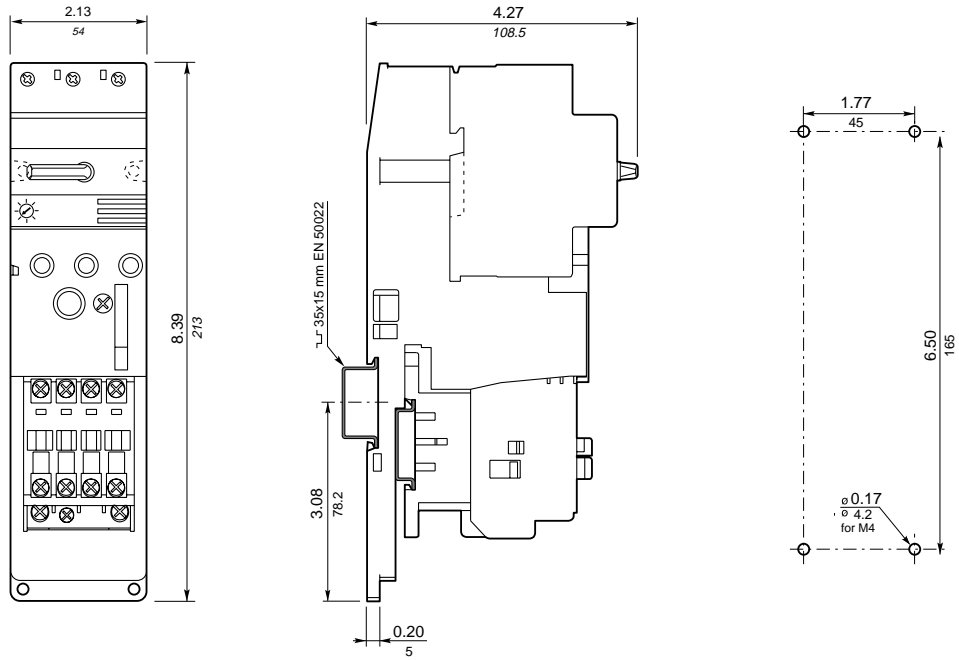

DLA 26

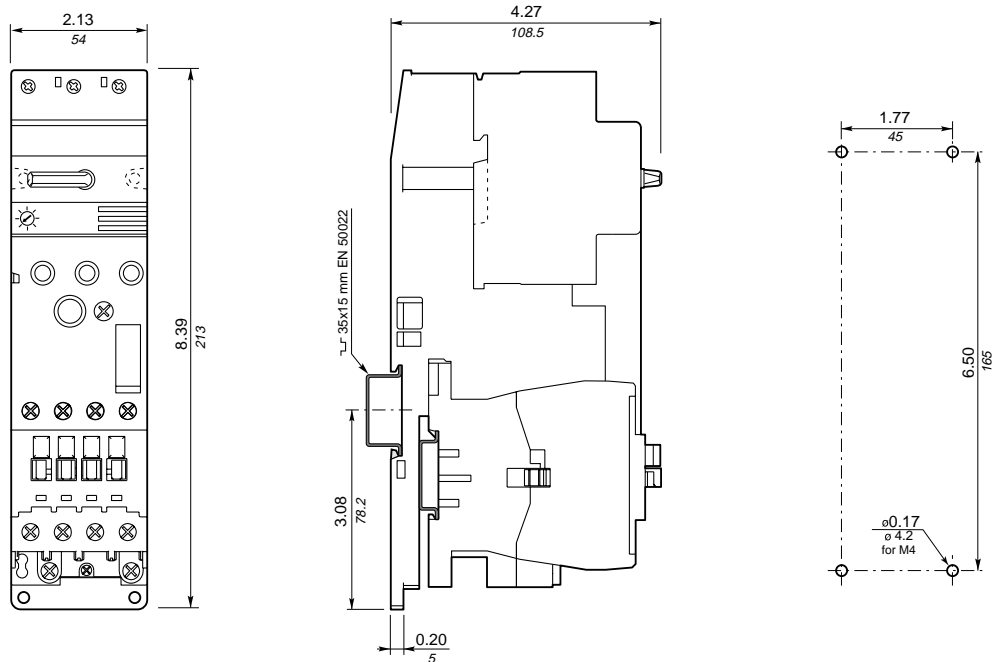

DLA starters



Notes



Overload relays

Type TA
Class 10

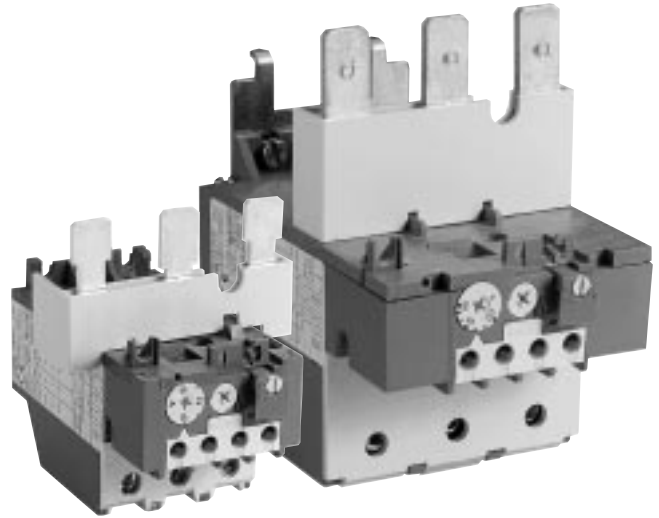

Description

- Available for starter construction with A Line contactors and separate panel mounting
- Designed for close couple mounting for 11 contactors, A9 – A110
- Separate base mounting available for all overload relays
- Class 10 adjustable overload relays are standard with all ABB Line starters
- Reset can also be adjusted to function as a stop button
- Screwdriver guide holes
- All terminal screws are available from the front
- UL File No: E48139
- CSA File No: LR98336
- Trip indication
- Remote trip and reset option available
- Single phase and phase unbalance protection
- Isolated alarm circuit (N.O.) contact
- Ambient compensation: -25°C to +55°C (-13°F to +131°F)
- Manual test
- Manual or automatic reset
- Factory calibrated and tested
- Wide adjustment range

Catalog number explanation

TA25DU 0.16

Frame size _____ Amp rating

Index

- Features 3.1
- OLRs for A9 – A110 3.4
- Technical data 3.7
- Approximate dimensions 3.12

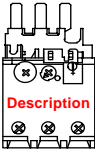

Description for Overload relays

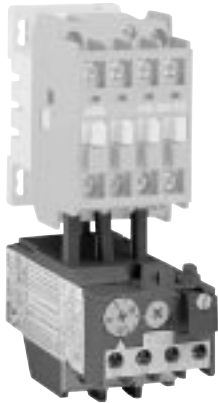

TA25DU

Application

TA thermal O/L relays are used with A Line contactors for the protection of motors having a nominal voltage of up to 600VAC max per UL/CSA (690VAC and 800VDC per IEC).

Product range

- Standard relays:
 - Types: TA25DU, TA42DU, TA75DU, TA80DU, TA110DU
 - **TA25 to TA110** are directly connected in the motor circuit.

Construction and function

Thermal O/L relays and their accessories meet UL, CSA and most other important international standards (IEC), European standards (EN) and the most important national standards (DIN-VDE, NFC-UTE, BS, etc.). They meet the certification and approval directives required throughout the world.

Thermal O/L relays are 3 pole.

The motor current flows through their bimetals (1 per phase) which are indirectly heated. Under the effect of the heating, the bimetals bend, cause the relay to trip and the position of the auxiliary contacts to change.

The relay setting range is graduated in amps. In compliance with international and national standards, the setting current is the **motor nominal current** and not the tripping current (no tripping at 1.05 x setting current, tripping at 1.2 times setting current).

The **tripping curves** (cold or warm starting, 3 phases and 2 phases) are shown on page 3.10

The relays are built to be self protecting in the event of an overload until the short circuit protection device is activated.

Function of TA25DU – TA110DU thermal O/L relays

	Resetting Contacts	Relay tripped		Relay not tripped
		Manual	Automatic	Both Manual and Automatic
Effect of blue button indexed on R	Resetting	Yes	No	No
	95-96	Closed when the button is pressed	No effect	No effect
	97-98	Open when the button is pressed		
Effect of blue button indexed on R/O	Resetting	Yes	No	No
	95-96	Closed when the button is released	No effect	Open when the button is pressed Closed when the button is released
	97-98	Open when the button is pressed		No effect

Overload relays

Selection guide for Overload relays

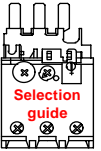

Thermal O/L relays

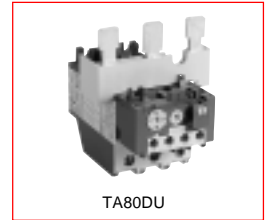
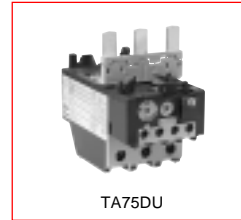
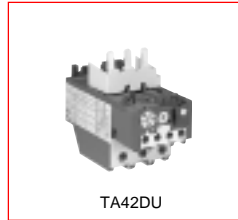
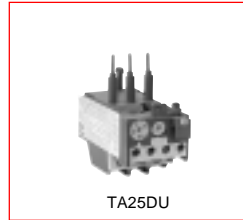

Types

Main characteristics

Construction	3 pole with ambient temperature compensation. Protection against single phase operation. Built in auxiliary contacts: 1N.O. + 1N.C.			

Resetting	Convertible: Manual to Automatic				
Setting ranges	Number	18	3	6	4
	from to	0.1 – 0.16A 24 – 32A	18 – 25A 29 – 42A	18 – 25A 60 – 80A	29 – 42A 60 – 80A

Mounted with contactors

Mounting kit	No kit is required for mounting thermal O/L relays below contactors			
Types of contactors for combined mounting	A9 BC9			
	A12 BC16 A16 BC18 A26 BC25 A30 BC30 A40	A30 A40	A50 AE50 A63 AE63 A75 AE75	A95 AE95 A110 AE110

Mounted separately (i.e. separate from contactor)

Separate mounting kit	DB25	DB80
-----------------------	------	------

Accessories

Tripping coil	DS25-A	
Resetting coil	DR25-A	
Terminal shroud	Terminals protected against direct contact (without the addition of terminal shrouds)	
Function markers	BA5-50	

Overload relays

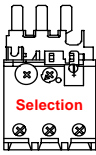

Type TA, Class 10 for Contactors A9 – A110

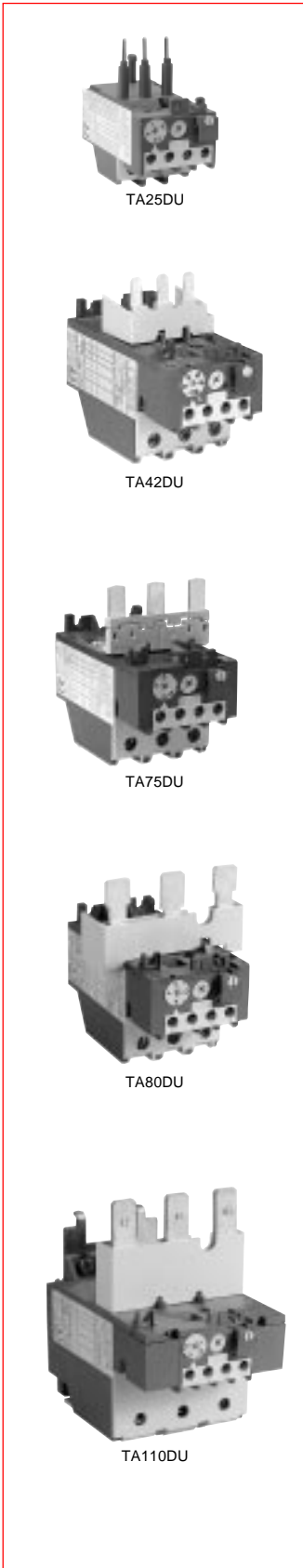

For contactor	Setting range A	Catalog number	List price
A9 – A40 BC9 – BC30 ^①	0.1 – 0.16	TA25DU0.16	\$ 63
	0.16 – 0.25	TA25DU0.25	
	0.25 – 0.4	TA25DU0.4	
	0.4 – 0.63	TA25DU0.63	
	0.63 – 1.0	TA25DU1.0	
	1.0 – 1.4	TA25DU1.4	
	1.3 – 1.8	TA25DU1.8	
	1.7 – 2.4	TA25DU2.4	
	2.2 – 3.1	TA25DU3.1	
	2.8 – 4.0	TA25DU4.0	
	3.5 – 5.0	TA25DU5.0	
	4.5 – 6.5	TA25DU6.5	
	6.0 – 8.5	TA25DU8.5	
	7.5 – 11	TA25DU11	
	10 – 14	TA25DU14	
	13 – 19	TA25DU19	
18 – 25	TA25DU25		
24 – 32	TA25DU32		
A30 – A40	18 – 25	TA42DU25	78
	22 – 32	TA42DU32	
	29 – 42	TA42DU42	
A(E)50 – A(E)75	18 – 25	TA75DU25	102
	22 – 32	TA75DU32	
	29 – 42	TA75DU42	
	36 – 52	TA75DU52	
	45 – 63	TA75DU63	
A(E)95 – A(E)110	60 – 80	TA75DU80	135
	29 – 42	TA80DU42	
	36 – 52	TA80DU52	
	45 – 63	TA80DU63	
	60 – 80	TA80DU80	
	65 – 90	TA110DU90	165
	80 – 110	TA110DU110	

^① To select an overload relay for BC9 – BC30 contactors, delete the "A" from the catalog number. Ex.: BC9-30-01-04 contactors with setting range of 1.3 – 1.8: OLR catalog number will be T25DU1.8

Accessories for Overload relays

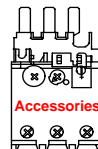

DB25/25A



DB80



DB200

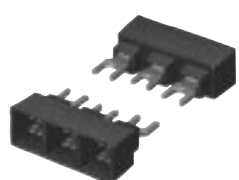

LC26-B1

Separate mounting kits

For O/L relays	Amps	Catalog number	List price
TA25DU	0.1 – 25	DB25/25A	\$ 30
TA25DU	24 – 32	DB25/32A	38
TA42DU, TA75DU, TA80DU	18 – 80	DB80	45
TA110DU	100 – 200	DB200	60

Flat pin terminal blocks

Mounting on:	Catalog number	List price
TA25DU relay	LC30-T	\$ 6
DB25/25A or DB25/32A	LC26-B1	6

Terminal block— AWG #8 cable

Mounting on:	Catalog number	List price
TA25DU (25A or less) or DB25/25A	DX25	\$ 15

Description

LC terminal blocks can be used to convert standard connections into Faston connections: 2 x 6.3 mm or 4 x 2.8 mm per pole. The connections are protected against accidental contact.

The LC30-T has a terminal block for the 3 power terminals and a second for the 4 auxiliary terminals of a TA25 DU thermal O/L relay.

The LC26-B1 has two identical terminal blocks each for 3 power terminals. This block allows the power terminals to be mounted with two DB25 kits or a TA25DU thermal O/L relay and DB25 kit assembly.

NOTE: According to DIN 46429 part 1 and NFC 20-120 the max. capacity of a Faston connection is 25 A.

AC 1030 – 6/98

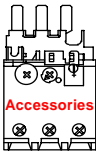

Accessories for Overload relays

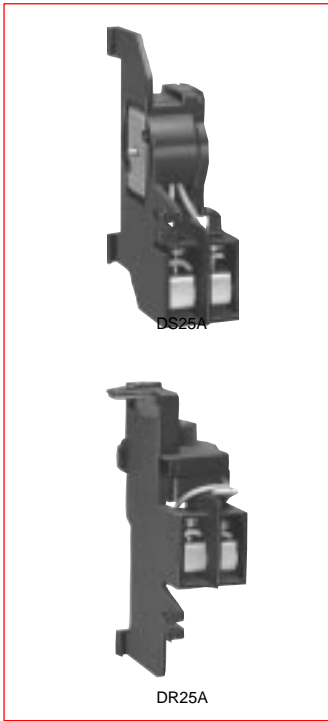

Remote tripping coils

	U voltage at 50/60 Hz	Catalog number	List price
DS25-A remote tripping coil	24V	DS25-A-24	\$ 60
	48V	DS25-A-48	
	110V	DS25-A-110	
	220/380V	DS25-A-220/380	
	500V	DS25-A-500	
DS25-A remote resetting coil	24V	DR25-A-24	
	48V	DR25-A-48	
	110V	DR25-A-110	
	220/380V	DR25-A-220/380	
	500V	DR25-A-500	

Application

- The DS25-A coil is used for remote electrical tripping of the TA25 DU thermal O/L relay and is connected to the relay's normally closed 95-96 auxiliary contact.
- The DR 25-A coil is used for remote electrical resetting of the TA25DU thermal O/L relay which is adjusted for "Manual resetting"; it is connected to the relay's normally open 97-98 auxiliary contact.

The coils are not designed for continuous duty. Impulse duration: 0.2 to 0.35 s.

Set the button to "Man" (Manual resetting).

Mounting: clipped on to TA25DU thermal O/L relay.

Installation diagrams

For connection of DS25-A to TA25DU relay

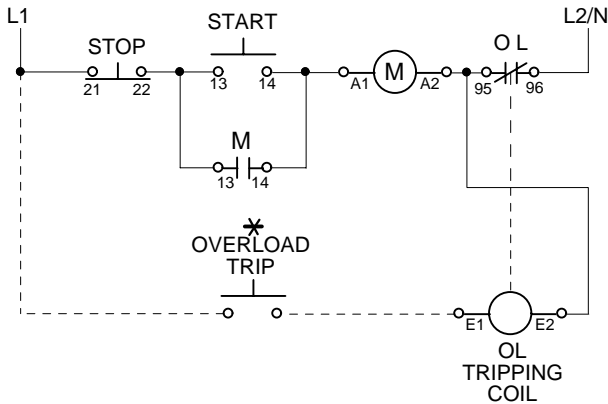

For connection of DR25-A to TA25DU relay

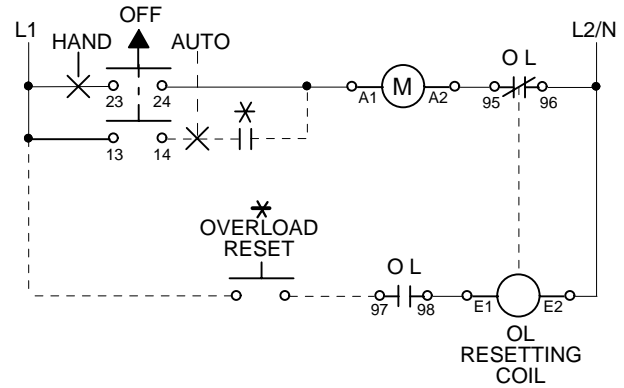
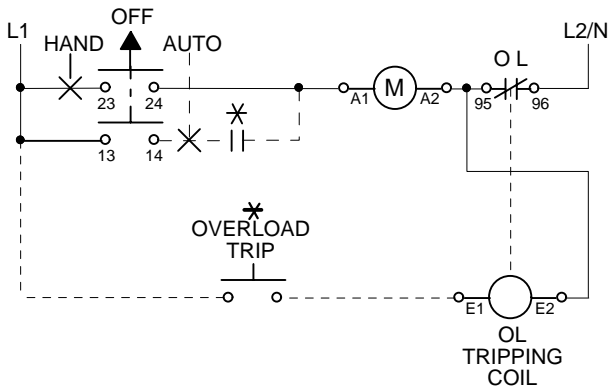
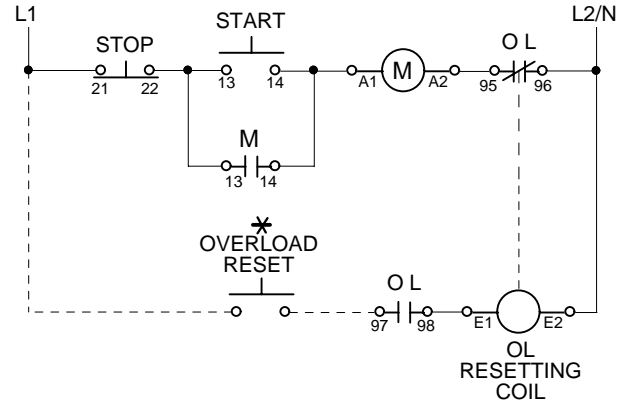

Technical data for Overload relays TA25DU – TA110DU

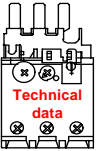

Intermittent duty

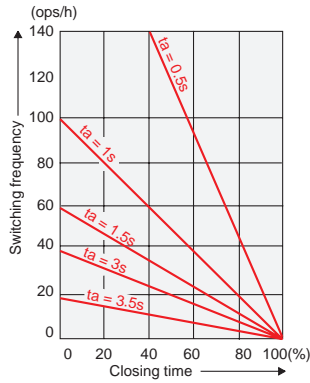

Switching frequency
in relation to load factor.
 t_a : motor starting time

Switching frequency

To avoid nuisance tripping, TA and T thermal O/L relays have been designed to withstand roughly 15 switching operations per hour with an approximately equal distribution between working and rest cycles.

In these conditions, the motor starting time must not exceed 1 second and the starting current must be lower than or equal to 6 times the motor I_n .

For intermittent operations, the diagram opposite specifies relay operating limits.

Example: Motor starting time: 1 sec.
Load factor: 40 %
Switching frequency: 60 ops./h according to diagram

Tripping limits at ambient temperatures varying by + 20°C

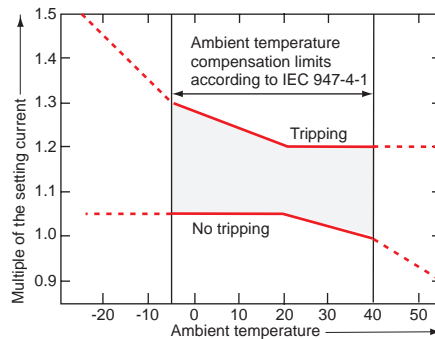

Ambient temperature compensation

Thermal O/L relays are compensated against ambient temperature variations by a compensation bimetal which is sensitive to the ambient temperature.

Thermal O/L relays are designed to operate between -5°C and $+40^{\circ}\text{C}$ in compliance with standard IEC947-4-1. For a wider range of -25°C to $+55^{\circ}\text{C}$ consult the graph opposite.

Example: tripping at -25°C . Tripping takes place before 1.5 times the setting current.

Resetting: TA25DU – TA110DU thermal O/L relays have convertible manual/automatic resetting.

Delivery: in manual resetting mode.

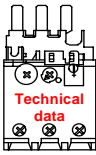

Technical data for Overload relays TA25DU – TA110DU

General technical data

Types	TA25DU	TA42DU	TA75DU	TA80DU	TA110DU
Standards: (main standards: international, European and national)	UL, CSA, IEC947-4-1, VDE0660, NF C63 650, BS4941, EN60947-4-1				
Rated insulation voltage U_i according to IEC947-4-1	600V (UL); 690V (IEC)				
Rated impulse withstand voltage U_{imp} according to IEC947-4-1	6				
Permissible ambient temperature — for storage — with compensation	-40 to +70 -25 to +55 (maximum values: see page 3.7)				
Climatic withstand DIN 50017	Humidity in alternate climate KFW, 30 cycles				
Mounting positions	①				
Shock withstand at nominal I_n Critical direction of shocks A1, A2	shock duration ms multiples of g				
	15				
	12				
Resistance to vibrations (±1 mm, 50 Hz)	multiples of g				
	8				
Mounting — on contactor — separate with DB - kit	Latching below the contactor, screw fixing on main terminals Using screws: 2 x M4 or 35 mm EN50022				
Terminals and cross-sectional areas for main conductors (motor side) • screw terminal — with cable clamp — via tunnel connector — flat type for lug or busbar • conductor cross-sectional area — rigid solid or rigid stranded — flexible with cable end — recommended busbars	TA25DU setting ranges: from 0.1-0.16A to 18-25 A		TA25DU setting ranges: 24-32 A		
	M4 — —	M5 — —	M6 — —	M6 — —	M6 — —
	HC, M8 — —				
	AWG mm ² mm	16 – 8 2 x 1.5 – 6 2 x 1.5 – 4	16 – 8 1 x 10 2 x 0.75 – 6	8 – 1 — —	8 – 1 1 x 2.5 – 35 or 2 x 2.5 x 16 1 x 2.5 – 25 or 2 x 2.5 x 10
					8 – 1 — —
					6 – 1 16 – 35 16 – 35 12 x 3
Terminals and cross-sectional area for auxiliary conductors • screw terminal (screw size) — with cable clamp • conductor cross sectional area — rigid solid or rigid stranded	AWG				
	M 3.5				
	2 x 18 – 24				
Degree of protection according to IEC144, IEC529 DIN 40 050, NFC20-010 and VDE110/Part. 106	②				③
Pole characteristics					
Number of poles	3				
Setting ranges	see page 3.4				
Tripping class according to IEC947-4	10A				
Operating frequency	Hz				
	0 – 400				
Tripping frequency without untimely tripping	Up to 15 ops./h or 60 ops./h with 40 % load factor when neither the starting current of $6 \times I_n$ nor the starting time 1s are exceeded.				
Resistance per phase in mΩ and heat dissipation in W at the maximum current setting	see page 3.9				
Protection fuses co-ordination with short circuit protection devices	To be sized per NEC Article 430-152				

① On a support at an angle of ±30° in relation to the vertical plane (standard position). Other positions possible except mounting on a horizontal plane (in this case the tripping mechanism would be located above the bimetals).
 ② All the terminals are protected against direct contact according to VDE0106/Part. 100. (without additional terminal shrouds).
 ③ All the terminals are protected against direct contact according to VDE0106/Part. 100. (with additional terminal shrouds).

Technical data for Overload relays TA25DU – TA110DU

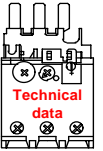

Auxiliary contacts		Normally Closed N.C.	Normally Open N.O.	
Terminal marking		95 – 96	97 – 97	
Rated insulation voltage U_i	VAC	500	500	
Conventional thermal current (in free air) I_{th}	A	10	6	
Rated operation current I_e , AC-15	up to 240V	3.0	1.5	
	up to 440V	1.9	0.95	
	up to 500V	1.0	0.75	
Rated operational current I_e , DC-13	up to 250V	A	0.12	0.04
Protection against short circuits gG (gl) fuses (according to IEC269 S271/S 281 circuit breaker	A	10	6	
	A	k3	k1	
Maximum potential difference between N.C. and N.O. auxiliary contacts	VAC	500	500	
	VDC	440	440	

Resistance and Joule Loss per phase

TA25DU Thermal O/L relay

Setting range	Resistance per phase	Joule loss per phase at max. setting current
from – to A A	mΩ	W
0.1 – 0.16	85850.0	2.2
0.16 – 0.25	85150.0	2.2
0.25 – 0.4	13750.0	2.2
0.4 – 0.63	5370.0	2.2
0.63 – 1.0	2190.0	2.2
1.0 – 1.4	1120.0	2.2
1.3 – 1.8	670.0	2.2
1.7 – 2.4	383.0	2.2
2.2 – 3.1	229.0	2.2
2.8 – 4.0	137.0	2.2
3.5 – 5.0	87.5	2.2
4.5 – 6.5	61.0	2.2
6.0 – 8.5	30.4	2.2
7.5 – 11	18.2	2.2
10 – 14	11.2	2.2
13 – 19	6.3	2.3
18 – 25	4.7	2.9
24 – 32	3.2	3.3

TA42DU Thermal O/L relay

Setting range	Resistance per phase	Joule loss per phase
A – A	mΩ	W
18 – 25	5.5	3.43
22 – 32	2.89	2.91
29 – 42	1.84	3.24

TA75DU Thermal O/L relay

18 – 25	5.5	3.43
22 – 32	2.89	2.91
29 – 42	1.84	3.24
36 – 52	1.3	3.51
45 – 63	0.936	3.72
60 – 80	0.615	3.94

TA80DU Thermal O/L relay

29 – 42	1.84	3.24
36 – 52	1.3	3.51
45 – 63	0.936	3.72
60 – 80	0.615	3.94

TA110DU Thermal O/L relay

80 – 100	0.378	3.78
----------	-------	------

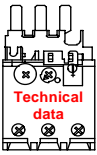

Tripping curves for Overload relays TA25DU – TA110DU

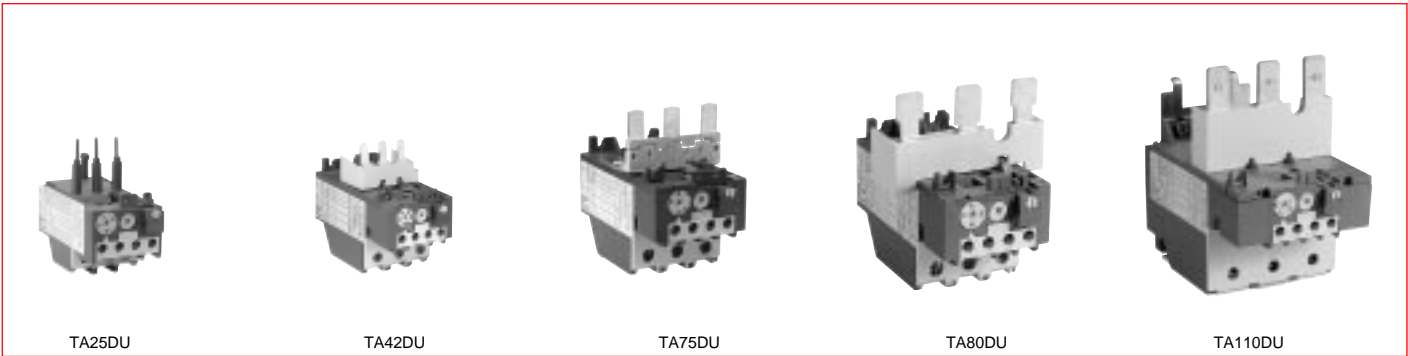

TA-DU and **T-DU** thermal O/L relays are 3 pole with manual or automatic resetting mode selection. The reset button can also be used for stopping.

Built in auxiliary contacts are physically separate and, consequently, can be used in different circuits (control circuit/indication circuit).

Each relay is temperature compensated and ensures phase failure protection.

Protective relays up to size TA75DU are protected against direct contact from the front face.

The connecting terminals are delivered in open position with (+,-) posidrive screws and screwdriver guidance. It is advisable to tighten unused terminal screws.

Thermal O/L relay tripping curves

TA25DU, T25DU
(tripping class 10A)

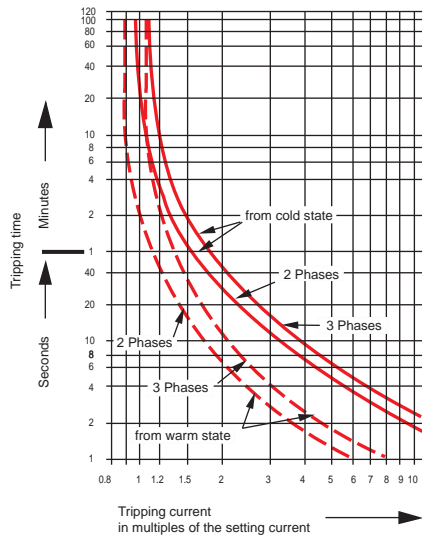

TA42DU, TA75DU and TA80DU
(tripping class 10A)

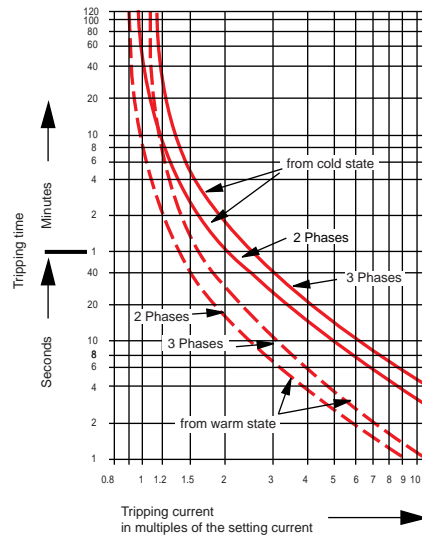

TA110DU
(tripping class 10A)

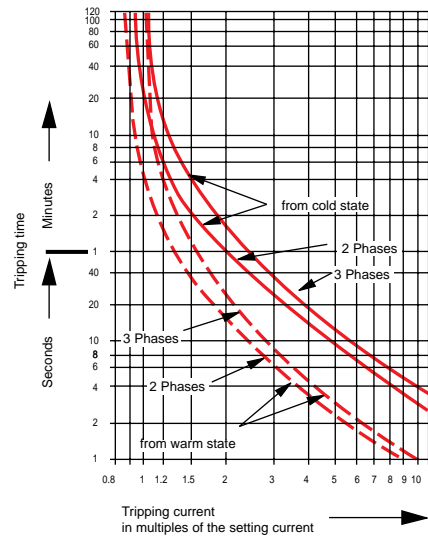

Overload relays

Approximate dimensions for Overload relays T25DU – TA110DU

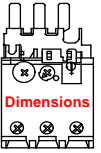

00.00 Inches
00.00 Millimeters

TA25DU

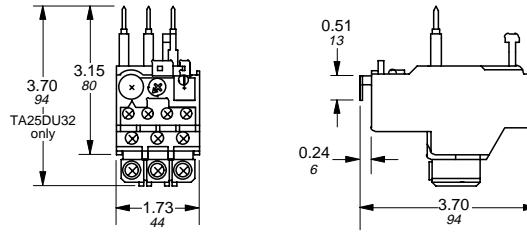

TA42DU

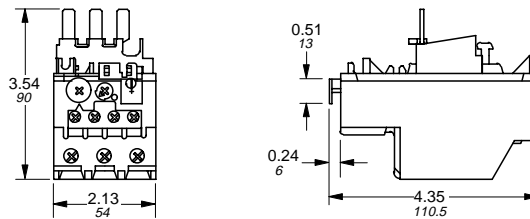

TA75DU & TA80DU

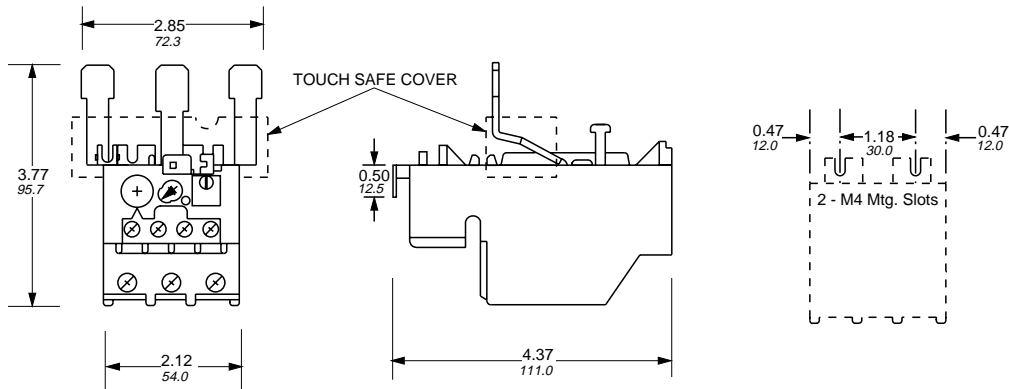

TA110DU

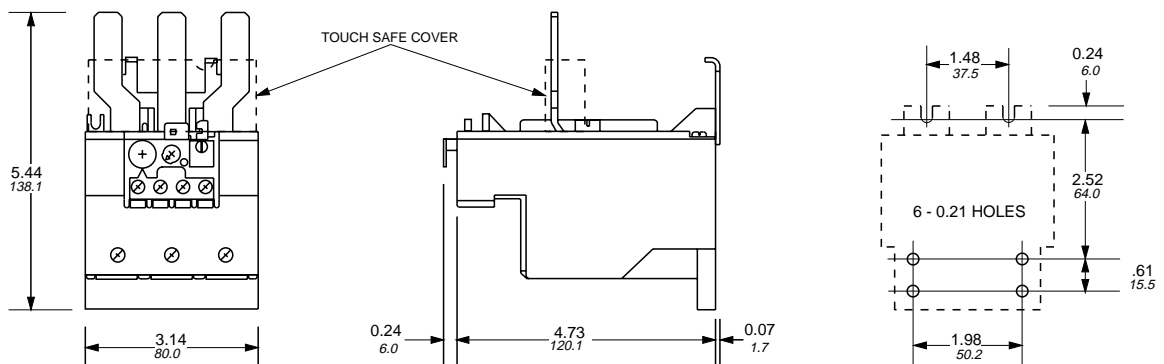

Overload relays

AC 1030 – 6/98

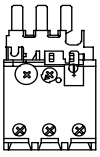

Approximate dimensions for Separate mounting kits TA25DU – TA75DU

00.00 Inches
00.00 Millimeters

TA25DU & AB25

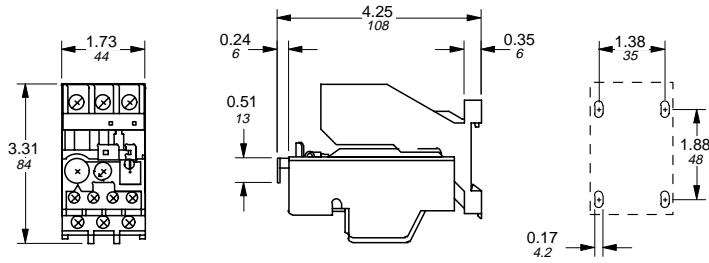

TA25DU32 & AB32

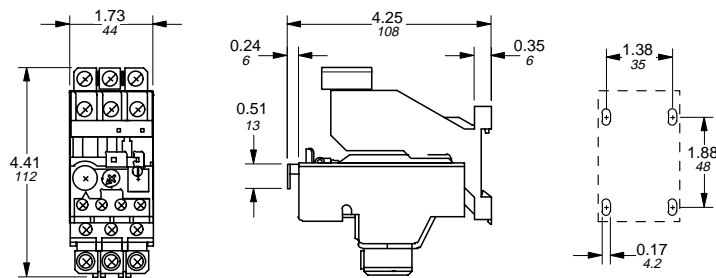

TA42DU / TA75DU & AB80A

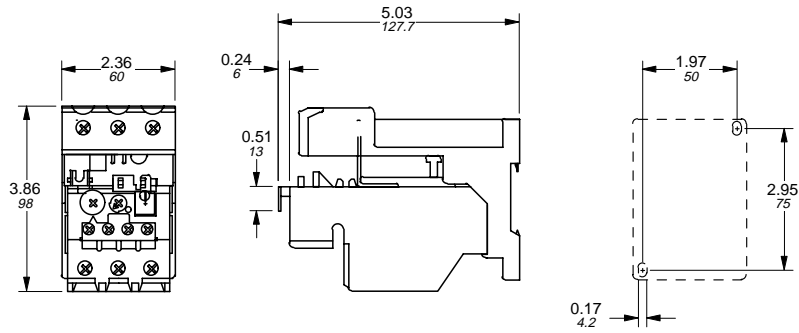

Overload relays



Control relays Type N & KC Positive safety



Description

- A.C. or D.C. operated
- DIN rail or panel mounting
- 600 volt heavy duty design, A600-10 amp, Q300-5 amp
- Snap-on accessories available:
 - 1 & 4 pole adder deck
 - Pneumatic on & off delay timer
 - Mechanical latch
- Coils are easily interchangeable
- NEMA, UL, IEC, CSA, VDE and most other international standards
- Fixed contacts are double break type for positive contact on low current applications
- Terminals supplied in open position for ease of wiring
- Touch safe design: All connection terminals are protected against accidental touch
- Terminal screws are captive with saddle type clamps for fast wiring and are easily accessible from the front
- Screwdriver guide holes

Positive safety relays

There are many applications where safety is very critical and it is important to use electrical equipment which ensures that dangerous machine movement cannot occur when a fault is detected with the moving contacts during the cycle which the fault is indicated.

Regulations and standards have been written to ensure that safety is maintained:

- | | |
|------------------|--------------------------------------|
| • United States | ANSI B11.19-1990
ANSI B11.20-1991 |
| • Germany | SÜVA
ZH1/457 |
| • France | INRS |
| • United Kingdom | BIA |
| • Switzerland | SA |

The ABB Type N & KC 4 and 8 pole relays are designed with "Positive Guided" contacts and fulfill the regulations or standards shown. The relays can provide positive safety for the N.O. and N.C. contacts which assure that the N.O. contacts will not close before any N.C. contact opens. Therefore, if one of the contacts weld due to abnormal conditions in the control circuit, the other contacts will also remain in the same position as when the welding occurred. This means that the open contacts must maintain an air distance 0.5mm when the coil is energized at 110% Vc or when it is de-energized.

Index

- | | |
|-------------------------------------|------|
| • Features | 4.1 |
| • Description | 4.2 |
| • Selection, AC & DC operated | 4.4 |
| • Accessories | 4.5 |
| • Technical data | 4.8 |
| • Approximate dimensions | 4.11 |



Description for Control relays Type N

Application

Type N control relays are used for switching auxiliary circuits and control circuits.

Description

- AC operated with laminated magnetic circuit.
- 2 versions: 4 pole or 8 pole. The width of 8 pole devices is identical to that of 4 pole devices; only the depth is increased.
- Side by side mounting possible.
- Self cleaning auxiliary contacts.
- Alone or by itself or with a 4 pole CA5 auxiliary contact block, these devices offer “positive safety” between their auxiliary contacts.

Holes for screw mounting (screws not supplied). Distances between holes according to EN50 002.

Quick mounting on 35 x 7.5 mm DIN mounting rail according to IEC715 and EN50 022.

Location of side mounted accessories: mounting on right or left hand side.

Terminals delivered in open position with captive screws (screws of unused terminals should be tightened). Screwdriver guidance for all screws makes it possible to use motorized screwdrivers.

All terminals provide protection against accidental direct contact with live parts according to VDE0106 – Part. 100 and offer IP 20 degree of protection according to IEC947-1.

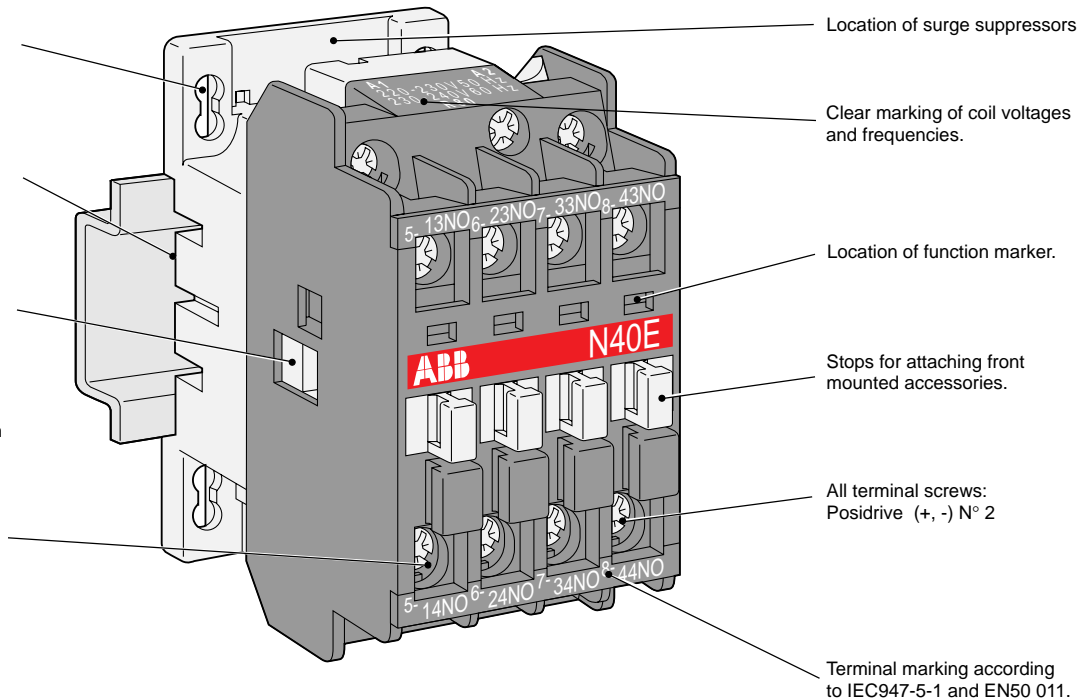

Location of surge suppressors

Clear marking of coil voltages and frequencies.

Location of function marker.

Stops for attaching front mounted accessories.

All terminal screws: Posidrive (+, -) N° 2

Terminal marking according to IEC947-5-1 and EN50 011.

Catalog number explanation

N 40E-84

Frame type

Coil voltage

(see coil voltage chart below)

Contact configuration

Coil voltage selection chart

Hz	Rel. type	Volts															
		12	24	48	110	120	125	208	220	240	277	380	415	440	480	500	600
60	N		81	83	84	84		34	75	80	42	48	86	86	51	53	55
50	N		81	83	84				80			85	86			55	
DC	EC-KC	07	01	16	04		27		05	33							

For other voltages, see page 1.13

Description for Control relays Type KC

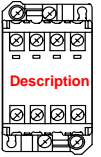

Application

KC control relays are used for switching auxiliary circuits and control circuits.

Description

- Magnetic circuit variants:
 - KC types: d.c. operated with solid magnetic circuits.
- 2 versions: 4 pole or 8 pole
The width of 8 pole devices is identical to that of 4 pole devices; only the depth is increased.
- Bifurcated auxiliary contacts.
- Alone or mounted with a 4 pole CA5 auxiliary contact block, these devices offer "positive safety" between their auxiliary contacts.

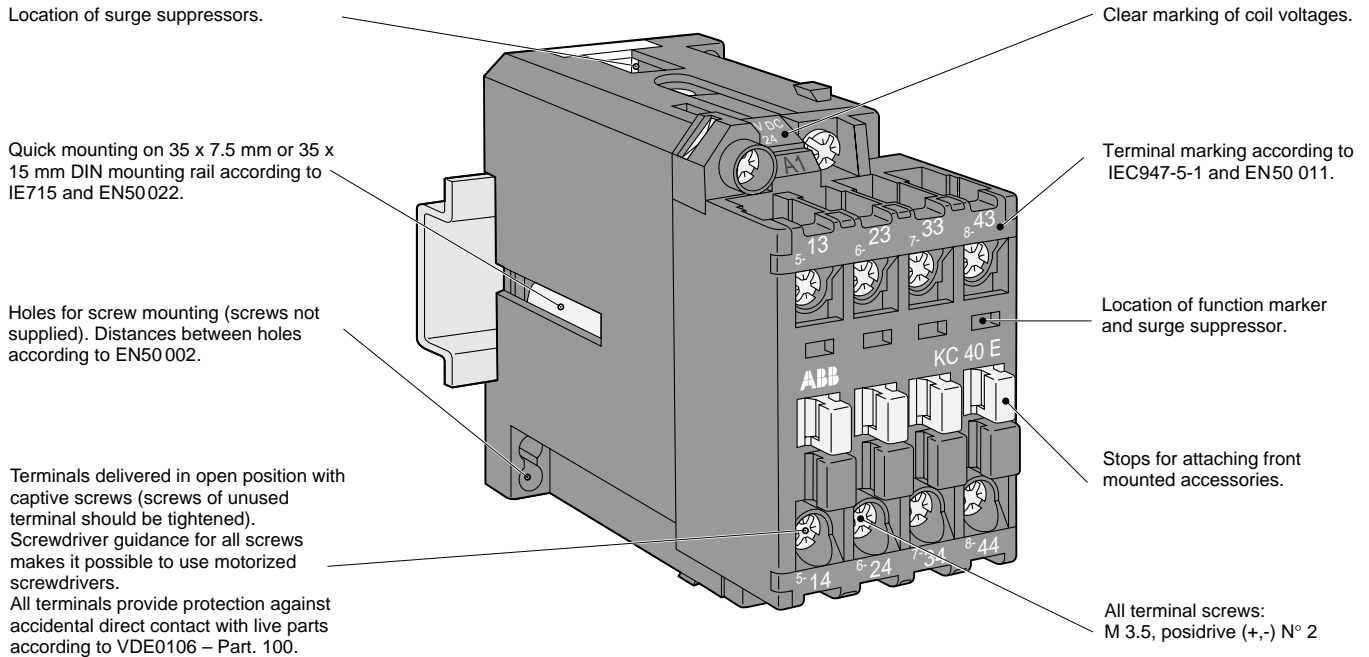

Catalog number explanation

KC 44E-84



Coil voltage selection chart

Hz	Rel. type	Volts															
		12	24	48	110	120	125	208	220	240	277	380	415	440	480	500	600
60	N		81	83	84	84		34	75	80	42	48	86	86	51	53	55
50	N		81	83	84			80				85	86			55	
DC	BC-KC	07	01	16	04		27		05	33							

For other voltages, see page 1.13



Control relays Type N & KC



N40E-1

KC22-E

A.C. operated

Contact configuration		Catalog number	List price
N.O.	N.C.		
4	0	N40E-84	\$ 60
3	1	N31E-84	
2	2	N22E-84	
4	4	N44E-84	120
5	3	N53E-84	
6	2	N62E-84	
7	1	N71E-84	
8	0	N80E-84	

D.C. operated

Contact configuration		Catalog number	List price
N.O.	N.C.		
4	0	KC40E-04	\$ 72
3	1	KC31E-04	
2	2	KC22E-04	
4	4	KC44E-04	144
6	2	KC62E-04	

Coil voltage selection

All AC operated catalog numbers include a 120VAC coil. All DC operated catalog numbers include a 110VDC coil. To select other coil voltages, substitute the code from the Coil Voltage Selection Chart for the first digit after the last dash in the catalog number.

Ex.: A 240V coil is required for an N80 control relay: N80E-**80**

Coil voltage selection chart

Hz	Rel. type	Volts															
		12	24	48	110	120	125	208	220	240	277	380	415	440	480	500	600
60	N	81	83	84	84		34	75	80	42	48	86	86	51	53	55	
50	N	81	83	84				80			85	86			55		
DC	BC-KC	07	01	16	04	27		05	33								

For other voltages, see page 1.13

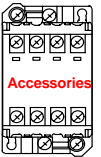

Accessories for Control relays Type N & KC

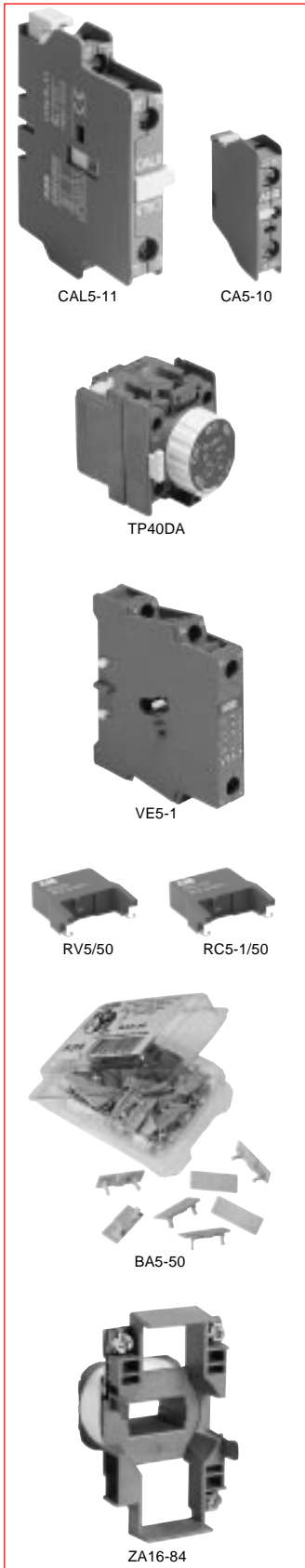

Auxiliary contact blocks

Positioning	Contacts		Catalog number	List price
	N.O.	N.C.		
Front face	1	—	CA5-10 CA5-01	\$ 15
	—	1		
	4	—	CA5-40N CA5-22N CA5-04N	30
	2	2		
—	4			
Side	1	1	CAL5-11	

Pneumatic timers

Timing range	Contacts		Catalog number	List price
	N.O.	N.C.		
On delay 0.1 – 40s	1	1	TP40DA TP180DA TP40IA TP180IA	\$ 108
On delay 10 – 180s	1	1		
Off delay 0.1 – 40s	1	1		
Off delay 10 – 180s	1	1		

Interlocks

Feature	Contacts		Catalog number	List price
	N.O.	N.C.		
Mech./elec.	—	2	VE5-1	\$ 45
Mechanical	—	—	VM5-1	21

Surge suppression devices for Type N control relays

Feature	Voltage range	Catalog number	List price
Varistor	24 – 50 VAC	RV5/50	\$ 30
	50 – 133 VAC	RV5/133	
	110 – 250 VAC	RV5/250	
	250 – 440 VAC	RV5/440	
RC	24 – 50 VDC	RC5-1/50	\$ 30
	50 – 133 VDC	RC5-1/133	
	110 – 250 VDC	RC5-1/250	
	250 – 440 VDC	RC5-1/440	

Identification marker

Feature	Catalog number	List price
Pack of 50	BA5-50	\$ 15

Surge suppressors — for Type KC control relays

Volts (VDC)	Catalog number	List price
24 – 60	RV-BC6/60	\$ 26
50 – 250	RV-BC6/250	
200 – 420	RV-BC6/380	

Coils

	Type N Relay		Type KC Relay	
	Catalog number	List price	Catalog number	List price
	ZA16-★	\$ 24	KBC30-★	\$ 60

★ Select the coil voltage from the Control Relay Coil Voltage Selection chart and substitute the letter code for the ★ as the last digit in the catalog number.

Coil voltage selection chart

Hz	Rel. type	Volts															
		12	24	48	110	120	125	208	220	240	277	380	415	440	480	500	600
60	N		81	83	84	84		34	75	80	42	48	86	86	51	53	55
50	N		81	83	84				80			85	86			55	
DC	BC-KC	07	01	16	04		27		05	33							

For other voltages, see page 1.13

Control relays



Accessory mounting information for Control relays Type N

4 Pole, N control relays

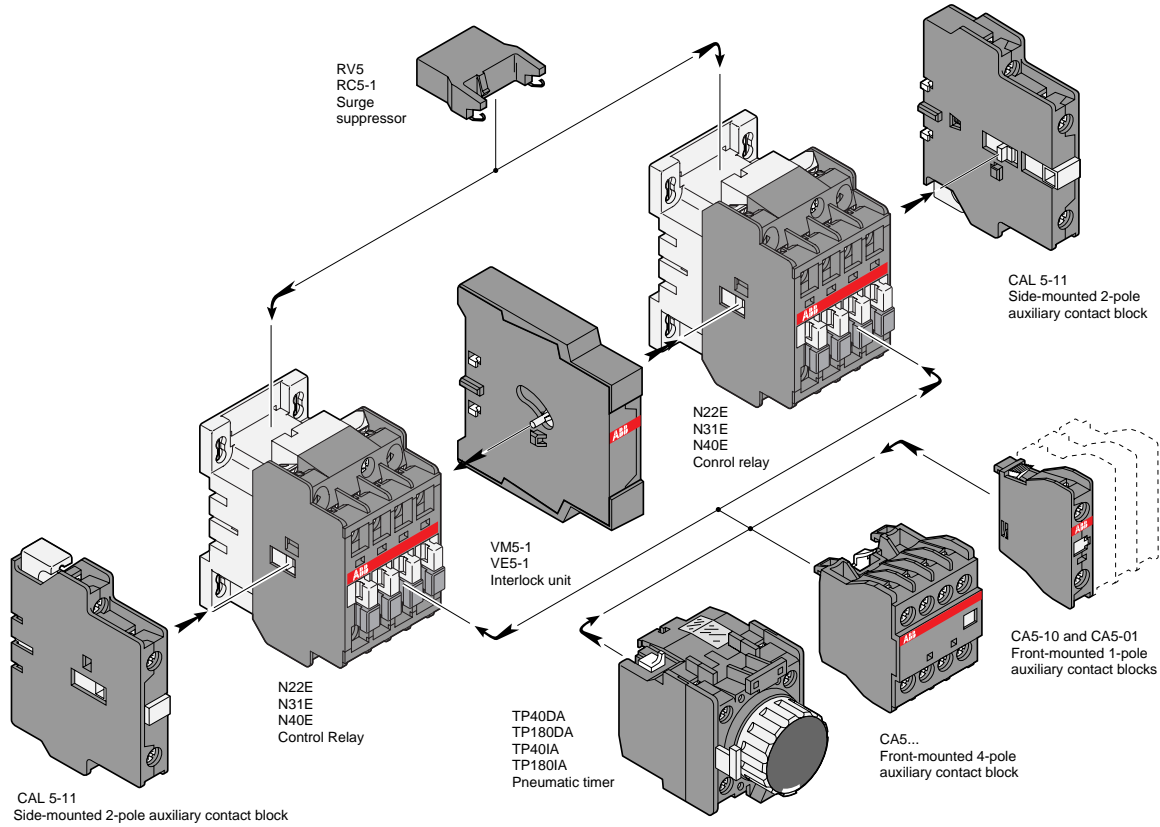

8 Pole, N contactor relays

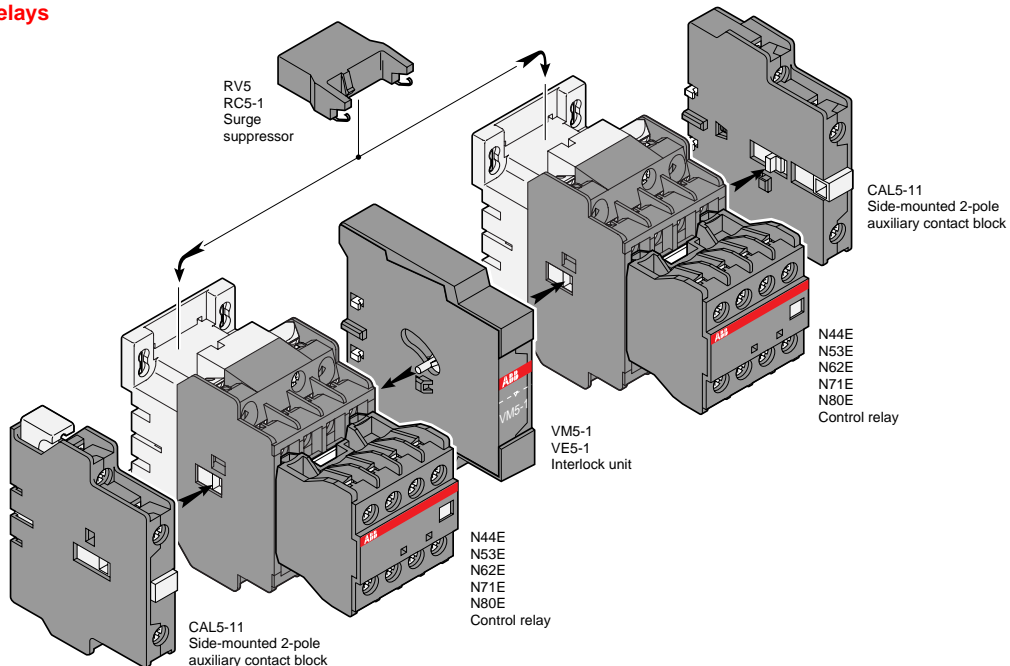

Control relays

Accessory mounting information for Control relays Type KC

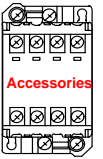

4 Pole, KC control relays

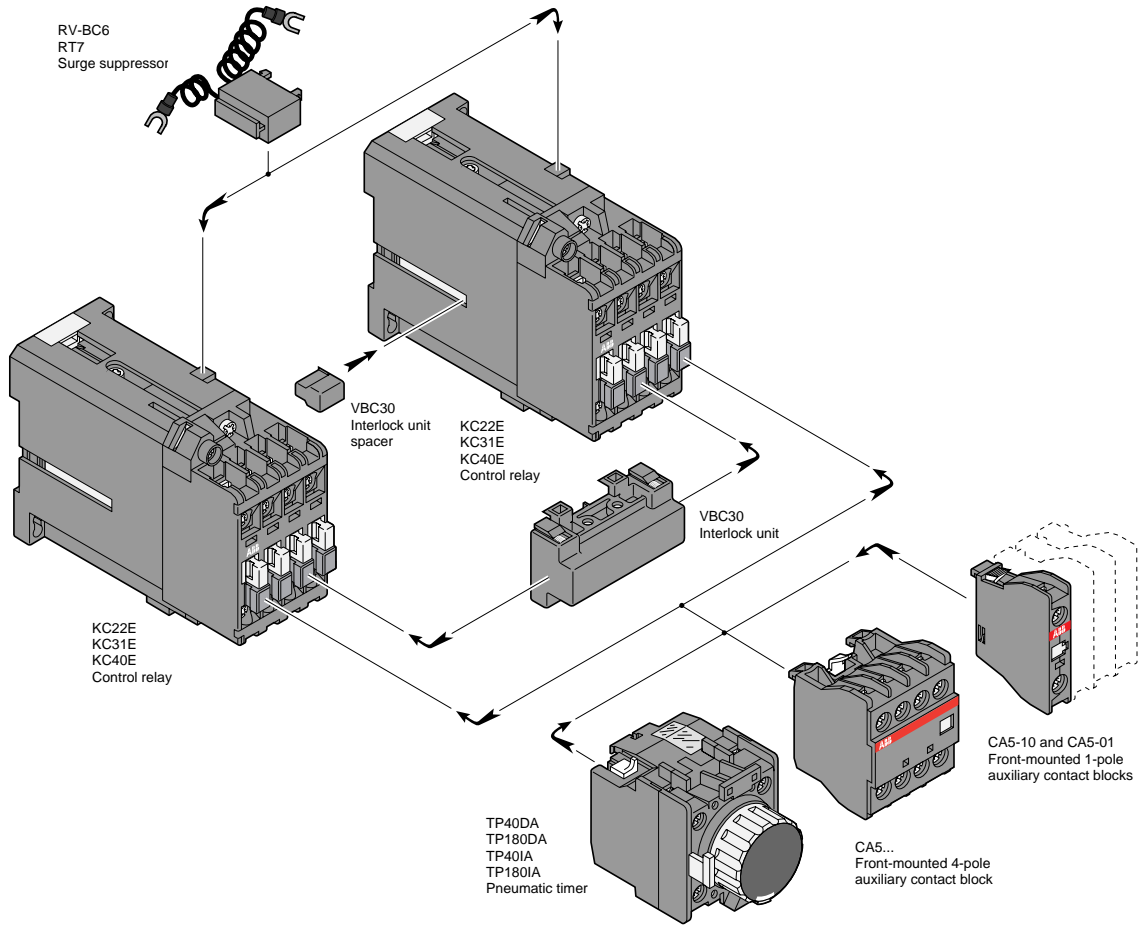

8 Pole, KC control relays

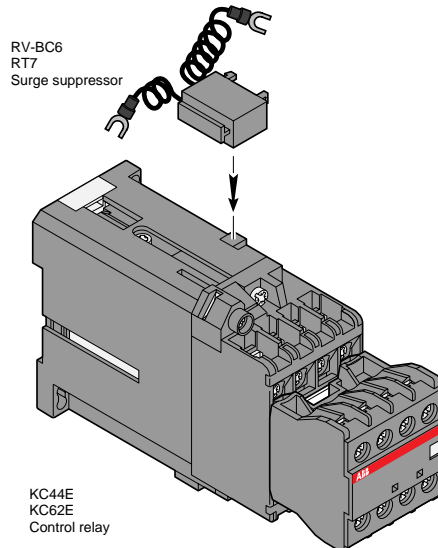



UL & CSA Technical data for Control relays

AC inductive ratings — NEMA A600

Voltage	Continuous current	Maximum make	Maximum break
120V 240V 480V 600V	10	7200VA	720VA

DC inductive ratings — NEMA P300

Voltage	Continuous current	Maximum make	Maximum break
120V 250V 300-600V	5	138VA	138VA

AC coil consumption

In rush	Sealed
80VA	8VA

DC coil consumption

In rush	Sealed
7.0W	7.0W

AC operating time

Pickup	Dropout
10 – 20ms	10 – 20ms

DC operating time

Pickup	Dropout
30 – 90ms	10 – 20ms

AC mechanical endurance 30 million operations

DC mechanical endurance 30 million operations

Pole configuration schematics

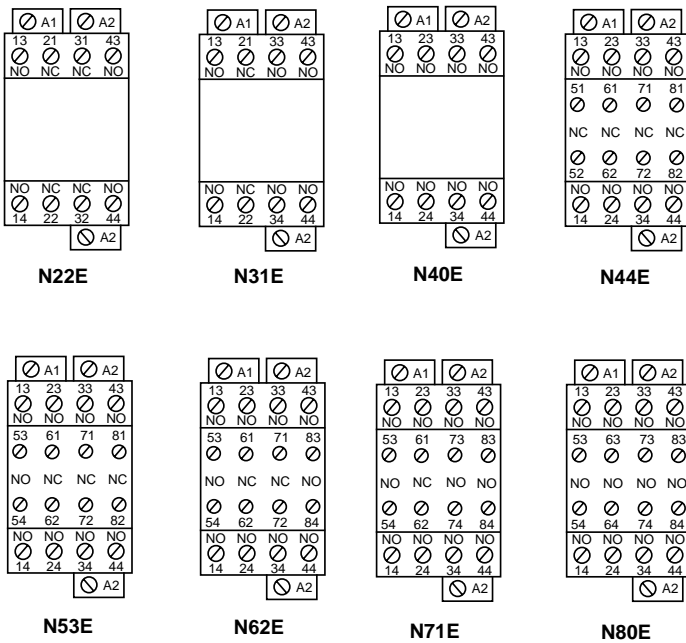

4 Pole control relay

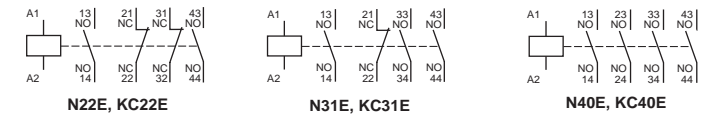

4 Pole control relay with 4 pole adder deck

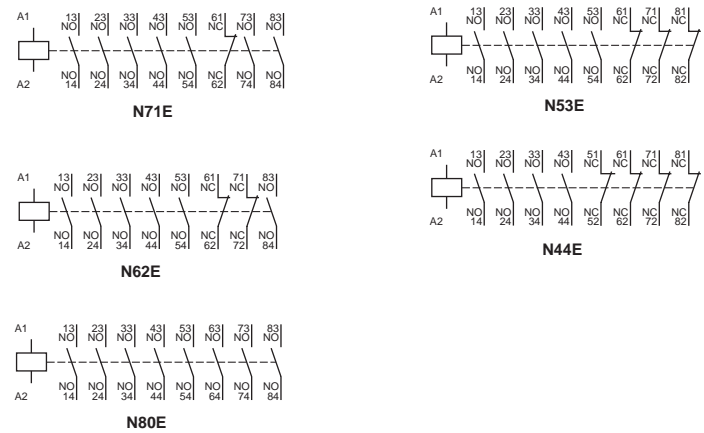

IEC Technical data for Control relays

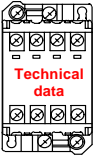

Type	N22, N31, N40	N44, N53, N62, N71, N80	KC22, KC31, KC40	KC44, KC62
Number of poles	4	8	4	8
Insulation characteristics				
Rated insulation voltage U_i acc. to IEC947-5-1 and VDE0110 (Gr. C) acc. to UL/CSA	V	690		
	V	600		
Rated impulse withstand voltage U_{imp} acc. to IEC947-5-1	kV	8		
General technical data				
Standards	Devices complying with international standards IEC947-5-1/947-4-1 and European standards EN60 947-5-1/60 947-4-1 Electromagnetic compatibility (EMC) according to amendment A11 to IEC947-1; EN60 947-1 and amendment 2 to IEC947-4-1			
Air temperature near contactor — for operation in free air: — for storage:	°C	-40 to +55 (0.85 – 1.1 U_o) / +55 to +70 (U_o) -60 to +80		
Climatic withstand	according to IEC68-2-30 and 68-2-11 – UTE C63-100, Specification II			
Mounting positions: (see diagrams below)	Positions 1 to 5	- $\theta \leq 55^\circ\text{C}$: 0.85 – 1.1 U_o - $\theta = 55 - 70^\circ\text{C}$: — U_o		
	Position 6	- $\theta \leq 55^\circ\text{C}$: 0.95 – 1.1 U_o - $\theta > 55^\circ\text{C}$: not acceptable		
Operating altitude	m	≤ 3000		
Shock withstand according to IEC 68-2-27 and EN 60068-2-27 Mounting pos. 1 (see below)		1/2 sinusoidal shock, 11ms: no change in contact position Shock direction: A, C1, C2 : 20 g B1 : 5 g B2 : 15 g		
Fixing — on mounting rail — with screws (not supplied)	35mm according to IEC715 and EN50022 2 x M4			
Connection terminals (delivered in open position, screws of unused terminals must be tightened)	M 3.5 (+,-) posidrive 2 screw with cable clamp			
Connection capacity Rigid solid	1 x AWG 2 x AWG	16 – 12 16 – 12		
Degree of protection according to IEC529, IEC947-1 and EN60529 — Pole terminals — Coil terminals	IP20 IP20		IP10 IP20	

Mounting positions

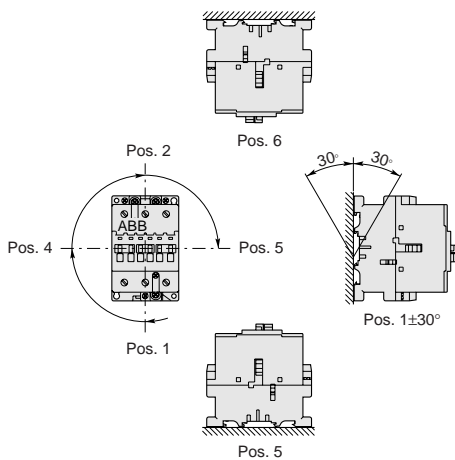

Electrical durability of contacts

utilization category AC – 15 according to IEC947-5-1
making current: 10 x I_o with $\cos \varphi = 0.7$ and U_o
breaking current: I_o with $\cos \varphi = 0.4$ and U_o

The curves opposite show the electrical durability of the control relays as well as the add-on auxiliary contact blocks in relation to the breaking current I_o . These curves have been drawn for resistive and inductive loads up to 690V, 40 – 60 Hz.

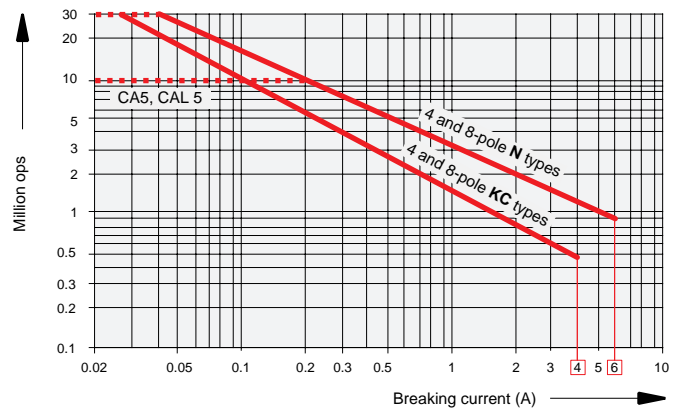

Control relays



IEC Technical data for Control relays

Type		N22, N31, N40	N44, N53, N62, N71, N80	KC22, KC31, KC40	KC44, KC62
Number of poles		4	8	4	8
Pole utilization characteristics					
Rated operational voltage U_e	V	690			
Conventional thermal current in free air I_{th} according to IEC947-5-1 $\theta \leq 40^\circ\text{C}$	A	16		10	
Rated operating current I_e in AC-15 according to IEC947-5-1					
24 – 127 V 50/60 Hz	A	6		6	
230 – 240 V 50/60 Hz	A	4		4	
400 – 415 V 50/60 Hz	A	3		3	
500 V 50/60 Hz	A	2		2	
690 V 50/60 Hz	A	2		2	
in DC-13 according to IEC947-5-1					
24VDC	A/W	6/144		6/144	
48VDC	A/W	2.8/134		2.8/134	
72VDC	A/W	1/72		1/72	
125VDC	A/W	0.55/69		0.55/69	
250VDC	A/W	0.3/75		0.3/75	
Field of rated frequencies	Hz	25 – 400			
Mechanical durability in operating cycles Max. switching frequency	cycles/h	> 20 million 6000		30 million 6000	
Electrical durability in operating cycles Max. switching frequency	cycles/h	1200			
Rated making capacity according to IEC947-5-1		10 x I_e /AC-15			
Rated breaking capacity according to IEC947-5-1		10 x I_e /AC-15			
gG (gl) protection fuse A		10			
Rated short time withstand current at ambient temp. of 40 °C, in free air, from cold state	1.0 s 0.1 s	100A 140A		50A 100A	
Insulation resistance at 500 VDC		after durability test: 5 M Ω			
Min. switching capacity with failure rate below 10 ⁻⁶		17V / 5mA		24V / 5mA	
Non overlapping time between N.O. and N.C. contacts	ms	≥ 2			
Power loss per pole at 6A	W	0.10		0.15	
Magnet system characteristics					
Coil operating limits $\theta \leq 40^\circ\text{C}$		according to IEC 947-5-1 : 0.85 - 1.1 U_e			
Drop out voltage in % of U_e		roughly 40 – 65%		roughly 10 – 30%	
Coil consumption (average value)					
— a.c. operation: 50 Hz pull in	VA	70		—	
60 Hz pull in	VA	80		—	
50/60 Hz ^① pull in	VA/VA	74/70		—	
50/60Hz holding	VA/W	8/2		—	
— d.c. operation: cold pull in	W	—		7	
warm holding	W	—		7	
Rated control voltage U_c					
— AC operation: 50/60 Hz	V	20 – 690		—	
— DC operation:	VDC	—		24 – 240	
Max. permissible short supply interruption without opening of contacts	ms	2		2	
Operating time					
between coil energization and:					
— closing of N.O. contact	ms	10 – 26		50 – 75	
— opening of N.C. contact	ms	7 – 21		45 – 70	
between coil de energization and:					
— opening of N.O. contact	ms	4 – 11		15 – 30 *	
— closing of N.C. contact	ms	9 – 16		17 – 32 *	

*Using surge suppressors increases the opening time by a ratio of 1.1 to 1.5 for a varistor suppressor and by 4 to 8 for a diode suppressor.

① 50/60 Hz coils: voltage codes 80 to 88 , see page 1.13.

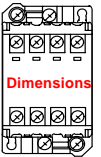

Approximate dimensions for Control relays Type N & KC, AC & DC operated

00.00 Inches
00.00 Millimeters

Type N, 4 Pole, AC Operated

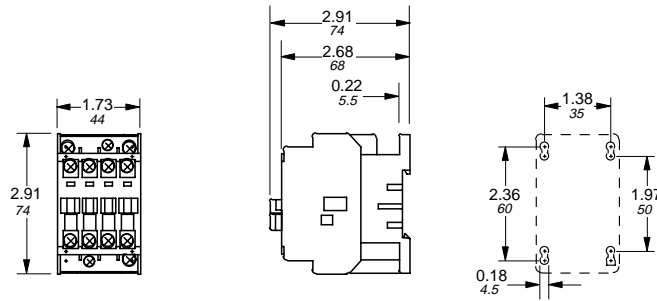

Type KC, 4 Pole, DC Operated

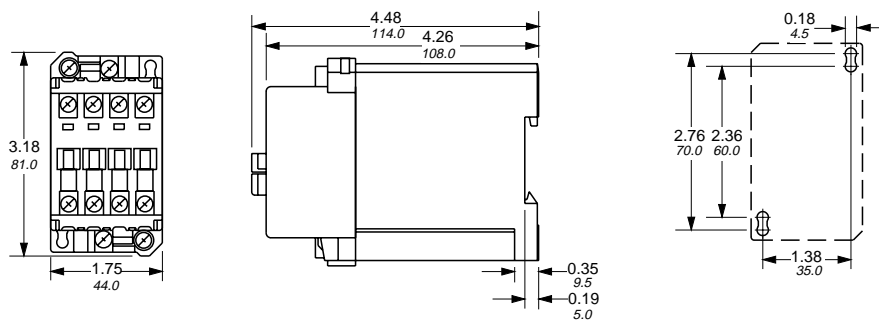

Type KC, 4 Pole with adder deck, DC Operated

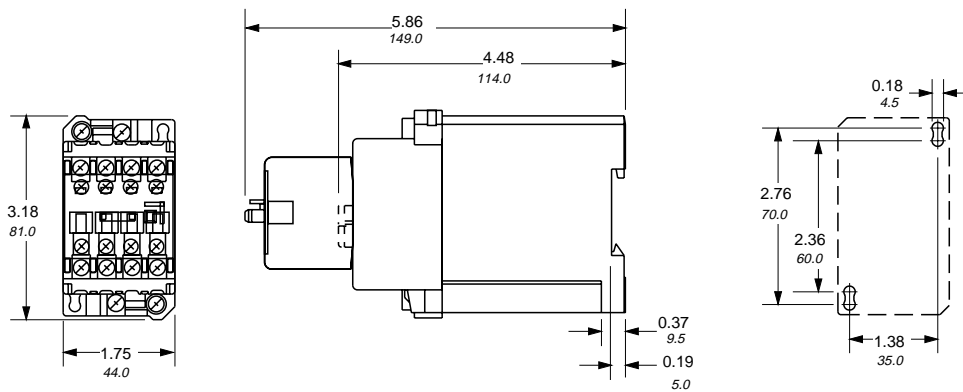

Type KC, 8 Pole, DC Operated

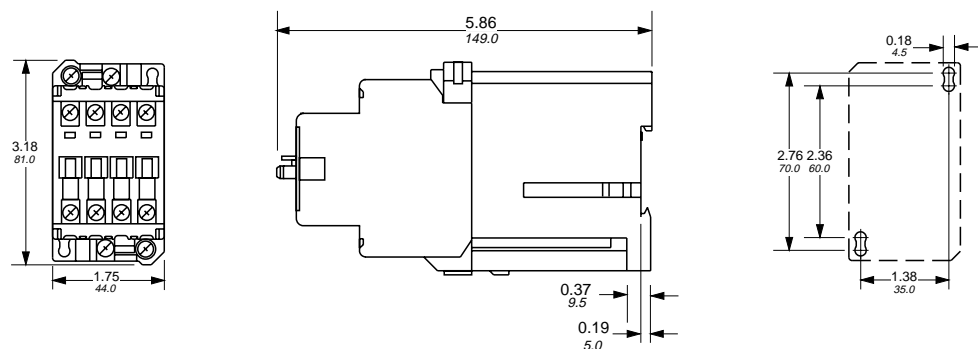

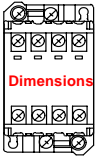

Approximate dimensions for Control relay accessories

← 00.00 Inches
 00.00 Millimeters
 →

N & KC Control relays

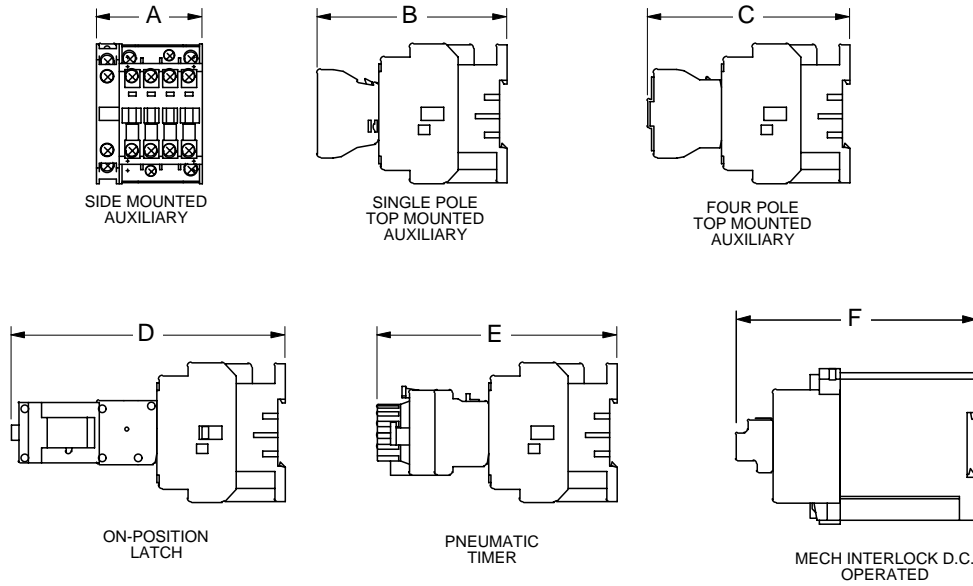

TYPE		A	B	C	D	E	F
N	IN	2.20	3.96	4.21	5.71	5.00	–
	MM	56	100.5	107	145	127	–
KC	IN	–	5.53	5.79	7.28	6.58	5.04
	MM	–	140.5	147	185	167	128

Terms & conditions

These terms and conditions govern all sales and shipments of control equipment products (including parts and accessories).

ABB Control Inc. hereby gives notice of its objection to any different or additional terms and conditions except for such as may be expressly accepted by it in writing.

Prices

Prices are subject to change without notice. Prices will be the prices in effect at the time of shipment by ABB Control Inc. and include freight, prepaid and allowed to first destination in the continental United States. In the event of a price change, the effective date of the change will be the date shown on the new price discount sheets. However, where a price change is made by letter or telegram, the effective date will be given as part of the announcement.

Taxes

The price does not include any Federal, state or local property, license, privilege, sales, use, excise, gross receipts or other like taxes which may now or hereafter be applicable. Payment by ABB Control Inc. of any such taxes shall be for the account of purchaser.

Standard terms of payment

Standard terms of payment are according to the appropriate discount schedule (AC 5000 - AC 5002).

Payment and late charges

ABB Control Inc. may require full or partial payment in advance if, in its sole judgement, the financial condition of the purchaser, at any time prior to delivery, does not merit the terms of payment specified.

If shipments are delayed by the purchaser or by reason of any of the causes referred to in the paragraph entitled "Excusable Delay", payments shall become due from the date when ABB Control Inc. is prepared to make shipment. Products held for the purchaser as a result of such delay shall be at the risk and expense of the purchaser. If the purchaser fails to pay any invoice when due, ABB Control Inc. may defer deliveries under this or any other contract with purchaser, except upon prior receipt of satisfactory security for or cash in payment of any such invoice. Failure on the part of purchaser to pay invoices when due shall at the option of ABB Control Inc. constitute a default under this contract.

A service charge, the lesser of the highest rate allowed by law or 11/2% per month, or fraction thereof, for a maximum charge of 18% per annum will be charged on all overdue accounts.

Delivery

Delivery of products shall be FOB point of shipment regardless of transportation costs being "allowed", "prepaid" or collect". Where the scheduled delivery of products and parts is delayed by the purchaser or by reason of any of the causes referred to in the paragraph entitled Excusable Delay, ABB Control Inc. may deliver such products by moving them to storage for the account of and at the risk of the purchaser. Shipping dates are approximate and are based upon prompt receipt of all necessary information from purchaser. ABB Control Inc. reserves the right to make delivery in installments.

Purchaser pick-up

No allowance will be made in lieu of transportation charges if the purchaser accepts shipment at the factory, warehouse or freight station. Transportation charges will not be deducted from the purchase price.

Origin, method of shipment and routing

ABB Control Inc. shall determine the point of origin of shipment, the method of transportation and the routing of shipment. Costs for shipment by means requested by purchaser different from ABB Control Inc.'s standard means of shipment are invoiced to the purchaser as a separate charge. Freight charges will be added to the price of any order under \$100.

Excusable delay

ABB Control Inc. shall not be liable for loss, damage, detention or delay, nor be deemed to be in default from causes beyond its reasonable control, including without limitation, fire, flood, strike or other labor difficulty, act or omission of any governmental authority or of the purchaser, insurrection or riot, embargo, delays or shortage in transportation or inability to obtain necessary labor, materials or manufacturing facilities from usual sources.

In the event of delay in performance due to any such cause, the date of delivery will be postponed by such length of time as may be reasonably necessary to compensate for the delay.

Warranty

ABB Control Inc. warrants that on date of shipment to purchaser, the goods will be the kind and quality described herein, merchantable and free of defects in workmanship and material.

If within one year from date of initial operation, but not more than eighteen months from date of shipment, should any failure to conform with this warranty appear within such time, ABB Control Inc. shall, if given prompt notice by purchaser, correct such nonconformity, at its option, either by repair or replacement F.O.B. repair facility or by refund of the purchase price of the nonconforming product or part. Return of products to ABB Control Inc. pursuant to this paragraph shall be at purchaser's risk and expense. *The foregoing warranty is exclusive and in lieu of all other warranties of quality, expressed or implied, and all other warranties, including any warranty of merchantability or fitness for a particular purpose are hereby disclaimed.*

Correction of nonconformities in the manner and for the period of time provided above shall be purchaser's exclusive remedy and shall constitute fulfillment of all liabilities of ABB Control Inc. whether in warranty, strict liability, contract, negligence, tort or otherwise with respect to any nonconformance or defect in the product.

The foregoing warranty shall not apply to any product which has been: a) improperly repaired or altered, b) subjected to misuse, misapplication, negligence or accident, c) used in a manner contrary to manufacturer's directions.

Limitation of liability

ABB Control Inc.'s liability to purchaser on any claim in connection with the product shall not exceed the purchase price of the product which gives rise to the claim.

IN NO EVENT SHALL ABB CONTROL INC. BE LIABLE FOR SPECIAL, INCIDENTAL OR CONSEQUENTIAL DAMAGES whether in warranty, contract, strict liability, tort, negligence or otherwise including but not limited to loss of profits or revenue, loss of use of the product or any associated product, cost of capital, cost of substitute products, facilities or services, downtime costs or claims of customers of the purchaser for such or other damages.

Except as prohibited by law, all causes of action against ABB Control Inc. shall expire unless brought within one year of the time of accrual thereof. *ABB CONTROL INC. NEITHER ASSUMES NOR AUTHORIZES ANYONE TO ASSUME FOR IT ANY OTHER OR FURTHER LIABILITY THAN AS SET OUT ABOVE.*

Patent indemnity

ABB Control Inc. will at its own expense defend any suit which may be brought against the Purchaser based on a claim that any apparatus or part furnished under contract constitutes an infringement of any United States letter patent (provided ABB Control Inc. is notified promptly of such suit and copies of all papers therein are delivered to ABB Control Inc.), and ABB Control Inc. agrees to pay all judgements and costs recovered in any such suit and to reimburse the Purchaser for costs of expenses incurred in the defense of any such claim or suit. In case said apparatus or any part is held to constitute infringement and the use of the apparatus or part is enjoined, ABB Control Inc. shall at its own expense, either procure for the Purchaser the right to continue using the apparatus or part or replace it with non-infringing apparatus; or modify it so it becomes non-infringing, or remove the apparatus and refund the purchase price and the transportation and installation cost thereof. The foregoing states the entire liability of ABB Control Inc. for patent infringement by apparatus or any part thereof.

Shipping loss or damage

In the event of shipping loss or damage: 1) Notification must be given to ABB Control Inc. within 72 hours of delivery; 2) Written notice of apparent loss or damage must be made on the carrier's delivery receipt; and 3) Concealed damage must be immediately reported to the delivering carrier with a request for inspection. Purchaser shall comply with the foregoing procedure whether or not ABB Control Inc. has the risk of loss at the point of loss or damage to the shipment.

Title – risk of loss

The products sold hereunder shall remain the property of ABB Control Inc. and shall remain personal property until fully paid for in cash, and purchaser agrees, if requested by ABB Control Inc. to execute a further security agreement covering the products sold, and to perform all acts which may be necessary to perfect and assure retention of title to such products by ABB Control Inc. Notwithstanding any agreement with respect to delivery terms, risk of loss or damage shall pass to the purchaser and delivery shall be deemed to be complete upon delivery to a private or common carrier or upon moving into storage, whichever occurs first, at the point of shipment.

Termination

Any order or contract may be terminated by the purchaser only on written notice and upon payment of reasonable and proper termination charges, including without limitation, all costs identified to the order of contract incurred by ABB Control Inc. up to the date of notice of termination and all charges incurred by ABB Control Inc. in respect of the termination.

Returns

In no event will ABB Control Inc. be responsible for unauthorized return of products. Returns will be accepted only at ABB Control Inc.'s option and subject to terms specified by ABB Control Inc. Authorization and shipping instructions for return of products must be obtained from ABB Control Inc. prior to return shipment. Product must be returned with proper identification. When a purchaser requests authorization to return for his own reasons, the return is subject to a minimum restocking charge of 20% for standard inventoried product and for any transportation paid by ABB Control Inc., both out and ingoing. Returns will be accepted up to 60 days after invoice date. Goods returned for purchaser's reason are subject to inspection and must be in good working condition, as new, and in original cartons.

Purchase orders

Except as provided below, all orders must be in writing and show quantities and prices, complete description (including catalog numbers) of products requested and mutually agreed delivery dates.

Verbal orders received via telephone or otherwise must be confirmed within 5 days either by mail, telex or the equivalent. Verbal orders with a purchase price over \$5,000 will not be processed until such written confirmation is received.

Unless otherwise agreed in writing, an addition to a previously entered order will be accepted only at then applicable prices, discount schedules, conditions of sale, etc.

Special quotations

Special quotations will automatically expire 30 days from issuance unless renewed in writing by ABB Control Inc.

Assignment

Any assignment of this contract, or any rights hereunder, without prior written consent of ABB Control Inc. by a duly authorized representative thereof shall be void.

Partial invalidity

If any provisions herein or portions thereof conflict with any statute or rule of law of the jurisdiction of applicable law or wherein the contract may be sought to be enforced, then such provisions or portions thereof shall be deemed void to the extent that they may so conflict, but without invalidating the remaining portions of such provisions or other provisions hereof.

Remedies

The remedies expressly provided for in the Conditions of Sale shall be in addition to any other remedies which ABB Control Inc. may have under the Uniform Commercial Code or other applicable law.

Choice of law

The construction and performance of this contract and the rights and remedies of the parties hereto shall be governed by the laws of the State of Texas.

General information

Standard compliance and approvals

Worldwide approvals ^①



The CE Mark

Within the European Union, EU, conformity of products and the proper application of the CE marking to machines and control equipment is necessary for marketing electrical equipment. The intent is to ensure compliance with all relevant EU Directives.

ABB Low Voltage Apparatus

ABB is a global group serving customers in electric power generation, transmission and distribution, industrial building systems, and rail transportation. ABB Low Voltage Apparatus develops, produces and markets low voltage products

such as contactors, starters, pushbuttons, soft starters, arc guard systems, relays, mini-contactors, manual motor starters, Isomax MCCBs, MCBs and disconnect switches.



With six manufacturing units within the European Union, we are ideally located to develop, manufacture and provide low voltage equipment to comply with the EU directive.

Background

The guarantee of free trade of goods within the Community is the most important objective. This will eliminate trade restrictions that result from different technical regulations in each individual member country. Harmonization of existing European standards and regulations, is being accomplished and already partially realized. Based on this goal, a new concept for creating directives was formed in 1985 by the European Community (EC) Commission to produce directives with a wide range of application which contain only the most basic safety requirements.

The CE Mark

The CE mark is prescribed by law and assures the European free trade of goods. It is short for "Communauté Européen", and is displayed on goods and/or packaging which acts as an external symbol for the inspection of products. It also illustrates the manufacturer's responsibility to uphold the community's directives.

ABB's commitment to the directives

ABB Low Voltage Apparatus producing companies will attach the CE mark in accordance with the product directives. Our products will conform as follows:

- Declarations of conformity for ABB products will be available when required by the relevant EU directives.
- Those products required to do so will bear CE marking as specified by the relevant EU directives and CE marking regulations.
- Necessary technical documentation will be on file and made available to authorized organizations upon written request.

^① Approvals listed may not apply to products listed in this publication.

Product scope

Industrial controls

- Contactors
- Drive contactors
- Welding contactors
- Overload relays
- Starters, open & enclosed
- Manual motor starters
- Softstarters
- Control relays
- Pushbuttons
- Miniature controls
- Control circuit transformers
- Sensors
- Arc Guard systems



Circuit protective devices

- Fusible disconnect switches
- Non-fusible disconnect switches
- Enclosed disconnect switches
- Molded case circuit breakers
- Miniature circuit breakers
- Megamax & Emax power circuit breakers (IEC)



Low Voltage Network Quality

Power factor correction

- Individual capacitors
- Fixed capacitor banks
- Automatic capacitor banks

Harmonics correction

- Anti-resonance capacitor banks
- Filter banks
- Dynacomp





ABB Control Inc.
1206 Hatton Road
Wichita Falls, TX 76302
Tel. (800) 877-3232
(940) 397-7000
Fax (940) 397-7001
Email info_usa@abbcontrol.com
Web www.abbcontrol.com