



## REFUdrive 500 Product Program

# Indramat Refu The Company



## **Stronger together**

Indramat Refu – two impressive names in one company. Since the beginning of the new millennium REFU “Gesellschaft für Regelbare Elektronische Frequenzumformer” – an acronym for controllable electronic frequency converters, belongs to Rexroth Indramat GmbH and therefore to Rexroth AG, “The Drive & Control Company”. Indramat Refu together with Rexroth Indramat, the technological leader of AC servo drives and open control systems, is a synonym for innovative solutions – worldwide.

## **Traditionally innovative**

Innovation is our driving factor. We have continuously set milestones in drive technology, which have later become “state of the art”. Our aim has been, and still is, to develop new applications for frequency converters in connection with synchronous and induction motors. This is tradition in our company: Just three years after the company’s establishment in 1965, we had already produced a frequency converter for high-speed drilling spindles, and shortly afterwards the first frequency converter with thyristors. Later we developed the new generation of converters with IGBT’s and high-performance microprocessors. We are nowadays setting new standards with the modular-constructed REFU*drive*.

## **Quality is standard**

Our company has of course been certified according to ISO 9001 for many years now. However, in addition to this certificate we place high expectations on our products and services – and we realize these expectations. Quality means to us much more than just quality of products: We

respond quickly to customer concerns, we reliably keep to promises as well as being open in all our processes, and these are actively created and implemented by our co-workers.

## **Worldwide on-site**

You can always rely on our service network. Experienced service engineers in Europe, America and Asia know your system and your application. Whether in person using a 24 hour telephone hotline or via Internet: We guarantee a quick response and solution. It is reassuring for you that we are there when you need us - around the clock, worldwide.

## **The Drive & Control Company**

Working hand in hand, learning from each other and developing together: Indramat Refu is a part of the successful Rexroth AG. Moving linearly or rotationally, raising or lowering equally, rapidly accelerating, maintaining commanded speeds, positioning accurately, running precisely under pressure, transferring performances, linking processes - these are the tasks which are constantly demanded by all areas of technology. Rexroth solve these tasks: Effectively and confidently with a multi-purpose product range for driving, controlling and moving. The Drive & Control Company combines all three technological drive types: Electronic drives, hydraulics and pneumatics. Rexroth are represented worldwide. Approximately 21,000 employees make annual sales of approximately 2.5 billion Euro.

# REFUdrive 500

## Device Overview

Type Code

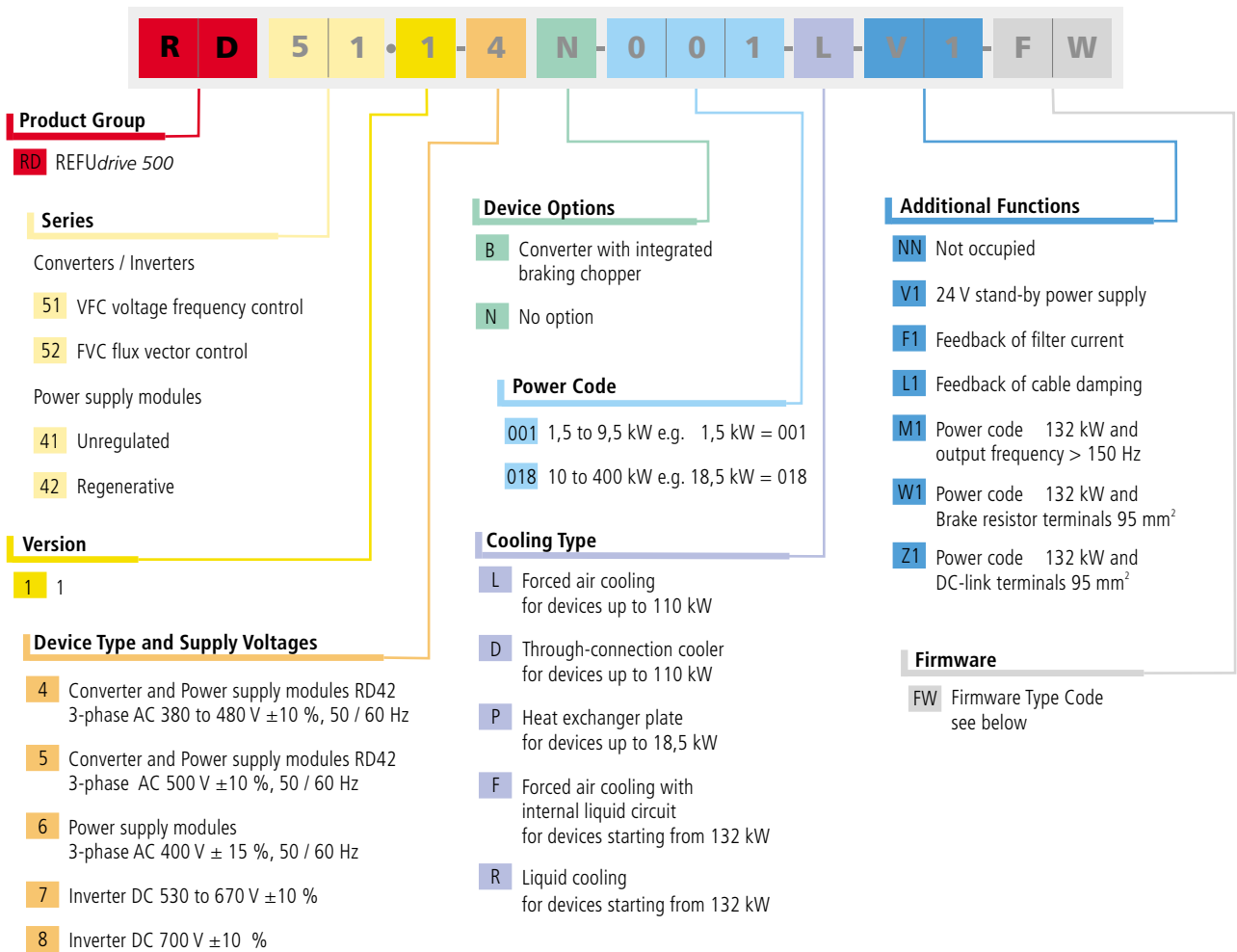

### Firmware FW

Please order a suitable firmware for the devices RD51 and RD52 with the following type code. The type codes of the branch specific solutions are listed in the corresponding product overview.

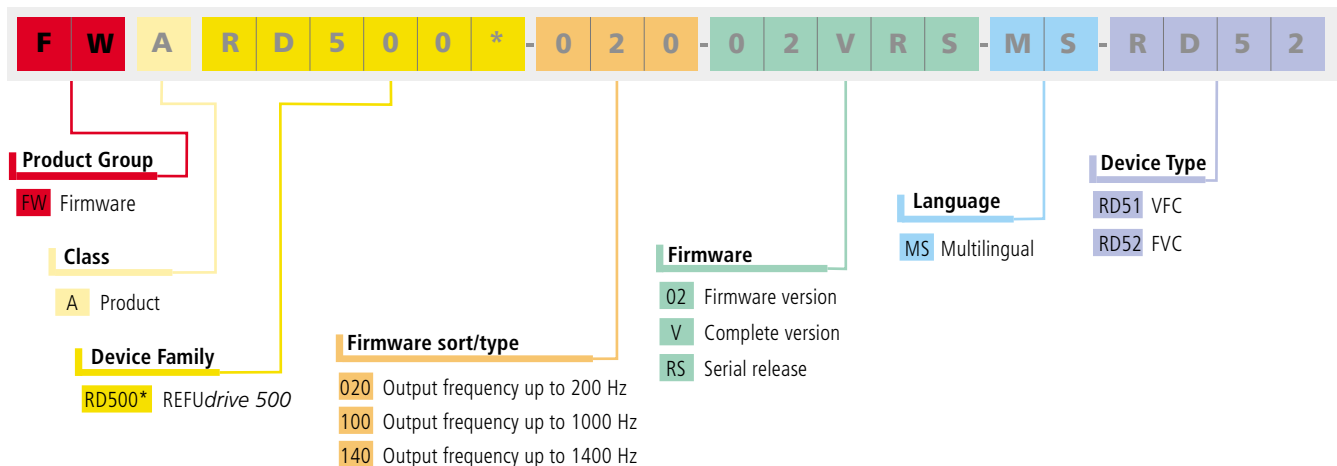

# REFUdrive 500 Series

## Description

REFUdrive 500 is a state-of-the-art three-phase current drive system which can be used universally for a wide variety of synchronous and induction motor models. Modular hardware and software construction enables optimized flexible customization for the particular drive task at hand. All requirements, from a simple VFC (voltage frequency control) drive to a highly dynamic FVC (flux vector control) drive can be covered with 2 different control components. Indramat Refu has developed its own patented flux vector current regulator for this.

The system offers drive converters in various versions (with or without a braking chopper, line contactor etc.), inverters for the DC connection and power supply modules in regenerative feedback and normal power supply versions.

The products can be ordered alone or combined, completely wired in a CE-tested cabinet.

The power modules are constructed for rear cooling. This enables cooling with forced ventilation outside of the cabinet at a high degree of protection (through-connection assembly or heat discharge plate). In addition, models with liquid cooling are deliverable, with an integrated or external heat exchanger.

## Start up

Easy start up has been given especially high importance:

- Automatic motor adaptation via parameter identification
- Quick-setup
- Basic parameterization
- Guided start up via operator panel with graphical display
- Highest level of comfort via PC with a powerful software tool, REFUwin.



## Technical Characteristics

- AC or DC power supply
- Choice of forced air cooling, heat discharge plate or integrated cooling circuits
- Removable operator panel with copy function
- 4-lined graphical display
- Various interfaces for operating, observing and parameterizing the drive system ("down-load" parameterizing):
  - Profibus DP
  - Interbus S

- CANopen
- RS 232
- RS 485
- Peer-to-Peer coupling with fiber-optic cable
- SynchroLink for quick communication between multiple drives
- Expanded, freely combinable function blocks:
  - PID and PI controllers, AND, OR, XOR, RS Flip-Flop, D-Latch and Sample & Hold module
  - Mathematical function elements
  - Timer elements, counters, comparators, ramp-function generators
- Additional signal processor (32-bit floating point) for highly dynamic applications and servo applications:
  - Torque rise time 0.3 msec
  - Current cycle time 0.1 msec
- Powerful software tool, REFUwin

## Electromagnetic Compatibility

The drive converters have integrated radio interference suppression filters and line reactors to reduce the harmonics fed back into the line supply. REFUdrive 500 completely fulfills the EMC Directive in reference to the noise immunity and noise emission according to the EMC Product Standard for electric drives EN 61800-3, EN 55011 Class A (IEC 1800-3). REFUdrive 500 units conform with noise immunity specifications according to EN 50082-2.

# REFUdrive 500 Technical Data

Power supply	3-phase AC 380 V to 500 V ( $\pm 10\%$ ) 50/60 Hz in different ranges The devices are suitable for connection to an IT network.
Power range	for 1.5 to 400 kW (2 to 500 HP) rated motor output
Overload ability	130 % for 60 sec; 170 % for 1 sec; 200 % for 0.5 sec (up to 110 kW (150 HP))
Output voltage	3-phase AC 0 V to power supply (VFC devices) 3-phase AC 0 V to 0.95 x power supply (FVC devices)
Output frequency	0 to 200 Hz, optionally to 1,400 Hz up to 3,000 Hz see product document REFU <i>speed</i>
Efficiency at nominal point	0.97 to 0.98 (depending on output range)
Line power factor	$\lambda_N > 0.9$ inductive; $\cos \varphi > 0.96$
Protection type	IP 20 according to EN 60529
Cooling type	see graph on the right
Installation height	1,000 m (3,300 ft) above sea level up to max. 2,000 m (6,600 ft); starting at 1,000 m (3,300 ft) power reduction 1,7 % per 100 m (330 ft)
Ambient temperature	0 to +40 °C (32 to 104°F) operation, up to 50 °C (122°F) with power reduction of 2.5 % per deg.; -25 to +70 °C (-13°F to 158°F) storage
Environmental class	3K3 according to DIN IEC 721-3-3 (ambient temperature 0 to +40 °C (32 to 104°F))
Perm. air humidity	<85 % at 28 °C (82°F); non condensing
Radio interference degree/noise immunity	A1 according to EN 55011/EN 61800-3
Electromagnetic Compatibility (EMC)	per EMC product standards for electric drives EN 61800-3, IEC 1800-3
Contamination level	level 2 per DIN VDE 0110
CE-label	EC low voltage guideline 73/23 (EWG) per EN 50178
Minimum operation frequency	with/without encoder 0 Hz/2 Hz
Approval	UL/CSA (in preparation)

## Cooling Methods

The cooling methods available are dependent on the rated motor output and the drive converter output respectively.

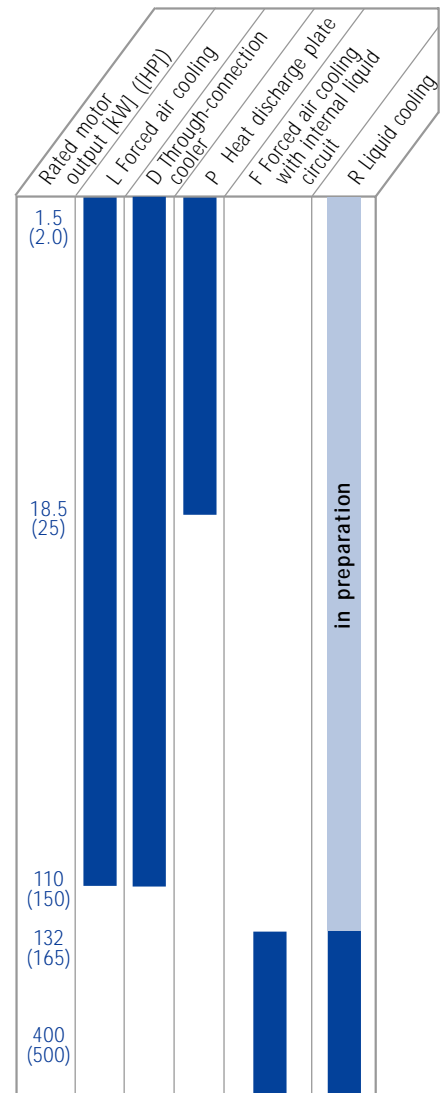

## Encoders that can be connected, RD52 series – Flux Vector Control

Incremental encoder	TTL $V_B = 5\text{ V}$ , TTL $V_B = 9\text{ to }30\text{ V}$ (version R), HTL $V_B = 9\text{ to }30\text{ V}$
Sine/Cosine encoder	$V_B = 5\text{ V}$ , $1\text{ V}_{SS}$ , with or without rotor positioning sensor
tooth wheel encoder	$V_B = 5\text{ V}$ , $1\text{ V}_{SS}$
Resolver	$V_E = 7\text{ V}_{eff}$ , 8 kHz, TR = 0.5, p = 2,4,6 to 64

## External heat exchanger



# REFUdrive 500

## Device Selection RD51/RD52

Device selection via

Technical Requirements



Necessary device characteristics	RD51 VFC	RD52 FVC	
	Voltage Frequency Control	Flux Vector Control	
	w/o encoder	w/o encoder	w/encoder
Speed control	–	yes	yes
Speed range	1:20	1:20	1:30,000
Speed precision	2 % with slippage compensation	0.6%	0.003 % at a high encoder resolution (ERN)
Torque control	no	yes	yes
Torque ripple	5 % $M_N$	2 % $M_N$	Synchronous motor: 0,5 % $M_N$ Induction motor: 1 % $M_N$
Torque rise time	–	0.5 msec	0.3 msec
Full holding torque at rot. speed 0	no	no	yes
Frequency precision	0.01 %	–	–
Motor identification	–	yes	yes
Electric line shaft	–	–	yes
Positioning	–	–	yes
Position control	–	–	yes



Decide which unit RD51 or RD52



Determine the necessary motor current for your individual drive tasks.

RD51:  $V_{FU-max}$  = power voltage

RD52:  $V_{FU-max}$  = 0.95 x power voltage



Do you need individual drives or drives with common circuits and energy alignment and with which:

line supply voltage/  
intermediate circuit voltage?



Is braking operation necessary?



Which cooling type?



How is the converter controlled?



Are the standard terminal strips sufficient for controlling the drive?



Is an output filter required? e. g. with long motor cable lengths of more than 75 m or with motors with insufficient voltage for modernization tasks.



Software tool REFUwin?

# REFUdrive 500

## Device Selection RD51/RD52

### Applications



- Converters pages 14-17
- Power supply modules pages 18, 19
- Inverters pages 22-23
  
- Drive converter with braking chopper
- Braking resistors pages 28-30
- Reinforced braking resistors pages 31-35
- Use regenerative power supply module page 19, unregulated power supply modules are always equipped with a braking chopper.
  
- Pages 15, 17, 21, 23
- External heat exchanger page 39
  
- Via operating panel page 25
- Via field buses from page 26
- Via terminal strips page 8, 10
- No: terminal strip expansion page 27
  
- Motor filter page 36
- Sinusoidal filter page 37
  
- Page 24

Device applications Recommendations	RD51 VFC	RD52 VFC	
	Voltage Frequency Control	Flux Vector Control	
	w/o encoder	w/o encoder	w/ encoder
Ventilator and pump drives	●		
Warehousing technology	○		●
Conveyor belts	●	○	○
Test stand technology		○	●
Centrifuges	●	○	
Agitators	●	○	
Extruders	○	●	○
Group drives (multiple motors running parallel on one converter)	●		
Roller tables	●		
Presses	●	○	○
Wire drawing systems	○	●	○
Winding drives (sheet metal, paper, cloth)		○	●
Winch drives		○	●
Paper machines		○	●
Flying shears			●
Crane technology <i>see REFUlift catalog</i>			
– Hoisting/pulling gear		○	●
– Moving gear	●		○
– Slewing gear	○		●
Stage technology "		○	●
Cableways/elevators/lifts "	○		●
Textile technology <i>see REFUreduc catalog</i>			
– Continuous machine	○	○	●
– Spinning machine	●	○	●
– Continuous spinning systems		○	●
Grinding machines <i>see REFUspeed catalog</i>	●		
– Drilling drives	●		
– Milling spindles/machines	○	○	●

- Main recommended applications
- Possible use conceivable



# REFUdrive 500

## RD51 VFC Voltage Frequency Control

### Block Diagram

#### Removable Operator Panel

- Operate
- Monitor
- Parameterize
- Copy parameter sets and transfer them to other devices

#### Standard control terminal strips

The control terminal strip includes:

- 3 digital inputs or outputs (as desired)
- 2 digital inputs  
Level: Inputs and outputs  
P24V PLC-compatible
- 1 analog input  $\pm 10$  V,  
resolution  $\pm 9$  bit  
0/4 to 20 mA, resolution 10 bit
- 1 encoder input for HTL incremental  
encoder, altern. 3 digital inputs
- 1 analog output  $\pm 10$  V, 5 mA,  
short-circuit-proof, resolution  $\pm 8$  bit,  
reference as selected + 10 V, -10 V
- 1 relay output 250 V AC, 7 A  
or 30 V DC, 7 A
- RS 232
- RS 485

#### With the control terminal strip extension you also receive

- 4 isolated digital inputs
- 1 analog input  $\pm 10$  V,  
resolution  $\pm 9$  bit or 0/4 to 20 mA,  
res. 10 bit
- 2 relay outputs (normally open contact)  
30 V AC/DC, 2 A
- 2 relay outputs (two-way switch)  
30 V AC/DC, 2 A
- 2 isolated analog outputs,  
resolution 9 bit, 0/4 to 20 mA

#### Various interfaces

The units are available with:

- Interbus S remote bus
- Profibus DP slave
- CANopen
- Peer-to-Peer coupling  
with fiber-optic cable

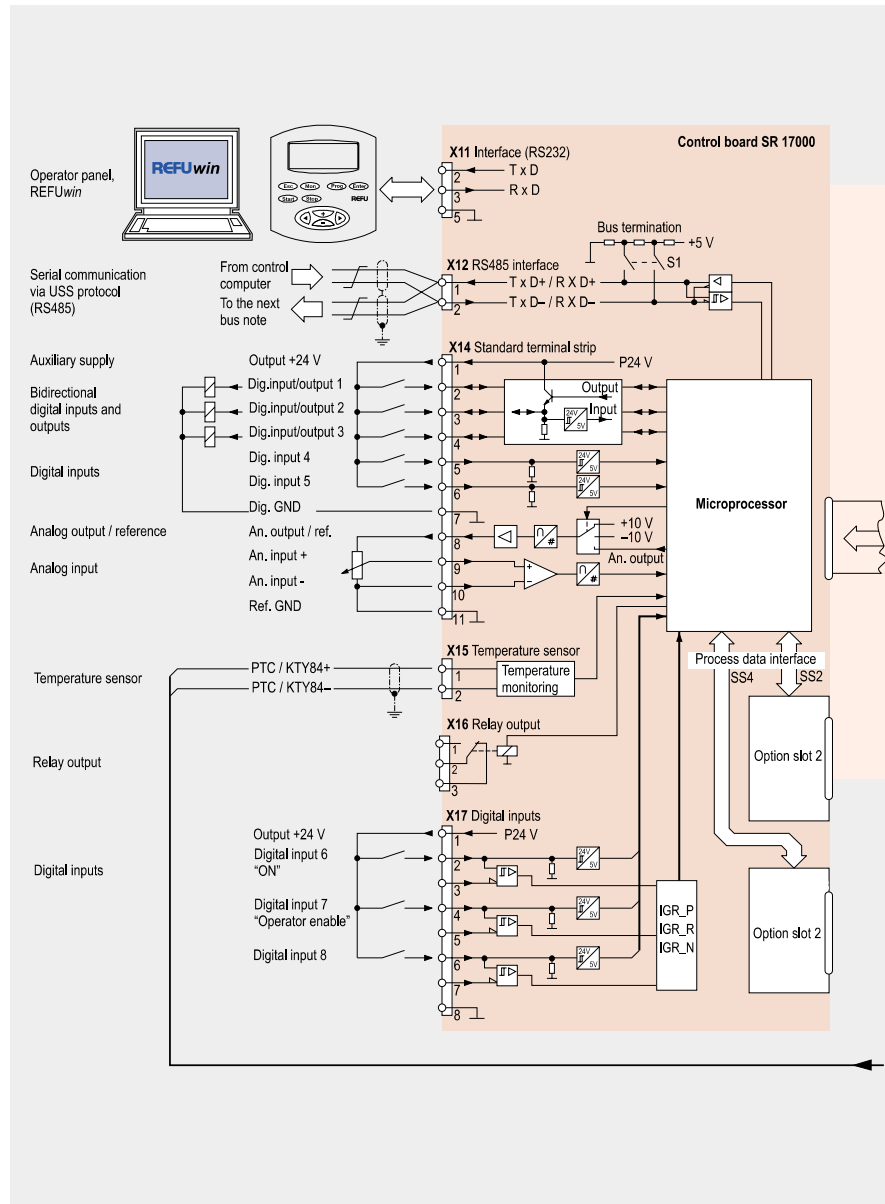



# REFUdrive 500

## RD51 VFC Voltage Frequency Control

### Block Diagram

#### Voltage Frequency Control

Voltage frequency control drives offer an economical drive solution for applications that do not need servo characteristics such as pumps, ventilators, moving gears, centrifuges, extruders, agitators and conveyor belts. The drive works on a frequency-controlled basis, that is the set value determines the converter output frequency. The output voltage is adjusted proportionally to the frequency. To improve the drive's qualities, I x R and slipping compensation are integrated as well as a rise in voltage (boost) in the lower frequency range.

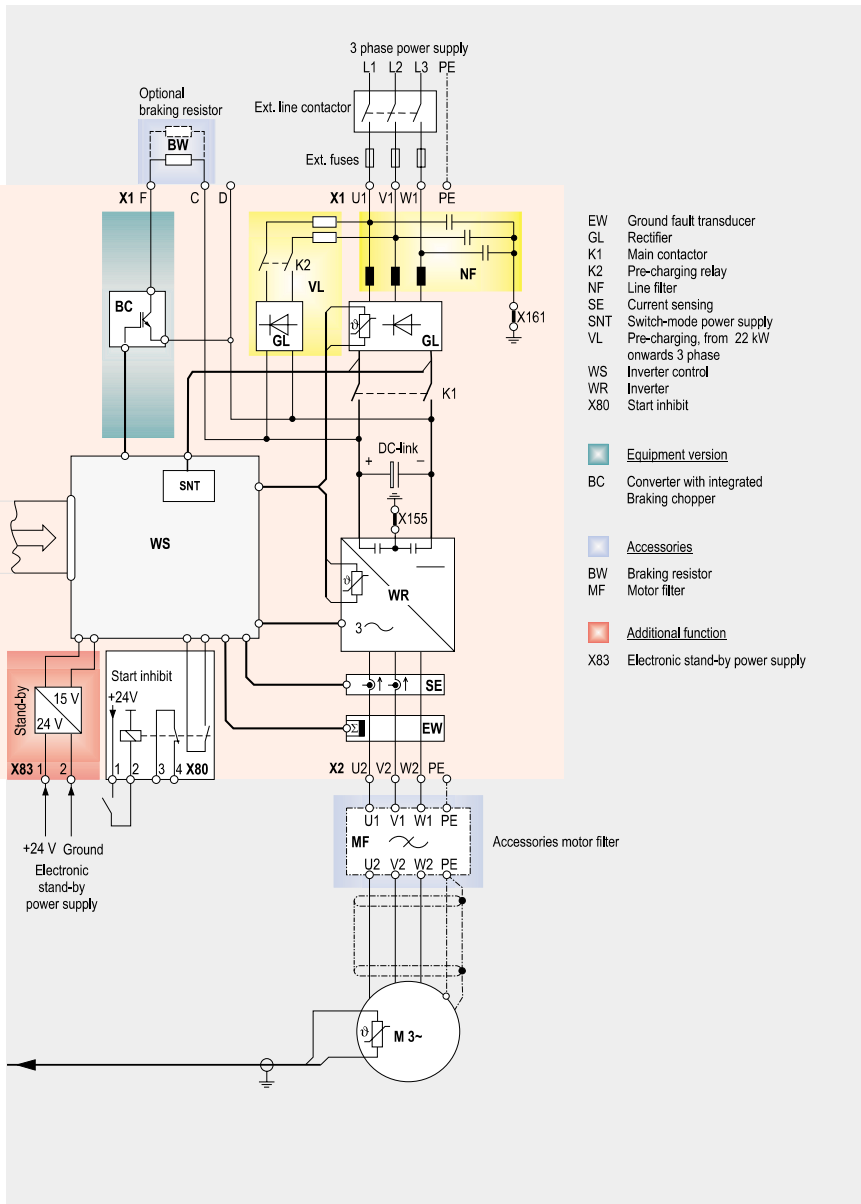

# REFUdrive 500 RD52 FVC Flux Vector Control

## Block Diagram

### Removable operator panel

- Operate
- Monitor
- Parameterize
- Copy parameter sets and transfer them to other devices

### Standard control terminal strips

The control terminal strip includes:

- 3 digital inputs or outputs (as desired)
- 2 digital inputs  
Level: Inputs and outputs  
P24V PLC-compatible
- 1 analog input  $\pm 10$  V, resolution  $\pm 11$  bit  
0/4 to 20 mA, resolution 12 bit
- 1 analog output  $\pm 10$  V, 5 mA, short-circuit-proof, resolution  $\pm 8$  bit, reference as selected +10 V, -10 V
- 1 relay output 250 V AC, 7 A or 30 V DC, 7 A
- RS 232
- RS 485

### With the control terminal strip extension you also receive

- 4 isolated digital inputs
- 1 analog input  $\pm 10$  V, resolution  $\pm 9$  bit or 0/4 to 20 mA, res. 10 bit
- 2 relay outputs (normally open contact) 30 V AC/DC, 2 A
- 2 relay outputs (two-way switch) 30 V AC/DC, 2 A
- 2 isolated analog outputs, resolution 9 bit, 0/4 to 20 mA

### Various interfaces

The units are available:

- Interbus S remote bus
- Profibus DP slave
- CANopen
- SynchroLink for fast communication between multiple drives
- Peer-to-Peer coupling with fiber-optic cable

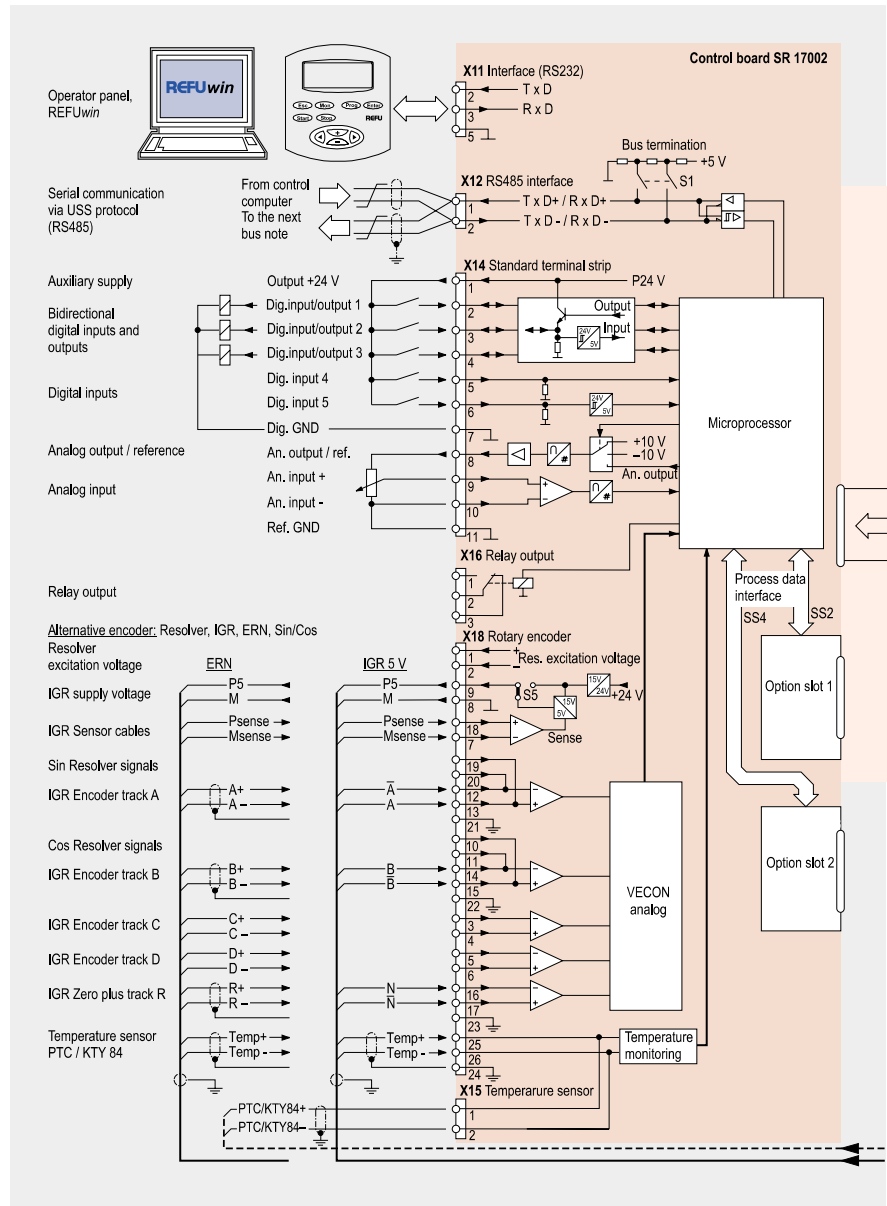

# REFUdrive 500

## RD52 FVC Flux Vector Control

### Block Diagram

#### Flux Vector Control

Flux vector control is employed in the most challenging, highly-dynamic drive tasks. The RD52 can be operated both with an encoder (incremental encoder, resolver, sin/cos encoder) as well as without an encoder. Three phase induction motors and synchronous motors can be operated with the RD52. The drive can control rotary speed or torque. The stator current is divided into two components: the magnetization current and the active current via the motor model. With the patented multivariable control system, the vectors of both component currents are adjusted so exactly in accordance with the dialog, that the highest possible utilization of the motor and drive converter combination is guaranteed.

Patent document:

44 18 997 from 2/6/99, German Patent and Trademark Office, Munich

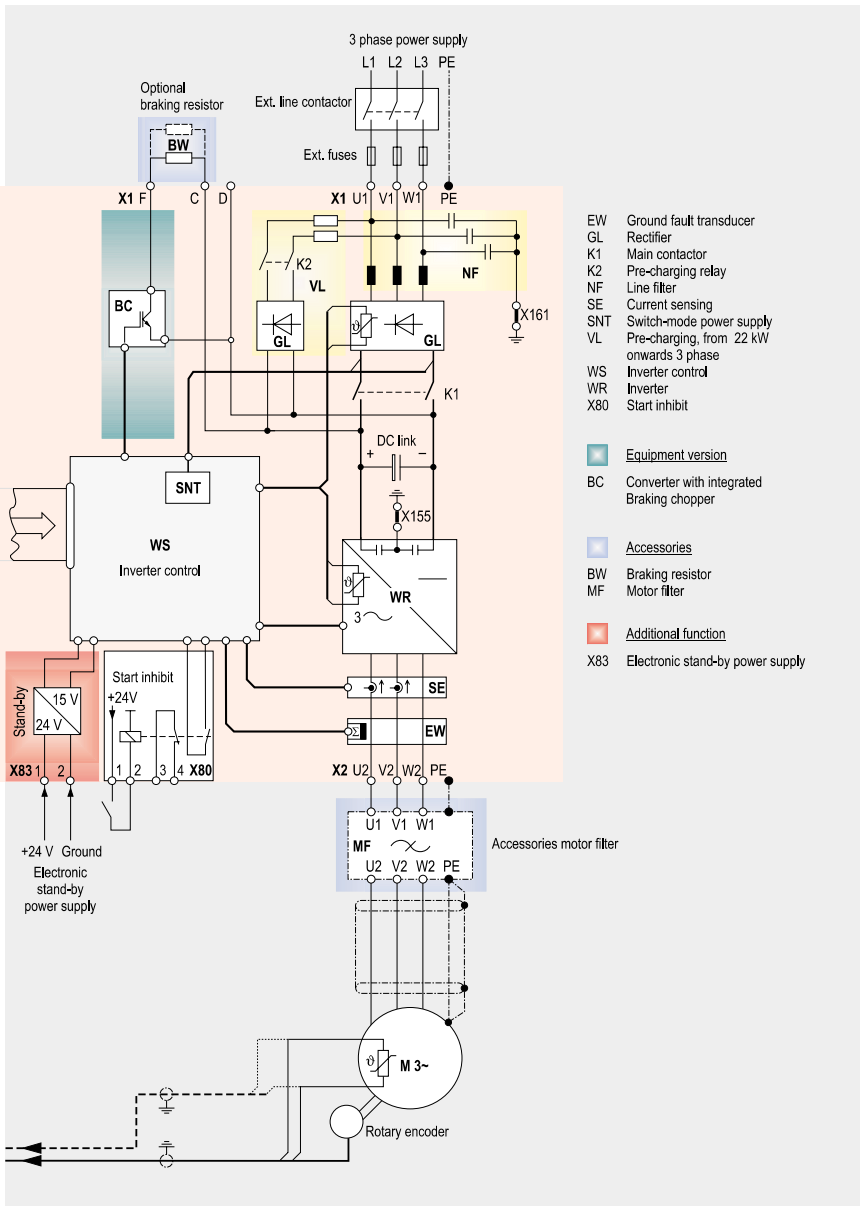

# REFUdrive 500

## Drive Converters with Internal Liquid Circuit

### Block Diagram

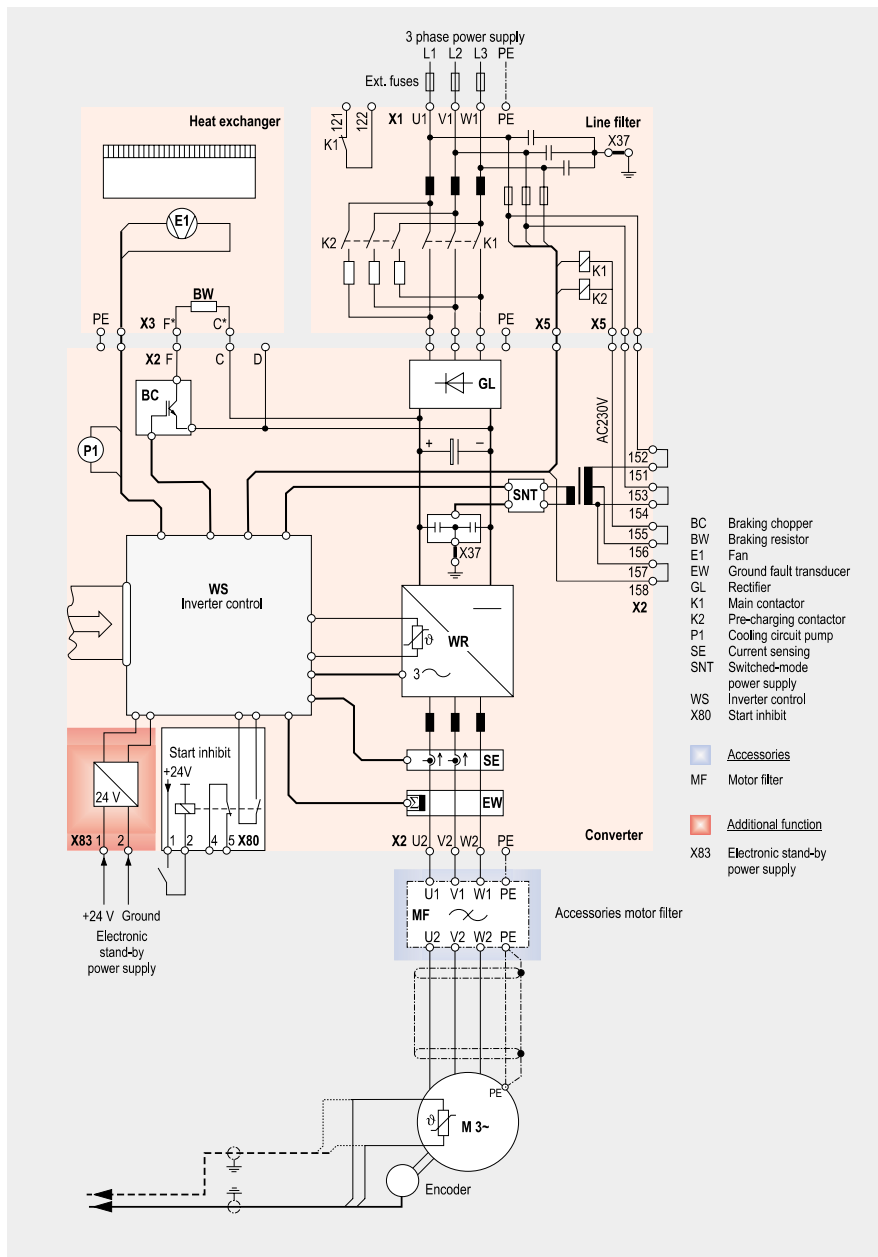

# REFU*drive 500*

## Electromagnetic Compatibility EMC

### **Electromagnetic compatibility EMC**

Drive converters control the torque and rotary speed of three phase induction motors using a pulse-width modulated output voltage with variable frequency. To reduce power losses, fast-switching semi-conductors are used, which ensure efficient controlling at high cycles. Electric and electromagnetic noise fields are usually a result of this.

The limiting values for the permissible noise emission of drive converters are stated in the European Standard EN 55011. This standard differentiates between voltage interference on the power supply due to the cables and radiated interference or radio interference. The standard defines the limiting values A for industrial power supplies and B for connection to public power supplies.

The REFU*drive 500* drive converters have integrated radio interference suppression filters and line reactors to reduce the harmonics fed back into the line supply.

The units completely fulfill the EMC Directive in reference to the noise immunity and noise emission according to the EMC Product Standard for electric drives EN 61800-3, EN 55011 class A (IEC1800-3) and the noise immunity specifications according to EN 50082-2.

Radio interference suppression filters are available as accessories for complying with radio interference degree B according to EN 55011.

### **Measures for Reducing Noise Emission**

Line filters are used to reduce the spread of noise emissions into the power supply. Shielded motor cables with shields fitted on both sides direct the noise emissions on the outside back to the drive converter. To reduce noise radiation, the drive converters are assembled into a closed cabinet. Power and control cables are to be laid at a safe distance apart. The whole entrance to the cabinet must be well shielded.

# REFUdrive 500

## Drive Converters 1.5 to 110 kW

Output frequencies up to 200 Hz  
 Technical Data

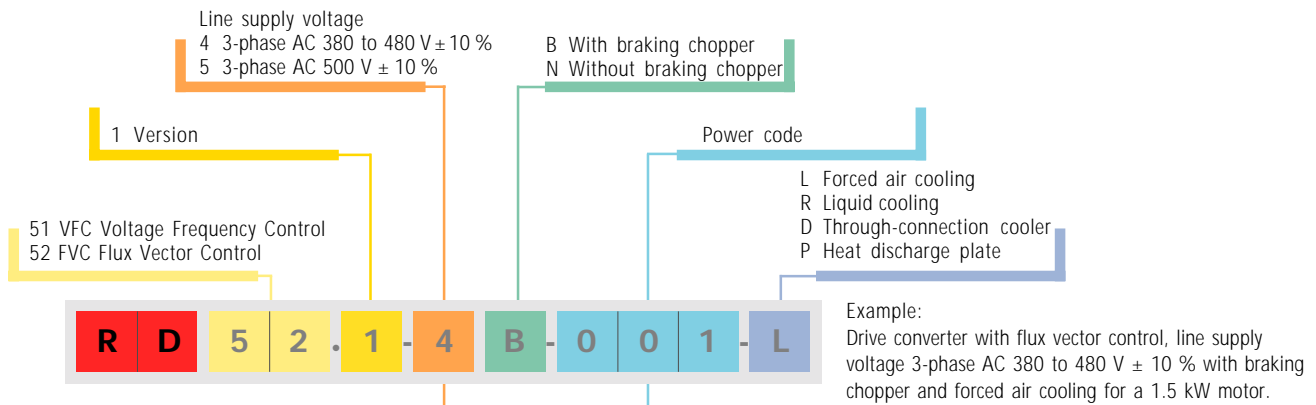

Rated motor output		Power code	Line supply voltage			Line supply voltage			Peak current			Size
[kW] <sup>1</sup> at 400 V	[kW] <sup>1</sup> at 500 V		4	Line supply voltage 3-phase AC 380 ... 480 V ± 10 % <sup>2</sup>	5	for 60 sec	for 1 sec	for 0.5 sec	Line supply voltage 3-phase AC 500 V ± 10 %	for 60 sec	for 1 sec	
Rated motor output			Rated current [A]	Peak current [A]	Rated current [A]	Peak current [A]	Rated current [A]	Peak current [A]	Rated current [A]	Peak current [A]	Size	
1.5	2	001	4	5.2 6.8 8	3	3.9 5.1 6					A	
3	3	003	7.5	9.8 13 15	6	7.8 10 12					A	
4	5	004	10	13 17 20	8	10 14 16					A	
5.5	7.5	005	13	17 22 26	10	13 17 20					A	
7.5	10	007	18	23 31 36	14	18 24 28					A	
11	15	011	25	33 43 50	20	26 34 40					B	
15	20	015	30	39 51 60	24	31 41 48					B	
18.5	25	018	35	46 60 70	28	36 48 56					B	
22	30	022	43	56 73 86	34	44 58 68					C	
30	40	030	56	73 95 112	45	59 77 90					C	
37	50	037	68	88 116 136	54	70 92 108					C	
45	60	045	82	107 139 164	66	86 112 132					C	
55	75	055	99	129 168 198	80	104 136 160					D	
75	100	075	135	176 230 270	108	140 184 216					D	
90	125	090	165	215 281 330	130	169 221 260					E	
110	150	110	195	254 332 390	160	208 272 320					E	

<sup>1</sup> Maximum permitted motor output referring to a 4-pole standard motor. Voltage drops can occur due to control margins in the converter or when using inductors or filters between the drive converter and the motor.

<sup>2</sup> The rated current is linearly reduced starting at an output voltage  $V_a > 400$  V from 100 % to 83 % at  $V_a = 480$  V.

# REFUdrive 500 Drive Converters 1.5 to 110kW

## Dimensions

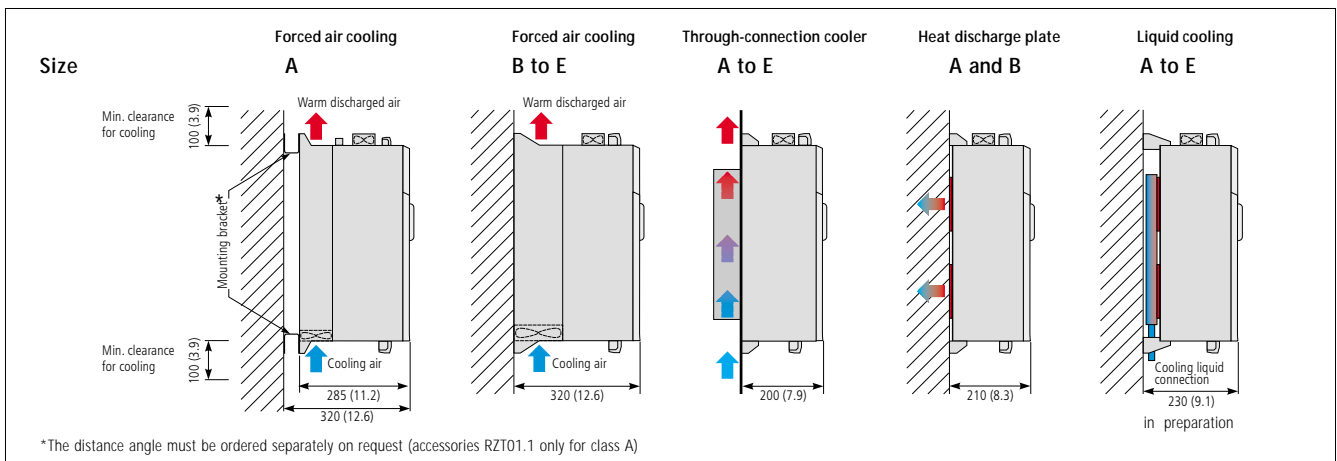
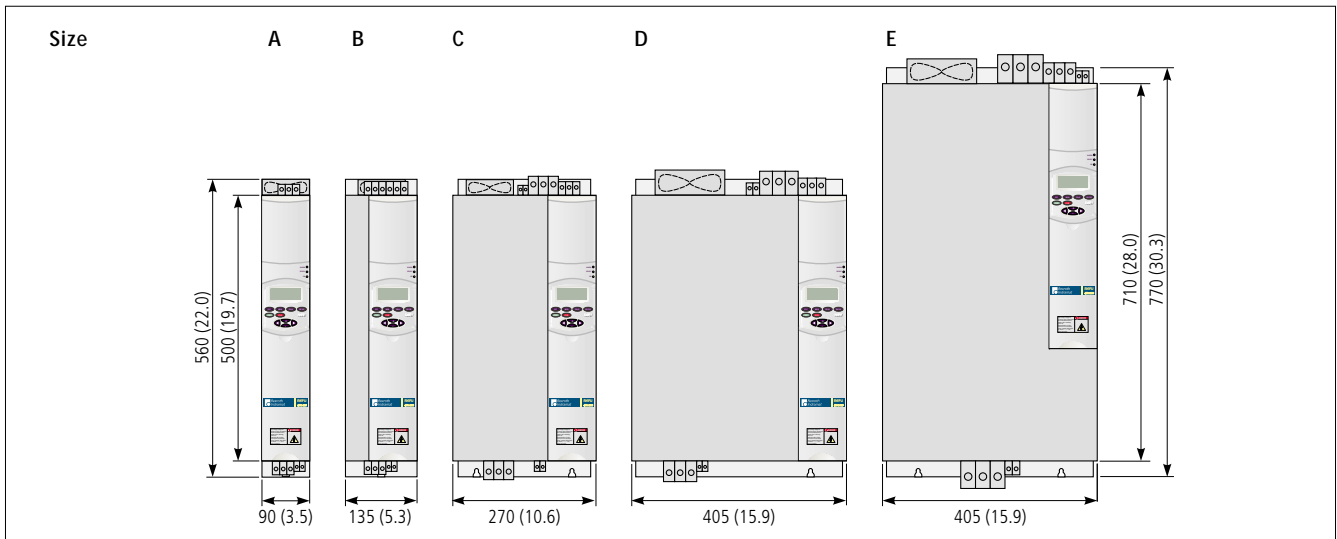

### L Forced air cooling

Size	Height mm (inch)	Width mm (inch)	Depth mm (inch)	Weight kg (lb)
A	500 (19.7)	90 (3.5)	285 (10.8)	15 (33)
B	500 (19.7)	135 (5.3)	320 (12.6)	18 (40)
C	500 (19.7)	270 (10.6)	320 (12.6)	33 (73)
D	500 (19.7)	405 (15.9)	320 (12.6)	50 (110)
E	710 (28.0)	405 (15.9)	320 (12.6)	80 (176)

### D Through-connection cooler

Size	Height mm (inch)	Width mm (inch)	Depth mm (inch)	Weight kg (lb)
A	500 (19.7)	90 (3.5)	200 (7.9)	15 (33)
B	500 (19.7)	135 (5.3)	200 (7.9)	18 (40)
C	500 (19.7)	270 (10.6)	200 (7.9)	33 (73)
D	500 (19.7)	405 (15.9)	200 (7.9)	50 (110)
E	710 (28.0)	405 (15.9)	200 (7.9)	80 (176)

### P Heat discharge plate

Size	Height mm (inch)	Width mm (inch)	Depth mm (inch)	Weight kg (lb)
A	500 (19.7)	90 (3.5)	210 (8.3)	10 (22)
B	500 (19.7)	135 (5.3)	210 (8.3)	12 (26)

### R Liquid cooling (in preparation)

Size	Height mm (inch)	Width mm (inch)	Depth mm (inch)	Weight kg (lb)
A	500 (19.7)	90 (3.5)	230 (9.1)	10 (22)
B	500 (19.7)	135 (5.3)	230 (9.1)	12 (26)
C	500 (19.7)	270 (10.6)	230 (9.1)	25 (55)
D	500 (19.7)	405 (15.9)	230 (9.1)	37 (82)
E	710 (28.0)	405 (15.9)	230 (9.1)	60 (132)



# REFUdrive 500

## Drive Converters 132 to 400 kW

Output frequencies up to 200 Hz  
 Technical Data

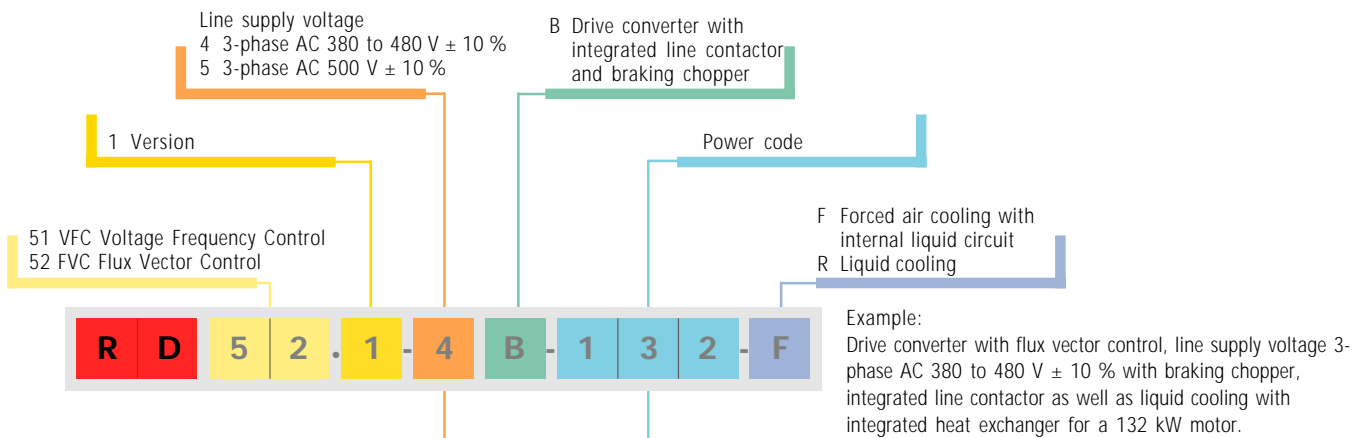

Rated motor output		Power code	Line supply voltage			Line supply voltage			Size
[kW] <sup>1</sup> at 400 V	[kW] <sup>1</sup> at 500 V		4	Peak current	Line supply voltage	Peak current	Peak current		
[HP] <sup>1</sup> at 460 V			Line supply voltage 3-phase AC 380...480 V ± 10 % <sup>2</sup>	for 60 sec	for 1 sec	Line supply voltage 3-phase AC 500 V ± 10 %	for 60 sec	for 1 sec	
Rated motor output		Rated current [A]	Peak current [A]	Rated current [A]	Peak current [A]	Peak current [A]	Size		
132	165	<b>132</b>	230	299	391	190	247	323	G1
160	200	<b>160</b>	290	377	493	240	312	408	G1
200	250	<b>200</b>	350	455	595	280	364	476	G2
315	400	<b>315</b>	540	702	918	432	562	734	H1
400	500	<b>400</b>	680	884	1156	550	715	935	H2

<sup>1</sup> Maximum permitted motor output referring to a 4-pole standard motor. Voltage drops can occur due to control margins in the converter or when using inductors or filters between the drive converter and the motor.

<sup>2</sup> The rated current is linearly reduced starting at an output voltage  $V_a > 400$  V from 100 % to 83 % at  $V_a = 480$  V.

The drive converters for the 132-400 kW power range are “all inclusive”, complete units to be installed in cabinets/racks by the customer.

The drive converters consist of:

- Line rectifier, capacitor link and
- IGBT inverter bridge
- Braking chopper with integrated braking resistor
- Line reactor for reducing line reaction

- Line contactor for electrical isolation
- Line filter to maintain class A1 according to EN 55011
- A motor filter designed for a 50 m motor cable

# REFUdrive 500

## Drive Converters 132 to 400 kW

### Dimensions

#### Cooling type F Forced air cooling with internal liquid circuit

#### Cooling type R Liquid cooling

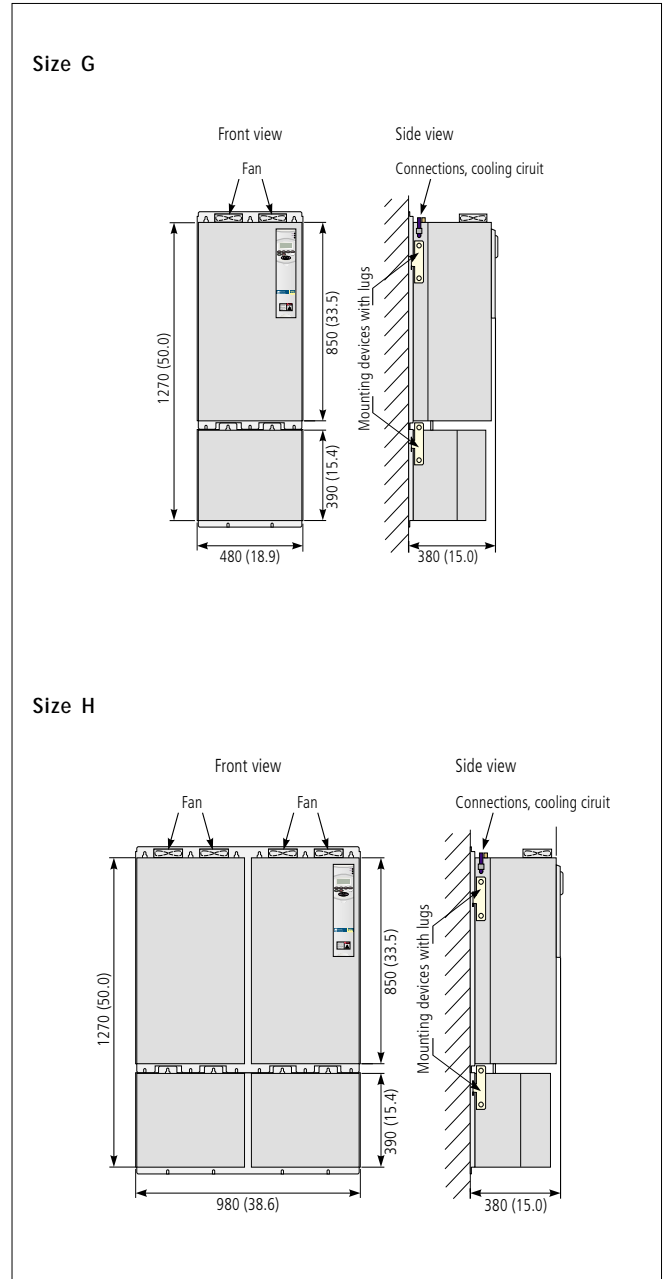
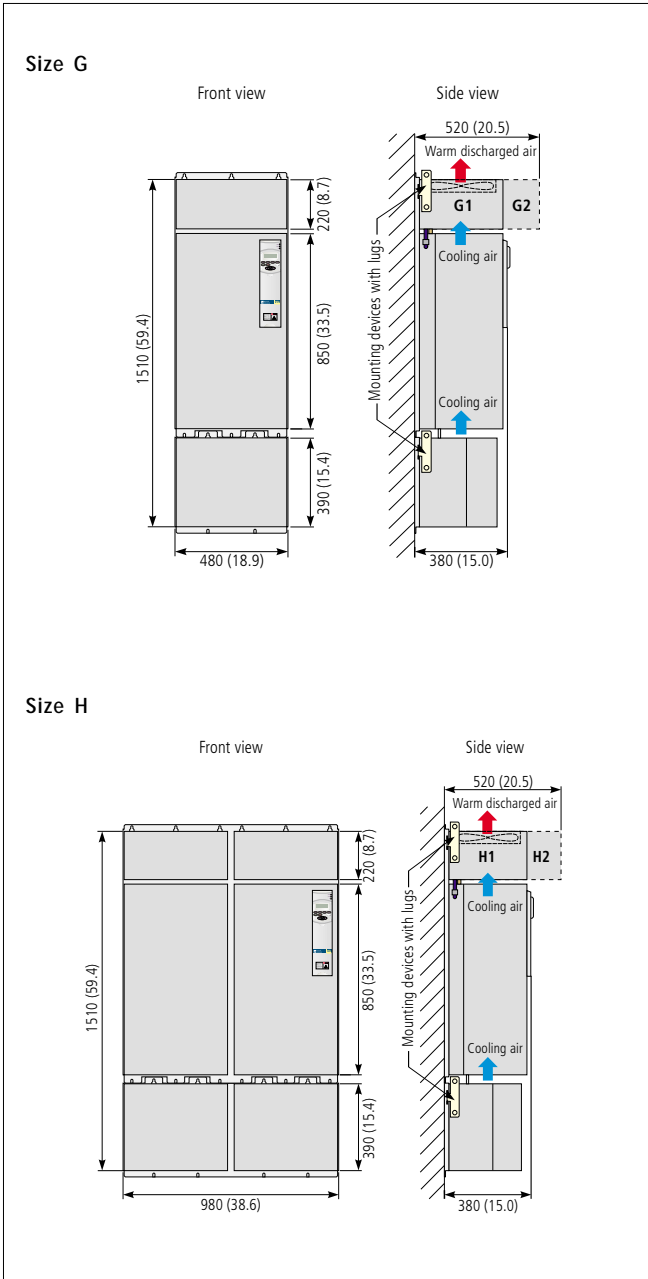

Size	Height		Width		Depth		Weight	
	mm	(inch)	mm	(inch)	mm	(inch)	kg	(lb)
G1	1510	(59.4)	480	(18.9)	380	(15.0)	180	(397)
G2	1510	(59.4)	480	(18.9)	520	(20.5)	180	(397)
H1	1510	(59.4)	980	(38.6)	380	(15.0)	358	(789)
H2	1510	(59.4)	980	(38.6)	520	(20.5)	358	(789)

Size	Height		Width		Depth		Weight	
	mm	(inch)	mm	(inch)	mm	(inch)	kg	(lb)
G1	1270	(50.0)	480	(18.9)	380	(15.0)	157	(346)
G2	1270	(50.0)	480	(18.9)	380	(15.0)	157	(346)
H1	1270	(50.0)	980	(38.6)	380	(15.0)	312	(688)
H2	1270	(50.0)	980	(38.6)	380	(15.0)	312	(688)

# REFUdrive 500

## Power Supply Modules

### RD41 Unregulated Power Supply Modules

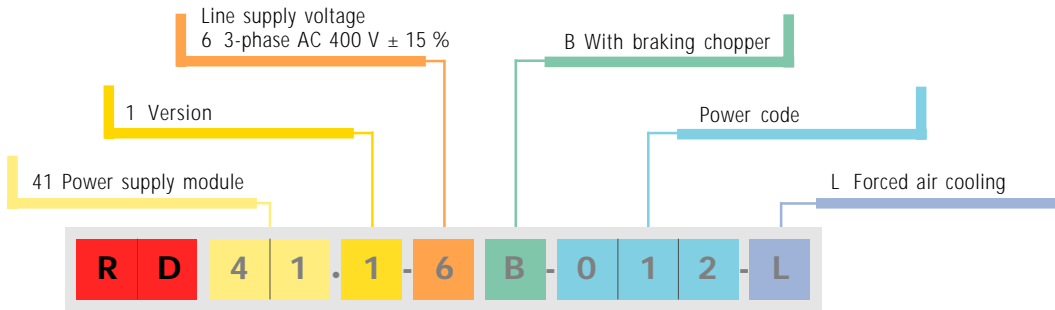

Rated output [kW] at 3-phase AC 400V	Power code	Rated current [A] in DC-link*	Braking resistor R <sub>min</sub> [Ohm]	Size	Relevant braking resistor power code**
12.5	012	25	20	A	011
25	025	50	7.5	A	030
50	050	100	5	B	075
100	100	200	3.75	C	050

\*overload capacity 1.5-times for 60 sec.  
\*\*see page 32

#### Dimensions

Size	Height		Width		Depth		Weight	
	mm	(inch)	mm	(inch)	mm	(inch)	kg	(lb)
A	500	(19.7)	120	(4.7)	360	(14.2)	22	(49)
B	500	(19.7)	240	(9.4)	360	(14.2)	36	(79)
C	990	(39.0)	240	(9.4)	360	(14.2)	58	(128)

Size A and B with integrated line filter  
Size C dimensions and weight include external line filter

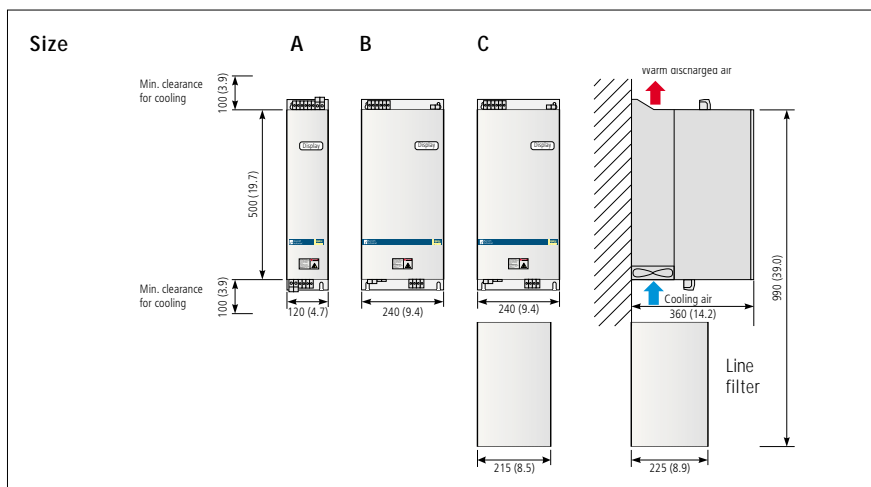

#### Selection

The net power consumption of the connected drives is used for selecting a suitable power supply module. This is calculated from the power difference of drives working as a regenerator and a motor at the same time plus the power loss of all drives.

#### Power supply modules

It is economical to supply multiple inverter modules from one common power supply module with drives that work in one common technological group. Via the inverter coupling in the DC-link, there is a power cancellation between drives working as a motor and a regenerator at the same time. Only the power difference

and the heat loss is taken from the incoming three phase supply network. The power supply module and other power supply devices such as transformers, switches, contactors etc. only need to be designed with the power necessary for the network. This can conserve a considerable amount of power, for example with wrappers.

If the power fed back in the DC-link regeneratively overbalances eg. when shut down, it is transformed into heat via a braking resistor unit connected to the power supply module.

# REFUdrive 500 Power Supply Modules RD42 Regenerative Power Supply Modules

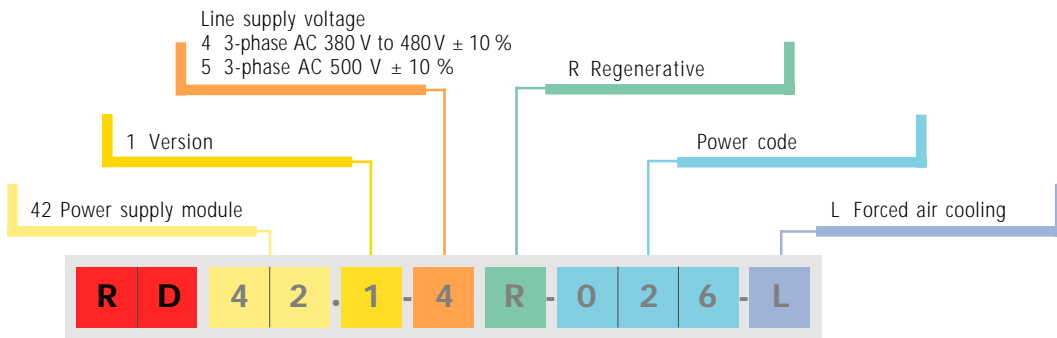

Rated output [kW] at 3-phase AC 400V	Power code	Rated output [kW] at 3-phase AC 500V	Rated current [A] in DC-link	Size
26	<b>026</b>	33	50	D
53	<b>053</b>	66	100	E
84	<b>084</b>	105	160	F
105	<b>105</b>	132	200	G

## Dimensions

Size	Height		Width		Depth		Weight	
	mm	(inch)	mm	(inch)	mm	(inch)	kg	(lb)
D	894	(35.2)	240	(9.4)	360	(14.2)	46	(101)
E	950	(37.4)	360	(14.2)	360	(14.2)	83	(183)
F	1050	(41.3)	360	(14.2)	360	(14.2)	88	(194)
G	1090	(42.9)	500	(19.7)	360	(14.2)	98	(216)

Sizes D to G dimensions and weight include external line filter

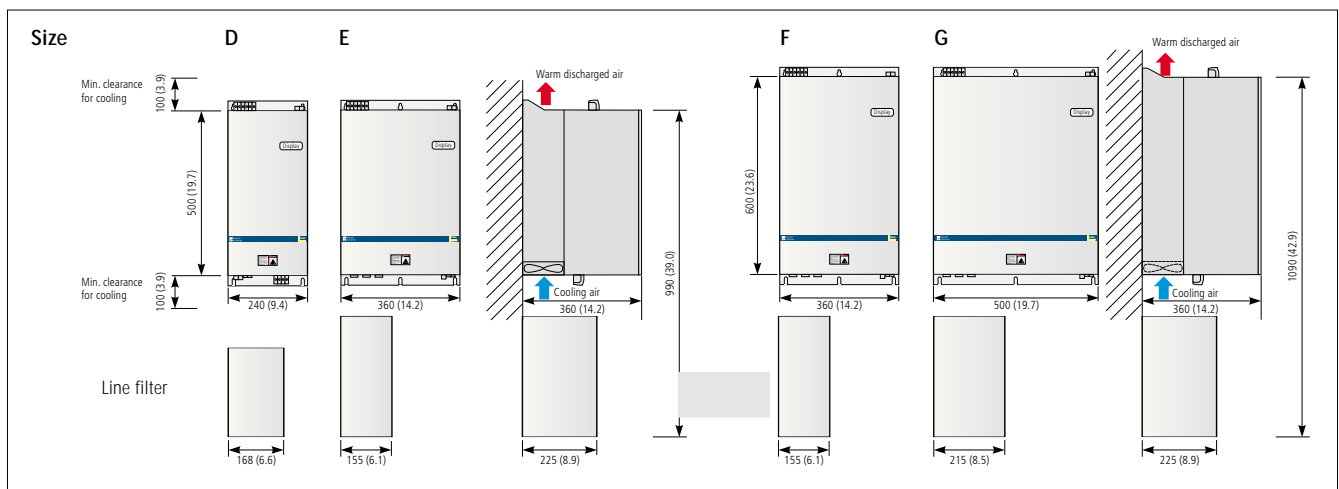

## Regenerative power supply modules

The use of regenerative power supply modules is recommended with predominantly generator-based operations or on those with large power demands. The devices from the RD42 range work with unregulated DC-link and block current.

## Selection

The net power consumption of the connected drives is used for selecting a suitable power supply module. This is calculated from the power difference of drives working as a regenerator and a motor at the same time plus the power loss of all drives.

# REFUdrive 500

## Inverters 1.5 to 110 kW

Output frequencies up to 200 Hz  
Technical Data

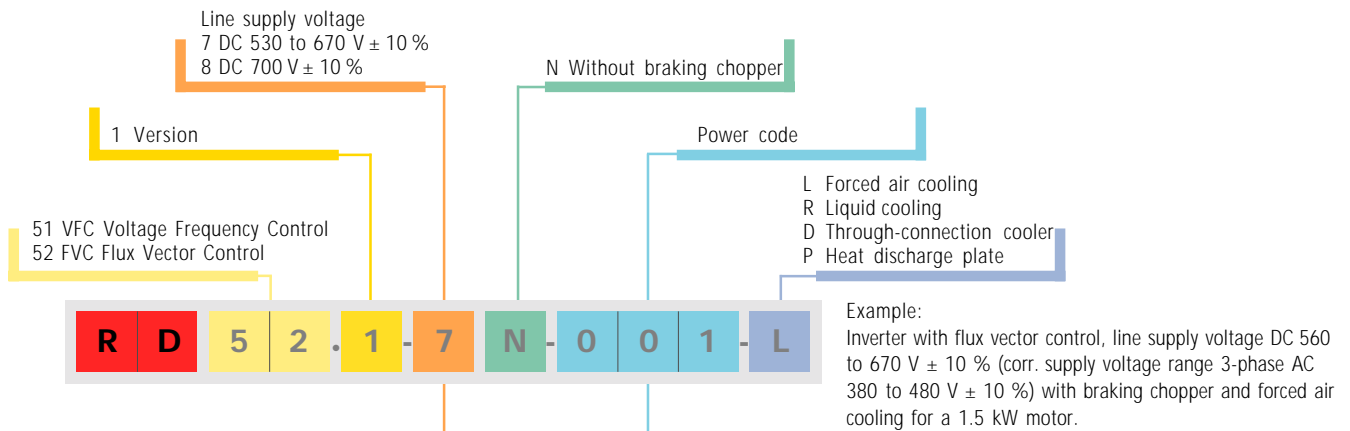

Rated motor output		Power code	Line supply voltage			Line supply voltage			Peak current			Size
[kW] <sup>1</sup> at 400 V	[kW] <sup>1</sup> at 500 V		DC 530...670 V ± 10 % <sup>2</sup> (corresponds to power supply 3-phase AC 380...480 V ± 10 %)	for 60 sec	for 1 sec	for 0.5 sec	DC 700 V ± 10 % (corresponds to power supply 3-phase AC 500 V)	for 60 sec	for 1 sec	for 0.5 sec		
Rated motor output		Rated current [A]	Peak current [A]			Rated current [A]			Peak current [A]			Size
1.5	2	001	4	5.2	6.8	8	3	3.9	5.1	6	A	
3	3	003	7.5	9.8	13	15	6	7.8	10	12	A	
4	5	004	10	13	17	20	8	10	14	16	A	
5.5	7.5	005	13	17	22	26	10	13	17	20	A	
7.5	10	007	18	23	31	36	14	18	24	28	A	
11	15	011	25	33	43	50	20	26	34	40	B	
15	20	015	30	39	51	60	24	31	41	48	B	
18.5	25	018	35	46	60	70	28	36	48	56	B	
22	30	022	43	56	73	86	34	44	58	68	C	
30	40	030	56	73	95	112	45	59	77	90	C	
37	50	037	68	88	116	136	54	70	92	108	C	
45	60	045	82	107	139	164	66	86	112	132	C	
55	75	055	99	129	168	198	80	104	136	160	D	
75	100	075	135	176	230	270	108	140	184	216	D	
90	125	090	165	215	281	330	130	169	221	260	E	
110	150	110	195	254	332	390	160	208	272	320	E	

<sup>1</sup> Maximum permitted motor output referring to a 4-pole standard motor. Voltage drops can occur due to control margins in the converter or when using inductors or filters between the drive converter and the motor.

<sup>2</sup> The rated current is linearly reduced starting at an output voltage  $V_a > 400$  V from 100 % to 83 % at  $V_a = 480$  V.

# REFUdrive 500 Inverters 1.5 to 110 kW

## Dimensions

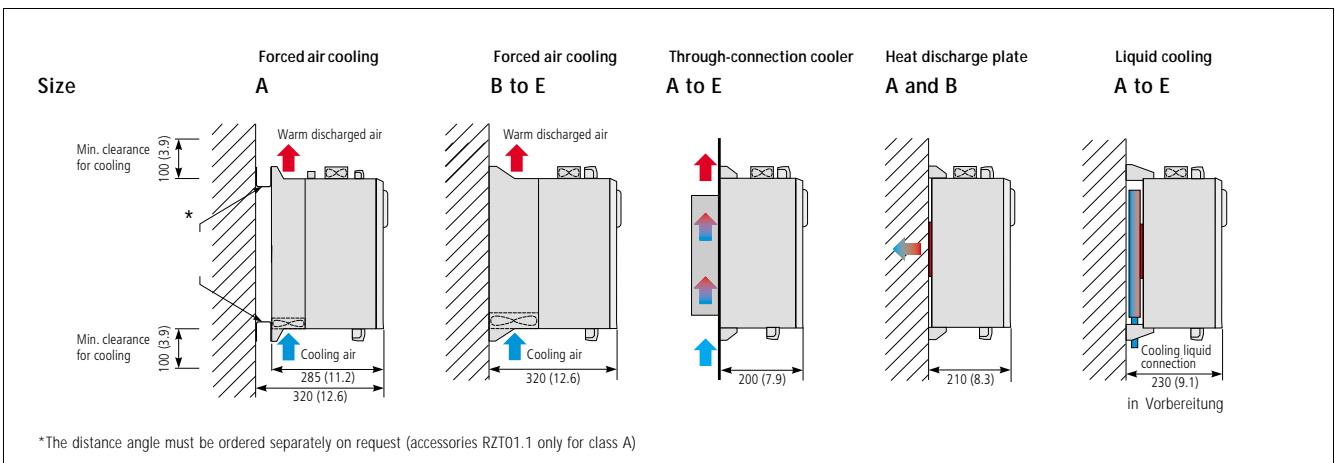
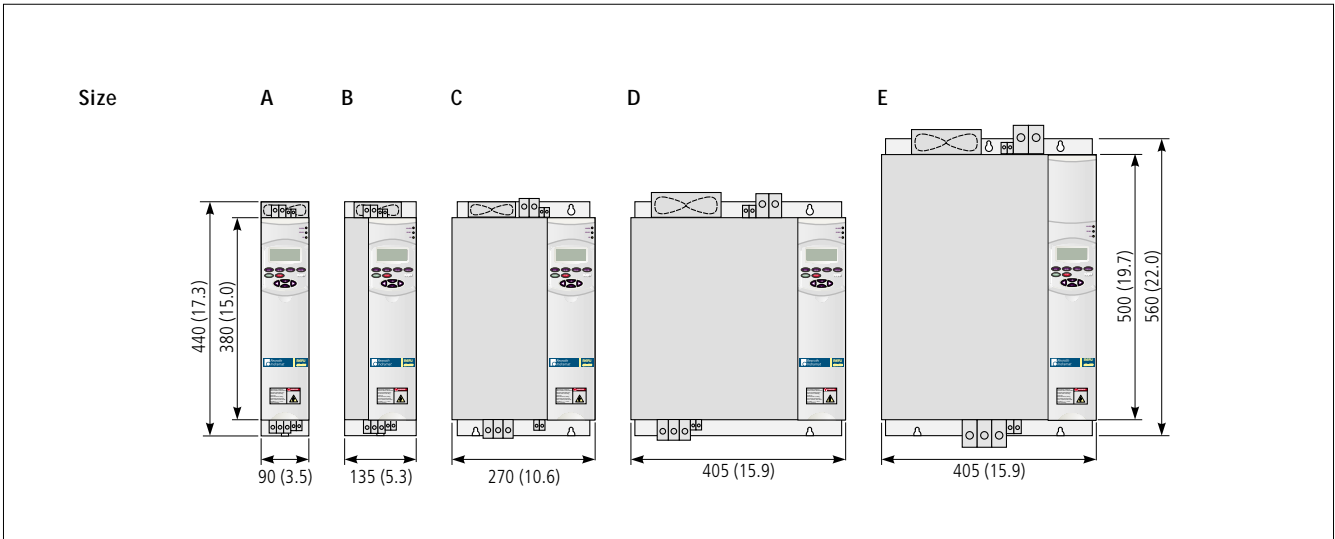

### L Forced air cooling

Size	Height		Width		Depth		Weight	
	mm	(inch)	mm	(inch)	mm	(inch)	kg	(lb)
A	380	(15.0)	90	(3.5)	285	(10.8)	11	(24)
B	380	(15.0)	135	(5.3)	320	(12.6)	14	(31)
C	380	(15.0)	270	(10.6)	320	(12.6)	25	(55)
D	380	(15.0)	405	(15.9)	320	(12.6)	38	(84)
E	500	(19.7)	405	(15.9)	320	(12.6)	61	(134)

### D Through-connection cooler

Size	Height		Width		Depth		Weight	
	mm	(inch)	mm	(inch)	mm	(inch)	kg	(lb)
A	380	(15.0)	90	(3.5)	200	(7.9)	11	(24)
B	380	(15.0)	135	(5.3)	200	(7.9)	14	(31)
C	380	(15.0)	270	(10.6)	200	(7.9)	25	(55)
D	380	(15.0)	405	(15.9)	200	(7.9)	38	(84)
E	500	(19.7)	405	(15.9)	200	(7.9)	61	(134)

### P Heat discharge plate

Size	Height		Width		Depth		Weight	
	mm	(inch)	mm	(inch)	mm	(inch)	kg	(lb)
A	380	(15.0)	90	(3.5)	210	(8.3)	7	(15)
B	380	(15.0)	135	(5.3)	210	(8.3)	9	(20)

### R Liquid cooling (in preparation)

Size	Height		Width		Depth		Weight	
	mm	(inch)	mm	(inch)	mm	(inch)	kg	(lb)
A	380	(15.0)	90	(3.5)	230	(9.1)	7	(15)
B	380	(15.0)	135	(5.3)	230	(9.1)	9	(20)
C	380	(15.0)	270	(10.6)	230	(9.1)	20	(44)
D	380	(15.0)	405	(15.9)	230	(9.1)	28	(62)
E	500	(19.7)	405	(15.9)	230	(9.1)	46	(101)

# REFUdrive 500 Inverters 132 to 400 kW

Output frequencies up to 200 Hz  
Technical Data

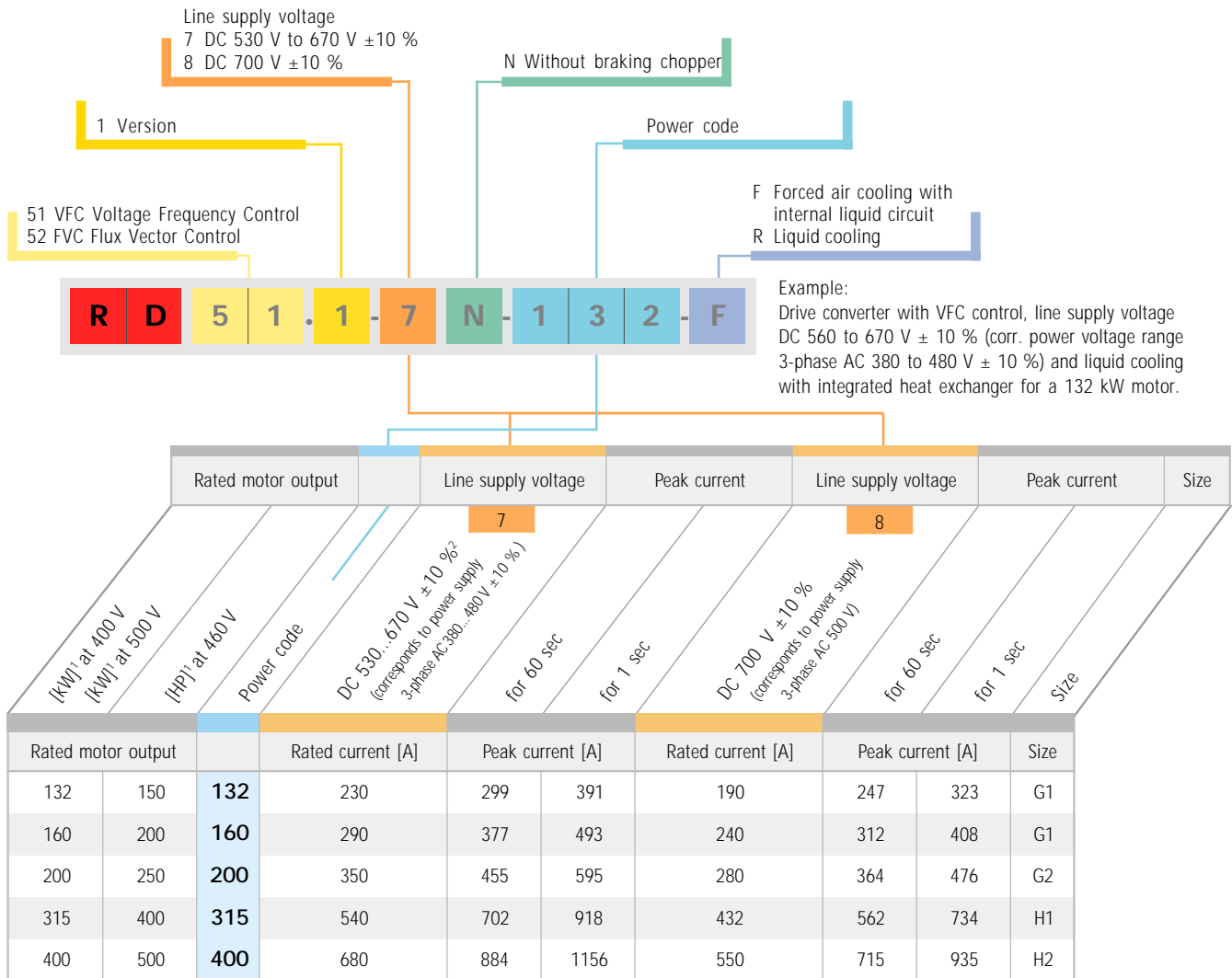

<sup>1</sup> Maximum permitted motor output referring to a 4-pole standard motor. Voltage drops can occur due to control margins in the converter or when using inductors or filters between the drive converter and the motor.

<sup>2</sup> The rated current is linearly reduced starting at an output voltage  $V_a > 400$  V from 100 % to 83 % at  $V_a = 480$  V.

The inverters for the power range 132 to 400 kW are designed with integrated motor filters for a 50 m motor cable.



# REFUdrive 500 Inverters 132 to 400 kW

Dimensions

## Cooling type F Forced air cooling with internal liquid circuit

## Cooling type R Liquid cooling

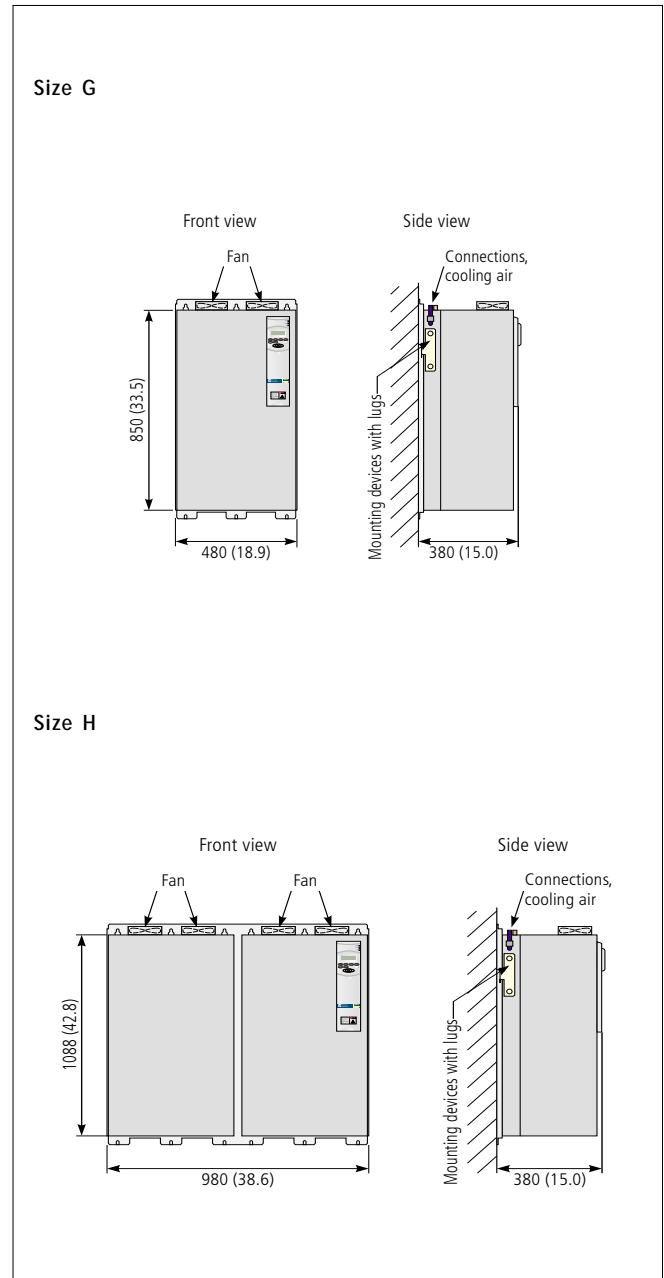
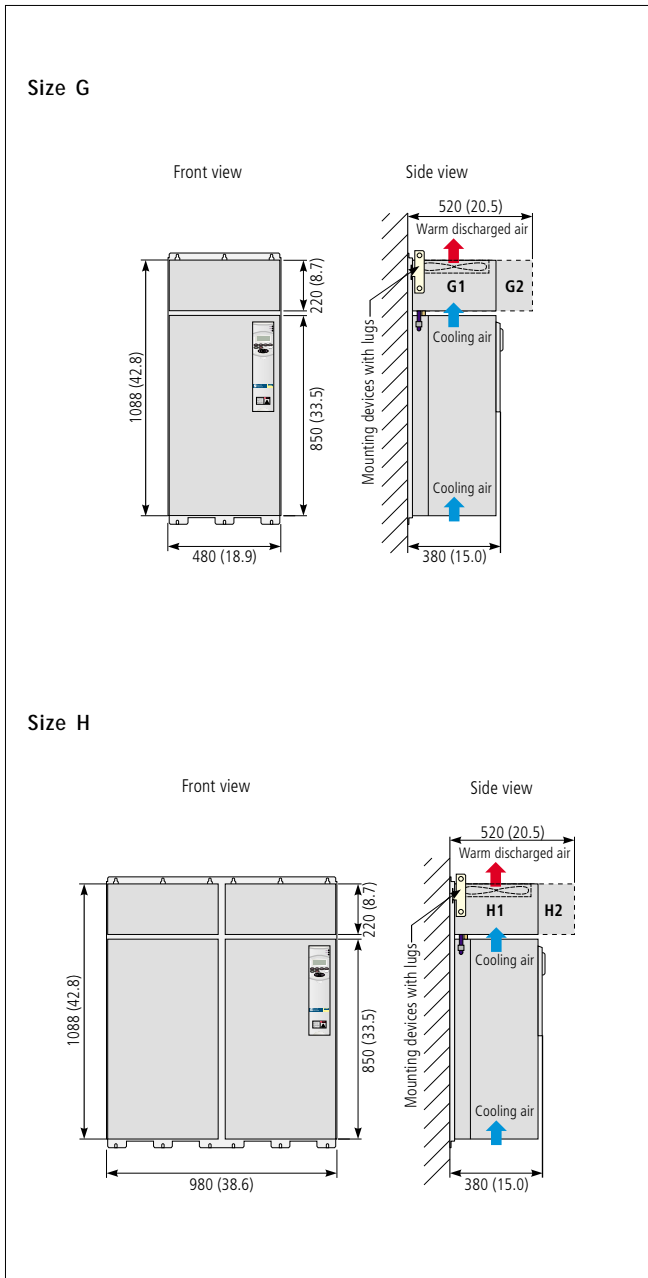

Size	Height		Width		Depth		Weight	
	mm	(inch)	mm	(inch)	mm	(inch)	kg	(lb)
G1	1088	(42.8)	480	(18.9)	380	(15.0)	127	(280)
G2	1088	(42.8)	480	(18.9)	520	(20.5)	127	(280)
H1	1088	(42.8)	980	(38.6)	380	(15.0)	252	(556)
H2	1088	(42.8)	980	(38.6)	520	(20.5)	252	(556)

Size	Height		Width		Depth		Weight	
	mm	(inch)	mm	(inch)	mm	(inch)	kg	(lb)
G1	850	(33.5)	480	(18.9)	380	(15.0)	104	(229)
G2	850	(33.5)	480	(18.9)	380	(15.0)	104	(229)
H1	850	(33.5)	480	(18.9)	380	(15.0)	206	(454)
H2	850	(33.5)	480	(18.9)	380	(15.0)	206	(454)

# REFUdrive 500 Accessories

## REFUwin

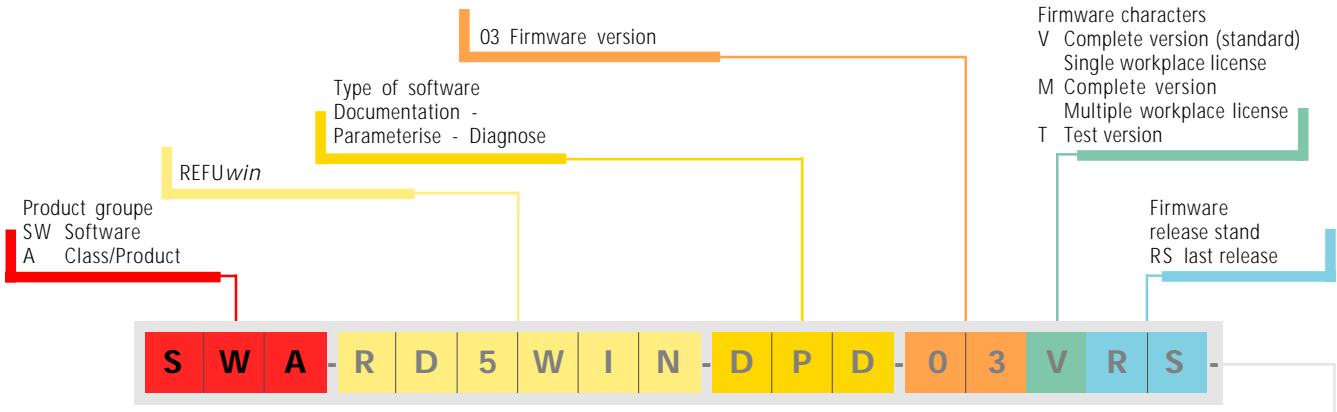

### Software tool REFUwin

REFUwin enables parameter sets to be saved and printed, simplifies error searches and thereby aids in starting up the system. REFUwin includes a 4-channel oscilloscope function with a sampling time from 0.2 msec to 500 msec. 512 measuring values are recorded in real time.

Included in the function library are:

- PID controller
- PI controller
- Logical function elements with two complementary outputs each: AND, OR, XOR, RS-Flip-Flop und D-Latch
- Mathematical function elements for addition, subtraction, multiplication and division

- Comparators
- Set integral memory
- Free characteristic curve with 10 interpolation points
- Timers
- Counters
- Sample & Hold
- Limiters
- Process data switches
- Friction characteristics with automatic recording routine

Complex drive tasks can also be easily carried out with these freely combinable functions.

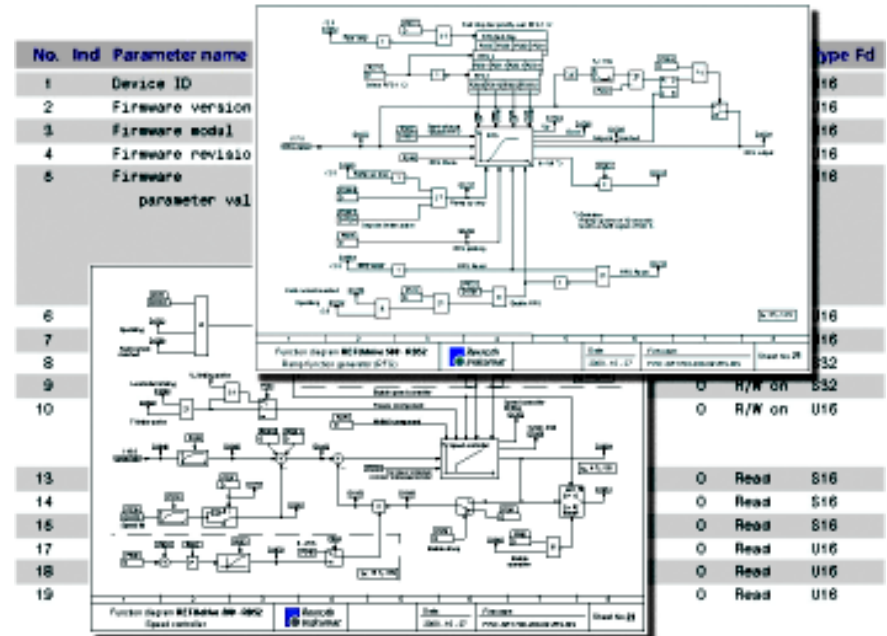
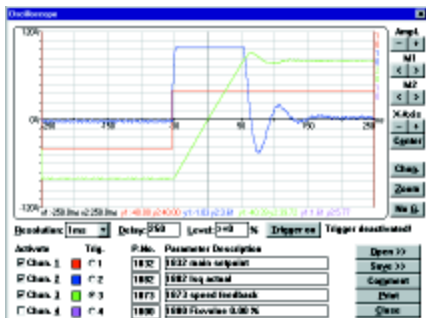
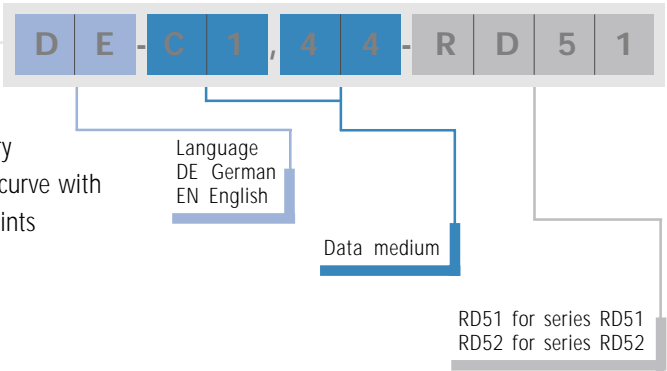

# REFUdrive 500 Accessories Operator Panel



Operator panel for cabinet installation

## Operator panel

The operator panel has a 4-lined graphics display with a multiple-language plain text display. The converters set of parameters can be saved in the operator panel. The parameters can also be quickly transferred to another converter without a PC. The set of parameters saved in the operator panel can be read out or transferred from the PC to the operator panel and saved there with the help of a PC adapter.

## Control console

For a fast and successful drive start up it is often necessary to simulate signals on the terminal strips before the machine control is finished or programmed. Therefore we offer a control console with switches, LEDs and potentiometers to simulate set values, inputs, outputs and motor temperature.

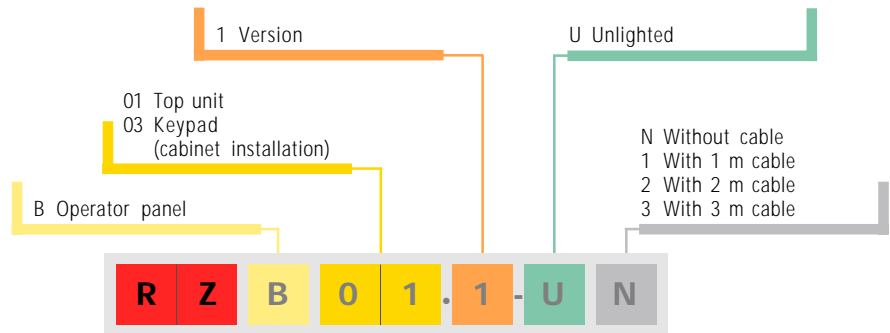

Option	Code	
Operator panel for RD 500 top unit	01	N
Operator panel for RD 500 for cabinet installation	03	1
- 1 m cable	03	2
- 2 m cable	03	3
- 3 m cable		
Degree of protection IP 54		
PC adapter for operating panel RZB incl. cable set, driver software, power supply	-	Order no.: RZA01.1
Control console	-	Order no.: RZB09.1-N

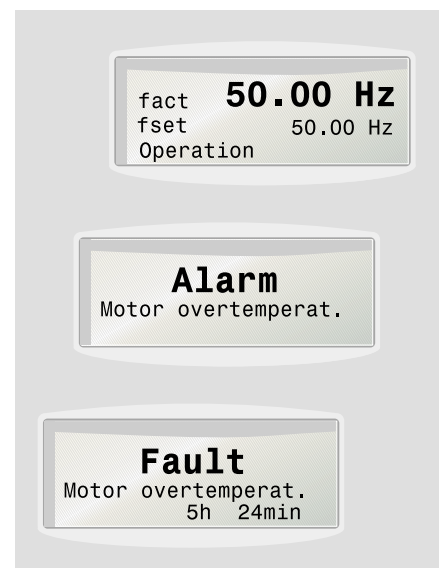
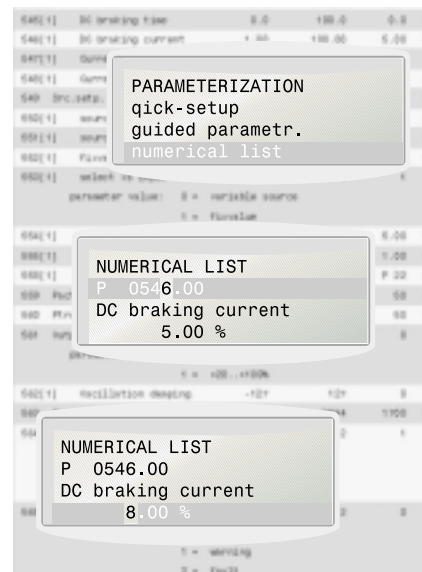

# REFUdrive 500 Accessories Options Module

The REFUdrive 500 can be integrated into the automation network quickly and easily using the following options. The field buses can also be achieved redundantly using the 2 module slots. The REFUdrive 500 can be parameterized completely via the bus ("down-load").

Interfaces RS 232 and RS 485 remain available during communication component use.

## Profibus DP Slave

Protocol: Profibus DP conforms to EN 50170 Volume 2 or DIN 19245 parts 1 and 3

Baud rate: 9.6 kBit/sec to 12 MBit/sec

## CANopen

Protocol: Basic profile (DS301)

I/O-profile (DS401)

Baud rate: 125 kBit/s, 250 kBit/s, 500 kBit/s, 1 MBit/s  
electrical isolation

## Interbus S Slave, Remote bus

Protocol: Interbus S-conform (DIN19258 or EN 50 254)

Baud rate: 500 kBit/s



P Options module

- C1 CANopen
- B1 Interbus S
- P1 Profibus DP
- L1 SynchroLink
- L2 Peer-to-Peer coupling
- G1 Incremental encoder emulation with resolver evaluation
- G2 Input for toothwheel encoder 1V<sub>pp</sub>, TTL, sin/cos and incremental encoder emulation
- G3 Incremental encoder emulation
- T1 Control terminal strip extension

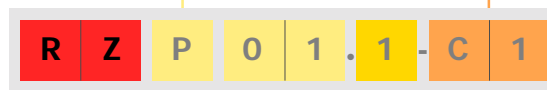

Options-module	Code
CANopen	C1
Interbus S	B1
Profibus DP	P1
Incremental encoder emulation with resolver evaluation	G1
Input for toothwheel encoder 1 V <sub>pp</sub> , TTL, sin/cos and incremental encoder emulation	G2
Incremental encoder emulation	G3
SynchroLink	L1
Peer-to-Peer coupling	L2
Control terminal strip extension	T1

G1, G2, G3 and L1: only for RD52

## Configuration Type Code



Object Group

CFG Configuration

Product Group

RD500 REFUdrive 500

Module slot 1 and 2

RD51.1			
B1-B1	B1-L2	B1-NN	B1-T1
C1-C1	C1-L2	C1-NN	C1-T1
	L2-NN	L2-T1	
	NN-NN	NN-T1	
P1-P1	P1-L2	P1-NN	P1-T1

RD52.1											
B1-B1	B1-G1	B1-G2	B1-G3	B1-L1	B1-L2	B1-NN	B1-T1				
C1-C1	C1-G1	C1-G2	C1-G3	C1-L1	C1-L2	C1-NN	C1-T1				
				G1-L1	G1-L2	G1-NN	G1-T1				
				G2-L1	G2-L2	G2-NN	G2-T1				
				G3-L1	G3-L2	G3-NN	G3-T1				
						L1-NN	L1-T1				
						L2-NN	L2-T1				
						NN-NN	NN-T1				
P1-P1	P1-G1	P1-G2	P1-G3	P1-L1	P1-L2	P1-NN	P1-T1				

If the options are fixed upon ordering of equipment, they are ordered via the configuration type code

## Converter communication

Coupling multiple REFUdrive 500 units to each other for quickly transferring controlled variables such as set and actual values. Transfer takes place quickly via fiber-optic cables and is immune to interference.

### SynchroLink

Baud rate: 10 MBit/s

- Synchronization impulse
- Complete duplex operation
- Bus monitoring, even on stand-by

Application areas:

- Angle synchronization
- Electric shaft
- Angle synchronized electric gears
- Converter synchronization

### Peer-to-Peer coupling

Baud rate: 230 kBit/s

Application areas:

- Speed synchronization
- Load distribution control
- Speed synchronized electric gears
- Set value cascading

## Electronic stand-by power supply

The control and regulation electronics can be supplied with external power in order to be able to access the REFUdrive 500's informational electronics even if the power is turned off. This option should be used when communication components are used.

Since this option is wired to power electronics components in the interior of the device we recommend ordering it together with the basic unit.

## Terminal strip extension

This option makes additional digital and analog inputs and outputs available.

	Standard in the converter	Terminal strip expansion
Digital inputs/outputs	3	-
Digital inputs	2	4 (isolated)
Relay outputs	1 changeover contact (AC 230 V / 7 A / DC 30 V / 7 A)	2 changeover contacts, 2 normally open contacts (DC 30 V / 2 A)
Analog input 0 to +10 V / 0 / 4 to 20 mA	1	1
Analog output 0 to 10 V 0 / 4 to 20 mA	1	2 (isolated)

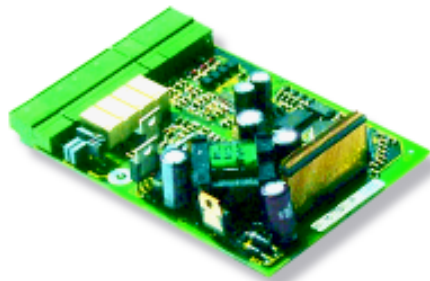

## Encoder evaluation

Encoder signals (also external) for speed and angle rotation are processed as an encoder simulation and issued as the new conductance.

# REFUdrive 500 Accessories

## Braking Resistors

### Description

There is an external braking resistor for every converter in the REFUdrive 500 series. The converter monitors the external braking resistor by calculating a thermal model with the current braking power using the firmware. If the limit values for the thermal model are exceeded, the converter turns off with a “braking resistor” error in order to protect the braking resistor from overloading.

### Assembly

A class C converter with the according braking resistor is shown in the drawing below.

### Note on resistor cooling

The braking resistors are designed, both in their construction and their nominal capacity, so that they should be cooled in the converter's exhaust air flow to prevent their surface temperature from exceeding 100°C (212°F).

**The resistors may not be operated at nominal capacity without air flow cooling!**

### Technical characteristics of high-load resistors

The braking unit resistors are composed of a highly durable metal plating. The resistor element is in an aluminum housing embedded in an insulating ceramic material with excellent thermal conductivity. Complete encapsulation offers protection from damaging ambient influences and accidental contact of live parts. High-load resistors have the following characteristics :

- Compact construction and light weight
- High capacity and pulse load
- Robust design
- High level of reliability
- High breakdown strength
- The resistor element is non-flammable

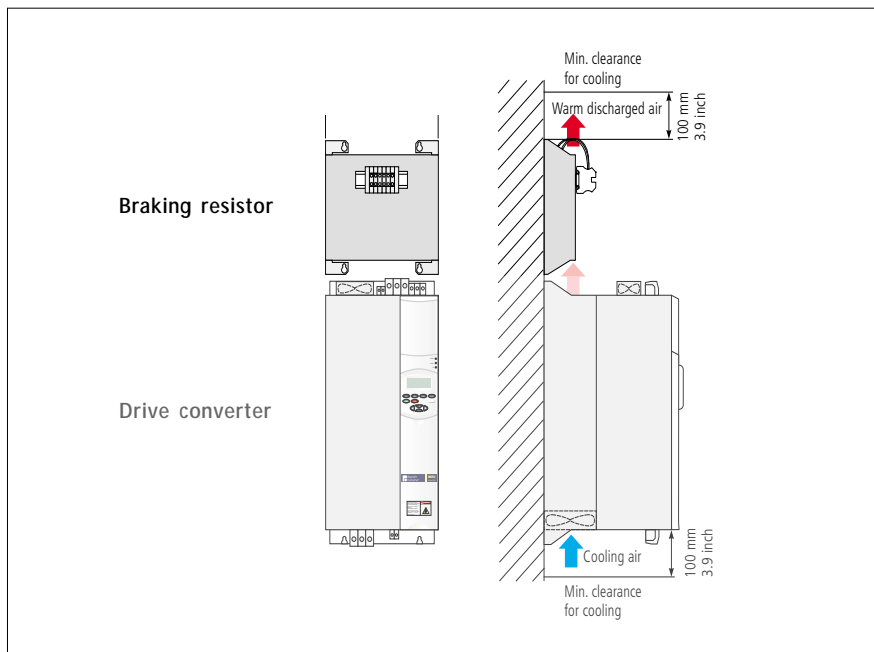

Further technical information can be found under the accessories description

# REFUdrive 500 Accessories Braking Resistors

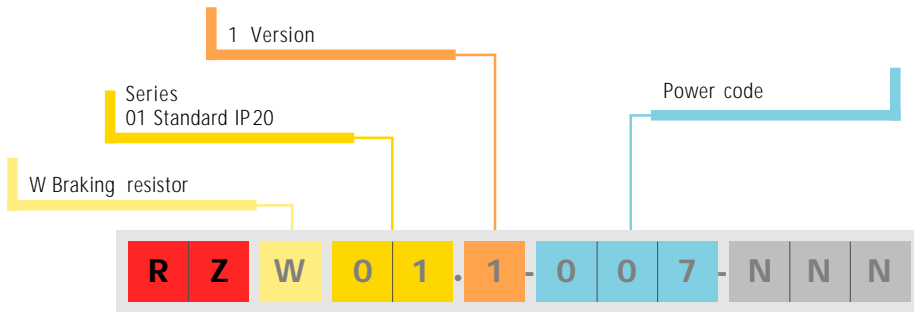

Converter performance code	Size	Power code	Resistance [Ohm]	Rated output [kW]	Maximum output [kW], 1 sec	Wire cross section [mm <sup>2</sup> ] (AWG)	Weight [kg] (lb)
001	A	<b>003</b>	60	0.06	10	1.5 (15)	1.5 (3)
003	A	<b>003</b>	60	0.06	10	1.5 (15)	1.5 (3)
004	A	<b>007</b>	35	0.1	18	1.5 (15)	1.5 (3)
005	A	<b>007</b>	35	0.1	18	1.5 (15)	1.5 (3)
007	A	<b>007</b>	35	0.1	18	1.5 (15)	1.5 (3)
011	B	<b>011</b>	20	0.18	32	2.5 (13)	2.3 (5)
015	B	<b>015</b>	17.5	0.2	37	2.5 (13)	2.3 (5)
018	B	<b>018</b>	13.3	0.25	48	4 (11)	3.1 (7)
022	C	<b>022</b>	11.7	0.3	56	10 (7)	3.4 (7)
030	C	<b>030</b>	8.8	0.4	74	10 (7)	4.2 (9)
037	C	<b>037</b>	7	0.5	93	10 (7)	4.8 (11)
045	C	<b>045</b>	5.8	0.6	111	10 (7)	5.6 (12)
055	D	<b>055</b>	5	0.7	130	10 (7)	7.1 (16)
075	D	<b>075</b>	4.4	0.8	148	10 (7)	7.9 (17)

## Technical Data

The converter to brake resistor assignment in the table must be observed since the appropriate brake resistor performance data for calculating the thermal image is saved in the converters.



# REFUdrive 500

## Accessories

### Braking Resistors

#### Dimensions

Size	Height		Width		Depth	
	mm	(inch)	mm	(inch)	mm	(inch)
A	285	(11.2)	90	(3.5)	125	(4.9)
B	285	(11.2)	135	(5.3)	125	(4.9)
C	285	(11.2)	268	(10.6)	125	(4.9)
D	285	(11.2)	403	(15.9)	125	(4.9)

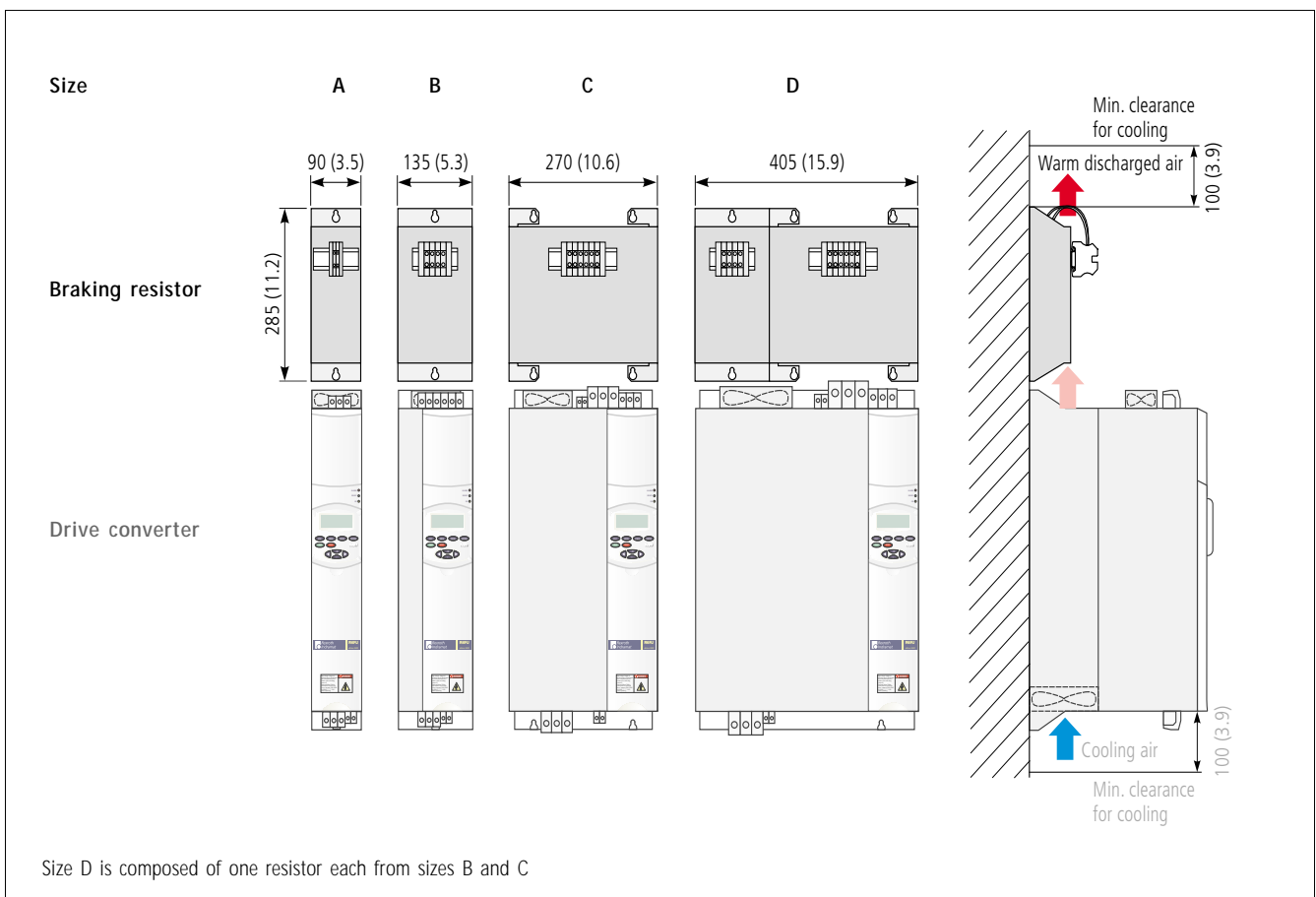

# REFUdrive 500 Accessories

## Reinforced Braking Resistors

### Description

Converters with an integrated braking chopper (types B and F) should be fitted with “reinforced braking resistors” for regenerative braking at higher performance levels as they occur in drives with larger flywheel loads (i.e. centrifuges) and long braking procedures (i.e. crane hoisting gear). The “reinforced braking resistors” are protected from overloading thanks to the monitoring function in the firmware REFUdrive500.

### Assembly

The types A and B resistor units are suited for vertical and/or horizontal assembly. The other types are to be assembled in a standing position.

### Technical characteristics

The model and dimension drawing of the corresponding resistor type can be found in the following list.

### For protection type IP20

Type A

Potted, wire-wound tubular fixed resistor units bolted with side pieces and perforated cover, mounting parallel to the mounting surface with 2 connections wired to porcellan terminals in the terminal box with a PU fitting.

Type B and C

Fixed resistor in a steel-grid version. Including 2 screw terminals, 2 M6 or M8 stud terminals, depending on the capacity, housing as described above.

Type D

Fixed resistor in a steel-grid version in a galvanized sheet steel housing with external ventilation via built-in axial-flow fans 3-phase AC/400 V/50 Hz/3,5 kVA, air flow monitoring via air-vane relays on terminals.

### For protection type IP 23

Type E

Wire-wound, multiple-disk resistor unit for wall mounting with 2 terminals and multiple drill holes which are closed by rubber grommets and are used as cable guides.

Type F

Fixed resistor in steel-grid model. Including 2 screw terminals, 2 M6, M8, M10 or M12 stud terminals, depending on the capacity.

Type G

Fixed resistor units in a steel-grid model with external ventilation via built-in axial-flow fans 3-phase AC/400 V/50 Hz/3.5 kVA, via air-vane relays on terminals.

The resistors are delivered with a galvanized sheet steel housing.

### Design

The resistor units are adjusted for the maximum motor output that can be connected to the converter. The braking power given applies to the relative ON-time (ED) named of 25 %, 40 %, 60 % and 100 %.

The relative ON-time refers to a duration of 120 sec. Example: at 40 % ED, the resistor may only be switched on a maximum of 48 sec ( $t_{ONmax}$ ) without interruption and then must be switched off for 72 sec. Shorter ON-periods are also permitted. The OFF-time required is reduced at the same ration. At an ON-period of 10 sec, for example, the resulting OFF-time is  $\frac{10sec}{48sec} \times 72 sec = 15 sec$ .

The full-load power of the relevant resistor type can be calculated with the help of the reduction factors given in the following tables. To do this, just divide the braking power for the corresponding ON-time (ED) by the reduction factor. Example:

Resistor type A3;

$$P_{peak} = 2.7 \text{ kW at } 25\% \text{ ED,}$$

$$\text{Reduction factor} = \frac{P_{peak}}{P_{duration}} = 3.2$$

$$P_{duration} = \frac{2.7 \text{ kW}}{3.2} = 0.844 \text{ kW}$$

### ON cycles

ED	100 %	60 %	40 %	25 %
$\frac{P_{peak}}{P_{duration}}$	1	1.5	2.2	3.2
$t_{ONmax}$	continuous	72 sec	48 sec	30 sec

# REFUdrive 500

## Accessories

### Reinforced Braking Resistors IP20 (Nema 1)

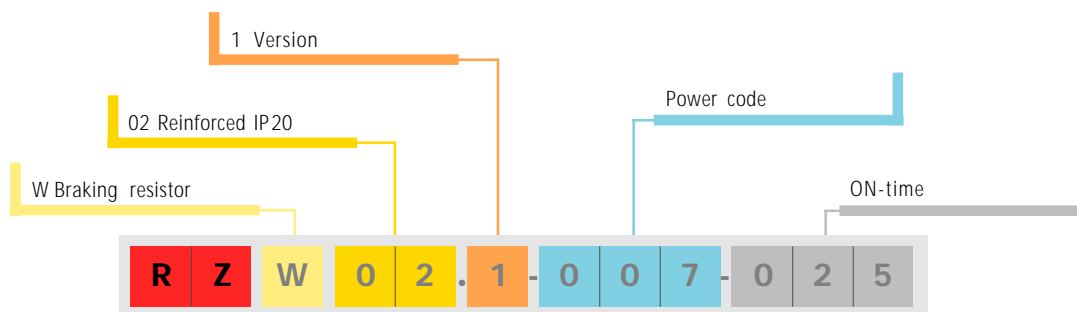

Converter output code	Minimum resistor value that can be connected [Ohm]	Maximum output [kW]	Size for ED 25 %	Resistance [Ohm]	Size for ED 40 %	Resistance [Ohm]	Size for ED 60 %	Resistance [Ohm]	Size for ED 100 %	Resistance [Ohm]
001	30	1.3	A1	120	A2	120	A3	120	A5	120
003	30	2.7	A3	68	A4	68	A6	68	A9	68
004	30	3.5	A4	47	A5	47	A8	47	B2	42
005	30	5	A7	47	A8	47	B2	42	B2	47
007	30	6.5	B1	33	B1	33	B2	33	B2	35
011	20	10	B1	23	B2	22	B3	23	B3	24
015	15	13.5	B2	16	B2	16	B3	16	B4	15
018	13.3	16.5	B2	16	B3	15	B4	13	B4	15
022	11.6	20	B3	14	B3	13	B4	13	B5	13
030	8.75	27	B3	10	B4	10	B5	11	C3	9.7
037	7	33	B3	7.3	B4	8.1	C3	7.2	C3	7.7
045	6	40	B4	7.3	B5	6.7	C3	7	C4	6.6
055	5	50	B5	5.1	C2	5.5	C4	5.4	C7	5.5
075	3.75	67	C2	5.4	C3	5	C6	5.3	2 x C4	10/2
090	2.5	81	C3	3.7	C4	3.7	C7	3.9	2 x C4	7.3/2
110	2.5	100	C5	2.6	C6	2.7	2 x C5	5.4/2	2 x C6	5.3/2
132	2.2	119	C4	2.4	C7	2.3	2 x C6	4.4/2	2 x C7	4.6/2
160	2.2	144	C6	2.4	2 x C3	4.8/2	2 x C7	4.8/2	D1	2.4
200	1.6	180	C7	1.8	2 x C4	3.5/2	D1	1.8	D2	1.8
315	1.1	280	2 x C6	2.4/2	D1	1.2	D2	1.2	D2	1.2
400	0.8	360	2 x C7	1.8/2	D1	1	D2	0.9	2 x D2	2.1/2

Note:

If two resistors are listed in one position (2 x ...), they are to be wired in parallel.

# REFUdrive 500 Accessories

## Reinforced Braking Resistors IP20 (Nema 1)

Type A

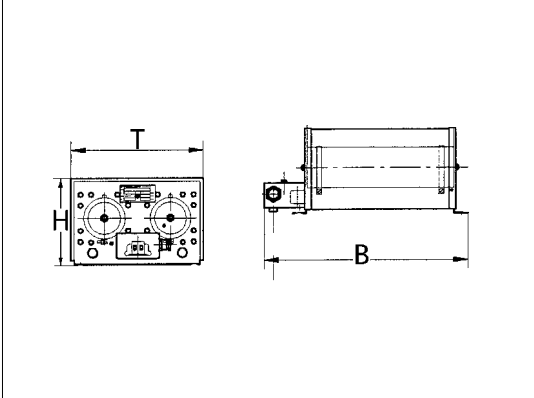

Type A	Height		Width		Depth		Weight	
	mm	(inch)	mm	(inch)	mm	(inch)	kg	(lb)
1	120	(4.7)	386	(15.2)	92	(3.6)	1.8	(4.0)
2	120	(4.7)	486	(19.1)	92	(3.6)	2.3	(5.1)
3	120	(4.7)	686	(27.0)	92	(3.6)	3.4	(7.5)
4	120	(4.7)	486	(19.1)	185	(7.3)	4.3	(9.5)
5	120	(4.7)	586	(23.1)	185	(7.3)	5.2	(11)
6	120	(4.7)	686	(27.0)	185	(7.3)	6.2	(14)
7	120	(4.7)	486	(19.1)	275	(10.8)	6.5	(14)
8	120	(4.7)	586	(23.1)	275	(10.8)	7.5	(17)
9	120	(4.7)	686	(27.0)	275	(10.8)	8.8	(19)

Type B

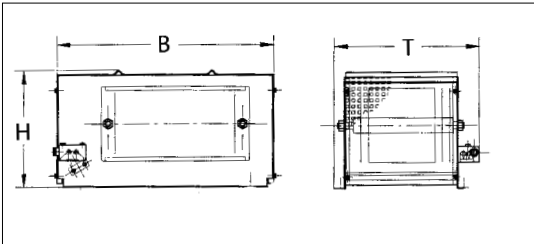

Type B	Height		Width		Depth		Weight	
	mm	(inch)	mm	(inch)	mm	(inch)	kg	(lb)
1	270	(10.6)	490	(19.3)	330	(13.0)	9	(20)
2	270	(10.6)	490	(19.3)	430	(16.9)	12	(26)
3	270	(10.6)	490	(19.3)	630	(24.8)	21	(46)
4	270	(10.6)	490	(19.3)	830	(32.7)	32	(71)
5	270	(10.6)	490	(19.3)	1030	(40.6)	43	(95)

Type C

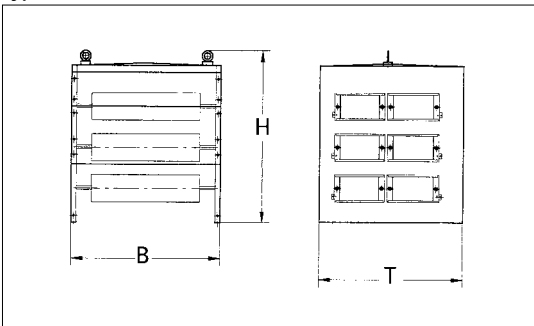

Type C	Height		Width		Depth		Weight	
	mm	(inch)	mm	(inch)	mm	(inch)	kg	(lb)
1	750	(29.5)	395	(15.6)	490	(19.3)	36	(79)
2	750	(29.5)	595	(23.4)	490	(19.3)	55	(121)
3	750	(29.5)	795	(31.3)	490	(19.3)	79	(174)
4	750	(29.5)	995	(39.2)	490	(19.3)	92	(203)
5	1000	(39.4)	595	(23.4)	490	(19.3)	74	(163)
6	1000	(39.4)	795	(31.3)	490	(19.3)	100	(220)
7	1000	(39.4)	995	(39.2)	490	(19.3)	123	(271)

Type D

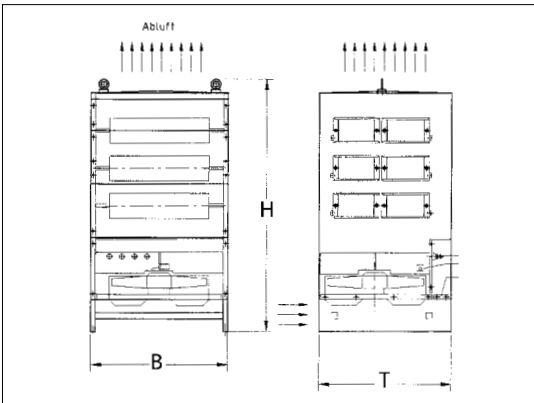

Type D	Height		Width		Depth		Weight	
	mm	(inch)	mm	(inch)	mm	(inch)	kg	(lb)
1	1450	(57.1)	995	(39.2)	955	(37.6)	250	(551)
2	1750	(68.9)	995	(39.2)	955	(37.6)	350	(772)

# REFUdrive 500

## Accessories

### Reinforced Braking Resistors IP23 (Nema 2)

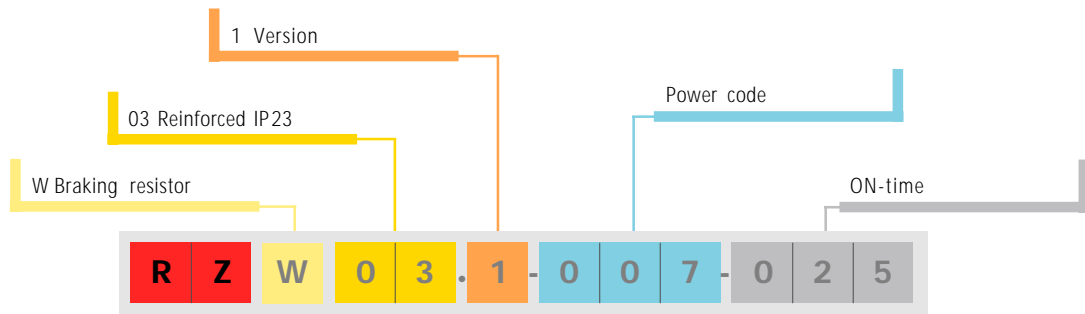

Converter output code	Minimum resistor value that can be connected [Ohm]	Maximum output [kW] at given ED	Size for ED 25 %	Resistance [Ohm]	Size for ED 40 %	Resistance [Ohm]	Size for ED 60 %	Resistance [Ohm]	Size for ED 100 %	Resistance [Ohm]
001	30	1.3	E1	120	E1	120	E2	120	E3	120
003	30	2.7	E2	68	E2	68	E3	68	E3	68
004	30	3.5	E2	47	E3	47	E3	47	F1	42
005	30	5	E3	47	E3	47	F1	42	F1	47
007	30	6.5	F1	33	F1	33	F1	33	F1	35
011	20	10	F1	23	F1	22	F2	23	F2	24
015	15	13.5	F1	16	F1	16	F2	16	F3	15
018	13.3	16.5	F1	16	F2	15	F3	13	F3	15
022	11.6	20	F2	14	F2	13	F3	13	F4	13
030	8.75	27	F2	10	F3	10	F4	11	F7	9.7
037	7	33	F2	7.3	F3	8.1	F7	7.2	F7	7.7
045	6	40	F3	7.3	F4	6.7	F7	7	F8	6.6
055	5	50	F4	5.1	F6	5.5	F8	5.4	F11	5.5
075	3.75	67	F6	5.4	F7	5	F10	5.3	2 x F8	10/2
090	2.5	81	F7	3.7	F8	3.7	F11	3.9	2 x F8	7.3/2
110	2.5	100	F9	2.6	F10	2.7	2 x F9	5.4/2	2 x F10	5.3/2
132	2.2	119	F8	2.4	F11	2.3	2 x F10	4.4/2	2 x F11	4.6/2
160	2.2	144	F10	2.4	2 x F7	4.8/2	2 x F11	4.8/2	G1	2.4
200	1.6	180	F11	1.8	2 x F8	3.5/2	G1	1.8	G2	1.8
315	1.1	280	2 x F10	2,4/2	G1	1.2	G2	1.2	G2	1.2
400	0,8	360	2 x F11	1,8/2	G1	1	G2	0.9	2 x G2	2.1/2

Note:

If two resistors are listed in one position (2 x ...), they are to be wired in parallel.

# REFUdrive 500 Accessories

## Reinforced Braking Resistors IP23 (Nema 2)

Type E

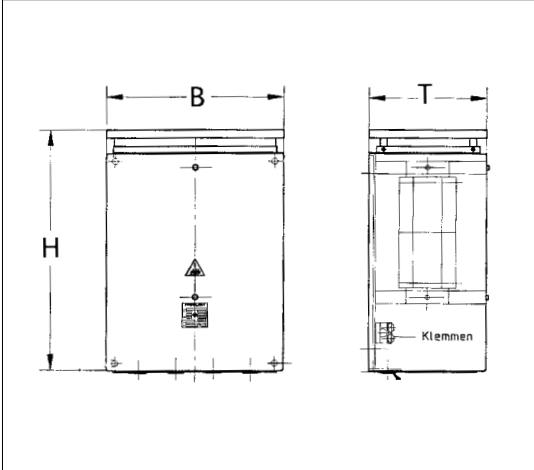

Type E	Height		Width		Depth		Weight	
	mm	(inch)	mm	(inch)	mm	(inch)	kg	(lb)
1	270	(10.6)	190	(7.5)	180	(7.1)	5	(11)
2	335	(13.2)	230	(9.1)	182	(7.2)	7	(15)
3	480	(18.9)	290	(11.4)	200	(7.9)	15	(33)

Type F

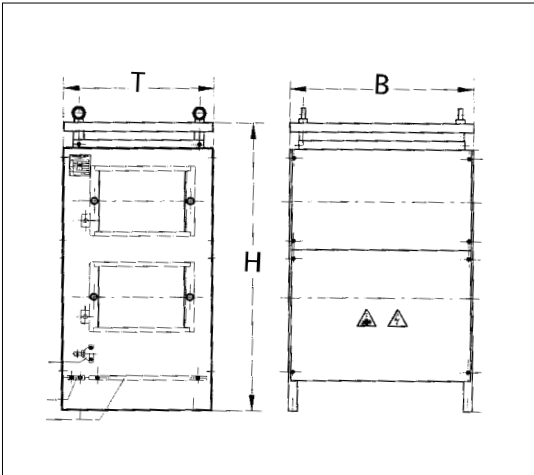

Type F	Height		Width		Depth		Weight	
	mm	(inch)	mm	(inch)	mm	(inch)	kg	(lb)
1	560	(22.0)	395	(15.6)	490	(19.3)	25	(55)
2	560	(22.0)	595	(23.4)	490	(19.3)	35	(77)
3	560	(22.0)	795	(31.3)	490	(19.3)	50	(110)
4	560	(22.0)	995	(39.2)	490	(19.3)	60	(132)
5	810	(31.9)	395	(15.6)	490	(19.3)	40	(88)
6	810	(31.9)	595	(23.4)	490	(19.3)	60	(132)
7	810	(31.9)	795	(31.3)	490	(19.3)	85	(187)
8	810	(31.9)	995	(39.2)	490	(19.3)	100	(220)
9	1140	(44.9)	595	(23.4)	490	(19.3)	0,8	(2)
10	1140	(44.9)	795	(31.3)	490	(19.3)	110	(243)
11	1140	(44.9)	995	(39.2)	490	(19.3)	135	(298)

Type G

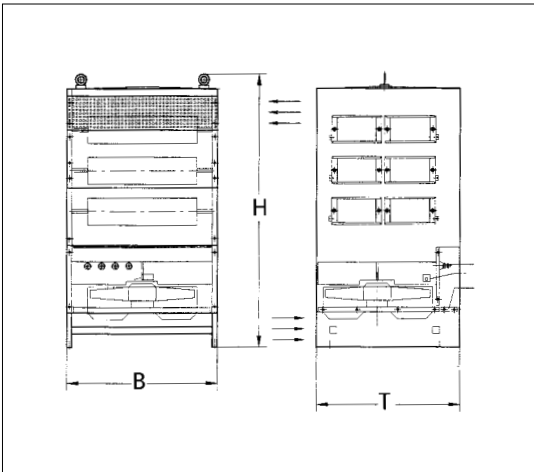

Type G	Height		Width		Depth		Weight	
	mm	(inch)	mm	(inch)	mm	(inch)	kg	(lb)
1	1450	(57.1)	995	(39.2)	955	(37.6)	260	(573)
2	1750	(68.9)	995	(39.2)	955	(37.6)	360	(794)

# REFUdrive 500 Accessories

## Motor Filter Output Frequency up to 200 Hz

### Description

The motor filter protects motors from transient voltage excesses and large voltage rising rates. The REFUdrive 500 can be used without restrictions on a wide range of three-phase machines with the advantages of today's IGBT technology with the motor filters especially developed by Indramat REFU and adjusted to the REFUdrive 500.

The maximum voltage peaks occurring on the motor terminal box are restricted, for example, to <1000 V at a motor cable length of 100 m and a line supply voltage of 400 V.

The filter must be used in motors without interphase insulation/separation in the winding overhangs. Otherwise the filter is only recommended for older motors.

Three-phase motors with today's insulation technology are also without filters and are suitable for operation on a converter without reducing the service life. When using long motor cables, the converters are additionally loaded due to the conversion currents in the cable capacities. By using a motor filter, the converter load can be considerably reduced.

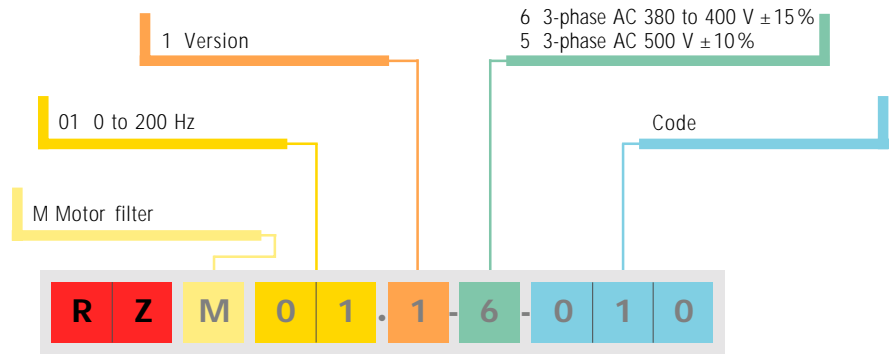

### Motor filter for line supply voltage 400 V

Converter output code	Code	Nominal current [A] (at 4 kHz)	Size	Power loss [W]
001 / 003 / 004	<b>010</b>	10	A	120
005 / 007 / 011 / 015	<b>030</b>	30	A	160
018 / 022 / 030	<b>056</b>	56	A	220
037 / 045 / 055	<b>099</b>	99	B	280
075 / 090	<b>165</b>	165	D	400
110 / 132	<b>230</b>	230	D	600
160 / 200	<b>350</b>	350	F	800

Pulse frequency	4 kHz
Max. output frequency	100 Hz
Max. motor cable lengths unshielded	300 m
Max. motor cable lengths shielded	150 m

### Motor filter for line supply voltage 500 V

Converter output code	Code	Nominal current [A] (at 4 kHz)	Size	Power loss [W]
001 / 003 / 004	<b>008</b>	8	A	140
005 / 007 / 011 / 015 / 018	<b>028</b>	28	A	190
022 / 030 / 037	<b>054</b>	54	B	250
045 / 055 / 075	<b>108</b>	108	C	440
090	<b>130</b>	130	E	650

Pulse frequency	4 kHz
Max. output frequency	100 Hz
Max. motor cable lengths unshielded	200 m
Max. motor cable lengths shielded	100 m

### Dimensions

Size	Height		Width		Depth	
	mm	(inch)	mm	(inch)	mm	(inch)
A	140	(5.5)	275	(10.8)	300	(11.8)
B	260	(10.2)	275	(10.8)	300	(11.8)
C	260	(10.2)	275	(10.8)	340	(13.4)
D	360	(14.2)	285	(11.2)	260	(10.2)
E	480	(18.9)	275	(10.8)	315	(12.4)
F	400	(15.7)	360	(14.2)	260	(10.2)

# REFUdrive 500 Accessories

## Sinusoidal Filter Output Frequency up to 200 Hz

### Description

The use of a sinusoidal filter is recommended to achieve sinusoidal current and voltage values at the converter output.

The sinusoidal filter developed especially for the REFUdrive 500 offers the following advantages:

- Limiting of the rate-of-rise time (du/dt) and the peak voltage value to 600 V at a motor cable length of 100 m and a line supply voltage of 400 V
- Reduction of winding insulation stressing
- Motors can be fed through long feeder cables (400 m)
- Operation of many parallel motors or group drives
- Reduction of supplementary losses in the motor
- Noise reduction of the motor
- Reduction of noise voltage on the motor feeder cable for increased EMC requirements.

The technically and commercially optimized combination of drive converter and sinusoidal filter can be achieved with a pulse frequency of  $\geq 8$  kHz. Our sinusoidal filters are therefore only designed for operating at a pulse frequency of 8 kHz. See the separate table on page 41 for drive converter "derating".

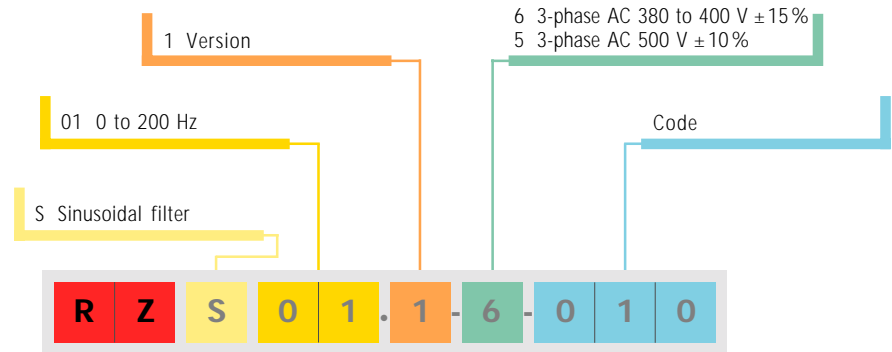

### Sinusoidal filter for line supply voltage 400 V

Converter output code	Code	Nominal current [A]	Size	Power loss [W]
001 / 003 / 004 / 005	010	10	A	60
007 / 011	020	20	B	120
015 / 018 / 022	035	35	C	150
030 / 037 / 045	068	68	C	200
055 / 075	099	99	D	300
090	135	135	E	400
110 / 132	195	195	E	600

Pulse frequency	8 kHz
Maximum output frequency	200 Hz
Maximum motor cable lengths unshielded	400 m
Maximum motor cable lengths shielded	200 m

### Sinusoidal filter for line supply voltage 500 V

Converter output code	Code	Nominal current [A]	Size	Power loss [W]
001 / 003 / 004	007	7	A	50
005 / 007 / 011	015	15	B	80
015 / 018	024	24	C	140
022 / 030	034	34	C	180
037	045	45	C	280
045 / 055	066	66	E	360
075	080	80	E	420
090	130	130	E	640

Pulse frequency	8 kHz
Maximum output frequency	100 Hz
Maximum motor cable lengths unshielded	400 m
Maximum motor cable lengths shielded	200 m

### Dimensions

Size	Height mm (inch)	Width mm (inch)	Depth mm (inch)
A	180 (7.1)	75 (3.0)	290 (11.4)
B	180 (7.1)	116 (4.6)	340 (13.4)
C	260 (10.2)	275 (10.8)	300 (11.8)
D	260 (10.2)	275 (10.8)	350 (13.8)
E	480 (18.9)	275 (10.8)	315 (12.4)



# REFUdrive 500 Accessories

## Radio Interference Suppression Filters B (Household Area)

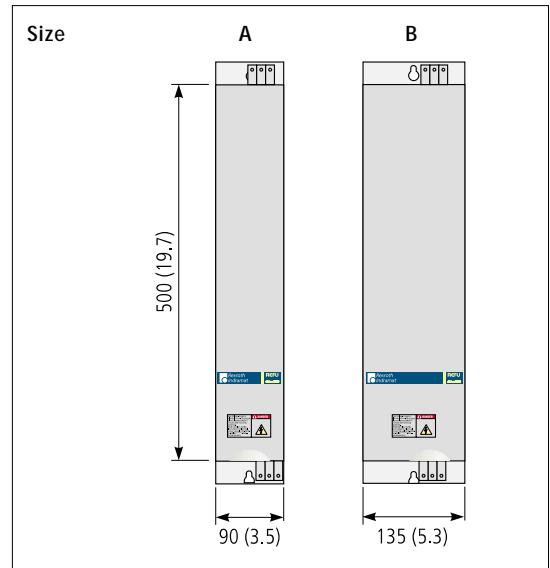
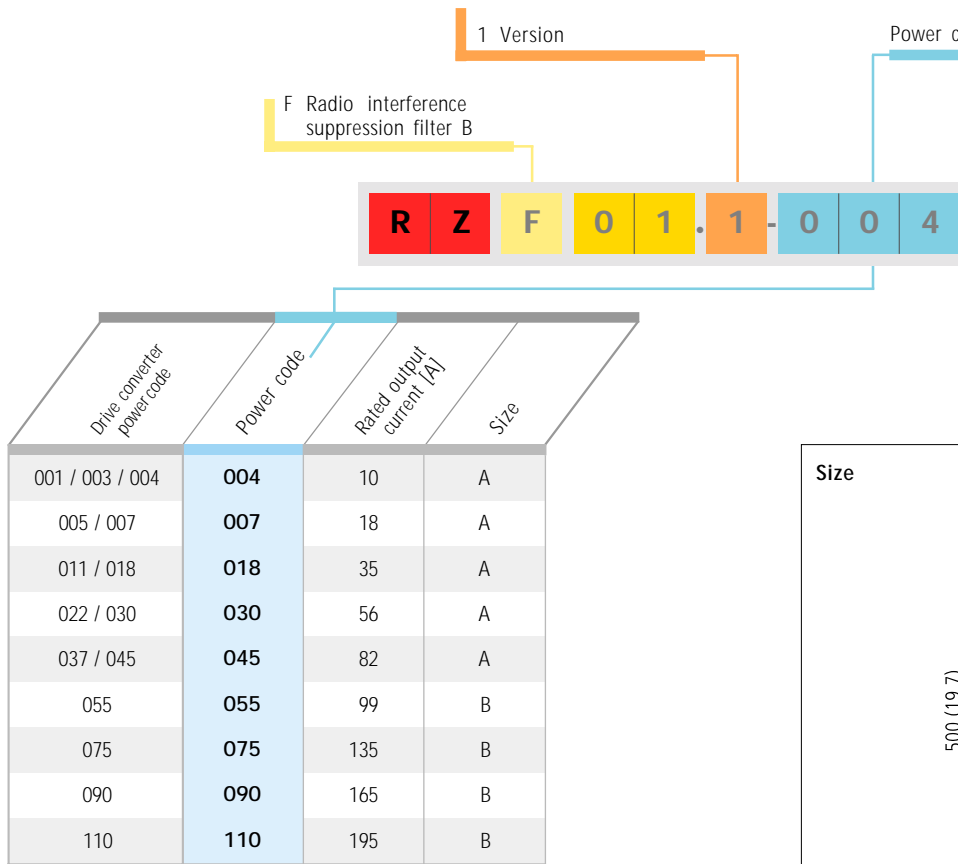

### Dimensions

Size	Height mm (inch)	Width mm (inch)	Depth mm (inch)	Weight kg (lb)
A	500 (19.7)	90 (3.5)	320 (12.6)	5 (11)
B	500 (19.7)	135 (5.3)	320 (12.6)	8 (18)

In compliance with the radio interference degree B according to EN 55011, the use of radio interference suppression filters are obligatory. They contain filters for both the line and motor and should be assembled next to the converter. Line and motor connections are on the filter. The cable connection to the converter is preassembled.

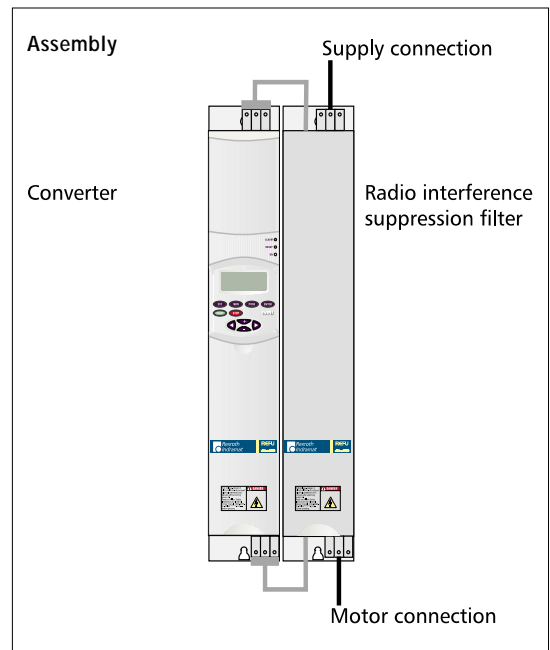

# REFUdrive 500 Accessories

## Heat Exchangers for External Assembly

The REFUdrive 500 line cooling system is designed for an ambient temperature of 40 °C (104 °F).

The nominal values in liquid-cooled systems refer to a coolant-entry temperature of 55 °C (131 °F). The coolant warms up between 3 °C (5 °F) and 5 °C (9 °F), depending on the performance. As many frequency converters can be connected to the heat exchanger until the sum of all individual converter losses does not exceed the cooling capacity of the heat exchanger.

The power code is to be used to assign the heat exchanger to the drive converter/ inverter.

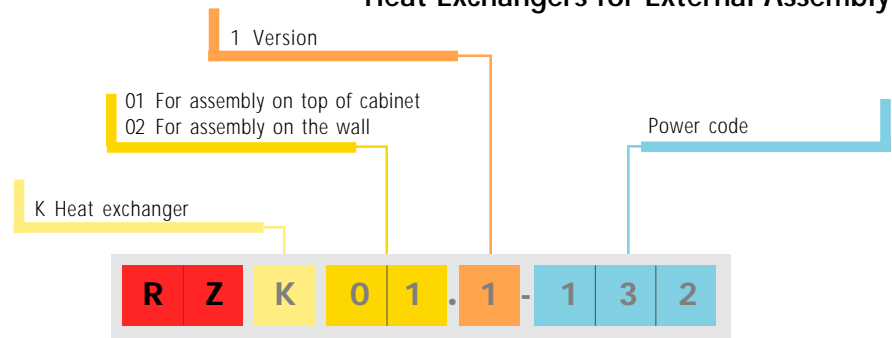

[kW]	[HP]	Power code	Resistance [Ohm]	Rated output [kW]	Maximum output [kW] (0.1 sec)	Heat-ex. capacity [kW]	Size
<b>Fan units for assembly on the top of the cabinet with braking resistor</b>							
132	150	<b>132</b>	2.2	2	270	4	A
160	200	<b>160</b>	2.2	2	270	4	A
200	250	<b>200</b>	1.6	2.5	370	5	B
315	400	<b>315</b>	1.1	4	540	8	A
400	500	<b>400</b>	0.8	5	740	10	B
<b>Fan units for assembly on the wall without braking resistor</b>							
132	150	<b>132</b>	—	—	—	4	A
160	200	<b>160</b>	—	—	—	4	A
200	250	<b>200</b>	—	—	—	5	B
315	400	<b>315</b>	—	—	—	8	A
400	500	<b>400</b>	—	—	—	10	B

### Dimensions

Size	Height		Width		Depth		Weight	
	mm	(inch)	mm	(inch)	mm	(inch)	kg	(lb)
A	340	(13.4)	495	(19.5)	350	(13.8)	16	(35)
B	340	(13.4)	495	(19.5)	510	(20.1)	23	(51)
C	365	(14.4)	480	(18.9)	360	(14.2)	16	(35)
D	365	(14.4)	480	(18.9)	520	(20.5)	23	(51)

### Heat exchanger assembled on top of cabinet

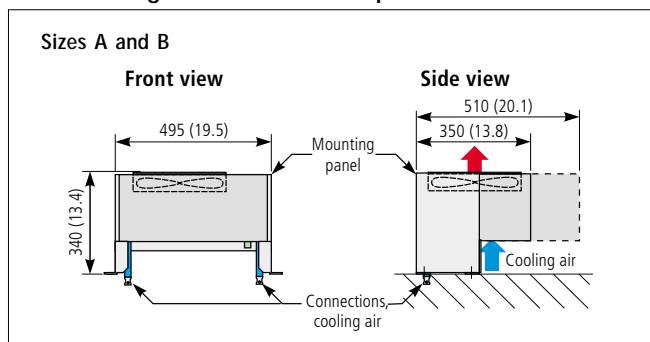

### Heat exchanger assembled on wall

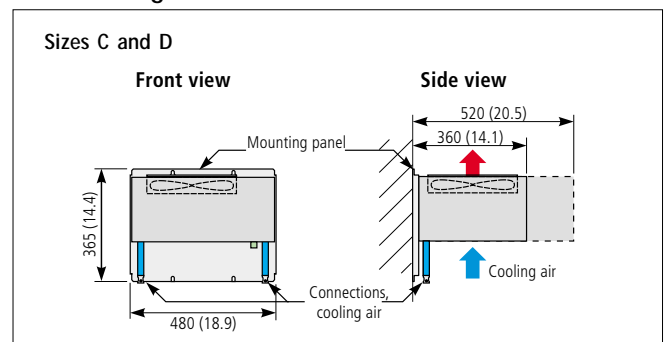

# REFUdrive 500 Accessories

For Water-Cooled Drive Converters/Inverters

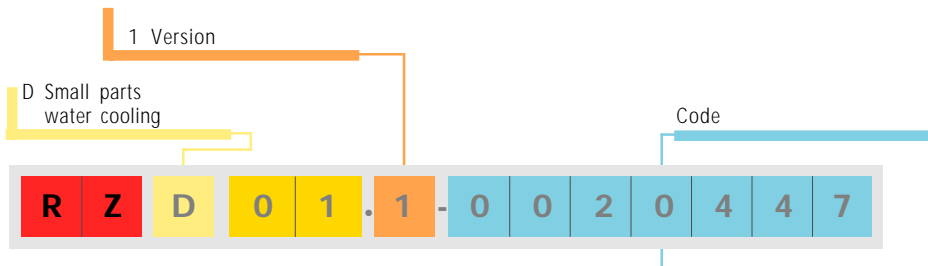













## Sizes A – E

An external circulation pump is necessary to circulate the coolant. The drive converter/ inverter size **A** to **E** with cooling type **R** (liquid cooling) can be connected to the customer's cooling water circuit with a PVC hose or, alternatively, with a soft polyamide tube (PA tube). Appropriate plug-in connections are present on the converters/inverters. The PVC hose is preferable to the PA tube because of the smaller bend when connecting the converters and inverters to each other (series connection). Hose nozzles should be installed on the converter/inverter side for connecting the PVC hose. The hose should be fixed to the nozzle using the worm drive hose clip. The PA tube can be inserted directly into the plug-in connections on the converter/ inverter cooler. The minimum bend is 100 mm (3.9 inches). We recommend appropriate connectors for extensions or branching and 90° curves.

## Sizes G + H

A circulation pump is necessary to circulate the coolant. The cooler hose mentioned can be used for connecting a drive converter/inverter of class G or H with cooling type R to the external heat exchanger. The quick-release lock connections given, product no. 0015559 or 0015558, should be used for connecting the converter or heat exchanger side. The cooler hose should also be attached with a worm drive hose clip. The couplers/plugs are self-locking which means that the coolant is prevented from running out when the connection is broken. A plug is installed on the converter/inverter and a coupling is on the heat exchanger. Appropriate connection pieces must be used for extensions and 90° curves. The hose should be attached to the connection pieces using a worm drive hose clip.

Converter/ Inverter size	Designation	Code
<b>A–E</b>		
	Hose plug-in nozzle RD 500 GK A-F	0020447
	Worm drive hose clip 16-27	0013457
	PVC hose with fabric insert	0020448
<b>Alternative connection system</b>		
	Polyamide tube (soft) 25 m rolls	0020449
	Plug-in connection, straight for polyamide tubes	0020450
	Elbow connector	0020451
	T-plug-in connector	0020452
<b>G + H</b>		
	Plug with hose nozzle HFCD2212-12	0015559
	Coupling with hose nozzle HF CD1712-12	0015558
	Coupling with bulkhead gland HFCD1612-35	0016765
	Cooler hose	0017446
	Hose coupling GS 19	0017510
	Elbow hose coupling WS 19	0020453
	Worm drive hose clip 32-50	0014497

# REFUdrive 500

## Derating with High Pulse Frequencies

Drive converter Inverter Power code	Operation at a pulse frequency of 4 kHz		Operation at a pulse frequency of 8 kHz		Operation at a pulse frequency of 10 kHz	Operation at a pulse frequency of 12 kHz
	Output frequency up to 400 Hz		Output frequency up to 800 Hz		Output frequency up to 1000 Hz	Output frequency up to 1400 Hz
Line supply voltage 3-phase AC-380...480 V ± 10% <sup>2</sup>	Line supply voltage 3-phase AC 500 V ± 10%	Line supply voltage 3-phase AC-380...480 V ± 10% <sup>2</sup>	Line supply voltage 3-phase AC 500 V ± 10%	Line supply voltage 3-phase AC 380... ...480 V ± 10% <sup>2</sup>	Line supply voltage 3-phase AC 380... ...480 V ± 10% <sup>2</sup>	Line supply voltage 3-phase AC 380... ...480 V ± 10% <sup>2</sup>
Rated current [A]						
001	4	3	3	2.4	2.6	2.2
003	7.5	6	5.8	4.5	4.9	4
004	10	8	7.5	6	6.5	5.5
005	13	10	10	8	8.5	7
007	18	14	13	10	12	10
011	25	20	18	14	16	13
015	30	24	25	20	22	18
018	35	28	30	24	26	22
022	43	34	35	28	33	30
030	56	45	43	34	39	35
037	68	54	56	45	48	40
045	82	66	68	55	60	52
055	99	80	82	66	75	68
075	135	108	99	80	90	80
090	165	130	135	108	108	80
110	195	160	135	108	108	80
132	230	190	195	160	168	140
160	290	240	230	190	200	170
200	350	280	280	240	245	210
315	540	432	400	345	355	310
400	680	550	540	432	468	395

<sup>2</sup> The rated current is linearly reduced starting at an output voltage  $V_{out} > 400$  V from 100 % to 83 % at  $V_{out} = 480$  V.

The permissible continuous currents of the drive converter/inverter are reduced when operating with higher pulse frequencies.

For all pulse frequencies, the short-term overload capacities apply:

Units up to power code 110:  
1.3-times for 60 sec; 1.7-times for 1 sec;  
2-times for 0.5 sec  
Units starting from 132 kW:  
1.3-times for 60 sec; 1.7-times for 1 sec

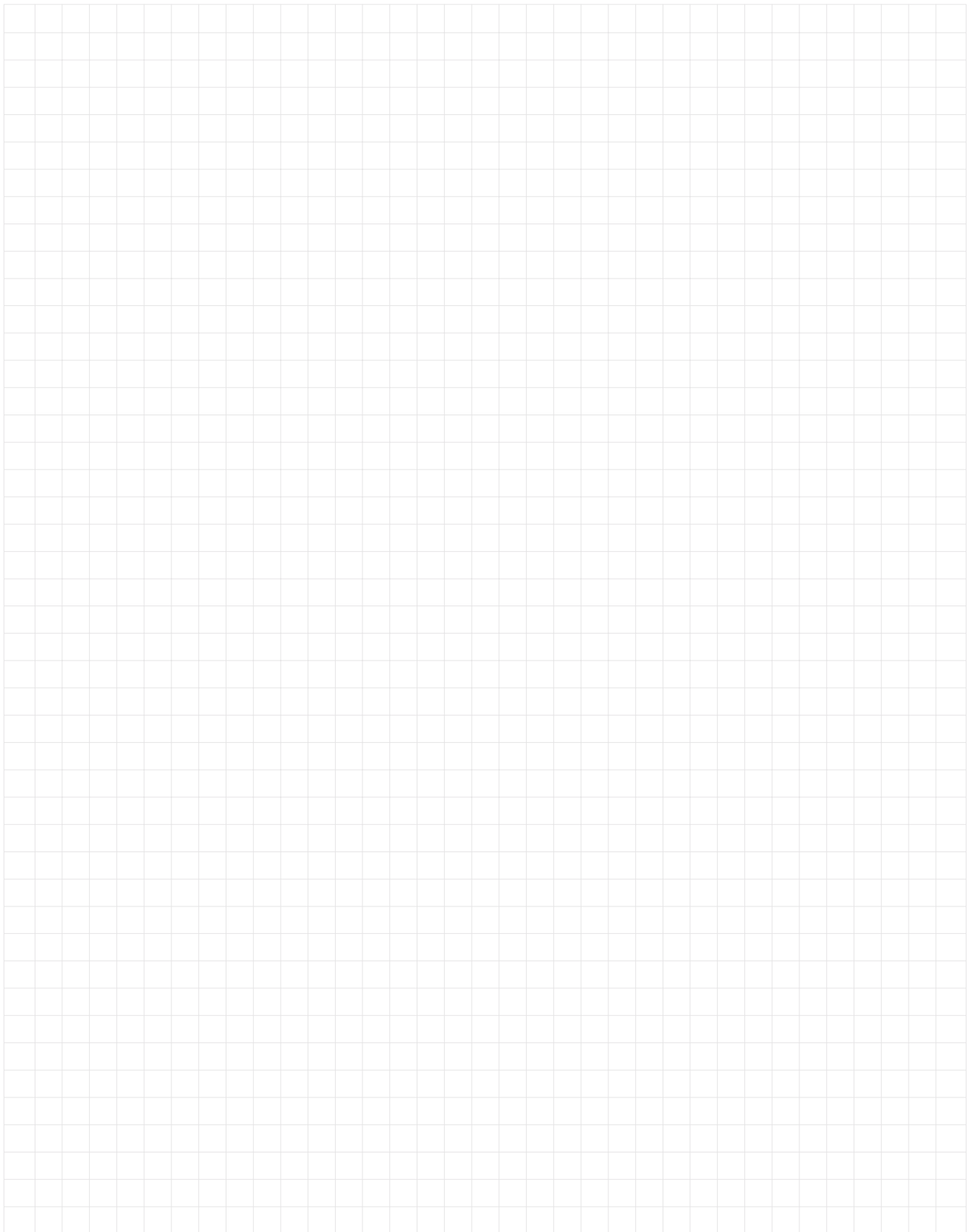

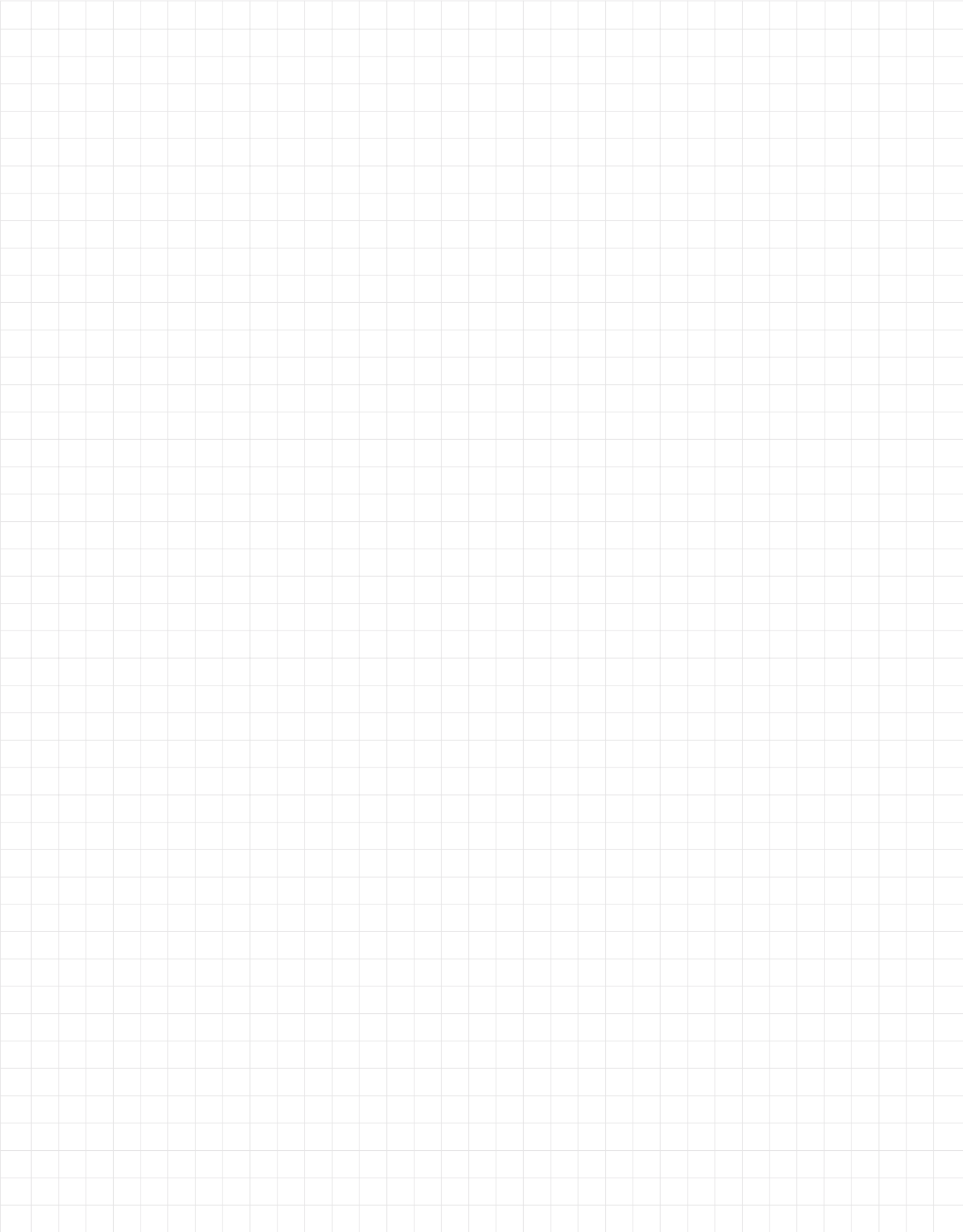

The data shown are for general information only.  
Please contact your local sales office for up-to-date information.

Presented by:

