

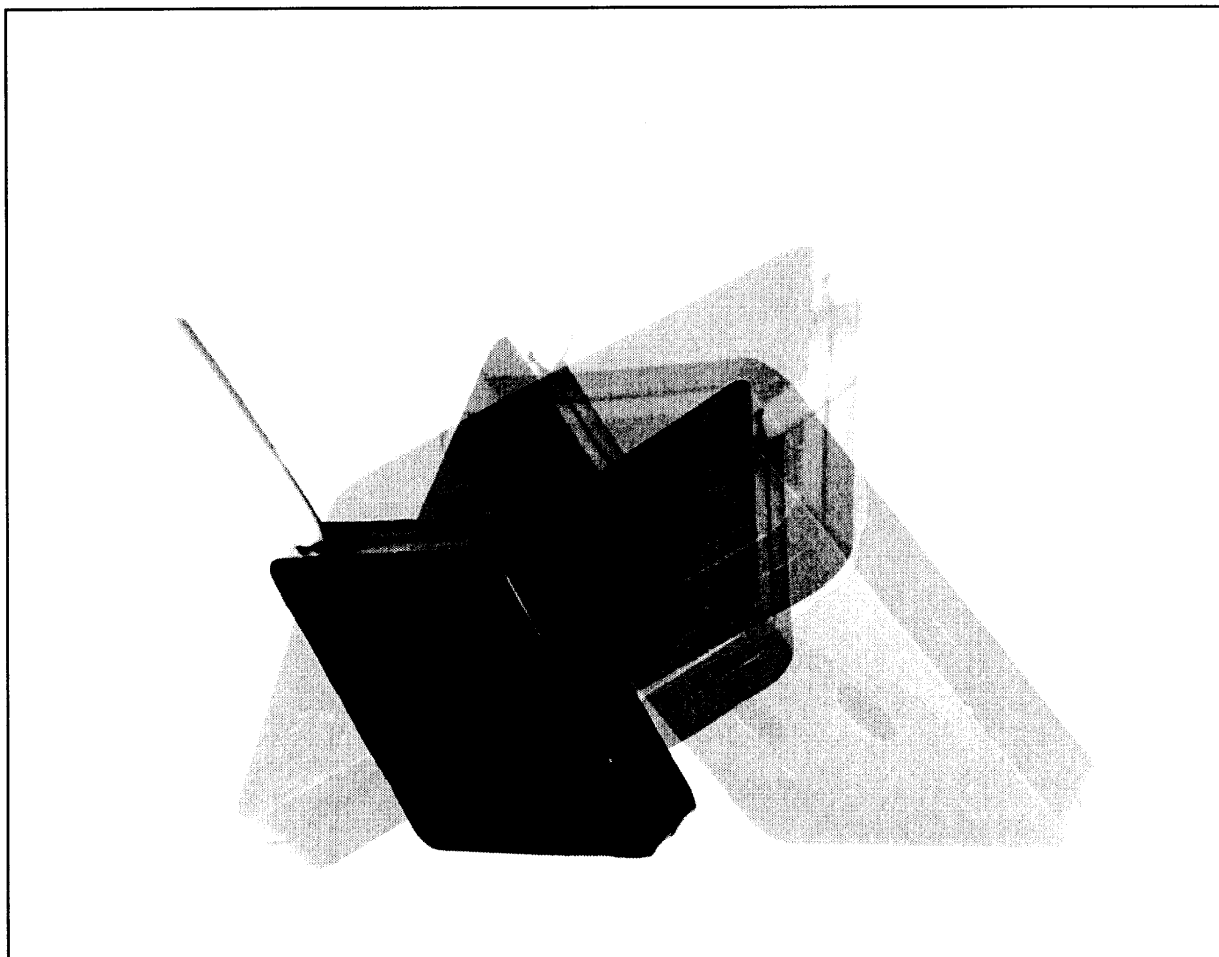

TECHNICAL SPECIFICATION SHEET

Switches: Tilt Switch Assemblies**Special Features**

- Sealed contacts
- Reliable switching
- Long life
- Non-toxic

Applications

- Safety systems
- Limit and position sensing
- Level sensing
- Security systems

This range of tilt switches offers the reliability of hermetically sealed reed switch contacts. The contacts will switch up to the maximum rating without the contact bounce/load problems normally associated with non-mercury tilt switches.

A full custom design service is available on this product range.

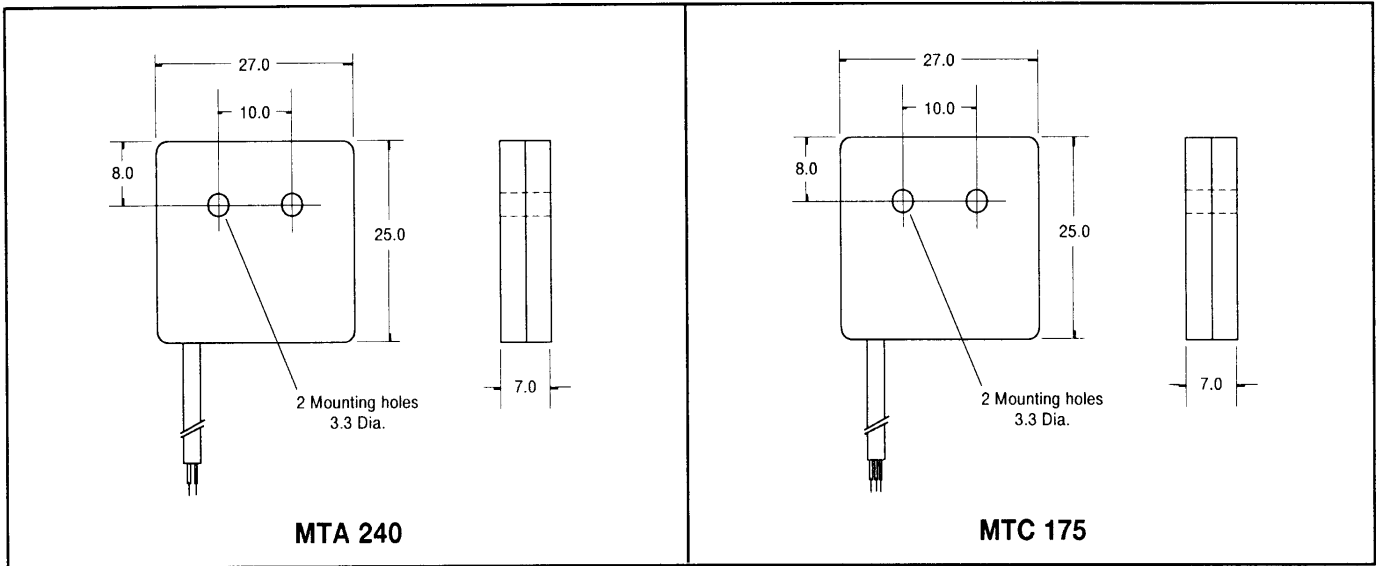

PART NUMBER		MTA 240	MTC 175
Switching Voltage	Max. Vac	240	175
Switching current	Max. A	0.50	0.25
Switching capacity	Max. VA	10	5
Contact resistance	Max. mΩ	150	150
Differential angle	Max. Deg. °C	90	120
Operating temperature	Deg. °C	-20° + 70°	-20° + 70°
Storage temperature	Deg. °C	-20° + 70°	-20° + 70°
Case material		ABS	ABS
Mechanical life	Min.	10 ⁵	10 ⁵
Terminations		<p>2 x round 0.14mm² PVC covered and insulated</p>	<p>3 x round 0.14mm² PVC covered and insulated</p> <p>Cable identification White: Common Brown: Normally closed Green: Normally open</p>

SWITCH OPERATION - Switches will operate in horizontal and vertical planes

A Sense-Rite product
Distributed by Assemtech Europe Limited

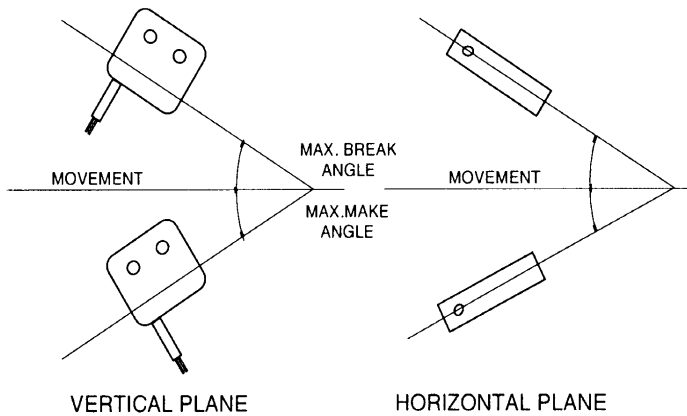

	Max. Break angle	Max. Make angle
MTA 240	45°	45°
MTC 175	75°	45°

These switches are sensitive to magnetic fields and ferrous materials.
Care should be taken when housing. Switches should not be fitted to ferrous materials.

006/1295 ISS 1

As part of our company policy of continued product improvement, specifications may change without notice. Please contact sales office for latest information.



Part of the

For further details contact:

ASSEMTECH EUROPE LIMITED

Rice Bridge Industrial Estate

Thorpe-le-Soken, Essex, England CO16 0HH

Telephone: 01255 862236 / 862001 Fax: 01255 862014



BS5750/ISO 9002
Reg. No. FM/2408