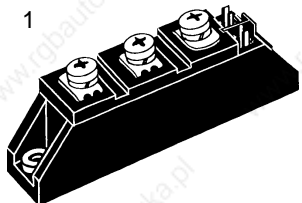
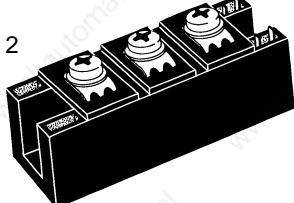
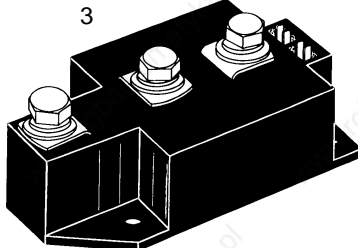
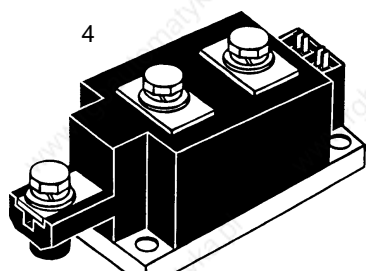
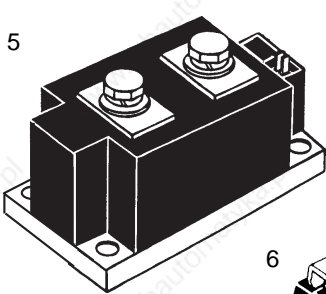
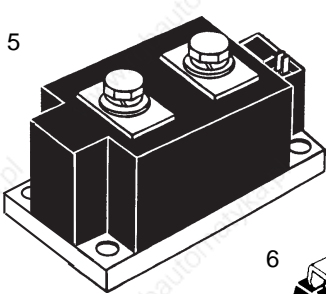
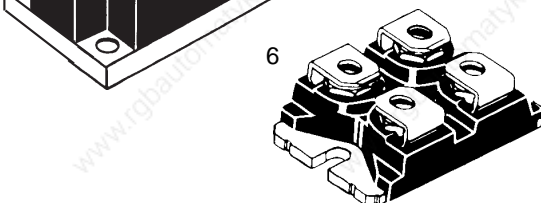


Package style	I <sub>TAVM</sub> I <sub>FAVM</sub> A	V <sub>RRM</sub> / V <sub>DRM</sub> (V)						Type	Page	
		800	1200	1400	1600	1800	2000			2200
<b>Thyristor Modules</b>										
	25	●	●	●	●			<b>MCC 19</b>	E2 - 2	
	21			●	●			<b>MCC 21</b> <i>new</i>	E2 - 6	
	32	●	●	●	●			<b>MCC 26</b>	E2 - 8	
	51	●	●	●	●	●		<b>MCC 44</b>	E2 - 14	
	60	●	●	●	●	●		<b>MCC 56</b>	E2 - 18	
	64				●	●		<b>MCC 60</b> <i>new</i>	E2 - 22	
	115	●	●	●	●	●		<b>MCC 72</b>	E2 - 24	
	104					●	●	<b>MCC 94</b>	E2 - 28	
	116	●	●	●	●			<b>MCC 95</b>	E2 - 30	
	130	●	●	●	●			<b>MCC 122</b> <i>new</i>	E2 - 34	
	130	●	●	●	●			<b>MCC 132</b>	E2 - 36	
	165					●	●	<b>MCC 161</b>	E2 - 40	
	190	●	●	●	●			<b>MCC 162</b>	E2 - 42	
	203		●	●	●			<b>MCC 170</b>	E2 - 46	
	250	●	●	●	●			<b>MCC 220</b>	E2 - 50	
	240					●	●	<b>MCC 224</b>	E2 - 54	
	221		●	●	●			<b>MCC 225</b>	E2 - 58	
	287	●	●	●	●	●		<b>MCC 250</b>	E2 - 62	
	250		●	●	●	●		<b>MCC 255</b>	E2 - 66	
	320	●	●	●	●	●		<b>MCC 310</b>	E2 - 70	
	320		●	●	●	●		<b>MCC 312</b>	E2 - 74	
	464					●	●	<b>MCO 450</b>	E2 - 78	
	560		●	●	●			<b>MCO 500</b>	E2 - 82	
	600					●	●	<b>MCO 600</b>	E2 - 82	
	<b>Thyristor / Diode Modules</b>									
		32	●	●	●	●			<b>MCD 26</b>	E2 - 8
		38		●	●	●			<b>MCD 40</b>	E2 - 12
51		●	●	●	●	●		<b>MCD 44</b>	E2 - 14	
64		●	●	●	●	●		<b>MCD 56</b>	E2 - 18	
64			600					<b>MDC 56</b> <i>new</i>	E2 - 18	
115		●	●	●	●			<b>MCD 72</b>	E2 - 24	
104						●	●	<b>MCD 94</b>	E2 - 28	
116		●	●	●	●			<b>MCD 95</b>	E2 - 30	
		130	●	●	●	●			<b>MCD 132</b>	E2 - 36
		165					●	●	<b>MCD 161</b>	E2 - 40
	190	●	●	●	●			<b>MCD 162</b>	E2 - 42	
	240					●	●	<b>MCD 224</b> <i>new</i>	E2 - 54	
	250	●	●	●	●			<b>MCD 220</b>	E2 - 50	
	221		●	●	●			<b>MCD 225</b>	E2 - 58	
	287	●	●	●	●	●		<b>MCD 250</b>	E2 - 62	
	250		●	●	●	●		<b>MCD 255</b>	E2 - 66	
	320	●	●	●	●	●		<b>MCD 310</b>	E2 - 70	
320		●	●	●	●		<b>MCD 312</b>	E2 - 74		
<b>Recommended RC snubber network</b>								E2 - 88		
<b>Peak reverse recovery current</b>								E2 - 88		

See also section E1  
page 1 Discrete Thyristors

Recommended RC snubber network  
Peak reverse recovery current

E2 - 88  
E2 - 88

## Thyristor Modules

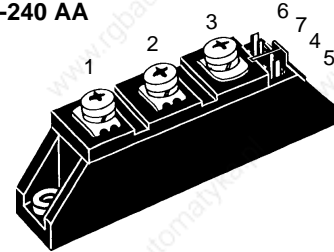
$$I_{TRMS} = 2 \times 40 \text{ A}$$

$$I_{TAVM} = 2 \times 25 \text{ A}$$

$$V_{RRM} = 800\text{-}1600 \text{ V}$$

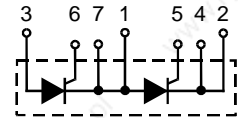
$V_{RSM}$	$V_{RRM}$	Type	
$V_{DSM}$	$V_{DRM}$	Version 1 B	Version 8 B
V	V		
900	800	MCC 19-08io1 B	MCC 19-08io8 B
1300	1200	MCC 19-12io1 B	MCC 19-12io8 B
1500	1400	MCC 19-14io1 B	MCC 19-14io8 B
1700	1600	MCC 19-16io1 B	MCC 19-16io8 B

TO-240 AA

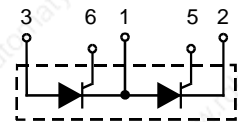


Symbol	Test Conditions	Maximum Ratings	
$I_{TRMS}$	$T_{VJ} = T_{VJM}$	40	A
$I_{TAVM}$	$T_C = 58^\circ\text{C}; 180^\circ \text{ sine}$	25	A
	$T_C = 85^\circ\text{C}; 180^\circ \text{ sine}$	18	A
$I_{TSM}$	$T_{VJ} = 45^\circ\text{C};$ $V_R = 0$	$t = 10 \text{ ms (50 Hz), sine}$ $t = 8.3 \text{ ms (60 Hz), sine}$	400 A 420 A
	$T_{VJ} = T_{VJM}$ $V_R = 0$	$t = 10 \text{ ms (50 Hz), sine}$ $t = 8.3 \text{ ms (60 Hz), sine}$	350 A 370 A
$\int i^2 dt$	$T_{VJ} = 45^\circ\text{C}$ $V_R = 0$	$t = 10 \text{ ms (50 Hz), sine}$ $t = 8.3 \text{ ms (60 Hz), sine}$	800 A <sup>2</sup> s 730 A <sup>2</sup> s
	$T_{VJ} = T_{VJM}$ $V_R = 0$	$t = 10 \text{ ms (50 Hz), sine}$ $t = 8.3 \text{ ms (60 Hz), sine}$	600 A <sup>2</sup> s 570 A <sup>2</sup> s
$(di/dt)_{cr}$	$T_{VJ} = T_{VJM}$ $f = 50 \text{ Hz}, t_p = 200 \mu\text{s}$ $V_D = 2/3 V_{DRM}$ $I_G = 0.45 \text{ A}$ $di_G/dt = 0.45 \text{ A}/\mu\text{s}$	repetitive, $I_T = 45 \text{ A}$	150 A/ $\mu\text{s}$
		non repetitive, $I_T = I_{TAVM}$	500 A/ $\mu\text{s}$
$(dv/dt)_{cr}$	$T_{VJ} = T_{VJM};$ $R_{GK} = \infty; \text{ method 1 (linear voltage rise)}$	$V_{DR} = 2/3 V_{DRM}$	1000 V/ $\mu\text{s}$
$P_{GM}$	$T_{VJ} = T_{VJM}$ $I_T = I_{TAVM}$	$t_p = 30 \mu\text{s}$ $t_p = 300 \mu\text{s}$	10 W 5 W
$P_{GAV}$			0.5 W
$V_{RGM}$			10 V
$T_{VJ}$			-40...+125 °C
$T_{VJM}$			125 °C
$T_{stg}$			-40...+125 °C
$V_{ISOL}$	50/60 Hz, RMS $I_{ISOL} \leq 1 \text{ mA}$	$t = 1 \text{ min}$ $t = 1 \text{ s}$	3000 V~ 3600 V~
$M_d$	Mounting torque (M5) Terminal connection torque (M5)		2.5-4.0/22-35 Nm/lb.in. 2.5-4.0/22-35 Nm/lb.in.
Weight	Typical including screws		90 g

Version 1 B



Version 8 B



### Features

- International standard package, JEDEC TO-240 AA
- Direct copper bonded Al<sub>2</sub>O<sub>3</sub> -ceramic base plate
- Planar passivated chips
- Isolation voltage 3600 V~
- UL registered, E 72873
- Gate-cathode twin pins for version 1B

### Applications

- DC motor control
- Softstart AC motor controller
- Light, heat and temperature control

### Advantages

- Space and weight savings
- Simple mounting with two screws
- Improved temperature and power cycling
- Reduced protection circuits

Data according to IEC 60747 and refer to a single thyristor unless otherwise stated. IXYS reserves the right to change limits, test conditions and dimensions

Symbol	Test Conditions	Characteristic Values
$I_{RRM}, I_{DRM}$	$T_{VJ} = T_{VJM}; V_R = V_{RRM}; V_D = V_{DRM}$	3 mA
$V_T$	$I_T = 80 \text{ A}; T_{VJ} = 25^\circ\text{C}$	2.05 V
$V_{T0}$	For power-loss calculations only ( $T_{VJ} = 125^\circ\text{C}$ )	0.85 V
$r_T$		18 mΩ
$V_{GT}$	$V_D = 6 \text{ V}; T_{VJ} = 25^\circ\text{C}$	1.5 V
	$T_{VJ} = -40^\circ\text{C}$	1.6 V
$I_{GT}$	$V_D = 6 \text{ V}; T_{VJ} = 25^\circ\text{C}$	100 mA
	$T_{VJ} = -40^\circ\text{C}$	200 mA
$V_{GD}$	$T_{VJ} = T_{VJM}; V_D = 2/3 V_{DRM}$	0.2 V
$I_{GD}$		10 mA
$I_L$	$T_{VJ} = 25^\circ\text{C}; t_p = 10 \mu\text{s}; V_D = 6 \text{ V}$ $I_G = 0.45 \text{ A}; di_G/dt = 0.45 \text{ A}/\mu\text{s}$	450 mA
$I_H$	$T_{VJ} = 25^\circ\text{C}; V_D = 6 \text{ V}; R_{GK} = \infty$	200 mA
$t_{gd}$	$T_{VJ} = 25^\circ\text{C}; V_D = 1/2 V_{DRM}$ $I_G = 0.45 \text{ A}; di_G/dt = 0.45 \text{ A}/\mu\text{s}$	2 μs
$t_q$	$T_{VJ} = T_{VJM}; I_T = 20 \text{ A}, t_p = 200 \mu\text{s}; -di/dt = 10 \text{ A}/\mu\text{s}$ $V_R = 100 \text{ V}; dv/dt = 20 \text{ V}/\mu\text{s}; V_D = 2/3 V_{DRM}$	typ. 150 μs
$Q_S$	$T_{VJ} = T_{VJM}; I_T = 25 \text{ A}, -di/dt = 0.64 \text{ A}/\mu\text{s}$	50 μC
$I_{RM}$		6 A
$R_{thJC}$	per thyristor; DC current	1.3 K/W
	per module	0.65 K/W
$R_{thJK}$	per thyristor; DC current	1.5 K/W
	per module	0.75 K/W
$d_s$	Creepage distance on surface	12.7 mm
$d_A$	Strike distance through air	9.6 mm
$a$	Maximum allowable acceleration	50 m/s <sup>2</sup>

Optional accessories for module-type MCC 19 version 1 B

Keyed gate/cathode twin plugs with wire length = 350 mm, gate = yellow, cathode = red

Type ZY 200L (L = Left for pin pair 4/5) } UL 758, style 1385,  
Type ZY 200R (R = right for pin pair 6/7) } CSA class 5851, guide 460-1-1

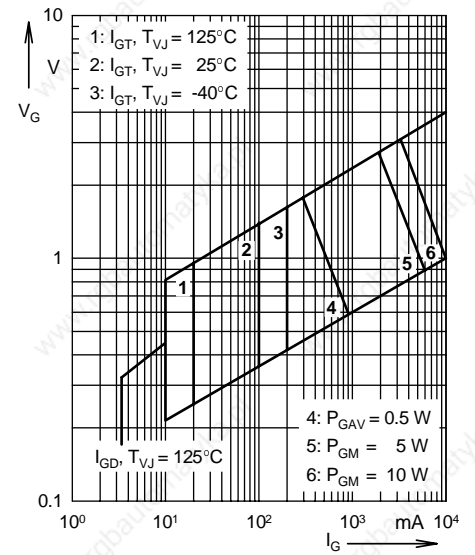


Fig. 1 Gate trigger characteristics

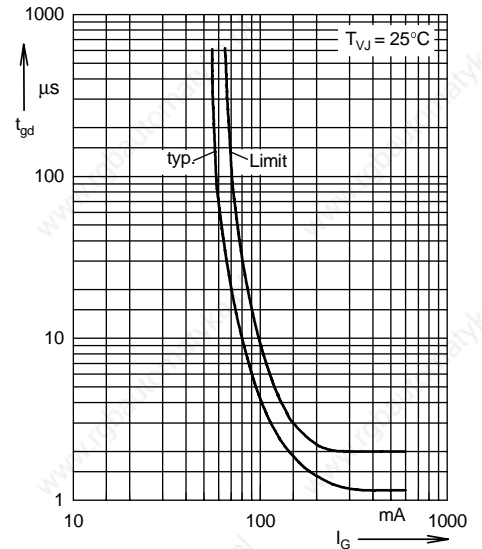
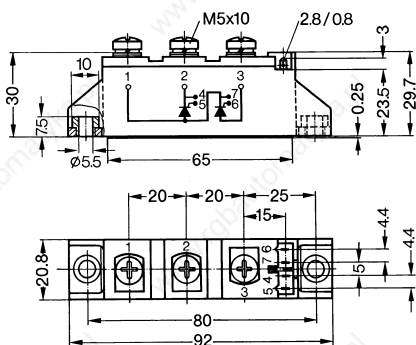


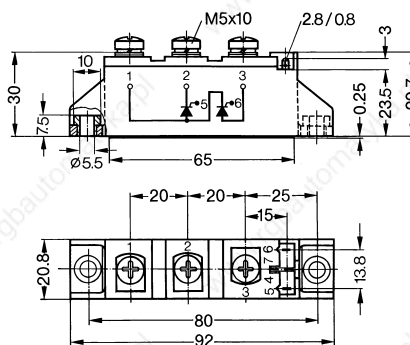
Fig. 2 Gate trigger delay time

### Dimensions in mm (1 mm = 0.0394")

#### Version 1 B



#### Version 8 B



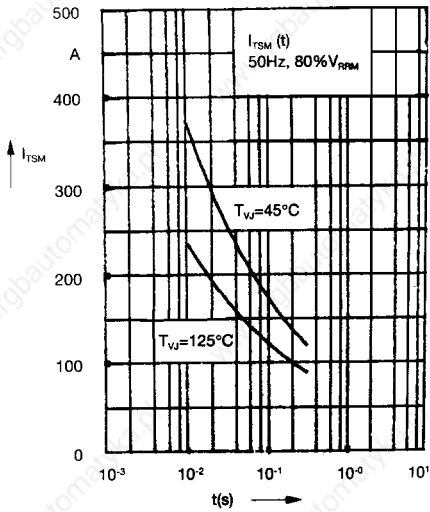


Fig. 3 Surge overload current  
 $I_{TSM}$ : Crest value,  $t$ : duration

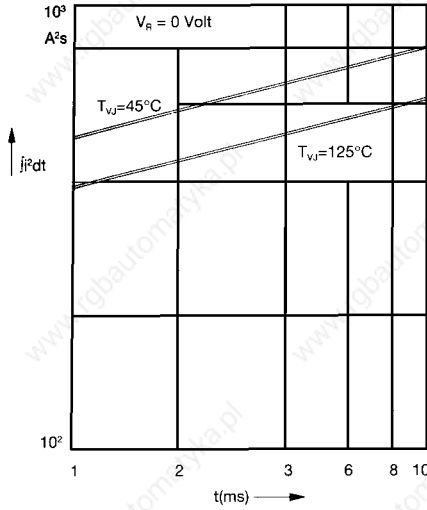


Fig. 4  $j^2dt$  versus time (1-10 ms)

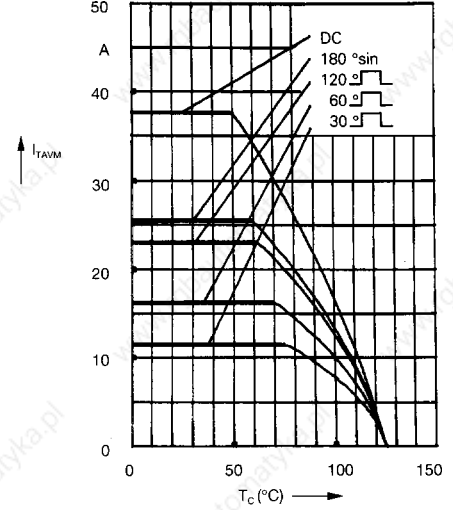


Fig. 4a Maximum forward current at case temperature

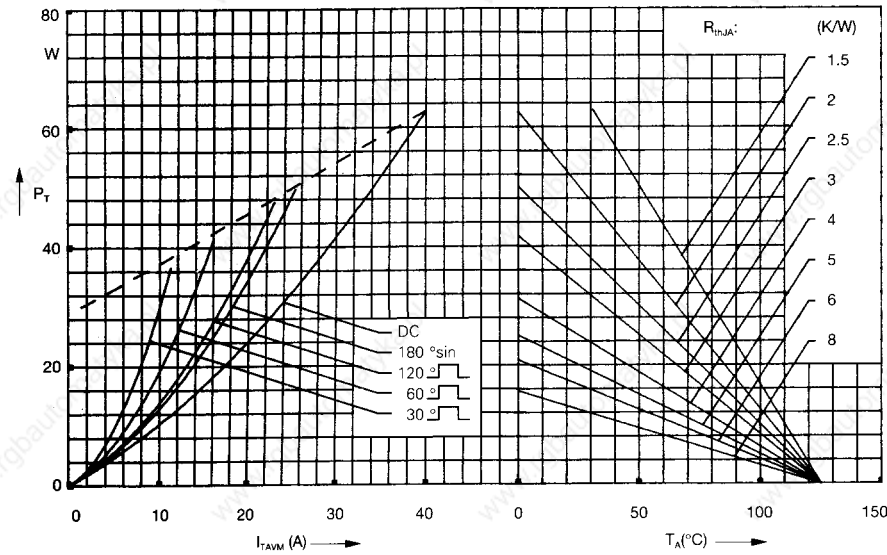


Fig. 5 Power dissipation versus on-state current and ambient temperature (per thyristor)

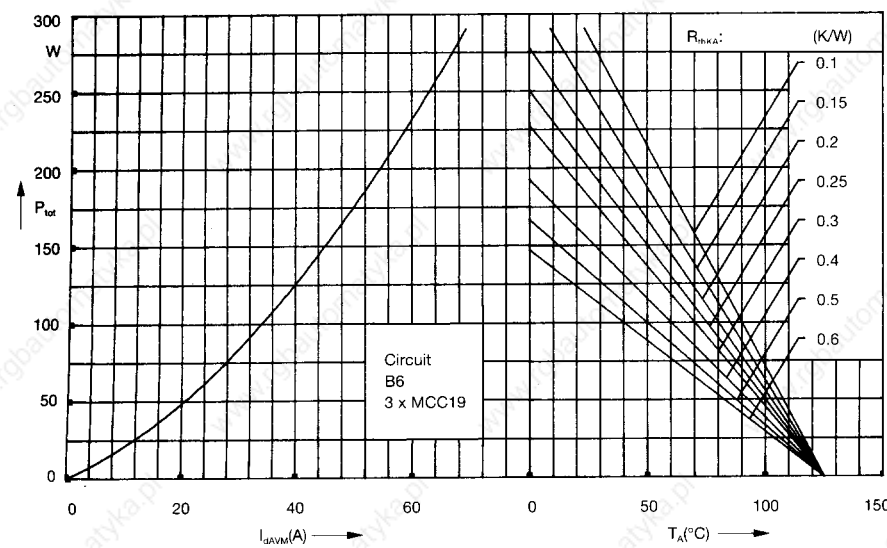


Fig. 6 Three phase rectifier bridge: Power dissipation versus direct output current and ambient temperature

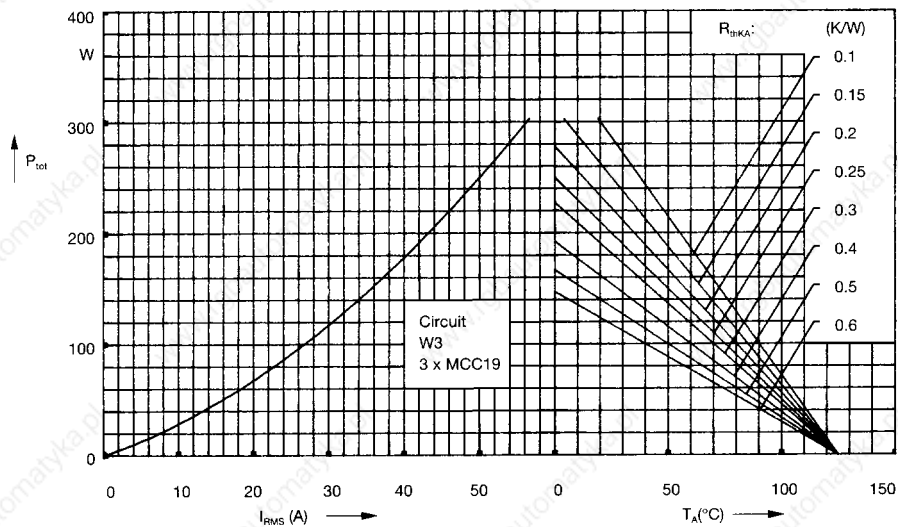


Fig. 7 Three phase AC-controller: Power dissipation versus RMS output current and ambient temperature

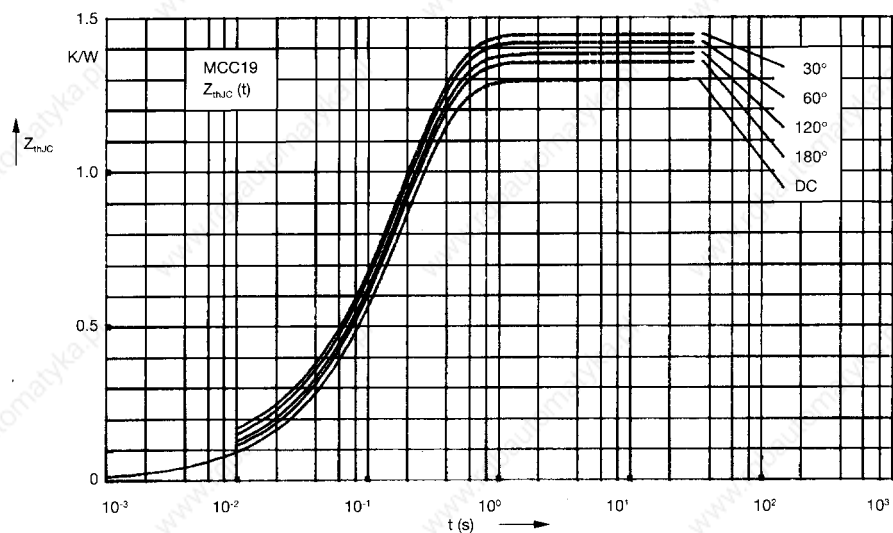


Fig. 8 Transient thermal impedance junction to case (per thyristor)

$R_{thJC}$  for various conduction angles  $d$ :

$d$	$R_{thJC}$ (K/W)
DC	1.3
180°	1.35
120°	1.39
60°	1.42
30°	1.45

Constants for  $Z_{thJC}$  calculation:

$i$	$R_{thi}$ (K/W)	$t_i$ (s)
1	0.018	0.0033
2	0.041	0.0216
3	1.241	0.191

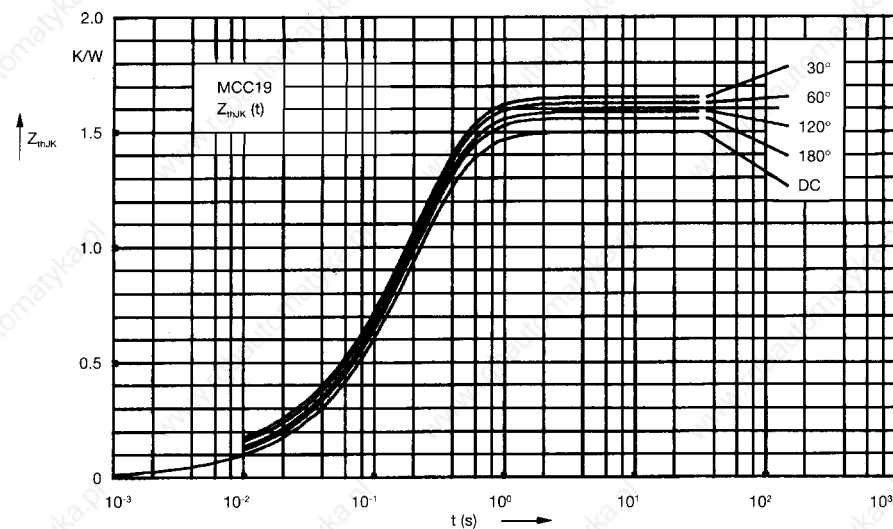


Fig. 9 Transient thermal impedance junction to heatsink (per thyristor)

$R_{thJK}$  for various conduction angles  $d$ :

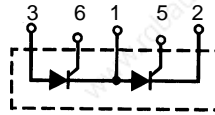
$d$	$R_{thJK}$ (K/W)
DC	1.5
180°	1.55
120°	1.59
60°	1.62
30°	1.65

Constants for  $Z_{thJK}$  calculation:

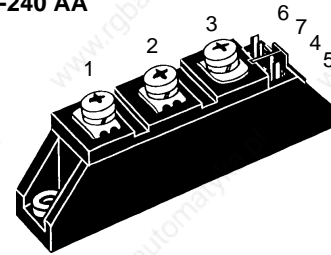
$i$	$R_{thi}$ (K/W)	$t_i$ (s)
1	0.018	0.0033
2	0.041	0.0216
3	1.241	0.191
4	0.2	0.46

## Thyristor Modules

$V_{RSM}$	$V_{RRM}$	Type
$V_{DSM}$	$V_{DRM}$	
V	V	
900	800	MCC 21-08io8 B
1300	1200	MCC 21-12io8 B
1500	1400	MCC 21-14io8 B
1700	1600	MCC 21-16io8 B



TO-240 AA



Symbol	Conditions	Maximum Ratings	
$I_{TRMS}$	$T_{VJ} = T_{VJM}$	33	A
$I_{TAVM}$	$T_C = 85^{\circ}\text{C}; 180^{\circ}$ sine	21	A
$I_{TSM}$	$T_{VJ} = 45^{\circ}\text{C};$ $V_R = 0$	$t = 10$ ms (50 Hz), sine	320 A
		$t = 8.3$ ms (60 Hz), sine	350 A
$I^2dt$	$T_{VJ} = T_{VJM}$ $V_R = 0$	$t = 10$ ms (50 Hz), sine	280 A
		$t = 8.3$ ms (60 Hz), sine	310 A
$I^2dt$	$T_{VJ} = 45^{\circ}\text{C}$ $V_R = 0$	$t = 10$ ms (50 Hz), sine	500 A <sup>2</sup> s
		$t = 8.3$ ms (60 Hz), sine	520 A <sup>2</sup> s
$(di/dt)_{cr}$	$T_{VJ} = T_{VJM}$ $f = 50\text{Hz}, t_p = 200\mu\text{s}$ $V_D = \frac{2}{3} V_{DRM}$ $I_G = 0.45$ A $di_G/dt = 0.45$ A/ $\mu\text{s}$	repetitive, $I_T = 45$ A	150 A/ $\mu\text{s}$
		non repetitive, $I_T = I_{TAVM}$	500 A/ $\mu\text{s}$
$(dv/dt)_{cr}$	$T_{VJ} = T_{VJM}; V_{DR} = \frac{2}{3} V_{DRM}$ $R_{GK} = \infty; \text{method 1 (linear voltage rise)}$	1000	V/ $\mu\text{s}$
$P_{GM}$	$T_{VJ} = T_{VJM}$ $I_T = I_{TAVM}$	$t_p = 30$ $\mu\text{s}$	10 W
		$t_p = 300$ $\mu\text{s}$	5 W
$P_{GAV}$		0.5	W
$V_{RGM}$		10	V
$T_{VJ}$		-40...+125	$^{\circ}\text{C}$
$T_{VJM}$		125	$^{\circ}\text{C}$
$T_{stg}$		-40...+125	$^{\circ}\text{C}$
$V_{ISOL}$	50/60 Hz, RMS $I_{ISOL} \leq 1$ mA	$t = 1$ min	3000 V~
		$t = 1$ s	3600 V~
$M_d$	Mounting torque (M5) Terminal connection torque (M5)	2.5-4.0/22-35	Nm/lb.in.
		2.5-4.0/22-35	Nm/lb.in.
Weight	Typical including screws	90	g

### Features

- International standard package, JEDEC TO-240 AA
- Direct copper bonded  $\text{Al}_2\text{O}_3$  -ceramic base plate
- Planar passivated chips
- Isolation voltage 3600 V~
- UL registered, E 72873
- Gate-cathode twin pins for version 1B

### Applications

- DC motor control
- Softstart AC motor controller
- Light, heat and temperature control

### Advantages

- Space and weight savings
- Simple mounting with two screws
- Improved temperature and power cycling
- Reduced protection circuits

Data according to DIN/IEC 747 and refer to a single thyristor unless otherwise stated.

Symbol	Conditions	Characteristic Values
$I_{RRM}, I_{DRM}$	$T_{VJ} = T_{VJM}; V_R = V_{RRM}; V_D = V_{DRM}$	5 mA
$V_T$	$I_T = 45 \text{ A}; T_{VJ} = 25^\circ\text{C}$	1.6 V
$V_{T0}$	For power-loss calculations only ( $T_{VJ} = 125^\circ\text{C}$ )	0.85 V
$r_T$		15 mΩ
$V_{GT}$	$V_D = 6 \text{ V}; T_{VJ} = 25^\circ\text{C}$ $T_{VJ} = -40^\circ\text{C}$	1.0 V 1.2 V
$I_{GT}$	$V_D = 6 \text{ V}; T_{VJ} = 25^\circ\text{C}$ $T_{VJ} = -40^\circ\text{C}$	65 mA 80 mA
$V_{GD}$ $I_{GD}$	$T_{VJ} = T_{VJM}; V_D = \frac{2}{3} V_{DRM}$	0.2 V 5 mA
$I_L$	$T_{VJ} = 25^\circ\text{C}; t_p = 10 \mu\text{s}; V_D = 6 \text{ V}$ $I_G = 0.3 \text{ A}; di_G/dt = 0.3 \text{ A}/\mu\text{s}$	150 mA
$I_H$	$T_{VJ} = 25^\circ\text{C}; V_D = 6 \text{ V}; R_{GK} = \infty$	100 mA
$t_{gd}$	$T_{VJ} = 25^\circ\text{C}; V_D = \frac{1}{2} V_{DRM}$ $I_G = 0.3 \text{ A}; di_G/dt = 0.3 \text{ A}/\mu\text{s}$	2 μs
$t_q$	$T_{VJ} = T_{VJM}; I_T = 15 \text{ A}, t_p = 300 \mu\text{s}; -di/dt = 10 \text{ A}/\mu\text{s}$ $V_R = 100 \text{ V}; dv/dt = 20 \text{ V}/\mu\text{s}; V_D = \frac{2}{3} V_{DRM}$	typ. 150 μs
$I_{RM}$	$T_{VJ} = T_{VJM}; I_T = 30 \text{ A}, -di/dt = 0.3 \text{ A}/\mu\text{s}$	4 A
$R_{thJC}$	per thyristor; DC current	1.1 K/W
	per module	0.55 K/W
$R_{thJK}$	per thyristor; DC current	1.3 K/W
	per module	0.65 K/W
	other values see Fig. 8/9	
$d_s$	Creepage distance on surface	12.7 mm
$d_A$	Strike distance through air	9.6 mm
$a$	Maximum allowable acceleration	50 m/s <sup>2</sup>

Optional accessories for module-type MCC 23 version 1 B

Keyed gate/cathode twin plugs with wire length = 350 mm, gate = yellow, cathode = red

Type **ZY 200L** (L = Left for pin pair 4/5) } UL 758, style 1385,

Type **ZY 200R** (R = right for pin pair 6/7) } CSA class 5851, guide 460-1-1

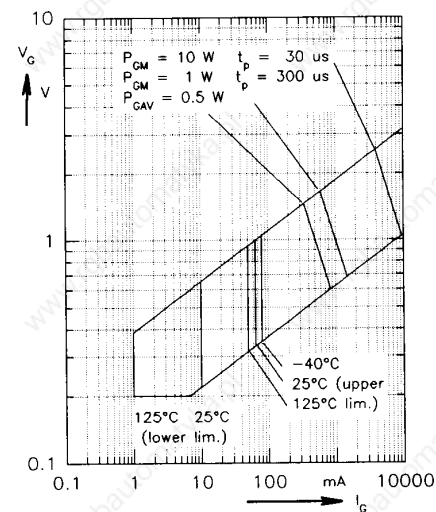


Fig. 1 Gate trigger characteristics

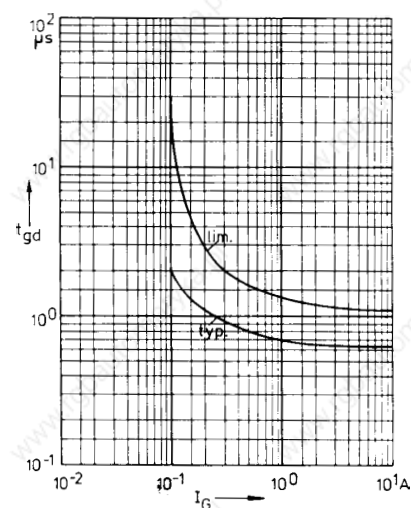
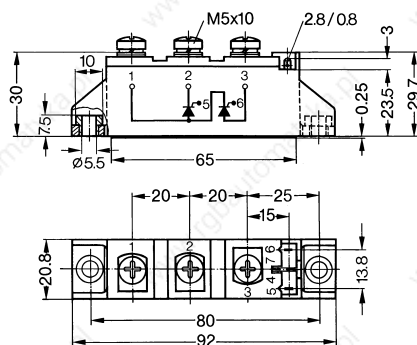


Fig. 2 Gate trigger delay time

### Dimensions in mm (1 mm = 0.0394")



## Thyristor Modules Thyristor/Diode Modules

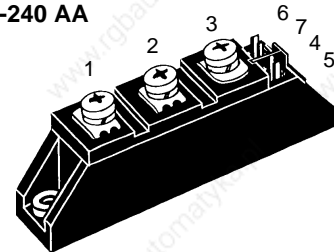
$$I_{TRMS} = 2 \times 50 \text{ A}$$

$$I_{TAVM} = 2 \times 32 \text{ A}$$

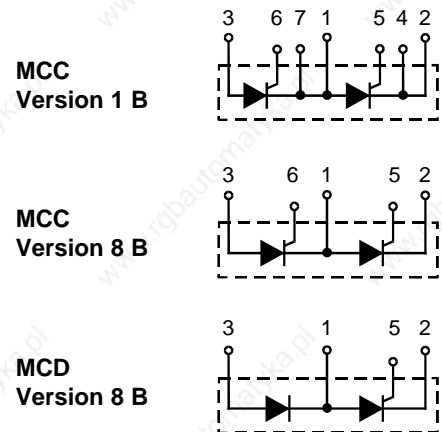
$$V_{RRM} = 800-1600 \text{ V}$$

$V_{RSM}$	$V_{RRM}$	Type		
$V_{DSM}$	$V_{DRM}$	Version 1 B	Version 8 B	Version 8 B
V	V			
900	800	MCC 26-08io1 B	MCC 26-08io8 B	MCD 26-08io8 B
1300	1200	MCC 26-12io1 B	MCC 26-12io8 B	MCD 26-12io8 B
1500	1400	MCC 26-14io1 B	MCC 26-14io8 B	MCD 26-14io8 B
1700	1600	MCC 26-16io1 B	MCC 26-16io8 B	MCD 26-16io8 B

TO-240 AA



Symbol	Test Conditions	Maximum Ratings		
$I_{TRMS}, I_{FRMS}$ $I_{TAVM}, I_{FAVM}$	$T_{VJ} = T_{VJM}$ $T_C = 75^\circ\text{C}; 180^\circ \text{ sine}$ $T_C = 85^\circ\text{C}; 180^\circ \text{ sine}$	50 32 27	A A A	
$I_{TSM}, I_{FSM}$	$T_{VJ} = 45^\circ\text{C};$ $V_R = 0$ $T_{VJ} = T_{VJM}$ $V_R = 0$	$t = 10 \text{ ms (50 Hz), sine}$ $t = 8.3 \text{ ms (60 Hz), sine}$ $t = 10 \text{ ms (50 Hz), sine}$ $t = 8.3 \text{ ms (60 Hz), sine}$	520 560 460 500	A A A A
$f^2dt$	$T_{VJ} = 45^\circ\text{C}$ $V_R = 0$ $T_{VJ} = T_{VJM}$ $V_R = 0$	$t = 10 \text{ ms (50 Hz), sine}$ $t = 8.3 \text{ ms (60 Hz), sine}$ $t = 10 \text{ ms (50 Hz), sine}$ $t = 8.3 \text{ ms (60 Hz), sine}$	1350 1300 1050 1030	$A^2s$ $A^2s$ $A^2s$ $A^2s$
$(di/dt)_{cr}$	$T_{VJ} = T_{VJM}$ $f = 50 \text{ Hz}, t_p = 200 \mu\text{s}$ $V_D = 2/3 V_{DRM}$ $I_G = 0.45 \text{ A}$ $di_G/dt = 0.45 \text{ A}/\mu\text{s}$	repetitive, $I_T = 45 \text{ A}$  non repetitive, $I_T = I_{TAVM}$	150  500	$A/\mu\text{s}$  $A/\mu\text{s}$
$(dv/dt)_{cr}$	$T_{VJ} = T_{VJM};$ $R_{GK} = \infty; \text{ method 1 (linear voltage rise)}$	$V_{DR} = 2/3 V_{DRM}$	1000	$V/\mu\text{s}$
$P_{GM}$	$T_{VJ} = T_{VJM}$ $I_T = I_{TAVM}$	$t_p = 30 \mu\text{s}$ $t_p = 300 \mu\text{s}$	10 5 0.5	W W W
$P_{GAV}$			10	V
$V_{RGM}$			10	V
$T_{VJ}$			-40...+125	$^\circ\text{C}$
$T_{VJM}$			125	$^\circ\text{C}$
$T_{stg}$			-40...+125	$^\circ\text{C}$
$V_{ISOL}$	50/60 Hz, RMS $I_{ISOL} \leq 1 \text{ mA}$	$t = 1 \text{ min}$ $t = 1 \text{ s}$	3000 3600	$V\sim$ $V\sim$
$M_d$	Mounting torque (M5) Terminal connection torque (M5)		2.5-4.0/22-35 2.5-4.0/22-35	Nm/lb.in. Nm/lb.in.
Weight	Typical including screws		90	g



### Features

- International standard package, JEDEC TO-240 AA
- Direct copper bonded  $\text{Al}_2\text{O}_3$  -ceramic base plate
- Planar passivated chips
- Isolation voltage 3600 V~
- UL registered, E 72873
- Gate-cathode twin pins for version 1B

### Applications

- DC motor control
- Softstart AC motor controller
- Light, heat and temperature control

### Advantages

- Space and weight savings
- Simple mounting with two screws
- Improved temperature and power cycling
- Reduced protection circuits

Data according to IEC 60747 and refer to a single thyristor/diode unless otherwise stated. IXYS reserves the right to change limits, test conditions and dimensions



Symbol	Test Conditions	Characteristic Values
$I_{RRM}, I_{DRM}$	$T_{VJ} = T_{VJM}; V_R = V_{RRM}; V_D = V_{DRM}$	3 mA
$V_T, V_F$	$I_T, I_F = 80 \text{ A}; T_{VJ} = 25^\circ\text{C}$	1.64 V
$V_{T0}$	For power-loss calculations only ( $T_{VJ} = 125^\circ\text{C}$ )	0.85 V
$r_T$		11.0 mΩ
$V_{GT}$	$V_D = 6 \text{ V}; T_{VJ} = 25^\circ\text{C}$	1.5 V
	$T_{VJ} = -40^\circ\text{C}$	1.6 V
$I_{GT}$	$V_D = 6 \text{ V}; T_{VJ} = 25^\circ\text{C}$	100 mA
	$T_{VJ} = -40^\circ\text{C}$	200 mA
$V_{GD}$	$T_{VJ} = T_{VJM}; V_D = 2/3 V_{DRM}$	0.2 V
$I_{GD}$		10 mA
$I_L$	$T_{VJ} = 25^\circ\text{C}; t_p = 10 \mu\text{s}; V_D = 6 \text{ V}$ $I_G = 0.45 \text{ A}; di_G/dt = 0.45 \text{ A}/\mu\text{s}$	450 mA
$I_H$	$T_{VJ} = 25^\circ\text{C}; V_D = 6 \text{ V}; R_{GK} = \infty$	200 mA
$t_{gd}$	$T_{VJ} = 25^\circ\text{C}; V_D = 1/2 V_{DRM}$ $I_G = 0.45 \text{ A}; di_G/dt = 0.45 \text{ A}/\mu\text{s}$	2 μs
$t_q$	$T_{VJ} = T_{VJM}; I_T = 20 \text{ A}, t_p = 200 \mu\text{s}; -di/dt = 10 \text{ A}/\mu\text{s}$ typ. $V_R = 100 \text{ V}; dv/dt = 20 \text{ V}/\mu\text{s}; V_D = 2/3 V_{DRM}$	150 μs
$Q_S$	$T_{VJ} = T_{VJM}; I_T, I_F = 25 \text{ A}, -di/dt = 0.64 \text{ A}/\mu\text{s}$	50 μC
$I_{RM}$		6 A
$R_{thJC}$	per thyristor/diode; DC current per module	0.88 K/W
$R_{thJK}$	per thyristor/diode; DC current per module	1.08 K/W
	other values see Fig. 8/9	0.44 K/W
		0.54 K/W
$d_s$	Creepage distance on surface	12.7 mm
$d_A$	Strike distance through air	9.6 mm
$a$	Maximum allowable acceleration	50 m/s <sup>2</sup>

Optional accessories for module-type MCC 26 version 1 B

Keyed gate/cathode twin plugs with wire length = 350 mm, gate = yellow, cathode = red

Type ZY 200L (L = Left for pin pair 4/5) } UL 758, style 1385,  
Type ZY 200R (R = right for pin pair 6/7) } CSA class 5851, guide 460-1-1

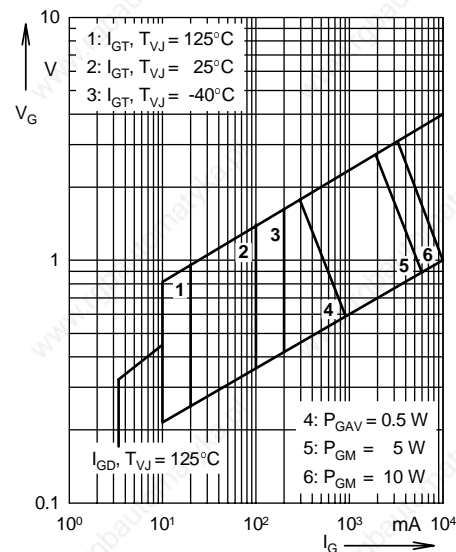


Fig. 1 Gate trigger characteristics

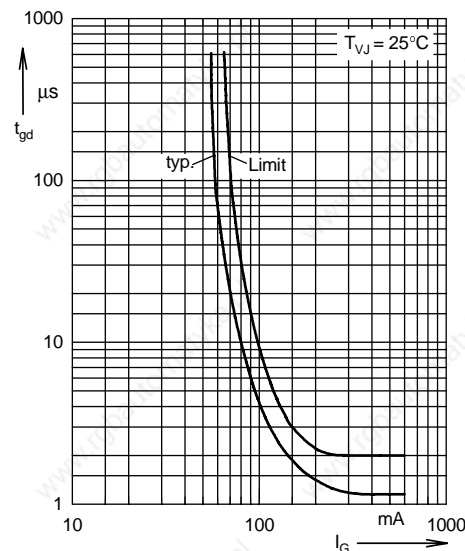
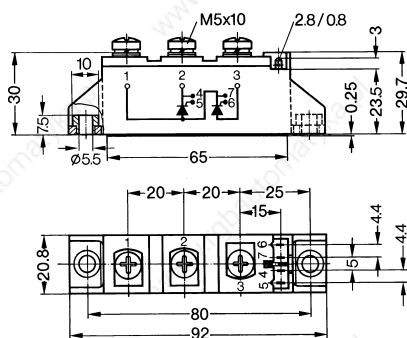


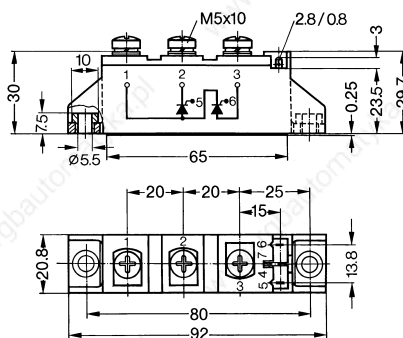
Fig. 2 Gate trigger delay time

### Dimensions in mm (1 mm = 0.0394")

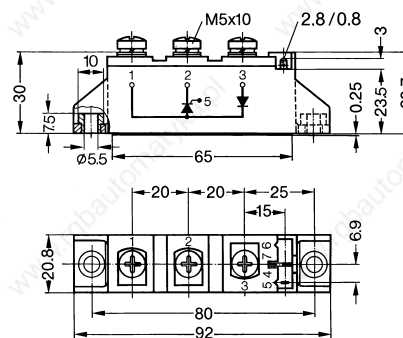
#### MCC Version 1 B



#### MCC Version 8 B



#### MCD Version 8 B



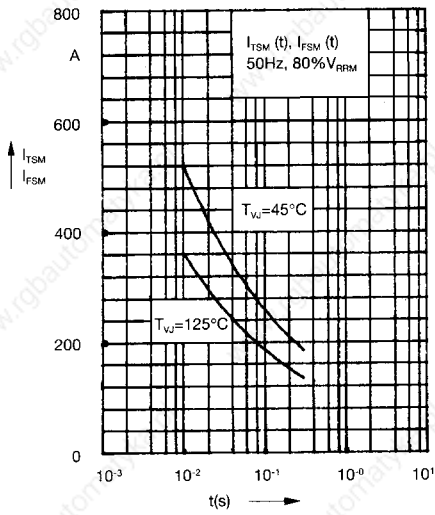


Fig. 3 Surge overload current  
 $I_{TSM}, I_{FSM}$ : Crest value,  $t$ : duration

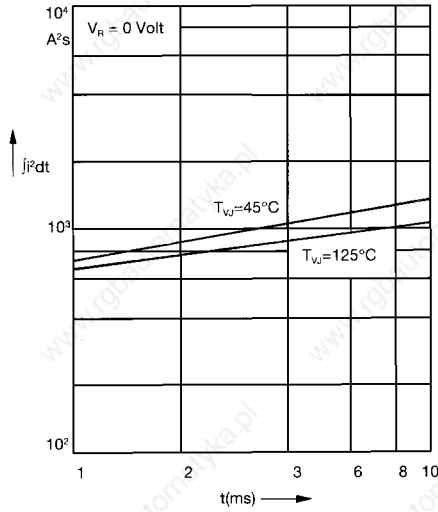


Fig. 4  $\int i^2 dt$  versus time (1-10 ms)

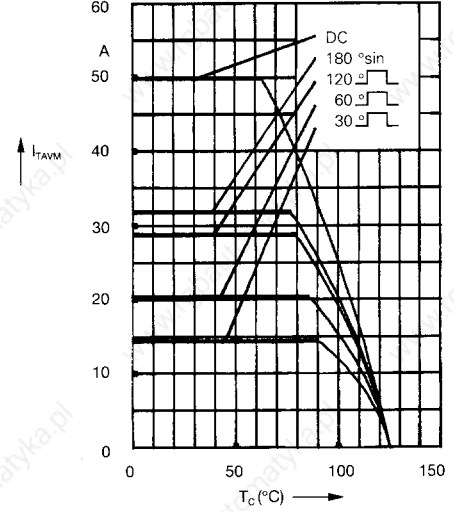


Fig. 4a Maximum forward current at case temperature

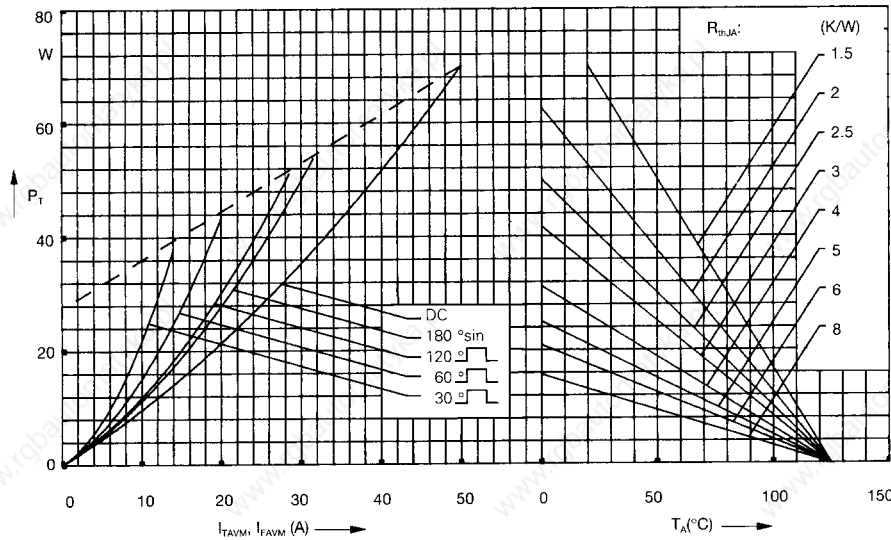


Fig. 5 Power dissipation versus on-state current and ambient temperature (per thyristor or diode)

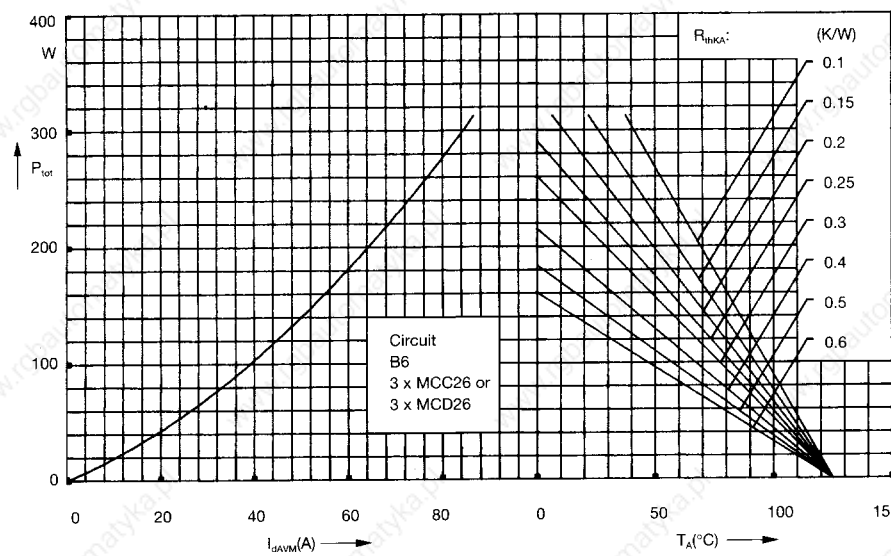


Fig. 6 Three phase rectifier bridge: Power dissipation versus direct output current and ambient temperature

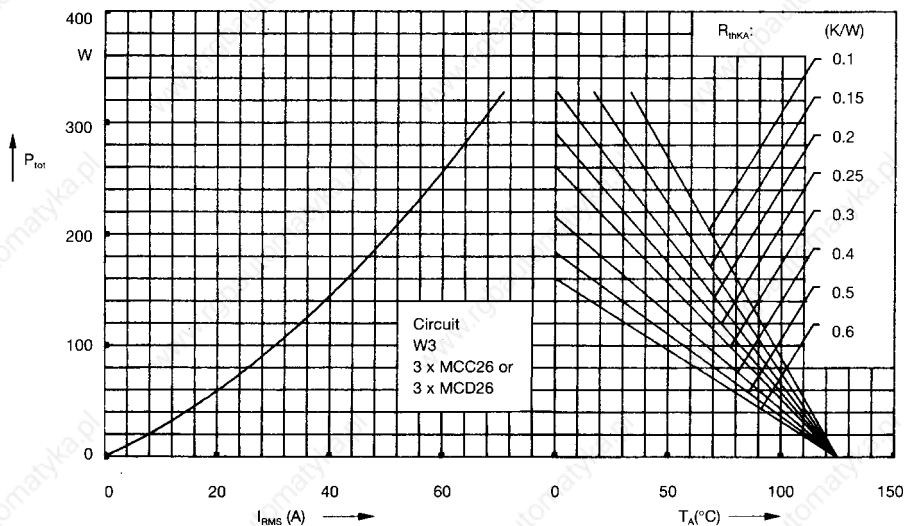


Fig. 7 Three phase AC-controller: Power dissipation versus RMS output current and ambient temperature

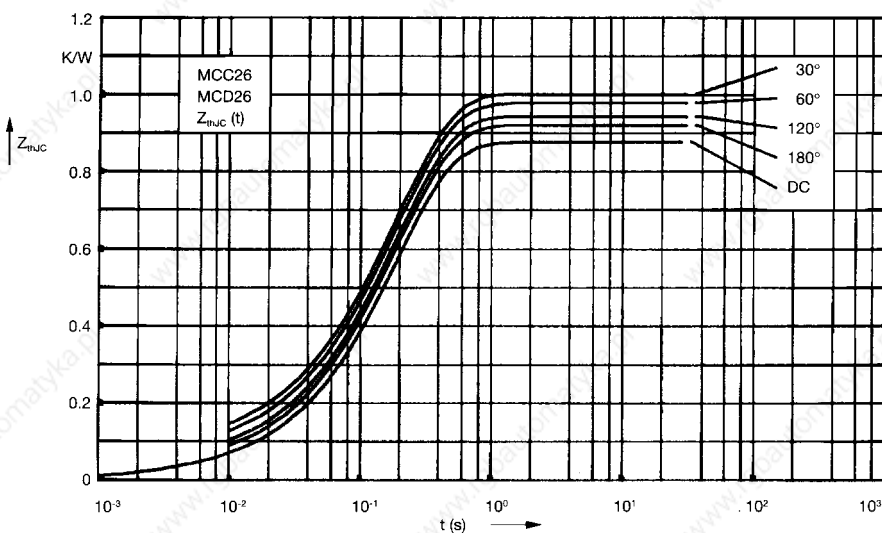


Fig. 8 Transient thermal impedance junction to case (per thyristor or diode)

$R_{thJC}$  for various conduction angles d:

d	$R_{thJC}$ (K/W)
DC	0.88
180°	0.92
120°	0.95
60°	0.98
30°	1.01

Constants for  $Z_{thJC}$  calculation:

i	$R_{thi}$ (K/W)	$t_i$ (s)
1	0.019	0.0031
2	0.029	0.0216
3	0.832	0.191

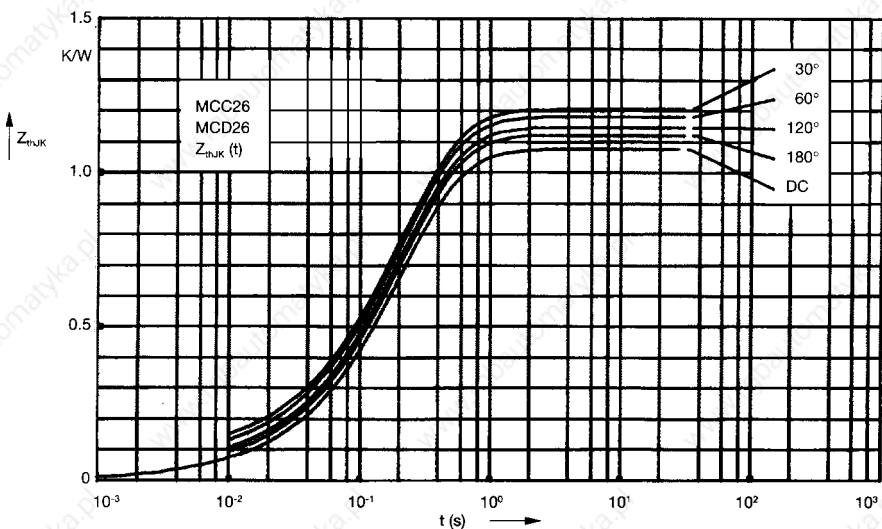


Fig. 9 Transient thermal impedance junction to heatsink (per thyristor or diode)

$R_{thJK}$  for various conduction angles d:

d	$R_{thJK}$ (K/W)
DC	1.08
180°	1.12
120°	1.15
60°	1.18
30°	1.21

Constants for  $Z_{thJK}$  calculation:

i	$R_{thi}$ (K/W)	$t_i$ (s)
1	0.019	0.0031
2	0.029	0.0216
3	0.832	0.191
4	0.2	0.45

## Thyristor/Diode Module

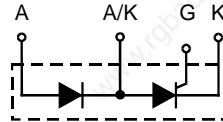
$$I_{TRMS} = 2 \times 60 \text{ A}$$

$$I_{TAVM} = 2 \times 38 \text{ A}$$

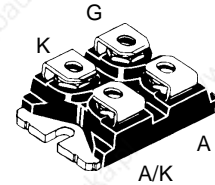
$$V_{RRM} = 1200-1600 \text{ V}$$

Preliminary data

$V_{RSM}$ $V_{DSM}$ V	$V_{RRM}$ $V_{DRM}$ V	Type
1300	1200	MCD 40-12io6
1700	1600	MCD 40-16io6



SOT-227 B,  
miniBLOC



K = Cathode, A = Anode, G = Gate,  
A/K = Common output

Symbol	Test Conditions	Maximum Ratings	
$I_{TRMS}^1$ , $I_{FRMS}$ $I_{TAVM}^2$ , $I_{FAVM}$	$T_{VJ} = T_{VJM}$ ; $T_C = 85^\circ\text{C}$ $T_{VJ} = T_{VJM}$ ; $T_C = 85^\circ\text{C}$ ; 180° sine	60 A 38 A	
$I_{TSM}^3$ , $I_{FSM}$	$T_{VJ} = 45^\circ\text{C}$ ; $V_R = 0$ $T_{VJ} = T_{VJM}$ $V_R = 0$	t = 10 ms (50 Hz), sine t = 8.3 ms (60 Hz), sine t = 10 ms (50 Hz), sine t = 8.3 ms (60 Hz), sine	500 A 440 A 450 A 490 A
$j^2dt$	$T_{VJ} = 45^\circ\text{C}$ $V_R = 0$ $T_{VJ} = T_{VJM}$ $V_R = 0$	t = 10 ms (50 Hz), sine t = 8.3 ms (60 Hz), sine t = 10 ms (50 Hz), sine t = 8.3 ms (60 Hz), sine	1250 A <sup>2</sup> s 1220 A <sup>2</sup> s 1010 A <sup>2</sup> s 1010 A <sup>2</sup> s
$(di/dt)_{cr}$	$T_{VJ} = T_{VJM}$ f = 50 Hz, t <sub>p</sub> = 200 μs $V_D = 2/3 V_{DRM}$ $I_G = 0.45 \text{ A}$ di <sub>G</sub> /dt = 0.45 A/μs	repetitive, I <sub>T</sub> = 45 A non repetitive, I <sub>T</sub> = I <sub>TAVM</sub>	100 A/μs 500 A/μs
$(dv/dt)_{cr}$	$T_{VJ} = T_{VJM}$ ; R <sub>GK</sub> = ∞; method 1 (linear voltage rise)	V <sub>DR</sub> = 2/3 V <sub>DRM</sub>	1000 V/μs
$P_{GM}$	$T_{VJ} = T_{VJM}$ I <sub>T</sub> = I <sub>TAVM</sub>	t <sub>p</sub> = 30 μs t <sub>p</sub> = 300 μs	10 W 5 W
$P_{GAV}$			0.5 W
$V_{RGM}$			10 V
$T_{VJ}$			-40...+125 °C
$T_{VJM}$			125 °C
$T_{stg}$			-40...+125 °C
$V_{ISOL}$	50/60 Hz, RMS	I <sub>ISOL</sub> ≤ 1 mA	2500 V~
$M_d$	Mounting torque (M4) Terminal connection torque (M4)		1.5/13 Nm/lb.in. 1.5/13 Nm/lb.in.
Weight	Typical including screws		30 g

### Features

- International standard package miniBLOC, SOT-227 B
- Planar passivated chips

### Applications

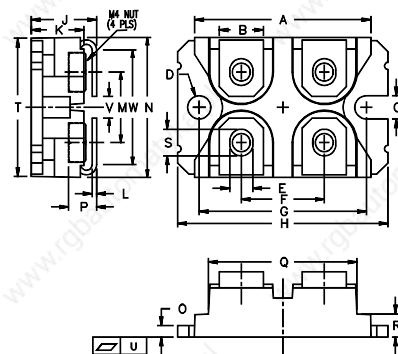
- DC motor control
- Softstart AC motor controller
- Light, heat and temperature control
- Half controlled rectifier bridge

### Advantages

- Space and weight savings
- Simple mounting with two screws
- Improved temperature and power cycling
- Reduced protection circuits

Data according to IEC 60747 refer to a single thyristor/diode unless otherwise stated.  
IXYS reserves the right to change limits, test conditions and dimensions

Symbol	Test Conditions	Characteristic Values
$I_{RRM}, I_{DRM}$	$T_{VJ} = T_{VJM}; V_R = V_{RRM}; V_D = V_{DRM}$	5 mA
$V_T, V_F$	$I_T, I_F = 80 \text{ A}; T_{VJ} = 25^\circ\text{C}$	1.68 V
$V_{T0}$ $r_T$	For power-loss calculations only ( $T_{VJ} = 125^\circ\text{C}$ )	0.85 V 9.5 mΩ
$V_{GT}$	$V_D = 6 \text{ V}; T_{VJ} = 25^\circ\text{C}$ $T_{VJ} = -40^\circ\text{C}$	1.5 V 1.6 V
$I_{GT}$	$V_D = 6 \text{ V}; T_{VJ} = 25^\circ\text{C}$ $T_{VJ} = -40^\circ\text{C}$	100 mA 200 mA
$V_{GD}$ $I_{GD}$	$T_{VJ} = T_{VJM}; V_D = 2/3 V_{DRM}$	0.2 V 5 mA
$I_L$	$T_{VJ} = 25^\circ\text{C}; t_p = 10 \mu\text{s}, V_D = 6 \text{ V}$ $I_G = 0.45 \text{ A}; di_G/dt = 0.45 \text{ A}/\mu\text{s}$	450 mA
$I_H$	$T_{VJ} = 25^\circ\text{C}; V_D = 6 \text{ V}; R_{GK} = \infty$	200 mA
$t_{gd}$	$T_{VJ} = 25^\circ\text{C}; V_D = 1/2 V_{DRM}$ $I_G = 0.45 \text{ A}; di_G/dt = 0.45 \text{ A}/\mu\text{s}$	2 μs
$t_q$	$T_{VJ} = T_{VJM}; I_T = 120 \text{ A}, t_p = 200 \mu\text{s}; -di/dt = 10 \text{ A}/\mu\text{s}$ $V_R = 100 \text{ V}; dv/dt = 20 \text{ V}/\mu\text{s}; V_D = 2/3 V_{DRM}$	typ.150 μs
$R_{thJC}$ $R_{thCH}$	per thyristor/diode; DC current	0.6 K/W 0.1 K/W
$d_s$	Creepage distance on surface	8 mm
$d_A$	Strike distance through air	4 mm
$a$	Maximum allowable acceleration	50 m/s <sup>2</sup>

**miniBLOC, SOT-227 B**


M4 screws (4x) supplied

Dim.	Millimeter		Inches	
	Min.	Max.	Min.	Max.
A	31.50	31.88	1.240	1.255
B	7.80	8.20	0.307	0.323
C	4.09	4.29	0.161	0.169
D	4.09	4.29	0.161	0.169
E	4.09	4.29	0.161	0.169
F	14.91	15.11	0.587	0.595
G	30.12	30.30	1.186	1.193
H	37.80	38.20	1.489	1.505
J	11.68	12.22	0.460	0.481
K	8.92	9.60	0.351	0.378
L	0.76	0.84	0.030	0.033
M	12.60	12.85	0.496	0.506
N	25.15	25.42	0.990	1.001
O	1.98	2.13	0.078	0.084
P	4.95	5.97	0.195	0.235
Q	26.54	26.90	1.045	1.059
R	3.94	4.42	0.155	0.174
S	4.72	4.85	0.186	0.191
T	24.59	25.07	0.968	0.987
U	-0.05	0.1	-0.002	0.004
V	3.30	4.57	0.130	0.180
W	0.780	0.830	0.031	0.033

## Thyristor Modules Thyristor/Diode Modules

$$I_{TRMS} = 2 \times 80 \text{ A}$$

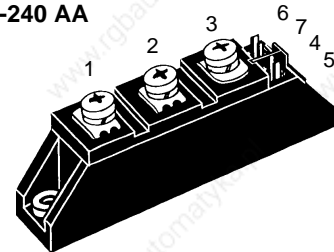
$$I_{TAVM} = 2 \times 51 \text{ A}$$

$$V_{RRM} = 800-1800 \text{ V}$$

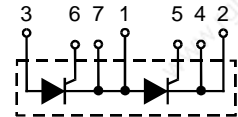
$V_{RSM}$	$V_{RRM}$	Type		
$V_{DSM}$	$V_{DRM}$	Version 1 B	Version 8 B	Version 8 B
V	V			
900	800	MCC 44-08io1 B	MCC 44-08io8 B	MCD 44-08io8 B
1300	1200	MCC 44-12io1 B	MCC 44-12io8 B	MCD 44-12io8 B
1500	1400	MCC 44-14io1 B	MCC 44-14io8 B	MCD 44-14io8 B
1700	1600	MCC 44-16io1 B	MCC 44-16io8 B	MCD 44-16io8 B
1900	1800	MCC 44-18io1 B	MCC 44-18io8 B	MCD 44-18io8 B

Symbol	Test Conditions	Maximum Ratings	
$I_{TRMS}^*, I_{FRMS}$ $I_{TAVM}^*, I_{FAVM}$	$T_{VJ} = T_{VJM}$ $T_C = 83^\circ\text{C}; 180^\circ \text{ sine}$ $T_C = 85^\circ\text{C}; 180^\circ \text{ sine}$	80 51 49	A A A
$I_{TSM}^*, I_{FSM}$	$T_{VJ} = 45^\circ\text{C};$ $V_R = 0$	$t = 10 \text{ ms (50 Hz), sine}$ $t = 8.3 \text{ ms (60 Hz), sine}$	1150 1230 A A
	$T_{VJ} = T_{VJM}$ $V_R = 0$	$t = 10 \text{ ms (50 Hz), sine}$ $t = 8.3 \text{ ms (60 Hz), sine}$	1000 1070 A A
$\int i^2 dt$	$T_{VJ} = 45^\circ\text{C}$ $V_R = 0$	$t = 10 \text{ ms (50 Hz), sine}$ $t = 8.3 \text{ ms (60 Hz), sine}$	6600 6280 $A^2s$ $A^2s$
	$T_{VJ} = T_{VJM}$ $V_R = 0$	$t = 10 \text{ ms (50 Hz), sine}$ $t = 8.3 \text{ ms (60 Hz), sine}$	5000 4750 $A^2s$ $A^2s$
$(di/dt)_{cr}$	$T_{VJ} = T_{VJM}$ $f = 50 \text{ Hz}, t_p = 200 \mu s$ $V_D = 2/3 V_{DRM}$ $I_G = 0.45 \text{ A}$ $di_G/dt = 0.45 \text{ A}/\mu s$	repetitive, $I_T = 150 \text{ A}$  non repetitive, $I_T = I_{TAVM}$	150  500 $A/\mu s$ $A/\mu s$
$(dv/dt)_{cr}$	$T_{VJ} = T_{VJM};$ $R_{GK} = \infty; \text{ method 1 (linear voltage rise)}$	$V_{DR} = 2/3 V_{DRM}$	1000 $V/\mu s$
$P_{GM}$	$T_{VJ} = T_{VJM}$ $I_T = I_{TAVM}$	$t_p = 30 \mu s$ $t_p = 300 \mu s$	10 5 W W
$P_{GAV}$			0.5 W
$V_{RGM}$			10 V
$T_{VJ}$			-40...+125 $^\circ\text{C}$
$T_{VJM}$			125 $^\circ\text{C}$
$T_{stg}$			-40...+125 $^\circ\text{C}$
$V_{ISOL}$	50/60 Hz, RMS $I_{ISOL} \leq 1 \text{ mA}$	$t = 1 \text{ min}$ $t = 1 \text{ s}$	3000 3600 V~ V~
$M_d$	Mounting torque (M5) Terminal connection torque (M5)		2.5-4.0/22-35 Nm/lb.in. 2.5-4.0/22-35 Nm/lb.in.
Weight	Typical including screws		90 g

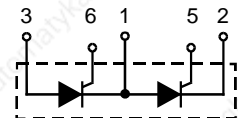
TO-240 AA



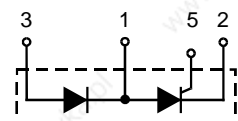
MCC  
Version 1 B



MCC  
Version 8 B



MCD  
Version 8 B



### Features

- International standard package, JEDEC TO-240 AA
- Direct copper bonded  $Al_2O_3$  -ceramic base plate
- Planar passivated chips
- Isolation voltage 3600 V~
- UL registered, E 72873
- Gate-cathode twin pins for version 1B

### Applications

- DC motor control
- Softstart AC motor controller
- Light, heat and temperature control

### Advantages

- Space and weight savings
- Simple mounting with two screws
- Improved temperature and power cycling
- Reduced protection circuits

Data according to IEC 60747 and refer to a single thyristor/diode unless otherwise stated. IXYS reserves the right to change limits, test conditions and dimensions

Symbol	Test Conditions	Characteristic Values
$I_{RRM}, I_{DRM}$	$T_{VJ} = T_{VJM}; V_R = V_{RRM}; V_D = V_{DRM}$	5 mA
$V_T, V_F$	$I_T, I_F = 200 \text{ A}; T_{VJ} = 25^\circ\text{C}$	1.75 V
$V_{T0}$	For power-loss calculations only ( $T_{VJ} = 125^\circ\text{C}$ )	0.85 V
$r_T$		5.3 mΩ
$V_{GT}$	$V_D = 6 \text{ V}; T_{VJ} = 25^\circ\text{C}$	1.5 V
	$T_{VJ} = -40^\circ\text{C}$	1.6 V
$I_{GT}$	$V_D = 6 \text{ V}; T_{VJ} = 25^\circ\text{C}$	100 mA
	$T_{VJ} = -40^\circ\text{C}$	200 mA
$V_{GD}$	$T_{VJ} = T_{VJM}; V_D = 2/3 V_{DRM}$	0.2 V
$I_{GD}$		10 mA
$I_L$	$T_{VJ} = 25^\circ\text{C}; t_p = 10 \mu\text{s}, V_D = 6 \text{ V}$ $I_G = 0.45 \text{ A}; di_G/dt = 0.45 \text{ A}/\mu\text{s}$	450 mA
$I_H$	$T_{VJ} = 25^\circ\text{C}; V_D = 6 \text{ V}; R_{GK} = \infty$	200 mA
$t_{gd}$	$T_{VJ} = 25^\circ\text{C}; V_D = 1/2 V_{DRM}$ $I_G = 0.45 \text{ A}; di_G/dt = 0.45 \text{ A}/\mu\text{s}$	2 μs
$t_q$	$T_{VJ} = T_{VJM}; I_T = 120 \text{ A}, t_p = 200 \mu\text{s}; -di/dt = 10 \text{ A}/\mu\text{s}$ typ. $V_R = 100 \text{ V}; dv/dt = 20 \text{ V}/\mu\text{s}; V_D = 2/3 V_{DRM}$	150 μs
$Q_S$	$T_{VJ} = T_{VJM}; I_T, I_F = 50 \text{ A}, -di/dt = 0.64 \text{ A}/\mu\text{s}$	90 μC
$I_{RM}$		11 A
$R_{thJC}$	per thyristor/diode; DC current per module	0.53 K/W
$R_{thJK}$	per thyristor/diode; DC current per module	0.265 K/W
	other values see Fig. 8/9	0.73 K/W
		0.365 K/W
$d_s$	Creepage distance on surface	12.7 mm
$d_A$	Strike distance through air	9.6 mm
$a$	Maximum allowable acceleration	50 m/s <sup>2</sup>

Optional accessories for module-type MCC 44 version 1 B

Keyed gate/cathode twin plugs with wire length = 350 mm, gate = yellow, cathode = red

Type ZY 200L (L = Left for pin pair 4/5) } UL 758, style 1385,  
Type ZY 200R (R = right for pin pair 6/7) } CSA class 5851, guide 460-1-1

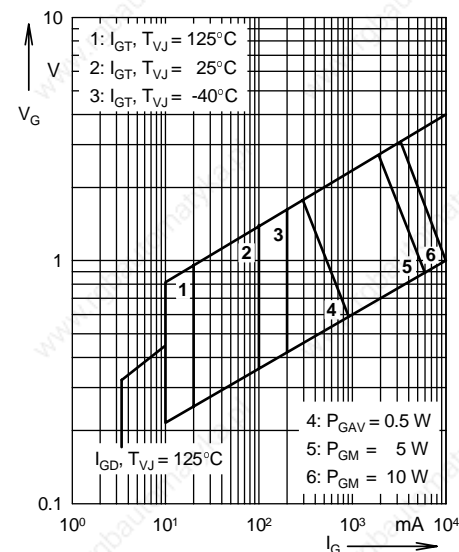


Fig. 1 Gate trigger characteristics

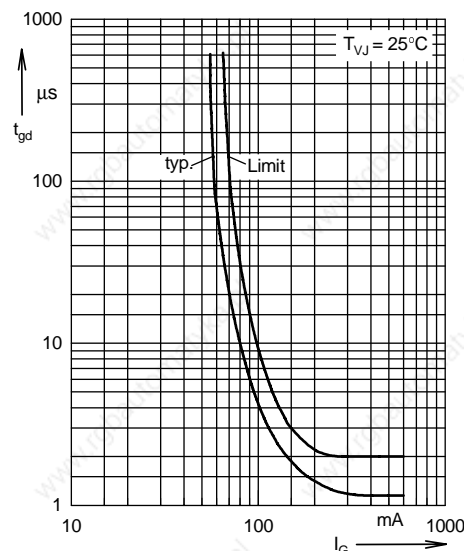
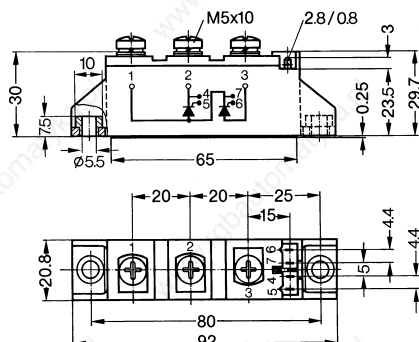


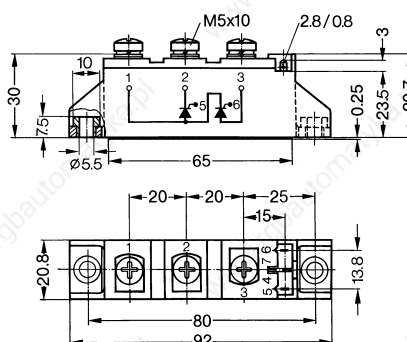
Fig. 2 Gate trigger delay time

### Dimensions in mm (1 mm = 0.0394")

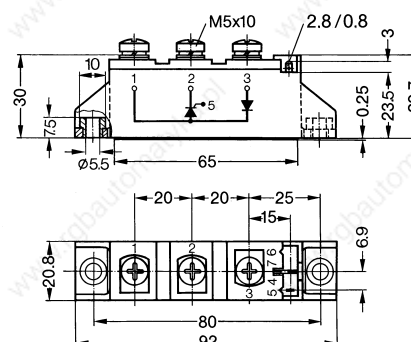
#### MCC Version 1 B



#### MCC Version 8 B



#### MCD Version 8 B



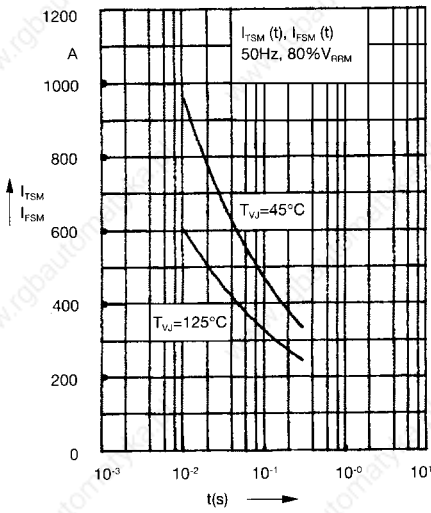


Fig. 3 Surge overload current  
 $I_{TSM}^*$   $I_{FSM}^*$ : Crest value, t: duration

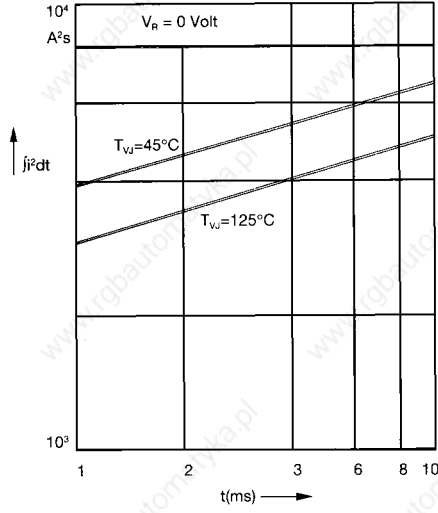


Fig. 4  $\int i^2 dt$  versus time (1-10 ms)

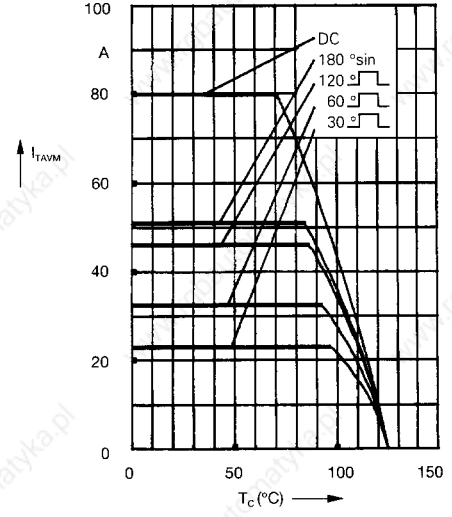


Fig. 4a Maximum forward current at case temperature

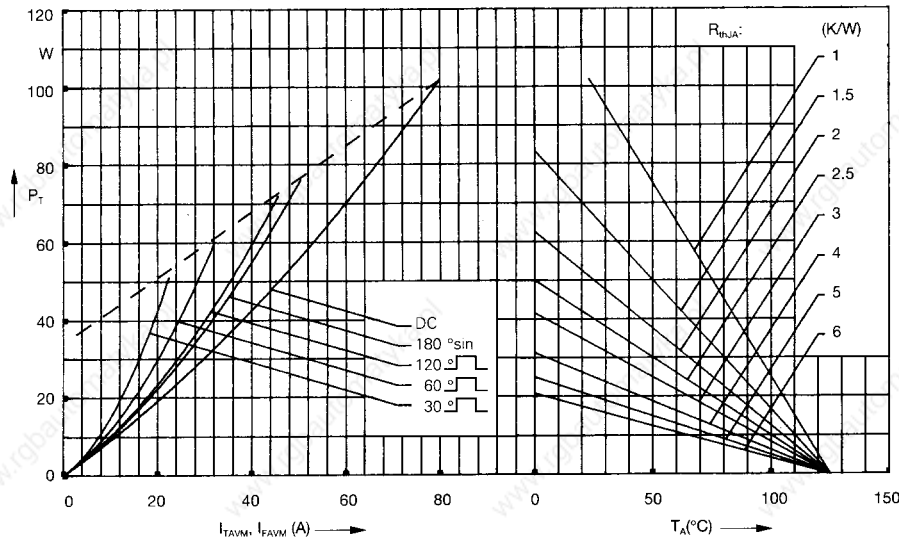


Fig. 5 Power dissipation versus on-state current and ambient temperature (per thyristor or diode)

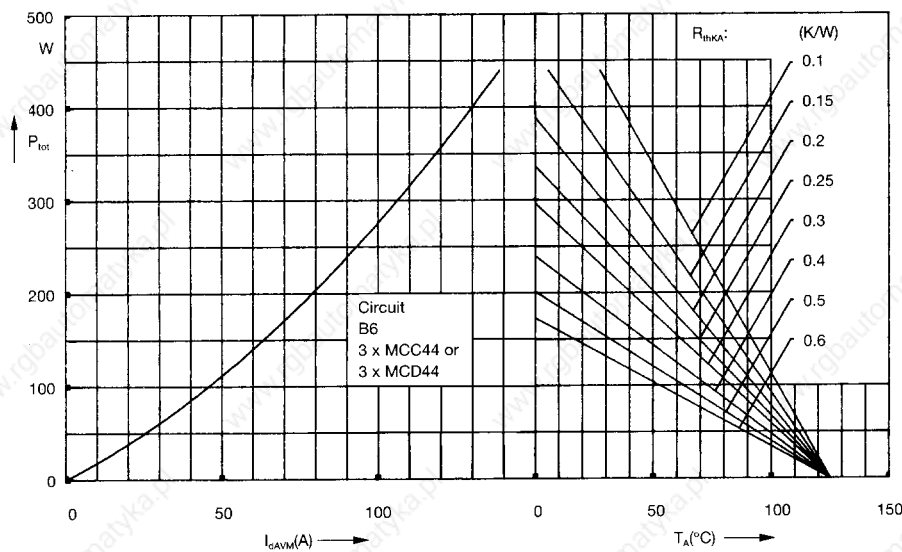


Fig. 6 Three phase rectifier bridge: Power dissipation versus direct output current and ambient temperature



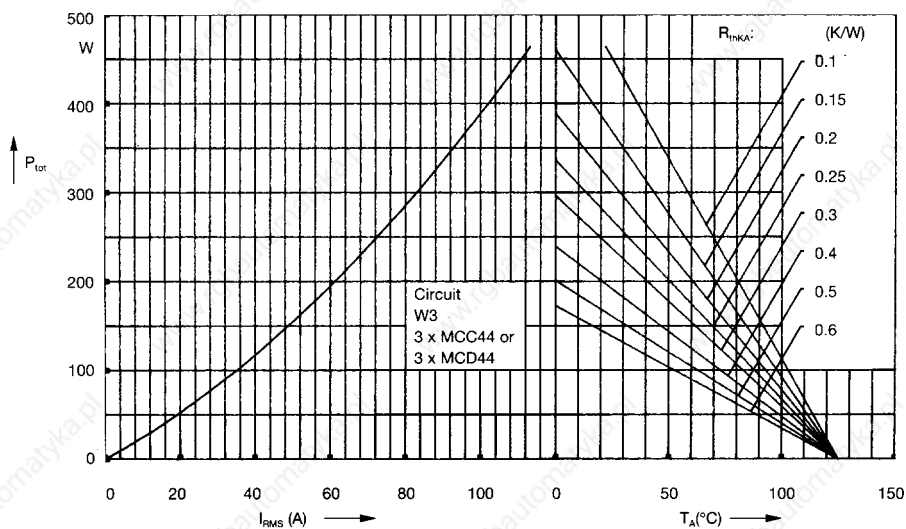


Fig. 7 Three phase AC-controller:  
Power dissipation versus RMS  
output current and ambient  
temperature

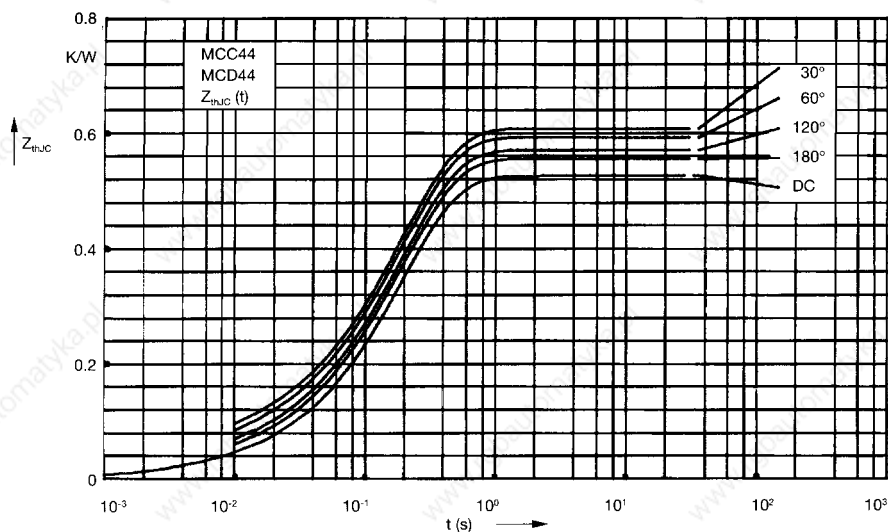


Fig. 8 Transient thermal impedance  
junction to case (per thyristor or  
diode)

$R_{thJC}$  for various conduction angles d:

d	$R_{thJC}$ (K/W)
DC	0.53
180°	0.55
120°	0.58
60°	0.6
30°	0.62

Constants for  $Z_{thJC}$  calculation:

i	$R_{thi}$ (K/W)	$t_i$ (s)
1	0.015	0.0035
2	0.026	0.02
3	0.489	0.195

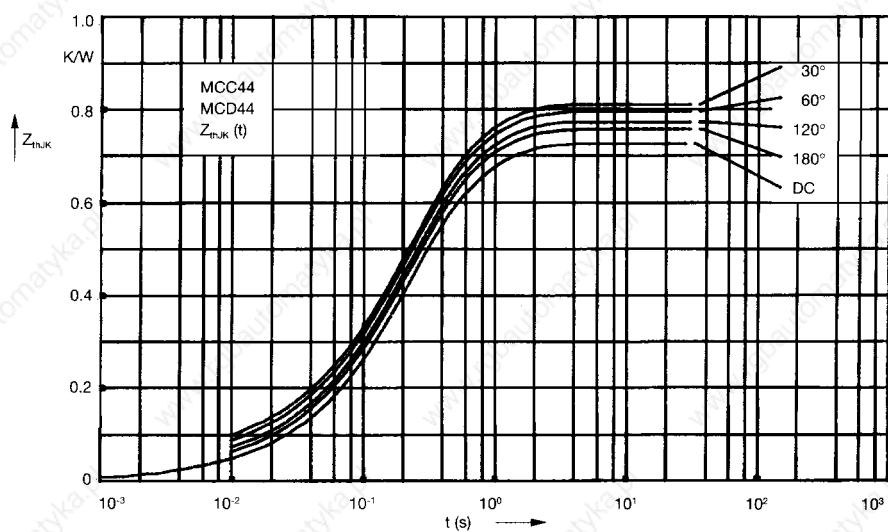


Fig. 9 Transient thermal impedance  
junction to heatsink (per thyristor  
or diode)

$R_{thJK}$  for various conduction angles d:

d	$R_{thJK}$ (K/W)
DC	0.73
180°	0.75
120°	0.78
60°	0.8
30°	0.82

Constants for  $Z_{thJK}$  calculation:

i	$R_{thi}$ (K/W)	$t_i$ (s)
1	0.015	0.0035
2	0.026	0.02
3	0.489	0.195
4	0.2	0.68

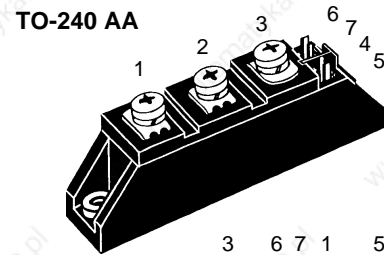
## Thyristor Modules Thyristor/Diode Modules

$I_{TRMS} = 2 \times 100 \text{ A}$   
 $I_{TAVM} = 2 \times 64 \text{ A}$   
 $V_{RRM} = 800-1800 \text{ V}$

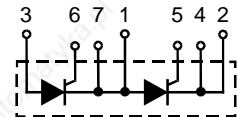
$V_{RSM}$ $V_{DSM}$	$V_{RRM}$ $V_{DRM}$	Type			
V	V	Version 1		Version 8	
900	800	MCC 56-08io1 B	MCD 56-08io1 B	MCC 56-08io8 B	MCD 56-08io8 B
1300	1200	MCC 56-12io1 B	MCD 56-12io1 B	MCC 56-12io8 B	MCD 56-12io8 B
1500	1400	MCC 56-14io1 B	--	MCC 56-14io8 B	MCD 56-14io8 B
1700	1600	MCC 56-16io1 B	MCD 56-16io1 B	MCC 56-16io8 B	MCD 56-16io8 B
1900	1800	MCC 56-18io1 B	--	MCC 56-18io8 B	MCD 56-18io8 B
1500	1400	MCC 56-14io1			
1700	1600	MCC 56-16io1			
700	600	MDC 56-06io1 B			

Symbol	Test Conditions	Maximum Ratings	
$I_{TRMS}^*$ $I_{FRMS}$ $I_{TAVM}^*$ $I_{FAVM}$	$T_{VJ} = T_{VJM}$ $T_C = 83^\circ\text{C}; 180^\circ \text{ sine}$ $T_C = 85^\circ\text{C}; 180^\circ \text{ sine}$	100 64 60	A A A
$I_{TSM}^*$ $I_{FSM}$	$T_{VJ} = 45^\circ\text{C};$ $V_R = 0$ $t = 10 \text{ ms (50 Hz), sine}$ $t = 8.3 \text{ ms (60 Hz), sine}$	1500 1600	A A
$\int i^2 dt$	$T_{VJ} = 45^\circ\text{C}$ $V_R = 0$ $t = 10 \text{ ms (50 Hz), sine}$ $t = 8.3 \text{ ms (60 Hz), sine}$	11 200 10 750	$\text{A}^2\text{s}$ $\text{A}^2\text{s}$
$(di/dt)_{cr}$	$T_{VJ} = T_{VJM}$ $V_R = 0$ $t = 10 \text{ ms (50 Hz), sine}$ $t = 8.3 \text{ ms (60 Hz), sine}$	9100 8830	$\text{A}^2\text{s}$ $\text{A}^2\text{s}$
$(dv/dt)_{cr}$	$T_{VJ} = T_{VJM}$ $R_{GK} = \infty; \text{ method 1 (linear voltage rise)}$	1000	$\text{V}/\mu\text{s}$
$P_{GM}$	$T_{VJ} = T_{VJM}$ $I_T = I_{TAVM}$	$t_p = 30 \mu\text{s}$ $t_p = 300 \mu\text{s}$	10 W 5 W
$P_{GAV}$			0.5 W
$V_{RGM}$			10 V
$T_{VJ}$ $T_{VJM}$ $T_{sig}$		-40...+125 125 -40...+125	$^\circ\text{C}$ $^\circ\text{C}$ $^\circ\text{C}$
$V_{ISOL}$	50/60 Hz, RMS $I_{ISOL} \leq 1 \text{ mA}$	$t = 1 \text{ min}$ $t = 1 \text{ s}$	3000 V~ 3600 V~
$M_d$	Mounting torque (M5) Terminal connection torque (M5)	2.5-4.0/22-35 2.5-4.0/22-35	Nm/lb.in. Nm/lb.in.
Weight	Typical including screws	90	g

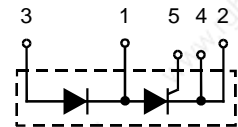
Data according to IEC 60747 and refer to a single thyristor/diode unless otherwise stated.  
IXYS reserves the right to change limits, test conditions and dimensions



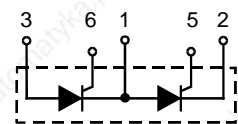
MCC  
Version 1



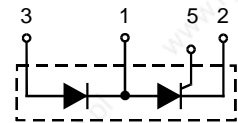
MCD  
Version 1



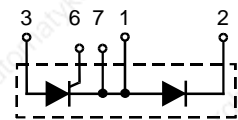
MCC  
Version 8



MCD  
Version 8



MDC  
Version 1



### Features

- International standard package, JEDEC TO-240 AA
- Direct copper bonded  $\text{Al}_2\text{O}_3$  -ceramic base plate
- Planar passivated chips
- Isolation voltage 3600 V~
- UL registered, E 72873
- Gate-cathode twin pins for version 1B

### Applications

- DC motor control
- Softstart AC motor controller
- Light, heat and temperature control

### Advantages

- Space and weight savings
- Simple mounting with two screws
- Improved temperature and power cycling
- Reduced protection circuits

Symbol	Test Conditions	Characteristic Values
$I_{RRM}, I_{DRM}$	$T_{VJ} = T_{VJM}; V_R = V_{RRM}; V_D = V_{DRM}$	5 mA
$V_T, V_F$	$I_T, I_F = 200 \text{ A}; T_{VJ} = 25^\circ\text{C}$	1.57 V
$V_{T0}$	For power-loss calculations only ( $T_{VJ} = 125^\circ\text{C}$ )	0.85 V
$r_T$		3.7 mΩ
$V_{GT}$	$V_D = 6 \text{ V}; T_{VJ} = 25^\circ\text{C}$	1.5 V
	$T_{VJ} = -40^\circ\text{C}$	1.6 V
$I_{GT}$	$V_D = 6 \text{ V}; T_{VJ} = 25^\circ\text{C}$	100 mA
	$T_{VJ} = -40^\circ\text{C}$	200 mA
$V_{GD}$	$T_{VJ} = T_{VJM}; V_D = 2/3 V_{DRM}$	0.2 V
$I_{GD}$		10 mA
$I_L$	$T_{VJ} = 25^\circ\text{C}; t_p = 10 \mu\text{s}; V_D = 6 \text{ V}$ $I_G = 0.45 \text{ A}; di_G/dt = 0.45 \text{ A}/\mu\text{s}$	450 mA
$I_H$	$T_{VJ} = 25^\circ\text{C}; V_D = 6 \text{ V}; R_{GK} = \infty$	200 mA
$t_{gd}$	$T_{VJ} = 25^\circ\text{C}; V_D = 1/2 V_{DRM}$ $I_G = 0.45 \text{ A}; di_G/dt = 0.45 \text{ A}/\mu\text{s}$	2 μs
$t_q$	$T_{VJ} = T_{VJM}; I_T = 150 \text{ A}, t_p = 200 \mu\text{s}; -di/dt = 10 \text{ A}/\mu\text{s}$ typ. $V_R = 100 \text{ V}; dv/dt = 20 \text{ V}/\mu\text{s}; V_D = 2/3 V_{DRM}$	150 μs
$Q_S$	$T_{VJ} = T_{VJM}; I_T, I_F = 50 \text{ A}, -di/dt = 3 \text{ A}/\mu\text{s}$	100 μC
$I_{RM}$		24 A
$R_{thJC}$	per thyristor/diode; DC current per module	0.45 K/W
$R_{thJK}$	per thyristor/diode; DC current per module	0.225 K/W
	other values see Fig. 8/9	0.65 K/W
		0.325 K/W
$d_s$	Creepage distance on surface	12.7 mm
$d_A$	Strike distance through air	9.6 mm
$a$	Maximum allowable acceleration	50 m/s <sup>2</sup>

Optional accessories for module-type MCC 56 version 1 B

Keyed gate/cathode twin plugs with wire length = 350 mm, gate = yellow, cathode = red

Type **ZY 200L** (L = Left for pin pair 4/5) } UL 758, style 1385,  
Type **ZY 200R** (R = right for pin pair 6/7) } CSA class 5851, guide 460-1-1

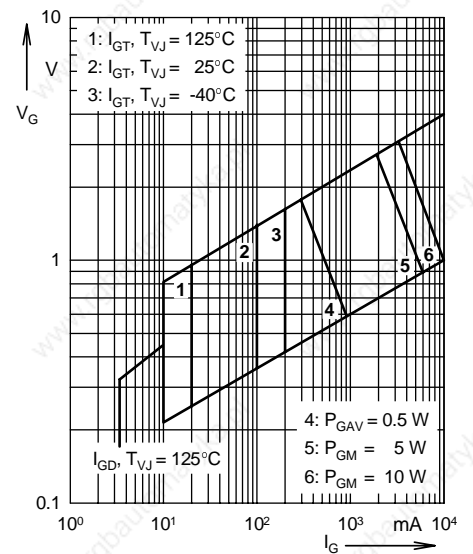


Fig. 1 Gate trigger characteristics

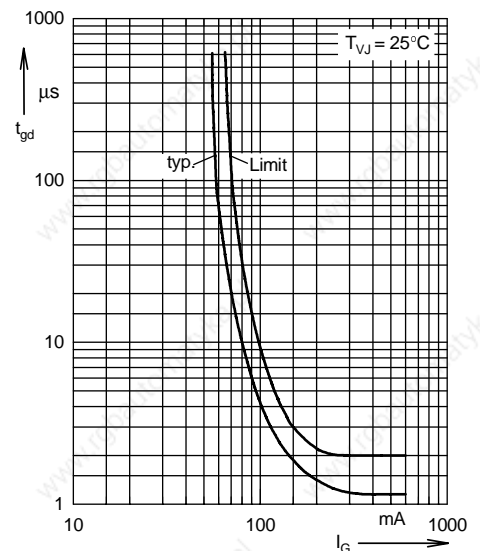
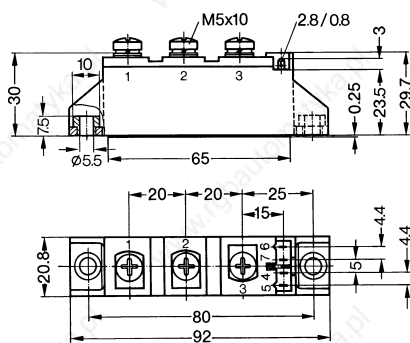


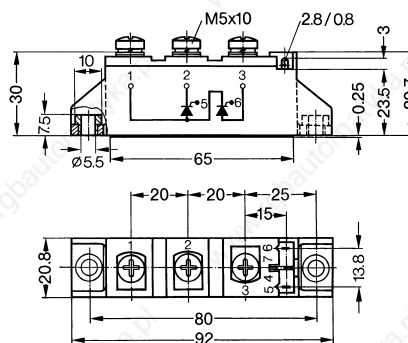
Fig. 2 Gate trigger delay time

Dimensions in mm (1 mm = 0.0394")

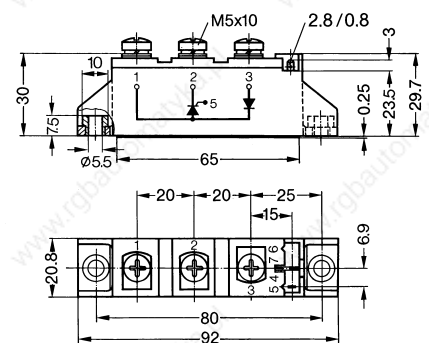
**MCC / MCD / MDC Version 1 B**



**MCC Version 8 B**



**MCD Version 8 B**



Version 1 or 8 without B in typ designation = without insert in mountig holes

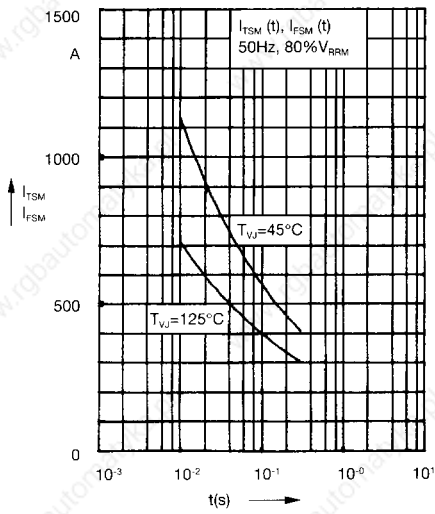


Fig. 3 Surge overload current  
 $I_{TSM}$ ,  $I_{FSM}$ : Crest value, t: duration

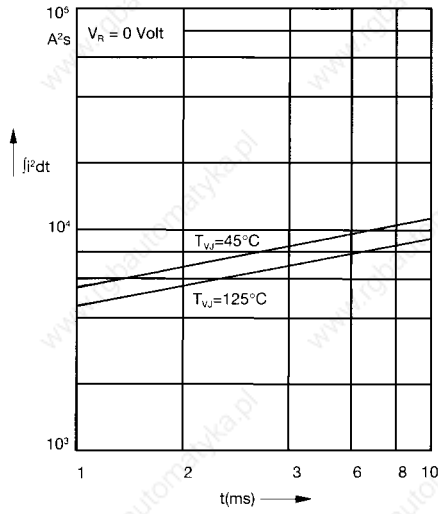


Fig. 4  $\int i^2 dt$  versus time (1-10 ms)

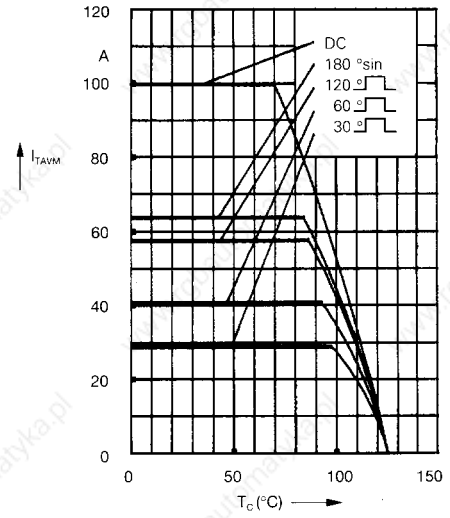


Fig. 4a Maximum forward current at case temperature

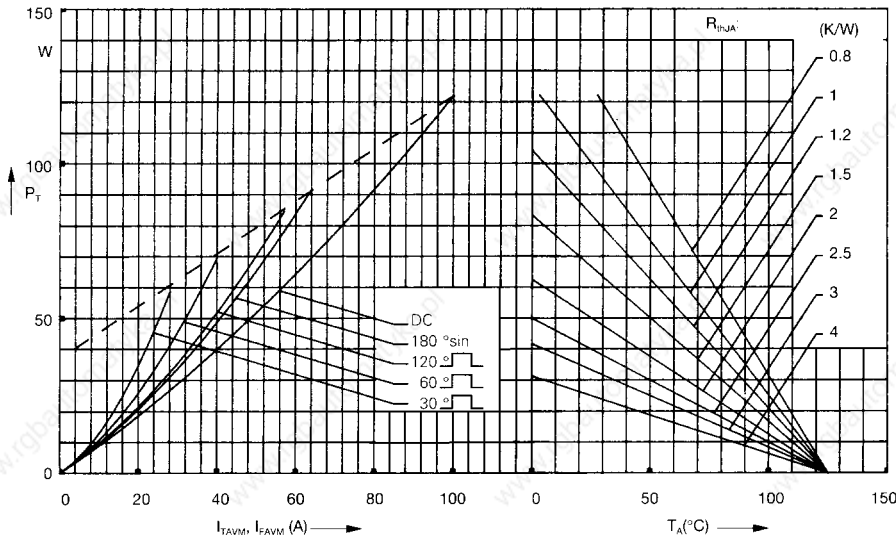


Fig. 5 Power dissipation versus on-state current and ambient temperature (per thyristor or diode)

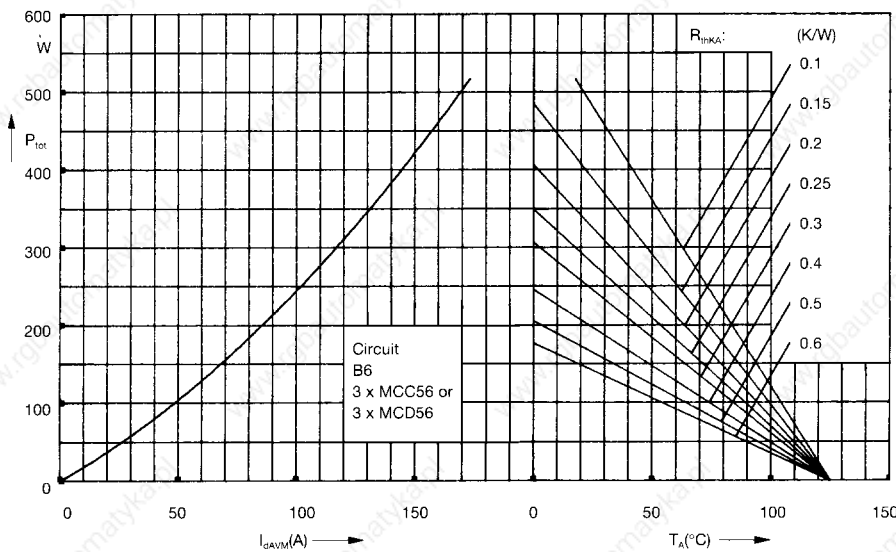


Fig. 6 Three phase rectifier bridge: Power dissipation versus direct output current and ambient temperature

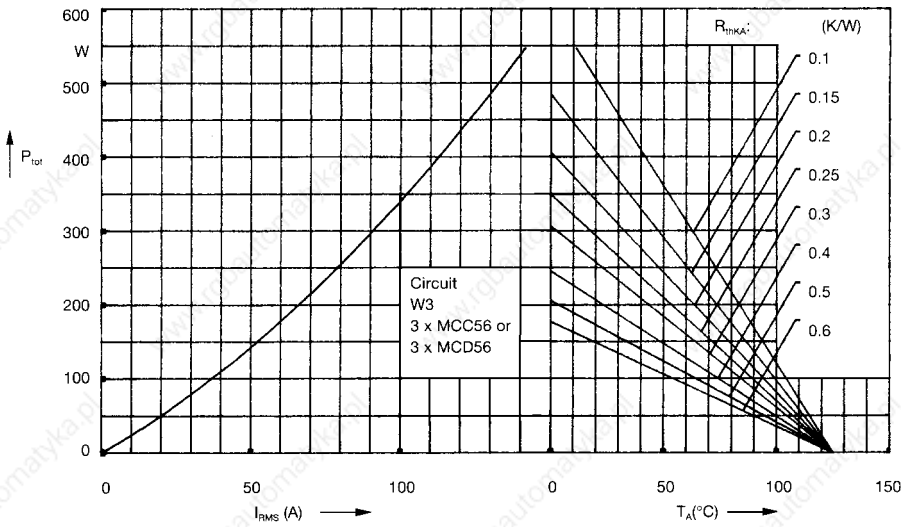


Fig. 7 Three phase AC-controller: Power dissipation versus RMS output current and ambient temperature

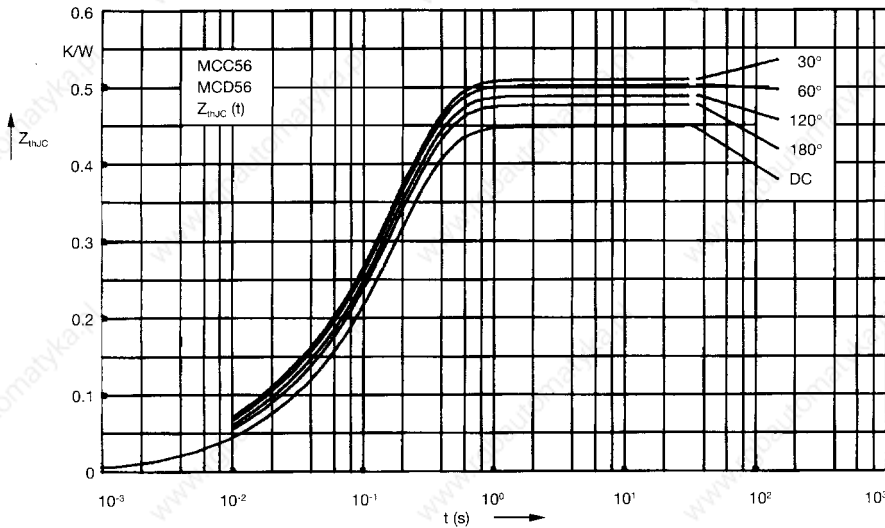


Fig. 8 Transient thermal impedance junction to case (per thyristor or diode)

$R_{thJC}$  for various conduction angles d:

d	$R_{thJC}$ (K/W)
DC	0.45
180°	0.47
120°	0.49
60°	0.505
30°	0.52

Constants for  $Z_{thJC}$  calculation:

i	$R_{thi}$ (K/W)	$t_i$ (s)
1	0.014	0.015
2	0.026	0.0095
3	0.41	0.175

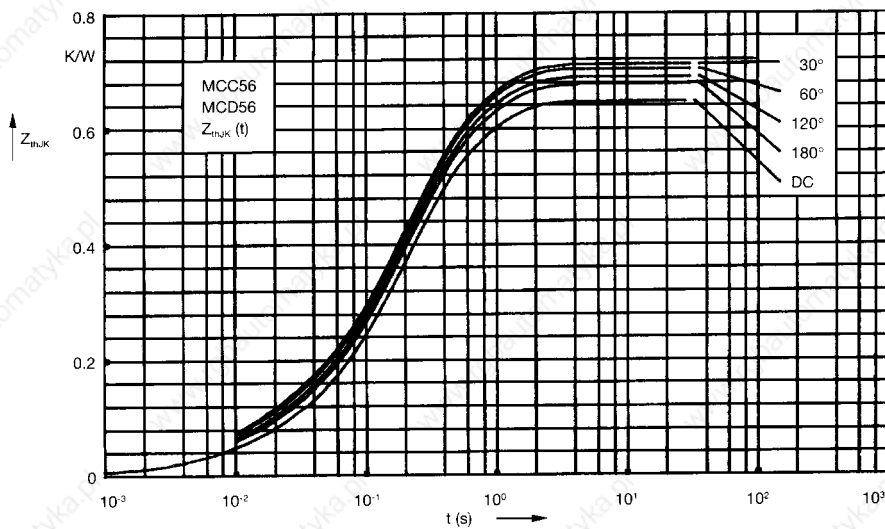


Fig. 9 Transient thermal impedance junction to heatsink (per thyristor or diode)

$R_{thJK}$  for various conduction angles d:

d	$R_{thJK}$ (K/W)
DC	0.65
180°	0.67
120°	0.69
60°	0.705
30°	0.72

Constants for  $Z_{thJK}$  calculation:

i	$R_{thi}$ (K/W)	$t_i$ (s)
1	0.014	0.015
2	0.026	0.0095
3	0.41	0.175
4	0.2	0.67

## Thyristor Module

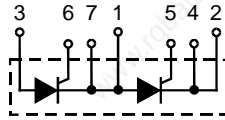
Preliminary data

$$I_{TRMS} = 2 \times 100 \text{ A}$$

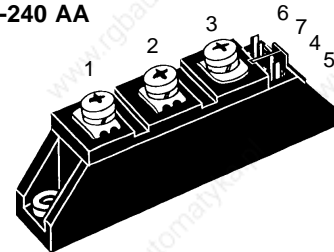
$$I_{TAVM} = 2 \times 64 \text{ A}$$

$$V_{RRM, DRM} = 1600 \text{ V}$$

$V_{RSM}$	$V_{RRM}$	Type
$V_{DSM}$	$V_{DRM}$	
V	V	
1700	1600	MCC 60-16io1 B



TO-240 AA



Symbol	Conditions	Maximum Ratings
$I_{TRMS}, I_{FRMS}$ $I_{TAVM}$	$T_{VJ} = T_{VJM}$ $T_C = 85^\circ\text{C}; 180^\circ \text{ sine}$	100 A 64 A
$I_{TSM}, I_{FSM}$	$T_{VJ} = 45^\circ\text{C};$ $V_R = 0$	$t = 10 \text{ ms (50 Hz), sine}$ 1150 A $t = 8.3 \text{ ms (60 Hz), sine}$ 1230 A
	$T_{VJ} = T_{VJM}$ $V_R = 0$	$t = 10 \text{ ms (50 Hz), sine}$ 1000 A $t = 8.3 \text{ ms (60 Hz), sine}$ 1070 A
$I^2dt$	$T_{VJ} = 45^\circ\text{C}$ $V_R = 0$	$t = 10 \text{ ms (50 Hz), sine}$ 6610 A <sup>2</sup> s $t = 8.3 \text{ ms (60 Hz), sine}$ 6350 A <sup>2</sup> s
	$T_{VJ} = T_{VJM}$ $V_R = 0$	$t = 10 \text{ ms (50 Hz), sine}$ 5000 A <sup>2</sup> s $t = 8.3 \text{ ms (60 Hz), sine}$ 4810 A <sup>2</sup> s
$(di/dt)_{cr}$	$T_{VJ} = T_{VJM}$ $f = 50\text{Hz}, t_p = 200\mu\text{s}$ $V_D = \frac{2}{3} V_{DRM}$ $I_G = 0.45 \text{ A}$ $di_G/dt = 0.45 \text{ A}/\mu\text{s}$	repetitive, $I_T = 150 \text{ A}$ 150 A/ $\mu\text{s}$ non repetitive, $I_T = I_{TAVM}$ 500 A/ $\mu\text{s}$
$(dv/dt)_{cr}$	$T_{VJ} = T_{VJM};$ $R_{GK} = \infty;$ method 1 (linear voltage rise)	$V_{DR} = \frac{2}{3} V_{DRM}$ 1000 V/ $\mu\text{s}$
$P_{GM}$	$T_{VJ} = T_{VJM}$ $I_T = I_{TAVM}$	$t_p = 30 \mu\text{s}$ 10 W $t_p = 300 \mu\text{s}$ 5 W
$P_{GAV}$		0.5 W
$V_{RGM}$		10 V
$T_{VJ}$		-40...+140 °C
$T_{VJM}$		140 °C
$T_{stg}$		-40...+125 °C
$V_{ISOL}$	50/60 Hz, RMS $I_{ISOL} \leq 1 \text{ mA}$	$t = 1 \text{ min}$ 3000 V~ $t = 1 \text{ s}$ 3600 V~
$M_d$	Mounting torque (M5) Terminal connection torque (M5)	2.5-4.0/22-35 Nm/lb.in. 2.5-4.0/22-35 Nm/lb.in.
Weight	Typical including screws	90 g

### Features

- International standard package
- Direct copper bonded Al<sub>2</sub>O<sub>3</sub>-ceramic base plate
- Planar passivated chips
- Isolation voltage 3600 V~
- Gate-cathode twin pins

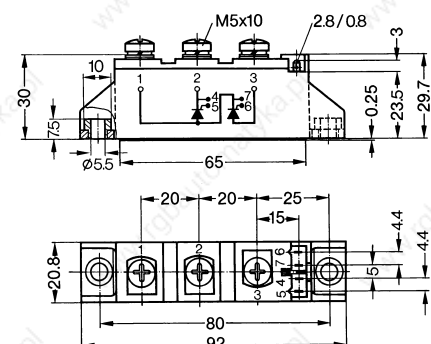
### Applications

- DC motor control
- Softstart AC motor controller
- Light, heat and temperature control

### Advantages

- Space and weight savings
- Simple mounting with two screws
- Improved temperature and power cycling
- Reduced protection circuits

### Dimensions in mm (1 mm = 0.0394")



Data according to IEC 60747 and refer to a single thyristor/diode unless otherwise stated. IXYS reserves the right to change limits, test conditions and dimensions

Symbol	Conditions	Characteristic Values
$I_{RRM}, I_{DRM}$	$T_{VJ} = T_{VJM}; V_R = V_{RRM}; V_D = V_{DRM}$	20 mA
$V_T, V_F$	$I_T, I_F = 200 \text{ A}; T_{VJ} = 25^\circ\text{C}$	1.70 V
$V_{T0}$	$T_{VJ} = 125^\circ\text{C};$ For power-loss calculations only	0.85 V
$r_T$	$T_{VJ} = T_{VJM}$	4.8 mΩ
$V_{GT}$	$V_D = 6 \text{ V}; T_{VJ} = 25^\circ\text{C}$	1.4 V
	$T_{VJ} = -40^\circ\text{C}$	1.6 V
$I_{GT}$	$V_D = 6 \text{ V}; T_{VJ} = 25^\circ\text{C}$	100 mA
	$T_{VJ} = -40^\circ\text{C}$	200 mA
$V_{GD}$	$T_{VJ} = T_{VJM}; V_D = \frac{2}{3} V_{DRM}$	0.2 V
$I_{GD}$		10 mA
$I_L$	$T_{VJ} = 25^\circ\text{C}; t_p = 10 \mu\text{s}, V_D = 6 \text{ V}$ $I_G = 0.45 \text{ A}; di_G/dt = 0.45 \text{ A}/\mu\text{s}$	450 mA
$I_H$	$T_{VJ} = 25^\circ\text{C}; V_D = 6 \text{ V}; R_{GK} = \infty$	200 mA
$t_{gd}$	$T_{VJ} = 25^\circ\text{C}; V_D = \frac{1}{2} V_{DRM}$ $I_G = 0.45 \text{ A}; di_G/dt = 0.45 \text{ A}/\mu\text{s}$	2 μs
$t_q$	$T_{VJ} = T_{VJM}; I_T = 120 \text{ A}, t_p = 200 \mu\text{s}; -di/dt = 10 \text{ A}/\mu\text{s typ.}$ $V_R = 100 \text{ V}; dv/dt = 20 \text{ V}/\mu\text{s}; V_D = \frac{2}{3} V_{DRM}$	150 μs
$Q_S$	$T_{VJ} = T_{VJM}; I_T, I_F = 50 \text{ A}, -di/dt = 0.64 \text{ A}/\mu\text{s}$	110 μC
$I_{RM}$		12 A
$R_{thJC}$	per thyristor/diode; DC current	0.5 K/W
	per module	0.25 K/W
$R_{thCH}$	per thyristor/diode; DC current	typ. 0.1 K/W
$d_s$	Creepage distance on surface	12.7 mm
$d_A$	Strike distance through air	9.6 mm
$a$	Maximum allowable acceleration	50 m/s <sup>2</sup>

Optional accessories for module-type MCC 60 version 1 B

Keyed gate/cathode twin plugs with wire length = 350 mm, gate = yellow, cathode = red

Type **ZY 200L** (L = Left for pin pair 4/5) } UL 758, style 1385,

Type **ZY 200R** (R = right for pin pair 6/7) } CSA class 5851, guide 460-1-1

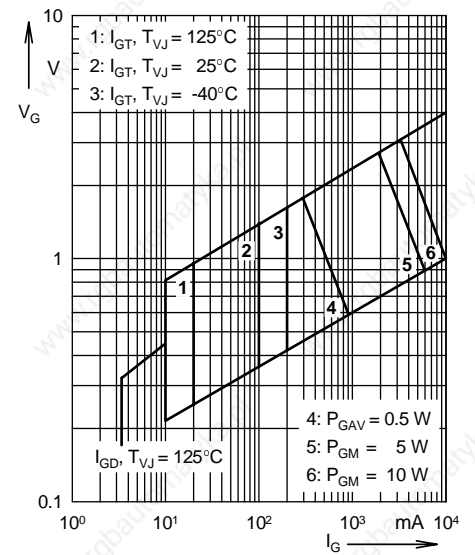


Fig. 1 Gate trigger characteristics

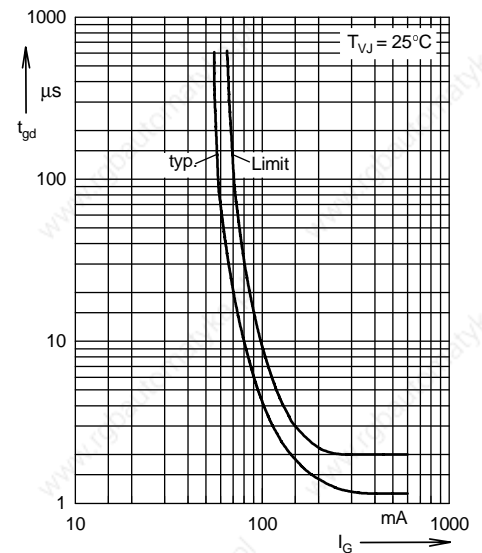


Fig. 2 Gate trigger delay time

## Thyristor Modules Thyristor/Diode Modules

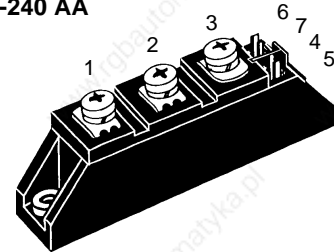
$$I_{TRMS} = 2 \times 180 \text{ A}$$

$$I_{TAVM} = 2 \times 115 \text{ A}$$

$$V_{RRM} = 800-1800 \text{ V}$$

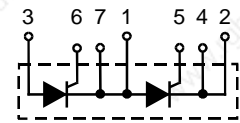
$V_{RSM}$ $V_{DSM}$	$V_{RRM}$ $V_{DRM}$	Type	
V	V	Version 1 B	Version 8 B
900	800	MCC 72-08io1 B	--
1300	1200	MCC 72-12io1 B	MCD 72-12io1 B
1500	1400	MCC 72-14io1 B	--
1700	1600	MCC 72-16io1 B	MCD 72-16io1 B
1900	1800	MCC 72-18io1 B	--
		MCC 72-08io8 B	MCD 72-08io8 B
		MCC 72-12io8 B	MCD 72-12io8 B
		MCC 72-14io8 B	MCD 72-14io8 B
		MCC 72-16io8 B	MCD 72-16io8 B
		MCC 72-18io8 B	MCD 72-18io8 B

TO-240 AA

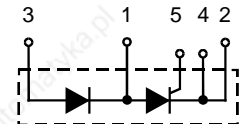


Symbol	Test Conditions	Maximum Ratings
$I_{TRMS}^*$ , $I_{FRMS}$ $I_{TAVM}^*$ , $I_{FAVM}$	$T_{VJ} = T_{VJM}$ $T_C = 63^\circ\text{C}$ ; 180° sine $T_C = 85^\circ\text{C}$ ; 180° sine	180 A 115 A 85 A
$I_{TSM}^*$ , $I_{FSM}$	$T_{VJ} = 45^\circ\text{C}$ ; $V_R = 0$ $T_{VJ} = T_{VJM}$ $V_R = 0$	$t = 10 \text{ ms}$ (50 Hz), sine $t = 8.3 \text{ ms}$ (60 Hz), sine 1700 A 1800 A 1540 A 1640 A
$\int i^2 dt$	$T_{VJ} = 45^\circ\text{C}$ $V_R = 0$ $T_{VJ} = T_{VJM}$ $V_R = 0$	$t = 10 \text{ ms}$ (50 Hz), sine $t = 8.3 \text{ ms}$ (60 Hz), sine 14 450 A <sup>2</sup> s 13 500 A <sup>2</sup> s 11 850 A <sup>2</sup> s 11 300 A <sup>2</sup> s
$(di/dt)_{cr}$	$T_{VJ} = T_{VJM}$ $f = 50 \text{ Hz}$ , $t_p = 200 \mu\text{s}$ $V_D = 2/3 V_{DRM}$ $I_G = 0.45 \text{ A}$ $di_G/dt = 0.45 \text{ A}/\mu\text{s}$	repetitive, $I_T = 250 \text{ A}$ non repetitive, $I_T = I_{TAVM}$ 150 A/ $\mu\text{s}$ 500 A/ $\mu\text{s}$
$(dv/dt)_{cr}$	$T_{VJ} = T_{VJM}$ ; $R_{GK} = \infty$ ; method 1 (linear voltage rise)	$V_{DR} = 2/3 V_{DRM}$ 1000 V/ $\mu\text{s}$
$P_{GM}$	$T_{VJ} = T_{VJM}$ $I_T = I_{TAVM}$	$t_p = 30 \mu\text{s}$ $t_p = 300 \mu\text{s}$ 10 W 5 W
$P_{GAV}$		0.5 W
$V_{RGM}$		10 V
$T_{VJ}$		-40...+125 °C
$T_{VJM}$		125 °C
$T_{sig}$		-40...+125 °C
$V_{ISOL}$	50/60 Hz, RMS $I_{ISOL} \leq 1 \text{ mA}$	$t = 1 \text{ min}$ $t = 1 \text{ s}$ 3000 V~ 3600 V~
$M_d$	Mounting torque (M5) Terminal connection torque (M5)	2.5-4.0/22-35 Nm/lb.in.
Weight	Typical including screws	90 g

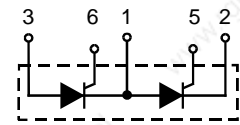
MCC  
Version 1 B



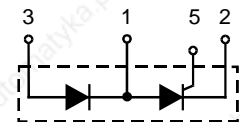
MCD  
Version 1 B



MCC  
Version 8 B



MCD  
Version 8 B



### Features

- International standard package, JEDEC TO-240 AA
- Direct copper bonded Al<sub>2</sub>O<sub>3</sub> -ceramic base plate
- Planar passivated chips
- Isolation voltage 3600 V~
- UL registered, E 72873
- Gate-cathode twin pins for version 1B

### Applications

- DC motor control
- Softstart AC motor controller
- Light, heat and temperature control

### Advantages

- Space and weight savings
- Simple mounting with two screws
- Improved temperature and power cycling
- Reduced protection circuits

Data according to IEC 60747 and refer to a single thyristor/diode unless otherwise stated. IXYS reserves the right to change limits, test conditions and dimensions



Symbol	Test Conditions	Characteristic Values
$I_{RRM}, I_{DRM}$	$T_{VJ} = T_{VJM}; V_R = V_{RRM}; V_D = V_{DRM}$	5 mA
$V_T, V_F$	$I_T, I_F = 300 \text{ A}; T_{VJ} = 25^\circ\text{C}$	1.74 V
$V_{T0}$	For power-loss calculations only ( $T_{VJ} = 125^\circ\text{C}$ )	0.85 V
$r_T$		3.2 mΩ
$V_{GT}$	$V_D = 6 \text{ V}; T_{VJ} = 25^\circ\text{C}$	2.5 V
	$T_{VJ} = -40^\circ\text{C}$	2.6 V
$I_{GT}$	$V_D = 6 \text{ V}; T_{VJ} = 25^\circ\text{C}$	150 mA
	$T_{VJ} = -40^\circ\text{C}$	200 mA
$V_{GD}$	$T_{VJ} = T_{VJM}; V_D = 2/3 V_{DRM}$	0.2 V
$I_{GD}$		10 mA
$I_L$	$T_{VJ} = 25^\circ\text{C}; t_p = 10 \mu\text{s}; V_D = 6 \text{ V}$ $I_G = 0.45 \text{ A}; di_G/dt = 0.45 \text{ A}/\mu\text{s}$	450 mA
$I_H$	$T_{VJ} = 25^\circ\text{C}; V_D = 6 \text{ V}; R_{GK} = \infty$	200 mA
$t_{gd}$	$T_{VJ} = 25^\circ\text{C}; V_D = 1/2 V_{DRM}$ $I_G = 0.45 \text{ A}; di_G/dt = 0.45 \text{ A}/\mu\text{s}$	2 μs
$t_q$	$T_{VJ} = T_{VJM}; I_T = 150 \text{ A}, t_p = 200 \mu\text{s}; -di/dt = 10 \text{ A}/\mu\text{s}$ typ. $V_R = 100 \text{ V}; dv/dt = 20 \text{ V}/\mu\text{s}; V_D = 2/3 V_{DRM}$	185 μs
$Q_S$	$T_{VJ} = T_{VJM}; I_T, I_F = 50 \text{ A}, -di/dt = 6 \text{ A}/\mu\text{s}$	170 μC
$I_{RM}$		45 A
$R_{thJC}$	per thyristor/diode; DC current per module	0.3 K/W
$R_{thJK}$	per thyristor/diode; DC current per module	0.15 K/W
	other values see Fig. 8/9	0.5 K/W
		0.25 K/W
$d_s$	Creepage distance on surface	12.7 mm
$d_A$	Strike distance through air	9.6 mm
$a$	Maximum allowable acceleration	50 m/s <sup>2</sup>

Optional accessories for module-type MCC 72 version 1 B

Keyed gate/cathode twin plugs with wire length = 350 mm, gate = yellow, cathode = red

Type ZY 200L (L = Left for pin pair 4/5) } UL 758, style 1385,  
Type ZY 200R (R = right for pin pair 6/7) } CSA class 5851, guide 460-1-1

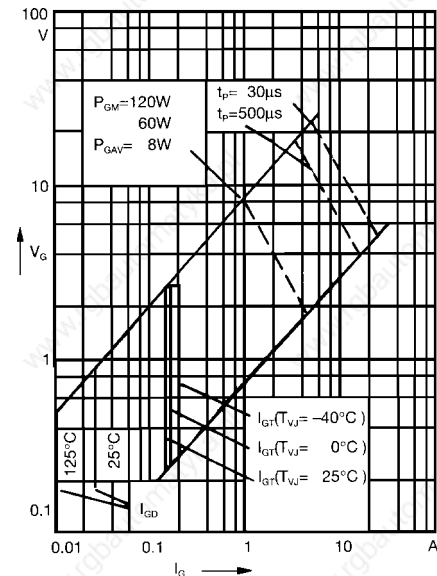


Fig. 1 Gate trigger characteristics

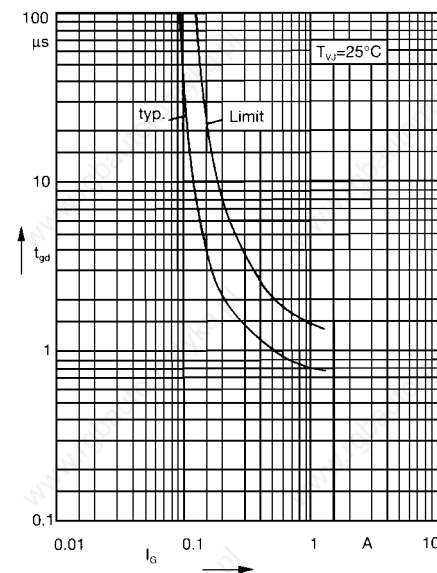
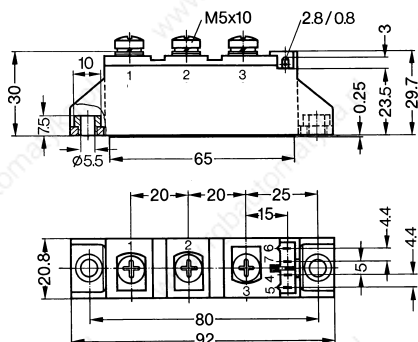


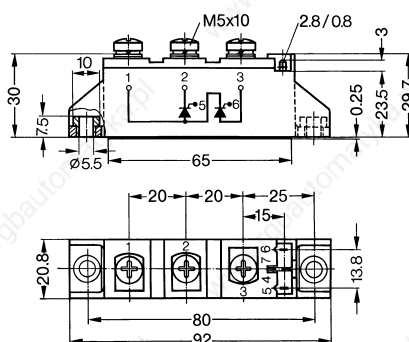
Fig. 2 Gate trigger delay time

### Dimensions in mm (1 mm = 0.0394")

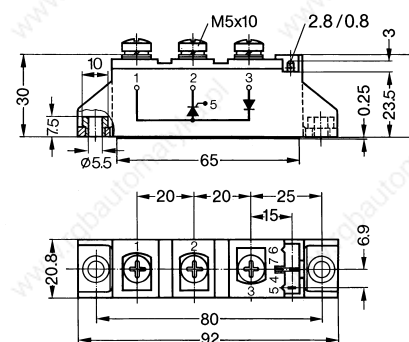
#### MCC / MCD Version 1 B



#### MCC Version 8 B



#### MCD Version 8 B



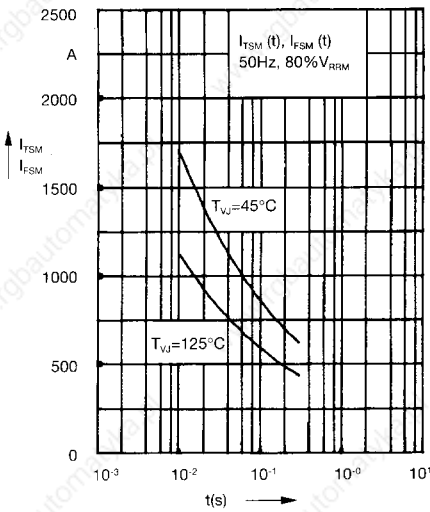


Fig. 3 Surge overload current  
 $I_{TSM}, I_{FSM}$ : Crest value,  $t$ : duration

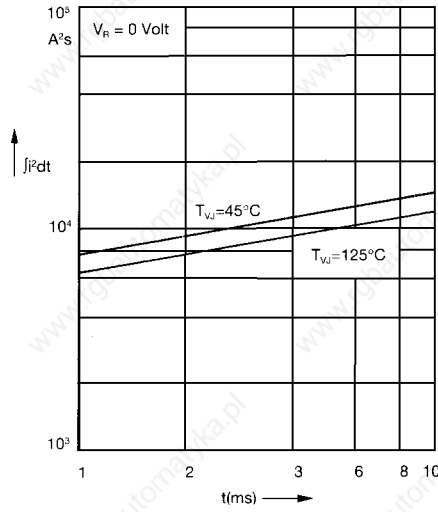


Fig. 4  $\int j^2 dt$  versus time (1-10 ms)

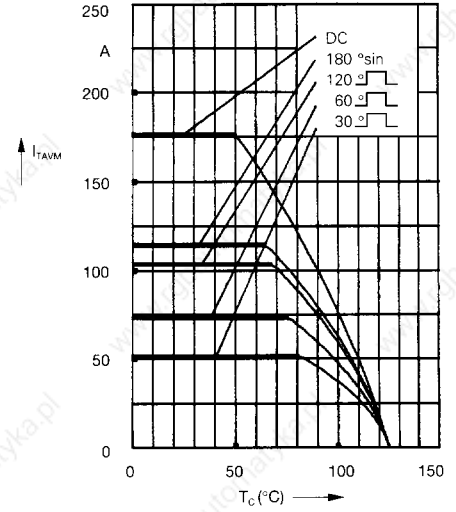


Fig. 4a Maximum forward current at case temperature

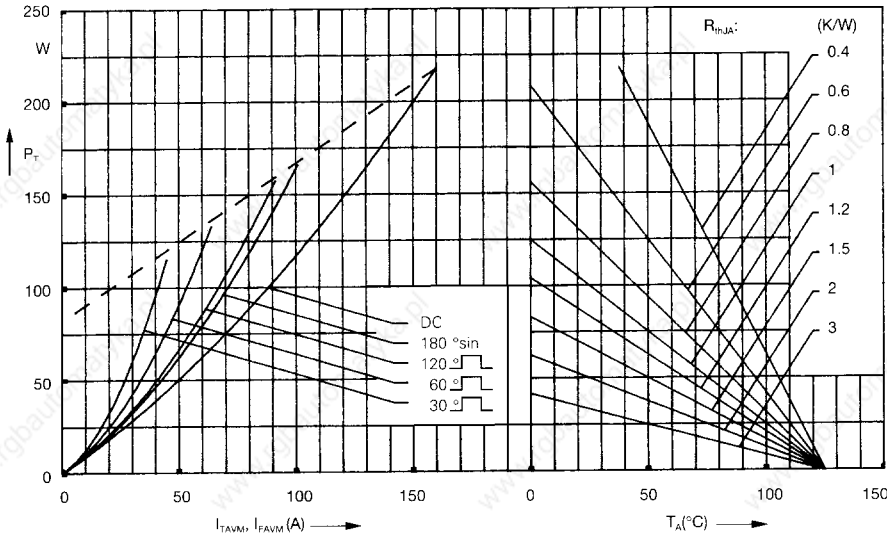


Fig. 5 Power dissipation versus on-state current and ambient temperature (per thyristor or diode)

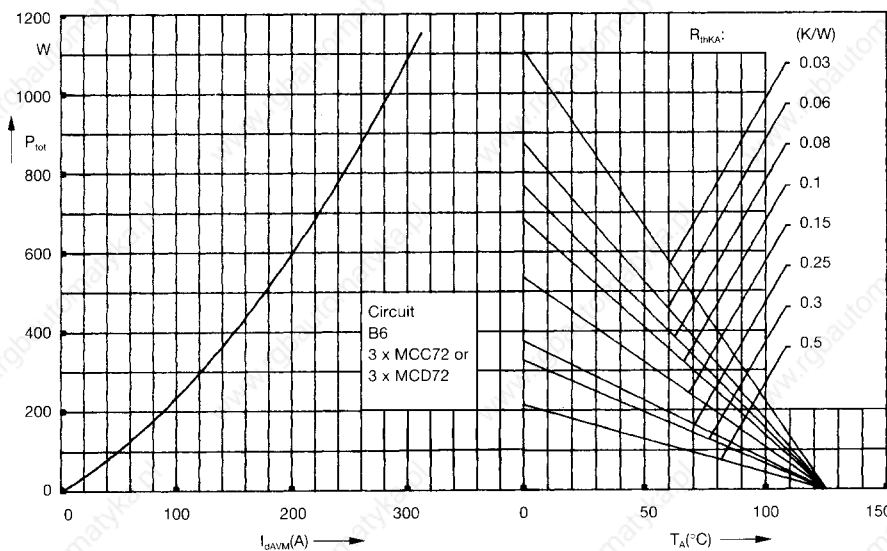


Fig. 6 Three phase rectifier bridge: Power dissipation versus direct output current and ambient temperature

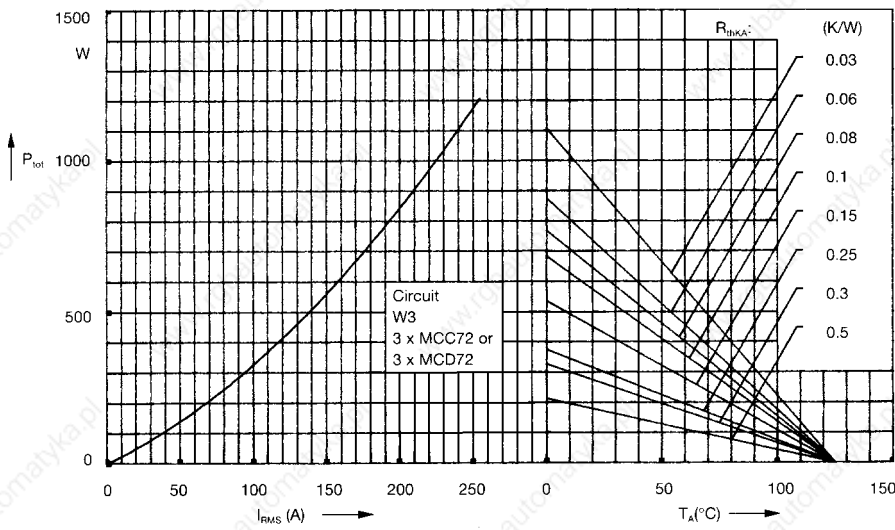


Fig. 7 Three phase AC-controller: Power dissipation versus RMS output current and ambient temperature

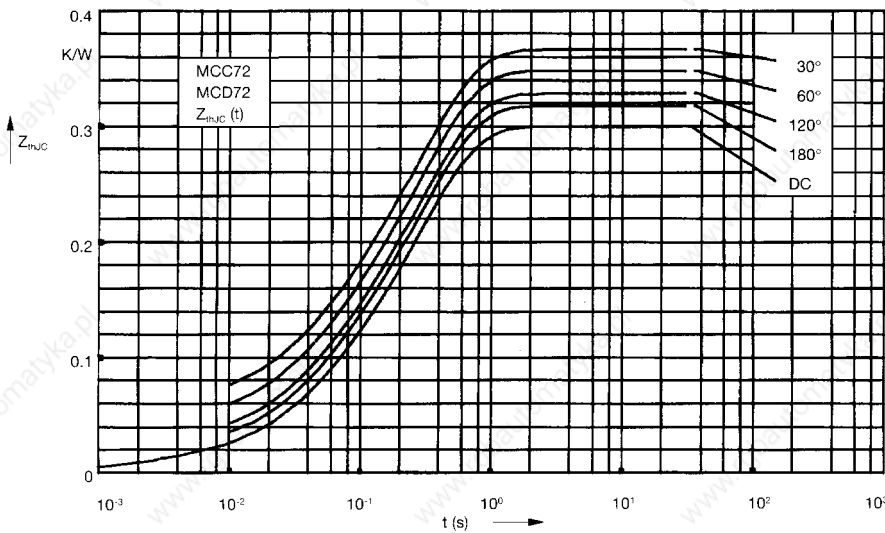


Fig. 8 Transient thermal impedance junction to case (per thyristor or diode)

$R_{thJC}$  for various conduction angles d:

d	$R_{thJC}$ (K/W)
DC	0.3
180°	0.31
120°	0.33
60°	0.35
30°	0.37

Constants for  $Z_{thJC}$  calculation:

i	$R_{thi}$ (K/W)	$t_i$ (s)
1	0.008	0.0019
2	0.054	0.047
3	0.238	0.3

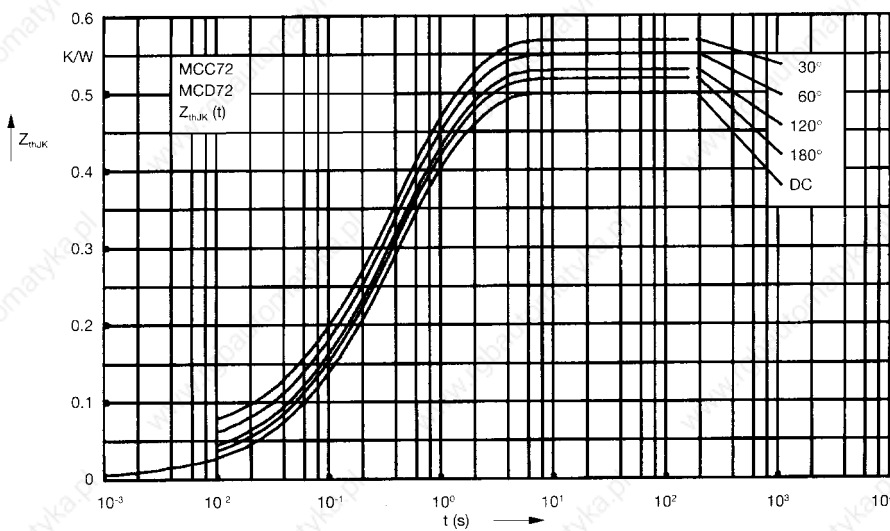


Fig. 9 Transient thermal impedance junction to heatsink (per thyristor or diode)

$R_{thJK}$  for various conduction angles d:

d	$R_{thJK}$ (K/W)
DC	0.5
180°	0.51
120°	0.53
60°	0.55
30°	0.57

Constants for  $Z_{thJK}$  calculation:

i	$R_{thi}$ (K/W)	$t_i$ (s)
1	0.008	0.0019
2	0.054	0.047
3	0.238	0.3
4	0.2	1.25

## High Voltage Thyristor Module High Voltage Thyristor/Diode Modules

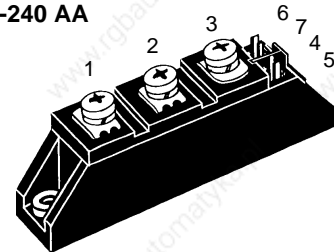
$$I_{TRMS} = 2 \times 180 \text{ A}$$

$$I_{TAVM} = 2 \times 104 \text{ A}$$

$$V_{RRM} = 2000-2200 \text{ V}$$

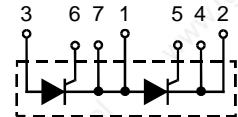
$V_{RSM}$ $V_{DSM}$ V	$V_{RRM}$ $V_{DRM}$ V	Type	
2100	2000	MCC 94-20io1 B	MCD 94-20io1 B
2300	2200	MCC 94-22io1 B	MCD 94-22io1 B

TO-240 AA

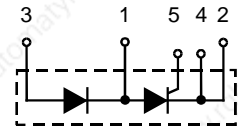


Symbol	Test Conditions	Maximum Ratings	
$I_{TRMS}$	$T_{VJ} = T_{VJM}$	180	A
$I_{TAVM}$	$T_C = 85^\circ\text{C}; 180^\circ \text{ sine}$	104	A
$I_{TSM}$	$T_{VJ} = 45^\circ\text{C};$ $V_R = 0$	$t = 10 \text{ ms (50 Hz)}$	1700 A
		$t = 8.3 \text{ ms (60 Hz)}$	1800 A
	$T_{VJ} = T_{VJM}$ $V_R = 0$	$t = 10 \text{ ms (50 Hz)}$	1540 A
		$t = 8.3 \text{ ms (60 Hz)}$	1640 A
$\int i^2 dt$	$T_{VJ} = 45^\circ\text{C}$ $V_R = 0$	$t = 10 \text{ ms (50 Hz)}$	14450 A <sup>2</sup> s
		$t = 8.3 \text{ ms (60 Hz)}$	13500 A <sup>2</sup> s
	$T_{VJ} = T_{VJM}$ $V_R = 0$	$t = 10 \text{ ms (50 Hz)}$	11850 A <sup>2</sup> s
		$t = 8.3 \text{ ms (60 Hz)}$	11300 A <sup>2</sup> s
$(di/dt)_{cr}$	$T_{VJ} = T_{VJM}$ $f = 50 \text{ Hz}, t_p = 200 \mu\text{s}$ $V_D = 2/3 V_{DRM}$ $I_G = 0.45 \text{ A},$ $di_G/dt = 0.45 \text{ A}/\mu\text{s}$	repetitive, $I_T = 250 \text{ A}$	150 A/ $\mu\text{s}$
		non repetitive, $I_T = I_{TAVM}$	500 A/ $\mu\text{s}$
$(dv/dt)_{cr}$	$T_{VJ} = T_{VJM}; V_{DR} = 2/3 V_{DRM}$ $R_{GK} = \infty; \text{method 1 (linear voltage rise)}$	1000	V/ $\mu\text{s}$
$P_{GM}$	$T_{VJ} = T_{VJM}$ $I_T = I_{TAVM}$	$t_p = 30 \mu\text{s}$	10 W
		$t_p = 300 \mu\text{s}$	5 W
$P_{GAV}$ $V_{RGM}$			0.5 W
			10 V
$T_{VJ}$		-40 ... 125	$^\circ\text{C}$
$T_{VJM}$		125	$^\circ\text{C}$
$T_{stg}$		-40 ... 125	$^\circ\text{C}$
$V_{ISOL}$	50/60 Hz, RMS $t = 1 \text{ min}$ $I_{ISOL} \leq 1 \text{ mA}$ $t = 1 \text{ s}$	3000	V~
		3600	V~
$M_d$	Mounting torque (M5) Terminal connection torque (M5)	2.5-4.0/22-35	Nm/lb.in.
		2.5-4.0/22-35	Nm/lb.in.
Weight	Typical including screws	90	g

MCC



MCD



### Features

- International standard package, JEDEC TO-240 AA
- Direct Copper Bonded  $\text{Al}_2\text{O}_3$  -ceramic base plate
- Planar passivated chips
- Isolation voltage 3600 V~
- UL registered, E 72873
- Gate-cathode twin pins for version 1B

### Applications

- DC motor control
- Softstart AC motor controller
- Light, heat and temperature control

### Advantages

- Space and weight savings
- Simple mounting with two screws
- Improved temperature and power cycling
- Reduced protection circuits

Data according to IEC 60747 and refer to a single thyristor/diode unless otherwise stated. IXYS reserves the right to change limits, test conditions and dimensions

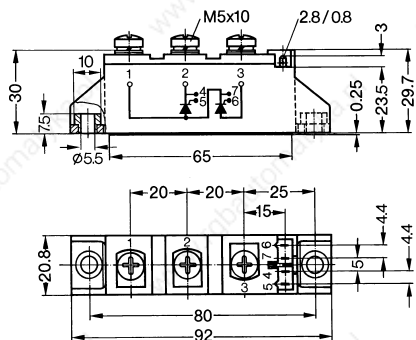
Symbol	Test Conditions	Characteristic Values
$I_{RRM}, I_{DRM}$	$T_{VJ} = T_{VJM}; V_R = V_{RRM}$	15 mA
$V_T$	$I_T = 300 \text{ A}; T_{VJ} = 25^\circ\text{C}$	1.74 V
$V_{T0}$	For power-loss calculations only ( $T_{VJ} = T_{VJM}$ )	0.85 V
$r_T$		3.2 mΩ
$V_{GT}$	$V_D = 6 \text{ V}; T_{VJ} = 25^\circ\text{C}$	1.5 V
	$T_{VJ} = -40^\circ\text{C}$	1.6 V
$I_{GT}$	$V_D = 6 \text{ V}; T_{VJ} = 25^\circ\text{C}$	100 mA
	$T_{VJ} = -40^\circ\text{C}$	200 mA
$V_{GD}$	$T_{VJ} = T_{VJM}; V_D = 2/3 V_{DRM}$	0.25 V
$I_{GD}$	$T_{VJ} = T_{VJM}; V_D = 2/3 V_{DRM}$	10 mA
$I_L$	$T_{VJ} = 25^\circ\text{C}; V_D = 6 \text{ V}; t_p = 30 \mu\text{s}$ $di_G/dt = 0.45 \text{ A}/\mu\text{s}; I_G = 0.45 \text{ A}$	200 mA
$I_H$	$T_{VJ} = 25^\circ\text{C}; V_D = 6 \text{ V}; R_{GK} = \infty$	150 mA
$t_{gd}$	$T_{VJ} = 25^\circ\text{C}; V_D = 1/2 V_{DRM}$ $di_G/dt = 0.45 \text{ A}/\mu\text{s}; I_G = 0.45 \text{ A}$	2 μs
$t_q$	$T_{VJ} = T_{VJM}; V_R = 100 \text{ V}; V_D = 2/3 V_{DRM}; t_p = 200 \mu\text{s}$ $dv/dt = 20 \text{ V}/\mu\text{s}; I_T = 150 \text{ A}; -di/dt = 10 \text{ A}/\mu\text{s}$	typ. 185 μs
$Q_S$	} $T_{VJ} = T_{VJM}$	170 μC
$I_{RM}$		-di/dt = 6 A/μs; $I_T = 50 \text{ A}$
$R_{thJC}$	per thyristor; DC current	0.22 K/W
	per module	0.11 K/W
$R_{thJK}$	per thyristor; DC current	0.42 K/W
	per module	0.21 K/W
$d_s$	Creeping distance on surface	12.7 mm
$d_A$	Creepage distance in air	9.6 mm
$a$	Maximum allowable acceleration	50 m/s <sup>2</sup>

Optional accessories for module-type MCC 94 version 1 B

Keyed gate/cathode twin plugs with wire length = 350 mm, gate = yellow, cathode = red

Type ZY 200L (L = Left for pin pair 4/5) } UL 758, style 1385,  
Type ZY 200R (R = right for pin pair 6/7) } CSA class 5851, guide 460-1-1

### Dimensions in mm (1 mm = 0.0394")



### $R_{thJC}$ for various conduction angles d:

d	$R_{thJC}$ (K/W)
DC	0.22
180°	0.23
120°	0.25
60°	0.27
30°	0.28

### Constants for $Z_{thJC}$ calculation:

i	$R_{thi}$ (K/W)	$t_i$ (s)
1	0.0066	0.0019
2	0.0678	0.0477
3	0.1456	0.344

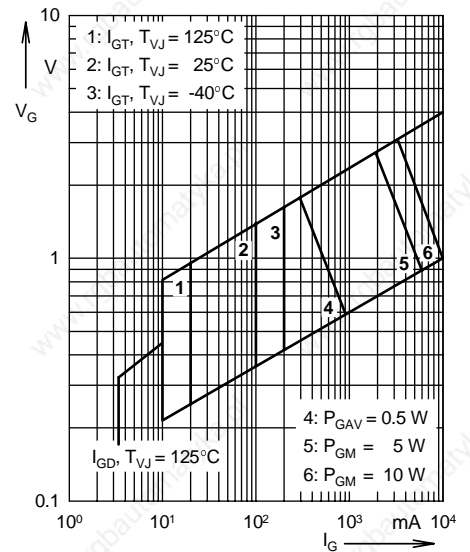


Fig. 1 Gate trigger characteristics

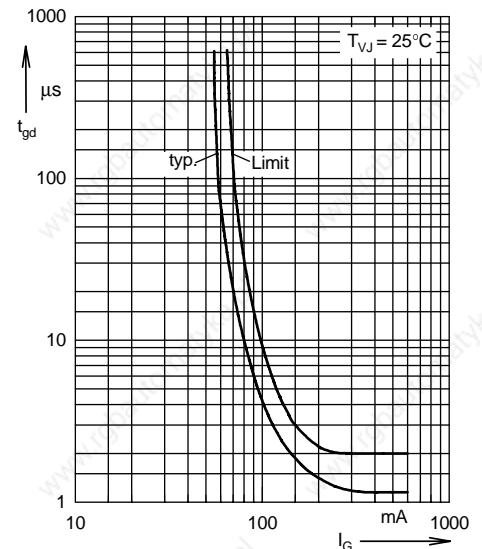


Fig. 2 Gate trigger delay time

### $R_{thJK}$ for various conduction angles d:

d	$R_{thJK}$ (K/W)
DC	0.42
180°	0.43
120°	0.45
60°	0.47
30°	0.48

### Constants for $Z_{thJK}$ calculation:

i	$R_{thi}$ (K/W)	$t_i$ (s)
1	0.0066	0.0019
2	0.0678	0.0477
3	0.1456	0.344
4	0.2	1.32

## Thyristor Modules Thyristor/Diode Modules

$$I_{TRMS} = 2 \times 180 \text{ A}$$

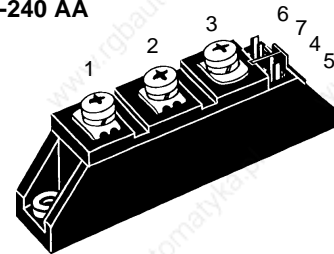
$$I_{TAVM} = 2 \times 116 \text{ A}$$

$$V_{RRM} = 800-1800 \text{ V}$$

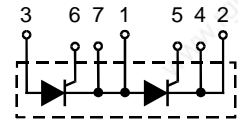
$V_{RSM}$ $V_{DSM}$ V	$V_{RRM}$ $V_{DRM}$ V	Type	
		Version 1	Version 8
900	800	MCC 95-08io1 B	--
1300	1200	MCC 95-12io1 B	MCD 95-12io1 B
1500	1400	MCC 95-14io1 B	--
1700	1600	MCC 95-16io1 B	MCD 95-16io1 B
1900	1800	MCC 95-18io1 B	--
1500	1400	MCC 95-16io8 B	MCD 95-08io8 B
1700	1600	MCC 95-18io8 B	MCD 95-12io8 B
			MCD 95-14io8 B
			MCD 95-16io8 B
			MCD 95-18io8 B

Symbol	Test Conditions	Maximum Ratings
$I_{TRMS}^1$ , $I_{FRMS}$ $I_{TAVM}^2$ , $I_{FAVM}$	$T_{VJ} = T_{VJM}$ $T_C = 85^\circ\text{C}$ ; 180° sine	180 A 116 A
$I_{TSM}^1$ , $I_{FSM}$	$T_{VJ} = 45^\circ\text{C}$ ; $V_R = 0$	$t = 10 \text{ ms}$ (50 Hz), sine 2250 A $t = 8.3 \text{ ms}$ (60 Hz), sine 2400 A
$ji^2dt$	$T_{VJ} = 45^\circ\text{C}$ $V_R = 0$	$t = 10 \text{ ms}$ (50 Hz), sine 25 300 A <sup>2</sup> s $t = 8.3 \text{ ms}$ (60 Hz), sine 23 900 A <sup>2</sup> s
	$T_{VJ} = T_{VJM}$ $V_R = 0$	$t = 10 \text{ ms}$ (50 Hz), sine 20 000 A <sup>2</sup> s $t = 8.3 \text{ ms}$ (60 Hz), sine 19 100 A <sup>2</sup> s
$(di/dt)_{cr}$	$T_{VJ} = T_{VJM}$ $f = 50 \text{ Hz}$ , $t_p = 200 \mu\text{s}$ $V_D = 2/3 V_{DRM}$ $I_G = 0.45 \text{ A}$ $di_G/dt = 0.45 \text{ A}/\mu\text{s}$	repetitive, $I_T = 250 \text{ A}$ 150 A/ $\mu\text{s}$ non repetitive, $I_T = I_{TAVM}$ 500 A/ $\mu\text{s}$
$(dv/dt)_{cr}$	$T_{VJ} = T_{VJM}$ ; $R_{GK} = \infty$ ; method 1 (linear voltage rise)	$V_{DR} = 2/3 V_{DRM}$ 1000 V/ $\mu\text{s}$
$P_{GM}$	$T_{VJ} = T_{VJM}$ $I_T = I_{TAVM}$	$t_p = 30 \mu\text{s}$ 10 W $t_p = 300 \mu\text{s}$ 5 W
$P_{GAV}$		0.5 W
$V_{RGM}$		10 V
$T_{VJ}$		-40...+125 °C
$T_{VJM}$		125 °C
$T_{stg}$		-40...+125 °C
$V_{ISOL}$	50/60 Hz, RMS $I_{ISOL} \leq 1 \text{ mA}$	$t = 1 \text{ min}$ 3000 V~ $t = 1 \text{ s}$ 3600 V~
$M_d$	Mounting torque (M5) Terminal connection torque (M5)	2.5-4.0/22-35 Nm/lb.in. 2.5-4.0/22-35 Nm/lb.in.
Weight	Typical including screws	90 g

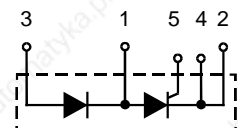
TO-240 AA



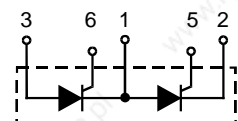
MCC  
Version 1



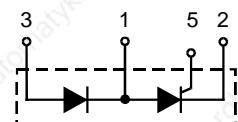
MCD  
Version 1



MCC  
Version 8



MCD  
Version 8



### Features

- International standard package, JEDEC TO-240 AA
- Direct copper bonded  $\text{Al}_2\text{O}_3$  -ceramic base plate
- Planar passivated chips
- Isolation voltage 3600 V~
- UL registered, E 72873
- Gate-cathode twin pins for version 1

### Applications

- DC motor control
- Softstart AC motor controller
- Light, heat and temperature control

### Advantages

- Space and weight savings
- Simple mounting with two screws
- Improved temperature and power cycling
- Reduced protection circuits

Data according to IEC 60747 and refer to a single thyristor/diode unless otherwise stated. IXYS reserves the right to change limits, test conditions and dimensions

Symbol	Test Conditions	Characteristic Values
$I_{RRM}, I_{DRM}$	$T_{VJ} = T_{VJM}; V_R = V_{RRM}; V_D = V_{DRM}$	5 mA
$V_T, V_F$	$I_T, I_F = 300 \text{ A}; T_{VJ} = 25^\circ\text{C}$	1.5 V
$V_{T0}$	For power-loss calculations only ( $T_{VJ} = 125^\circ\text{C}$ )	0.8 V
$r_T$		2.4 mΩ
$V_{GT}$	$V_D = 6 \text{ V}; T_{VJ} = 25^\circ\text{C}$	2.5 V
	$T_{VJ} = -40^\circ\text{C}$	2.6 V
$I_{GT}$	$V_D = 6 \text{ V}; T_{VJ} = 25^\circ\text{C}$	150 mA
	$T_{VJ} = -40^\circ\text{C}$	200 mA
$V_{GD}$	$T_{VJ} = T_{VJM}; V_D = 2/3 V_{DRM}$	0.2 V
$I_{GD}$		10 mA
$I_L$	$T_{VJ} = 25^\circ\text{C}; t_p = 10 \mu\text{s}; V_D = 6 \text{ V}$ $I_G = 0.45 \text{ A}; di_G/dt = 0.45 \text{ A}/\mu\text{s}$	450 mA
$I_H$	$T_{VJ} = 25^\circ\text{C}; V_D = 6 \text{ V}; R_{GK} = \infty$	200 mA
$t_{gd}$	$T_{VJ} = 25^\circ\text{C}; V_D = 1/2 V_{DRM}$ $I_G = 0.45 \text{ A}; di_G/dt = 0.45 \text{ A}/\mu\text{s}$	2 μs
$t_q$	$T_{VJ} = T_{VJM}; I_T = 150 \text{ A}, t_p = 200 \mu\text{s}; -di/dt = 10 \text{ A}/\mu\text{s}$ typ. $V_R = 100 \text{ V}; dv/dt = 20 \text{ V}/\mu\text{s}; V_D = 2/3 V_{DRM}$	185 μs
$Q_S$	$T_{VJ} = T_{VJM}; I_T, I_F = 50 \text{ A}, -di/dt = 6 \text{ A}/\mu\text{s}$	170 μC
$I_{RM}$		45 A
$R_{thJC}$	per thyristor/diode; DC current per module	0.22 K/W
$R_{thJK}$	per thyristor/diode; DC current per module	0.11 K/W 0.42 K/W 0.21 K/W
	other values see Fig. 8/9	
$d_s$	Creepage distance on surface	12.7 mm
$d_A$	Strike distance through air	9.6 mm
$a$	Maximum allowable acceleration	50 m/s <sup>2</sup>

Optional accessories for module-type MCC 95 version 1 B

Keyed gate/cathode twin plugs with wire length = 350 mm, gate = yellow, cathode = red

Type **ZY 200L** (L = Left for pin pair 4/5) } UL 758, style 1385,  
Type **ZY 200R** (R = right for pin pair 6/7) } CSA class 5851, guide 460-1-1

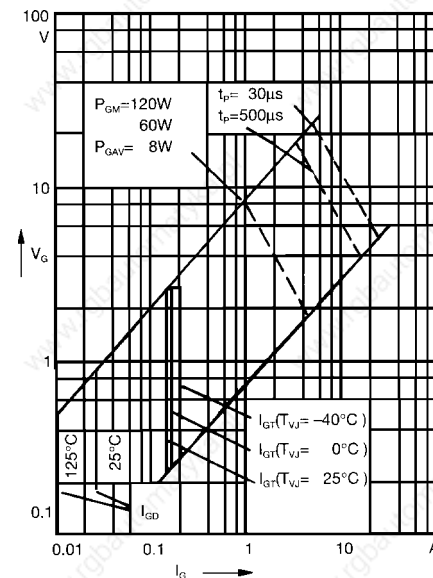


Fig. 1 Gate trigger characteristics

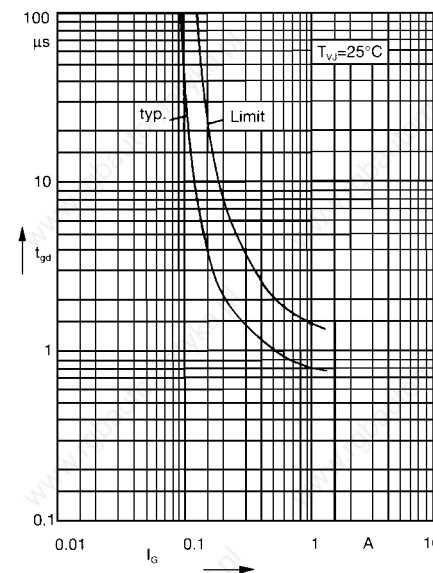
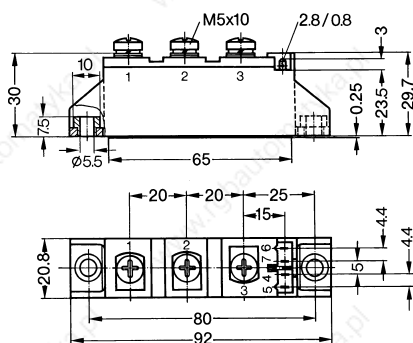


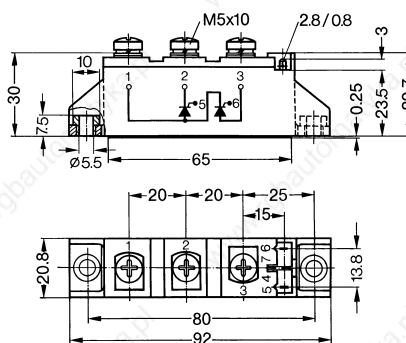
Fig. 2 Gate trigger delay time

Dimensions in mm (1 mm = 0.0394")

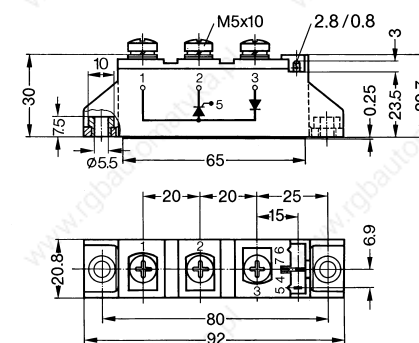
MCC / MCD Version 1 B



MCC Version 8 B



MCD Version 8 B



Version 1 or 8 without B in typ designation = without insert in mounting holes

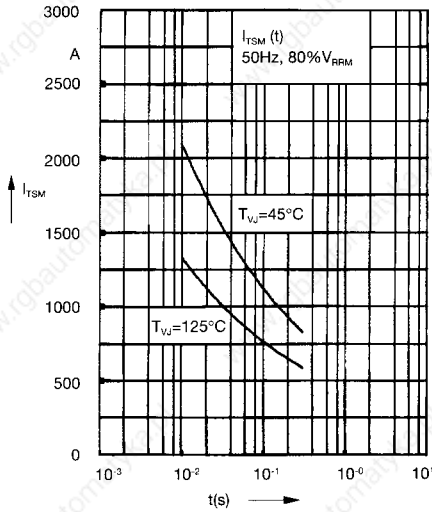


Fig. 3 Surge overload current  
 $I_{TSM}$ ,  $I_{FSM}$ : Crest value, t: duration

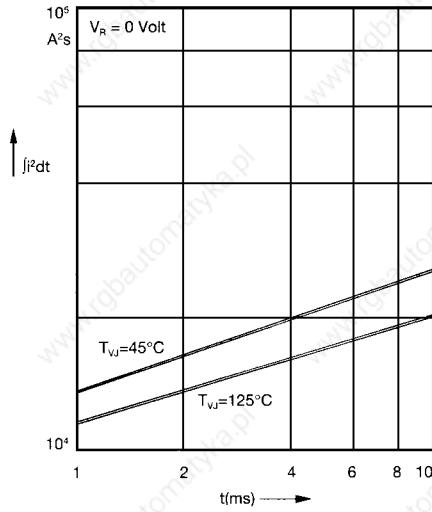


Fig. 4  $j^2dt$  versus time (1-10 ms)

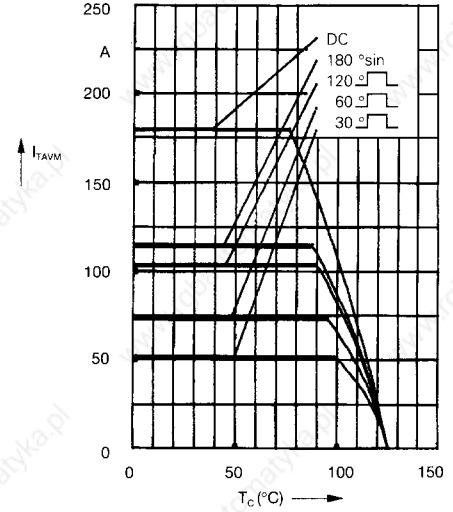


Fig. 4a Maximum forward current at case temperature

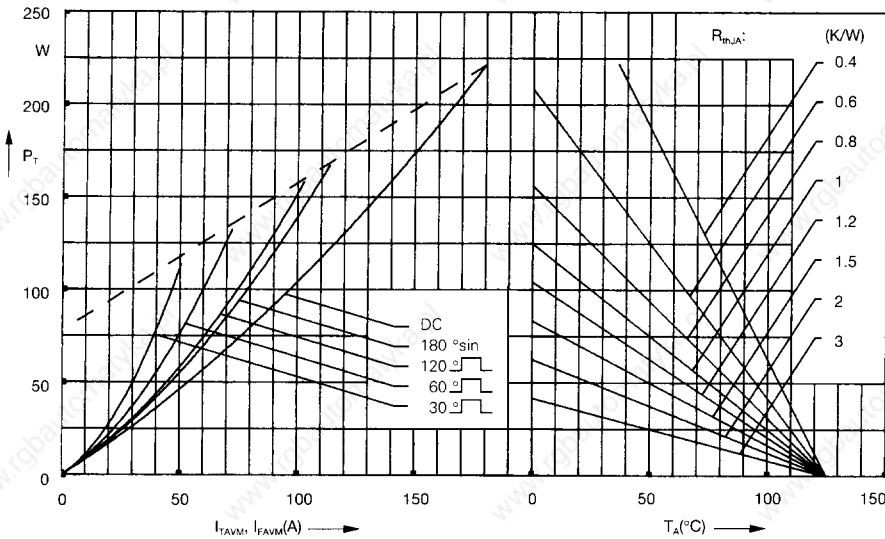


Fig. 5 Power dissipation versus on-state current and ambient temperature (per thyristor or diode)

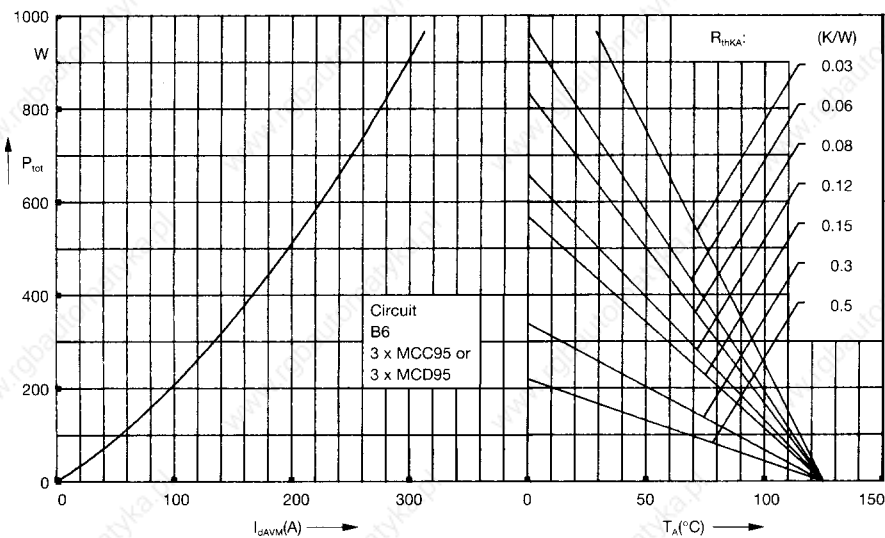


Fig. 6 Three phase rectifier bridge: Power dissipation versus direct output current and ambient temperature



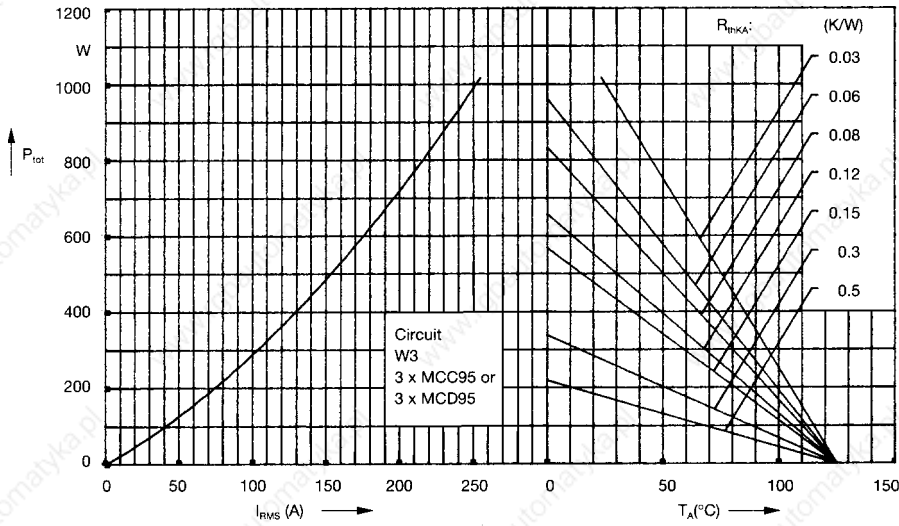


Fig. 7 Three phase AC-controller: Power dissipation versus RMS output current and ambient temperature

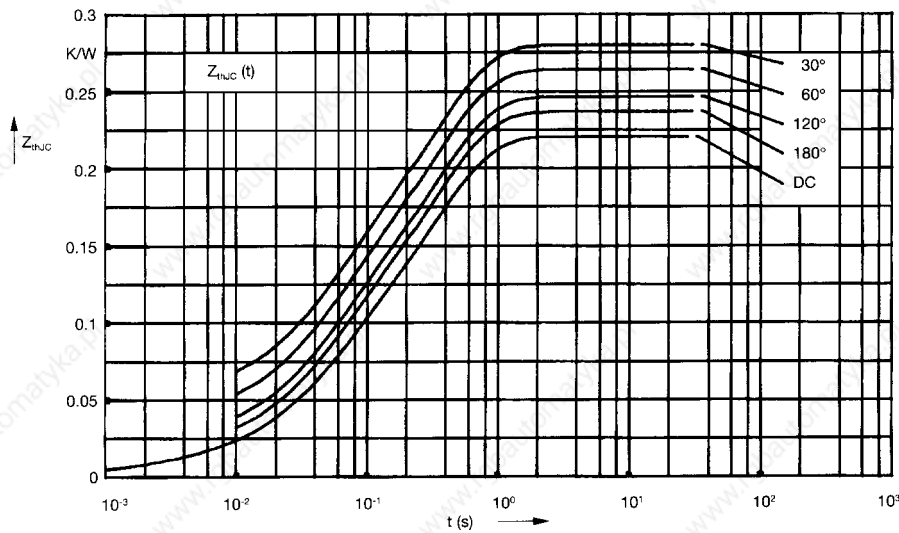


Fig. 8 Transient thermal impedance junction to case (per thyristor or diode)

$R_{thJC}$  for various conduction angles  $d$ :

$d$	$R_{thJC}$ (K/W)
DC	0.22
180°	0.23
120°	0.25
60°	0.27
30°	0.28

Constants for  $Z_{thJC}$  calculation:

$i$	$R_{thi}$ (K/W)	$t_i$ (s)
1	0.0066	0.0019
2	0.0678	0.0477
3	0.1456	0.344

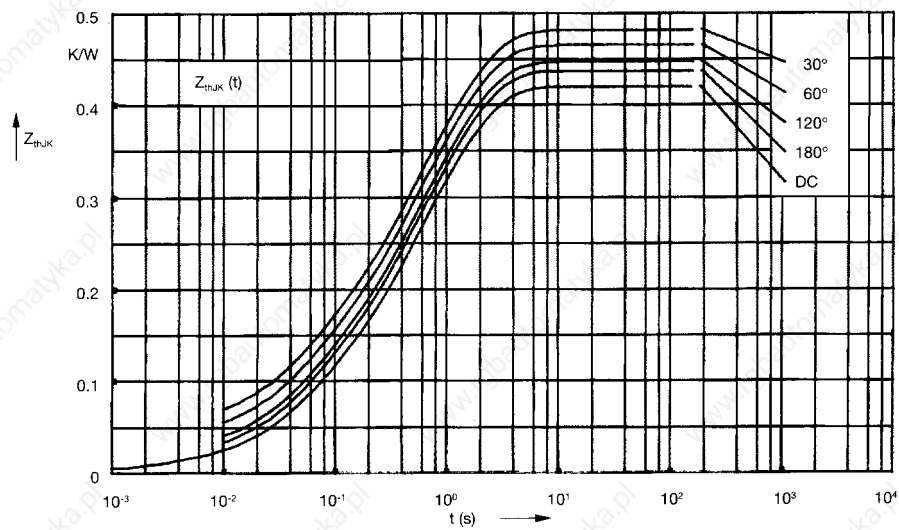


Fig. 9 Transient thermal impedance junction to heatsink (per thyristor or diode)

$R_{thJK}$  for various conduction angles  $d$ :

$d$	$R_{thJK}$ (K/W)
DC	0.42
180°	0.43
120°	0.45
60°	0.47
30°	0.48

Constants for  $Z_{thJK}$  calculation:

$i$	$R_{thi}$ (K/W)	$t_i$ (s)
1	0.0066	0.0019
2	0.0678	0.0477
3	0.1456	0.344
4	0.2	1.32

### Thyristor Module

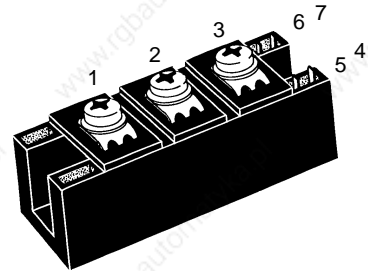
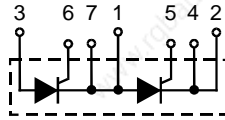
Preliminary data

$$I_{TRMS} = 2 \times 300 \text{ A}$$

$$I_{TAVM} = 2 \times 128 \text{ A}$$

$$V_{RRM, DRM} = 800-1800 \text{ V}$$

$V_{RSM}$	$V_{RRM}$	Type
$V_{DSM}$	$V_{DRM}$	
V	V	
900	800	MCC 122-08io1
1300	1200	MCC 122-12io1
1500	1400	MCC 122-14io1
1700	1600	MCC 122-16io1
1900	1800	MCC 122-18io1



Symbol	Conditions	Maximum Ratings		
$I_{TRMS}$	$T_C = 85^\circ\text{C}; 180^\circ \text{ sine}$	300	A	
$I_{TAVM}$		128	A	
$I_{TSM}$	$T_{VJ} = 45^\circ\text{C}$ $V_R = 0$	$t = 10 \text{ ms (50 Hz), sine}$ $t = 8.3 \text{ ms (60 Hz), sine}$	3600 3850	A A
	$T_{VJ} = T_{VJM}$ $V_R = 0$	$t = 10 \text{ ms (50 Hz), sine}$ $t = 8.3 \text{ ms (60 Hz), sine}$	3200 3420	A A
$I^2dt$	$T_{VJ} = 45^\circ\text{C}$ $V_R = 0$	$t = 10 \text{ ms (50 Hz), sine}$ $t = 8.3 \text{ ms (60 Hz), sine}$	64800 62300	$\text{A}^2\text{s}$ $\text{A}^2\text{s}$
	$T_{VJ} = T_{VJM}$ $V_R = 0$	$t = 10 \text{ ms (50 Hz), sine}$ $t = 8.3 \text{ ms (60 Hz), sine}$	51200 49100	$\text{A}^2\text{s}$ $\text{A}^2\text{s}$
$(di/dt)_{cr}$	$T_{VJ} = T_{VJM}$ $f = 50\text{Hz}, t_p = 200\mu\text{s}$ $V_D = \frac{2}{3} V_{DRM}$ $I_G = 0.5 \text{ A}$ $di_G/dt = 0.5 \text{ A}/\mu\text{s}$	repetitive, $I_T = 500 \text{ A}$	150	$\text{A}/\mu\text{s}$
		non repetitive, $I_T = 500 \text{ A}$	500	$\text{A}/\mu\text{s}$
$(dv/dt)_{cr}$	$T_{VJ} = T_{VJM};$ $R_{GK} = \infty; \text{ method 1 (linear voltage rise)}$	$V_{DR} = \frac{2}{3} V_{DRM}$	1000	$\text{V}/\mu\text{s}$
$P_{GM}$	$T_{VJ} = T_{VJM}$ $I_T = I_{TAVM}$	$t_p = 30 \mu\text{s}$	120	W
		$t_p = 500 \mu\text{s}$	60	W
$P_{GAV}$			8	W
$V_{RGM}$			10	V
$T_{VJ}$			-40...+125	$^\circ\text{C}$
$T_{VJM}$			125	$^\circ\text{C}$
$T_{stg}$			-40...+125	$^\circ\text{C}$
$V_{ISOL}$	50/60 Hz, RMS $I_{ISOL} \leq 1 \text{ mA}$	$t = 1 \text{ min}$	3000	V~
		$t = 1 \text{ s}$	3600	V~
$M_d$	Mounting torque (M6) Terminal connection torque (M6)		2.25-2.75/20-25	Nm/lb.in.
			4.5-5.5/40-48	Nm/lb.in.
Weight	Typical including screws		125	g

#### Features

- International standard package
- Direct copper bonded  $\text{Al}_2\text{O}_3$ -ceramic base plate
- Planar passivated chips
- Isolation voltage 3600 V~
- UL registered, E 72873
- Keyed gate/cathode twin pins

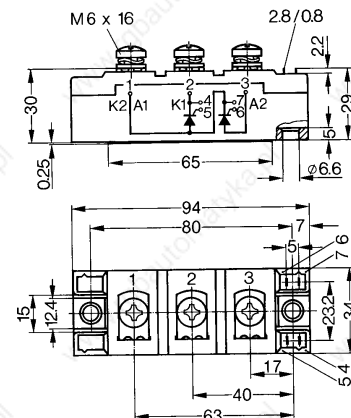
#### Applications

- Motor control
- Power converter
- Heat and temperature control for industrial furnaces and chemical processes
- Lighting control
- Contactless switches

#### Advantages

- Space and weight savings
- Simple mounting
- Improved temperature and power cycling
- Reduced protection circuits

#### Dimensions in mm (1 mm = 0.0394")



Data according to IEC 60747 and refer to a single thyristor/diode unless otherwise stated.

Symbol	Conditions	Characteristic Values	
$I_{RRM}, I_{DRM}$	$T_{VJ} = T_{VJM}; V_R = V_{RRM}; V_D = V_{DRM}$	10	mA
$V_T, V_F$	$I_T, I_F = 120 \text{ A}; T_{VJ} = 25^\circ\text{C}$	1.13	V
$V_{T0}$	$T_{VJ} = 125^\circ\text{C}$ ; For power-loss calculations only	0.85	V
$r_T$	$T_{VJ} = T_{VJM}$	2	m $\Omega$
$V_{GT}$	$V_D = 6 \text{ V}; T_{VJ} = 25^\circ\text{C}$	1.4	V
	$T_{VJ} = -40^\circ\text{C}$	1.6	V
$I_{GT}$	$V_D = 6 \text{ V}; T_{VJ} = 25^\circ\text{C}$	150	mA
	$T_{VJ} = -40^\circ\text{C}$	200	mA
$V_{GD}$	$T_{VJ} = T_{VJM}; V_D = \frac{2}{3} V_{DRM}$	0.2	V
$I_{GD}$		10	mA
$I_L$	$T_{VJ} = 25^\circ\text{C}; t_p = 10 \mu\text{s}, V_D = 6 \text{ V}$ $I_G = 0.45 \text{ A}; di_G/dt = 0.45 \text{ A}/\mu\text{s}$	300	mA
$I_H$	$T_{VJ} = 25^\circ\text{C}; V_D = 6 \text{ V}; R_{GK} = \infty$	200	mA
$t_{gd}$	$T_{VJ} = 25^\circ\text{C}; V_D = \frac{1}{2} V_{DRM}$ $I_G = 0.45 \text{ A}; di_G/dt = 0.45 \text{ A}/\mu\text{s}$	2	$\mu\text{s}$
$t_q$	$T_{VJ} = T_{VJM}; I_T = 120 \text{ A}, t_p = 200 \mu\text{s}; -di/dt = 10 \text{ A}/\mu\text{s typ.}$ $V_R = 100 \text{ V}; dv/dt = 20 \text{ V}/\mu\text{s}; V_D = \frac{2}{3} V_{DRM}$	150	$\mu\text{s}$
$Q_S$	$T_{VJ} = T_{VJM}; I_T, I_F = 200 \text{ A}, -di/dt = 50 \text{ A}/\mu\text{s}$	330	$\mu\text{C}$
$I_{RM}$		180	A
$R_{thJC}$	per thyristor/diode; DC current	0.2	K/W
	per module	0.1	K/W
$R_{thCH}$	per thyristor/diode; DC current	typ. 0.1	K/W
$d_s$	Creepage distance on surface	12.7	mm
$d_A$	Strike distance through air	9.6	mm
$a$	Maximum allowable acceleration	50	m/s <sup>2</sup>

Optional accessories for modules

Keyed gate/cathode twin plugs with wire length = 350 mm, gate = yellow, cathode = red

Type **ZY 180L** (L = Left for pin pair 4/5) } UL Styles 1385,

Type **ZY 180R** (R = right for pin pair 6/7) } CSA Class 5851, File 41234

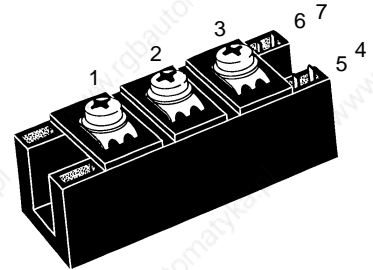
## Thyristor Modules Thyristor/Diode Modules

$$I_{TRMS} = 2 \times 300 \text{ A}$$

$$I_{TAVM} = 2 \times 130 \text{ A}$$

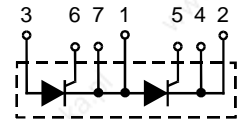
$$V_{RRM} = 800-1800 \text{ V}$$

$V_{RSM}$ $V_{DSM}$ V	$V_{RRM}$ $V_{DRM}$ V	Type	Version 1	Version 1
900	800	MCC 132-08io1	MCC 132-08io1	MCD 132-08io1
1300	1200	MCC 132-12io1	MCC 132-12io1	MCD 132-12io1
1500	1400	MCC 132-14io1	MCC 132-14io1	MCD 132-14io1
1700	1600	MCC 132-16io1	MCC 132-16io1	MCD 132-16io1
1900	1800	MCC 132-18io1	MCC 132-18io1	MCD 132-18io1

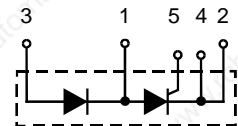


Symbol	Test Conditions	Maximum Ratings
$I_{TRMS}^1, I_{FRMS}$ $I_{TAVM}^2, I_{FAVM}$	$T_{VJ} = T_{VJM}$ $T_C = 85^\circ\text{C}; 180^\circ \text{ sine}$	300 A 130 A
$I_{TSM}^3, I_{FSM}$	$T_{VJ} = 45^\circ\text{C};$ $V_R = 0$	$t = 10 \text{ ms (50 Hz), sine}$ 4750 A $t = 8.3 \text{ ms (60 Hz), sine}$ 5080 A
	$T_{VJ} = T_{VJM}$ $V_R = 0$	$t = 10 \text{ ms (50 Hz), sine}$ 4230 A $t = 8.3 \text{ ms (60 Hz), sine}$ 4530 A
$ji^2dt$	$T_{VJ} = 45^\circ\text{C}$ $V_R = 0$	$t = 10 \text{ ms (50 Hz), sine}$ 113 000 A <sup>2</sup> s $t = 8.3 \text{ ms (60 Hz), sine}$ 108 000 A <sup>2</sup> s
	$T_{VJ} = T_{VJM}$ $V_R = 0$	$t = 10 \text{ ms (50 Hz), sine}$ 89 500 A <sup>2</sup> s $t = 8.3 \text{ ms (60 Hz), sine}$ 86 200 A <sup>2</sup> s
$(di/dt)_{cr}$	$T_{VJ} = T_{VJM}$ $f = 50 \text{ Hz}, t_p = 200 \mu\text{s}$ $V_D = 2/3 V_{DRM}$ $I_G = 0.5 \text{ A}$ $di_G/dt = 0.5 \text{ A}/\mu\text{s}$	repetitive, $I_T = 500 \text{ A}$ 150 A/ $\mu\text{s}$ non repetitive, $I_T = 500 \text{ A}$ 500 A/ $\mu\text{s}$
$(dv/dt)_{cr}$	$T_{VJ} = T_{VJM};$ $R_{GK} = \infty;$ method 1 (linear voltage rise)	$V_{DR} = 2/3 V_{DRM}$ 1000 V/ $\mu\text{s}$
$P_{GM}$	$T_{VJ} = T_{VJM}$ $I_T = I_{TAVM}$	$t_p = 30 \mu\text{s}$ 120 W $t_p = 500 \mu\text{s}$ 60 W
$P_{GAV}$		8 W
$V_{RGM}$		10 V
$T_{VJ}$		-40...+125 °C
$T_{VJM}$		125 °C
$T_{stg}$		-40...+125 °C
$V_{ISOL}$	50/60 Hz, RMS $I_{ISOL} \leq 1 \text{ mA}$	$t = 1 \text{ min}$ 3000 V~ $t = 1 \text{ s}$ 3600 V~
$M_d$	Mounting torque (M6) Terminal connection torque (M6)	2.25-2.75/20-25 Nm/lb.in. 4.5-5.5/40-48 Nm/lb.in.
Weight	Typical including screws	125 g

MCC



MCD



### Features

- International standard package
- Direct copper bonded Al<sub>2</sub>O<sub>3</sub> -ceramic base plate
- Planar passivated chips
- Isolation voltage 3600 V~
- UL registered, E 72873
- Keyed gate/cathode twin pins

### Applications

- Motor control
- Power converter
- Heat and temperature control for industrial furnaces and chemical processes
- Lighting control
- Contactless switches

### Advantages

- Space and weight savings
- Simple mounting
- Improved temperature and power cycling
- Reduced protection circuits

Data according to IEC 60747 and refer to a single thyristor/diode unless otherwise stated.  
IXYS reserves the right to change limits, test conditions and dimensions

Symbol	Test Conditions	Characteristic Values
$I_{RRM}, I_{DRM}$	$T_{VJ} = T_{VJM}; V_R = V_{RRM}; V_D = V_{DRM}$	10 mA
$V_T, V_F$	$I_T, I_F = 300 \text{ A}; T_{VJ} = 25^\circ\text{C}$	1.36 V
$V_{T0}$	For power-loss calculations only ( $T_{VJ} = 125^\circ\text{C}$ )	0.8 V
$r_T$		1.5 mΩ
$V_{GT}$	$V_D = 6 \text{ V}; T_{VJ} = 25^\circ\text{C}$	2.5 V
	$T_{VJ} = -40^\circ\text{C}$	2.6 V
$I_{GT}$	$V_D = 6 \text{ V}; T_{VJ} = 25^\circ\text{C}$	150 mA
	$T_{VJ} = -40^\circ\text{C}$	200 mA
$V_{GD}$	$T_{VJ} = T_{VJM}; V_D = 2/3 V_{DRM}$	0.2 V
$I_{GD}$		10 mA
$I_L$	$T_{VJ} = 25^\circ\text{C}; t_p = 30 \mu\text{s}; V_D = 6 \text{ V}$ $I_G = 0.5 \text{ A}; di_G/dt = 0.5 \text{ A}/\mu\text{s}$	300 mA
$I_H$	$T_{VJ} = 25^\circ\text{C}; V_D = 6 \text{ V}; R_{GK} = \infty$	200 mA
$t_{gd}$	$T_{VJ} = 25^\circ\text{C}; V_D = 1/2 V_{DRM}$ $I_G = 0.5 \text{ A}; di_G/dt = 0.5 \text{ A}/\mu\text{s}$	2 μs
$t_q$	$T_{VJ} = T_{VJM}; I_T = 160 \text{ A}, t_p = 200 \mu\text{s}; -di/dt = 10 \text{ A}/\mu\text{s}$ typ. $V_R = 100 \text{ V}; dv/dt = 20 \text{ V}/\mu\text{s}; V_D = 2/3 V_{DRM}$	150 μs
$Q_S$	$T_{VJ} = T_{VJM}; I_T, I_F = 300 \text{ A}, -di/dt = 50 \text{ A}/\mu\text{s}$	550 μC
$I_{RM}$		235 A
$R_{thJC}$	per thyristor/diode; DC current per module	0.23 K/W
$R_{thJK}$	per thyristor/diode; DC current per module	0.115 K/W
	other values see Fig. 8/9	0.33 K/W
		0.165 K/W
$d_s$	Creepage distance on surface	12.7 mm
$d_A$	Strike distance through air	9.6 mm
$a$	Maximum allowable acceleration	50 m/s <sup>2</sup>

### Optional accessories for modules

Keyed gate/cathode twin plugs with wire length = 350 mm, gate = yellow, cathode = red  
 Type **ZY 180L** (L = Left for pin pair 4/5) } UL 758, style 1385,  
 Type **ZY 180R** (R = right for pin pair 6/7) } CSA class 5851, guide 460-1-1

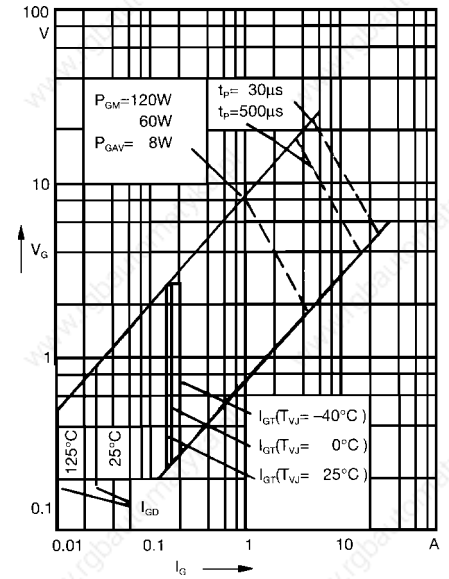


Fig. 1 Gate trigger characteristics

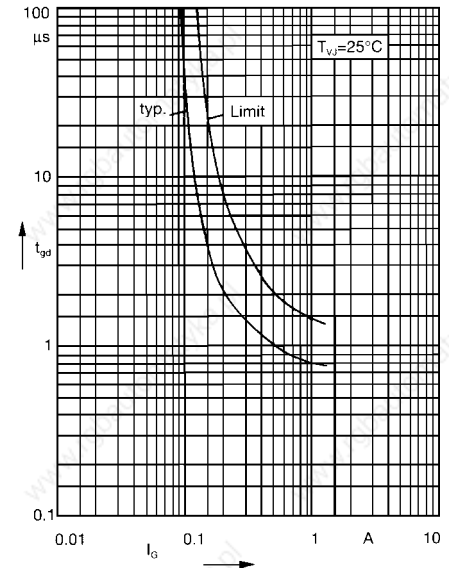
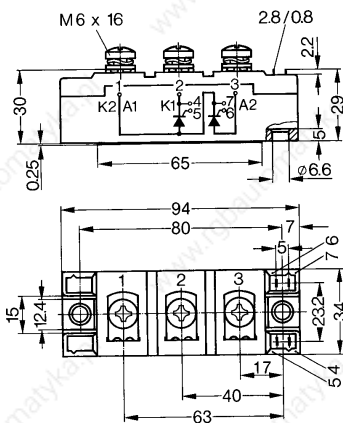


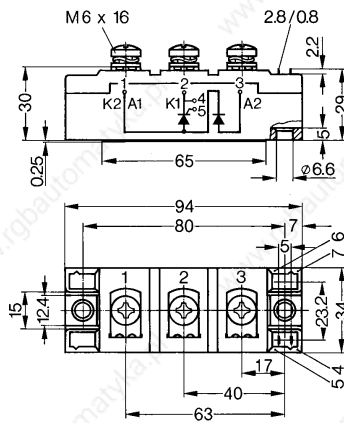
Fig. 2 Gate trigger delay time

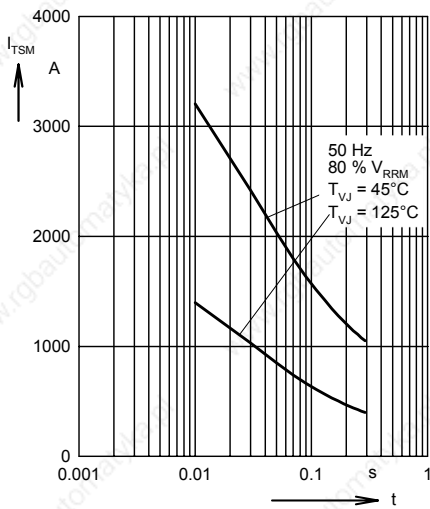
### Dimensions in mm (1 mm = 0.0394")

#### MCC

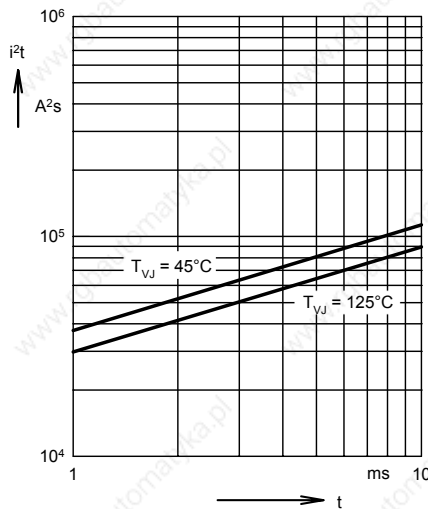


#### MCD

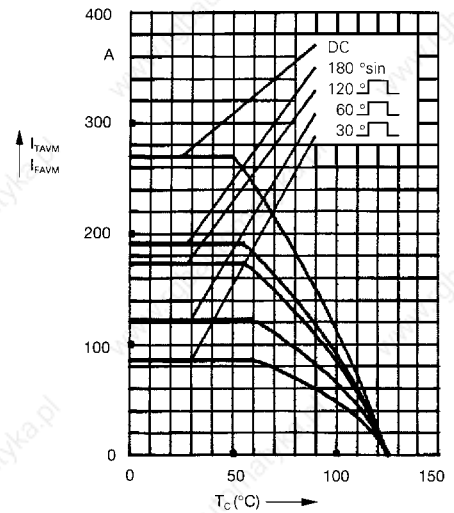




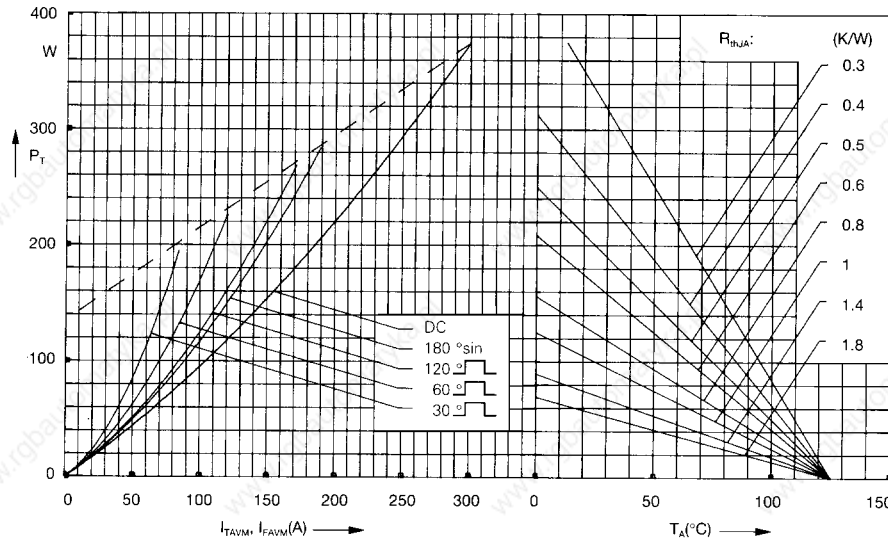
**Fig. 3 Surge overload current**  
 $I_{TSM}$ ,  $I_{FSM}$ : Crest value, t: duration



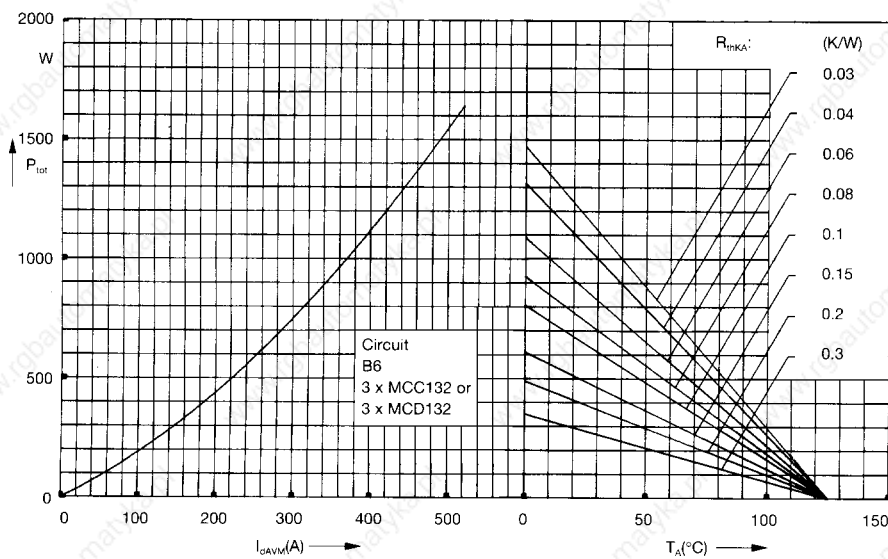
**Fig. 4  $i^2t$  versus time (1-10 ms)**



**Fig. 4a Maximum forward current at case temperature**



**Fig. 5 Power dissipation versus on-state current and ambient temperature (per thyristor or diode)**



**Fig. 6 Three phase rectifier bridge: Power dissipation versus direct output current and ambient temperature**

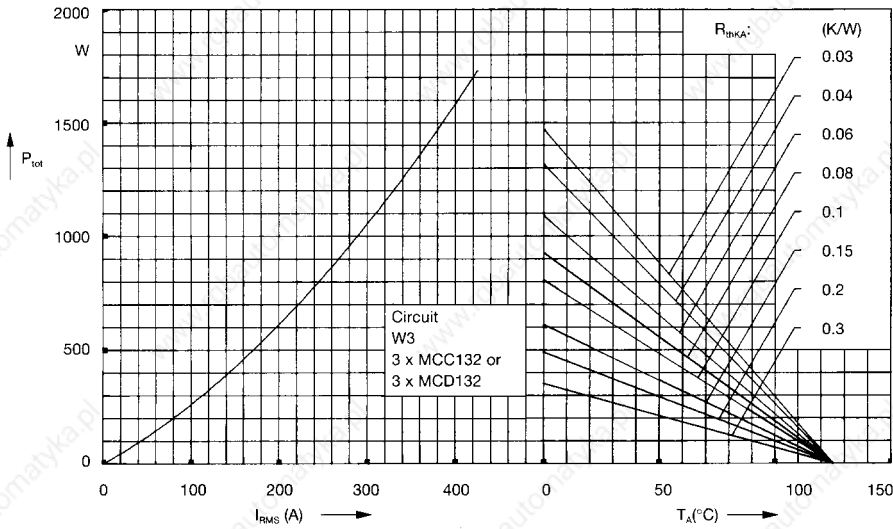


Fig. 7 Three phase AC-controller: Power dissipation versus RMS output current and ambient temperature

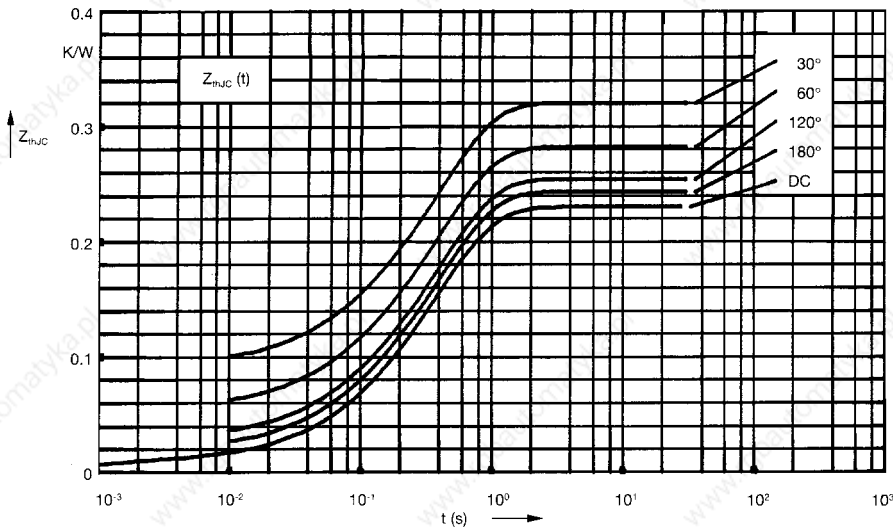


Fig. 8 Transient thermal impedance junction to case (per thyristor or diode)

$R_{thJC}$  for various conduction angles d:

d	$R_{thJC}$ (K/W)
DC	0.230
180°	0.244
120°	0.255
60°	0.283
30°	0.321

Constants for  $Z_{thJC}$  calculation:

i	$R_{thi}$ (K/W)	$t_i$ (s)
1	0.0095	0.001
2	0.0175	0.065
3	0.203	0.4

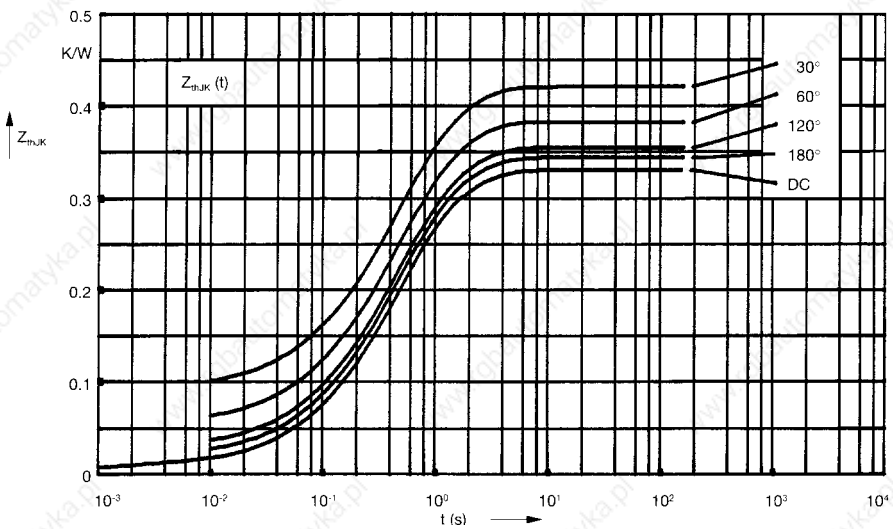


Fig. 9 Transient thermal impedance junction to heatsink (per thyristor or diode)

$R_{thJK}$  for various conduction angles d:

d	$R_{thJK}$ (K/W)
DC	0.330
180°	0.344
120°	0.355
60°	0.383
30°	0.421

Constants for  $Z_{thJK}$  calculation:

i	$R_{thi}$ (K/W)	$t_i$ (s)
1	0.0095	0.001
2	0.0175	0.065
3	0.203	0.4
4	0.1	1.29

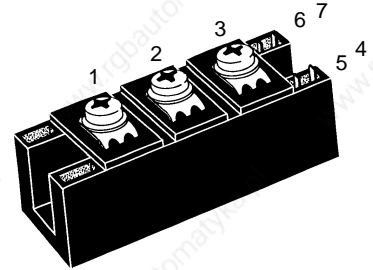
## High Voltage Thyristor Module High Voltage High Voltage

$$I_{TRMS} = 2x 300 A$$

$$I_{TAVM} = 2x 165 A$$

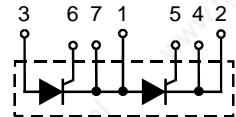
$$V_{RRM} = 2000-2200 V$$

$V_{RSM}$ $V_{DSM}$ V	$V_{RRM}$ $V_{DRM}$ V	Type	
2100 2300	2000 2200	MCC 161-20io1 MCC 161-22io1	MCD 161-20io1 MCD 161-22io1

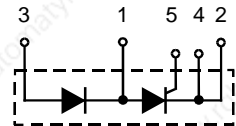


Symbol	Test Conditions	Maximum Ratings		
$I_{TRMS}$ $I_{TAVM}$	$T_{VJ} = T_{VJM}$ $T_C = 85^{\circ}C$ ; 180° sine	300 165	A A	
$I_{TSM}$	$T_{VJ} = 45^{\circ}C$ ; $V_R = 0$	$t = 10$ ms (50 Hz) $t = 8.3$ ms (60 Hz)	A A	
	$T_{VJ} = T_{VJM}$ $V_R = 0$	$t = 10$ ms (50 Hz) $t = 8.3$ ms (60 Hz)	A A	
$\int i^2 dt$	$T_{VJ} = 45^{\circ}C$ $V_R = 0$	$t = 10$ ms (50 Hz) $t = 8.3$ ms (60 Hz)	A <sup>2</sup> s A <sup>2</sup> s	
	$T_{VJ} = T_{VJM}$ $V_R = 0$	$t = 10$ ms (50 Hz) $t = 8.3$ ms (60 Hz)	A <sup>2</sup> s A <sup>2</sup> s	
$(di/dt)_{cr}$	$T_{VJ} = T_{VJM}$ $f = 50$ Hz, $t_p = 200$ $\mu$ s $V_D = 2/3 V_{DRM}$ $I_G = 0.5$ A, non repetitive, $I_T = I_{TAVM}$ $di_G/dt = 0.5$ A/ $\mu$ s	repetitive, $I_T = 500$ A 500	A/ $\mu$ s A/ $\mu$ s	
	$T_{VJ} = T_{VJM}$ ; $V_{DR} = 2/3 V_{DRM}$ $R_{GK} = \infty$ ; method 1 (linear voltage rise)	1000	V/ $\mu$ s	
$P_{GM}$	$T_{VJ} = T_{VJM}$ $I_T = I_{TAVM}$	$t_p = 30$ $\mu$ s $t_p = 500$ $\mu$ s	W W	
$P_{GAV}$ $V_{RGM}$		8 10	W V	
$T_{VJ}$ $T_{VJM}$ $T_{stg}$		-40 ... 125 125 -40 ... 125	$^{\circ}C$ $^{\circ}C$ $^{\circ}C$	
$V_{ISOL}$	50/60 Hz, RMS $I_{ISOL} \leq 1$ mA	$t = 1$ min $t = 1$ s	3000 3600	V~ V~
	$M_d$	Mounting torque (M6) Terminal connection torque (M6)	2.25-2.75/20-25 4.5-5.5/40-48	Nm/lb.in. Nm/lb.in.
Weight	Typical including screws	125	g	

MCC



MCD



### Features

- International standard package
- Direct Copper Bonded  $Al_2O_3$  -ceramic base plate
- Planar passivated chips
- Isolation voltage 3600 V~
- UL registered, E 72873
- Keyed gate/cathode twin pins

### Applications

- Motor control
- Power converter
- Heat and temperature control for industrial furnaces and chemical processes
- Lighting control
- Contactless switches

### Advantages

- Space and weight savings
- Simple mounting
- Improved temperature and power cycling
- Reduced protection circuits

Data according to IEC 60747 and refer to a single thyristor/diode unless otherwise stated.  
IXYS reserves the right to change limits, test conditions and dimensions



Symbol	Test Conditions	Characteristic Values	
$I_{RRM}, I_{DRM}$	$T_{VJ} = T_{VJM}; V_R = V_{RRM}$	40	mA
$V_T$	$I_T = 300 \text{ A}; T_{VJ} = 25^\circ\text{C}$	1.36	V
$V_{T0}$	For power-loss calculations only ( $T_{VJ} = T_{VJM}$ )	0.8	V
$r_T$		1.6	mΩ
$V_{GT}$	$V_D = 6 \text{ V}; T_{VJ} = 25^\circ\text{C}$	2	V
	$T_{VJ} = -40^\circ\text{C}$	2.6	V
$I_{GT}$	$V_D = 6 \text{ V}; T_{VJ} = 25^\circ\text{C}$	150	mA
	$T_{VJ} = -40^\circ\text{C}$	200	mA
$V_{GD}$	$T_{VJ} = T_{VJM}; V_D = 2/3 V_{DRM}$	0.25	V
$I_{GD}$	$T_{VJ} = T_{VJM}; V_D = 2/3 V_{DRM}$	10	mA
$I_L$	$T_{VJ} = 25^\circ\text{C}; V_D = 6 \text{ V}; t_p = 30 \mu\text{s}$ $di_G/dt = 0.45 \text{ A}/\mu\text{s}; I_G = 0.45 \text{ A}$	200	mA
$I_H$	$T_{VJ} = 25^\circ\text{C}; V_D = 6 \text{ V}; R_{GK} = \infty$	150	mA
$t_{gd}$	$T_{VJ} = 25^\circ\text{C}; V_D = 1/2 V_{DRM}$ $di_G/dt = 0.5 \text{ A}/\mu\text{s}; I_G = 0.5 \text{ A}$	2	μs
$t_q$	$T_{VJ} = T_{VJM}; V_R = 100 \text{ V}; V_D = 2/3 V_{DRM}; t_p = 200 \mu\text{s}$ typ. 150 $dv/dt = 20 \text{ V}/\mu\text{s}; I_T = 160 \text{ A}; -di/dt = 10 \text{ A}/\mu\text{s}$	150	μs
$Q_S$	$T_{VJ} = T_{VJM}$	550	μC
$I_{RM}$		235	A
$R_{thJC}$	per thyristor; DC current	0.155	K/W
	per module	0.078	K/W
$R_{thJK}$	per thyristor; DC current	0.225	K/W
	per module	0.113	K/W
$d_s$	Creeping distance on surface	12.7	mm
$d_A$	Creepage distance in air	9.6	mm
$a$	Maximum allowable acceleration	50	m/s <sup>2</sup>

Optional accessories for modules

Keyed gate/cathode twin plugs with wire length = 350 mm, gate = yellow, cathode = red  
 Type **ZY 180L** (L = Left for pin pair 4/5) } UL 758, style 1385,  
 Type **ZY 180R** (R = right for pin pair 6/7) } CSA class 5851, guide 460-1-1

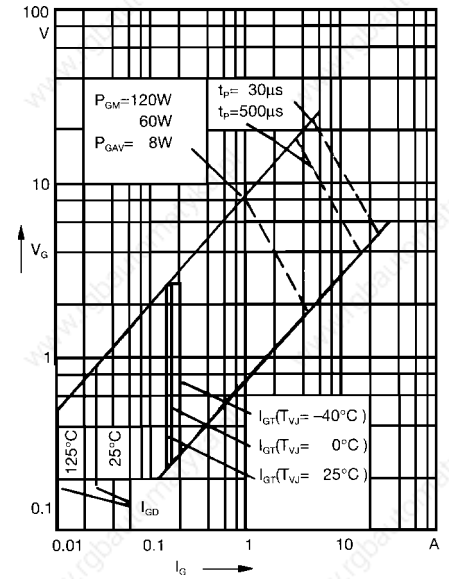


Fig. 1 Gate trigger characteristics

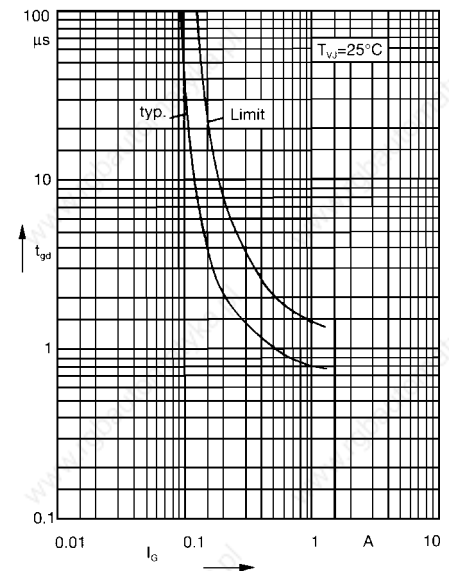
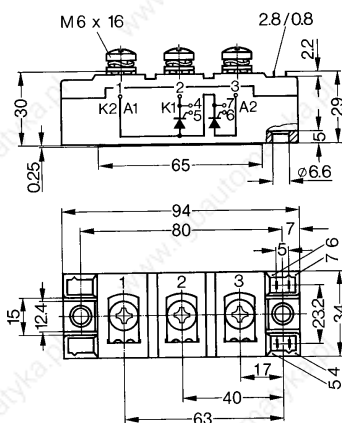


Fig. 2 Gate trigger delay time

### Dimensions in mm (1 mm = 0.0394")



### R<sub>thJC</sub> for various conduction angles d:

d	R <sub>thJC</sub> (K/W)
DC	0.155
180°	0.167
120°	0.175
60°	0.197
30°	0.226

### Constants for Z<sub>thJC</sub> calculation:

i	R <sub>thi</sub> (K/W)	t <sub>i</sub> (s)
1	0.0072	0.001
2	0.0188	0.08
3	0.129	0.2

### R<sub>thJK</sub> for various conduction angles d:

d	R <sub>thJK</sub> (K/W)
DC	0.225
180°	0.237
120°	0.245
60°	0.262
30°	0.296

### Constants for Z<sub>thJK</sub> calculation:

i	R <sub>thi</sub> (K/W)	t <sub>i</sub> (s)
1	0.0072	0.001
2	0.0188	0.08
3	0.129	0.2
4	0.07	1.0

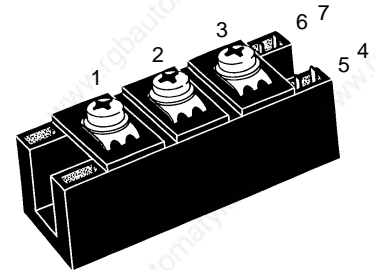
## Thyristor Modules Thyristor/Diode Modules

$$I_{TRMS} = 2x 300 A$$

$$I_{TAVM} = 2x 190 A$$

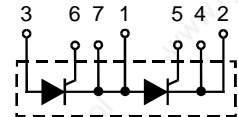
$$V_{RRM} = 800-1800 V$$

$V_{RSM}$	$V_{RRM}$	Type	
$V_{DSM}$	$V_{DRM}$		
V	V	Version 1	Version 1
900	800	MCC 162-08io1	MCD 162-08io1
1300	1200	MCC 162-12io1	MCD 162-12io1
1500	1400	MCC 162-14io1	MCD 162-14io1
1700	1600	MCC 162-16io1	MCD 162-16io1
1900	1800	MCC 162-18io1	MCD 162-18io1

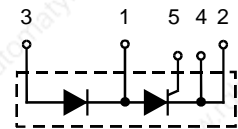


Symbol	Test Conditions	Maximum Ratings	
$I_{TRMS}^*$ , $I_{FRMS}$ $I_{TAVM}^*$ , $I_{FAVM}$	$T_{VJ} = T_{VJM}$ $T_C = 80^\circ C$ ; 180° sine $T_C = 85^\circ C$ ; 180° sine	300 190 181	A A A
$I_{TSM}^*$ , $I_{FSM}$	$T_{VJ} = 45^\circ C$ ; $V_R = 0$	$t = 10$ ms (50 Hz), sine $t = 8.3$ ms (60 Hz), sine	6000 6400 A A
	$T_{VJ} = T_{VJM}$ $V_R = 0$	$t = 10$ ms (50 Hz), sine $t = 8.3$ ms (60 Hz), sine	5250 5600 A A
$\int i^2 dt$	$T_{VJ} = 45^\circ C$ $V_R = 0$	$t = 10$ ms (50 Hz), sine $t = 8.3$ ms (60 Hz), sine	180 000 170 000 A <sup>2</sup> s A <sup>2</sup> s
	$T_{VJ} = T_{VJM}$ $V_R = 0$	$t = 10$ ms (50 Hz), sine $t = 8.3$ ms (60 Hz), sine	137 000 128 000 A <sup>2</sup> s A <sup>2</sup> s
$(di/dt)_{cr}$	$T_{VJ} = T_{VJM}$ $f = 50$ Hz, $t_p = 200$ $\mu$ s $V_D = 2/3 V_{DRM}$ $I_G = 0.5$ A $di_G/dt = 0.5$ A/ $\mu$ s	repetitive, $I_T = 500$ A non repetitive, $I_T = 500$ A	150 500 A/ $\mu$ s A/ $\mu$ s
$(dv/dt)_{cr}$	$T_{VJ} = T_{VJM}$ ; $R_{GK} = \infty$ ; method 1 (linear voltage rise)	$V_{DR} = 2/3 V_{DRM}$	1000 V/ $\mu$ s
$P_{GM}$	$T_{VJ} = T_{VJM}$ $I_T = I_{TAVM}$	$t_p = 30$ $\mu$ s $t_p = 500$ $\mu$ s	120 60 W W
$P_{GAV}$			8 W
$V_{RGM}$			10 V
$T_{VJ}$			-40...+125 $^\circ C$
$T_{VJM}$			125 $^\circ C$
$T_{sig}$			-40...+125 $^\circ C$
$V_{ISOL}$	50/60 Hz, RMS $I_{ISOL} \leq 1$ mA	$t = 1$ min $t = 1$ s	3000 3600 V~ V~
$M_d$	Mounting torque (M6) Terminal connection torque (M6)	2.25-2.75/20-25 4.5-5.5/40-48	Nm/lb.in. Nm/lb.in.
Weight	Typical including screws		125 g

MCC



MCD



### Features

- International standard package
- Direct copper bonded Al<sub>2</sub>O<sub>3</sub> -ceramic base plate
- Planar passivated chips
- Isolation voltage 3600 V~
- UL registered, E 72873
- Keyed gate/cathode twin pins

### Applications

- Motor control
- Power converter
- Heat and temperature control for industrial furnaces and chemical processes
- Lighting control
- Contactless switches

### Advantages

- Space and weight savings
- Simple mounting
- Improved temperature and power cycling
- Reduced protection circuits

Data according to IEC 60747 and refer to a single thyristor/diode unless otherwise stated.  
IXYS reserves the right to change limits, test conditions and dimensions

Symbol	Test Conditions	Characteristic Values
$I_{RRM}, I_{DRM}$	$T_{VJ} = T_{VJM}; V_R = V_{RRM}; V_D = V_{DRM}$	10 mA
$V_T, V_F$	$I_T, I_F = 300 \text{ A}; T_{VJ} = 25^\circ\text{C}$	1.25 V
$V_{T0}$	For power-loss calculations only ( $T_{VJ} = 125^\circ\text{C}$ )	0.88 V
$r_T$		1.15 mΩ
$V_{GT}$	$V_D = 6 \text{ V}; T_{VJ} = 25^\circ\text{C}$	2.5 V
	$T_{VJ} = -40^\circ\text{C}$	2.6 V
$I_{GT}$	$V_D = 6 \text{ V}; T_{VJ} = 25^\circ\text{C}$	150 mA
	$T_{VJ} = -40^\circ\text{C}$	200 mA
$V_{GD}$	$T_{VJ} = T_{VJM}; V_D = 2/3 V_{DRM}$	0.2 V
$I_{GD}$		10 mA
$I_L$	$T_{VJ} = 25^\circ\text{C}; t_p = 30 \mu\text{s}; V_D = 6 \text{ V}$ $I_G = 0.5 \text{ A}; di_g/dt = 0.5 \text{ A}/\mu\text{s}$	300 mA
$I_H$	$T_{VJ} = 25^\circ\text{C}; V_D = 6 \text{ V}; R_{GK} = \infty$	200 mA
$t_{gd}$	$T_{VJ} = 25^\circ\text{C}; V_D = 1/2 V_{DRM}$ $I_G = 0.5 \text{ A}; di_g/dt = 0.5 \text{ A}/\mu\text{s}$	2 μs
$t_q$	$T_{VJ} = T_{VJM}; I_T = 300 \text{ A}, t_p = 200 \mu\text{s}; -di/dt = 10 \text{ A}/\mu\text{s}$ typ. $V_R = 100 \text{ V}; dv/dt = 20 \text{ V}/\mu\text{s}; V_D = 2/3 V_{DRM}$	150 μs
$Q_S$	$T_{VJ} = T_{VJM}; I_T, I_F = 300 \text{ A}, -di/dt = 50 \text{ A}/\mu\text{s}$	550 μC
$I_{RM}$		235 A
$R_{thJC}$	per thyristor/diode; DC current per module	0.155 K/W
$R_{thJK}$	per thyristor/diode; DC current per module	0.0775 K/W
	other values see Fig. 8/9	0.225 K/W
		0.1125 K/W
$d_s$	Creepage distance on surface	12.7 mm
$d_A$	Strike distance through air	9.6 mm
$a$	Maximum allowable acceleration	50 m/s <sup>2</sup>

Optional accessories for modules

Keyed gate/cathode twin plugs with wire length = 350 mm, gate = yellow, cathode = red  
 Type **ZY 180L** (L = Left for pin pair 4/5) } UL 758, style 1385,  
 Type **ZY 180R** (R = right for pin pair 6/7) } CSA class 5851, guide 460-1-1

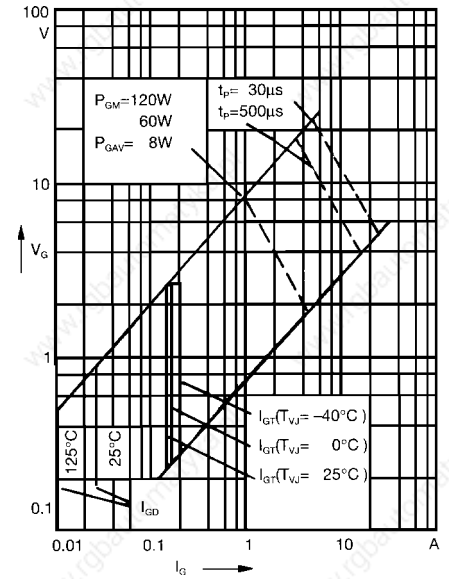


Fig. 1 Gate trigger characteristics

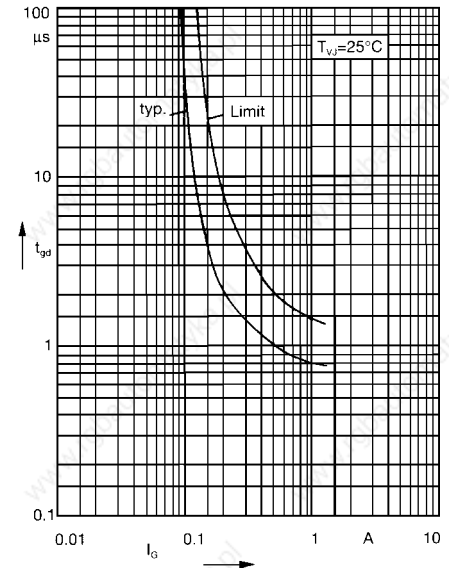
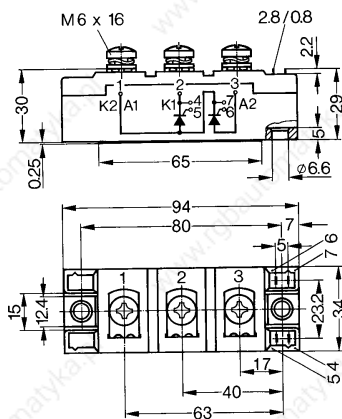


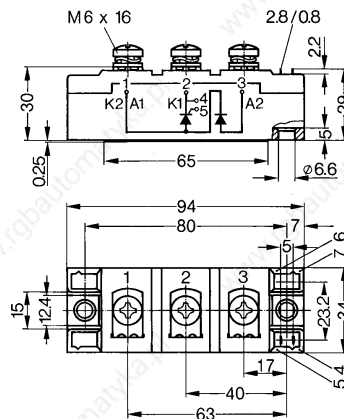
Fig. 2 Gate trigger delay time

Dimensions in mm (1 mm = 0.0394")

MCC Version 1



MCD Version 1



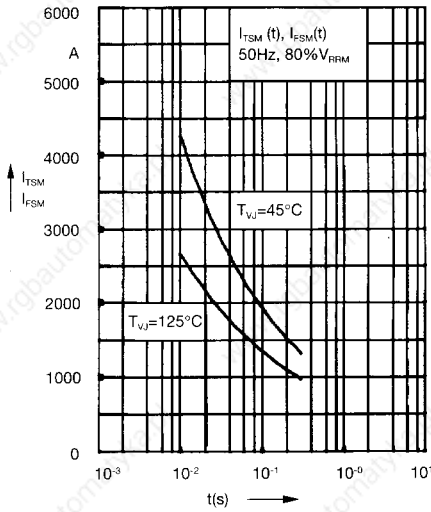


Fig. 3 Surge overload current  
 $I_{TSM}$ ,  $I_{FSM}$ : Crest value, t: duration

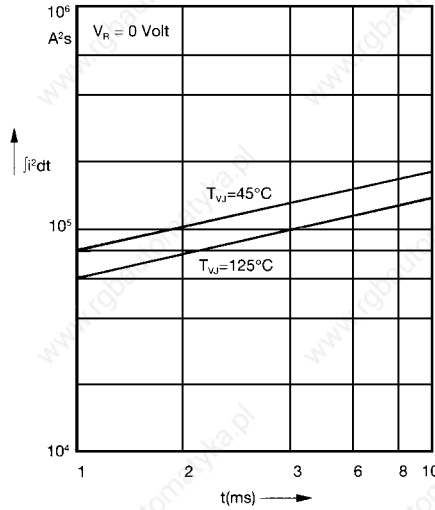


Fig. 4  $\int j^2 dt$  versus time (1-10 ms)

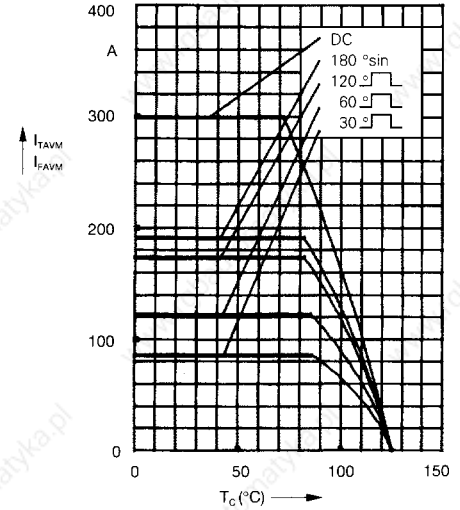


Fig. 4a Maximum forward current at case temperature

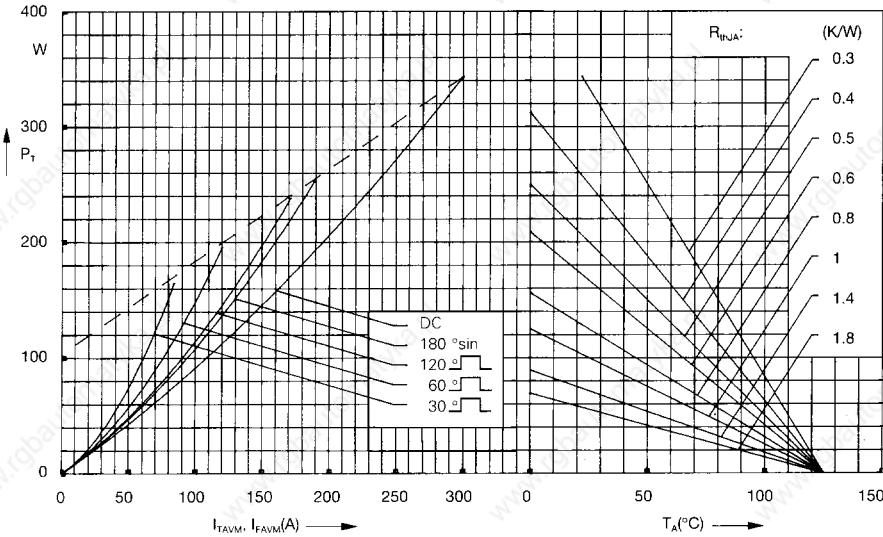


Fig. 5 Power dissipation versus on-state current and ambient temperature (per thyristor or diode)

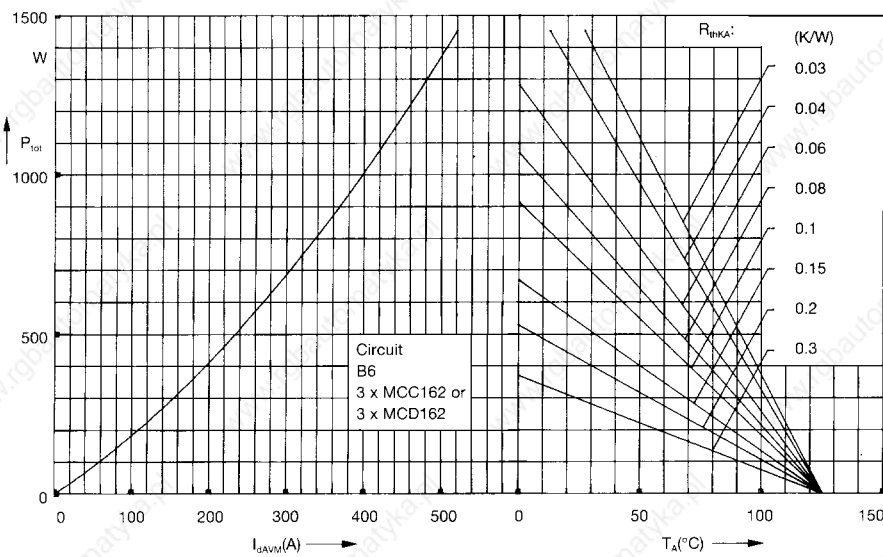


Fig. 6 Three phase rectifier bridge: Power dissipation versus direct output current and ambient temperature

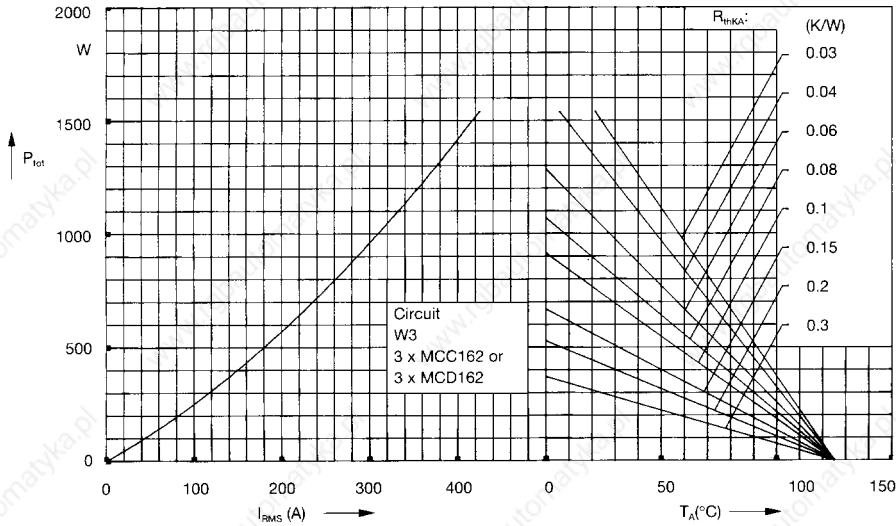


Fig. 7 Three phase AC-controller: Power dissipation versus RMS output current and ambient temperature

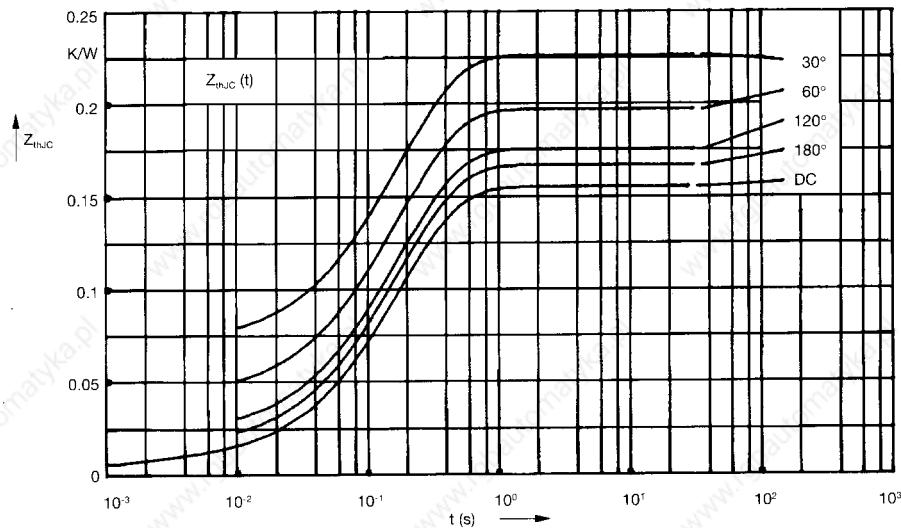


Fig. 8 Transient thermal impedance junction to case (per thyristor or diode)

$R_{thJC}$  for various conduction angles d:

d	$R_{thJC}$ (K/W)
DC	0.155
180°	0.167
120°	0.176
60°	0.197
30°	0.227

Constants for  $Z_{thJC}$  calculation:

i	$R_{thi}$ (K/W)	$t_i$ (s)
1	0.0072	0.001
2	0.0188	0.08
3	0.129	0.2

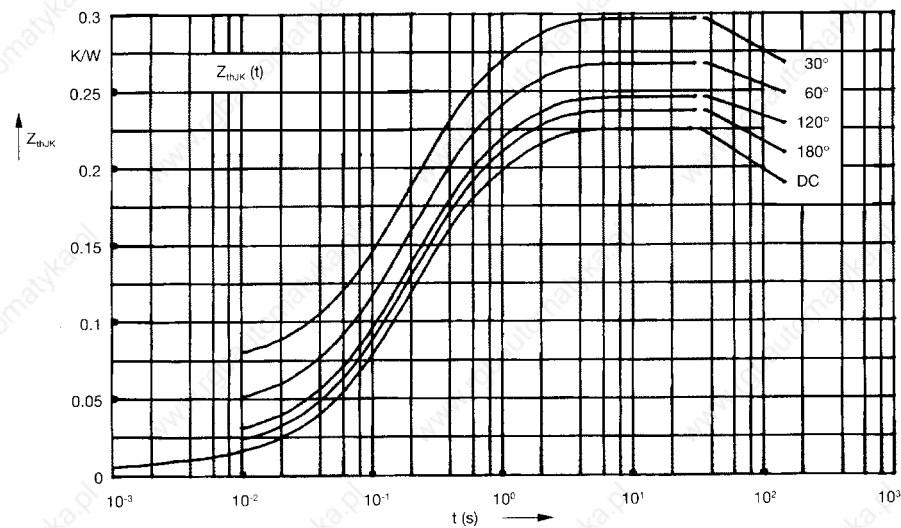


Fig. 9 Transient thermal impedance junction to heatsink (per thyristor or diode)

$R_{thJK}$  for various conduction angles d:

d	$R_{thJK}$ (K/W)
DC	0.225
180°	0.237
120°	0.246
60°	0.267
30°	0.297

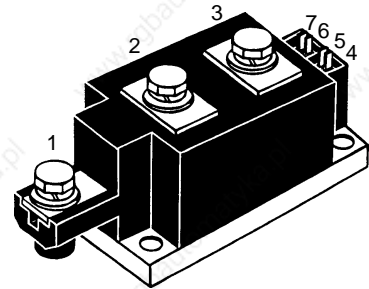
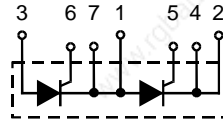
Constants for  $Z_{thJK}$  calculation:

i	$R_{thi}$ (K/W)	$t_i$ (s)
1	0.0072	0.001
2	0.0188	0.08
3	0.129	0.2
4	0.07	1.0

## Thyristor Modules Thyristor/Diode Modules

$I_{TRMS} = 2 \times 350 \text{ A}$   
 $I_{TAVM} = 2 \times 203 \text{ A}$   
 $V_{RRM} = 1200-1800 \text{ V}$

$V_{RSM}$ $V_{DSM}$ V	$V_{RRM}$ $V_{DRM}$ V	Type
1300	1200	MCC 170-12io1
1500	1400	MCC 170-14io1
1700	1600	MCC 170-16io1
1900	1800	MCC 170-18io1



Symbol	Test Conditions	Maximum Ratings
$I_{TRMS}$ $I_{TAVM}$	$T_{VJ} = T_{VJM}$ $T_C = 85^\circ\text{C}; 180^\circ \text{ sine}$	350 A 203 A
$I_{TSM}, I_{FSM}$	$T_{VJ} = 45^\circ\text{C};$ $V_R = 0$	$t = 10 \text{ ms (50 Hz)}$ 5400 A $t = 8.3 \text{ ms (60 Hz)}$ 5800 A
	$T_{VJ} = T_{VJM}$ $V_R = 0$	$t = 10 \text{ ms (50 Hz)}$ 5000 A $t = 8.3 \text{ ms (60 Hz)}$ 5500 A
$\int i^2 dt$	$T_{VJ} = 45^\circ\text{C}$ $V_R = 0$	$t = 10 \text{ ms (50 Hz)}$ 146 000 A <sup>2</sup> s $t = 8.3 \text{ ms (60 Hz)}$ 140 000 A <sup>2</sup> s
	$T_{VJ} = T_{VJM}$ $V_R = 0$	$t = 10 \text{ ms (50 Hz)}$ 125 000 A <sup>2</sup> s $t = 8.3 \text{ ms (60 Hz)}$ 126 000 A <sup>2</sup> s
$(di/dt)_{cr}$	$T_{VJ} = T_{VJM}$ $f = 50 \text{ Hz}, t_p = 200 \mu\text{s}$ $V_D = 2/3 V_{DRM}$ $I_G = 1 \text{ A},$ $di_G/dt = 1 \text{ A}/\mu\text{s}$	repetitive, $I_T = 660 \text{ A}$ 100 A/ $\mu\text{s}$ non repetitive, $I_T = I_{TAVM}$ 500 A/ $\mu\text{s}$
$(dv/dt)_{cr}$	$T_{VJ} = T_{VJM}; V_{DR} = 2/3 V_{DRM}$ $R_{GK} = \infty; \text{method 1 (linear voltage rise)}$	1000 V/ $\mu\text{s}$
$P_{GM}$	$T_{VJ} = T_{VJM}$ $I_T = I_{TAVM}$	$t_p = 30 \mu\text{s}$ 120 W $t_p = 500 \mu\text{s}$ 60 W
$P_{GAV}$ $V_{RGM}$		20 W 10 V
$T_{VJ}$ $T_{VJM}$ $T_{stg}$		-40...+130 °C 130 °C -40...+125 °C
$V_{ISOL}$	50/60 Hz, RMS $I_{ISOL} \leq 1 \text{ mA}$	$t = 1 \text{ min}$ 3000 V~ $t = 1 \text{ s}$ 3600 V~
$M_d$	Mounting torque (M6) Terminal connection torque (M8)	4.5-7/40-62 Nm/lb.in. 11-13/97-115 Nm/lb.in.
Weight	Typical including screws	750 g

### Features

- International standard package
- Direct copper bonded  $\text{Al}_2\text{O}_3$ -ceramic with copper base plate
- Planar passivated chips
- Isolation voltage 3600 V~
- UL registered E 72873
- Keyed gate/cathode twin pins

### Applications

- Motor control, softstarter
- Power converter
- Heat and temperature control for industrial furnaces and chemical processes
- Lighting control
- Solid state switches

### Advantages

- Simple mounting
- Improved temperature and power cycling
- Reduced protection circuits

Data according to IEC 60747 and refer to a single thyristor/diode unless otherwise stated.  
 IXYS reserves the right to change limits, test conditions and dimensions

Symbol	Test Conditions	Characteristic Values
$I_{RRM}, I_{DRM}$	$T_{VJ} = T_{VJM}; V_R = V_{RRM}; V_D = V_{DRM}$	40 mA
$V_{T1}, V_F$	$I_T, I_F = 600 \text{ A}; T_{VJ} = 25^\circ\text{C}$	1.65 V
$V_{T0}$	For power-loss calculations only ( $T_{VJ} = 130^\circ\text{C}$ )	0.8 V
$r_T$		1 mΩ
$V_{GT}$	$V_D = 6 \text{ V}; T_{VJ} = 25^\circ\text{C}$	2 V
	$T_{VJ} = -40^\circ\text{C}$	3 V
$I_{GT}$	$V_D = 6 \text{ V}; T_{VJ} = 25^\circ\text{C}$	150 mA
	$T_{VJ} = -40^\circ\text{C}$	220 mA
$V_{GD}$	$T_{VJ} = T_{VJM}; V_D = 2/3 V_{DRM}$	0.25 V
$I_{GD}$	$T_{VJ} = T_{VJM}; V_D = 2/3 V_{DRM}$	10 mA
$I_L$	$T_{VJ} = 25^\circ\text{C}; t_p = 30 \mu\text{s}; V_D = 6 \text{ V}$ $I_G = 0.45 \text{ A}; di_G/dt = 0.45 \text{ A}/\mu\text{s}$	200 mA
$I_H$	$T_{VJ} = 25^\circ\text{C}; V_D = 6 \text{ V}; R_{GK} = \infty$	150 mA
$t_{gd}$	$T_{VJ} = 25^\circ\text{C}; V_D = 1/2 V_{DRM}$ $I_G = 1 \text{ A}; di_G/dt = 1 \text{ A}/\mu\text{s}$	2 μs
$t_q$	$T_{VJ} = T_{VJM}; I_T = 300 \text{ A}, t_p = 200 \mu\text{s}; -di/dt = 10 \text{ A}/\mu\text{s}$ $V_R = 100 \text{ V}; dv/dt = 50 \text{ V}/\mu\text{s}; V_D = 2/3 V_{DRM}$	typ. 200 μs
$Q_S$	$T_{VJ} = 125^\circ\text{C}; I_T, I_F = 300 \text{ A}; -di/dt = 50 \text{ A}/\mu\text{s}$	550 μC
$I_{RM}$		235 A
$R_{thJC}$	per thyristor (diode); DC current per module	0.164 K/W
$R_{thJK}$	per thyristor (diode); DC current per module	0.102 K/W
	other values see Fig. 8/9	0.082 K/W
		0.204 K/W
$d_s$	Creeping distance on surface	12.7 mm
$d_a$	Creepage distance in air	9.6 mm
$a$	Maximum allowable acceleration	50 m/s <sup>2</sup>

Optional accessories for modules

Keyed Gate/Cathode twin plugs with wire length = 350 mm, gate = yellow, cathode = red

Type ZY 180 L (L = Left for pin pair 4/5) } UL 758, style 1385,  
Type ZY 180 R (R = Right for pin pair 6/7) } CSA class 5851, guide 460-1-1

### Dimensions in mm (1 mm = 0.0394")

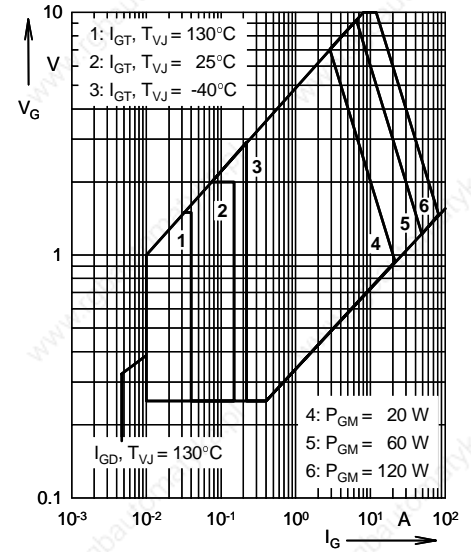
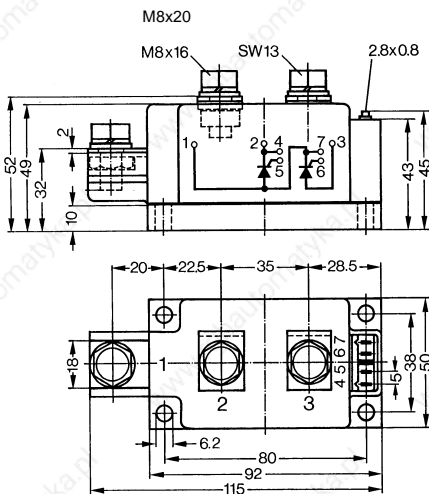


Fig. 1 Gate trigger characteristics

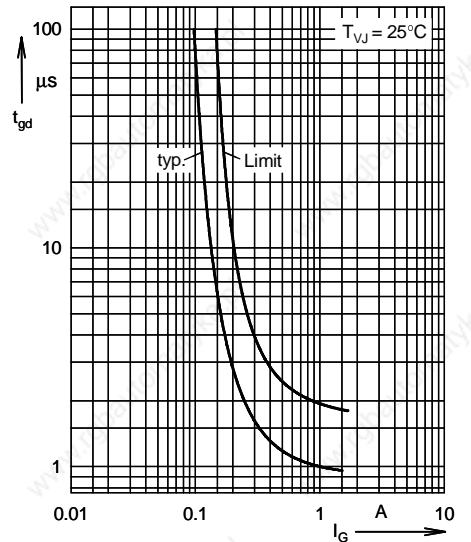


Fig. 2 Gate trigger delay time

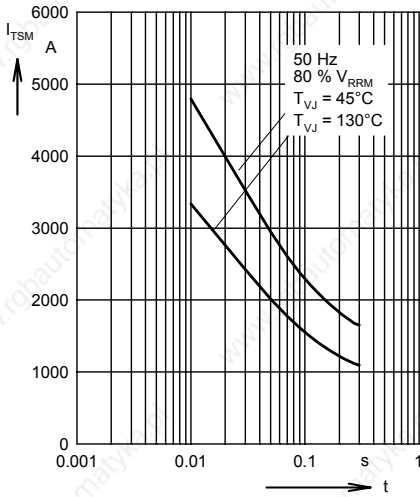


Fig. 3 Surge overload current  
 $I_{TSM}$ ,  $I_{FSM}$ : Crest value,  $t$ : duration

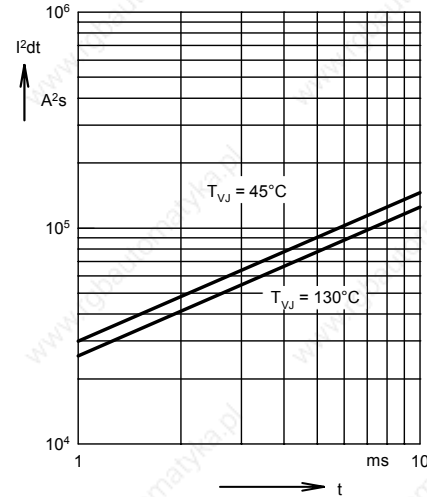


Fig. 4  $\int i^2 dt$  versus time (1-10 ms)

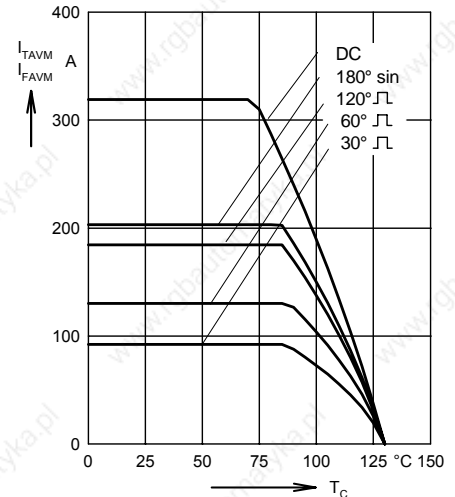


Fig. 4a Maximum forward current at case temperature

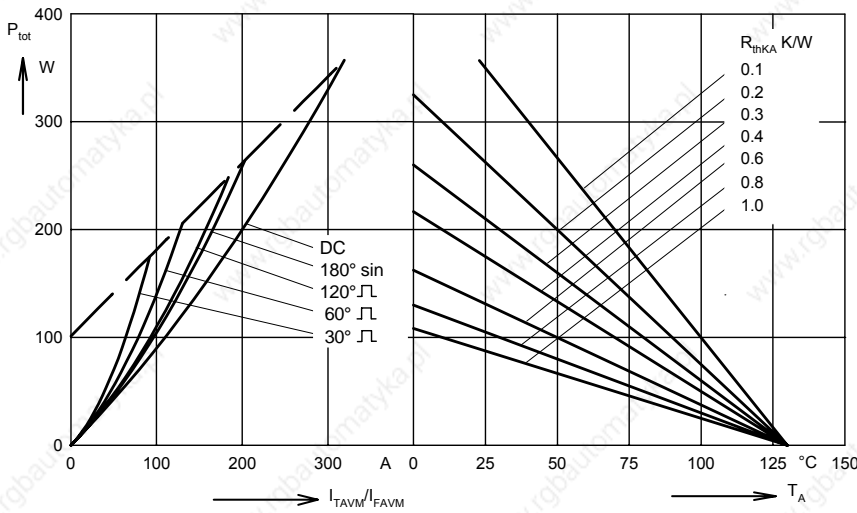


Fig. 5 Power dissipation versus on-state current and ambient temperature (per thyristor or diode)

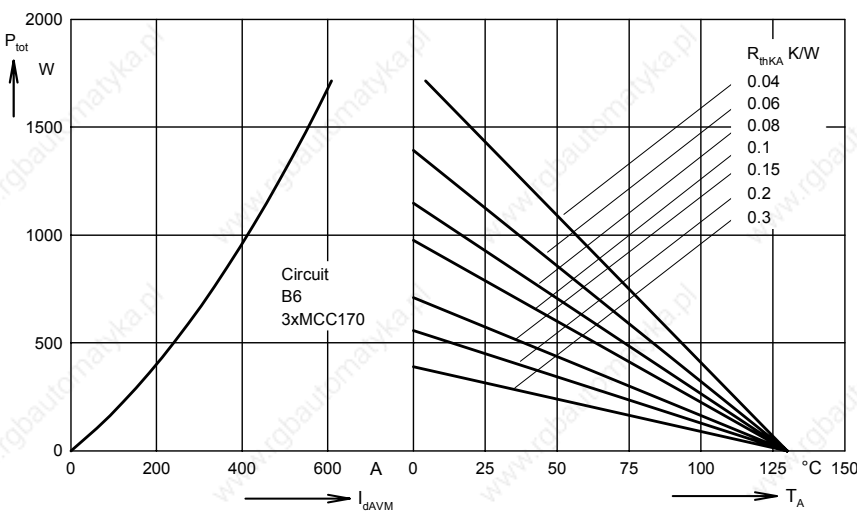


Fig. 6 Three phase rectifier bridge: Power dissipation versus direct output current and ambient temperature



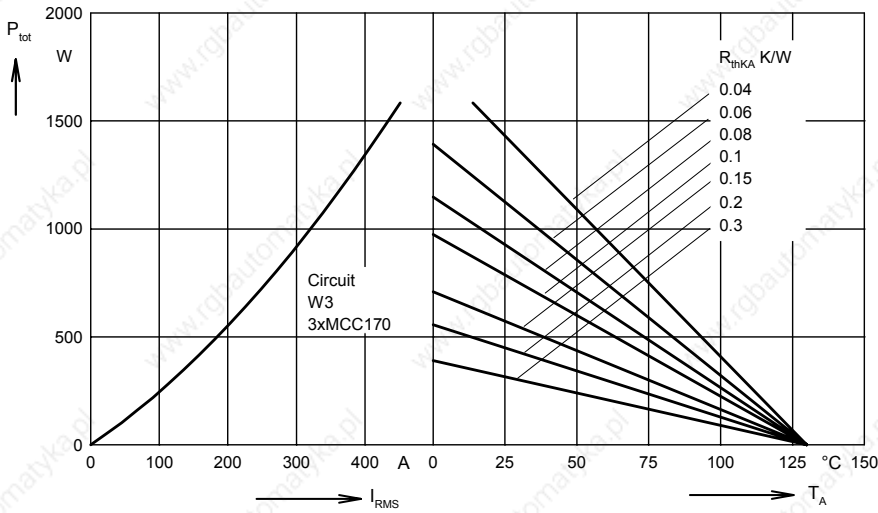


Fig. 7 Three phase AC-controller: Power dissipation versus RMS output current and ambient temperature

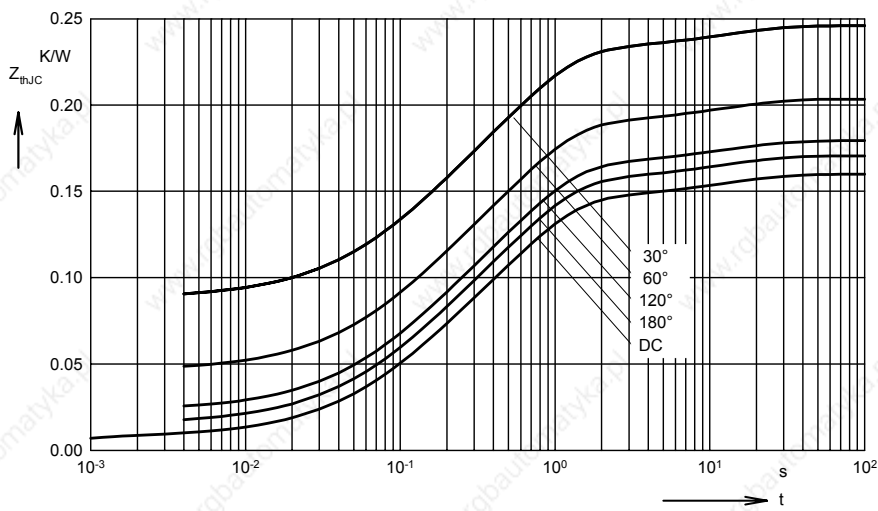


Fig. 8 Transient thermal impedance junction to case (per thyristor or diode)

$R_{thJC}$  for various conduction angles d:

d	$R_{thJC}$ (K/W)
DC	0.160
180°	0.171
120°	0.180
60°	0.203
30°	0.247

Constants for  $Z_{thJC}$  calculation:

i	$R_{thi}$ (K/W)	$t_i$ (s)
1	0.0077	0.00054
2	0.0413	0.098
3	0.096	0.54
4	0.0149	12

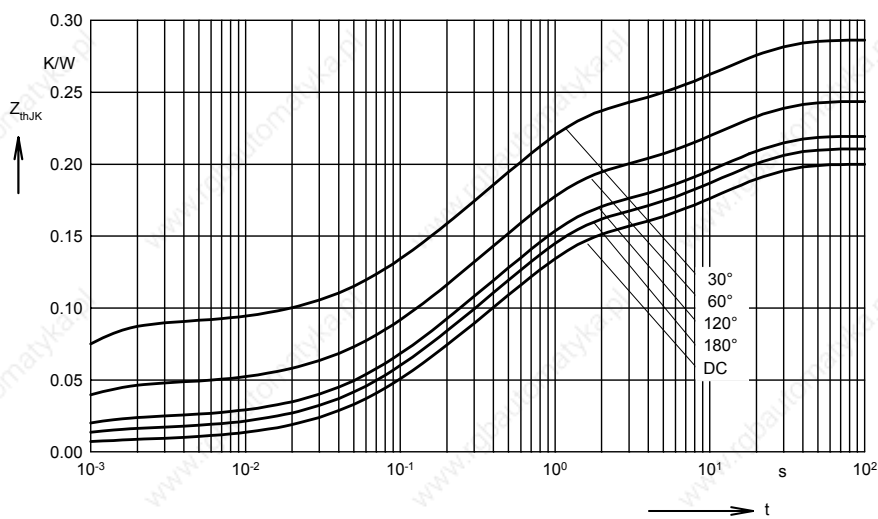


Fig. 9 Transient thermal impedance junction to heatsink (per thyristor or diode)

$R_{thJK}$  for various conduction angles d:

d	$R_{thJK}$ (K/W)
DC	0.200
180°	0.211
120°	0.220
60°	0.243
30°	0.287

Constants for  $Z_{thJK}$  calculation:

i	$R_{thi}$ (K/W)	$t_i$ (s)
1	0.0077	0.00054
2	0.0413	0.098
3	0.096	0.54
4	0.0149	12
5	0.04	12

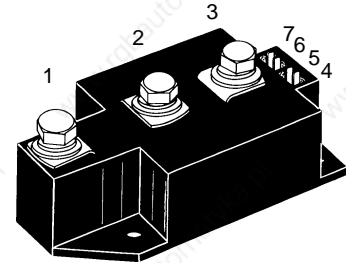
### Thyristor Modules Thyristor/Diode Modules

$$I_{TRMS} = 2 \times 400 \text{ A}$$

$$I_{TAVM} = 2 \times 250 \text{ A}$$

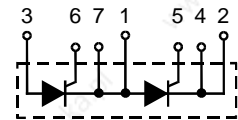
$$V_{RRM} = 800-1600 \text{ V}$$

$V_{RSM}$ $V_{DSM}$ V	$V_{RRM}$ $V_{DRM}$ V	Type	Version 1	Version 1
900	800	MCC 220-08io1	MCC 220-08io1	MCD 220-08io1
1300	1200	MCC 220-12io1	MCC 220-12io1	MCD 220-12io1
1500	1400	MCC 220-14io1	MCC 220-14io1	MCD 220-14io1
1700	1600	MCC 220-16io1	MCC 220-16io1	MCD 220-16io1

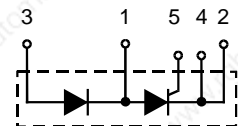


Symbol	Test Conditions	Maximum Ratings
$I_{TRMS}^1$ , $I_{FRMS}$ $I_{TAVM}^2$ , $I_{FAVM}$	$T_{VJ} = T_{VJM}$ $T_C = 85^\circ\text{C}$ ; 180° sine	400 A 250 A
$I_{TSM}^3$ , $I_{FSM}$	$T_{VJ} = 45^\circ\text{C}$ ; $V_R = 0$	t = 10 ms (50 Hz), sine 8500 A t = 8.3 ms (60 Hz), sine 9000 A
	$T_{VJ} = T_{VJM}$ $V_R = 0$	t = 10 ms (50 Hz), sine 7000 A t = 8.3 ms (60 Hz), sine 7600 A
$\int i^2 dt$	$T_{VJ} = 45^\circ\text{C}$ $V_R = 0$	t = 10 ms (50 Hz), sine 360 000 A <sup>2</sup> s t = 8.3 ms (60 Hz), sine 336 000 A <sup>2</sup> s
	$T_{VJ} = T_{VJM}$ $V_R = 0$	t = 10 ms (50 Hz), sine 245 000 A <sup>2</sup> s t = 8.3 ms (60 Hz), sine 240 000 A <sup>2</sup> s
$(di/dt)_{cr}$	$T_{VJ} = T_{VJM}$ f = 50 Hz, t <sub>p</sub> = 200 μs $V_D = 2/3 V_{DRM}$ $I_G = 1 \text{ A}$ di <sub>G</sub> /dt = 1 A/μs	repetitive, I <sub>T</sub> = 750 A 100 A/μs non repetitive, I <sub>T</sub> = 250 A 800 A/μs
$(dv/dt)_{cr}$	$T_{VJ} = T_{VJM}$ ; R <sub>GK</sub> = ∞; method 1 (linear voltage rise)	$V_{DR} = 2/3 V_{DRM}$ 1000 V/μs
$P_{GM}$	$T_{VJ} = T_{VJM}$ I <sub>T</sub> = I <sub>TAVM</sub>	t <sub>p</sub> = 30 μs 120 W t <sub>p</sub> = 500 μs 60 W
$P_{GAV}$		20 W
$V_{RGM}$		10 V
$T_{VJ}$		-40...+140 °C
$T_{VJM}$		140 °C
$T_{stg}$		-40...+125 °C
$V_{ISOL}$	50/60 Hz, RMS I <sub>ISOL</sub> ≤ 1 mA	t = 1 min 3000 V~ t = 1 s 3600 V~
$M_d$	Mounting torque (M5) Terminal connection torque (M8)	2.5-5/22-44 Nm/lb.in. 12-15/106-132 Nm/lb.in.
Weight	Typical including screws	320 g

MCC



MCD



#### Features

- International standard package
- Direct copper bonded Al<sub>2</sub>O<sub>3</sub> -ceramic base plate
- Planar passivated chips
- Isolation voltage 3600 V~
- UL registered, E 72873
- Keyed gate/cathode twin pins

#### Applications

- Motor control
- Power converter
- Heat and temperature control for industrial furnaces and chemical processes
- Lighting control
- Contactless switches

#### Advantages

- Space and weight savings
- Simple mounting
- Improved temperature and power cycling
- Reduced protection circuits

Data according to IEC 60747 and refer to a single thyristor/diode unless otherwise stated.  
IXYS reserves the right to change limits, test conditions and dimensions

Symbol	Test Conditions	Characteristic Values
$I_{RRM}$	$T_{VJ} = T_{VJM}; V_R = V_{RRM}; V_D = V_{DRM}$	70 mA
$I_{DRM}$		40 mA
$V_T, V_F$	$I_T, I_F = 600 \text{ A}; T_{VJ} = 25^\circ\text{C}$	1.53 V
$V_{T0}$	For power-loss calculations only ( $T_{VJ} = 140^\circ\text{C}$ )	0.9 V
$r_T$		1.0 mΩ
$V_{GT}$	$V_D = 6 \text{ V}; T_{VJ} = 25^\circ\text{C}$	2 V
	$T_{VJ} = -40^\circ\text{C}$	3 V
$I_{GT}$	$V_D = 6 \text{ V}; T_{VJ} = 25^\circ\text{C}$	150 mA
	$T_{VJ} = -40^\circ\text{C}$	200 mA
$V_{GD}$	$T_{VJ} = T_{VJM}; V_D = 2/3 V_{DRM}$	0.25 V
$I_{GD}$		10 mA
$I_L$	$T_{VJ} = 25^\circ\text{C}; t_p = 30 \mu\text{s}; V_D = 6 \text{ V}$ $I_G = 0.45 \text{ A}; di_G/dt = 0.45 \text{ A}/\mu\text{s}$	200 mA
$I_H$	$T_{VJ} = 25^\circ\text{C}; V_D = 6 \text{ V}; R_{GK} = \infty$	150 mA
$t_{gd}$	$T_{VJ} = 25^\circ\text{C}; V_D = 1/2 V_{DRM}$ $I_G = 1 \text{ A}; di_G/dt = 1 \text{ A}/\mu\text{s}$	2 μs
$t_q$	$T_{VJ} = T_{VJM}; I_T = 300 \text{ A}, t_p = 200 \mu\text{s}; -di/dt = 10 \text{ A}/\mu\text{s}$ typ. $V_R = 100 \text{ V}; dv/dt = 50 \text{ V}/\mu\text{s}; V_D = 2/3 V_{DRM}$	200 μs
$Q_S$	$T_{VJ} = 125^\circ\text{C}; I_T, I_F = 400 \text{ A}, -di/dt = 50 \text{ A}/\mu\text{s}$	760 μC
$I_{RM}$		275 A
$R_{thJC}$	per thyristor/diode; DC current per module	0.139 K/W
$R_{thJK}$	per thyristor/diode; DC current per module	0.0695 K/W
	other values see Fig. 8/9	0.179 K/W
		0.0895 K/W
$d_s$	Creepage distance on surface	12.7 mm
$d_A$	Strike distance through air	9.6 mm
$a$	Maximum allowable acceleration	50 m/s <sup>2</sup>

Optional accessories for modules

Keyed gate/cathode twin plugs with wire length = 350 mm, gate = yellow, cathode = red

Type ZY 180L (L = Left for pin pair 4/5) } UL 758, style 1385,  
Type ZY 180R (R = right for pin pair 6/7) } CSA class 5851, guide 460-1-1

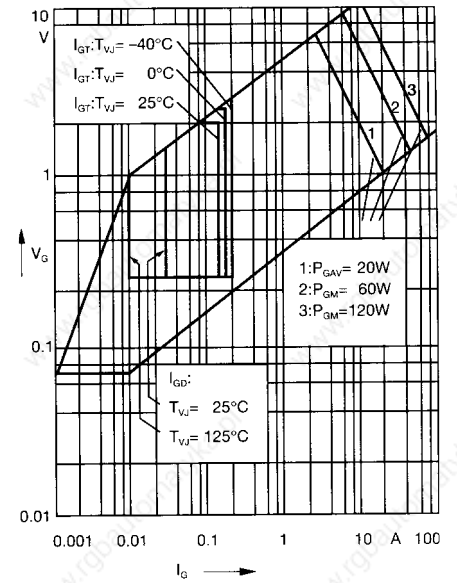


Fig. 1 Gate trigger characteristics

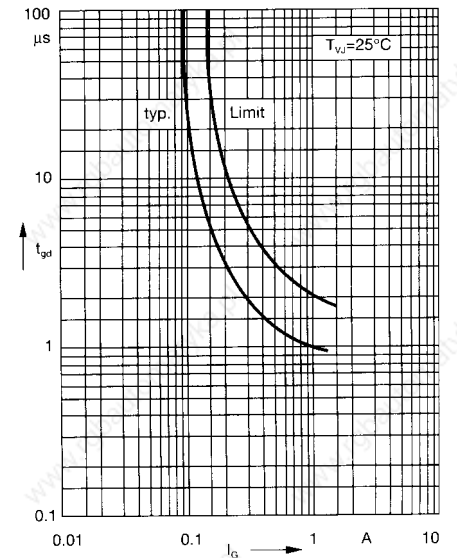
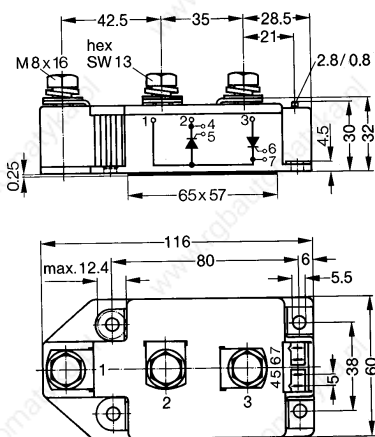


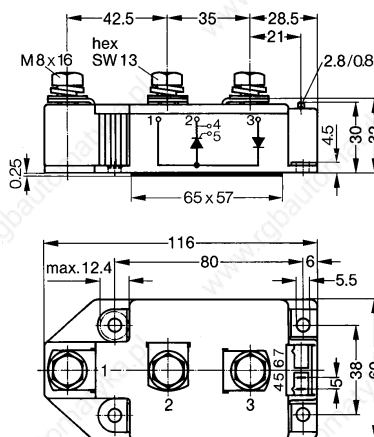
Fig. 2 Gate trigger delay time

### Dimensions in mm (1 mm = 0.0394")

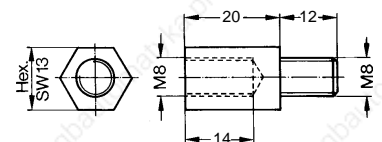
#### MCC



#### MCD



Threaded spacer for higher Anode/Cathode construction:  
Type ZY 250, material brass



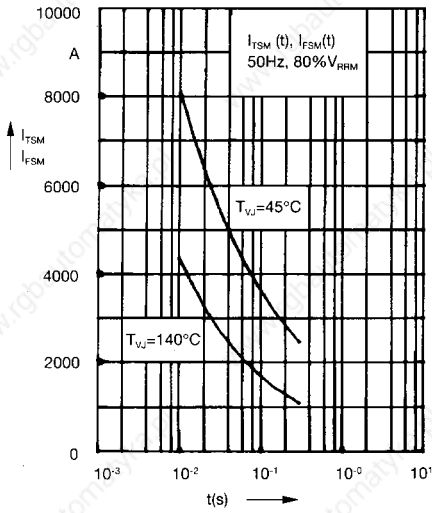


Fig. 3 Surge overload current  
 $I_{TSM}, I_{FSM}$ : Crest value,  $t$ : duration

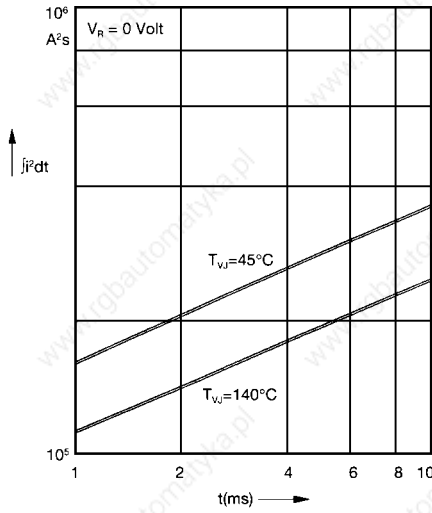


Fig. 4  $\int j^2 dt$  versus time (1-10 ms)

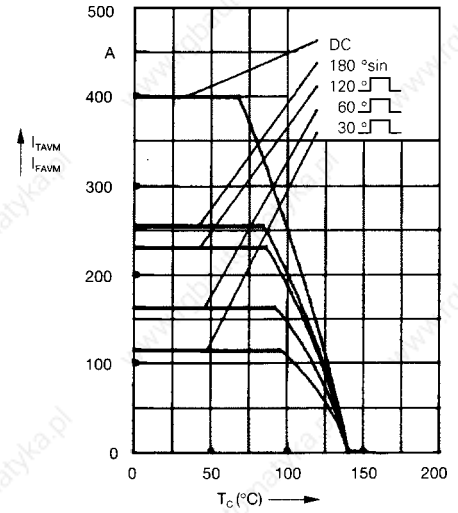


Fig. 4a Maximum forward current at case temperature

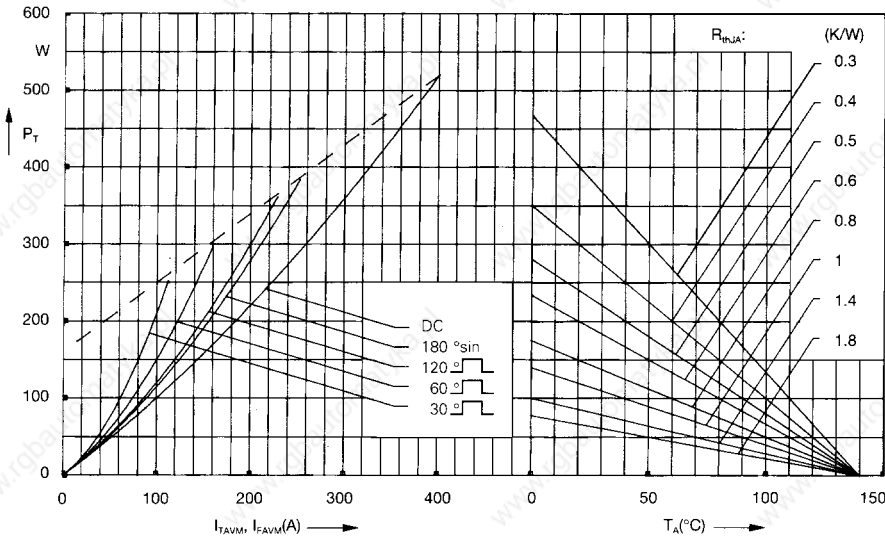


Fig. 5 Power dissipation versus on-state current and ambient temperature (per thyristor or diode)

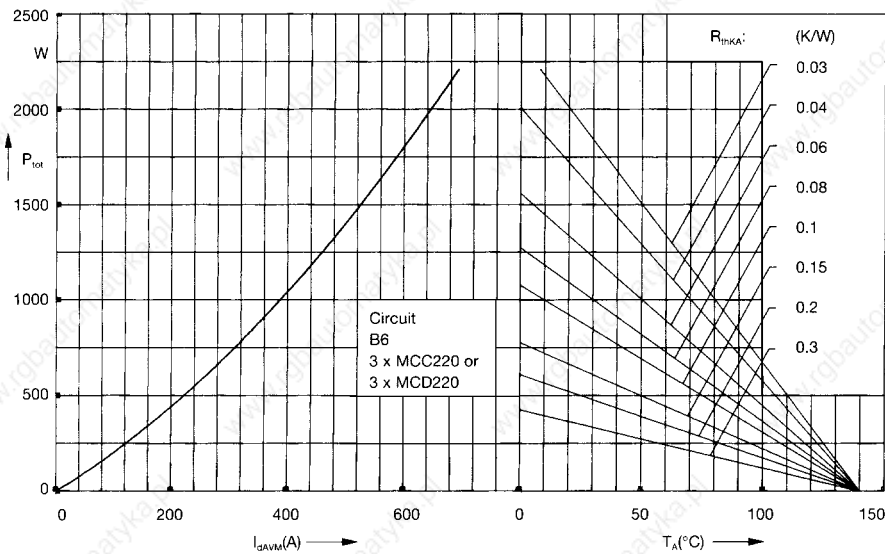


Fig. 6 Three phase rectifier bridge: Power dissipation versus direct output current and ambient temperature

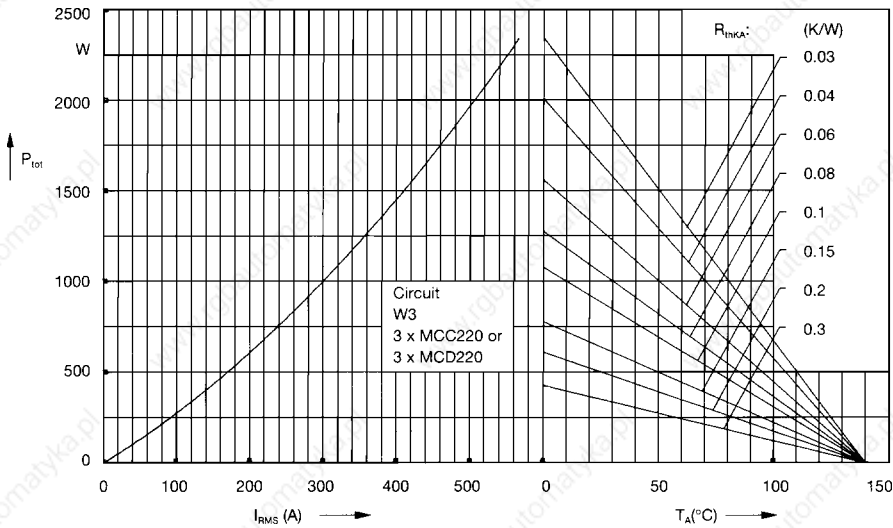


Fig. 7 Three phase AC-controller:  
Power dissipation versus RMS  
output current and ambient  
temperature

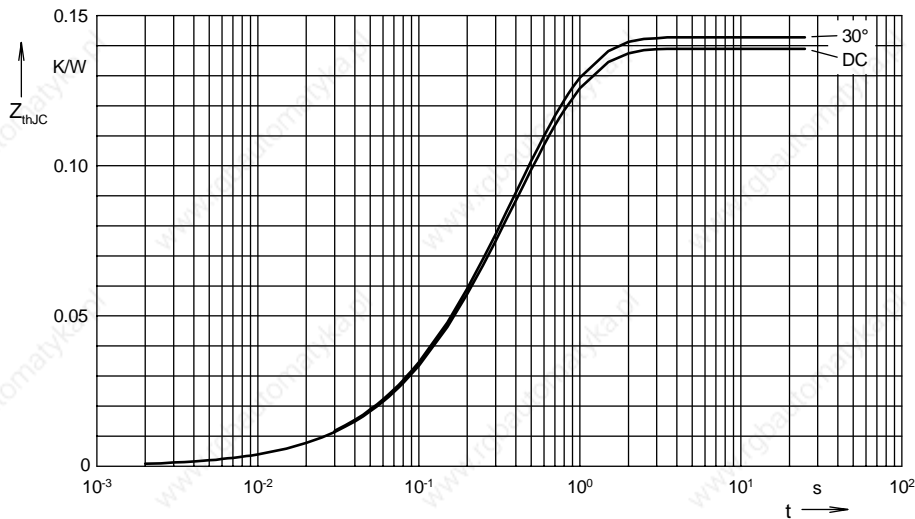


Fig. 8 Transient thermal impedance  
junction to case (per thyristor or  
diode)

$R_{thJC}$  for various conduction angles d:

d	$R_{thJC}$ (K/W)
DC	0.139
180°C	0.141
120°C	0.142
60°C	0.142
30°C	0.143

Constants for  $Z_{thJC}$  calculation:

i	$R_{thi}$ (K/W)	$t_i$ (s)
1	0.0037	0.0099
2	0.0177	0.168
3	0.1175	0.456

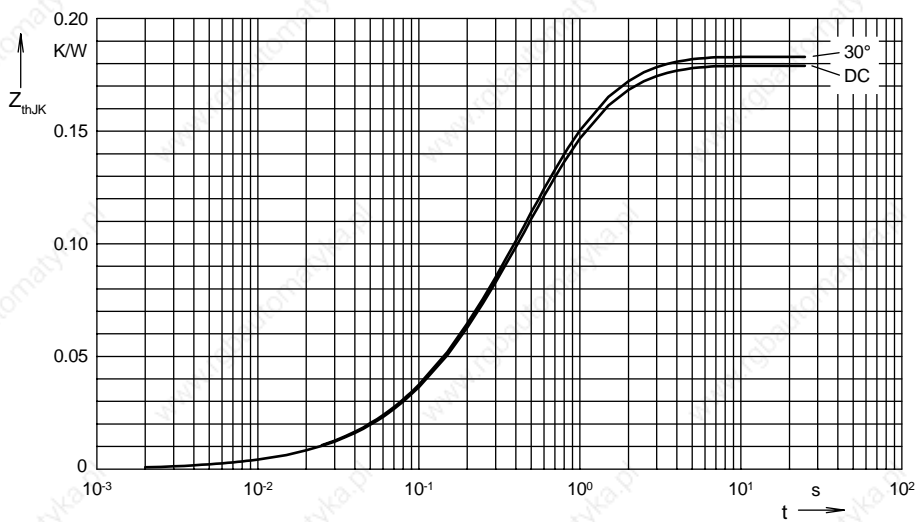


Fig. 9 Transient thermal impedance  
junction to heatsink (per thyristor  
or diode)

$R_{thJK}$  for various conduction angles d:

d	$R_{thJK}$ (K/W)
DC	0.179
180°C	0.181
120°C	0.182
60°C	0.183
30°C	0.183

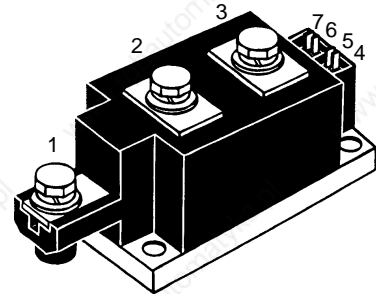
Constants for  $Z_{thJK}$  calculation:

i	$R_{thi}$ (K/W)	$t_i$ (s)
1	0.0037	0.0099
2	0.0177	0.168
3	0.1175	0.456
4	0.04	1.36

## Thyristor Modules Thyristor/Diode Modules

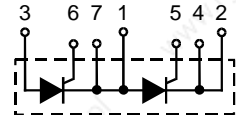
$I_{TRMS} = 2 \times 400 \text{ A}$   
 $I_{TAVM} = 2 \times 240 \text{ A}$   
 $V_{RRM} = 2000-2200 \text{ V}$

$V_{RSM}$	$V_{RRM}$	Type	
$V_{DSM}$	$V_{DRM}$		
V	V		
2100	2000	MCC 224-20io1	MCD 224-20io1
2300	2200	MCC 224-22io1	MCD 224-22io1

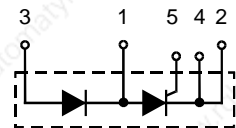


Symbol	Test Conditions	Maximum Ratings	
$I_{TRMS}$	$T_{VJ} = T_{VJM}$	400	A
$I_{TAVM}$	$T_C = 85^\circ\text{C}; 180^\circ \text{ sine}$	240	A
$I_{TSM}$	$T_{VJ} = 45^\circ\text{C};$ $V_R = 0$	$t = 10 \text{ ms (50 Hz)}$	A
		$t = 8.3 \text{ ms (60 Hz)}$	A
	$T_{VJ} = T_{VJM}$	$t = 10 \text{ ms (50 Hz)}$	A
	$V_R = 0$	$t = 8.3 \text{ ms (60 Hz)}$	A
$\int i^2 dt$	$T_{VJ} = 45^\circ\text{C}$ $V_R = 0$	$t = 10 \text{ ms (50 Hz)}$	$A^2s$
		$t = 8.3 \text{ ms (60 Hz)}$	$A^2s$
	$T_{VJ} = T_{VJM}$	$t = 10 \text{ ms (50 Hz)}$	$A^2s$
	$V_R = 0$	$t = 8.3 \text{ ms (60 Hz)}$	$A^2s$
$(di/dt)_{cr}$	$T_{VJ} = T_{VJM}$ $f = 50 \text{ Hz}, t_p = 200 \mu s$ $V_D = 2/3 V_{DRM}$ $I_G = 1 \text{ A}$ $di_G/dt = 1 \text{ A}/\mu s$	repetitive, $I_T = 750 \text{ A}$	100 $A/\mu s$
		non repetitive, $I_T = I_{TAVM}$	500 $A/\mu s$
$(dv/dt)_{cr}$	$T_{VJ} = T_{VJM}; V_{DR} = 2/3 V_{DRM}$ $R_{GK} = \infty; \text{method 1 (linear voltage rise)}$	1000	$V/\mu s$
$P_{GM}$	$T_{VJ} = T_{VJM}$ $I_T = I_{TAVM}$	$t_p = 30 \mu s$	120 W
		$t_p = 500 \mu s$	60 W
$P_{GAV}$			20 W
$V_{RGM}$			10 V
$T_{VJ}$		-40 ... 130	$^\circ\text{C}$
$T_{VJM}$		130	$^\circ\text{C}$
$T_{sig}$		-40 ... 125	$^\circ\text{C}$
$V_{ISOL}$	50/60 Hz, RMS	$t = 1 \text{ min}$	$V_{\sim}$
	$I_{ISOL} \leq 1 \text{ mA}$	$t = 1 \text{ s}$	$V_{\sim}$
$M_d$	Mounting torque (M6)	4.5-7/40-62	Nm/lb.in.
	Terminal connection torque (M8)	11-13/97-115	Nm/lb.in.
Weight	Typical including screws	750	g

**MCC**



**MCD**



### Features

- International standard package
- Direct Copper Bonded  $\text{Al}_2\text{O}_3$ -ceramic with copper base plate
- Planar passivated chips
- Isolation voltage 3600 V~
- UL registered E 72873
- Keyed gate/cathode twin pins

### Applications

- Motor control, softstarter
- Power converter
- Heat and temperature control for industrial furnaces and chemical processes
- Lighting control
- Solid state switches

### Advantages

- Simple mounting
- Improved temperature and power cycling
- Reduced protection circuits

Data according to IEC 60747 and refer to a single thyristor/diode unless otherwise stated. IXYS reserves the right to change limits, test conditions and dimensions

Symbol	Test Conditions	Characteristic Values	
$I_{RRM}, I_{DRM}$	$T_{VJ} = T_{VJM}; V_R = V_{RRM}$	40	mA
$V_T$	$I_T = 600 \text{ A}; T_{VJ} = 25^\circ\text{C}$	1.4	V
$V_{T0}$	For power-loss calculations only ( $T_{VJ} = T_{VJM}$ )	0.8	V
$r_T$		0.76	mΩ
$V_{GT}$	$V_D = 6 \text{ V}; T_{VJ} = 25^\circ\text{C}$	2	V
	$T_{VJ} = -40^\circ\text{C}$	3	V
$I_{GT}$	$V_D = 6 \text{ V}; T_{VJ} = 25^\circ\text{C}$	150	mA
	$T_{VJ} = -40^\circ\text{C}$	220	mA
$V_{GD}$	$T_{VJ} = T_{VJM}; V_D = 2/3 V_{DRM}$	0.25	V
$I_{GD}$	$T_{VJ} = T_{VJM}; V_D = 2/3 V_{DRM}$	10	mA
$I_L$	$T_{VJ} = 25^\circ\text{C}; V_D = 6 \text{ V}; t_p = 30 \mu\text{s}$ $di_G/dt = 0.45 \text{ A}/\mu\text{s}; I_G = 0.45 \text{ A}$	200	mA
$I_H$	$T_{VJ} = 25^\circ\text{C}; V_D = 6 \text{ V}; R_{GK} = \infty$	150	mA
$t_{gd}$	$T_{VJ} = 25^\circ\text{C}; V_D = 1/2 V_{DRM}$ $di_G/dt = 1 \text{ A}/\mu\text{s}; I_G = 1 \text{ A}$	2	μs
$t_q$	$T_{VJ} = T_{VJM}; V_R = 100 \text{ V}; V_D = 2/3 V_{DRM}; t_p = 200 \mu\text{s}$ $dv/dt = 50 \text{ V}/\mu\text{s}; I_T = 300 \text{ A}; -di/dt = 10 \text{ A}/\mu\text{s}$	typ. 200	μs
$Q_S$	} $T_{VJ} = T_{VJM}$ } $-di/dt = 50 \text{ A}/\mu\text{s}; I_T = 400 \text{ A}$	760	μC
$I_{RM}$		275	A
$R_{thJC}$	per thyristor; DC current	0.139	K/W
	per module	0.069	K/W
$R_{thJK}$	per thyristor; DC current	0.179	K/W
	per module	0.089	K/W
$d_s$	Creeping distance on surface	12.7	mm
$d_A$	Creepage distance in air	9.6	mm
$a$	Maximum allowable acceleration	50	m/s <sup>2</sup>

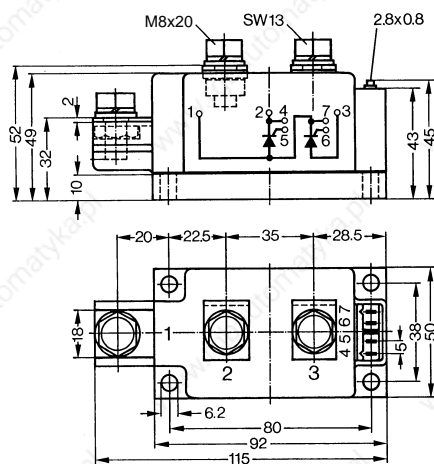
### Optional accessories for modules

Keyed Gate/Cathode twin plugs with wire length = 350 mm, gate = yellow, cathode = red

Type ZY 180 L (L = Left for pin pair 4/5) } UL 758, style 1385,  
Type ZY 180 R (R = Right for pin pair 6/7) } CSA class 5851, guide 460-1-1

### Dimensions in mm (1 mm = 0.0394")

#### MCC



#### MCD

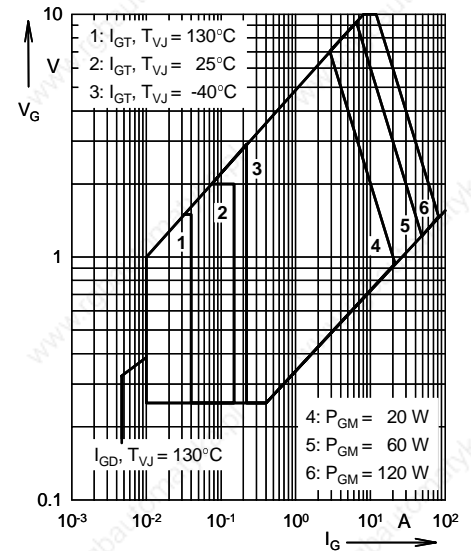
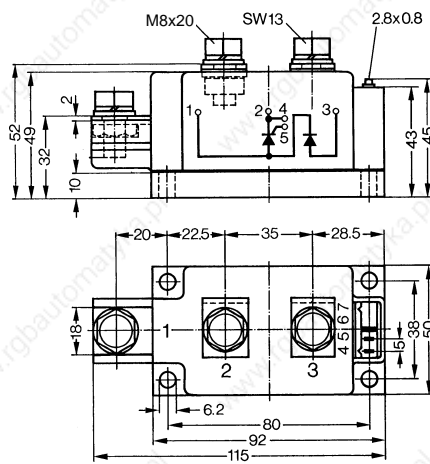


Fig. 1 Gate trigger characteristics

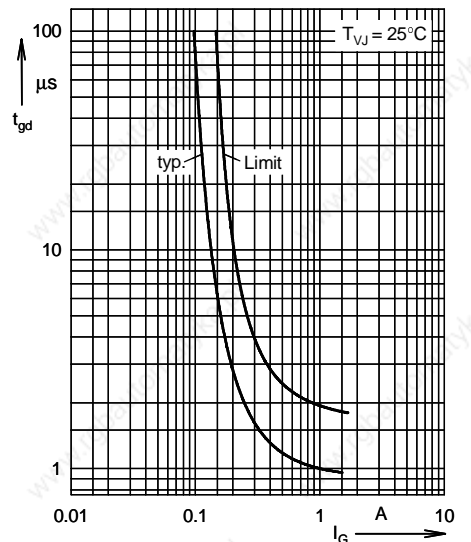


Fig. 2 Gate trigger delay time

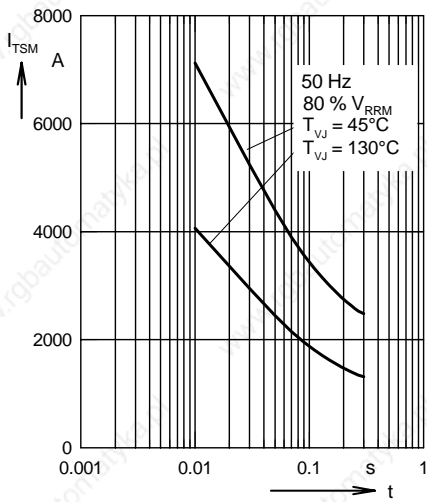


Fig. 3 Surge overload current  
 $I_{TSM}$ : Crest value,  $t$ : duration

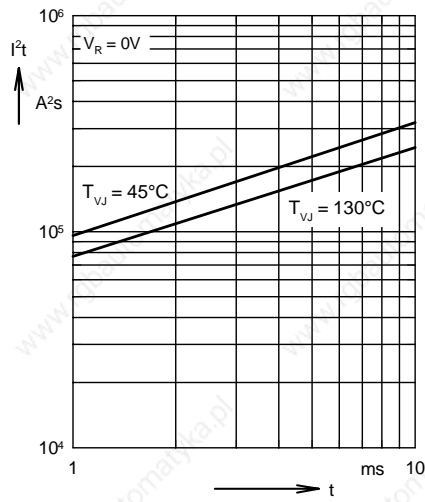


Fig. 4  $I^2t$  versus time (1-10 ms)

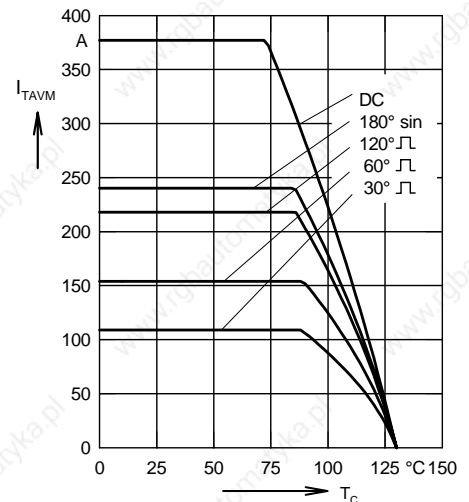


Fig. 4a Maximum forward current at case temperature

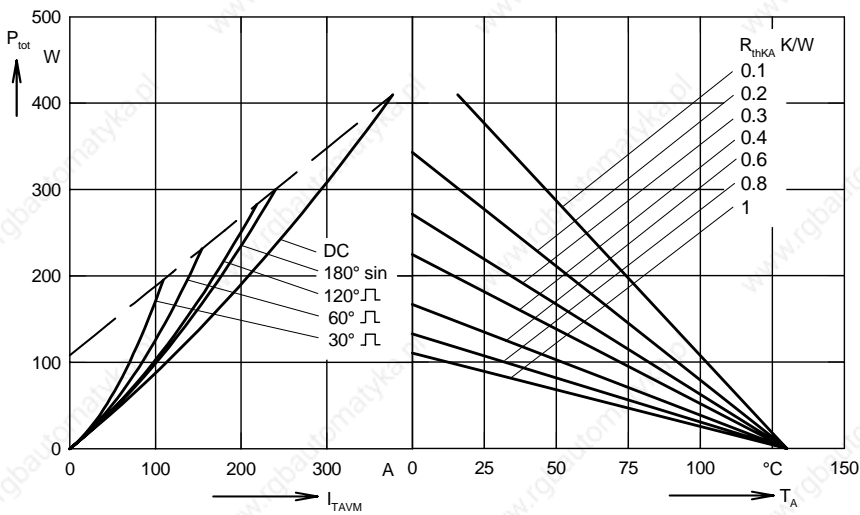


Fig. 5 Power dissipation versus on-state current and ambient temperature (per thyristor or diode)

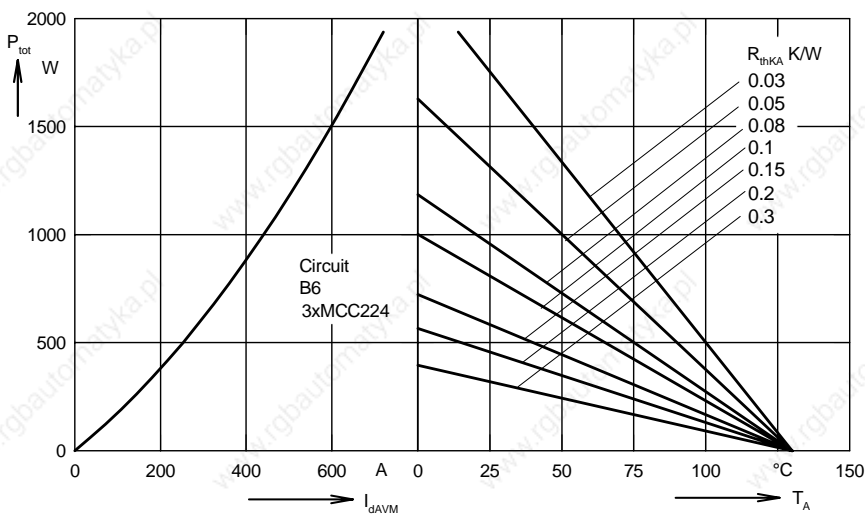


Fig. 6 Three phase rectifier bridge: Power dissipation versus direct output current and ambient temperature



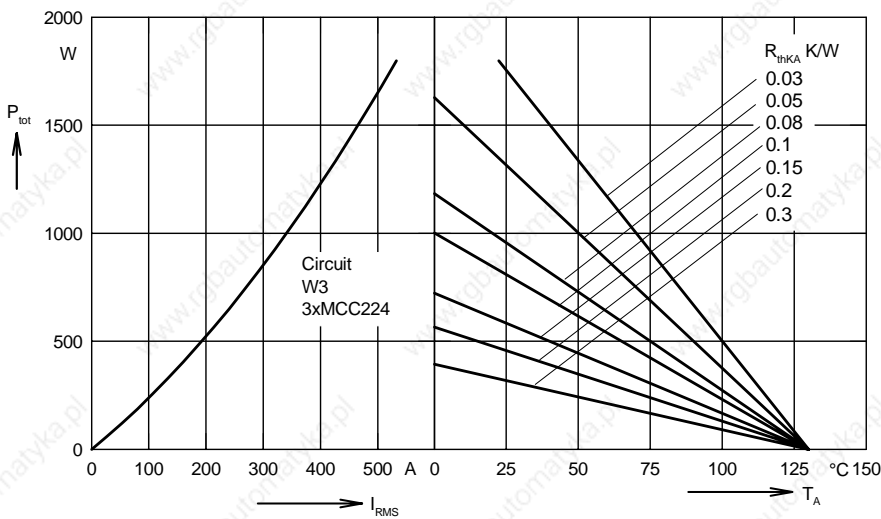


Fig. 7 Three phase AC-controller: Power dissipation versus RMS output current and ambient temperature

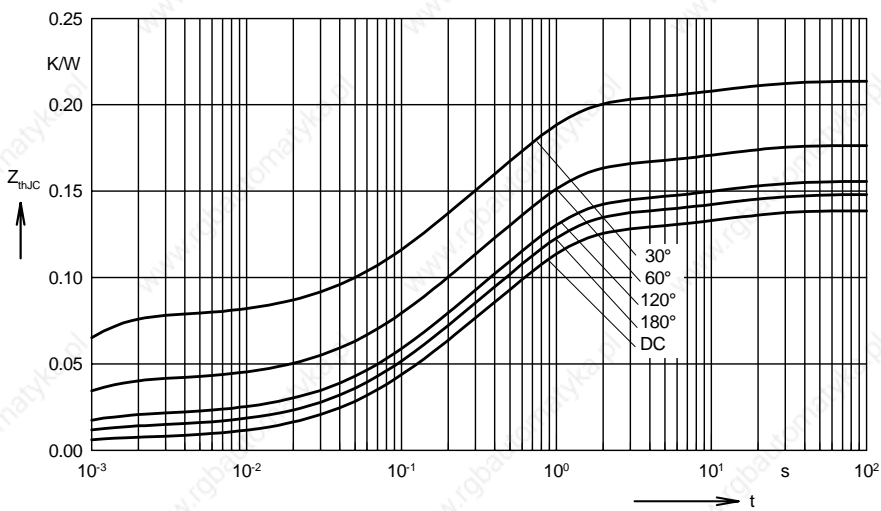


Fig. 8 Transient thermal impedance junction to case (per thyristor or diode)

$R_{thJC}$  for various conduction angles d:

d	$R_{thJC}$ (K/W)
DC	0.139
180°	0.148
120°	0.156
60°	0.176
30°	0.214

Constants for  $Z_{thJC}$  calculation:

i	$R_{thi}$ (K/W)	$t_i$ (s)
1	0.0067	0.00054
2	0.0358	0.098
3	0.0832	0.54
4	0.0129	12

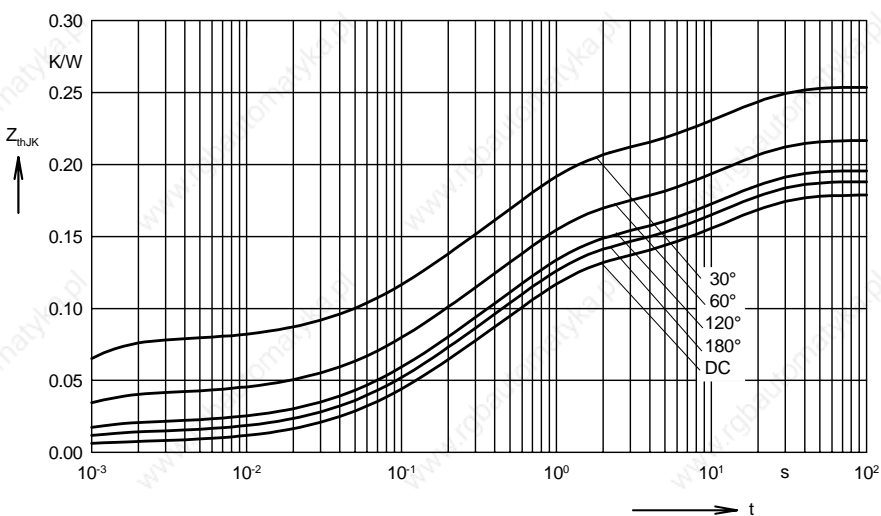


Fig. 9 Transient thermal impedance junction to heatsink (per thyristor or diode)

$R_{thJK}$  for various conduction angles d:

d	$R_{thJK}$ (K/W)
DC	0.179
180°	0.188
120°	0.196
60°	0.216
30°	0.256

Constants for  $Z_{thJK}$  calculation:

i	$R_{thi}$ (K/W)	$t_i$ (s)
1	0.0067	0.00054
2	0.0358	0.098
3	0.0832	0.54
4	0.0129	12
5	0.04	12

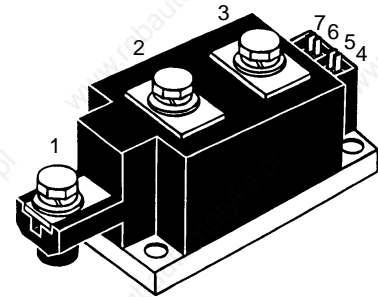
## Thyristor Modules Thyristor/Diode Modules

$$I_{TRMS} = 2 \times 400 \text{ A}$$

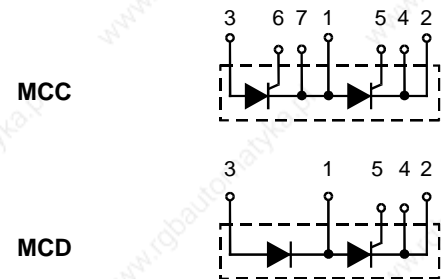
$$I_{TAVM} = 2 \times 221 \text{ A}$$

$$V_{RRM} = 1200-1800 \text{ V}$$

$V_{RSM}$	$V_{RRM}$	Type	
$V_{DSM}$	$V_{DRM}$		
V	V		
1300	1200	MCC 225-12io1	MCD 225-12io1
1500	1400	MCC 225-14io1	MCD 225-14io1
1700	1600	MCC 225-16io1	MCD 225-16io1
1900	1800	MCC 225-18io1	MCD 225-18io1



Symbol	Test Conditions	Maximum Ratings	
$I_{TRMS}$	$T_{VJ} = T_{VJM}$	400	A
$I_{TAVM}$	$T_C = 85^\circ\text{C}; 180^\circ \text{ sine}$	221	A
$I_{TSM}^*, I_{FSM}$	$T_{VJ} = 45^\circ\text{C};$ $V_R = 0$	$t = 10 \text{ ms (50 Hz)}$	8000 A
		$t = 8.3 \text{ ms (60 Hz)}$	8500 A
	$T_{VJ} = T_{VJM}$ $V_R = 0$	$t = 10 \text{ ms (50 Hz)}$	7000 A
		$t = 8.3 \text{ ms (60 Hz)}$	7700 A
$\int i^2 dt$	$T_{VJ} = 45^\circ\text{C}$ $V_R = 0$	$t = 10 \text{ ms (50 Hz)}$	320 000 A <sup>2</sup> s
		$t = 8.3 \text{ ms (60 Hz)}$	300 000 A <sup>2</sup> s
$(di/dt)_{cr}$	$T_{VJ} = T_{VJM}$ $V_R = 0$	$t = 10 \text{ ms (50 Hz)}$	245 000 A <sup>2</sup> s
		$t = 8.3 \text{ ms (60 Hz)}$	246 000 A <sup>2</sup> s
$(di/dt)_{cr}$	$T_{VJ} = T_{VJM}$ $f = 50 \text{ Hz}, t_p = 200 \mu\text{s}$ $V_D = 2/3 V_{DRM}$ $I_G = 1 \text{ A},$ $di_G/dt = 1 \text{ A}/\mu\text{s}$	repetitive, $I_T = 750 \text{ A}$	100 A/ $\mu\text{s}$
		non repetitive, $I_T = I_{TAVM}$	500 A/ $\mu\text{s}$
$(dv/dt)_{cr}$	$T_{VJ} = T_{VJM}; V_{DR} = 2/3 V_{DRM}$ $R_{GK} = \infty; \text{method 1 (linear voltage rise)}$	1000	V/ $\mu\text{s}$
$P_{GM}$	$T_{VJ} = T_{VJM}$ $I_T = I_{TAVM}$	$t_p = 30 \mu\text{s}$	120 W
		$t_p = 500 \mu\text{s}$	60 W
$P_{GAV}$		20	W
$V_{RGM}$		10	V
$T_{VJ}$		-40...+130	°C
$T_{VJM}$		130	°C
$T_{stg}$		-40...+125	°C
$V_{ISOL}$	50/60 Hz, RMS $I_{ISOL} \leq 1 \text{ mA}$	$t = 1 \text{ min}$	3000 V~
		$t = 1 \text{ s}$	3600 V~
$M_d$	Mounting torque (M6)	4.5-7/40-62	Nm/lb.in.
	Terminal connection torque (M8)	11-13/97-115	Nm/lb.in.
Weight	Typical including screws	750	g



### Features

- International standard package
- Direct copper bonded Al<sub>2</sub>O<sub>3</sub>-ceramic with copper base plate
- Planar passivated chips
- Isolation voltage 3600 V~
- UL registered E 72873
- Keyed gate/cathode twin pins

### Applications

- Motor control, softstarter
- Power converter
- Heat and temperature control for industrial furnaces and chemical processes
- Lighting control
- Solid state switches

### Advantages

- Simple mounting
- Improved temperature and power cycling
- Reduced protection circuits

Data according to IEC 60747 and refer to a single thyristor/diode unless otherwise stated. IXYS reserves the right to change limits, test conditions and dimensions

Symbol	Test Conditions	Characteristic Values
$I_{RRM}, I_{DRM}$	$T_{VJ} = T_{VJM}; V_R = V_{RRM}; V_D = V_{DRM}$	40 mA
$V_T, V_F$	$I_T, I_F = 600 \text{ A}; T_{VJ} = 25^\circ\text{C}$	1.40 V
$V_{T0}$	For power-loss calculations only ( $T_{VJ} = 130^\circ\text{C}$ )	0.8 V
$r_T$		0.76 mΩ
$V_{GT}$	$V_D = 6 \text{ V}; T_{VJ} = 25^\circ\text{C}$	2 V
	$T_{VJ} = -40^\circ\text{C}$	3 V
$I_{GT}$	$V_D = 6 \text{ V}; T_{VJ} = 25^\circ\text{C}$	150 mA
	$T_{VJ} = -40^\circ\text{C}$	220 mA
$V_{GD}$	$T_{VJ} = T_{VJM}; V_D = 2/3 V_{DRM}$	0.25 V
$I_{GD}$	$T_{VJ} = T_{VJM}; V_D = 2/3 V_{DRM}$	10 mA
$I_L$	$T_{VJ} = 25^\circ\text{C}; t_p = 30 \mu\text{s}; V_D = 6 \text{ V}$ $I_G = 0.45 \text{ A}; di_G/dt = 0.45 \text{ A}/\mu\text{s}$	200 mA
$I_H$	$T_{VJ} = 25^\circ\text{C}; V_D = 6 \text{ V}; R_{GK} = \infty$	150 mA
$t_{gd}$	$T_{VJ} = 25^\circ\text{C}; V_D = 1/2 V_{DRM}$ $I_G = 1 \text{ A}; di_G/dt = 1 \text{ A}/\mu\text{s}$	2 μs
$t_q$	$T_{VJ} = T_{VJM}; I_T = 300 \text{ A}, t_p = 200 \mu\text{s}; -di/dt = 10 \text{ A}/\mu\text{s}$ $V_R = 100 \text{ V}; dv/dt = 50 \text{ V}/\mu\text{s}; V_D = 2/3 V_{DRM}$	typ. 200 μs
$Q_S$	$T_{VJ} = 125^\circ\text{C}; I_T, I_F = 300 \text{ A}; -di/dt = 50 \text{ A}/\mu\text{s}$	550 μC
$I_{RM}$		235 A
$R_{thJC}$	per thyristor (diode); DC current per module	0.157 K/W
$R_{thJK}$	per thyristor (diode); DC current per module	0.08 K/W 0.197 K/W 0.1 K/W
	other values see Fig. 8/9	
$d_s$	Creeping distance on surface	12.7 mm
$d_a$	Creepage distance in air	9.6 mm
$a$	Maximum allowable acceleration	50 m/s <sup>2</sup>

### Optional accessories for modules

Keyed Gate/Cathode twin plugs with wire length = 350 mm, gate = yellow, cathode = red

Type ZY 180 L (L = Left for pin pair 4/5) } UL 758, style 1385,  
Type ZY 180 R (R = Right for pin pair 6/7) } CSA class 5851, guide 460-1-1

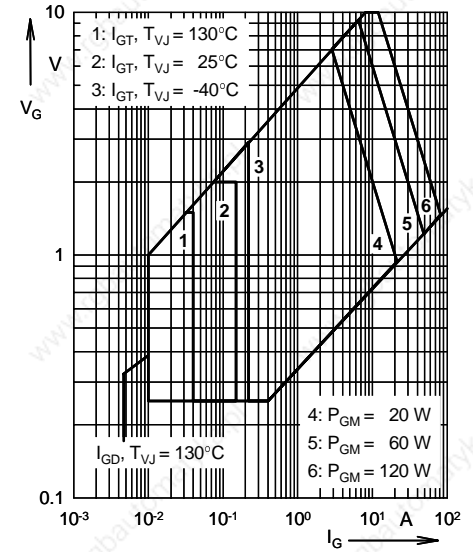


Fig. 1 Gate trigger characteristics

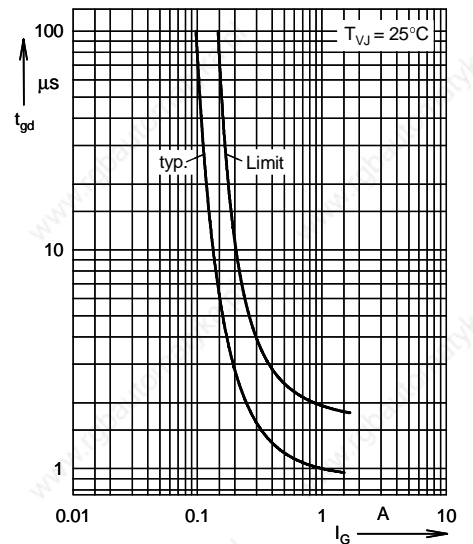
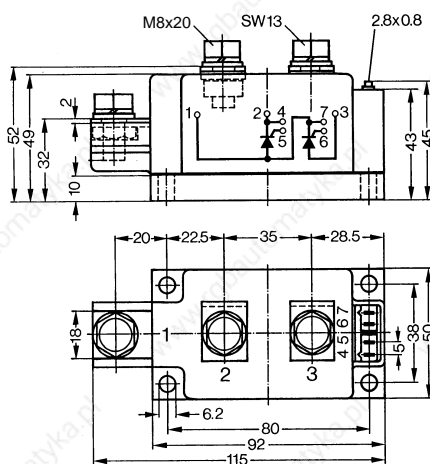


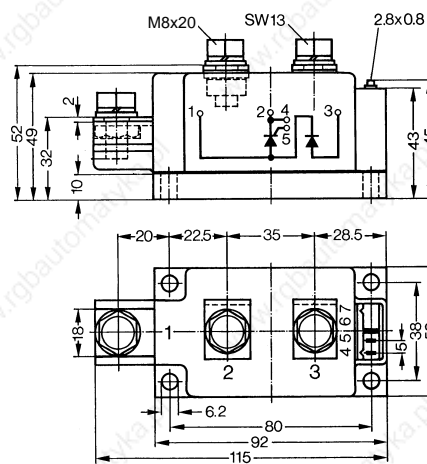
Fig. 2 Gate trigger delay time

### Dimensions in mm (1 mm = 0.0394")

#### MCC



#### MCD



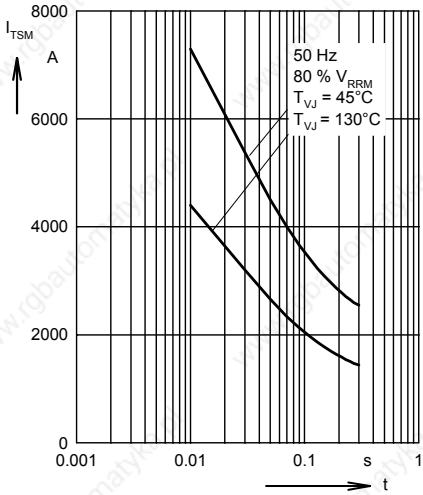


Fig. 3 Surge overload current  
 $I_{TSM}$ ,  $I_{FSM}$ : Crest value,  $t$ : duration

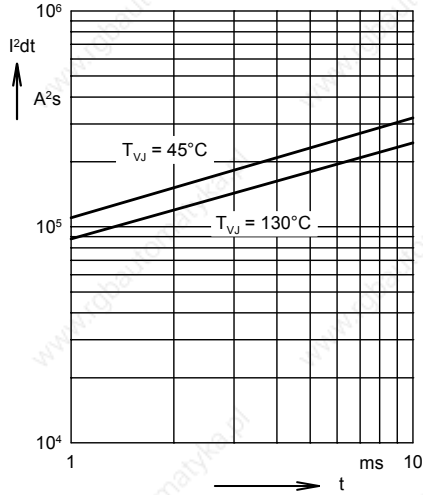


Fig. 4  $\int I^2 dt$  versus time (1-10 ms)

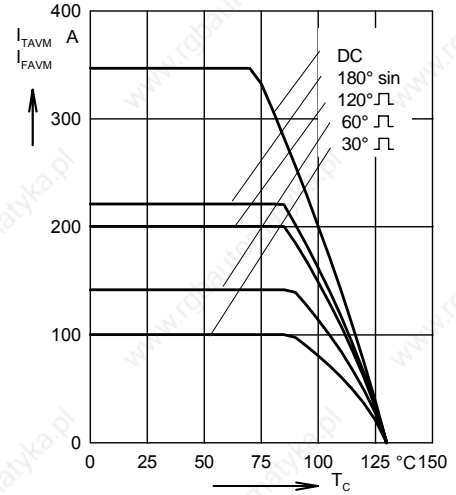


Fig. 4a Maximum forward current at case temperature

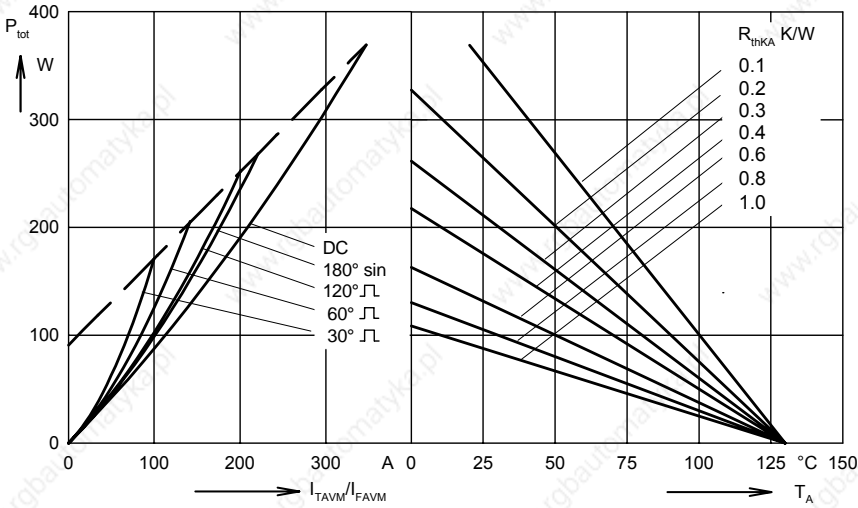


Fig. 5 Power dissipation versus on-state current and ambient temperature (per thyristor or diode)

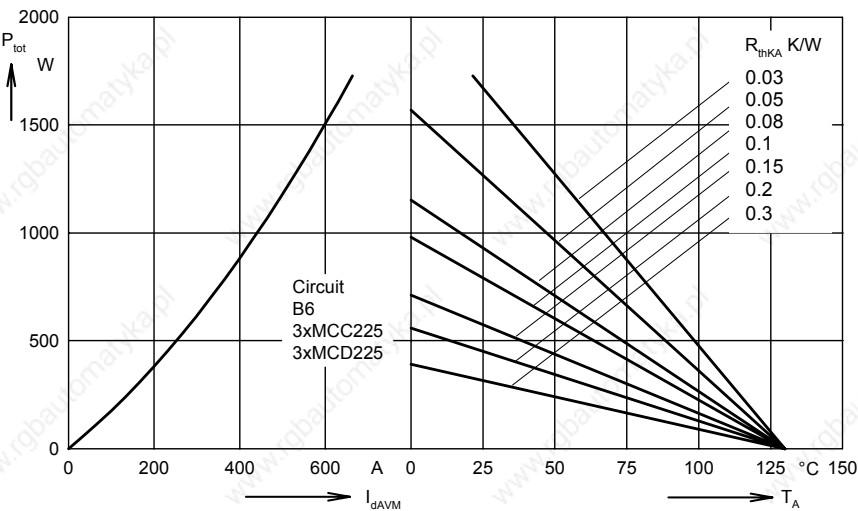


Fig. 6 Three phase rectifier bridge: Power dissipation versus direct output current and ambient temperature

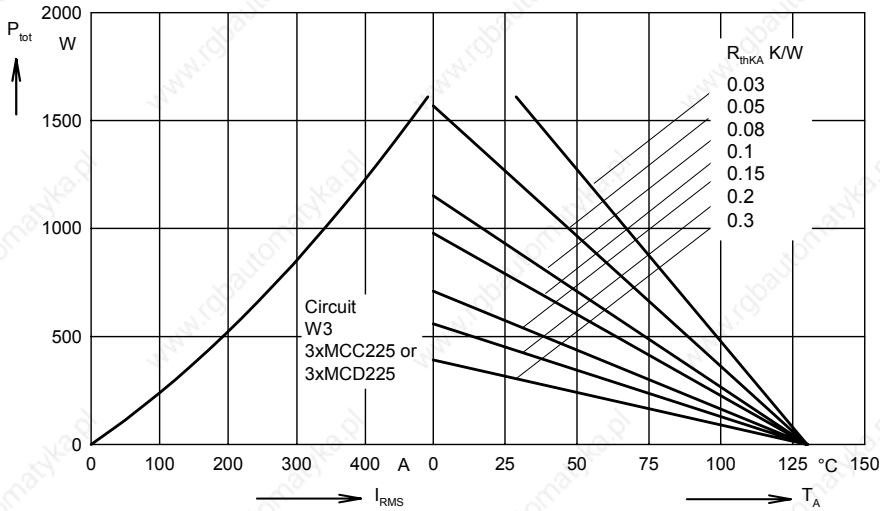


Fig. 7 Three phase AC-controller:  
Power dissipation versus RMS  
output current and ambient  
temperature

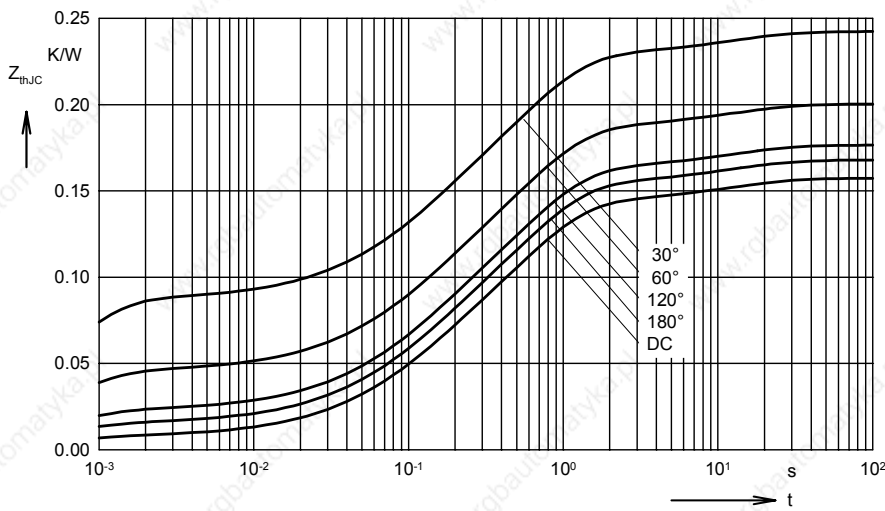


Fig. 8 Transient thermal impedance  
junction to case (per thyristor or  
diode)

$R_{thJC}$  for various conduction angles d:

d	$R_{thJC}$ (K/W)
DC	0.157
180°	0.168
120°	0.177
60°	0.200
30°	0.243

Constants for  $Z_{thJC}$  calculation:

i	$R_{thi}$ (K/W)	$t_i$ (s)
1	0.0076	0.00054
2	0.0406	0.098
3	0.0944	0.54
4	0.0147	12

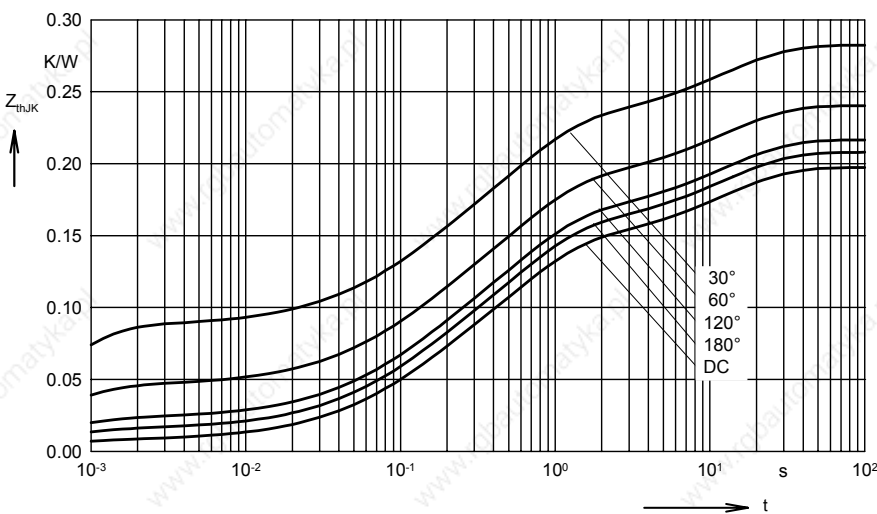


Fig. 9 Transient thermal impedance  
junction to heatsink (per thyristor  
or diode)

$R_{thJK}$  for various conduction angles d:

d	$R_{thJK}$ (K/W)
DC	0.197
180°	0.208
120°	0.217
60°	0.240
30°	0.283

Constants for  $Z_{thJK}$  calculation:

i	$R_{thi}$ (K/W)	$t_i$ (s)
1	0.0076	0.00054
2	0.0406	0.098
3	0.0944	0.54
4	0.0147	12
5	0.04	12

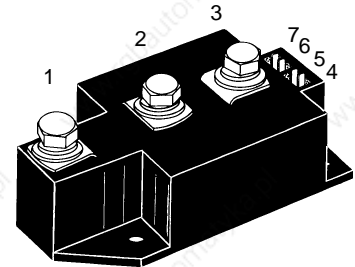
## Thyristor Modules Thyristor/Diode Modules

$$I_{TRMS} = 2 \times 450 \text{ A}$$

$$I_{TAVM} = 2 \times 287 \text{ A}$$

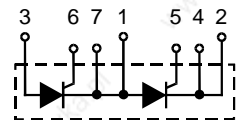
$$V_{RRM} = 800-1800 \text{ V}$$

$V_{RSM}$ $V_{DSM}$ V	$V_{RRM}$ $V_{DRM}$ V	Type	Version 1	Version 1
900	800	MCC 250-08io1	MCD 250-08io1	
1300	1200	MCC 250-12io1	MCD 250-12io1	
1500	1400	MCC 250-14io1	MCD 250-14io1	
1700	1600	MCC 250-16io1	MCD 250-16io1	
1900	1800	MCC 250-18io1		

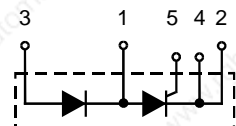


Symbol	Test Conditions	Maximum Ratings
$I_{TRMS}^1$ , $I_{FRMS}$ $I_{TAVM}^2$ , $I_{FAVM}$	$T_{VJ} = T_{VJM}$ $T_C = 85^\circ\text{C}$ ; 180° sine	450 A 287 A
$I_{TSM}^3$ , $I_{FSM}$	$T_{VJ} = 45^\circ\text{C}$ ; $V_R = 0$	t = 10 ms (50 Hz), sine 9000 A t = 8.3 ms (60 Hz), sine 9600 A
	$T_{VJ} = T_{VJM}$ $V_R = 0$	t = 10 ms (50 Hz), sine 7800 A t = 8.3 ms (60 Hz), sine 8500 A
$j^2dt$	$T_{VJ} = 45^\circ\text{C}$ $V_R = 0$	t = 10 ms (50 Hz), sine 405 000 A <sup>2</sup> s t = 8.3 ms (60 Hz), sine 380 000 A <sup>2</sup> s
	$T_{VJ} = T_{VJM}$ $V_R = 0$	t = 10 ms (50 Hz), sine 304 000 A <sup>2</sup> s t = 8.3 ms (60 Hz), sine 300 000 A <sup>2</sup> s
$(di/dt)_{cr}$	$T_{VJ} = T_{VJM}$ f = 50 Hz, t <sub>p</sub> = 200 μs $V_D = 2/3 V_{DRM}$ $I_G = 1 \text{ A}$ di <sub>G</sub> /dt = 1 A/μs	repetitive, I <sub>T</sub> = 860 A 100 A/μs non repetitive, I <sub>T</sub> = 290 A 800 A/μs
$(dv/dt)_{cr}$	$T_{VJ} = T_{VJM}$ ; R <sub>GK</sub> = ∞; method 1 (linear voltage rise)	$V_{DR} = 2/3 V_{DRM}$ 1000 V/μs
$P_{GM}$	$T_{VJ} = T_{VJM}$ I <sub>T</sub> = I <sub>TAVM</sub>	t <sub>p</sub> = 30 μs 120 W t <sub>p</sub> = 500 μs 60 W
$P_{GAV}$		20 W
$V_{RGM}$		10 V
$T_{VJ}$		-40...+140 °C
$T_{VJM}$		140 °C
$T_{stg}$		-40...+125 °C
$V_{ISOL}$	50/60 Hz, RMS I <sub>ISOL</sub> ≤ 1 mA	t = 1 min 3000 V~ t = 1 s 3600 V~
$M_d$	Mounting torque (M5) Terminal connection torque (M8)	2.5-5/22-44 Nm/lb.in. 12-15/106-132 Nm/lb.in.
<b>Weight</b>	Typical including screws	320 g

**MCC**



**MCD**



### Features

- International standard package
- Direct copper bonded Al<sub>2</sub>O<sub>3</sub> -ceramic base plate
- Planar passivated chips
- Isolation voltage 3600 V~
- UL registered, E 72873
- Keyed gate/cathode twin pins

### Applications

- Motor control
- Power converter
- Heat and temperature control for industrial furnaces and chemical processes
- Lighting control
- Contactless switches

### Advantages

- Space and weight savings
- Simple mounting
- Improved temperature and power cycling
- Reduced protection circuits

Data according to IEC 60747 and refer to a single thyristor/diode unless otherwise stated.  
IXYS reserves the right to change limits, test conditions and dimensions

Symbol	Test Conditions	Characteristic Values
$I_{RRM}$	$T_{VJ} = T_{VJM}; V_R = V_{RRM}; V_D = V_{DRM}$	70 mA
$I_{DRM}$		40 mA
$V_T, V_F$	$I_T, I_F = 600 \text{ A}; T_{VJ} = 25^\circ\text{C}$	1.36 V
$V_{T0}$	For power-loss calculations only ( $T_{VJ} = 140^\circ\text{C}$ )	0.85 V
$r_T$		0.82 mΩ
$V_{GT}$	$V_D = 6 \text{ V}; T_{VJ} = 25^\circ\text{C}$	2 V
	$T_{VJ} = -40^\circ\text{C}$	3 V
$I_{GT}$	$V_D = 6 \text{ V}; T_{VJ} = 25^\circ\text{C}$	150 mA
	$T_{VJ} = -40^\circ\text{C}$	200 mA
$V_{GD}$	$T_{VJ} = T_{VJM}; V_D = 2/3 V_{DRM}$	0.25 V
$I_{GD}$		10 mA
$I_L$	$T_{VJ} = 25^\circ\text{C}; t_p = 30 \mu\text{s}; V_D = 6 \text{ V}$ $I_G = 0.45 \text{ A}; di_G/dt = 0.45 \text{ A}/\mu\text{s}$	200 mA
$I_H$	$T_{VJ} = 25^\circ\text{C}; V_D = 6 \text{ V}; R_{GK} = \infty$	150 mA
$t_{gd}$	$T_{VJ} = 25^\circ\text{C}; V_D = 1/2 V_{DRM}$ $I_G = 1 \text{ A}; di_G/dt = 1 \text{ A}/\mu\text{s}$	2 μs
$t_q$	$T_{VJ} = T_{VJM}; I_T = 300 \text{ A}, t_p = 200 \mu\text{s}; -di/dt = 10 \text{ A}/\mu\text{s}$ typ. $V_R = 100 \text{ V}; dv/dt = 50 \text{ V}/\mu\text{s}; V_D = 2/3 V_{DRM}$	200 μs
$Q_S$	$T_{VJ} = 125^\circ\text{C}; I_T, I_F = 400 \text{ A}, -di/dt = 50 \text{ A}/\mu\text{s}$	760 μC
$I_{RM}$		275 A
$R_{thJC}$	per thyristor/diode; DC current per module	0.129 K/W
$R_{thJK}$	per thyristor/diode; DC current per module	0.0645 K/W
	other values see Fig. 8/9	0.169 K/W
		0.0845 K/W
$d_s$	Creepage distance on surface	12.7 mm
$d_A$	Strike distance through air	9.6 mm
$a$	Maximum allowable acceleration	50 m/s <sup>2</sup>

Optional accessories for modules

Keyed gate/cathode twin plugs with wire length = 350 mm, gate = yellow, cathode = red

Type ZY 180L (L = Left for pin pair 4/5) } UL 758, style 1385,  
Type ZY 180R (R = right for pin pair 6/7) } CSA class 5851, guide 460-1-1

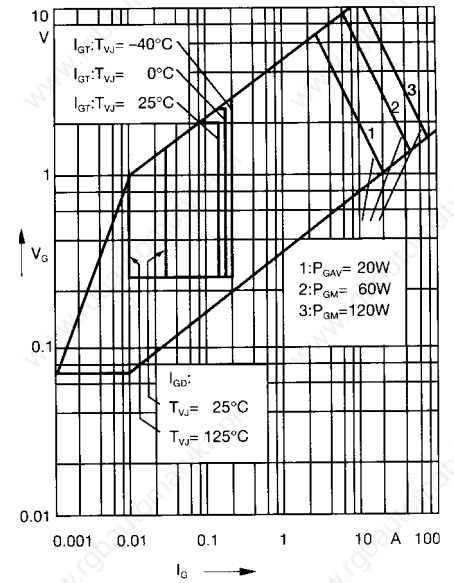


Fig. 1 Gate trigger characteristics

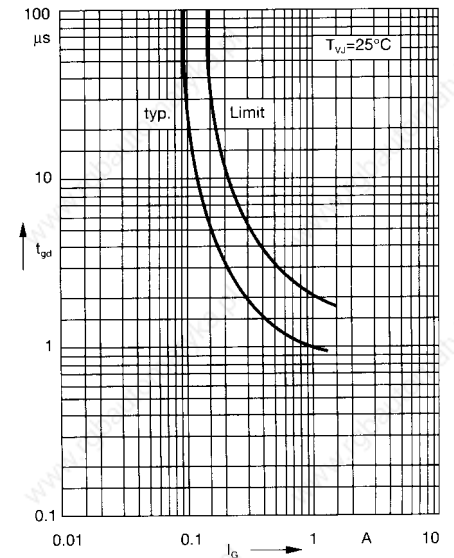
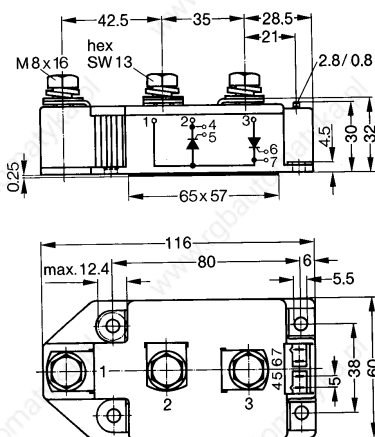


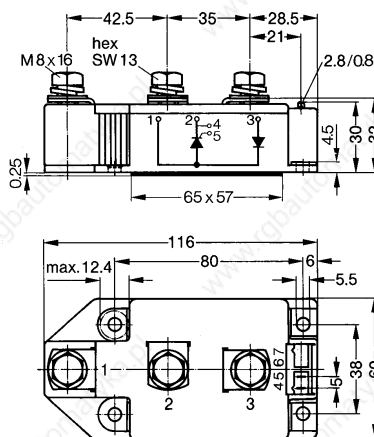
Fig. 2 Gate trigger delay time

### Dimensions in mm (1 mm = 0.0394")

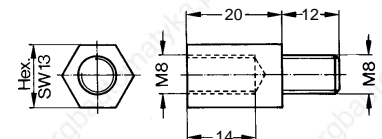
#### MCC



#### MCD



Threaded spacer for higher Anode/Cathode construction:  
Type ZY 250, material brass



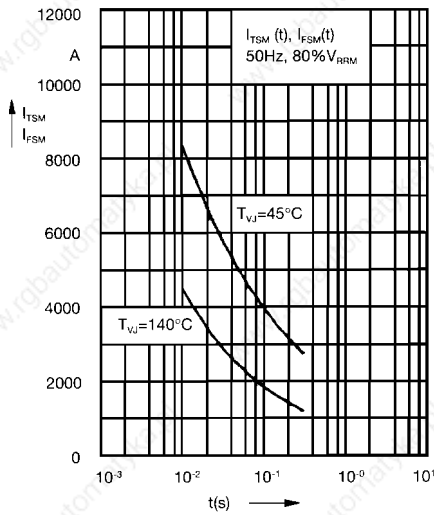


Fig. 3 Surge overload current  
 $I_{TSM}, I_{FSM}$ : Crest value, t: duration

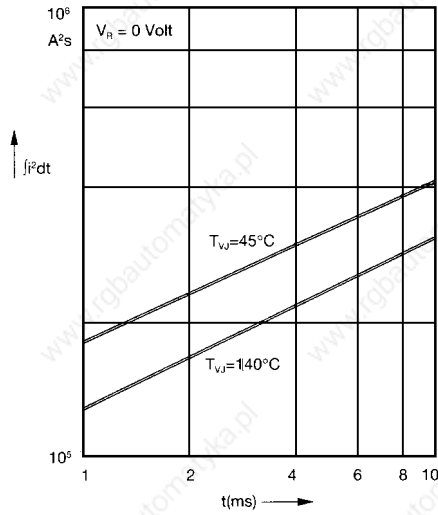


Fig. 4  $j^2dt$  versus time (1-10 ms)

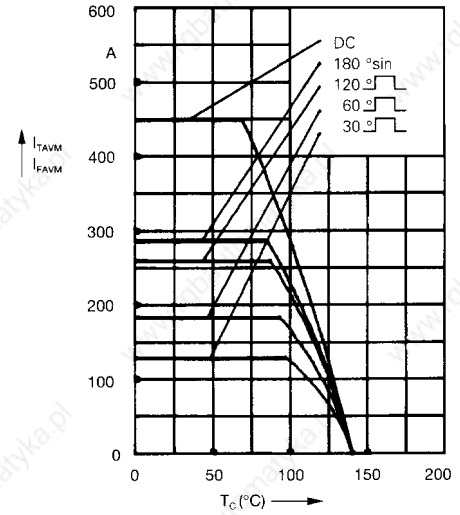


Fig. 4a Maximum forward current at case temperature

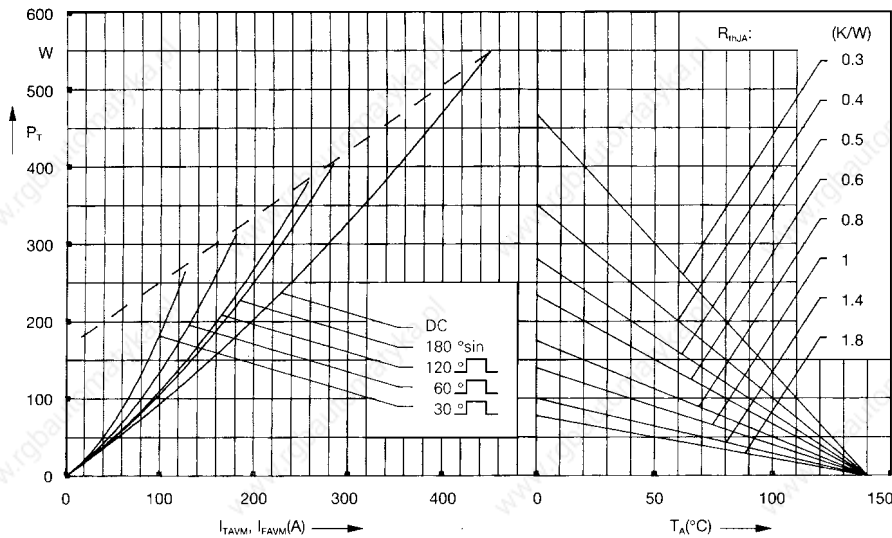


Fig. 5 Power dissipation versus on-state current and ambient temperature (per thyristor or diode)

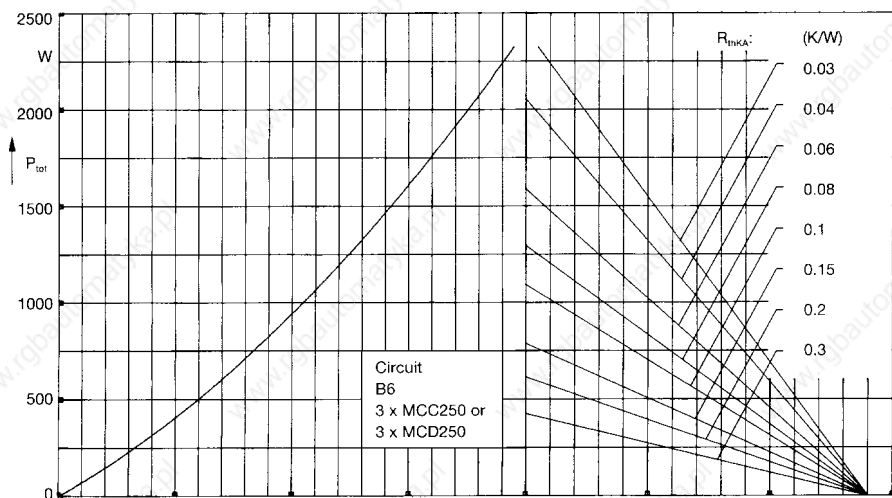


Fig. 6 Three phase rectifier bridge: Power dissipation versus direct output current and ambient temperature



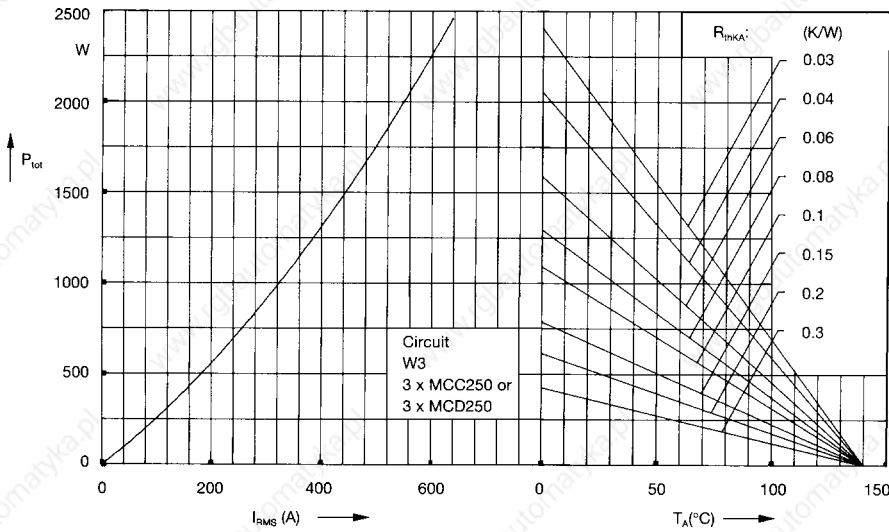


Fig. 7 Three phase AC-controller:  
Power dissipation versus RMS  
output current and ambient  
temperature

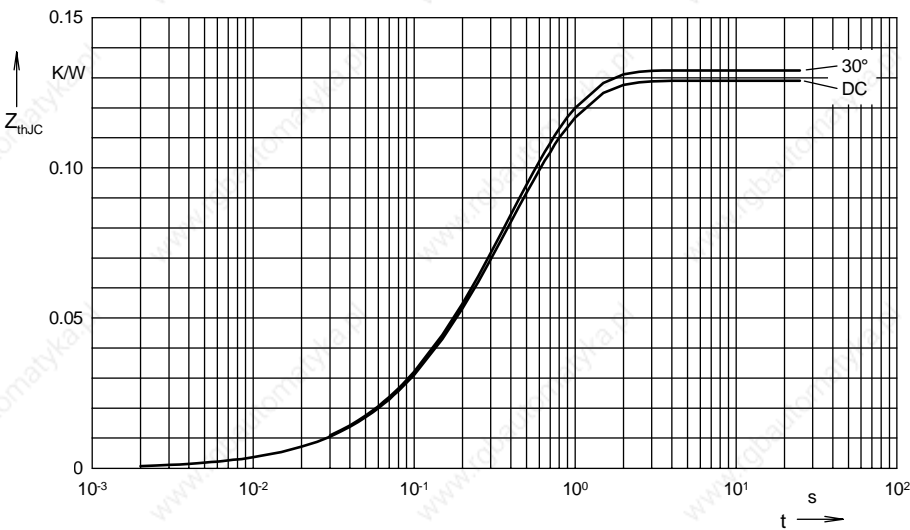


Fig. 8 Transient thermal impedance  
junction to case (per thyristor or  
diode)

$R_{thJC}$  for various conduction angles  $d$ :

$d$	$R_{thJC}$ (K/W)
DC	0.129
180°C	0.131
120°C	0.131
60°C	0.132
30°C	0.132

Constants for  $Z_{thJC}$  calculation:

$i$	$R_{thi}$ (K/W)	$t_i$ (s)
1	0.0035	0.099
2	0.0165	0.168
3	0.1091	0.456

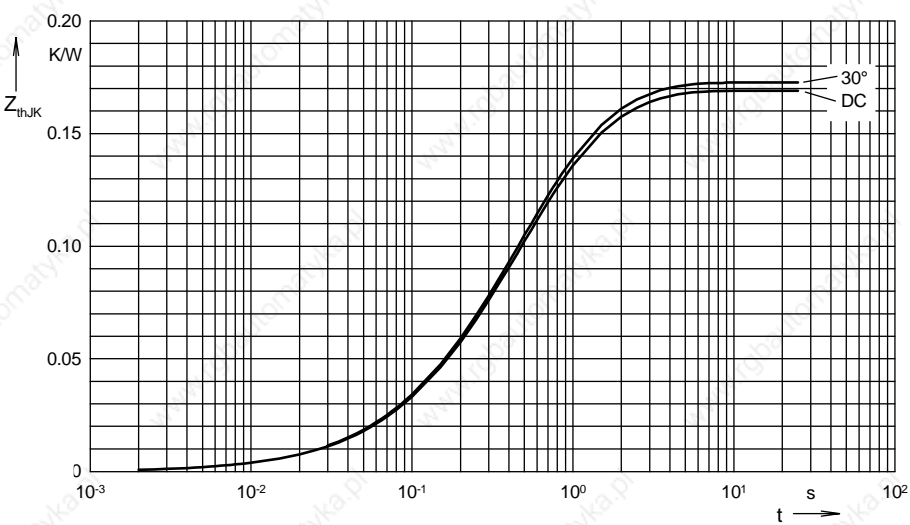


Fig. 9 Transient thermal impedance  
junction to heatsink (per thyristor  
or diode)

$R_{thJK}$  for various conduction angles  $d$ :

$d$	$R_{thJK}$ (K/W)
DC	0.169
180°C	0.171
120°C	0.172
60°C	0.172
30°C	0.173

Constants for  $Z_{thJK}$  calculation:

$i$	$R_{thi}$ (K/W)	$t_i$ (s)
1	0.0033	0.099
2	0.0159	0.168
3	0.1053	0.456
4	0.04	1.36

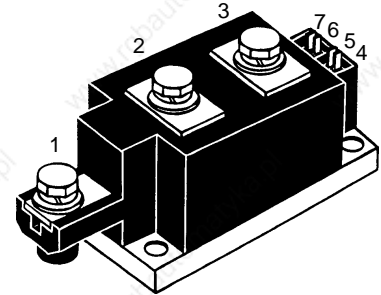
### Thyristor Modules Thyristor/Diode Modules

$$I_{TRMS} = 2x 450 A$$

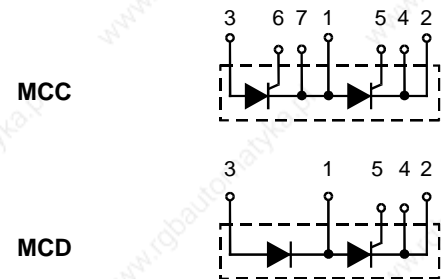
$$I_{TAVM} = 2x 250 A$$

$$V_{RRM} = 1200-1800 V$$

$V_{RSM}$ $V_{DSM}$ V	$V_{RRM}$ $V_{DRM}$ V	Type	
1300	1200	MCC 255-12io1	MCD 255-12io1
1500	1400	MCC 255-14io1	MCD 255-14io1
1700	1600	MCC 255-16io1	MCD 255-16io1
1900	1800	MCC 255-18io1	MCD 255-18io1



Symbol	Test Conditions	Maximum Ratings	
$I_{TRMS}$ , $I_{FRMS}$ $I_{TAVM}$ , $I_{FAVM}$	$T_{VJ} = T_{VJM}$ $T_C = 85^\circ C$ ; 180° sine	450	A
		250	A
$I_{TSM}$ , $I_{FSM}$	$T_{VJ} = 45^\circ C$ ; $V_R = 0$	t = 10 ms (50 Hz) t = 8.3 ms (60 Hz)	A A
	$T_{VJ} = T_{VJM}$ $V_R = 0$	t = 10 ms (50 Hz) t = 8.3 ms (60 Hz)	A A
$\int i^2 dt$	$T_{VJ} = 45^\circ C$ $V_R = 0$	t = 10 ms (50 Hz) t = 8.3 ms (60 Hz)	405 000 A <sup>2</sup> s 382 000 A <sup>2</sup> s
	$T_{VJ} = T_{VJM}$ $V_R = 0$	t = 10 ms (50 Hz) t = 8.3 ms (60 Hz)	304 000 A <sup>2</sup> s 307 000 A <sup>2</sup> s
$(di/dt)_{cr}$	$T_{VJ} = T_{VJM}$ f = 50 Hz, t <sub>p</sub> = 200 μs $V_D = 2/3 V_{DRM}$ $I_G = 1 A$ , di <sub>G</sub> /dt = 1 A/μs	repetitive, I <sub>T</sub> = 860 A non repetitive, I <sub>T</sub> = I <sub>TAVM</sub>	100 A/μs 500 A/μs
$(dv/dt)_{cr}$	$T_{VJ} = T_{VJM}$ ; $V_{DR} = 2/3 V_{DRM}$ R <sub>GK</sub> = ∞; method 1 (linear voltage rise)		1000 V/μs
$P_{GM}$	$T_{VJ} = T_{VJM}$ $I_T = I_{TAVM}$	t <sub>p</sub> = 30 μs t <sub>p</sub> = 500 μs	120 W 60 W 20 W 10 W
$P_{GAV}$ $V_{RGM}$			20 W 10 V
$T_{VJ}$ $T_{VJM}$ $T_{stg}$			-40...+130 °C 130 °C -40...+125 °C
$V_{ISOL}$	50/60 Hz, RMS $I_{ISOL} \leq 1 mA$	t = 1 min t = 1 s	3000 V~ 3600 V~
$M_d$	Mounting torque (M6) Terminal connection torque (M8)		4.5-7/40-62 Nm/lb.in. 11-13/97-115 Nm/lb.in.
Weight	Typical including screws		750 g



#### Features

- International standard package
- Direct copper bonded Al<sub>2</sub>O<sub>3</sub>-ceramic with copper base plate
- Planar passivated chips
- Isolation voltage 3600 V~
- UL registered E 72873
- Keyed gate/cathode twin pins

#### Applications

- Motor control, softstarter
- Power converter
- Heat and temperature control for industrial furnaces and chemical processes
- Lighting control
- Solid state switches

#### Advantages

- Simple mounting
- Improved temperature and power cycling
- Reduced protection circuits

Data according to IEC 60747 and refer to a single thyristor/diode unless otherwise stated. IXYS reserves the right to change limits, test conditions and dimensions

Symbol	Test Conditions	Characteristic Values
$I_{RRM}, I_{DRM}$	$T_{VJ} = T_{VJM}; V_R = V_{RRM}; V_D = V_{DRM}$	40 mA
$V_T, V_F$	$I_T, I_F = 600 \text{ A}; T_{VJ} = 25^\circ\text{C}$	1.36 V
$V_{T0}$	For power-loss calculations only ( $T_{VJ} = 130^\circ\text{C}$ )	0.8 V
$r_T$		0.68 mΩ
$V_{GT}$	$V_D = 6 \text{ V}; T_{VJ} = 25^\circ\text{C}$	2 V
	$T_{VJ} = -40^\circ\text{C}$	3 V
$I_{GT}$	$V_D = 6 \text{ V}; T_{VJ} = 25^\circ\text{C}$	150 mA
	$T_{VJ} = -40^\circ\text{C}$	220 mA
$V_{GD}$	$T_{VJ} = T_{VJM}; V_D = 2/3 V_{DRM}$	0.25 V
$I_{GD}$	$T_{VJ} = T_{VJM}; V_D = 2/3 V_{DRM}$	10 mA
$I_L$	$T_{VJ} = 25^\circ\text{C}; t_p = 30 \mu\text{s}; V_D = 6 \text{ V}$ $I_G = 0.45 \text{ A}; di_G/dt = 0.45 \text{ A}/\mu\text{s}$	200 mA
$I_H$	$T_{VJ} = 25^\circ\text{C}; V_D = 6 \text{ V}; R_{GK} = \infty$	150 mA
$t_{gd}$	$T_{VJ} = 25^\circ\text{C}; V_D = 1/2 V_{DRM}$ $I_G = 1 \text{ A}; di_G/dt = 1 \text{ A}/\mu\text{s}$	2 μs
$t_q$	$T_{VJ} = T_{VJM}; I_T = 300 \text{ A}, t_p = 200 \mu\text{s}; -di/dt = 10 \text{ A}/\mu\text{s}$ typ. $V_R = 100 \text{ V}; dv/dt = 50 \text{ V}/\mu\text{s}; V_D = 2/3 V_{DRM}$	200 μs
$Q_S$	$T_{VJ} = 125^\circ\text{C}; I_T, I_F = 300 \text{ A}; -di/dt = 50 \text{ A}/\mu\text{s}$	760 μC
$I_{RM}$		275 A
$R_{thJC}$	per thyristor (diode); DC current per module	0.140 K/W
$R_{thJK}$	per thyristor (diode); DC current per module	0.07 K/W 0.18 K/W 0.09 K/W
	other values see Fig. 8/9	
$d_s$	Creeping distance on surface	12.7 mm
$d_A$	Creepage distance in air	9.6 mm
$a$	Maximum allowable acceleration	50 m/s <sup>2</sup>

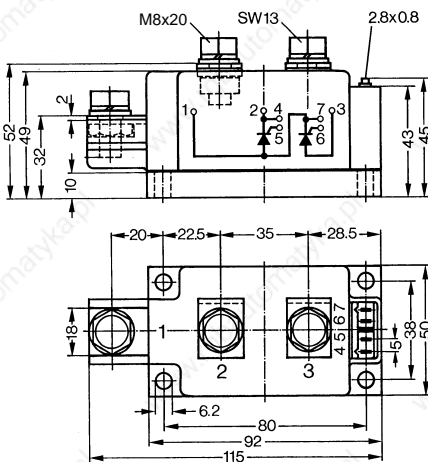
### Optional accessories for modules

Keyed Gate/Cathode twin plugs with wire length = 350 mm, gate = yellow, cathode = red

Type ZY 180 L (L = Left for pin pair 4/5) } UL 758, style 1385,  
Type ZY 180 R (R = Right for pin pair 6/7) } CSA class 5851, guide 460-1-1

### Dimensions in mm (1 mm = 0.0394")

#### MCC 255



#### MCD 255

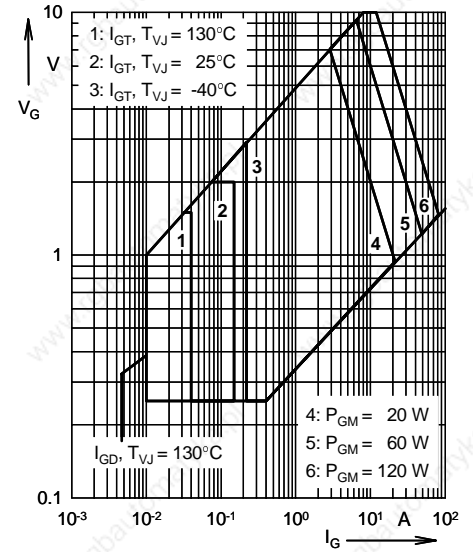
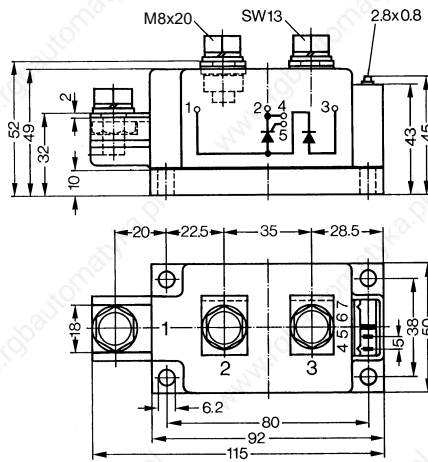


Fig. 1 Gate trigger characteristics

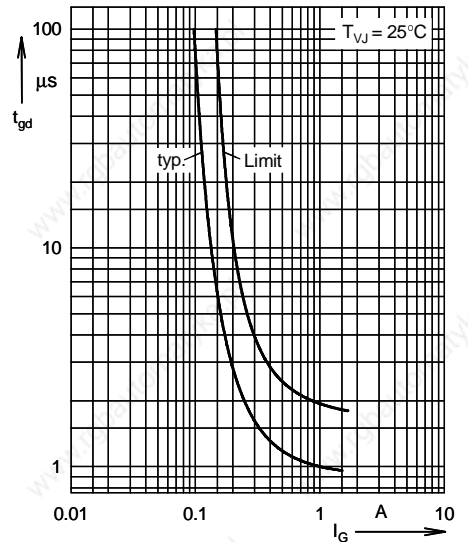


Fig. 2 Gate trigger delay time

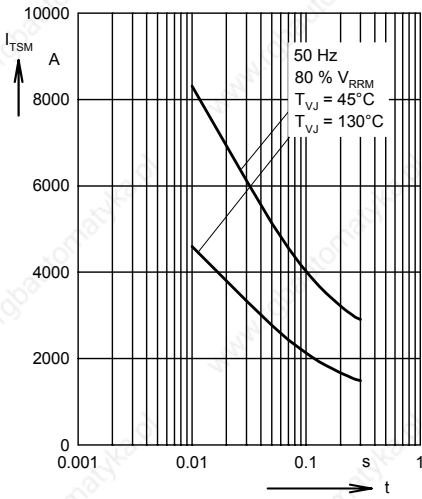


Fig. 3 Surge overload current  
 $I_{TSM}$ ,  $I_{FSM}$ : Crest value,  $t$ : duration

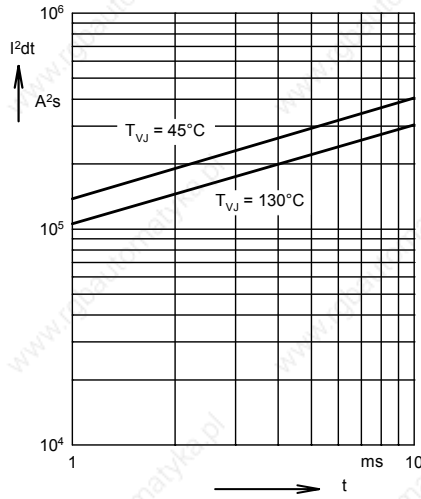


Fig. 4  $\int i^2 dt$  versus time (1-10 ms)

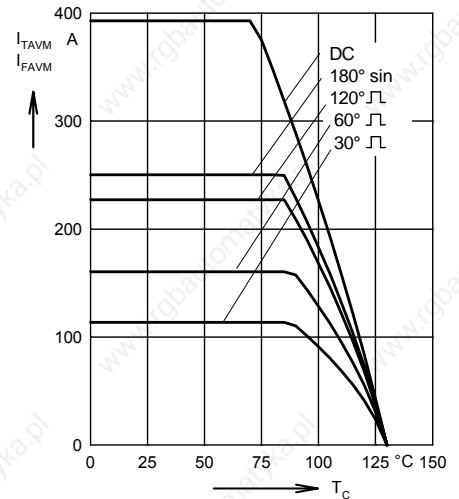


Fig. 4a Maximum forward current at case temperature

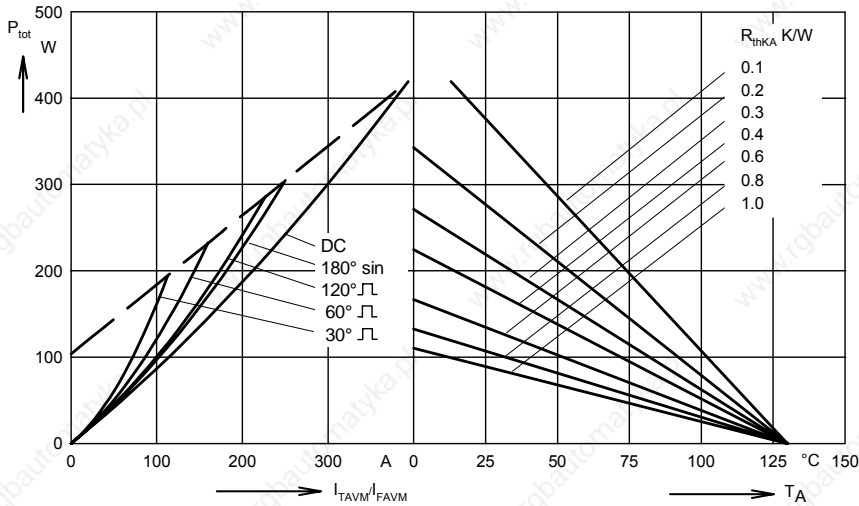


Fig. 5 Power dissipation versus on-state current and ambient temperature (per thyristor or diode)

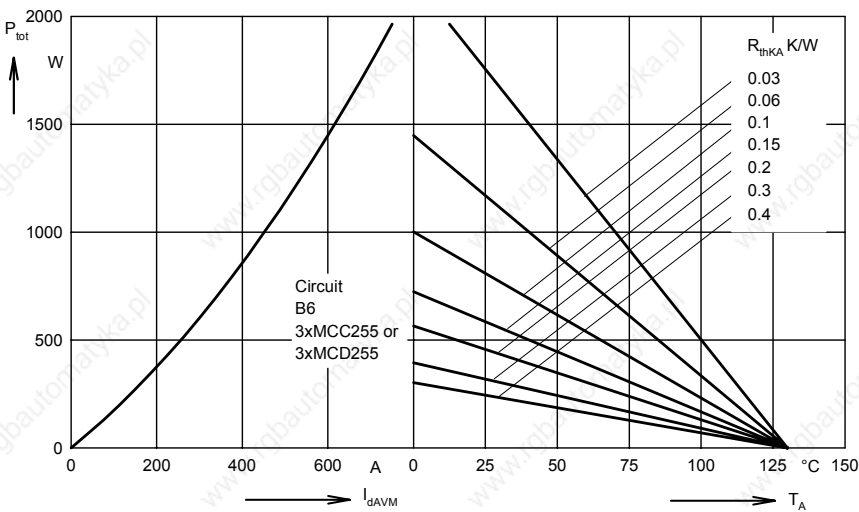


Fig. 6 Three phase rectifier bridge: Power dissipation versus direct output current and ambient temperature

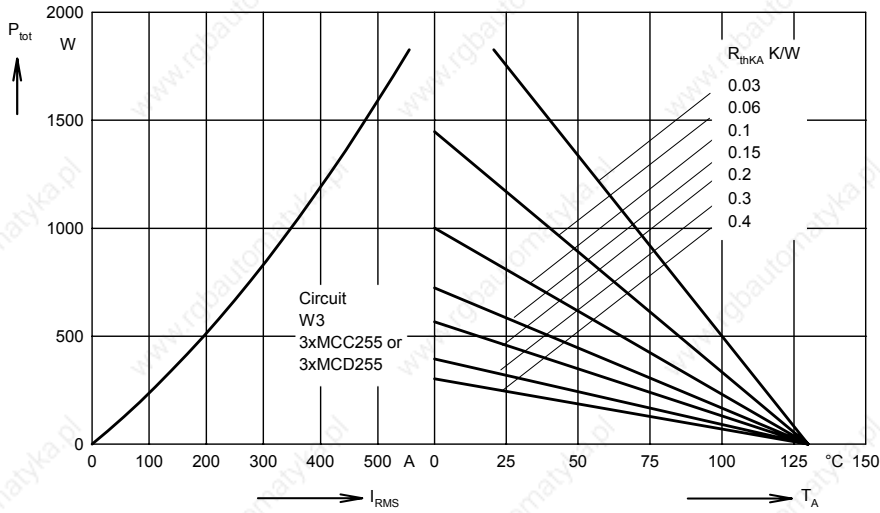


Fig. 7 Three phase AC-controller:  
Power dissipation versus RMS  
output current and ambient  
temperature

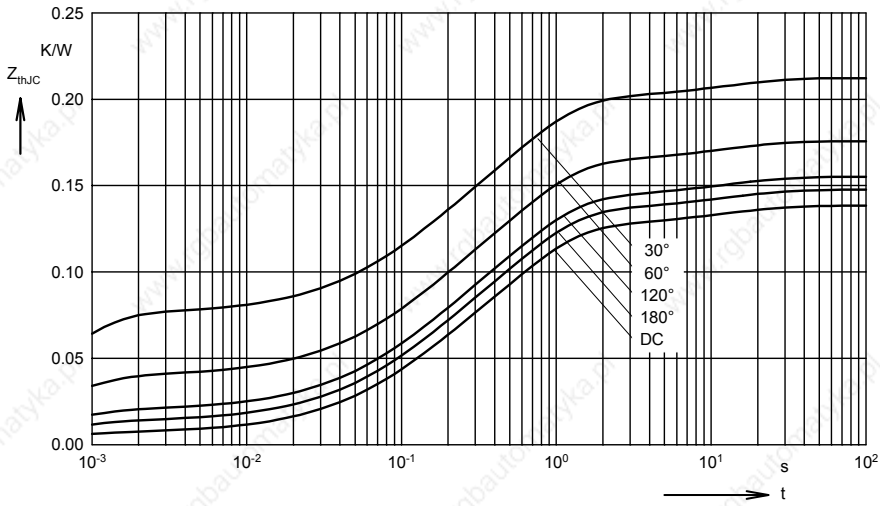


Fig. 8 Transient thermal impedance  
junction to case (per thyristor or  
diode)

$R_{thJC}$  for various conduction angles d:

d	$R_{thJC}$ (K/W)
DC	0.139
180°	0.148
120°	0.156
60°	0.176
30°	0.214

Constants for  $Z_{thJC}$  calculation:

i	$R_{thi}$ (K/W)	$t_i$ (s)
1	0.0066	0.00054
2	0.0358	0.098
3	0.0831	0.54
4	0.0129	12

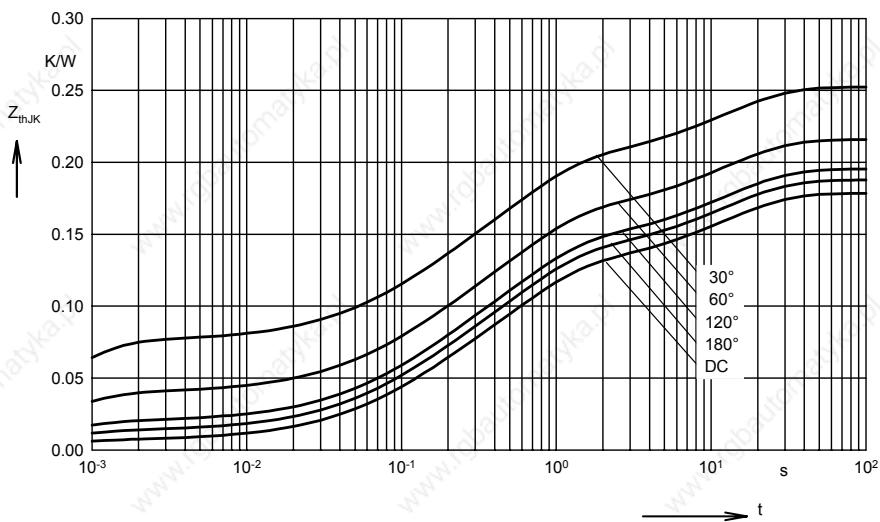


Fig. 9 Transient thermal impedance  
junction to heatsink (per thyristor  
or diode)

$R_{thJK}$  for various conduction angles d:

d	$R_{thJK}$ (K/W)
DC	0.179
180°	0.188
120°	0.196
60°	0.216
30°	0.254

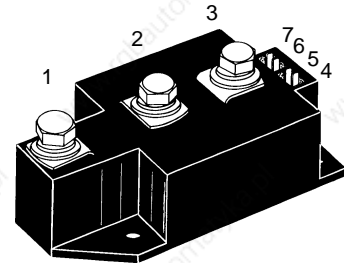
Constants for  $Z_{thJK}$  calculation:

i	$R_{thi}$ (K/W)	$t_i$ (s)
1	0.0066	0.00054
2	0.0358	0.098
3	0.0831	0.54
4	0.0129	12
5	0.04	12

### Thyristor Modules Thyristor/Diode Modules

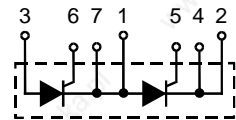
$I_{TRMS} = 2 \times 500 \text{ A}$   
 $I_{TAVM} = 2 \times 320 \text{ A}$   
 $V_{RRM} = 800-2200 \text{ V}$

$V_{RSM}$ $V_{DSM}$ V	$V_{RRM}$ $V_{DRM}$ V	Type	Version 1	Version 1
900	800	MCC 310-08io1	MCC 310-08io1	MCD 310-08io1
1300	1200	MCC 310-12io1	MCC 310-12io1	MCD 310-12io1
1500	1400	MCC 310-14io1	MCC 310-14io1	MCD 310-14io1
1700	1600	MCC 310-16io1	MCC 310-16io1	MCD 310-16io1
1900	1800	MCC 310-18io1	MCC 310-18io1	MCD 310-18io1

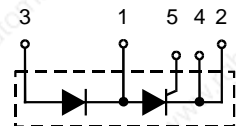


Symbol	Test Conditions	Maximum Ratings
$I_{TRMS}^1$ , $I_{FRMS}$ $I_{TAVM}^2$ , $I_{FAVM}$	$T_{VJ} = T_{VJM}$ $T_C = 85^\circ\text{C}$ ; 180° sine	500 A 320 A
$I_{TSM}^3$ , $I_{FSM}$	$T_{VJ} = 45^\circ\text{C}$ ; $V_R = 0$	$t = 10 \text{ ms}$ (50 Hz), sine 9200 A $t = 8.3 \text{ ms}$ (60 Hz), sine 9800 A
	$T_{VJ} = T_{VJM}$ $V_R = 0$	$t = 10 \text{ ms}$ (50 Hz), sine 8000 A $t = 8.3 \text{ ms}$ (60 Hz), sine 8600 A
$j_i^2 dt$	$T_{VJ} = 45^\circ\text{C}$ $V_R = 0$	$t = 10 \text{ ms}$ (50 Hz), sine 420 000 A <sup>2</sup> s $t = 8.3 \text{ ms}$ (60 Hz), sine 400 000 A <sup>2</sup> s
	$T_{VJ} = T_{VJM}$ $V_R = 0$	$t = 10 \text{ ms}$ (50 Hz), sine 320 000 A <sup>2</sup> s $t = 8.3 \text{ ms}$ (60 Hz), sine 306 000 A <sup>2</sup> s
$(di/dt)_{cr}$	$T_{VJ} = T_{VJM}$ $f = 50 \text{ Hz}$ , $t_p = 200 \mu\text{s}$ $V_D = 2/3 V_{DRM}$ $I_G = 1 \text{ A}$ $di_G/dt = 1 \text{ A}/\mu\text{s}$	repetitive, $I_T = 960 \text{ A}$ 100 A/ $\mu\text{s}$ non repetitive, $I_T = 320 \text{ A}$ 500 A/ $\mu\text{s}$
$(dv/dt)_{cr}$	$T_{VJ} = T_{VJM}$ ; $R_{GK} = \infty$ ; method 1 (linear voltage rise)	$V_{DR} = 2/3 V_{DRM}$ 1000 V/ $\mu\text{s}$
$P_{GM}$	$T_{VJ} = T_{VJM}$ $I_T = I_{TAVM}$	$t_p = 30 \mu\text{s}$ 120 W $t_p = 500 \mu\text{s}$ 60 W
$P_{GAV}$		20 W
$V_{RGM}$		10 V
$T_{VJ}$		-40...+140 °C
$T_{VJM}$		140 °C
$T_{stg}$		-40...+125 °C
$V_{ISOL}$	50/60 Hz, RMS $I_{ISOL} \leq 1 \text{ mA}$	$t = 1 \text{ min}$ 3000 V~ $t = 1 \text{ s}$ 3600 V~
$M_d$	Mounting torque (M5) Terminal connection torque (M8)	2.5-5/22-44 Nm/lb.in. 12-15/106-132 Nm/lb.in.
Weight	Typical including screws	320 g

MCC



MCD



#### Features

- International standard package
- Direct copper bonded Al<sub>2</sub>O<sub>3</sub> -ceramic base plate
- Planar passivated chips
- Isolation voltage 3600 V~
- UL registered, E 72873
- Keyed gate/cathode twin pins

#### Applications

- Motor control
- Power converter
- Heat and temperature control for industrial furnaces and chemical processes
- Lighting control
- Contactless switches

#### Advantages

- Space and weight savings
- Simple mounting
- Improved temperature and power cycling
- Reduced protection circuits

Data according to IEC 60747 and refer to a single thyristor/diode unless otherwise stated.  
IXYS reserves the right to change limits, test conditions and dimensions



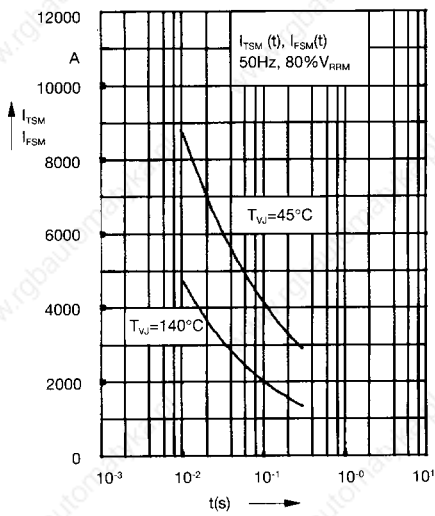


Fig. 3 Surge overload current  
 $I_{TSM}, I_{FSM}$ : Crest value,  $t$ : duration

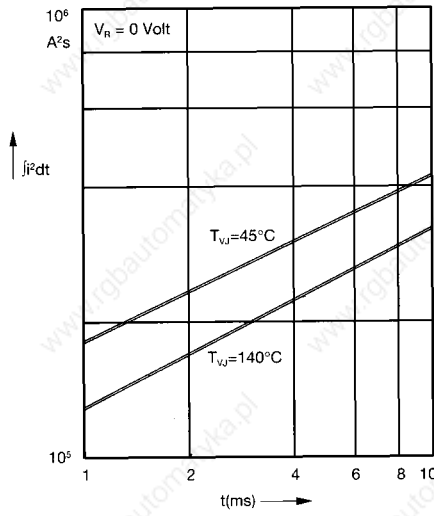


Fig. 4  $\int j^2 dt$  versus time (1-10 ms)

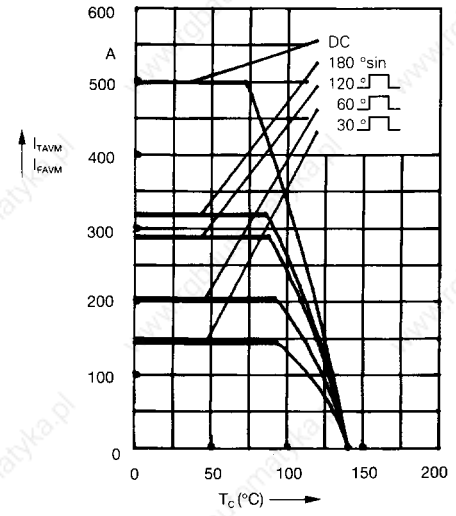


Fig. 4a Maximum forward current at case temperature

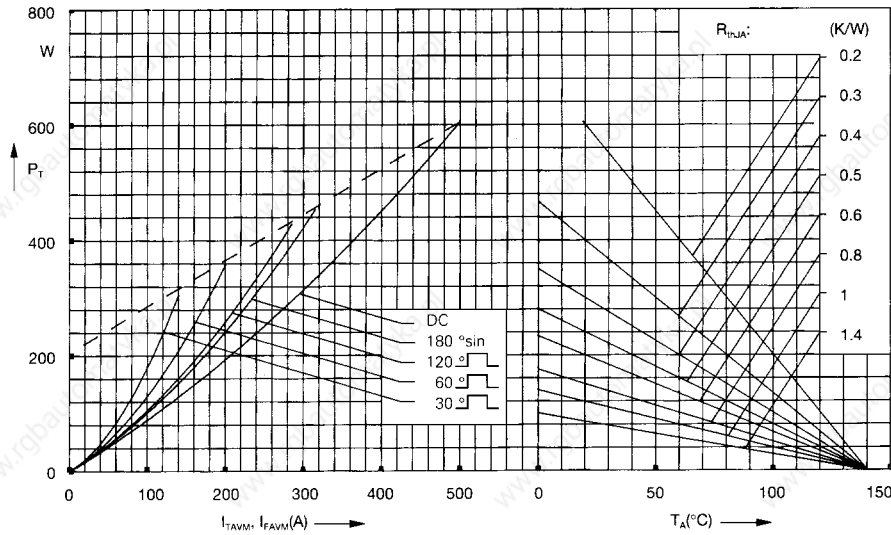


Fig. 5 Power dissipation versus on-state current and ambient temperature (per thyristor or diode)

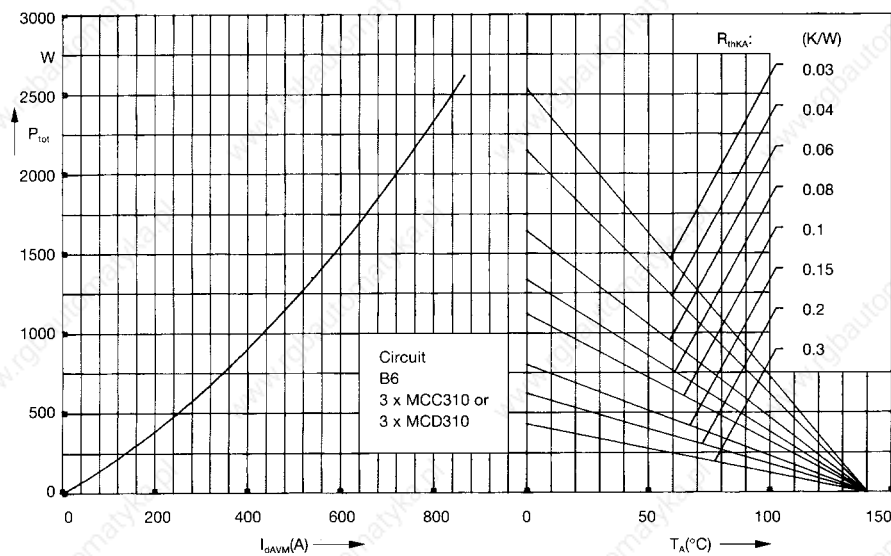


Fig. 6 Three phase rectifier bridge: Power dissipation versus direct output current and ambient temperature



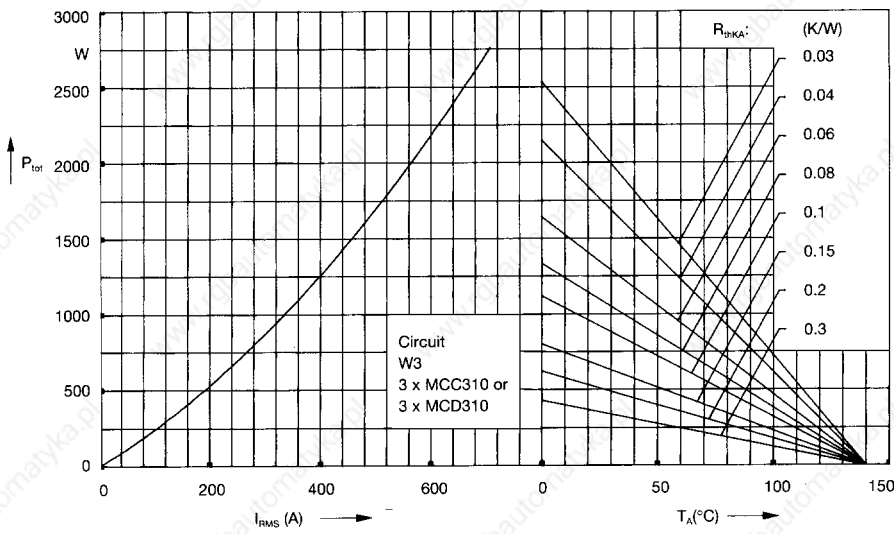


Fig. 7 Three phase AC-controller: Power dissipation versus RMS output current and ambient temperature

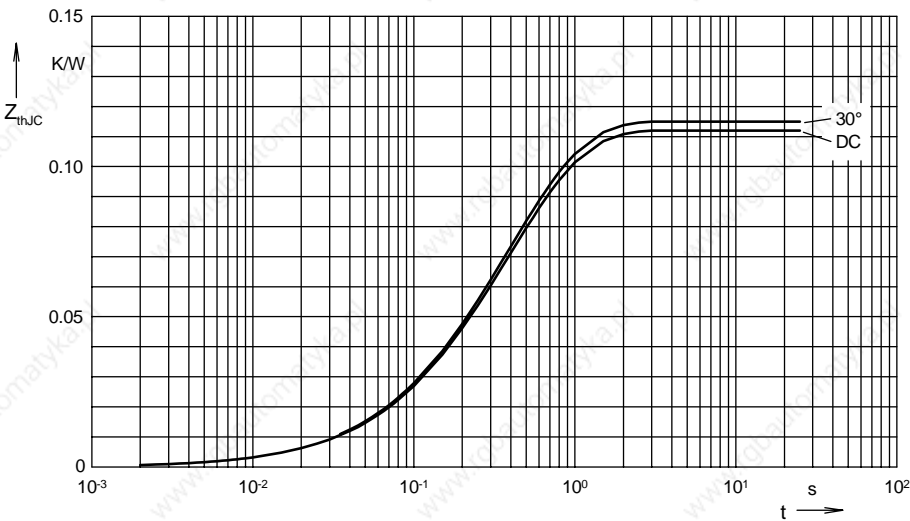


Fig. 8 Transient thermal impedance junction to case (per thyristor or diode)

$R_{thJC}$  for various conduction angles  $d$ :

$d$	$R_{thJC}$ (K/W)
DC	0.112
180°C	0.113
120°C	0.114
60°C	0.115
30°C	0.115

Constants for  $Z_{thJC}$  calculation:

$i$	$R_{thi}$ (K/W)	$t_i$ (s)
1	0.003	0.099
2	0.0143	0.168
3	0.0947	0.456

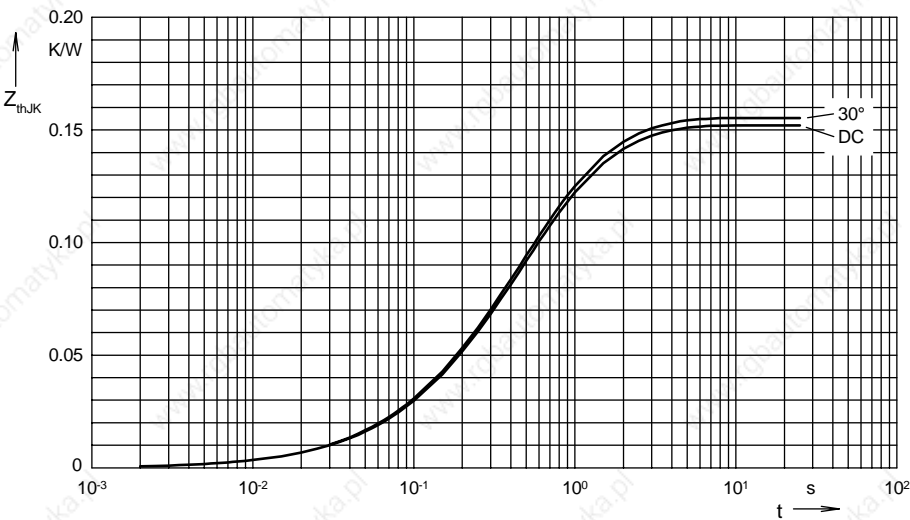


Fig. 9 Transient thermal impedance junction to heatsink (per thyristor or diode)

$R_{thJK}$  for various conduction angles  $d$ :

$d$	$R_{thJK}$ (K/W)
DC	0.152
180°C	0.154
120°C	0.154
60°C	0.155
30°C	0.155

Constants for  $Z_{thJK}$  calculation:

$i$	$R_{thi}$ (K/W)	$t_i$ (s)
1	0.003	0.099
2	0.0143	0.168
3	0.0947	0.456
4	0.04	1.36

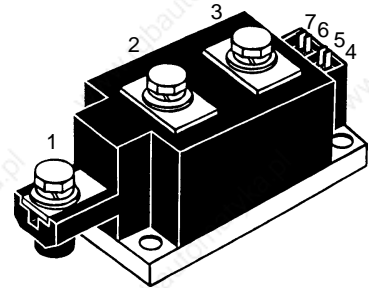
## Thyristor Modules Thyristor/Diode Modules

$$I_{TRMS} = 2x 520 A$$

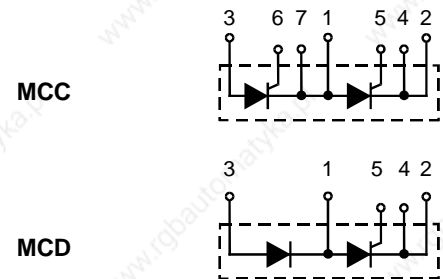
$$I_{TAVM} = 2x 320 A$$

$$V_{RRM} = 1200-1800 V$$

$V_{RSM}$	$V_{RRM}$	Type	
$V_{DSM}$	$V_{DRM}$		
V	V		
1300	1200	MCC 312-12io1	MCD 312-12io1
1500	1400	MCC 312-14io1	MCD 312-14io1
1700	1600	MCC 312-16io1	MCD 312-16io1
1900	1800	MCC 312-18io1	MCD 312-18io1



Symbol	Test Conditions	Maximum Ratings	
$I_{TRMS}, I_{FRMS}$ $I_{TAVM}, I_{FAVM}$	$T_{VJ} = T_{VJM}$ $T_C = 85^\circ C; 180^\circ$ sine	520	A
		320	A
$I_{TSM}, I_{FSM}$	$T_{VJ} = 45^\circ C;$ $V_R = 0$	$t = 10$ ms (50 Hz)	A
		$t = 8.3$ ms (60 Hz)	A
	$T_{VJ} = T_{VJM}$ $V_R = 0$	$t = 10$ ms (50 Hz)	A
		$t = 8.3$ ms (60 Hz)	A
$\int i^2 dt$	$T_{VJ} = 45^\circ C$ $V_R = 0$	$t = 10$ ms (50 Hz)	$A^2s$
		$t = 8.3$ ms (60 Hz)	$A^2s$
	$T_{VJ} = T_{VJM}$ $V_R = 0$	$t = 10$ ms (50 Hz)	$A^2s$
		$t = 8.3$ ms (60 Hz)	$A^2s$
$(di/dt)_{cr}$	$T_{VJ} = T_{VJM}$ $f = 50$ Hz, $t_p = 200$ $\mu s$ $V_D = 2/3 V_{DRM}$ $I_G = 1$ A, $di_G/dt = 1$ A/ $\mu s$	repetitive, $I_T = 960$ A	100 $A/\mu s$
		non repetitive, $I_T = I_{TAVM}$	500 $A/\mu s$
$(dv/dt)_{cr}$	$T_{VJ} = T_{VJM}; V_{DR} = 2/3 V_{DRM}$ $R_{GK} = \infty;$ method 1 (linear voltage rise)		1000 $V/\mu s$
$P_{GM}$	$T_{VJ} = T_{VJM}$ $I_T = I_{TAVM}$	$t_p = 30$ $\mu s$	120 W
		$t_p = 500$ $\mu s$	60 W
$P_{GAV}$			20 W
$V_{RGM}$			10 V
$T_{VJ}$			-40...+140 $^\circ C$
$T_{VJM}$			140 $^\circ C$
$T_{stg}$			-40...+125 $^\circ C$
$V_{ISOL}$	50/60 Hz, RMS	$t = 1$ min	3000 V~
	$I_{ISOL} \leq 1$ mA	$t = 1$ s	3600 V~
$M_d$	Mounting torque (M6)	4.5-7/40-62	Nm/lb.in.
	Terminal connection torque (M8)	11-13/97-115	Nm/lb.in.
Weight	Typical including screws	750	g



### Features

- International standard package
- Direct copper bonded  $Al_2O_3$ -ceramic with copper base plate
- Planar passivated chips
- Isolation voltage 3600 V~
- UL registered E 72873
- Keyed gate/cathode twin pins

### Applications

- Motor control, softstarter
- Power converter
- Heat and temperature control for industrial furnaces and chemical processes
- Lighting control
- Solid state switches

### Advantages

- Simple mounting
- Improved temperature and power cycling
- Reduced protection circuits

Data according to IEC 60747 and refer to a single thyristor/diode unless otherwise stated. IXYS reserves the right to change limits, test conditions and dimensions

Symbol	Test Conditions	Characteristic Values
$I_{RRM}, I_{DRM}$	$T_{VJ} = T_{VJM}; V_R = V_{RRM}; V_D = V_{DRM}$	40 mA
$V_T, V_F$	$I_T, I_F = 600 \text{ A}; T_{VJ} = 25^\circ\text{C}$	1.32 V
$V_{T0}$	For power-loss calculations only ( $T_{VJ} = 140^\circ\text{C}$ )	0.8 V
$r_T$		0.68 mΩ
$V_{GT}$	$V_D = 6 \text{ V}; T_{VJ} = 25^\circ\text{C}$	2 V
	$T_{VJ} = -40^\circ\text{C}$	3 V
$I_{GT}$	$V_D = 6 \text{ V}; T_{VJ} = 25^\circ\text{C}$	150 mA
	$T_{VJ} = -40^\circ\text{C}$	220 mA
$V_{GD}$	$T_{VJ} = T_{VJM}; V_D = 2/3 V_{DRM}$	0.25 V
$I_{GD}$	$T_{VJ} = T_{VJM}; V_D = 2/3 V_{DRM}$	10 mA
$I_L$	$T_{VJ} = 25^\circ\text{C}; t_p = 30 \mu\text{s}; V_D = 6 \text{ V}$ $I_G = 0.45 \text{ A}; di_G/dt = 0.45 \text{ A}/\mu\text{s}$	200 mA
$I_H$	$T_{VJ} = 25^\circ\text{C}; V_D = 6 \text{ V}; R_{GK} = \infty$	150 mA
$t_{gd}$	$T_{VJ} = 25^\circ\text{C}; V_D = 1/2 V_{DRM}$ $I_G = 1 \text{ A}; di_G/dt = 1 \text{ A}/\mu\text{s}$	2 μs
$t_q$	$T_{VJ} = T_{VJM}; I_T = 300 \text{ A}, t_p = 200 \mu\text{s}; -di/dt = 10 \text{ A}/\mu\text{s}$ typ. $V_R = 100 \text{ V}; dv/dt = 50 \text{ V}/\mu\text{s}; V_D = 2/3 V_{DRM}$	200 μs
$Q_S$	$T_{VJ} = 125^\circ\text{C}; I_T, I_F = 300 \text{ A}; -di/dt = 50 \text{ A}/\mu\text{s}$	760 μC
$I_{RM}$		275 A
$R_{thJC}$	per thyristor (diode); DC current per module	0.12 K/W
$R_{thJK}$	per thyristor (diode); DC current per module	0.06 K/W
	other values see Fig. 8/9	0.16 K/W
		0.08 K/W
$d_s$	Creeping distance on surface	12.7 mm
$d_A$	Creepage distance in air	9.6 mm
$a$	Maximum allowable acceleration	50 m/s <sup>2</sup>

Optional accessories for modules

Keyed Gate/Cathode twin plugs with wire length = 350 mm, gate = yellow, cathode = red

Type ZY 180 L (L = Left for pin pair 4/5)

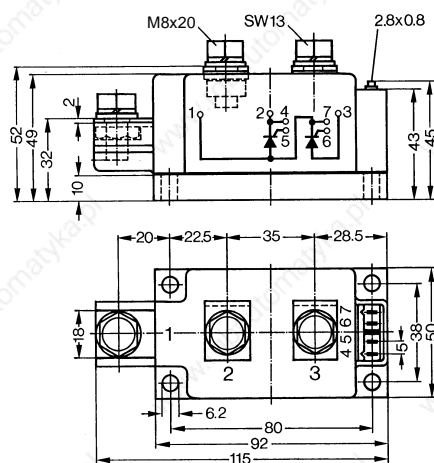
UL 758, style 1385,

Type ZY 180 R (R = Right for pin pair 6/7)

CSA class 5851, guide 460-1-1

### Dimensions in mm (1 mm = 0.0394")

#### MCC



#### MCD

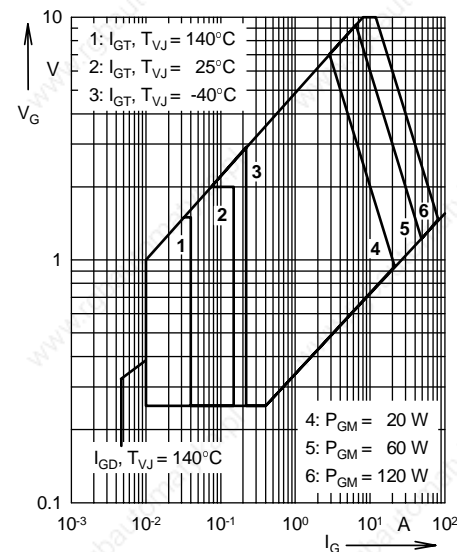
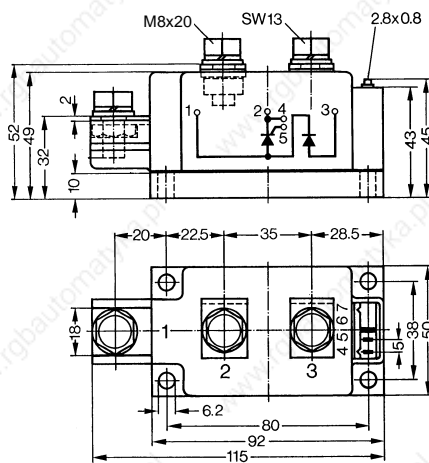


Fig. 1 Gate trigger characteristics

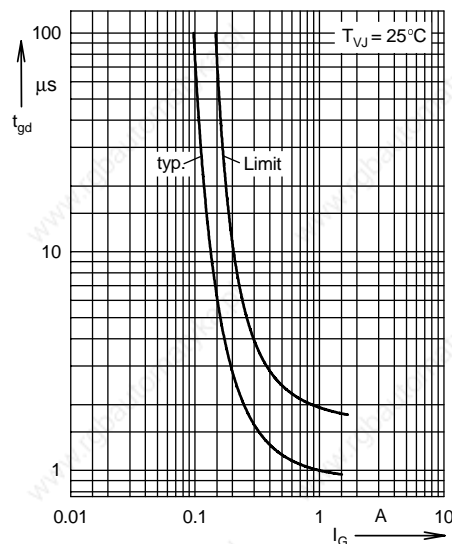


Fig. 2 Gate trigger delay time

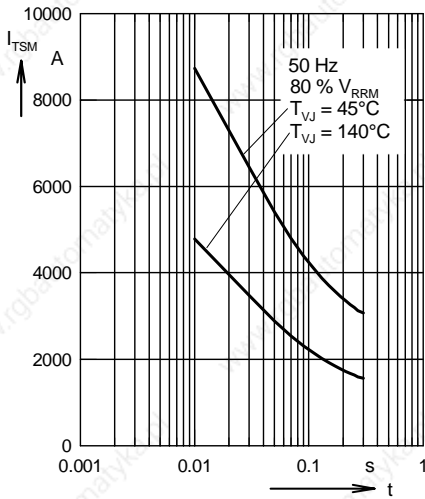


Fig. 3 Surge overload current  
 $I_{TSM}$ ,  $I_{FSM}$ : Crest value, t: duration

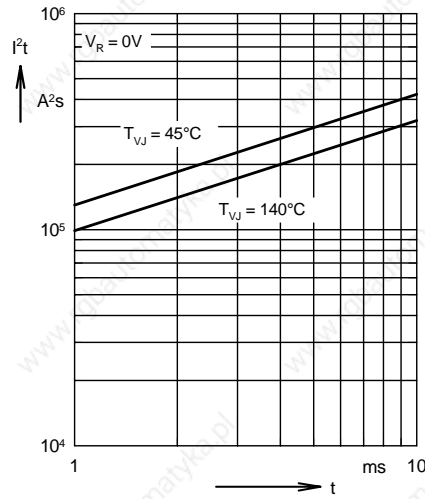


Fig. 4  $I^2t$  versus time (1-10 ms)

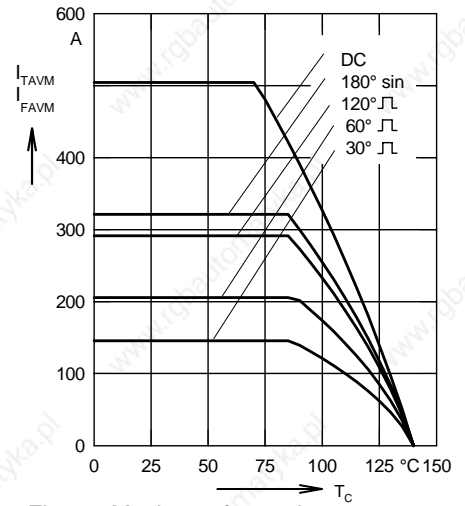


Fig. 4a Maximum forward current at case temperature

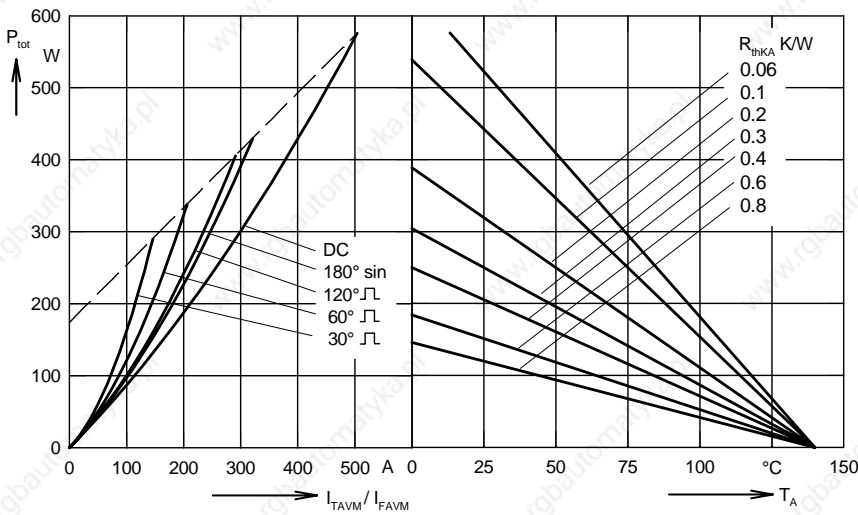


Fig. 5 Power dissipation versus on-state current and ambient temperature (per thyristor or diode)

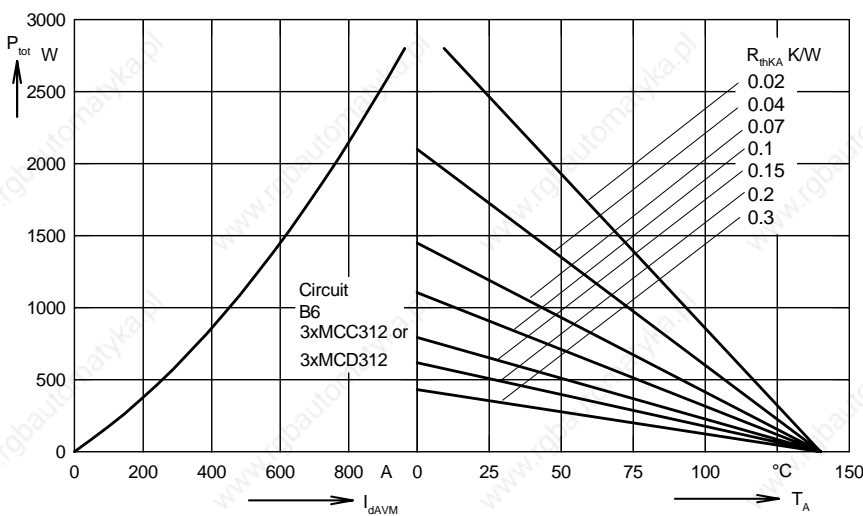


Fig. 6 Three phase rectifier bridge: Power dissipation versus direct output current and ambient temperature

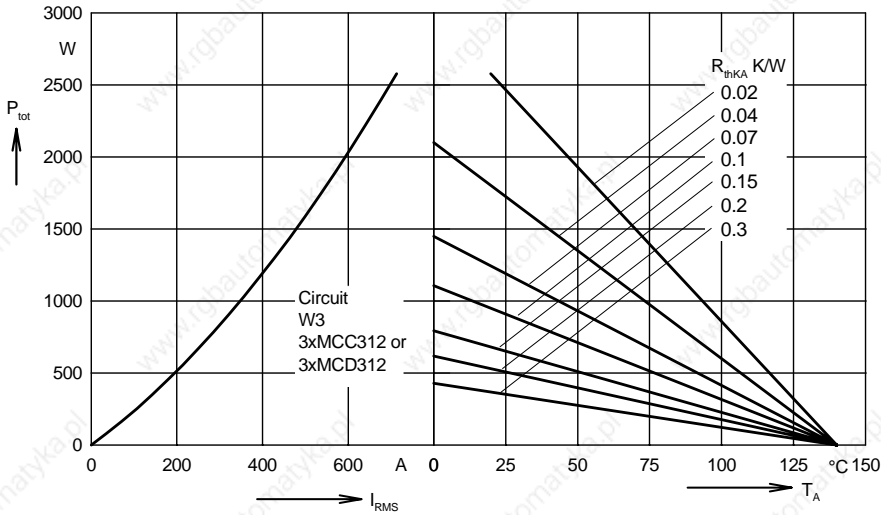


Fig. 7 Three phase AC-controller:  
Power dissipation versus RMS  
output current and ambient  
temperature

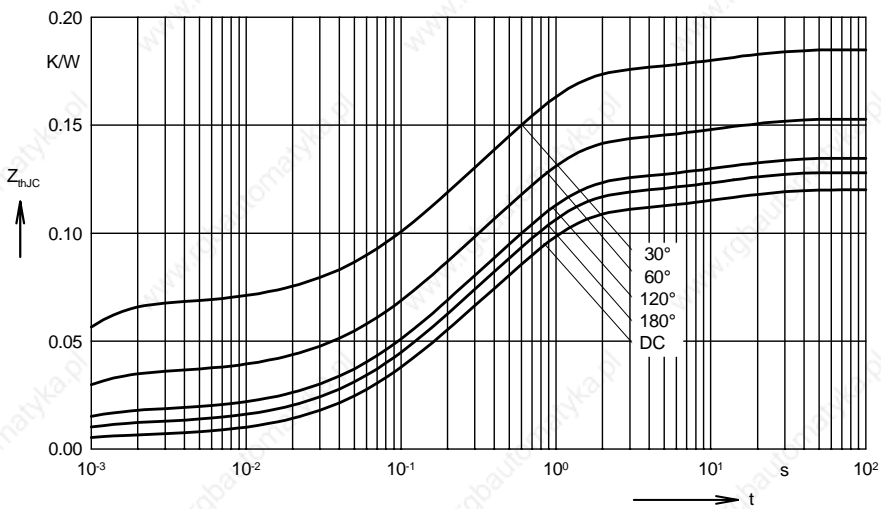


Fig. 8 Transient thermal impedance  
junction to case (per thyristor or  
diode)

$R_{thJC}$  for various conduction angles  $d$ :

$d$	$R_{thJC}$ (K/W)
DC	0.120
180°	0.128
120°	0.135
60°	0.153
30°	0.185

Constants for  $Z_{thJC}$  calculation:

$i$	$R_{thi}$ (K/W)	$t_i$ (s)
1	0.0058	0.00054
2	0.031	0.098
3	0.072	0.54
4	0.0112	12

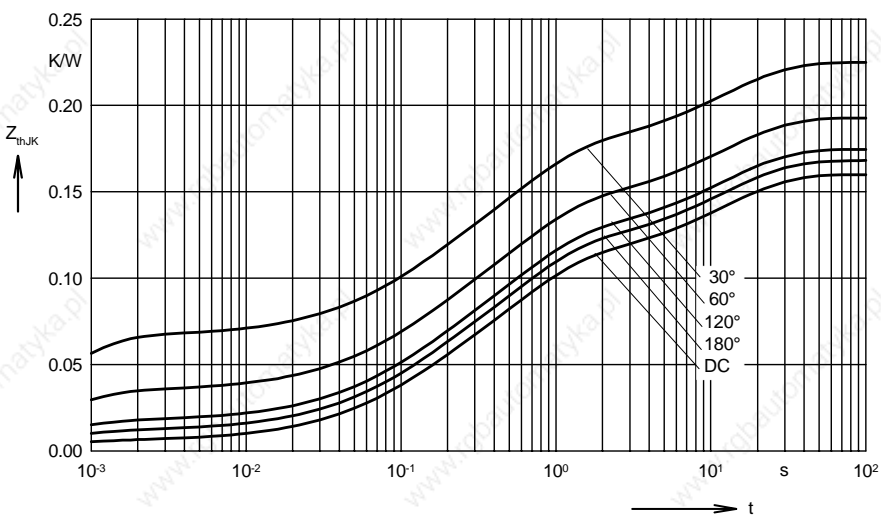


Fig. 9 Transient thermal impedance  
junction to heatsink (per thyristor  
or diode)

$R_{thJK}$  for various conduction angles  $d$ :

$d$	$R_{thJK}$ (K/W)
DC	0.160
180°	0.168
120°	0.175
60°	0.193
30°	0.225

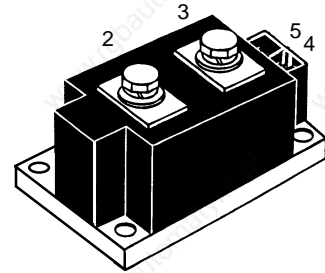
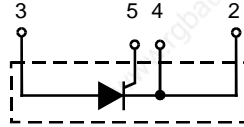
Constants for  $Z_{thJK}$  calculation:

$i$	$R_{thi}$ (K/W)	$t_i$ (s)
1	0.0058	0.00054
2	0.031	0.098
3	0.072	0.54
4	0.0112	12
5	0.04	12

# High Power Single Thyristor Module

$I_{TRMS} = 750 \text{ A}$   
 $I_{TAV} = 464 \text{ A}$   
 $V_{RRM} = 2000-2200 \text{ V}$

$V_{RSM}$	$V_{RRM}$	Type
$V_{DSM}$	$V_{DRM}$	
V	V	
2100	2000	MCO 450-20io1
2300	2200	MCO 450-22io1



Symbol	Test Conditions	Maximum Ratings	
$I_{TRMS}$	$T_{VJ} = T_{VJM}$	750 A	
$I_{TAV}$	$T_C = 85^\circ\text{C}; 180^\circ \text{ sine}$	464 A	
$I_{TSM}$	$T_{VJ} = 45^\circ\text{C}$ $V_R = 0$	$t = 10 \text{ ms (50 Hz)}$ $t = 8.3 \text{ ms (60 Hz)}$	15000 A 16000 A
	$T_{VJ} = T_{VJM}$ $V_R = 0$	$t = 10 \text{ ms (50 Hz)}$ $t = 8.3 \text{ ms (60 Hz)}$	13000 A 14400 A
$I^2t$	$T_{VJ} = 45^\circ\text{C}$ $V_R = 0$	$t = 10 \text{ ms (50 Hz)}$ $t = 8.3 \text{ ms (60 Hz)}$	1125000 $\text{A}^2\text{s}$ 1062000 $\text{A}^2\text{s}$
	$T_{VJ} = T_{VJM}$ $V_R = 0$	$t = 10 \text{ ms (50 Hz)}$ $t = 8.3 \text{ ms (60 Hz)}$	845000 $\text{A}^2\text{s}$ 813000 $\text{A}^2\text{s}$
$(di/dt)_{cr}$	$T_{VJ} = T_{VJM}$ repetitive, $I_T = 960 \text{ A}$ $f = 50 \text{ Hz}, t_p = 200 \mu\text{s}$ $V_D = 2/3 V_{DRM}$		100 $\text{A}/\mu\text{s}$
	$I_G = 1 \text{ A}$ , non repetitive, $I_T = I_{TAVM}$ $di_G/dt = 1 \text{ A}/\mu\text{s}$		500 $\text{A}/\mu\text{s}$
$(dv/dt)_{cr}$	$T_{VJ} = T_{VJM}; V_{DR} = 2/3 V_{DRM}$ $R_{GK} = \infty$ ; method 1 (linear voltage rise)		1000 $\text{V}/\mu\text{s}$
$P_{GM}$	$T_{VJ} = T_{VJM}$ $I_T = I_{TAVM}$	$t_p = 30 \mu\text{s}$ $t_p = 500 \mu\text{s}$	120 W 60 W
$P_{GAV}$			30 W
$V_{RGM}$			10 V
$T_{VJ}$			-40...130 $^\circ\text{C}$
$T_{VJM}$			130 $^\circ\text{C}$
$T_{stg}$			-40...125 $^\circ\text{C}$
$V_{ISOL}$	50/60 Hz, RMS	$t = 1 \text{ min}$	3000 V~
	$I_{ISOL} \leq 1 \text{ mA}$	$t = 1 \text{ s}$	3600 V~
$M_d$	Mounting torque (M6)		4.5-7/40-62 Nm/lb.in.
	Terminal connection torque (M8)		11-13/97-115 Nm/lb.in.
Weight	Typical including screws		650 g

## Features

- Direct copper bonded  $\text{Al}_2\text{O}_3$  -ceramic with copper base plate
- Planar passivated chips
- Isolation voltage 3600 V~
- UL applied
- Keyed gate/cathode twin pins

## Applications

- Motor control, soft starter
- Power converter
- Heat and temperature control for industrial furnaces and chemical processes
- Lighting control
- Solid state switches

## Advantages

- Improved temperature and power cycling
- Reduced protection circuits

Data according to IEC 60747 refer to a single thyristor/diode unless otherwise stated. IXYS reserves the right to change limits, test conditions and dimensions

Symbol	Test Conditions	Characteristic Values	
$I_{RRM}$	$T_{VJ} = T_{VJM}; V_R = V_{RRM}$	40	mA
$V_T$	$I_T = 600 \text{ A}; T_{VJ} = 25^\circ\text{C}$	1.15	V
$V_{T0}$	For power-loss calculations only ( $T_{VJ} = T_{VJM}$ )	0.77	V
$r_T$		0.42	m $\Omega$
$V_{GT}$	$V_D = 6 \text{ V}; T_{VJ} = 25^\circ\text{C}$	2	V
	$T_{VJ} = -40^\circ\text{C}$	3	V
$I_{GT}$	$V_D = 6 \text{ V}; T_{VJ} = 25^\circ\text{C}$	300	mA
	$T_{VJ} = -40^\circ\text{C}$	400	mA
$V_{GD}$	$T_{VJ} = T_{VJM}; V_D = 2/3 V_{DRM}$	0.25	V
$I_{GD}$	$T_{VJ} = T_{VJM}; V_D = 2/3 V_{DRM}$	10	mA
$I_L$	$T_{VJ} = 25^\circ\text{C}; V_D = 6 \text{ V}; t_p = 30 \mu\text{s}$ $di_G/dt = 1 \text{ A}/\mu\text{s}; I_G = 1 \text{ A}$	400	mA
$I_H$	$T_{VJ} = 25^\circ\text{C}; V_D = 6 \text{ V}; R_{GK} = \infty$	300	mA
$t_{gd}$	$T_{VJ} = 25^\circ\text{C}; V_D = 1/2 V_{DRM}$ $di_G/dt = 1 \text{ A}/\mu\text{s}; I_G = 1 \text{ A}$	2	$\mu\text{s}$
$t_q$	$T_{VJ} = T_{VJM}; V_R = 100 \text{ V}; V_D = 2/3 V_{DRM}; t_p = 200 \mu\text{s}$ $dv/dt = 50 \text{ V}/\mu\text{s}; I_T = 500 \text{ A}; -di/dt = 10 \text{ A}/\mu\text{s}$	typ. 350	$\mu\text{s}$
$R_{thJC}$	DC current	0.072	K/W
$R_{thJK}$	DC current	0.096	K/W
$d_s$	Creep distance on surface	12.7	mm
$d_A$	Strike distance in air	9.6	mm
$a$	Maximum allowable acceleration	50	m/s <sup>2</sup>

Optional accessories for modules

Keyed Gate/Cathode twin plugs with wire length = 350 mm, gate = yellow, cathode = red

Type **ZY 180 L** (L = Left for pin pair 4/5)  $\left\{ \begin{array}{l} \text{UL 758, style 1385, File E 38136,} \\ \text{CSA class 5851, guide 460-1-1, appl. 41234} \end{array} \right.$

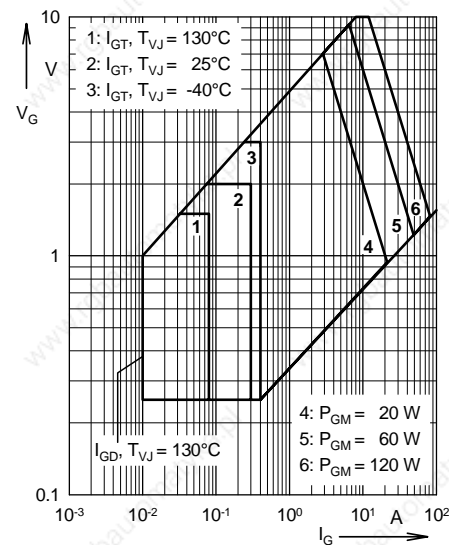


Fig. 1 Gate trigger characteristics

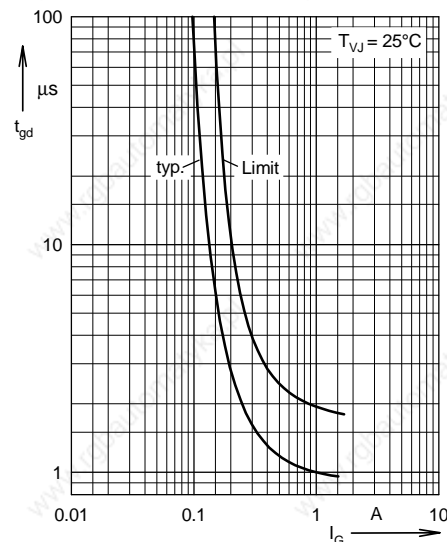
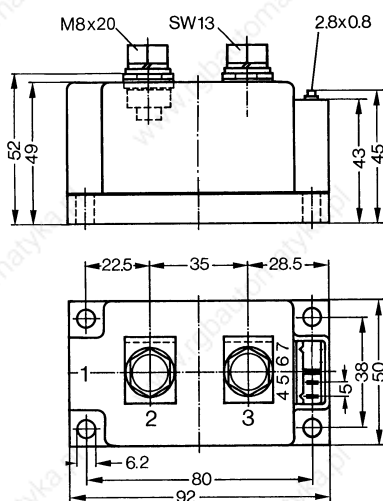


Fig. 2 Gate trigger delay time

### Dimensions in mm (1 mm = 0.0394")



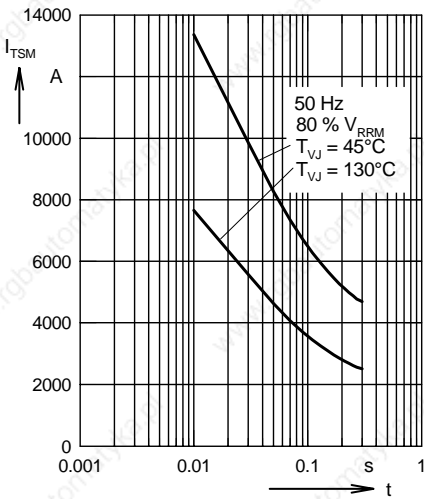


Fig. 3 Surge overload current  
 $I_{TSM}$ : Crest value,  $t$ : duration

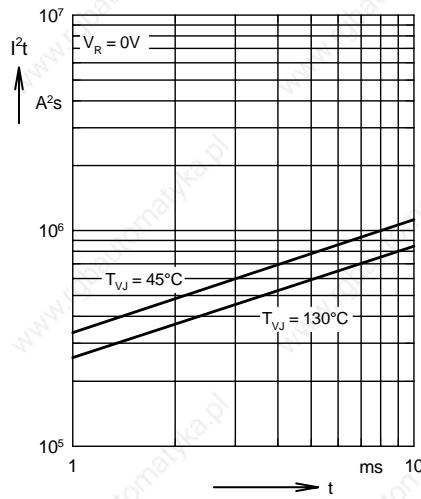


Fig. 4  $I^2t$  versus time (1-10 ms)

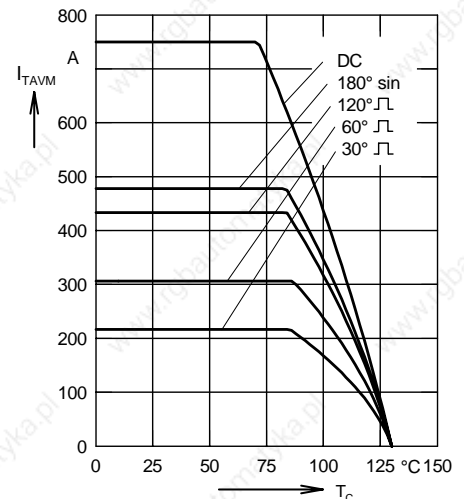


Fig. 5 Maximum forward current at case temperature

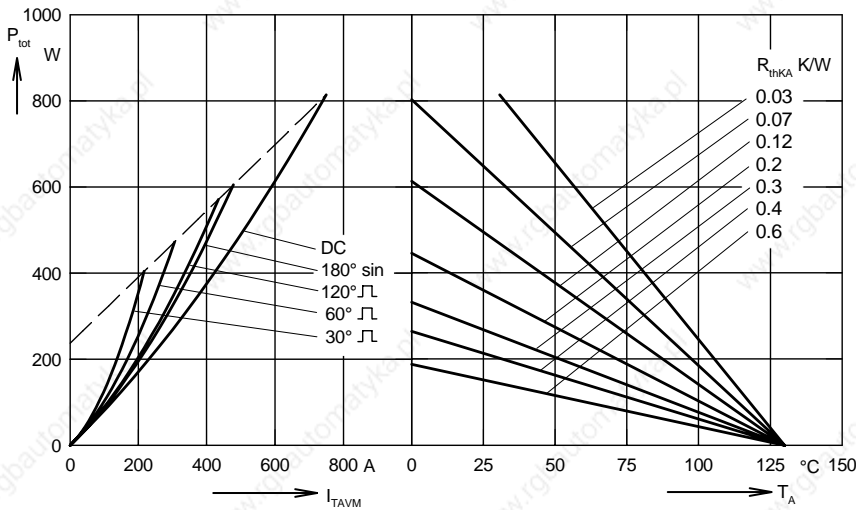


Fig. 6 Power dissipation versus on-state current and ambient temperature

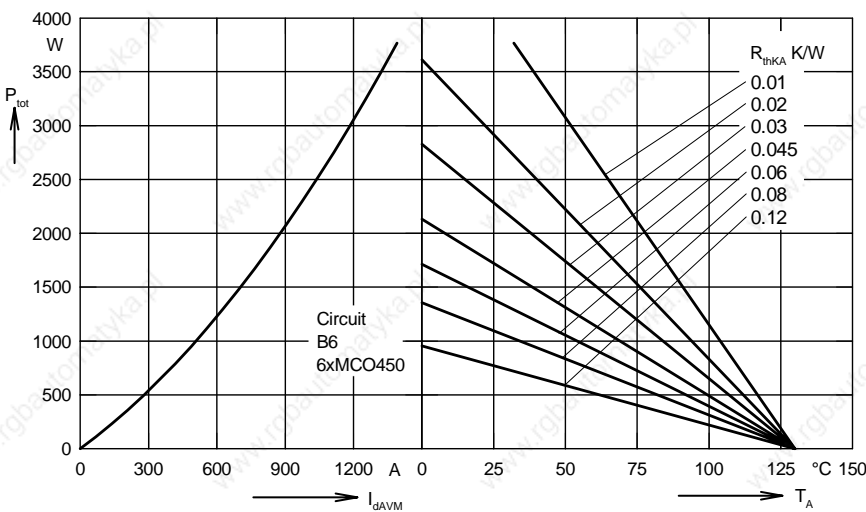


Fig. 7 Three phase rectifier bridge:  
 Power dissipation versus direct output current and ambient temperature



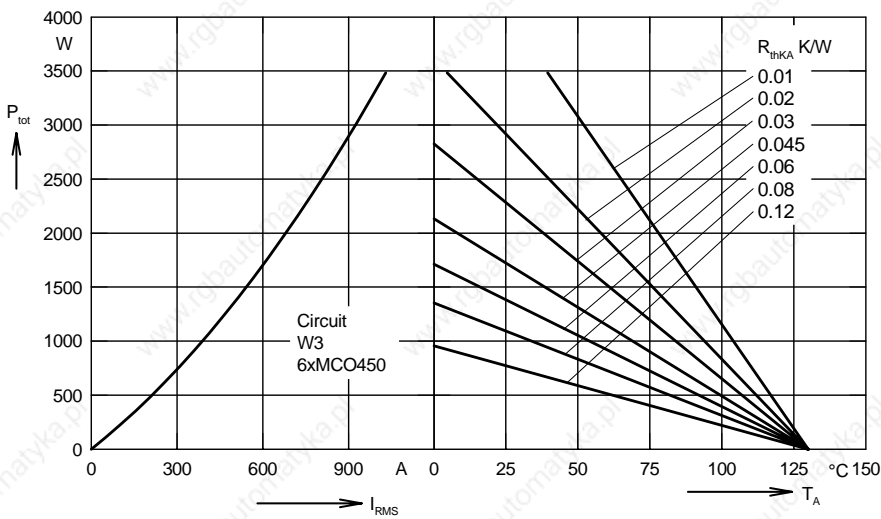


Fig. 8 Three phase AC-controller: Power dissipation versus RMS output current and ambient temperature

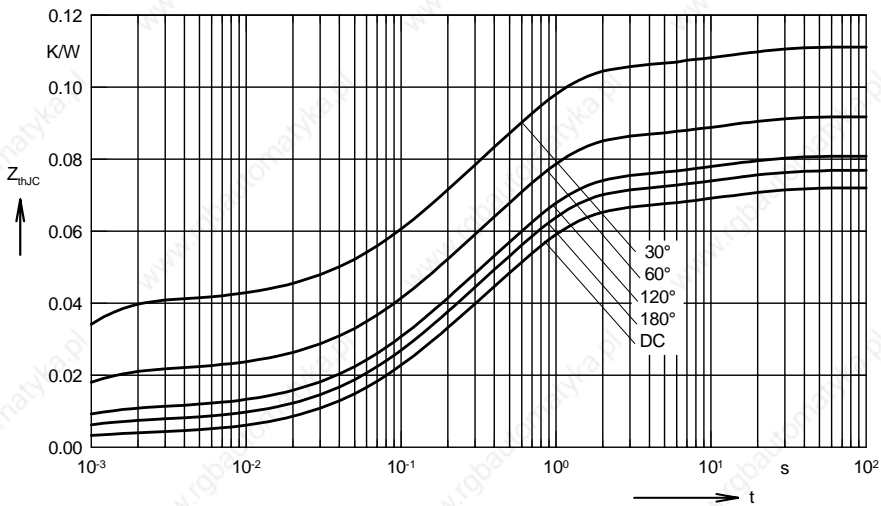


Fig. 9 Transient thermal impedance junction to case

$R_{thJC}$  for various conduction angles d:

d	$R_{thJC}$ (K/W)
DC	0.072
180°	0.0768
120°	0.081
60°	0.092
30°	0.111

Constants for  $Z_{thJC}$  calculation:

i	$R_{thi}$ (K/W)	$t_i$ (s)
1	0.0035	0.0054
2	0.0186	0.098
3	0.0432	0.54
4	0.0067	12

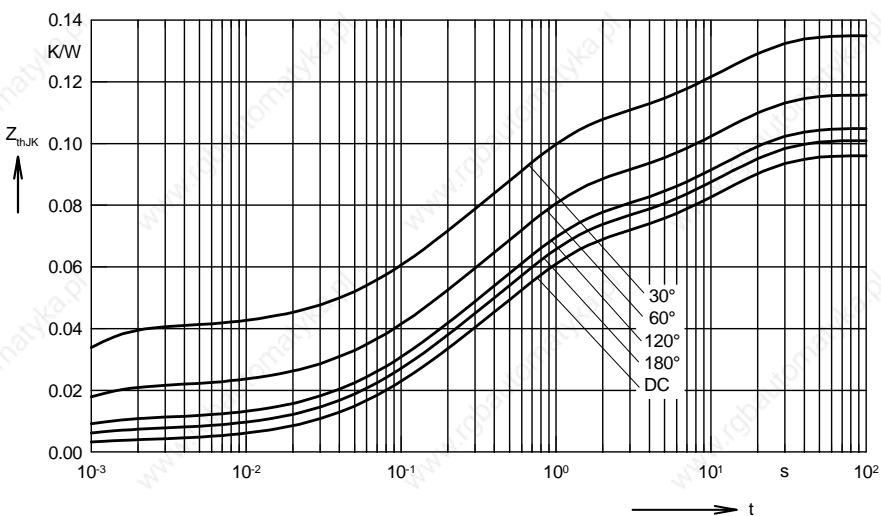


Fig.10 Transient thermal impedance junction to heatsink

$R_{thJK}$  for various conduction angles d:

d	$R_{thJK}$ (K/W)
DC	0.096
180°	0.1
120°	0.105
60°	0.116
30°	0.135

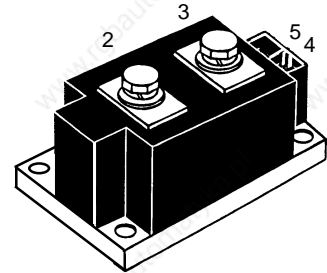
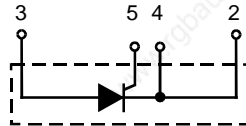
Constants for  $Z_{thJK}$  calculation:

i	$R_{thi}$ (K/W)	$t_i$ (s)
1	0.0035	0.0054
2	0.0186	0.098
3	0.0432	0.54
4	0.0067	12
5	0.024	12

## High Power Thyristor Modules

$I_{TRMS} = 880 \text{ A}$   
 $I_{T(AV)M} = 560 \text{ A}$   
 $V_{RRM} = 1200-1800 \text{ V}$

$V_{RSM}$ $V_{DSM}$ V	$V_{RRM}$ $V_{DRM}$ V	Type
1300	1200	MCO 500-12io1
1500	1400	MCO 500-14io1
1700	1600	MCO 500-16io1
1900	1800	MCO 500-18io1



Symbol	Test Conditions	Maximum Ratings	
$I_{TRMS}$	$T_{VJ} = T_{VJM}$	880 A	
$I_{T(AV)M}$	$T_C = 85^\circ\text{C}; 180^\circ \text{ sine}$	560 A	
$I_{TSM}$	$T_{VJ} = 45^\circ\text{C}$ $V_R = 0$	$t = 10 \text{ ms (50 Hz)}$ $t = 8.3 \text{ ms (60 Hz)}$	17000 A 16000 A
	$T_{VJ} = T_{VJM}$ $V_R = 0$	$t = 10 \text{ ms (50 Hz)}$ $t = 8.3 \text{ ms (60 Hz)}$	13000 A 14400 A
$I^2t$	$T_{VJ} = 45^\circ\text{C}$ $V_R = 0$	$t = 10 \text{ ms (50 Hz)}$ $t = 8.3 \text{ ms (60 Hz)}$	1445000 $A^2s$ 1062000 $A^2s$
	$T_{VJ} = T_{VJM}$ $V_R = 0$	$t = 10 \text{ ms (50 Hz)}$ $t = 8.3 \text{ ms (60 Hz)}$	845000 $A^2s$ 813000 $A^2s$
$(di/dt)_{cr}$	$T_{VJ} = T_{VJM}$ $f = 50 \text{ Hz}, t_p = 200 \mu\text{s}$ $V_D = 2/3 V_{DRM}$	repetitive, $I_T = 960 \text{ A}$	100 $A/\mu\text{s}$
	$I_G = 1 \text{ A}$ $di_G/dt = 1 \text{ A}/\mu\text{s}$	non repetitive, $I_T = I_{T(AV)M}$	500 $A/\mu\text{s}$
$(dv/dt)_{cr}$	$T_{VJ} = T_{VJM}; V_{DR} = 2/3 V_{DRM}$ $R_{GK} = \infty$ ; method 1 (linear voltage rise)		1000 $V/\mu\text{s}$
$P_{GM}$	$T_{VJ} = T_{VJM}$ $I_T = I_{T(AV)M}$	$t_p = 30 \mu\text{s}$ $t_p = 500 \mu\text{s}$	120 W 60 W
$P_{GAV}$			30 W
$V_{RGM}$			10 V
$T_{VJ}$			-40...140 $^\circ\text{C}$
$T_{VJM}$			140 $^\circ\text{C}$
$T_{stg}$			-40...125 $^\circ\text{C}$
$V_{ISOL}$	50/60 Hz, RMS	$t = 1 \text{ min}$	3000 V~
	$I_{ISOL} \leq 1 \text{ mA}$	$t = 1 \text{ s}$	3600 V~
$M_d$	Mounting torque (M6)		4.5-7/40-62 Nm/lb.in.
	Terminal connection torque (M8)		11-13/97-115 Nm/lb.in.
Weight	Typical including screws		650 g

### Features

- International standard package
- Direct copper bonded  $\text{Al}_2\text{O}_3$ -ceramic with copper base plate
- Planar passivated chips
- Isolation voltage 3600 V~
- UL registered E 72873
- Keyed gate/cathode twin pins

### Applications

- Motor control, softstarter
- Power converter
- Heat and temperature control for industrial furnaces and chemical processes
- Lighting control
- Solid state switches

### Advantages

- Simple mounting
- Improved temperature and power cycling
- Reduced protection circuits

Data according to IEC 60747 refer to a single thyristor/diode unless otherwise stated. IXYS reserves the right to change limits, test conditions and dimensions

Symbol	Test Conditions	Characteristic Values	
$I_{RRM}$	$T_{VJ} = T_{VJM}; V_R = V_{RRM}$	40	mA
$V_T$	$I_T = 1200 \text{ A}; T_{VJ} = 25^\circ\text{C}$	1.3	V
$V_{T0}$	For power-loss calculations only ( $T_{VJ} = T_{VJM}$ )	0.8	V
$r_T$		0.38	m $\Omega$
$V_{GT}$	$V_D = 6 \text{ V}; T_{VJ} = 25^\circ\text{C}$	2	V
	$T_{VJ} = -40^\circ\text{C}$	3	V
$I_{GT}$	$V_D = 6 \text{ V}; T_{VJ} = 25^\circ\text{C}$	300	mA
	$T_{VJ} = -40^\circ\text{C}$	400	mA
$V_{GD}$	$T_{VJ} = T_{VJM}; V_D = 2/3 V_{DRM}$	0.25	V
$I_{GD}$	$T_{VJ} = T_{VJM}; V_D = 2/3 V_{DRM}$	10	mA
$I_L$	$T_{VJ} = 25^\circ\text{C}; V_D = 6 \text{ V}; t_p = 30 \mu\text{s}$ $di_G/dt = 1 \text{ A}/\mu\text{s}; I_G = 1 \text{ A}$	400	mA
$I_H$	$T_{VJ} = 25^\circ\text{C}; V_D = 6 \text{ V}; R_{GK} = \infty$	300	mA
$t_{gd}$	$T_{VJ} = 25^\circ\text{C}; V_D = 1/2 V_{DRM}$ $di_G/dt = 1 \text{ A}/\mu\text{s}; I_G = 1 \text{ A}$	2	$\mu\text{s}$
$t_q$	$T_{VJ} = T_{VJM}; V_R = 100 \text{ V}; V_D = 2/3 V_{DRM}; t_p = 200 \mu\text{s}$ $dv/dt = 50 \text{ V}/\mu\text{s}; I_T = 500 \text{ A}; -di/dt = 10 \text{ A}/\mu\text{s}$	typ. 350	$\mu\text{s}$
$R_{thJC}$	DC current	0.072	K/W
$R_{thJK}$	DC current	0.096	K/W
$d_s$	Creeping distance on surface	12.7	mm
$d_A$	Creepage distance in air	9.6	mm
$a$	Maximum allowable acceleration	50	m/s <sup>2</sup>

Optional accessories for modules

Keyed Gate/Cathode twin plugs with wire length = 350 mm, gate = yellow, cathode = red

Type **ZY 180 L** (L = Left for pin pair 4/5)  $\left\{ \begin{array}{l} \text{UL 758, style 1385,} \\ \text{CSA class 5851, guide 460-1-1} \end{array} \right.$

Dimensions in mm (1 mm = 0.0394")

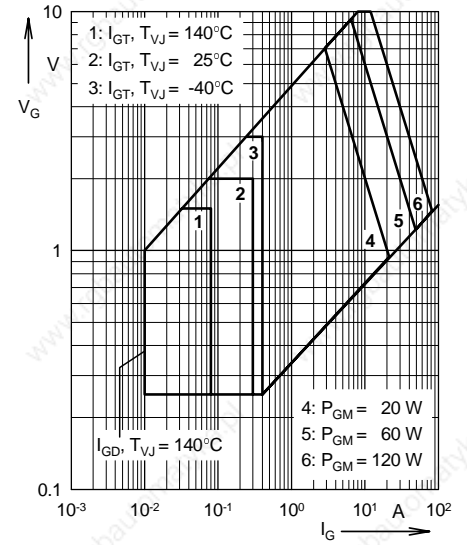
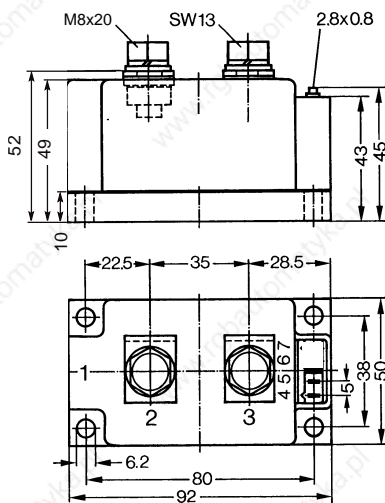


Fig. 1 Gate trigger characteristics

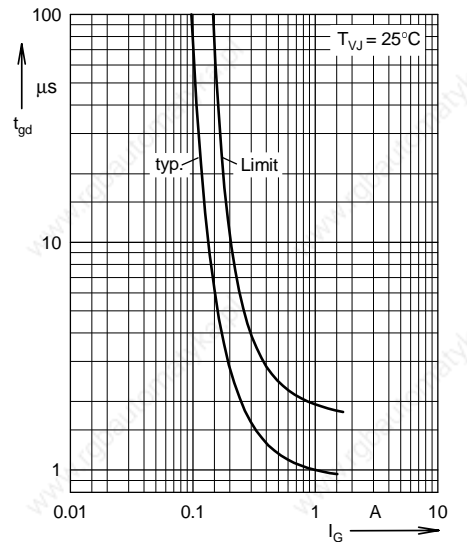


Fig. 2 Gate trigger delay time

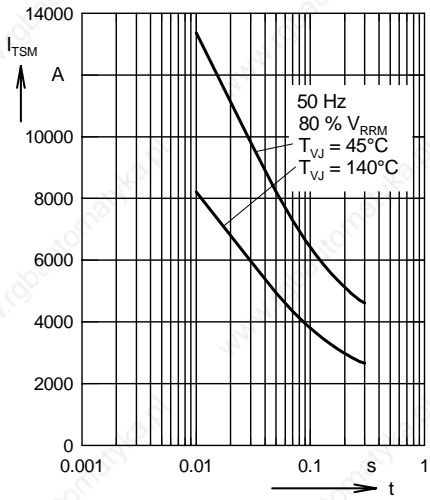


Fig. 3 Surge overload current  
 $I_{TSM}$ ,  $I_{FSM}$ : Crest value, t: duration

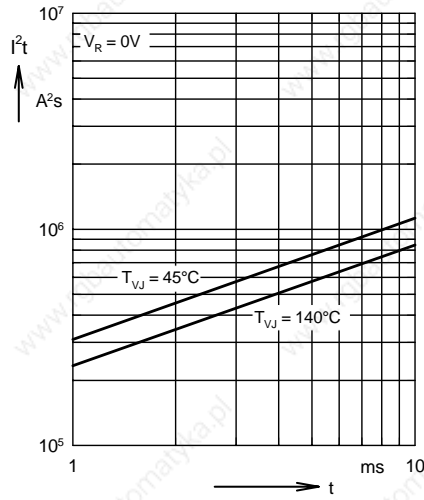


Fig. 4  $j^2t$  versus time (1-10 ms)

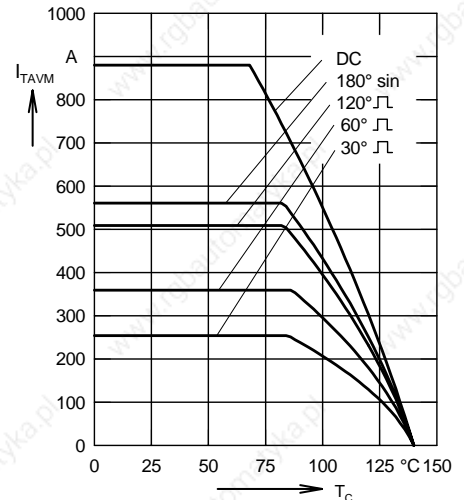


Fig. 5 Maximum forward current at case temperature

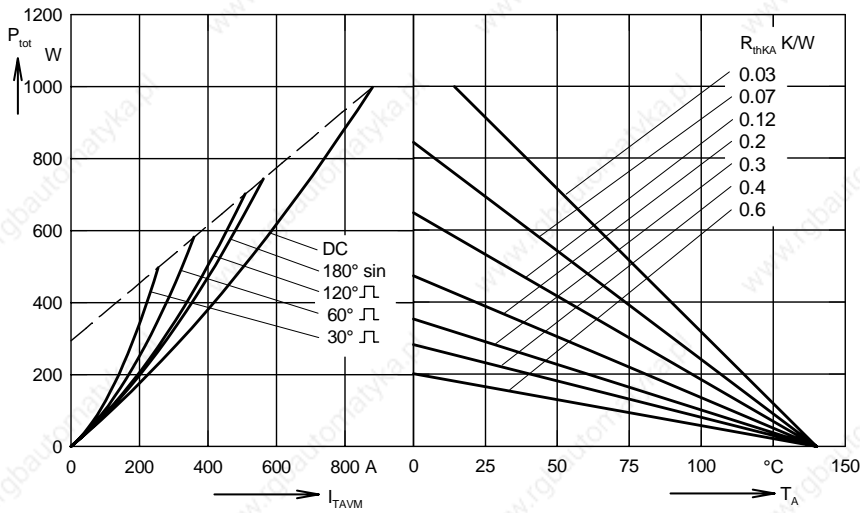


Fig. 6 Power dissipation versus on-state current and ambient temperature

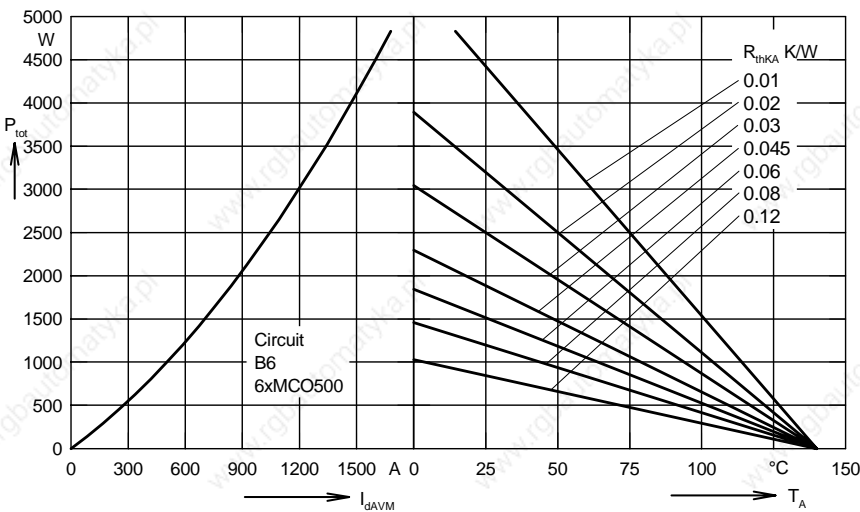


Fig. 7 Three phase rectifier bridge: Power dissipation versus direct output current and ambient temperature

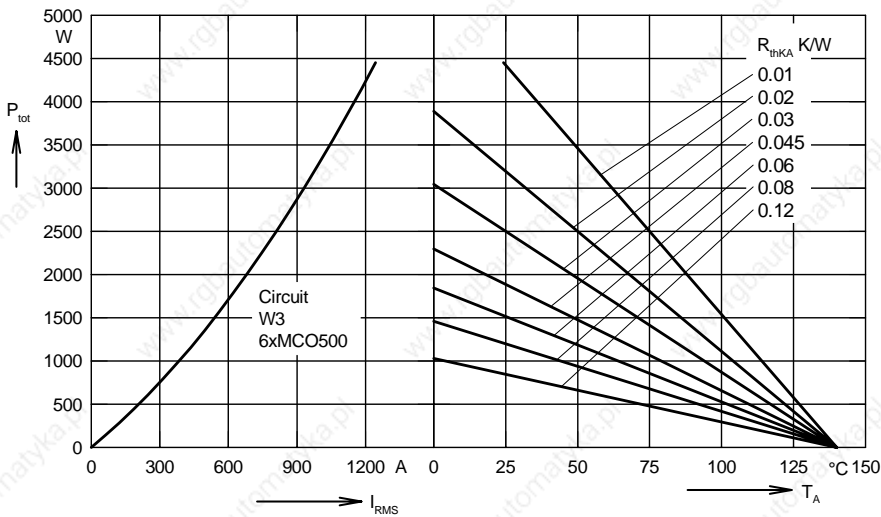


Fig. 8 Three phase AC-controller: Power dissipation versus RMS output current and ambient temperature

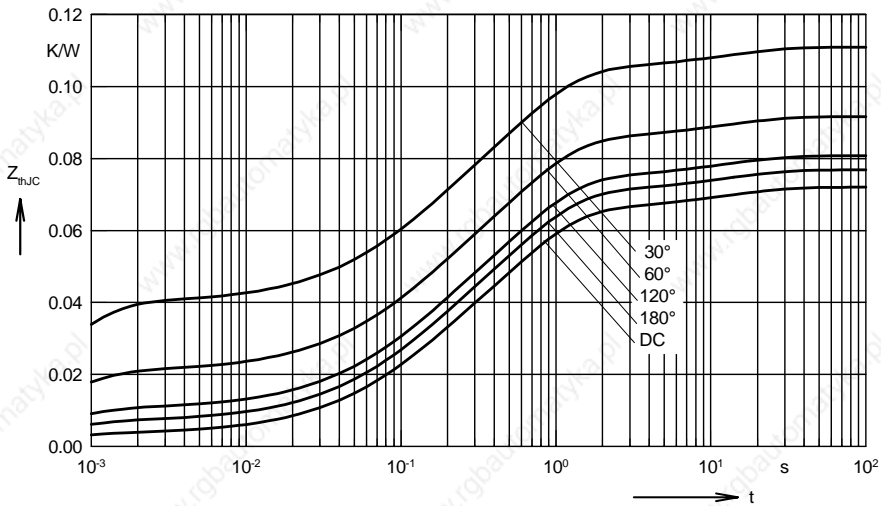


Fig. 9 Transient thermal impedance junction to case (per thyristor)

$R_{thJC}$  for various conduction angles  $d$ :

$d$	$R_{thJC}$ (K/W)
DC	0.072
180°	0.0768
120°	0.081
60°	0.092
30°	0.111

Constants for  $Z_{thJC}$  calculation:

$i$	$R_{thi}$ (K/W)	$t_i$ (s)
1	0.0035	0.0054
2	0.0186	0.098
3	0.0432	0.54
4	0.0067	12

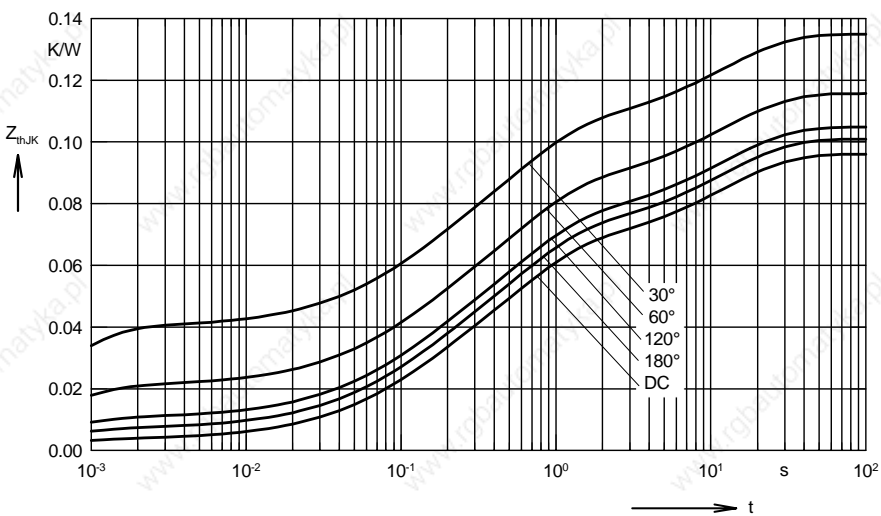


Fig.10 Transient thermal impedance junction to heatsink (per thyristor)

$R_{thJK}$  for various conduction angles  $d$ :

$d$	$R_{thJK}$ (K/W)
DC	0.096
180°	0.1
120°	0.105
60°	0.116
30°	0.135

Constants for  $Z_{thJK}$  calculation:

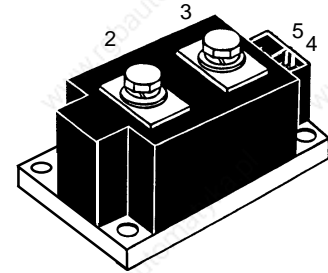
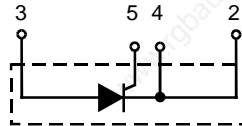
$i$	$R_{thi}$ (K/W)	$t_i$ (s)
1	0.0035	0.0054
2	0.0186	0.098
3	0.0432	0.54
4	0.0067	12
5	0.024	12

# High Power Single Thyristor Module

$I_{TRMS} = 928 \text{ A}$   
 $I_{TAV} = 600 \text{ A}$   
 $V_{RRM} = 2000\text{-}2200 \text{ V}$

Preliminary data

$V_{RSM}$ $V_{DSM}$ V	$V_{RRM}$ $V_{DRM}$ V	Type
2100	2000	MCO 600-20io1
2300	2200	MCO 600-22io1



Symbol	Test Conditions	Maximum Ratings
$I_{TRMS}$ $I_{TAV}$	$T_{VJ} = T_{VJM}$ $T_C = 85^\circ\text{C}; 180^\circ \text{ sine}$	928 A 600 A
$I_{TSM}$	$T_{VJ} = 45^\circ\text{C}$ $V_R = 0$	$t = 10 \text{ ms (50 Hz)}$ $t = 8.3 \text{ ms (60 Hz)}$
	$T_{VJ} = T_{VJM}$ $V_R = 0$	15000 A 16000 A
$I^2t$	$T_{VJ} = 45^\circ\text{C}$ $V_R = 0$	$t = 10 \text{ ms (50 Hz)}$ $t = 8.3 \text{ ms (60 Hz)}$
	$T_{VJ} = T_{VJM}$ $V_R = 0$	1125000 A <sup>2</sup> s 1062000 A <sup>2</sup> s
$(di/dt)_{cr}$	$T_{VJ} = T_{VJM}$ $f = 50 \text{ Hz}, t_p = 200 \mu\text{s}$ $V_D = 2/3 V_{DRM}$ $I_G = 1 \text{ A},$ non repetitive, $I_T = I_{TAVM}$ $di_G/dt = 1 \text{ A}/\mu\text{s}$	100 A/ $\mu\text{s}$ 500 A/ $\mu\text{s}$
	$T_{VJ} = T_{VJM}; V_{DR} = 2/3 V_{DRM}$ $R_{GK} = \infty; \text{method 1 (linear voltage rise)}$	1000 V/ $\mu\text{s}$
$P_{GM}$	$T_{VJ} = T_{VJM}$ $I_T = I_{TAVM}$	$t_p = 30 \mu\text{s}$ $t_p = 500 \mu\text{s}$
$P_{GAV}$ $V_{RGM}$		120 W 60 W 30 W 10 V
$T_{VJ}$ $T_{VJM}$ $T_{stg}$		-40...140 °C 140 °C -40...125 °C
$V_{ISOL}$	50/60 Hz, RMS $I_{ISOL} \leq 1 \text{ mA}$	$t = 1 \text{ min}$ $t = 1 \text{ s}$
		3000 V~ 3600 V~
$M_d$	Mounting torque (M6)	4.5-7/40-62 Nm/lb.in.
	Terminal connection torque (M8)	11-13/97-115 Nm/lb.in.
Weight	Typical including screws	650 g

## Features

- Direct copper bonded  $\text{Al}_2\text{O}_3$  -ceramic with copper base plate
- Planar passivated chips
- Isolation voltage 3600 V~
- UL applied
- Keyed gate/cathode twin pins

## Applications

- Motor control, softstarter
- Power converter
- Heat and temperature control for industrial furnaces and chemical processes
- Lighting control
- Solid state switches

## Advantages

- Improved temperature and power cycling
- Reduced protection circuits

Data according to IEC 60747 and refer to a single thyristor/diode unless otherwise stated. IXYS reserves the right to change limits, test conditions and dimensions

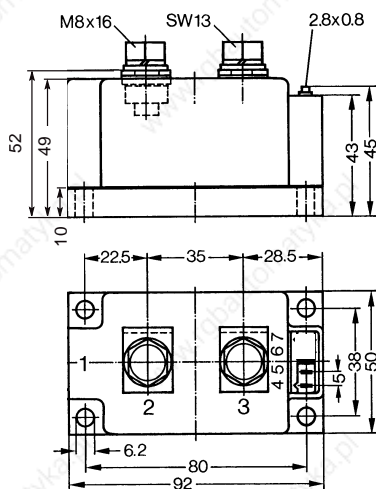
Symbol	Test Conditions	Characteristic Values	
$I_{RRM}$	$T_{VJ} = T_{VJM}; V_R = V_{RRM}$	60	mA
$V_T$	$I_T = 600 \text{ A}; T_{VJ} = 25^\circ\text{C}$	1.15	V
$V_{T0}$	For power-loss calculations only ( $T_{VJ} = T_{VJM}$ )	0.77	V
$r_T$		0.42	m $\Omega$
$V_{GT}$	$V_D = 6 \text{ V}; T_{VJ} = 25^\circ\text{C}$	2	V
	$T_{VJ} = -40^\circ\text{C}$	3	V
$I_{GT}$	$V_D = 6 \text{ V}; T_{VJ} = 25^\circ\text{C}$	300	mA
	$T_{VJ} = -40^\circ\text{C}$	400	mA
$V_{GD}$	$T_{VJ} = T_{VJM}; V_D = 2/3 V_{DRM}$	0.25	V
$I_{GD}$	$T_{VJ} = T_{VJM}; V_D = 2/3 V_{DRM}$	10	mA
$I_L$	$T_{VJ} = 25^\circ\text{C}; V_D = 6 \text{ V}; t_p = 30 \mu\text{s}$ $di_G/dt = 1 \text{ A}/\mu\text{s}; I_G = 1 \text{ A}$	400	mA
$I_H$	$T_{VJ} = 25^\circ\text{C}; V_D = 6 \text{ V}; R_{GK} = \infty$	300	mA
$t_{gd}$	$T_{VJ} = 25^\circ\text{C}; V_D = 1/2 V_{DRM}$ $di_G/dt = 1 \text{ A}/\mu\text{s}; I_G = 1 \text{ A}$	2	$\mu\text{s}$
$t_q$	$T_{VJ} = T_{VJM}; V_R = 100 \text{ V}; V_D = 2/3 V_{DRM}; t_p = 200 \mu\text{s}$ $dv/dt = 50 \text{ V}/\mu\text{s}; I_T = 500 \text{ A}; -di/dt = 10 \text{ A}/\mu\text{s}$	typ. 350	$\mu\text{s}$
$R_{thJC}$	DC current	0.065	K/W
$R_{thJK}$	DC current	0.085	K/W
$d_s$	Creep distance on surface	12.7	mm
$d_A$	Strike distance in air	9.6	mm
$a$	Maximum allowable acceleration	50	m/s <sup>2</sup>

Optional accessories for modules

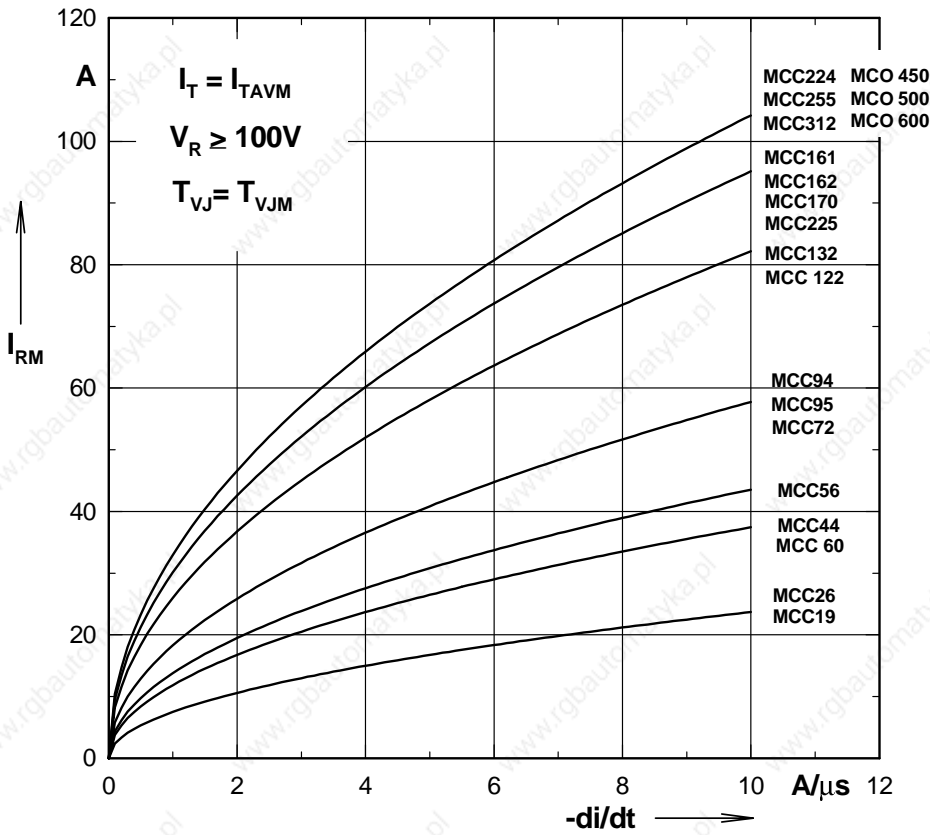
Keyed Gate/Cathode twin plugs with wire length = 350 mm, gate = yellow, cathode = red

Type **ZY 180 L** (L = Left for pin pair 4/5)  $\left\{ \begin{array}{l} \text{UL 758, style 1385, File E 38136,} \\ \text{CSA class 5851, guide 460-1-1, appl. 41234} \end{array} \right.$

### Dimensions in mm (1 mm = 0.0394")



### Peak reverse recovery current versus $-di/dt$



### Recommended RC snubber network against hole storage effect overvoltage

Type	Supply Voltage $V_{VRMS}$		
	$\leq 250 V$	$\leq 400 V$	$\leq 575 V$
MCC/MCD/MDD 19/26	R = 68 $\Omega$ /6 W C = 0.22 $\mu F$	R = 68 $\Omega$ /6 W C = 0.22 $\mu F$	R = 100 $\Omega$ /10 W C = 0.1 $\mu F$
MCC/MCD/MDD 44/56/60/72/94/95	R = 33 $\Omega$ /10 W C = 0.22 $\mu F$	R = 47 $\Omega$ /10 W C = 0.22 $\mu F$	R = 68 $\Omega$ /10 W C = 0.1 $\mu F$
MCC/MCD/MDD/MCO/MDO 122/132/142/161/162/170/ 172/220/225/250/255/310/ 312/450/500/600	R = 33 $\Omega$ /25 W C = 0.47 $\mu F$	R = 33 $\Omega$ /25 W C = 0.47 $\mu F$	R = 47 $\Omega$ /25 W C = 0.1 $\mu F$

#### Conditions

$f = 40 - 60 \text{ Hz}$   
 Short circuit voltage 4-6 %  
 Voltage safety factor 2.5

