

RoHS  **216 Series, 5 x 20 mm, Fast-Acting Fuse**











Description

5x20mm fast-acting ceramic body cartridge fuse designed to IEC specification.

Features

- Designed to International (IEC) Standards for use globally
- Meets the IEC 60127-2, sheet 1 specification
- for fast-acting fuses
- Available in cartridge and axial lead form
- RoHS compliant and lead-free

Agency Approvals

Agency	Agency File Number	Ampere Range
	Cartridge Certificates: 1-5A NBK 080205-E10480A 6.6A-10A NBK 250702-E10480E 12.5A NBK 240108-JP1021C 16A NBK 240108-JP1021E	1A – 10A
	Leaded Certificates: 1-5A NBK 080205-E10480B 6.3A-10A NBK 250702-E10480F 12.5A NBK 240108-JP1021D 16A NBK 240108-JP1021F	
	Certificates: 2003010207079960	50mA – 6.3A
	Certificates: SU05001-2013	1A – 10A
	Recognised File: E10480 Guide: JDYX2	50mA – 10A 12.5A, 16A
	File: 029862 Acc. Class: LR1422-30	
	License: KM41462	1A – 6.3A
	File: 9851193, 0149272 0147099 and 811745 508639, 601025	50mA – 6.3A 8A&10A, 16A
	License: 40013834	
	License: 40016442	*12.5A
		50mA – 16A
		

*Approval for Cartridge versions only

Applications

Used as supplementary protection in appliance or utilization equipment to provide individual protection for components or internal circuits.

Electrical Characteristics for Series

% of Ampere Rating	Ampere Rating	Opening Time
150%	50mA – 4A	60 minutes, Minimum
	5A – 6.3A	60 minutes, Minimum
	8A – 16A	30 minutes, Minimum
210%	50mA – 4A	30 minutes, Maximum
	5A – 6.3A 8A – 16A	30 minutes, Maximum
275%	50mA – 4A	0.01 sec., Min.; 2 sec. Max.
	5A – 6.3A	0.01 sec., Min.; 3 sec. Max.
	8A – 16A	0.04 sec., Min.; 20 sec. Max.
400%	50mA – 4A	.003 sec., Min.; 0.3 sec. Max.
	5A – 6.3A	.003 sec., Min.; 0.3 sec. Max.
	8A – 16A	.01 sec., Min.; 1.0 sec. Max.
1000%	50mA – 4A	.02 seconds, Maximum
	5A – 6.3A	.02 seconds, Maximum
	8A – 16A	.03 sec.onds, Maximum

216 Series

Electrical Characteristics Specifications by Item

Amp Code	Amp Rating (A)	Voltage Rating (V)	Interrupting Rating	Nominal Cold Resistance (Ohms)	Nominal Melting I ² t (A ² sec)	Nominal Voltage Drop at Rated Current (mV)	Nominal Power Dissipation at Rated Current (W)	Agency Approvals									
								CCC	UL	CSA	CE	UL	VDE	VDE	PS		
.050	0.05	250	1500A@250Vac	15.9000	0.00019	10000	1.6		x	x	x	x	x		x		
.063	0.063	250		10.4500	0.00054	8800	1.6		x	x	x	x	x		x		
.080	0.08	250		7.8850	0.00084	7600	1.6		x	x	x	x	x		x		
.100	0.1	250		5.7925	0.00450	7000	1.6		x	x	x	x	x		x		
.125	0.125	250		3.6750	0.00546	5000	1.6		x	x	x	x	x		x		
.160	0.16	250		5.3490	0.00576	4300	1.6		x	x	x	x	x		x		
.200	0.2	250		3.3500	0.00439	3500	1.6		x	x	x	x	x		x		
.250	0.25	250		2.3500	0.00891	2800	2.5		x	x	x	x	x		x		
.315	0.315	250		1.8500	0.01000	2500	2.5		x	x	x	x	x		x		
.400	0.4	250		0.9065	0.04000	2000	2.5		x	x	x	x	x		x		
.500	0.5	250		0.8660	0.16500	1800	2.5		x	x	x	x	x		x		
.630	0.63	250		0.4650	0.17500	1500	2.5		x	x	x	x	x		x		
.800	0.8	250		0.2950	0.28500	1200	2.5		x	x	x	x	x		x		
001.	1	250		0.2370	0.18000	1000	2.5	x	x	x	x	x	x	x	x		x
1.25	1.25	250		0.1530	0.48000	800	4	x	x	x	x	x	x	x	x		x
01.6	1.6	250		0.1112	1.00500	600	4	x	x	x	x	x	x	x	x		x
002.	2	250		0.0764	1.87000	500	4	x	x	x	x	x	x	x	x		x
02.5	2.5	250		0.0584	2.69500	400	4	x	x	x	x	x	x	x	x		x
3.15	3.15	250		0.0368	6.70000	350	4	x	x	x	x	x	x	x	x		x
004.	4	250		0.0247	14.99500	300	4	x	x	x	x	x	x	x	x		x
005.	5	250		0.0183	27.46000	250	4	x	x	x	x	x	x	x	x		x
06.3	6.3	250		0.0137	56.43000	200	4	x	x	x	x	x	x	x	x		x
008.	8	250		0.0123	64.31500	200	4	x		x	x	x	x		x*		x
010.	10	250		0.0079	154.34000	200	4	x		x	x	x	x		x*		x
12.5	12.5	250	0.0057	235.00000	200	4			x	x		x			x*		
016.	16	250	750A@250Vac	0.0040	462.50000	200	4.5			x	x	x	x				

* Approval for cartridge versions only.

Temperature Derating Curve

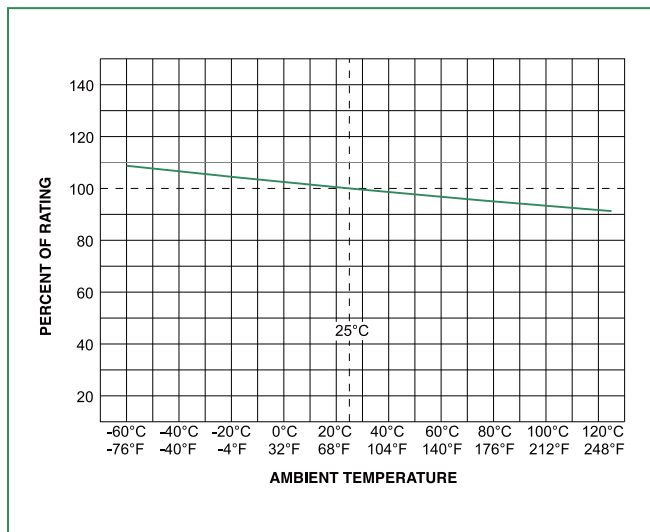

Average Time Current Curves

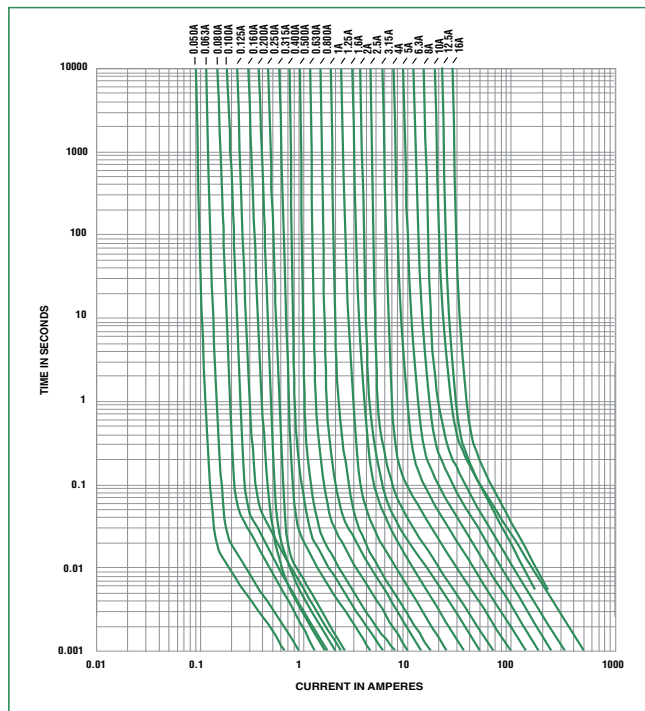

Soldering Parameters - Wave Soldering



Recommended Process Parameters:

Wave Parameter	Lead-Free Recommendation
Preheat: (Depends on Flux Activation Temperature) (Typical Industry Recommendation)	
Temperature Minimum:	100° C
Temperature Maximum:	150° C
Preheat Time:	60-180 seconds
Solder Pot Temperature:	260° C Maximum
Solder Dwell Time:	2-5 seconds

Recommended Hand-Solder Parameters:

Solder Iron Temperature: 350° C +/- 5° C
 Heating Time: 5 seconds max.

Note: These devices are not recommended for IR or Convection Reflow process.

Product Characteristics

Material	Body: Ceramic Cap: Nickel-plated brass Leads: Tin-plated Copper Filler (160mA-16A): Sand
Terminal Strength	MIL-STD-202G, Method 211A, Test Condition A
Solderability	Reference IEC 60127 Second Edition 2003-01 Annex A
Product Marking	Cap 1: Brand logo, current and voltage rating Cap 2: Agency approval markings
Packaging	Available in Bulk (M=1000 pcs/pkg) or on Tape/Reel (MRET1=1000 pcs/reel)

Operating Temperature	-55°C to +125°C
Thermal Shock	MIL-STD-202G, Method 107G, Test Condition B: (5 cycles -65°C to +125°C)
Vibration	MIL-STD-202G, Method 201A
Humidity	MIL-STD-202G, Method 103B, Test Condition A. high RH (95%) and elevated temperature (40°C) for 240 hours.
Salt Spray	MIL-STD-202G, Method 101D, Test Condition B

Dimensions

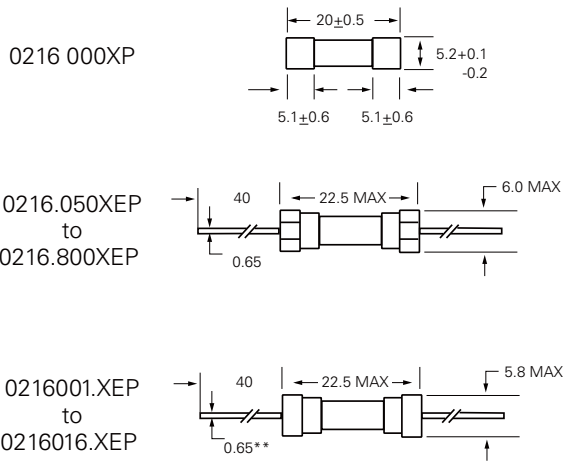

All dimensions in mm
** Ratings above 6.3A have 0.8 mm diameter lead

Part Numbering System

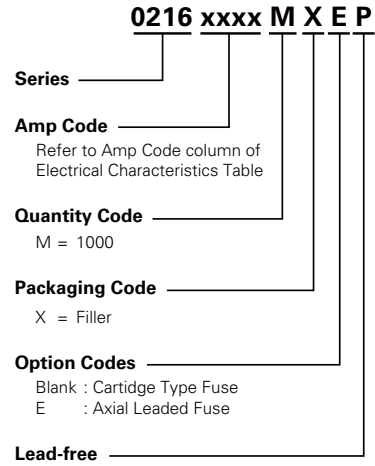

Packaging

Packaging Option	Packaging Specification	Quantity	Quantity & Packaging Code	Taping Width
216 Series				
Bulk	N/A	1000	MX	N/A
Bulk	N/A	1000	MXE	N/A
Reel and Tape	EIA 296-E	1000	MRET1	T1=52mm (2.062")
Bulk	N/A	1000	MXG	N/A
Bulk	N/A	1000	MXB	N/A
Bulk	N/A	100	HX	N/A