

Type 5ST / 5STP

Time-lag Fuse Series (Low Breaking Capacity)

HF  5ST/5STP Series, 5x20mm Glass Tube Time-lag Fuse

RoHS 2 Compliant

Description

5x20mm Time-lag, low breaking capacity, glass tube body cartridge fuse designed, approved and complied with IEC 60127-2, standard sheet 3.



Features

- Meet IEC standard 60127-2, sheet 3
- Wide operating temperature range
- Bulk and Tape & Reel packing available
- RoHS 2 compliant
- Halogen Free
- Lead Free

Applications

Provide individual protection for components or internal circuits.

- Power supplies
- Battery charger
- Monitor
- Adapter

LEAD FREE = 
 HALOGEN FREE = 

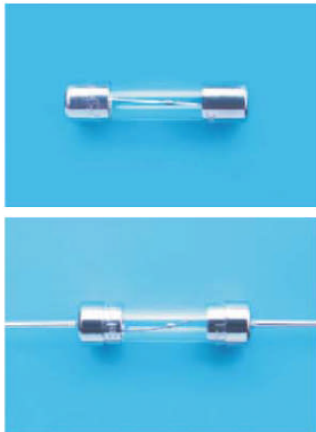

Physical Specifications





Materials	Body : Glass
	Cap : Nickel Plated Brass Caps
	Leads : Matte Tin Plated Copper
Marking	On Fuse :
	"bel", "T", "Current Rating", "L", "250V",
	"Appropriate Safety Logos", "✓" (RoHS 2 compliant)
	On Label :
	"bel", "5ST" or "5STP", "Current Rating", "Voltage Rating", "Interrupting Rating", "Appropriate Safety Logos" and "✓", "RoHS", "e" (China RoHS compliant).

Electrical Characteristics (IEC-127-2 STANDARD SHEET 3)

Rated Current	1.5 In		2.1 In		2.75 In		4 In		10 In	
	MIN	MAX	MIN	MAX	MIN	MAX	MIN	MAX	MIN	MAX
63mA to 100mA	1	2	200	10	40	3	10	300		
125mA to 12.5A	1	2	600	10	150	3	20	300		
	hr.	min.	ms	sec	ms	sec	ms	ms		

In clause 9.2, the test voltage for 5STP ratings from 63mA to 6.3A is 63VDC.

Safety Agency Approvals





Safety Agency	Safety Agency Certificate	Voltage Rating (V)	Ampere Range / Volt @ I.R. ability*
	15133392	63mA-10A /250V AC	63mA-6.3A/250V AC @35A or 10 In whichever is greater
	40000507		
	E20624		63mA-6.3A/250V AC @35A or 10 In whichever is greater
	LR39772		
	2003010207030316		

*I.R.= Interrupting Rating = Short Circuit Rating(Amps)

Environmental Specifications

Shock Resistance	MIL-STD-202G, Method 213B, Test Condition 1 (100 G's peak for 6 milliseconds; Sawtooth waveform)
Vibration Resistance	MIL-STD-202G, Method 201A (10-55 Hz, 0.06 inch, total excursion).
Salt Spray Resistance	MIL-STD-202G, Method 101E, Test Condition B (48 hrs).
Insulation Resistance	MIL-STD-202G, Method 302, Test Condition B (After Opening) 100,000 ohms minimum.
Solderability	MIL-STD-202G, Method 208H
Resistance to solder Heat	MIL-STD-202G, Method 210F, Test Condition B (260+/-5°C, 10+/-1 sec)
Thermal Shock	MIL-STD-202G, Method 107G, Test Condition B (-65°C to +125°C).
Operating Temperature	-55°C to +125°C
Terminal Strength	IEC-68-2-21

Electrical Specifications

Catalog Number	Ampere Rating	Typical Cold Resistance (ohms)	Volt-drop @100%In (Volt) max.	Voltage and Interrupting Ratings	Melting I ² T <10 mSec (A ² Sec)	Melting I ² T @10 In (A ² Sec)	Maximum Power Dissipation (W)	Agency Approvals				
												
5ST(P) 63-R	63mA	19.5	1.90	See Table of Safety Approvals on Page 1 for Voltage and associated Interrupting Ratings	0.008	0.021	0.32	Y	Y	Y	Y	Y
5ST(P) 80-R	80mA	13.2	1.68		0.015	0.036	0.49	Y	Y	Y	Y	Y
5ST(P) 100-R	100mA	11.0	1.63		0.03	0.06	0.51	Y	Y	Y	Y	Y
5ST(P) 125-R	125mA	7.02	1.29		0.05	0.11	0.51	Y	Y	Y	Y	Y
5ST(P) 160-R	160mA	4.10	0.92		0.08	0.19	0.61	Y	Y	Y	Y	Y
5ST(P) 200-R	200mA	2.60	0.77		0.15	0.33	0.56	Y	Y	Y	Y	Y
5ST(P) 250-R	250mA	1.70	0.64		0.26	0.58	0.56	Y	Y	Y	Y	Y
5ST(P) 315-R	315mA	1.30	0.57		0.46	1.01	0.75	Y	Y	Y	Y	Y
5ST(P) 400-R	400mA	0.72	0.41		0.81	1.76	0.76	Y	Y	Y	Y	Y
5ST(P) 500-R	500mA	0.57	0.47		1.4	3.1	0.76	Y	Y	Y	Y	Y
5ST(P) 630-R	630mA	0.18	0.14		0.9	1.5	0.24	Y	Y	Y	Y	Y
5ST(P) 800-R	800mA	0.14	0.14		1.6	2.5	0.30	Y	Y	Y	Y	Y
5ST(P) 1-R	1A	0.10	0.13		2.4	3.3	0.32	Y	Y	Y	Y	Y
5ST(P) 1.25-R	1.25A	0.052	0.08		4.1	5.5	0.33	Y	Y	Y	Y	Y
5ST(P) 1.6-R	1.6A	0.036	0.08		6.9	8.9	0.35	Y	Y	Y	Y	Y
5ST(P) 2-R	2A	0.028	0.08		12	15	0.45	Y	Y	Y	Y	Y
5ST(P) 2.5-R	2.5A	0.023	0.08		20	24	0.58	Y	Y	Y	Y	Y
5ST(P) 3.15-R	3.15A	0.017	0.08		33	39	0.76	Y	Y	Y	Y	Y
5ST(P) 4-R	4A	0.013	0.07		56	64	0.80	Y	Y	Y	Y	Y
5ST(P) 5-R	5A	0.0096	0.07		95	105	0.89	Y	Y	Y	Y	Y
5ST(P) 6.3-R	6.3A	0.0073	0.07		160	173	1.15	Y	Y	Y	Y	Y
5ST(P) 8-R	8A	0.0062	0.07		260	282	2.00	Y	Y			
5ST(P) 10-R	10A	0.0052	0.07		439	461	2.70	Y	Y			
5ST(P) 12.5-R	12.5A	0.0041	0.07		490	679	3.85					

Consult manufacturer for other ratings



Specifications subject to change without notice

Bel Fuse Inc.
206 Van Vorst Street
Jersey City, NJ 07302 USA

+1 201.432.0463
Bel.US.CS@belf.com
belfuse.com/circuit-protection

Temperature Derating Curve

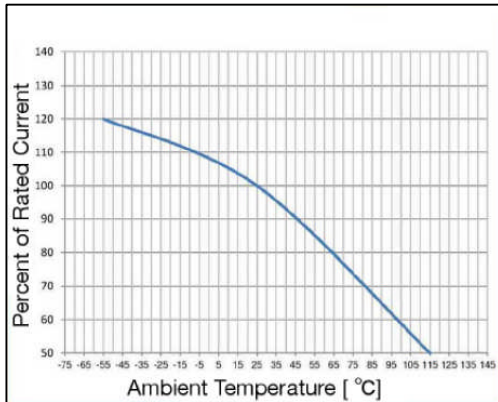

Average Time Current Curve

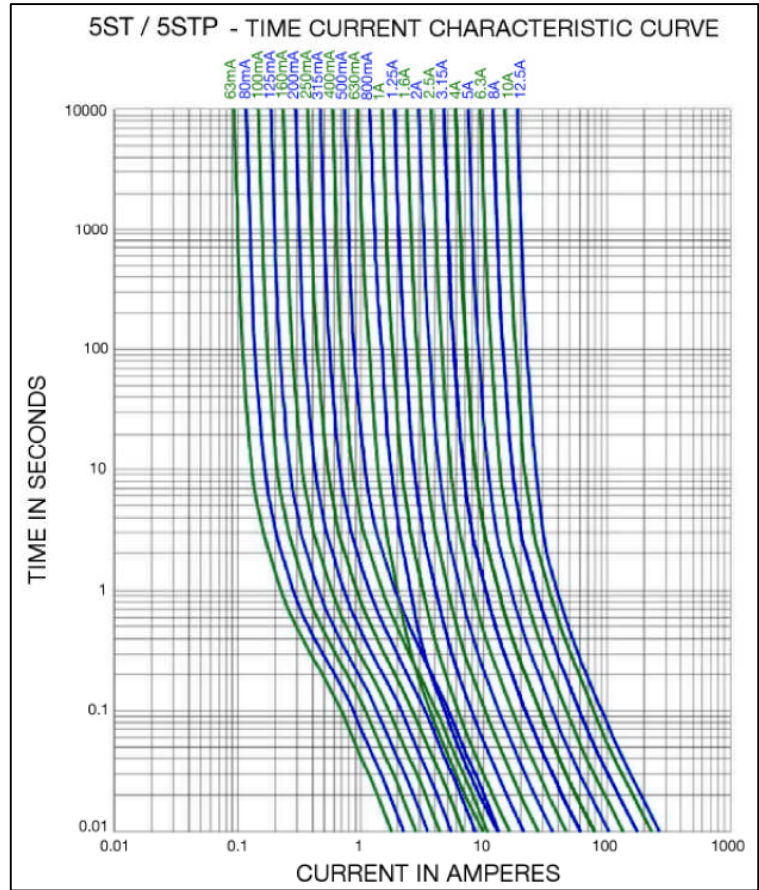

Soldering Parameters

Lead-free Wave Soldering Profile	
Wave Soldering Parameter	
Average ramp-up rate	200°C / second
Heating rate during preheat	typical 1 - 2°C / second Max 4°C / second
Final preheat temperature	within 125°C of soldering temperature
Peak temperature T _p	260°C
Time within +0°C / -5°C of actual peak temperature	10 seconds
Ramp-down rate	5°C / second max.

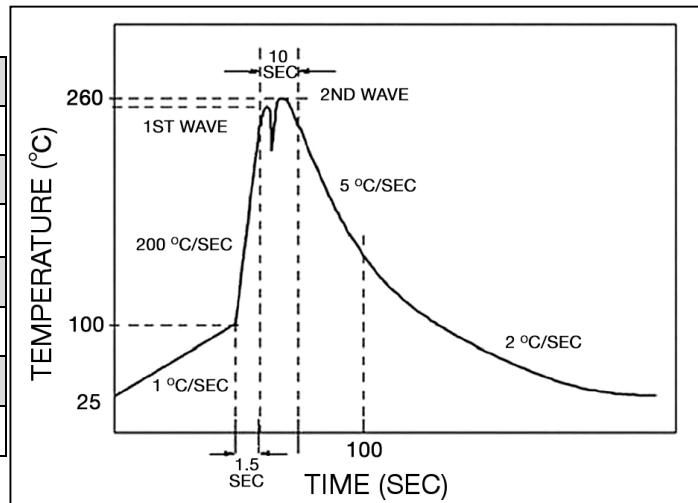

Fuse FGNO Explanation

0652 R [XXXX] -XX

[XXXX]=Ampere Rating; XX=See Ordering Information as below

Fraction	Decimal	Milliamps	Bel FGNO[XXXX]
1/16	0.063	63	0063
8/100	.080	80	0080
1/10	.100	100	0100
1/8	.125	125	0125
	.160	160	0160
2/10	.200	200	0200
1/4	.250	250	0250
	.315	315	0315
4/10	.400	400	0400
1/2	.500	500	0500
	.630	630	0630
8/10	.800	800	0800

Fraction	Decimal	Amps	Bel FGNO[XXXX]
	1.0	1	1000
1-1/4	1.25	1.25	1250
	1.60	1.6	1600
	2.0	2	2000
2-1/2	2.5	2.5	2500
	3.15	3.15	3150
	4.0	4	4000
	5.0	5	5000
	6.3	6.3	6300
	8.0	8	8000
		10	9100
		12.5	9125

Mechanical Dimensions

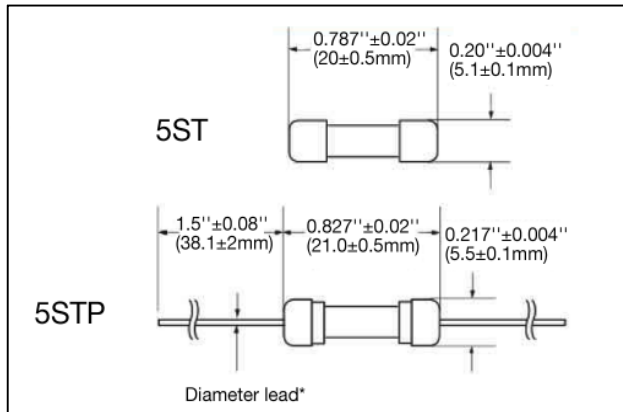

*Ratings 6.3A and less have 0.032" diameter lead;
 *Ratings 8A and above have 0.040" diameter lead.

Ordering Information

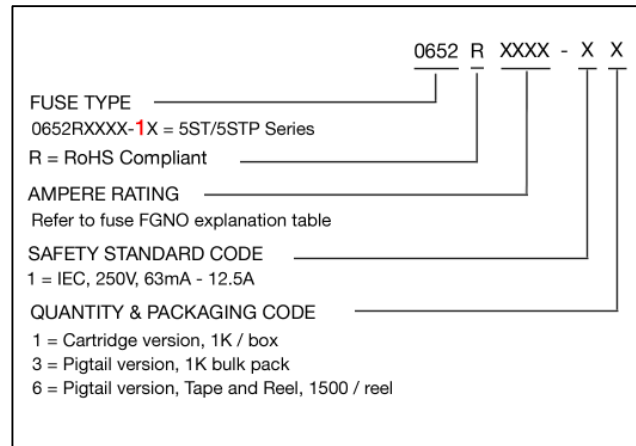

Packaging

Packaging Option	Packaging Specification	Quantity	Packaging Code	Inside Tape Spacing
Bulk	N/A	1000	11	N/A
Bulk (Pigtail Type)	N/A	1000	13	N/A
Tape & Reel, 10mm Pitch	EIA-296-F	1500	16	63



Specifications subject to change without notice

Bel Fuse Inc.
 206 Van Vorst Street
 Jersey City, NJ 07302 USA

+1 201.432.0463
 Bel.US.CS@belf.com
belfuse.com/circuit-protection