

## 216SP Series, 5x20 mm, Fast Acting Fuse



### Description

5x20mm fast acting ceramic body cartridge fuse Designed to IEC specification









### Features

- Designed to International (IEC) Standards for use globally
- High breaking capacity
- Meets the IEC 60127-2, Sheet 1 specification for Fast-Acting fuses
- RoHS compliant and lead-free

### Applications

Used as supplementary protection in appliance or utilization equipment to provide individual protection for components or internal circuits.

### Agency Approvals

Agency		Ampere Range
	NBK080205-E10480B NBK250702-E10480F	1A – 5A 6.3A – 10A
	CQC10012049970	1A – 10A
	SU05001-11001A SU05001-11002A	1A – 2.5A 3.15A – 6.3A
	E10480	1A – 10A
	29862	1A – 10A
	40013834	1 – 6.3A
	J50248090	8A/10A
	N/A	1A – 10A

### Electrical Characteristics for Series

% of Ampere Rating	Ampere Rating	Opening Time
210%	1A – 4A	30 minutes, Maximum
	5A – 6.3A	30 minutes, Maximum
	8A – 10A	30 minutes, Maximum
275%	1A – 4A	0.01 sec., Min.; 2 sec. Max.
	5A – 6.3A	0.01 sec., Min.; 3 sec. Max.
	8A – 10A	0.04 sec., Min.; 20 sec. Max.
400%	1A – 4A	.003 sec., Min.; 0.3 sec. Max.
	5A – 6.3A	.003 sec., Min.; 0.3 sec. Max.
	8A – 10A	.01 sec., Min.; 1.0 sec. Max.
1000%	1A – 4A	.02 seconds, Maximum
	5A – 6.3A	.02 seconds, Maximum
	8A – 10A	.03 sec.onds, Maximum

### Electrical Characteristic Specifications by Item

Amp Code	Amp Rating	Voltage Rating	Interrupting Rating	Nominal Resistance Cold Ohms (Ohms)	Nominal Melting I <sup>2</sup> t (A <sup>2</sup> sec)	Maximum Voltage Drop at Rated Current (mV)	Maximum Power Dissipation at 1.5I <sub>n</sub> (W)	Agency Approvals							
															
001	1	250	1500 A @ 250 VAC	0.2370	0.18000	1000	2.5	x	x	x	x	x	x		x
01.6	1.6	250		0.1112	1.00500	600	4	x	x	x	x	x	x		x
002	2	250		0.0764	1.87000	500	4	x	x	x	x	x	x		x
02.5	2.5	250		0.0584	3.67200	400	4	x	x	x	x	x	x		x
3.15	3.15	250		0.0368	6.70000	350	4	x	x	x	x	x	x		x
004	4	250		0.0247	14.99500	300	4	x	x	x	x	x	x		x
005	5	250		0.0183	27.46000	250	4	x	x	x	x	x	x		x
06.3	6.3	250		0.0137	56.43000	200	4	x	x	x	x	x	x		x
008	8	250		0.0123	64.31500	200	4	x	x		x	x		x	x
010	10	250		0.0079	154.34000	200	4	x	x		x	x		x	x

I<sup>2</sup>t test at 10x rated current

## Temperature Re-rating Curve

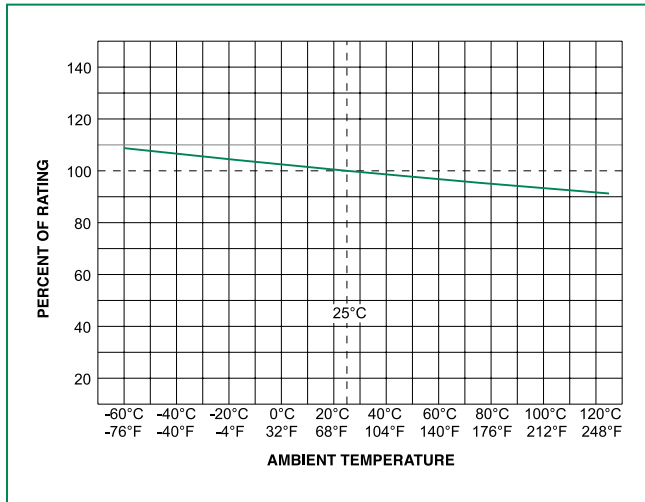

Note:  
Rerating depicted in this curve is in addition to the standard derating of 25% for continuous operation.

## Average Time Current Curves

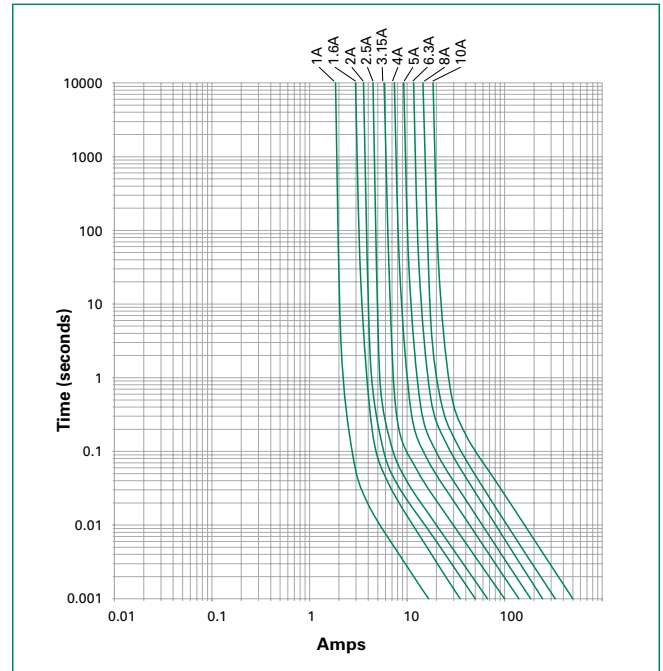

## Soldering Parameters - Wave Soldering

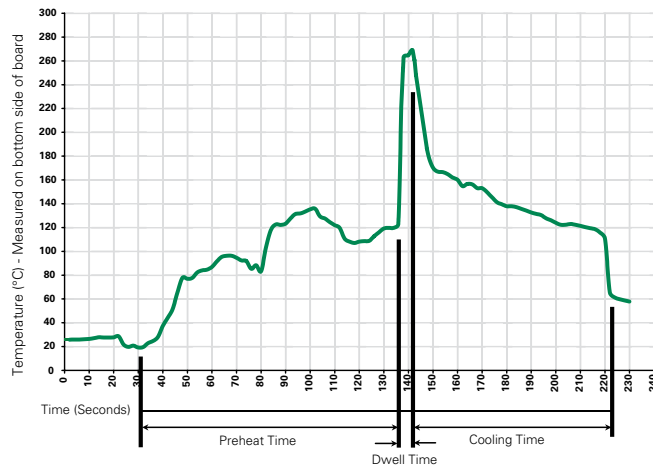

### Recommended Process Parameters:

Wave Parameter	Lead-Free Recommendation
<b>Preheat:</b> (Depends on Flux Activation Temperature) (Typical Industry Recommendation)	
Temperature Minimum:	100°C
Temperature Maximum:	150°C
Preheat Time:	60-180 seconds
<b>Solder Pot Temperature:</b>	260°C Maximum
<b>Solder Dwell Time:</b>	2-5 seconds

### Recommended Hand-Solder Parameters:

Solder Iron Temperature: 350°C +/- 5°C  
Heating Time: 5 seconds max.

**Note: These devices are not recommended for IR or Convection Reflow process.**

Different values of A and B available, please contact the Littelfuse sales representative in your region:

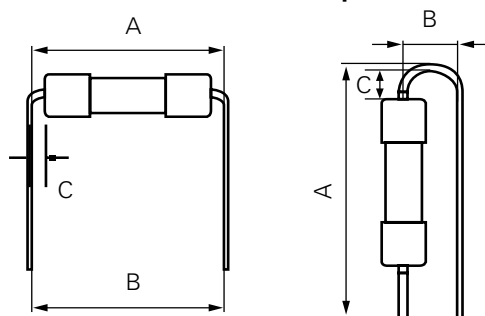

For the pigtailed fuse, please follow the recommendations below for axial lead forming and mounting into PCB:

### Lead forming:

The distance C between cap flat surface and axial lead shall be greater than 1.0 mm.

### PCB mounting:

According to the standard of IPC-A-610, the distance between PCB and fuse cap is recommended to be a minimum of 1.5 mm.

## Product Characteristics

<b>Materials</b>	<b>Body:</b> Ceramic <b>Cap:</b> Nickel-plated Brass <b>Leads:</b> Tin-plated Copper
<b>Terminal Strength</b>	MIL-STD-202, Method 211, Test Condition A
<b>Solderability</b>	MIL-STD-202 Method 208
<b>Product Marking</b>	<b>Cap 1:</b> Brand logo, current and voltage ratings <b>Cap 2:</b> Agency approval marks

<b>Operating Temperature</b>	-55°C to +125°C
<b>Thermal Shock</b>	MIL-STD-202, Method 107, Test Condition B (5 cycles, -65°C to +125°C)
<b>Vibration</b>	MIL-STD-202, Method 201
<b>Humidity</b>	MIL-STD-202, Method 103, Test Condition A (High RH (95%) and elevated temp (40°C) for 240 hours)
<b>Salt Spray</b>	MIL-STD-202, Method 101, Test Condition B

## Dimensions

All dimensions in mm

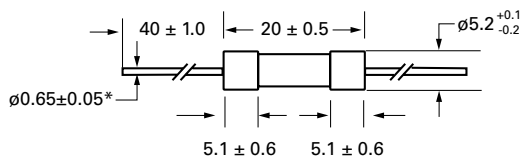

Notes:

\* Ratings 8A and 10A have 0.8 ± 0.05 diameter lead.

## Part Numbering System

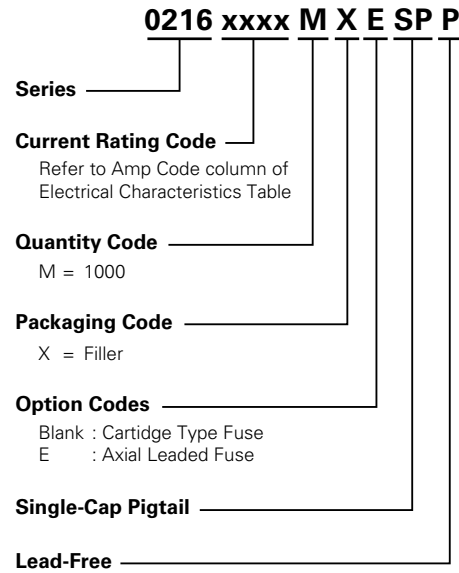

## Packaging

Packaging Option	Packaging Specification	Quantity	Packaging Code	Reel Size
<b>216SP Series</b>				
Bulk	N/A	1000	MXE	N/A

## Additional Information



Datasheet



Resources



Samples