

UMV 4301

**Open and closed loop speed controllers
for asynchronous and synchronous motors
Installation and maintenance**

UMV 4301

Open or closed loop speed controller for asynchronous and synchronous motors

NOTE

LEROY-SOMER reserves the right to modify the characteristics of its products at any time in order to incorporate the latest technological developments. The information contained in this document may therefore be changed without notice.

LEROY-SOMER gives no contractual guarantee whatsoever concerning the information published in this document and cannot be held responsible for any errors it may contain, nor for any damage resulting from its use.

CAUTION

For the user's own safety, this variable speed drive must be connected to an approved earth (\perp terminal).

If accidentally starting the installation is likely to cause a risk to personnel or the machines being driven, it is essential to supply the device via a circuit-breaking device (power contactor) which can be controlled via an external safety system (emergency stop, detection of errors on the installation).

The variable speed drive is fitted with safety devices which, in the event of a fault, control stopping and thus stop the motor. The motor itself can become jammed for mechanical reasons. Voltage fluctuations, and in particular power cuts, may also cause the motor to stop.

The removal of the causes of the shutdown can lead to restarting, which may be dangerous for certain machines or installations. In such cases, it is essential that the user takes appropriate precautions against the motor restarting after an unscheduled stop.

The variable speed drive is designed to be able to supply a motor and the driven machine above its rated speed.

If the motor or the machine are not mechanically designed to withstand such speeds, the user may be exposed to serious danger resulting from their mechanical deterioration.

It is important that the user checks that the installation can withstand it before programming a high speed.

The variable speed drive which is the subject of this manual is designed to be integrated in an installation or an electrical machine, and can under no circumstances be considered to be a safety device. It is therefore the responsibility of the machine manufacturer, the designer of the installation or the user to take all necessary precautions to ensure that the system complies with current standards, and to provide any devices required to ensure the safety of equipment and personnel.

Use of the speed controller for hoisting : if this application is selected, special instructions, available on request, **must** be observed.

The user is responsible for getting this instruction manual from his usual LEROY-SOMER contact.

LEROY-SOMER declines all responsibility in the event of the above recommendations not being observed.

.....

Manual corresponding to software version \geq **V 03.01.07**

Update of manual **2415 - 4.33/b - 6.98**

UMV 4301

Open or closed loop speed controller for asynchronous and synchronous motors

SAFETY AND OPERATING INSTRUCTIONS FOR SPEED CONTROLLERS (In accordance with the low voltage directive 73/23/EEC modified by 93/68/EEC)

 • Throughout the manual, this symbol warns against consequences which may arise from inappropriate use of the speed controller, since electrical risks may lead to material or physical damage as well as constituting a fire hazard.

1 - General

Depending on their degree of protection, the variable speed drives may contain unprotected live parts, which may be moving or rotating, as well as hot surfaces, during operation.

Unjustified removal of protections, incorrect use, faulty installation or inappropriate operation could represent a serious risk to personnel, animals and equipment.

For further information, consult the manual.

All work relating to transportation, installation, commissioning and maintenance must be performed by experienced, qualified personnel (see IEC 364 or CENELEC HD 384, or DIN VDE 0100 and national specifications for installation and accident prevention).

In these basic safety instructions, qualified personnel means persons competent to install, mount, commission and operate the product and possessing the relevant qualifications.

2 - Use

Variable speed drives are components designed for integration in installations or electrical machines.

When integrated in a machine, commissioning must not take place until it has been verified that the machine conforms with directive 97/37/EEC (Machinery Directive). It is also necessary to comply with standard EN 60024, which stipulates in particular that electrical actuators (which include variable speed drives) cannot be considered as circuit-breaking devices and certainly not as isolating switches.

Commissioning can take place only if the requirements of the Electromagnetic Compatibility Directive (89/336/EEC, modified by 92/31/EEC) are met.

The variable speed drives meet the requirements of the Low Voltage Directive 73/23/EEC, modified by 93/68/EEC. The harmonised standards of the DIN VDE 0160 series in connection with standard VDE 0660, part 500 and EN 60146/VDE 0558 are also applicable.

The technical characteristics and instructions concerning the connection conditions specified on the nameplate and in the documentation provided must be observed without fail.

3 - Transportation, storage

All instructions concerning transportation, storage and correct handling must be observed.

The climatic conditions specified in the technical manual must be observed.

4 - Installation

The installation and cooling of equipment must comply with the specifications in the manual supplied with the product.

The variable speed drives must be protected against any excessive stress. In particular, there must be no damage to parts and/or modification of the clearance between components during transportation and handling. Avoid touching the electronic components and contact parts.

The variable speed drives contain parts which are sensitive to electrostatic stresses and may be easily damaged if handled incorrectly. Electrical components must not be exposed to mechanical damage or destruction (risks to health!).

5 - Electrical connection

When work is performed on variable speed drives which are powered up, the national accident prevention regulations must be respected.

The electrical installation must comply with the relevant specifications (for example conductor cross-sections, protection via fused circuit-breaker, connection of protective conductor). More detailed information is given in the manual.

Instructions for an installation which meets the requirements for electromagnetic compatibility, such as screening, earthing, presence of filters and correct insertion of cables and conductors, are given in the documentation supplied with the variable speed drives.

These instructions must be followed in all cases, even if the variable speed drive carries the CE mark. Adherence to the limits given in the EMC legislation is the responsibility of the manufacturer of the installation or the machine.

6 - Operation

Installations in which variable speed drives are to be integrated must be fitted with additional protection and monitoring devices as laid down in the current relevant safety regulations, such as the law on technical equipment, accident prevention regulations, etc. Modifications to the variable speed drives using control software are permitted.

Active parts of the device and the live power connections must not be touched immediately after the variable speed drive is powered down, as the capacitors may still be charged. In view of this, the warnings fixed to the variable speed drives must be observed.

During operation, all doors and protective devices must be kept closed.

7 - Servicing and maintenance

Refer to the manufacturer's documentation.

This manual is to be given to the end user.

UMV 4301

Open or closed loop speed controller for asynchronous and synchronous motors

PREFACE

This manual describes how to commission digital technology **UMV 4301** flux vector control electronic speed drives. It gives details of all the procedures to be performed on the speed controller, and provides information on extension options.

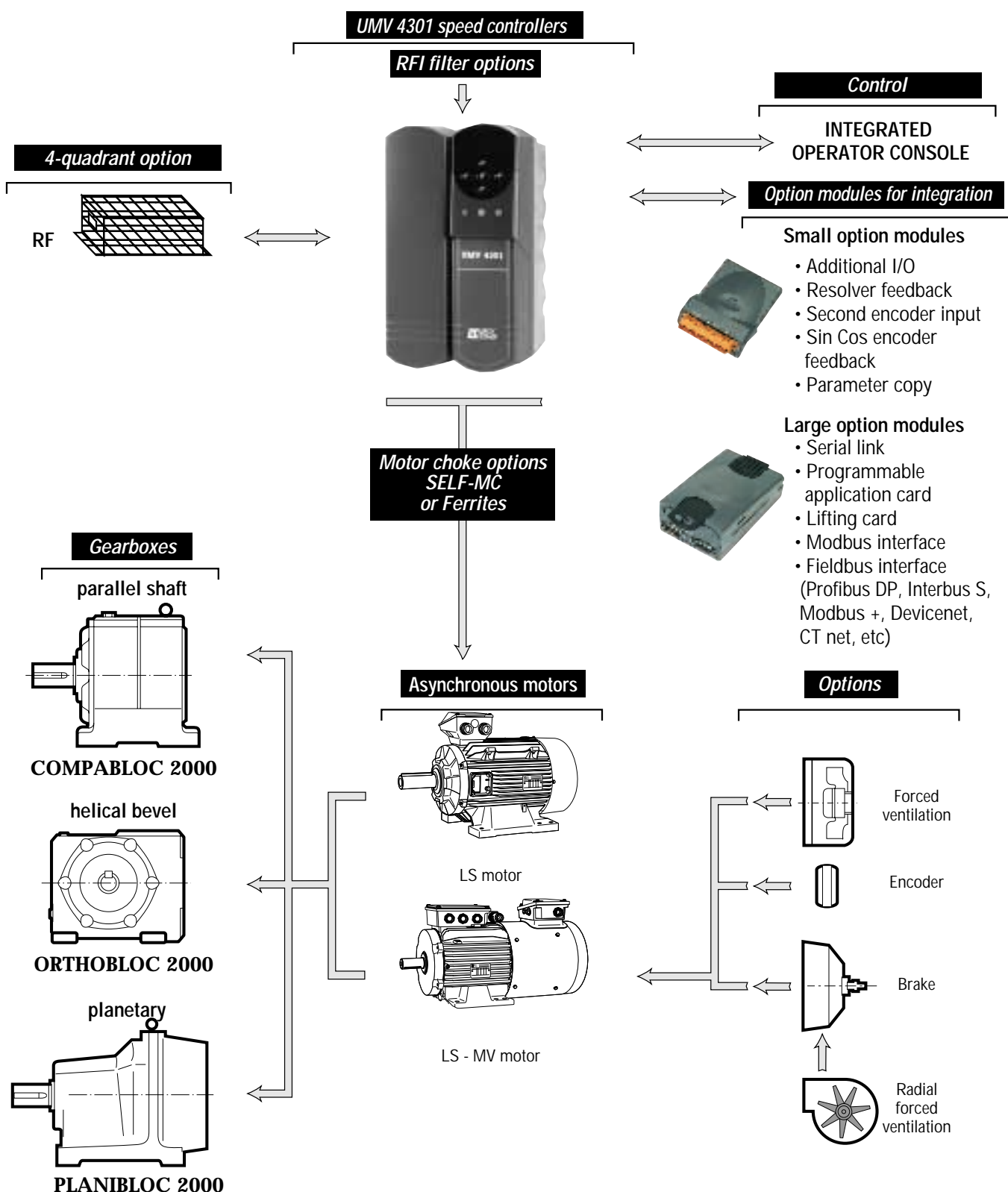

UMV 4301

Open or closed loop speed controller for asynchronous and synchronous motors

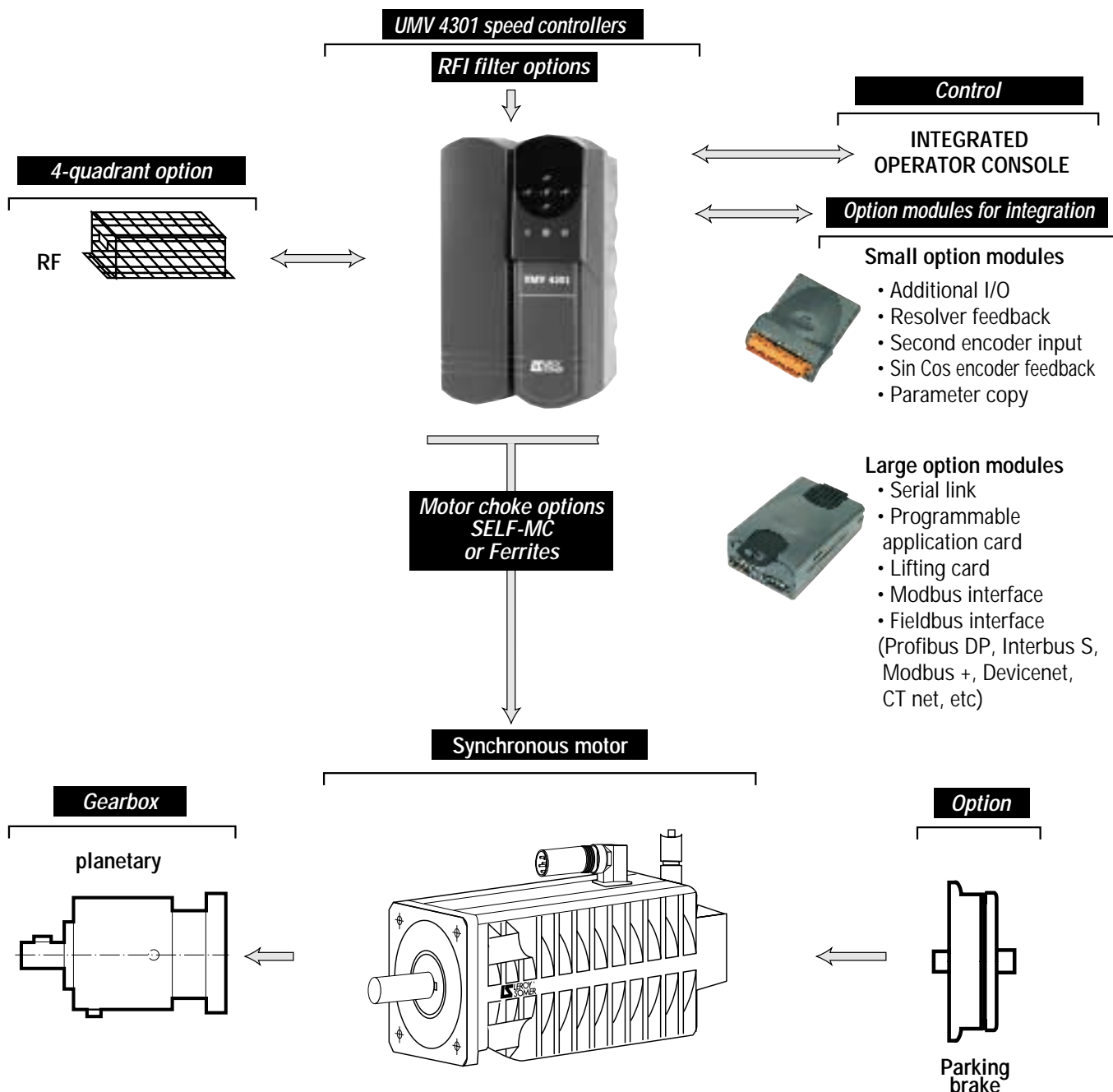

UMV 4301
Open or closed loop speed
controller for asynchronous and
synchronous motors

NOTES

UMV 4301

Open or closed loop speed controller for asynchronous and synchronous motors

CONTENTS

	Pages
1 - GENERAL INFORMATION	
1.1 - General operating principle	8
1.2 - Product designation	8
1.3 - Characteristics.....	9 to 11
1.4 - Environmental characteristics.....	12
1.5 - Weight and dimensions.....	13
2 - MECHANICAL INSTALLATION	
2.1 - Checks on receipt.....	14
2.2 - Installation precautions.....	14
2.3 - Installing the controller.....	14 to 17
3 - CONNECTIONS	
3.1 - Connecting an asynchronous motor.....	18 - 19
3.2 - Connecting the SMV UM synchronous motor.....	20 - 21
3.3 - Connecting the controller.....	21 to 24
3.4 - Description of cables and protection.....	25 - 26
3.5 - Special connections.....	27
3.6 - Electrical and electromagnetic phenomena.....	28 to 33
3.7 - Block diagrams.....	34 to 44
4 - COMMISSIONING	
4.1 - Using the operator console.....	45 to 47
4.2 - Starting up the controller.....	48 to 51
4.3 - Menu 0 - Factory configuration.....	52 to 70
4.4 - Other preset configurations.....	71 to 88
4.5 - Fault processing.....	89
4.6 - Other possibilities.....	90
5 - FAULTS - DIAGNOSTICS	
5.1 - Display indication - error messages.....	91 to 94
5.2 - Display of the controller status.....	95
5.3 - Display of controller alarms.....	95
5.4 - Indication via logic outputs.....	95
6 - MAINTENANCE	
6.1 - Introduction and advice.....	96
6.2 - Care.....	96
6.3 - Voltage, current and power measurements.....	96
6.4 - Spare parts list.....	96
6.5 - Replacement of products.....	96
7 - OPERATING EXTENSIONS	
7.1 - Small option modules.....	97
7.2 - Large option modules.....	97
7.3 - RF braking resistors.....	97 - 98
7.4 - R.F.I. filters.....	98 - 99
7.5 - Three-phase motor chokes for attenuation of leakage currents : Self MC.....	100
7.6 - Motor and encoder ferrites for attenuation of leakage currents.....	100
7.7 - INTERCOD 15 encoder connection interface.....	100
7.8 - UMVSOFT.....	100
8 - SUMMARY OF SETTINGS FOR YOUR APPLICATION.....	101 to 104

UMV 4301

Open or closed loop speed controller for asynchronous and synchronous motors

1 - GENERAL INFORMATION

1.1 - General operating principle

The **UMV 4301** is an AC controller for supplying asynchronous motors and synchronous (brushless) motors. The **UMV 4301** can therefore be configured in various operating modes, as follows :

1.1.1 - Open loop flux vector control

As a result of its calculating power, the controller controls the magnetizing current and the active current for a standard asynchronous motor separately. The speed and position of the rotor are calculated to control the torque and speed of the motor. This open loop operating mode gives very high levels of performance and is thus suitable for the majority of applications.

1.1.2 - Closed loop flux vector control

The use of the closed loop flux vector control mode on a standard asynchronous motor fitted with an incremental encoder for the position and exact speed of the rotor gives better control of the torque and speed of the motor over a wider speed range (including zero speed), with enhanced dynamic performance.

1.1.3 - Open loop operation with voltage/frequency (V/F) control

The controller simultaneously controls the voltage and the frequency at the terminals of the asynchronous motor. This operating mode is used for particular applications for which open loop flux vector control does not provide the required performance levels (several motors supplied by a single controller, etc).

1.1.4 - Operation with synchronous (brushless) motor

The use of the SERVO mode with a synchronous motor (motor with rotor fitted with permanent magnets) equipped with an incremental encoder or resolver provides very high dynamic performance levels, for example for driving axes.

1.1.5 - Power module

The **UMV 4301** controller uses an inverter bridge with IGBT transistors.

This advanced technology considerably reduces the noise and temperature rise for variable speed motors.

The performance of the **UMV 4301** is ideally suited to use in all 4 quadrants of the torque-speed diagram.

During periods of operation in generator mode, the energy restored by the motor is dissipated by resistors.

1.1.6 - Diagram

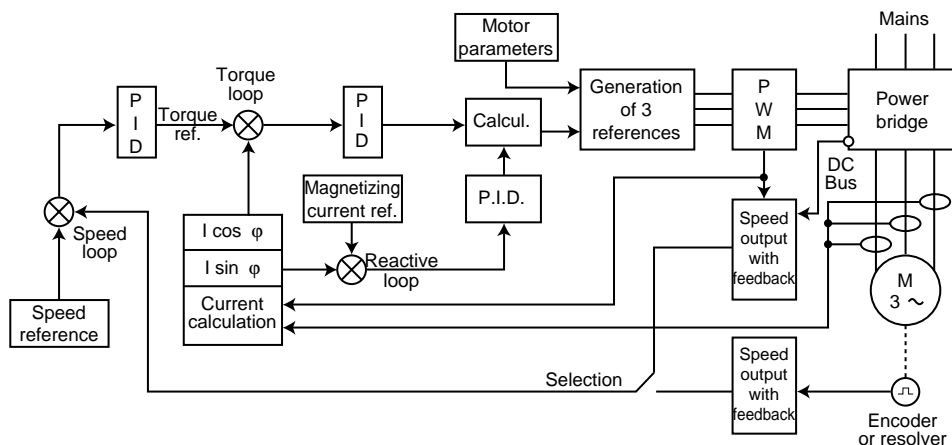

1.2 - Product designation

UMV 4301 : speed controller with voltage/frequency (V/F) control, and open or closed loop flux vector control, for synchronous servo motor.

2.5 = Rating in kVA at 400V,

T = 400V 3-phase supply or **TL** = 230V 3-phase supply.

This designation appears on the nameplates located on the upper side of the speed controller.



LEROY SOMER

Il est indispensable de lire la notice avant de raccorder cet appareil.

Après mise hors tension, attendre 10 minutes pour toute intervention dans l'appareil.

UMV 4301 2,5T

CT Ref : UNI 1403

It is essential to read the instructions before connecting the inverter.

After switching off the inverter, wait 10 minutes before performing maintenance or inspection.

ENTRÉE / INPUT	SORTIE / OUTPUT
3 Ph 380/480V	3 Ph 0-380/480 V
5.3 A	1.5 kW
	3.8 A
	5.6 A/60s

Input characteristics

Serial number

N° : 3709287008 SW : 3.01.07

Output characteristics

Software version



UMV 4301

Open or closed loop speed controller for asynchronous and synchronous motors

1.3 - Characteristics

1.3.1 - Main electrical characteristics

Input power supply	3-phase supply : 200 to 240V ± 10 % (TL) 380V to 480V ± 10 % (T)
Input frequency	48Hz to 62Hz
Phase imbalance at input	≤ 3 %
Output voltage	From 0V to supply voltage
Maximum number of power-ups per hour	20

1.3.2 - Electrical output characteristics at 40°C (50°C in brackets)

UMV 4301 rating	CT ref.	Characteristics for switching freq. = 3kHz				Continuous rated current for switching frequency > 3 kHz			
		Motor output power at 400V (kW)	Continuous rated current (A)	Overload current for 60s (A)	Peak current for 4s (A)	4.5 kHz (A)	6 kHz (A)	9 kHz (A)	12 kHz (A)
1.5T	UNI 1401	0.75	2.1 (2.1)	3.1	3.7	2.1 (2.1)	2.1 (2.1)	2.1 (2.1)	2.1 (2.1)
2T	UNI 1402	1.1	2.8 (2.8)	4.2	4.9	2.8 (2.8)	2.8 (2.8)	2.8 (2.8)	2.8 (2.8)
2.5T	UNI 1403	1.5	3.8 (3.8)	5.6	6.7	3.8 (3.8)	3.8 (3.8)	3.8 (3.8)	3.8 (3.3)
3.5T	UNI 1404	2.2	5.6 (5.6)	8.3	9.9	5.6 (5.6)	5.6 (5.1)	5.6 (4.0)	4.5 (3.3)
5.5T	UNI 1405	4	9.5 (6.9)	14.1	16.8	9.5 (5.9)	8.5 (5.1)	7 (4.0)	5.5 (3.3)
8T	UNI 2401	5.5	12 (12)	17.9	21.2	12 (12)	12 (12)	12 (11.6)	11.7 (9.7)
11T	UNI 2402	7.5	16 (16)	23.8	28.2	16 (16)	16 (14.7)	14.2 (11.6)	11.7 (9.7)
16T	UNI 2403	11	25 (20)	37.2	44.1	21.7 (17.3)	18.2 (14.7)	14.2 (11.6)	11.7 (9.7)
22T	UNI 3401	15	34 (34)	50.6	60	34 (34)	34 (28)	28 (21)	23 (17.9)
27T	UNI 3402	18.5	40 (40)	59.6	70.6	40 (34)	37 (28)	28 (21)	23 (17.9)
33T	UNI 3403	22	46 (44)	68.5	81.2	46 (36)	40 (31)	32 (24)	26.6 (20.6)
40T	UNI 3404	30	60 (44)	89.4	106	47 (36)	40 (31)	32 (24)	26.7 (20.9)
50T	UNI 3405	37	70 (50)	114.7	136	56 (41)	46 (34)	35 (26)	28 (23)
60T	UNI 4401	45	96 (95)	143	169.5	96 (85)	88 (75)	70 (60)	X
75T	UNI 4402	55	124 (105)	184.7	219	104 (85)	88 (75)	70 (60)	X
100T	UNI 4403	75	156 (135)	232.3	275.5	124 (105)	105 (85)	80 (65)	X
120T	UNI 4404	90	180 (168)	268	317.8	175 (150)	145 (125)	110 (95)	X

UMV 4301 rating	CT ref.	Caractéristiques pour f découpage = 3kHz				Intensité nominale permanente pour f découpage > 3 kHz			
		Motor output power at 230V (kW)	Continuous rated current (A)	Overload current for 60s (A)	Peak current for 4s (A)	4.5 kHz (A)	6 kHz (A)	9 kHz (A)	12 kHz (A)
1TL	UNI 1201	0.37	2.1 (2.1)	3.1	3.7	2.1 (2.1)	2.1 (2.1)	2.1 (2.1)	2.1 (2.1)
1.2TL	UNI 1202	0.55	2.8 (2.8)	4.2	4.9	2.8 (2.8)	2.8 (2.8)	2.8 (2.8)	2.8 (2.8)
1.5 TL	UNI 1203	0.75	3.8 (3.8)	5.6	6.7	3.8 (3.8)	3.8 (3.8)	3.8 (3.8)	3.8 (3.3)
2 TL	UNI 1204	1.1	5.6 (5.6)	8.3	9.9	5.6 (5.6)	5.6 (5.1)	5.6 (4.0)	4.5 (3.3)
3.5TL	UNI 1205	2.2	9.5 (6.9)	14.1	16.8	9.5 (5.9)	8.5 (5.1)	7 (4.0)	5.5 (3.3)
4.5TL	UNI 2201	3	12 (12)	17.9	21.2	12 (12)	12 (12)	12 (11.6)	11.7 (9.7)
5.5TL	UNI 2202	4	16 (16)	23.8	28.2	16 (16)	16 (14.7)	14.2 (11.6)	11.7 (9.7)
8TL	UNI 2203	5.5	25 (20)	37.2	44.1	21.7 (17.3)	18.2 (14.7)	14.2 (11.6)	11.7 (9.7)
11TL	UNI 3201	7.5	34 (34)	50.6	60	34 (34)	34 (28)	28 (21)	23 (17.9)
16TL	UNI 3202	11	46 (44)	68.5	81.2	46 (36)	40 (31)	32 (24)	26.6 (20.6)
22TL	UNI 3203	15	60 (44)	89.4	106	47 (36)	40 (31)	32 (24)	26.7 (20.9)
27TL	UNI 3204	22	74 (50)	111	130	56 (41)	46 (34)	35 (26)	28 (23)

X : Frequency not available

WARNING :

At 50°C, ensure that parameter 0.46 (motor rated current) does not exceed the value mentioned in the table above.

UMV 4301



Open or closed loop speed controller for asynchronous and synchronous motors

1.3.3 - Characteristics and main functions available in basic menu 0

CHARACTERISTIC	UMV 4301 1.5T to 16T - 1TL to 8TL	UMV 4301 22T to 50T - 11TL to 33TL	UMV 4301 60T to 120T
Regulation mode	<ul style="list-style-type: none"> • Vector control, open loop • Vector control, closed loop • Voltage/frequency ratio (V/F) • Servomotor 		
Regulation	<ul style="list-style-type: none"> • Speed reference • Torque reference (regulation of motor current) 		
Constant torque Constant power	Adjusted by basic frequency		
Switching frequency	3 - 4.5 - 6 - 9 and 12 kHz Depending on the rating, derating according to the switching frequency or automatic adjustment of the switching frequency according to the load		
Overload capacity	<ul style="list-style-type: none"> • 150 % of controller rated current for 60s • 175 % of controller rated current for 4s (in servomotor mode) 		
Braking	<ul style="list-style-type: none"> • Hypersynchronous. Controller alone or with RF options • By DC injection 		
Speed feedback for closed loop operation	<ul style="list-style-type: none"> • By incremental encoder (2 complementary channels + 0 marker) • By incremental encoder (2 complementary channels + 0 marker + 3 complem. channels per phase U, V, W) in servomotor mode • By resolver + RLV UMV option card in servomotor mode 		
CONTROL			
Control logic	<ul style="list-style-type: none"> • Negative { high level > + 15V • Positive { low level < + 5V 		
Speed references	<ul style="list-style-type: none"> • Analogue : <ul style="list-style-type: none"> - differential voltage $\pm 10V$ (input impedance : 100 KΩ) - voltage $0/\pm 10V$ in common mode (input impedance : 100 KΩ) - current 0-20mA, 4-20mA or 20-0mA, 20-4mA • Digital : <ul style="list-style-type: none"> - from keypad - by jogging 		
Torque reference	<ul style="list-style-type: none"> • Analogue : <ul style="list-style-type: none"> - voltage $0/\pm 10V$ in common mode (input impedance : 100 KΩ) - current 0-20mA, 4-20mA or 20-0mA, 20-4mA (input impedance : 100 Ω) • Digital : <ul style="list-style-type: none"> - from keypad by incrementation 		
Speed regulation	Adjustment by programming the "proportional" and "integral" and "derivative" coefficients of the speed loop		
Forward/reverse control	<ul style="list-style-type: none"> • By inversion of the reference polarity • By logic input • From the operator console 		
Self-adaptation of the controller to the motor	Measurement of the motor characteristics ($\cos \phi$, magnetizing current and stator resistance) and the encoder feedback.		
OPERATION			
Acceleration / deceleration ramps	Separate settings from 0 to 3200s. Linear or "S" curve. The radius of the "S" ramp can be adjusted.		
Minimum/maximum speed limit	Speed variation between two stops.		
Stopping mode	<ul style="list-style-type: none"> • Freewheel stop : by logic input (terminal 30) immediate cut-off of motor power supply. • Stop on ramp (following different modes). • DC injection braking stop. • Orientation stop in specific position (closed loop). 		
Dynamic V/F selection	Automatic adaptation of the V/F curve to the motor load in V/F mode.		
Flying restart	Ability of the controller to start while the motor is running.		

UMV 4301

Open or closed loop speed controller for asynchronous and synchronous motors

PRESET CONFIGURATIONS	UMV 4301 1.5T to 16T - 1TL to 8TL	UMV 4301 22T to 50T - 11TL to 33TL	UMV 4301 60T to 120T
Configuration 1	Simplified local/remote operation		
Configuration 2	Motorised potentiometer : speed reference by faster / slower command		
Configuration 3	Preset speeds : possibility of 4 preset speeds		
Configuration 4	Torque control with speed limit		
Configuration 5	PID control		
Configuration 6	Axis control : Run/Stop control via limit switches		
Configuration 7	Brake control		
Configuration 8	Electrical shaft : Synchronization mode ( and )		
FAULTS			
Processor fault	Internal fault in controller and options.		
External fault	Fault forced via the terminal block (terminal 30).		
Overload (I x t)	Electronic thermal overload relay for the motor and the braking resistor.		
Overheating	<ul style="list-style-type: none"> • Controller : radiator and electronic cards. • Motor : by PTC probe : <ul style="list-style-type: none"> - trip for PTC > 3 kΩ, - reset for PTC \leq 1.65 kΩ, - PTC short-circuit detection, (\leq 4 Ω in TH SC mode) <p style="text-align: center;">by PTO probe.</p>		
Overcurrent	200 % of rated current. Short-circuit : phase-phase/phase-earth.		
Phase loss Phase imbalance	Mains power cut.		
Under- and overvoltage DC bus	DC bus voltage outside its operating range.		
Internal power supply	Monitoring of controller internal power supplies.		
Encoder	Wiring fault or encoder feedback missing (during the " autotune " phase).		
SIGNALLING			
Display	On the operator console : - output frequency (Hz) or motor speed (min ⁻¹), - output current (A).		
Relay	Relay 250 VAC - 5A (resistive load)		
Logic output	Commutator open : external source from 0 to +24V 100 mA Active : - open loop : at speed, - closed loop : zero speed.		
Analogue output	- 0 to \pm 10V 10mA		
OPTIONS			
Radio interference suppression filters	FLT 5101 - 10 FLT 5106 - 16 FLT 5106 - 25	FLT 5113 - 50 FLT 5113 - 63 FLT 5113 - 100	FLT 5113 - 150 FLT 5113 - 180
Motor chokes for attenuation of leakage currents	Self MC 3.5T, 11T and 27T	Self MC 27T and 50T	Self MC 75T and 120T
Motor ferrites and encoder for attenuation of leakage currents	Ferrite FRT 4200		
Small option modules	For integration in the UMV 4301 - 2nd encoder input : Cod 2 UMV Sin Cos encoder feedback : SIN COS UMV - resolver feedback : RLV UMV parameter copy : COPY UMV - additional I/O : ES UMV		
Large option modules	For integration in the UMV 4301 - RS 485 and RS 232 serial link, protocol ANSI x 3.28 : COM 1 UMV - fieldbus interface (Profibus DP, Interbus S, Modbus +, Devicenet, CT net, etc) - programmable application card : CAP - UMV.		
Resistance braking RF	RF 320T to RF 55000T according to ratings		

UMV 4301

Open or closed loop speed controller for asynchronous and synchronous motors

1.4 - Environmental characteristics

-  • UMV 4301 controllers have a protection index of IP 40.
• They are designed for installation in cubicles or enclosures in order to protect them from conductive dust and condensation. Access to non-qualified personnel should be prohibited.

1.4.1 - General

Characteristics	Level
Enclosure protection	IP40 with gland plates and cable glands fitted.
Storage temperature	- 40 °C to + 50 °C, 12 months maximum.*
Operating temperature	- 5 °C to + 40 °C without derating, up to +50°C with derating (§ 1.3.2).
Altitude	• ≤ 1000 m without derating. • Derating : 1 % of I _n per 100 m above 1000m, up to 4000m maximum.
Humidity	• Relative humidity = 95 % without condensation at 40°C.
Vibration	Conforming to IEC 68-2-34
shocks	Conforming to IEC 68-2-27
Immunity	Conforming to : - EN 61000 - 4 - 2 Level 3 - EN 61000 - 4 - 6 Niveau 3 - EN 61000 - 4 - 3 Level 3 - EN 61800 - 3 - EN 61000 - 4 - 4 Level 3 (power), level 4 (control)
Emissions	conducted Conforming to : - EN 50081-1 (VDE 875 N) see tables § 3.6.7.2 - EN 50081-2 (VDE 875 G)
	radiated Conforming to EN 50081-2

* **WARNING :**

Follow the maintenance instructions in § 6.

1.4.2 - Table of losses in W

This table indicates the maximum value of the drive losses at I_{nom} (including the option losses when fitted in the drive).

Switching frequency	UMV 4301																
	1.5T	2T	2.5T	3.5T	5.5T	8T	11T	16T	22T	27T	33T	40T	50T	60T	75T	100T	120T
3 kHz	80	90	100	130	180	210	270	400	570	660	730	950	1090	1460	1910	2370	2460
4.5 kHz	80	90	110	130	190	230	290	380	620	720	800	830	990	1610	1780	2130	2890
6 kHz	90	100	110	140	190	250	310	360	670	730	770	790	920	1630	1670	2030	2700
9 kHz	90	100	120	150	190	280	320	330	660	660	730	740	850	1530	1560	1860	2470
12 kHz	90	110	130	150	170	310	310	310	630	630	700	710	800	-	-	-	-

Switching frequency	UMV 4301												
	1TL	1.2TL	1.5TL	2TL	3.5TL	4.5TL	5.5TL	8TL	11TL	16TL	22TL	33TL	
3 kHz	80	90	100	130	180	210	270	400	570	730	950	1090	
4.5 kHz	80	90	110	130	190	230	290	380	620	800	830	990	
6 kHz	90	100	110	140	190	250	310	360	670	770	790	920	
9 kHz	90	100	120	150	190	280	320	330	660	730	740	850	
12 kHz	90	110	130	150	170	310	310	310	630	700	710	800	

1.4.3 - Table of forced ventilation flow rates (m³/h)

Forced ventilation	UMV 4301		
	1.5T to 16T - 1TL to 8TL	22T to 50T - 11TL to 33TL	60T à 120T
Flow rate (m ³ /h)	85 m ³ /h	320 m ³ /h	640 m ³ /h

UMV 4301

Open or closed loop speed controller for asynchronous and synchronous motors

1.5 - Weight and dimensions

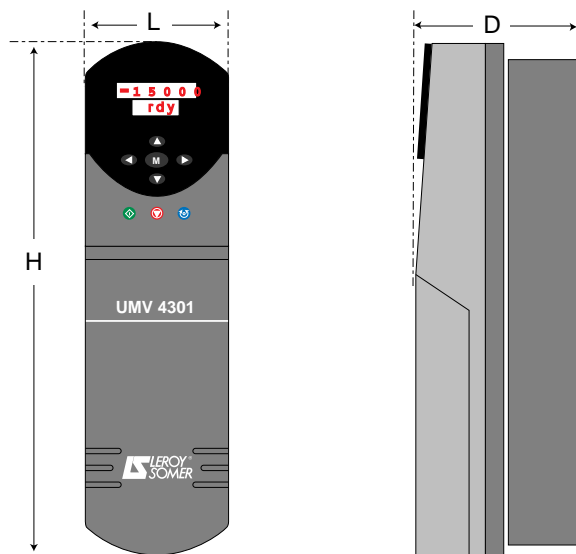

UMV 4301 rating	Dimensions (mm)			Weight (kg)
	H	L	P	
1.5T à 5.5T 1TL à 3.5TL	335	95	200	4
8T à 16T 4.5TL à 8TL	335	190	200	8
22T à 50T 11TL à 33TL	335	375	260	22
60T à 120T	700	500	260	70

1.6 - UL listing information

The drive complies with UL listing requirements only when the following are observed :

- the drive is installed in a type 1 enclosure or better, as defined by UL 50,
- UL listed fuses class RK 1600V AC are used in the AC supply,
- class 1 60/75°C copper wire only is used,
- the ambient temperature must not exceed 40°C when the drive is operating,
- the terminal tightening torques have to be used according to § 3.3.

The drive is suitable for use in a circuit capable of delivering not more than 5000 RMS symmetrical Amperes (10000A for UMV 4301 60 to 120T) at 528V AC rms maximum for the 400V three-phase drives (T), and at 268V AC rms maximum for the 230V three-phase drives (TL).

UMV 4301

Open or closed loop speed controller for asynchronous and synchronous motors

2 - MECHANICAL INSTALLATION



• It is the responsibility of the owner or the user to ensure that the installation, operation and care of the controller and its options comply with legislation relating to the safety of machinery and personnel and with the current regulations of the country in which it is used.

• UMV 4301 controllers must be installed in an environment free from conducting dust, fumes, corrosive gases and fluids, and condensation (for example class 2 according to UL 840 and IEC 60335-1). The controller must not be installed in hazardous areas unless they are enclosed in a specially adapted cubicle. In this case the installation must be certified.

• In atmospheres subject to the formation of condensation, a heating system must be installed. This system should operate when the controller is not in use, and be powered down when the controller is operating. Ideally this heating system should be controlled automatically.

• The housing of the UMV 4301 is not fire-proof. It may therefore be necessary to use a fire-proof enclosure.

• UMV 4301 units larger than the 22T and 11TL weigh more than 22 kg. They must be handled using appropriate handling equipment.

2.1 - Checks on receipt

Before installing the controller, check that :

- the controller has not been damaged during transport,
- the mounting accessories are included,
- the nameplate corresponds to the mains supply and the motor.

2.2 - Installation precautions

The controller should be mounted vertically with a clearance of 100 mm above and below. Except for the 11TL to 33TL ratings, leave a 150mm space above the drive and 100mm below.

Do not place the UMV 4301 above a heat source or another controller. There is a risk of tripping when the heatsink temperature reaches 90°C.

Never obstruct the controller ventilation grilles.

The UMV 4301 60T to 120T are fitted with two M10 tapped holes on the upper part of the heatsink for fitting lifting eyes.

2.3 - Installing the controller

2.3.1 - General

The controller can be installed in two ways :

With the heatsink inside or outside the enclosure. With the latter configuration it is not necessary to dissipate the controller losses.

- UMV 4301 from 1.5T to 5.5T and 1TL to 3.5TL

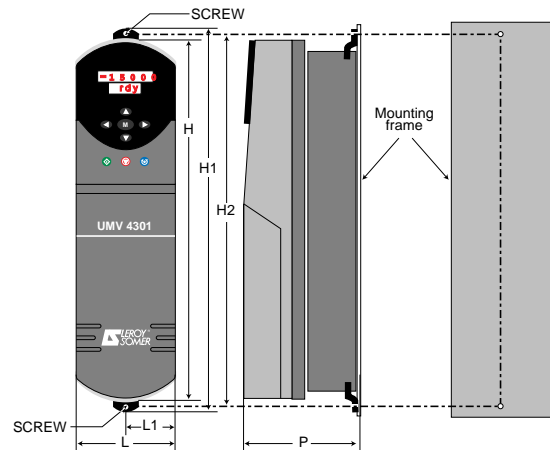

- UMV 4301 from 8T to 16T and 4.5TL to 8TL

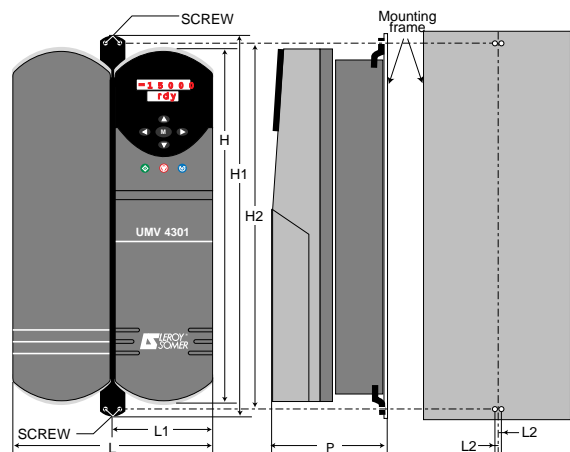

UMV 4301

Open or closed loop speed controller for asynchronous and synchronous motors

- UMV 4301 from 22T to 50T and 11TL to 33TL

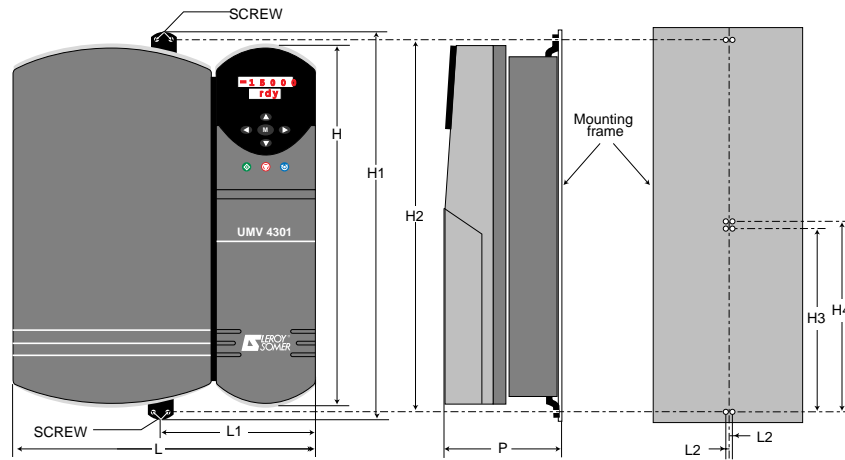

- UMV 4301 from 60T to 120T

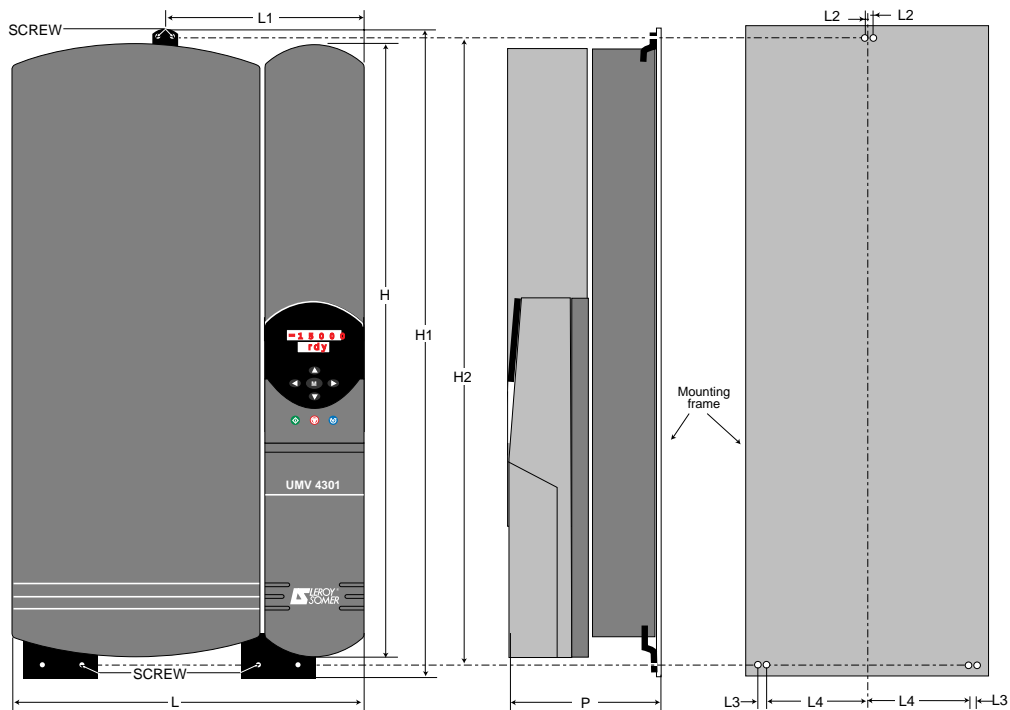

Dimensions

UMV 4301 rating	Dimensions (mm)											
	H	H1	H2	H3	H4	L	L1	L2	L3	L4	P	SCREW
1.5T to 5.5T 1TL to 3.5TL	335	366	343.5	-	-	95	47.5	-	-	-	200	M6
8T to 16T 4.5TL to 8TL	335	366	343.5	-	-	190	95	16.5	-	-	200	M6
22T to 50T 11TL to 33TL	335	368	346	175	220	375	187.5	16.5	-	-	260	M6
60T to 120T	700	765	713	-	-	500	250	17	65	143.5	260	M6

2.3.2 - Mounting with the heatsink inside the enclosure

The UMV 4301 1.5T to 16T and 1TL to 8TL must be fitted on a solid base plate in order to direct the flow of cooling air correctly.

The UMV 4301 22T to 120T and 11TL to 33TL can also be installed on a grille, a frame or a DIN rail.

- Insert the mounting feet in the grooves at the top and bottom of the heatsink,
- Fix the feet onto the base plate, the DIN rail or the grille with M6 screws.

UMV 4301

Open or closed loop speed controller for asynchronous and synchronous motors

2.3.3 - Mounting heatsink outside the enclosure

- 1 - Cut out and drill the rear panel of the enclosure.
- 2 - Insert a mounting foot in the groove at the top of the controller.
- 3 - For UMV 4301 ratings 1.5T to 5.5T, 1TL to 3.5TL, 22T to 50T, 11TL to 33TL and 60T to 120T, remove the lower terminal block cover to access the fixing holes.

- 4 - Place the gasket supplied with the controller on the flange.
- 5 - Insert the controller in the rear panel cutout.
- 6 - Fasten the controller by the upper mounting and via the lower holes.

WARNING :
Ensure that there is an adequate air flow at the rear of the enclosure.

- Cutout drawings UMV 4301 from 1.5T to 5.5T and 1TL to 3.5TL

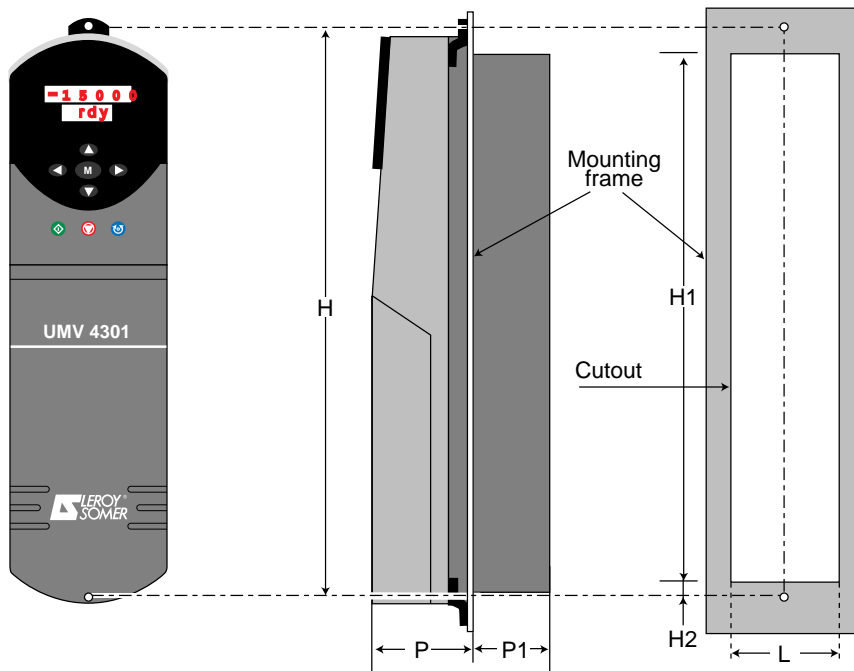

UMV 4301 from 8T to 16T and 4.5TL to 8TL

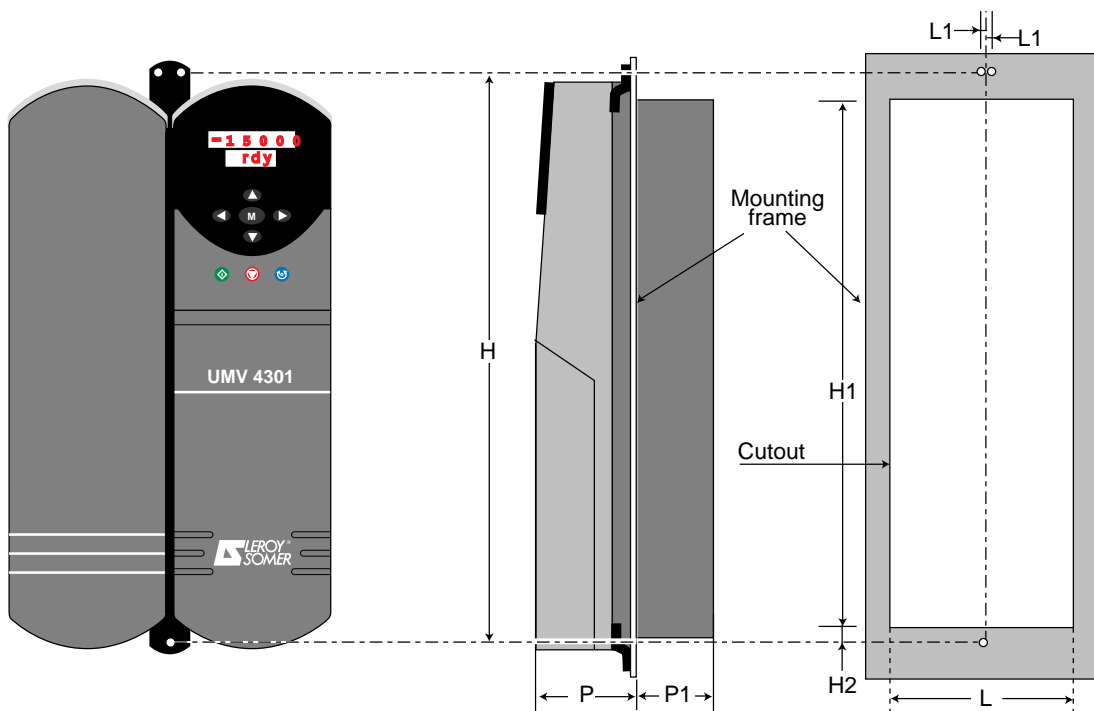

UMV 4301

Open or closed loop speed controller for asynchronous and synchronous motors

- Cutout drawings (continued)

UMV 4301 from 22T to 50T and 11TL to 33TL

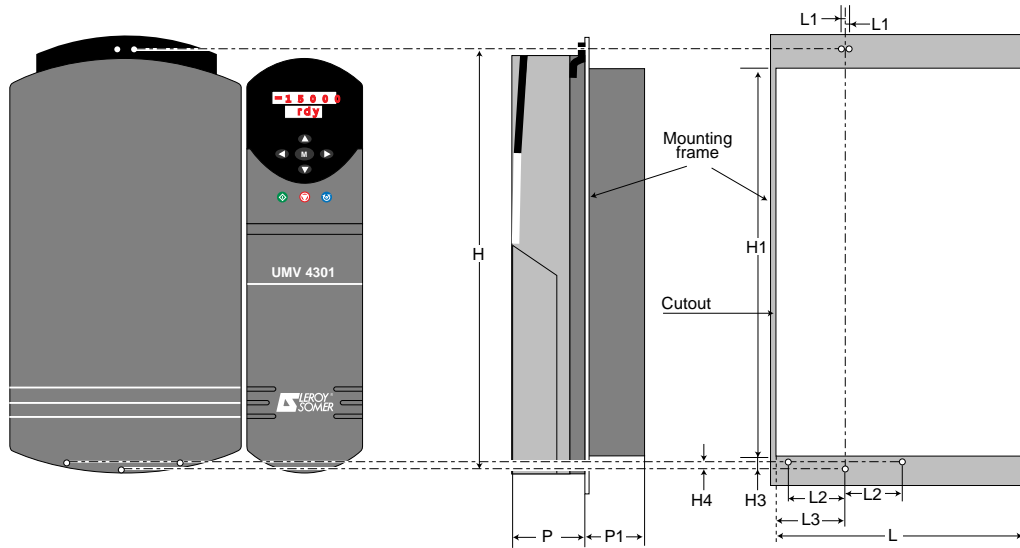

UMV 4301 from 60T to 120T

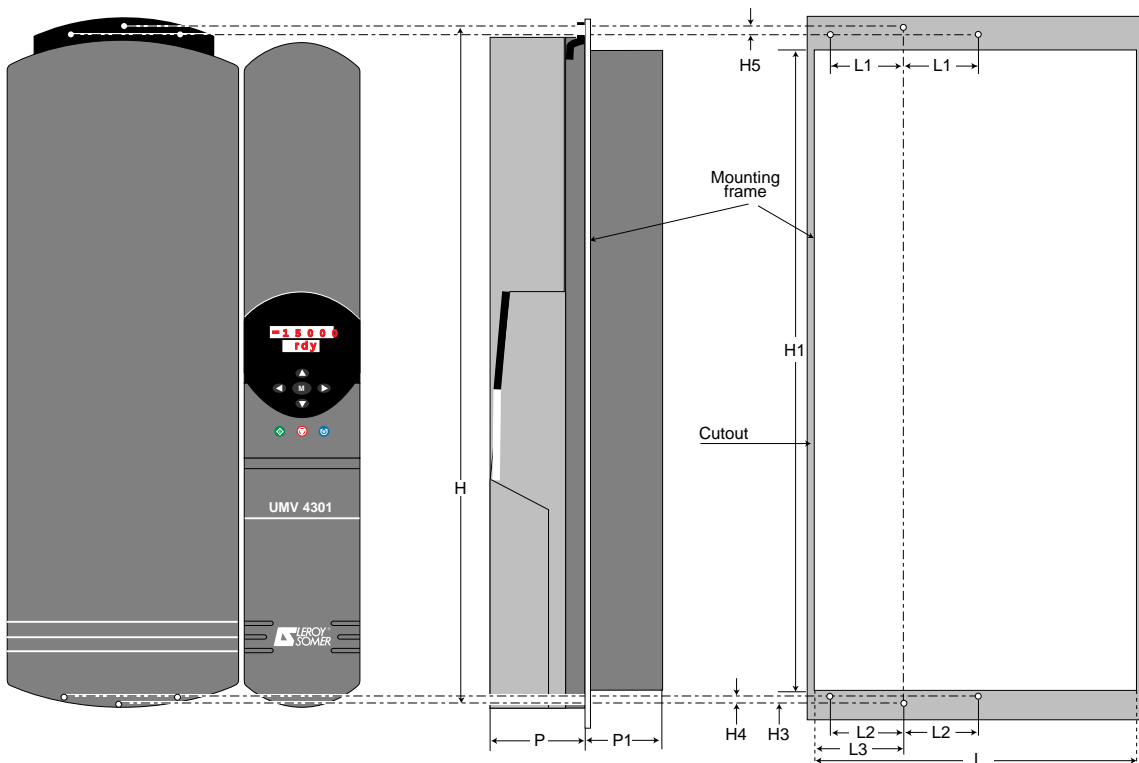

Dimensions (mm)

UMV 4301 rating	Dimensions (mm)												
	H	H1	H2	H3	H4	H5	L	L1	L3	L2	P*	P1**	SCREW
1.5T to 5.5T 1TL to 3.5TL	345	295	13	-	-	-	86.5	-	-	-	120	80	M6
8T to 16T 4.5TL to 8TL	345	295	13	-	-	-	182	16.5	-	-	120	80	M6
22T to 50T 11TL to 33TL	345	287	-	16	7	-	358	16.5	131.5	69	120	140	M6
60T to 120T	717.5	650	-	17	7.5	3.5	482	65	192	130	120	140	M6

* Add the thickness of the gasket.

** Subtract the thickness of the gasket.

UMV 4301

Open or closed loop speed controller for asynchronous and synchronous motors

3 - CONNECTIONS

! All connection work must be performed in accordance with the current legislation of the country in which the controller is installed. This includes earthing or grounding in order to ensure that no part of the controller which is directly accessible can remain at mains voltage or any other voltage which may be hazardous.

- The voltages on the cables or the connections to the mains, the motor, the braking resistor or the filter may cause fatal electric shocks. Avoid contact in all cases.

- The controller must be supplied through a circuit-breaking device in order to power it down safely.

- The controller power supply must be protected against overloads and short-circuits.

- The stop function of the controller does not provide protection against high voltages on the terminal blocks.

- The controller contains capacitors which remain charged at a fatal voltage even after the power supply has been cut off.

- Wait 10 minutes after powering down the controller before removing the protective cover.

- Check that the DC bus voltage is below 40V before performing any work.

- Check that the voltage and current of the controller, the motor and the mains supply are compatible.

3.1 - Connecting an asynchronous motor

3.1.1 - Terminal block

LS MV motors are mainly 230/400V dual-voltage motors. For a 400V supply ("T" ratings) star connection should thus be used as standard.

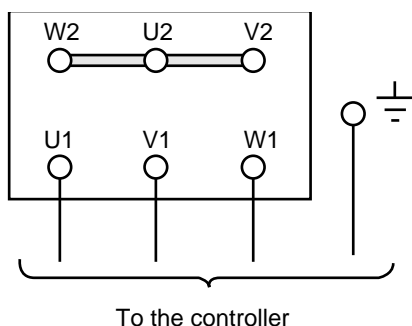

For a 230V supply ("TL" ratings), connect the motor in delta.

! In some cases, delta connection can increase motor temperature rise. For more information, consult LEROY-SOMER.

Check the details on the nameplate before connecting the motor.

WARNING :

In closed loop mode, it is essential to follow the motor/controller phase order.

3.1.2 - Auxiliary terminal blocks

3.1.2.1 - Optional forced ventilation

LS MV motors can be fitted with forced ventilation as an option, connected in the following way :

- LS MV motor, frame size ≤ 132 , single phase power supply as standard :

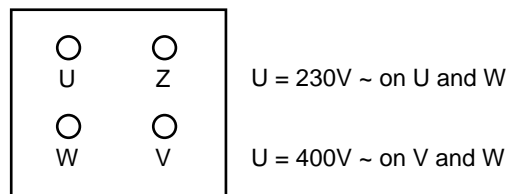

- LS MV motor, frame size ≥ 160

Forced ventilation power supply

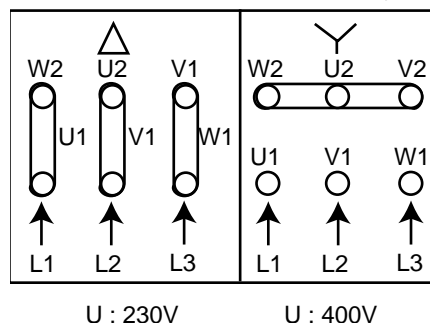

Refer to the LS MV motor catalogue for further information.

3.1.2.2 - Optional encoder

For operation in closed loop flux vector control mode, the LS MV motor must be fitted with an incremental encoder as an option.

Characteristics of the standard encoder :

- power supply : 5V,
- consumption : 150 mA,
- number of pulses/revolution : 1024,
- number of channels : 2 channels with their complements and the zero marker.
- maximum speed : 6000 min^{-1} ,
- housing : injected Zamac,
- external finish : epoxy,
- protection : IP 65.

UMV 4301

Open or closed loop speed controller for asynchronous and synchronous motors

- Connecting the controller

The controller is connected via the 15-pin female SUB-D connector.

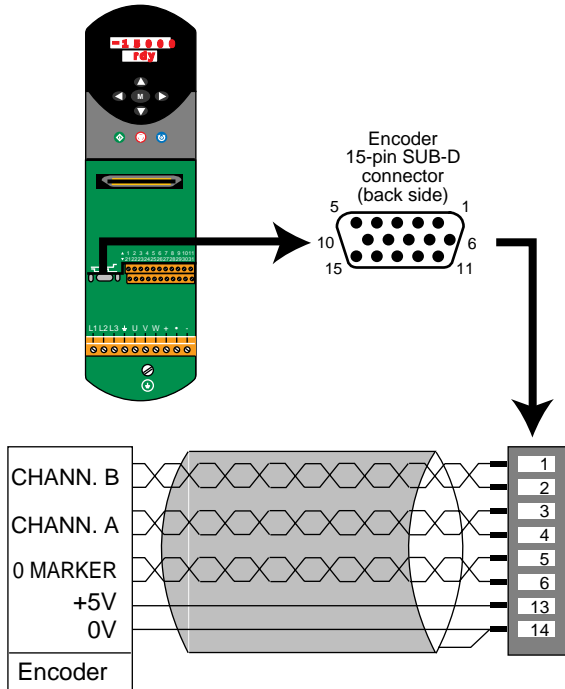

Reference	Designation	Function
1	0V	Encoder power supply
2	+5VDC	
3	A	Encoder feedback 2 complemented channels + zero marker
4	B	
5	O	
6	\bar{A}	
7	\bar{B}	
8	\bar{O}	
9	Free terminal	-
10	-	Do not use
11	-	
12	-	

The encoder is connected to the **UMV 4301** controller by pairs of shielded cable, maximum length 150m.

The shielding is connected at one end only to the 0V terminal (14) on the 15-pin SUB-D connector.

Note : Depending on the manufacturer, the zero marker may be marked 0, C or Z.

Precautions :

- connect or disconnect the encoder with controller powered down,
- keep the encoder shielded cable separate from the power cables and avoid parallel routing.

Ref.	Designation	Function	Electrical characteristics
1	B	Encoder feedback 3 complemented channels	Inputs : - RS 422 differential - F max : 205 kHz - Impedance : 120 Ω in series with 0.1 μ F
2	\bar{B}		
3	A		
4	\bar{A}		
5	O		
6	\bar{O}		
13	+ 5V	Encoder power supply	+ 5.15V \pm 2 % 300mA max
14	0V		Common
15	-	Do not use	-

- Connecting the motor

The motor is connected via the female connector on the encoder.

The encoder connector is located beside the terminal block.



UMV 4301

Open or closed loop speed controller for asynchronous and synchronous motors

3.2 - Connecting the SMV UM synchronous motor

3.2.1 - Power connector

The synchronous motor is connected via the power connector. The male connector is fastened onto the motor, the female connector can be provided for the connection in option.

WARNING :

It is advisable to use shielded cable, connected to earth at both ends.



Male connector motor side

Pin reference	Connection function	Controller terminal
1	Phase U	U
2	Phase V	V
4	Phase W	W
5	Brake opt. +24VDC	★
6	Brake option 0V	★
⊥	Earth	⊥

★ Use an external power supply for the brake. (Refer to the LS - SMV UM manual).

3.2.2 - Auxiliary terminal blocks

3.2.2.1 - Encoder connector

For operation in servo mode, the motor is fitted with an encoder with switching phase for the speed and position feedback.

3.2.2.1 - Encoder connector

• Connecting the controller

The controller is connected via the 15-pin female SUB-D connector.

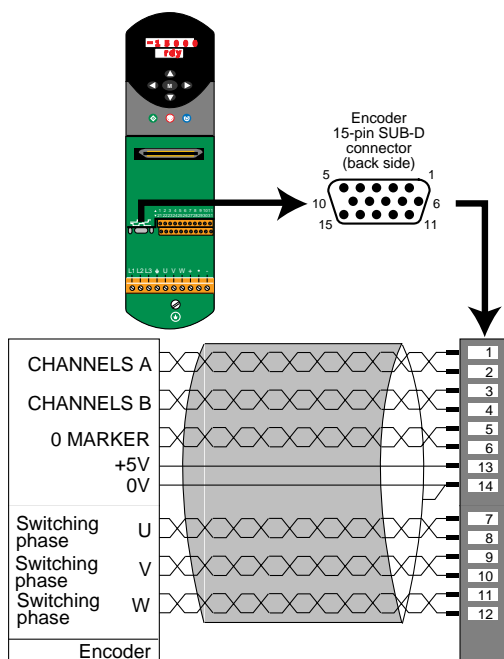

Ref.	Designation	Function	Electrical characteristics
1	A	Encoder feedback 3 complemented channels	Inputs : - RS 422 differential - F max : 205kHz - Input impeded : 120 Ω in series with 0.1 μF
2	\bar{A}		
3	B		
4	\bar{B}		
5	O		
6	\bar{O}		
7	U	Encoder feedback 3 complemented channels for switch. phases	
8	\bar{U}		
9	V		
10	\bar{V}		
11	W		
12	\bar{W}		
13	+5V	Encoder power supply	+5.15V ±2 % 300mA max
14	0V		Common
15		Do not use	

• Connecting the motor

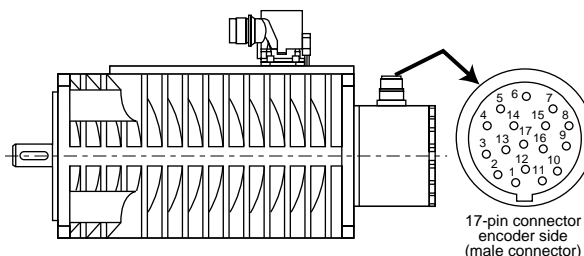

Ref.	Designation	Function	Electrical characteristics
1	PTC probe	Motor thermal protection	Trip value : 3kΩ★
2	PTC probe		
3	Shielding	Do not connect	Do not connect
4	U	Encoder feedback 3 complemented channels for switching phases	
5	\bar{U}		
6	V		
7	\bar{V}		
8	W		
9	\bar{W}		
10	A	Encoder feedback 3 complemented channels	
11	O		
12	\bar{O}		
13	\bar{A}	3 complemented channels	
14	B		
15	\bar{B}		
16	+5VDC	Power supply	
17	0V	Power supply	

★ Motor PTC probe : to be connected on controller terminal block 1, terminals 8 and 11 in standard configuration.

UMV 4301

Open or closed loop speed controller for asynchronous and synchronous motors

WARNING :

The encoder is connected to the UMV 4301 controller via a shielded cable, maximum length 150m. The shielding is connected at one end to the 0V terminal (14) on the 15-pin SUB-D connector.

Note :

- Depending on the manufacturer, the zero marker may be marked 0, C or Z.
- To assist with connecting the encoder, an INTERCOD 15 interface is available as an option. See section 7.7.

Precautions :

- connect or disconnect the encoder with controller powered down,
- keep the encoder shielded cable separate from the power cables and avoid parallel routing.

3.3 - Connecting the controller

3.3.1 - Power terminal block

3.3.1.1 - Access to the power terminal blocks

- UMV 4301 1.5T to 16T and 1TL to 8TL

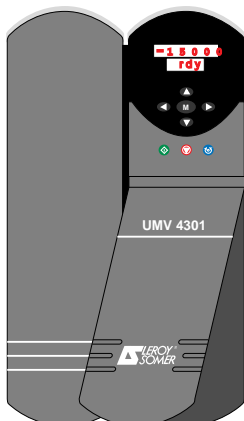

Unclip the plastic cover on the control side by slightly separating the 2 lower edges.

- UMV 4301 22T to 120T and 11TL to 33TL

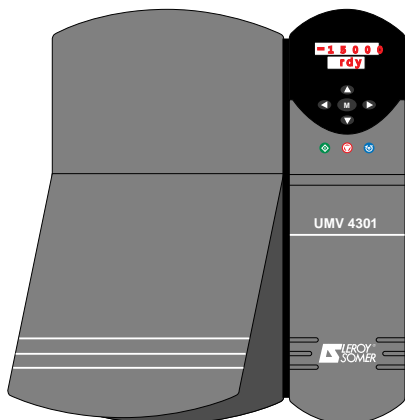

Unclip the plastic cover on the power side by slightly separating the 2 lower edges.

3.3.1.2 - Wiring the power terminal block

- UMV 4301 1.5T to 16T and 1TL to 8TL

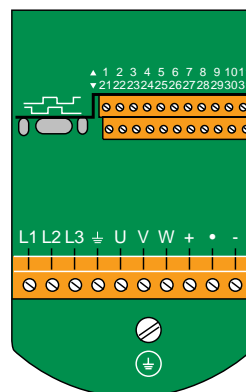

Pluggable screw type terminal.

Tightening torque for the power terminal blocks : 0.5 Nm.
Tightening torque for the earth terminal (M4) : 3N.m.

- UMV 4301 22T to 120T and 11TL to 33TL

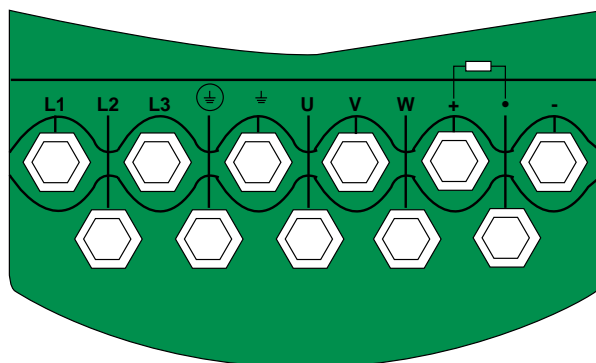

M10 terminals

Tightening torque for the power terminal blocks : 15 Nm.

Reference	Function
L1 - L2 - L3	3-phase controller power supply.
0	Controller and motor earth.
U - V - W	Motor connection (follow the motor and controller phase order).
+ (with resistor symbol)	Connection of R-FMV optional braking resistors via a thermal relay. (+) access to + pole of DC bus.
-	- pole of DC bus.

⚠ • Check that the braking resistors are correctly connected between the + and • terminals and not the + and - terminals. If incorrectly connected, the resistor would be permanently powered up with no control possible via the controller. This would cause overheating of the resistor which could lead to a risk of burns or fire.

UMV 4301

Open or closed loop speed controller for asynchronous and synchronous motors

3.3.2 - Control terminal blocks



- The default setting of the UMV 4301 is negative logic.
- All the descriptions of the terminal blocks refer to negative logic configuration.
- Connecting a controller configured with negative logic to a PLC operating in positive logic would cause the controller to start when powered up.

The control terminal block consists of two removable 11-pin connectors, which can be accessed by removing the plastic cover of the control module.

3.3.2.1 - Upper connector

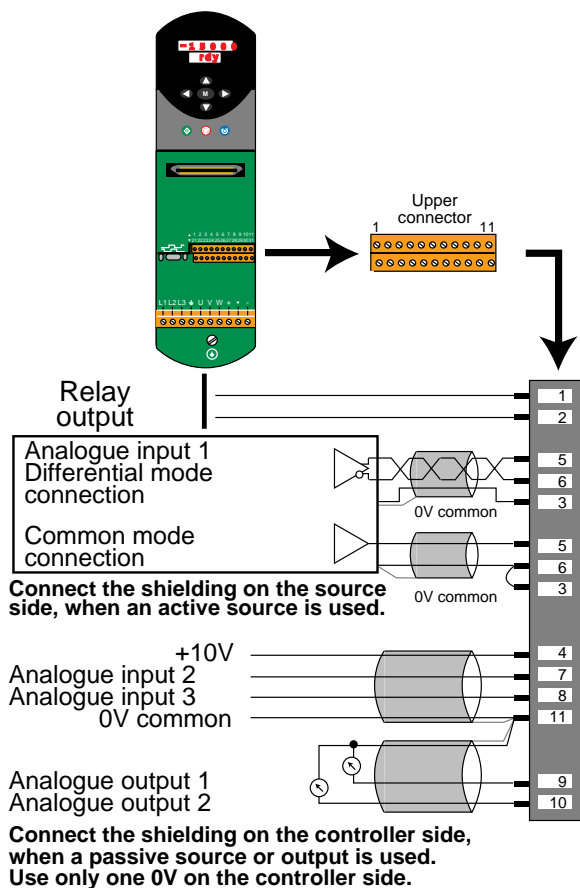

1	Assignable relay output
2	
Characteristics	250VAC max 5A resistive load
Insulation voltage	3 kV
Reset period	8ms
Factory configuration	Fault relay
	: Powered down or fault : Controller ready

3	0V Common - analogue circuits
----------	-------------------------------

4	+10V internal analogue source
Tolerance	±1 %
Rated current	10 mA
Protection	Overload and thermal

5	Analogue input 1 (+)	assignable
6	Analogue input 1 (-)	
Characteristics	Bipolar differential inputs (operation in common mode : connection terminals 6 and 3)	
Rated voltage	± 10VDC	
Maximum voltage	± 24V/0V ± 24V differential	
Input impedance	100 kΩ	
Resolution	12 bits plus sign	
Sampling	≤ 2ms / < 450µs	
Factory configuration	0 - 10V : Speed input 1	
	0V : Minimum speed 10V : Maximum speed	

7	Analogue input 2 assignable
Characteristics	Bipolar common mode
Rated voltage	± 10VDC
Maximum voltage	± 24VDC/0V
Input impedance	100 kΩ
Resolution	10 bits plus sign
Sampling	≤ 2ms
Factory configuration	0 - 10V : Speed input 2
	0V : Minimum speed 10V : Maximum speed

UMV 4301

Open or closed loop speed controller for asynchronous and synchronous motors

8 Analogue input 3 assignable	
Characteristics	Bipolar common mode
Rated voltage	± 10VDC
Maximum voltage	± 24VDC/0V
Input impedance	100 kΩ
Resolution	10 bits plus sign
Sampling	≤ 2ms
Factory configuration	Management of a PTC or PTO probe
	Internal voltage : 4.25V Trip threshold : 3kΩ Reset threshold : 1.65kΩ

9 Analogue output 1 assignable		
10 Analogue output 2 assignable		
Characteristics	Bipolar common voltage mode	
Voltage output or current output	± 10VDC, 10mA max 0-20mA, 4-20mA (15V max)	
Load resistance	1 kΩ minimum	
Protection	Short-circuit	
Resolution	10 bits plus sign	
Sampling	8 ms	
Factory config.		0 - 10V : Speed output
	1	0V : 0 10V : Maximum speed
		0 - 10V : Torque output
	2	0V : 0 10V : Maximum torque

11 0V common - analogue circuits

UMV 4301

Open or closed loop speed controller for asynchronous and synchronous motors

3.3.2.2 - Lower connector

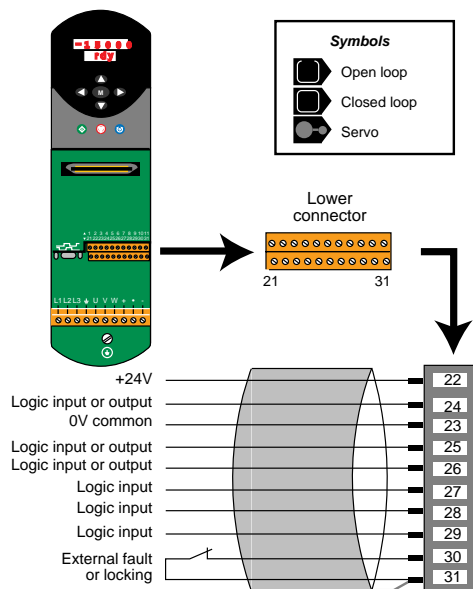

21	Earth - Do not use	
-----------	---------------------------	--

22	+24V internal source for logic circuit	
Tolerance	± 10 %	
Rated current	200 mA (maximum including terminals 24 to 26 when used as outputs)	
Overload current	240 mA (maximum including terminals 24 to 26 when used as outputs)	
Protection	Limitation above 240mA	

23	0V common - digital circuits only
-----------	-----------------------------------

24	Assignable logic inputs or outputs
25	
26	

Negative logic input	
Voltage	0V to +24V
Absolute max. voltage	-3V to +30V
Input current for +24V	≥ 3.2mA
Logic levels	Level 0 > +15V (open circuit) Level 1 < +5V (closed circuit)

or positive logic input	
Voltage	0V to +24V
Absolute max. voltage	-3V to +30V
Input current for +24V	≥ 3.2mA
Logic levels	Level 0 < +5V (open circuit) Level 1 > +15V (closed circuit)

or logic output	
Characteristics	Open collector transistor (push-pull)
Voltage	0V to +24V
Maximum output current	200mA (maximum including terminal 22)
Overload current	240mA (maximum including terminal 22)

Factory configuration	
24	Logic output
	At speed (open loop) Zero speed (closed loop or servo)
25	Negative logic input
	Fault reset
26	Negative logic input
	Jogging

27	Assignable logic inputs
28	
29	

Negative logic input	
Voltage	0V to +24V
Absolute max. voltage	-3V to +30V
Input current for +24V	≥ 3.2mA
Logic levels	Level 0 > +15V (open circuit) Level 1 < +5V (closed circuit)

or positive logic input	
Voltage	0V to +24V
Absolute max. voltage	-3V to +30V
Input current for +24V	≥ 3.2mA
Logic levels	Level 0 < +5V (open circuit) Level 1 > +15V (closed circuit)

Factory configuration	
27	Negative logic input
	Run forward/Stop
28	Negative logic input
	Run reverse/Stop
29	Negative logic input
	Select analogue input 1 (open) Select analogue input 2 (closed)

30	Logic input
	- external fault (open loop) - locking (closed loop)

31	0V common - digital circuits only
-----------	-----------------------------------

WARNING :

- Negative and positive logic :
- the controller is configured for negative logic,
- most of the connections in section 3.7 are in negative logic. See diagram 3.7.3 for positive logic connection.

UMV 4301

Open or closed loop speed controller for asynchronous and synchronous motors

3.4 - Description of cables and protection

 • It is the responsibility of the user to connect and protect the UMV 4301 according to current legislation and the regulations in force in the country in which it is used. This is particularly important for the size of the cables, the type and size of the fuses, the connection to earth or ground, powering down, trip resets, insulation and protection against overcurrents.

• These tables are given for information only, and can under no circumstances serve as a substitute for current standards.

Rating	Motor power (kW)	Current			gl fuses		Cross-section of power cables *** (mm ²)				Maximum motor cable length for 3kHz switching frequency (m)	
		Motor * (A)	Mains (A)	DC bus ** (A)	Mains (A)	DC Bus ** * (A)	Motor	Mains	DC bus **	$\frac{\perp}{-}$	400V supply	480V supply
1.5T	0.75	2.1	3.1	1.7	6	4	1.5	1.5	1.5	1.5	65	50
2T	1.1	2.8	3.2	2.4	10	4	1.5	1.5	1.5	1.5	100	75
2.5T	1.5	3.8	5.5	3.3	10	6	1.5	1.5	1.5	1.5	130	100
3.5T	2.2	5.6	8.4	4.9	10	8	1.5	1.5	1.5	1.5	200	150
5.5T	4	9.5	9.5	8.7	16	12	1.5	1.5	1.5	1.5	300	250
8T	5.5	12	13.7	11.9	16	16	1.5	1.5	1.5	1.5	300	300
11T	7.5	16	16.3	15.7	20	25	2.5	2.5	2.5	2.5	300	300
16T	11	25	24.3	22	35	32	4	4	4	4	300	300
22T	15	34	34	30	40	40	6	6	6	6	200	120
27T	18.5	40	39	37	50	50	10	10	10	10	200	120
33T	22	46	46	44	60	63	10	10	10	10	200	120
40T	30	60	59	60	70	80	16	16	16	16	200	120
50T	37	70	74	74	80	100	16	16	16	16	200	120
60T	45	96	96	90	100	125	25	25	25	16	200	120
75T	55	124	120	110	125	160	35	35	35	16	200	120
100T	75	156	151	150	160	200	50	50	50	25	200	120
120T	90	180	173	180	200	250	70	70	70	35	200	120

Rating	Motor power (kW)	Current			gl fuse		Cross-section of power cables *** (mm ²)				Maximum motor cable length for 3kHz switching frequency (m)
		Motor* (A)	Mains (A)	DC bus ** (A)	Mains (A)	DC bus ** * (A)	Motor	Mains	DC bus**	$\frac{\perp}{-}$	
1TL	0.37	2.1	3.1	1.7	6	4	1.5	1.5	1.5	1.5	65
1.2TL	0.55	2.8	3.2	2.4	10	4	1.5	1.5	1.5	1.5	100
1.5TL	0.75	3.8	5.5	3.3	10	6	1.5	1.5	1.5	1.5	130
2TL	1.1	5.6	8.4	4.9	16	8	1.5	1.5	1.5	1.5	200
3.5TL	2.2	9.5	9.5	8.7	16	12	1.5	1.5	1.5	1.5	300
4.5TL	3	12	13.7	11.9	16	16	1.5	1.5	1.5	1.5	300
5.5TL	4	16	16.3	15.7	20	25	2.5	2.5	2.5	2.5	300
8TL	5.5	25	24.3	22	35	32	4	4	4	4	300
11TL	7.5	34	34	30	40	40	6	6	6	6	200
16TL	11	46	46	44	60	63	10	10	10	10	200
22TL	15	60	59	60	70	80	16	16	16	16	200
33TL	22	74	74	74	80	100	16	16	16	16	200

* For switching frequency = 3 kHz. Refer to section 1.3.2 for other frequencies.

** In the event of parallel connection of controllers via the DC bus, section 3.5.5.2.

*** The recommended cross-sections are for electrical enclosures and do not take account of line voltage drops due to the length.

Note : The mains current value is a typical value which depends on the source impedance. The higher the impedance, the lower the current.

UMV 4301

Open or closed loop speed controller for asynchronous and synchronous motors

WARNING :

- The maximum motor cable length must be below numbers indicated in previous chart when drive is used in the following conditions :
- switching frequency > 3 kHz : the maximum cable length must be reduced in proportion to the increase of the switching frequency. Example : if switching frequency = 9 kHz, the maximum cable length of the table is divided by 3,
- when high capacitance cables are used, the maximum cable length must be divided by 2.

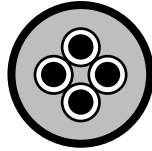

Normal
capacitance
cable



High
capacitance
cable

When the installation requires motor cables longer than the maximum length, select the next drive rating.

- In closed loop, when a UMV 4301 TL is used with long motor cable, do not supply the encoder from the drive (voltage losses). Use a separate DC supply close to the encoder.

UMV 4301

Open or closed loop speed controller for asynchronous and synchronous motors

3.5 - Special connections

3.5.1 - Parallel connection of motors in V/F mode

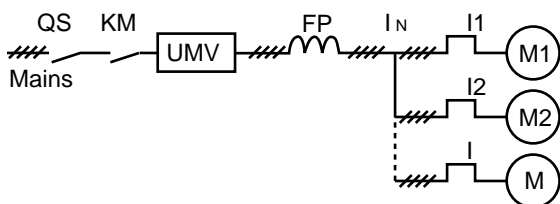

It is possible to supply several motors of different power ratings from a single controller. Each motor must be protected by a thermal relay.

Determination of the rating of the controller :

$$I_N \text{ controller} > I_1 + I_2 + \dots + I$$

To avoid accidental tripping of the thermal relays, a special Minimal Loss (ML) choke can be supplied as an option. The determination of this choke depends on the rating of the controller and the length of the cable between the controller and the motor. Consult LEROY-SOMER.

3.5.2 - Direct connection of the motor to the mains (by-pass) in V/F mode.

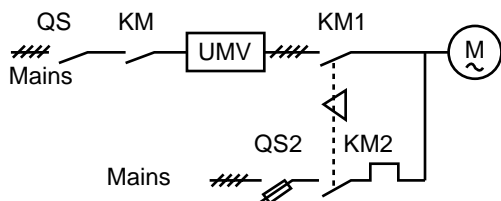

Sequence to be followed :

- KM1 must be operated before KM,
- mechanical locking between KM1 and KM2.

Time $T_2 = 1.5s$ must be observed. It corresponds to the motor demagnetization time.

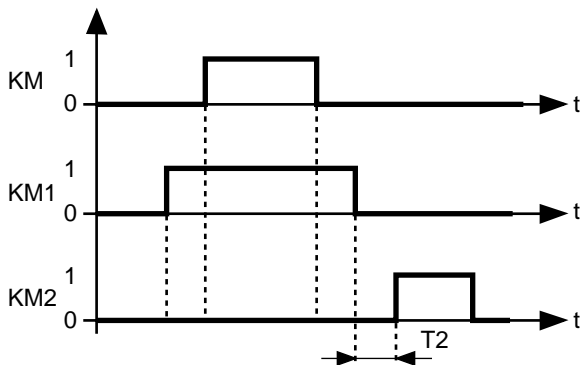

3.5.3 - Opening of the contactor with the motor stopped

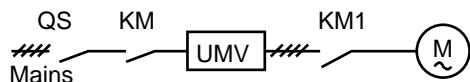

Sequence to be followed :

- the run command must not be given until KM1 has been activated.

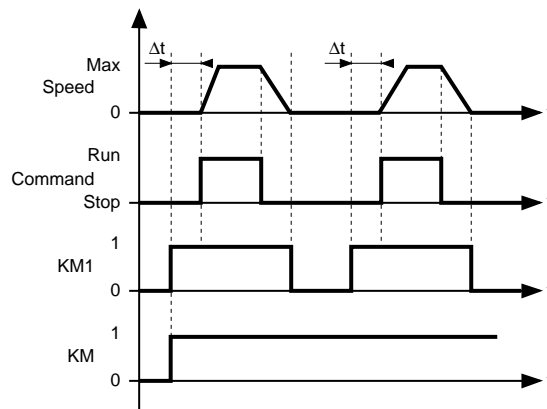

3.5.4 - Connecting the earth terminals of several controllers

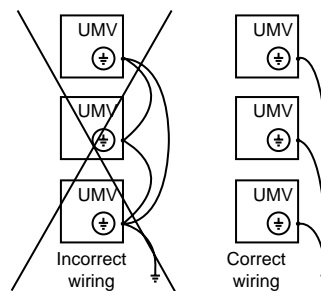

3.5.5 - Parallel connection of controllers via the DC bus

3.5.5.1 - General

Controllers which are connected in parallel should be the **same rating** and they should be powered up simultaneously.

The DC bus of each inverter must be fitted with fuses. (See section 3.4).

It is thus possible to avoid using optional braking resistors, or to limit the number used in cases where the driving energy is greater than the restored energy.

3.5.5.2 - Example : UMV 4301 connection diagram

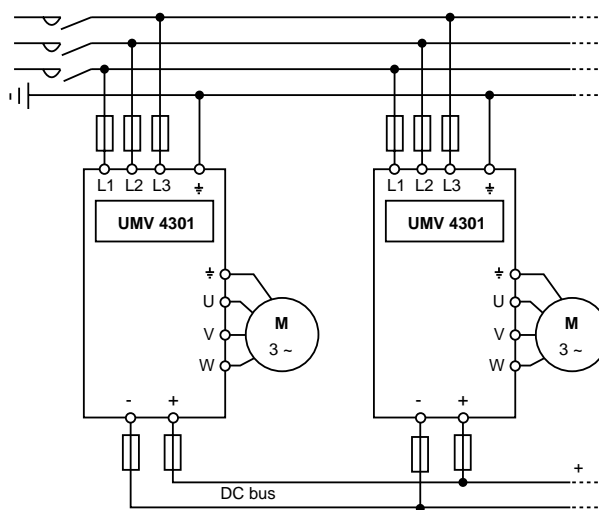

UMV 4301

Open or closed loop speed controller for asynchronous and synchronous motors

3.6 - Electrical and electromagnetic phenomena

3.6.1 - General

The power structure of speed controllers leads to the occurrence of two types of phenomena :

- low frequency harmonic feedback on the mains power supply,

3.6.2 - Low frequency harmonics

3.6.2.1 - General

The rectifier at the head of the speed controller generates a non-sinusoidal AC line current.

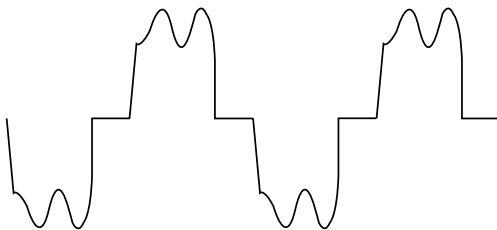

Mains line current drawn by a 3-phase rectifier

This current carries harmonics with order $6n \pm 1$.

Their amplitudes depend on the impedance of the mains supply upstream of the rectifier bridge, and on the structure of the DC bus downstream of the rectifier bridge.

The more inductive the mains supply and the DC bus, the more these harmonics are reduced

They have a significant effect only for loads on frequency inverters of several hundred kVA and when these loads represent more than a quarter of the total load on a site.

They have virtually no effect on the electrical energy consumption level. Temperature rises associated with these harmonics in transformers and motors connected to the mains supply are negligible.

These low frequency harmonics only rarely cause interference on sensitive equipment.

3.6.3 - Radio-frequency interference : Immunity

3.6.3.1 - General

The level of immunity of a device is defined by its ability to operate in an environment which is subject to interference from external elements or from its own electrical connections.

- emission of radio-frequency signals (RFI).

These phenomena are independent. They have different consequences on the electrical environment.

3.6.2.2 - Standards

There is no standard for current harmonics.

Current harmonics generate voltage harmonics on the mains supply. **The amplitude of these harmonics depends on the impedance of the mains supply.**

The energy distribution company, who is affected by these phenomena in the case of high **high power installations**, has its own **recommendations** concerning the level of the voltage harmonics :

- 0.6 % on even order harmonics,
- 1 % on uneven order harmonics,
- 1.6 % on overall harmonic distortion.

This applies to the power distribution connection and not to the harmonic generator.

3.6.2.3 - Reduction of harmonics fed back to the mains supply

The controller is fitted as standard with an inductance coil in the DC bus. The purpose is to reduce the level of harmonics fed back to the mains supply. It is therefore virtually never necessary to use any other device.

However, in rare cases where the characteristics of the mains and the total load on the controller make it impossible to comply with the harmonic level recommended by the energy distribution company, LEROY-SOMER will offer any assistance to the installer for the determination of an additional mains choke.

3.6.3.2 - Standards

Each device must undergo a series of standard tests (European Standards) and meet a minimum requirement in order to be declared as complying with the generic industrial (EN 50082-2) and domestic (EN 50082-1) standards.

3.6.3.3 - Recommendations

An installation consisting exclusively of devices which comply with the standards relating to immunity is very unlikely to be subject to a risk of interference.

UMV 4301

Open or closed loop speed controller for asynchronous and synchronous motors

3.6.4 - Radio-frequency interference : Emission

3.6.4.1 - General

Speed controllers use high-speed switches (transistors, semi-conductors) for switching high voltages (about 550V for " T " ratings, and around 300V for " TL " ratings) and currents at high frequencies (several kHz). This provides better efficiency and a low level of motor noise.

As a result they generate radio frequency signals which may disturb operation of other equipment or distort sensor measurements :

- due to high frequency leakage currents escaping to earth via the controller / motor connection cable leakage capacitor and via the motor leakage capacitor through the metal structures supporting the motor.

- by conduction or feedback of radio frequency signals on the power supply cable : **conducted emissions**,

- by direct radiation close to the power supply cable or the controller / motor connection cable : **radiated emissions**. These phenomena are of direct interest to the user.

The frequency range concerned (radio-frequency) does not affect the energy distribution company.

3.6.4.2 - Standards

The maximum emission level is specified in the generic industrial (EN 50081-2) and domestic (EN 50081-1) standards.

3.6.4.3 - Recommendations

• **Experience shows that the levels specified in standards EN 50081-1 and 50081-2 do not necessarily need to be respected to eliminate interference phenomena.**

• **Following the basic precautions described in the next paragraph generally results in correct operation of the installation.**

3.6.5 - Basic precautions

These are to be taken into account during the design stage and also when wiring the cubicle and the external elements. In each paragraph, they are listed in decreasing order of effect on correct operation of the installation.

3.6.5.1 - Design

1) Choice of equipment

Give priority to components whose immunity level conforms to the generic immunity standards EN 50082-1 and EN 50082-2, and mount them in a steel cubicle.

2) Location of the controller

Install the controller as near to the motor as possible in order to reduce cable length.

3.6.5.2 - Installation of the controller and related components in the cubicle

1) Screw the controller and its components onto a metal grille or a base plate which is unpainted or paint-free around the fastening points.

2) Fasten the plate at several paint-free points on the bottom of the cubicle.

3.6.5.3 - Wiring inside the cubicle

1) Do not run the control and power cables in the same cable duct (minimum distance 0.5m).

2) For control cables, use twisted shielded cables with tight copper shielding mesh and connect the shielding to 0V at the controller end only.

3) Relays and contactors which are electrically connected to the controller should be fitted with an RC filter.

3.6.5.4 - Wiring outside the cubicle

1) Separate the power cables from the control cables.

2) Connect the motor earth terminal to that of the controller.

3) Run the motor power supply cables, as well as the auxiliary cable connecting the motor earth to the controller earth, in a metal cable duct. This cable duct should be mechanically connected to the cubicle and to the metal structure supporting the motor. The cables should be attached to the bottom of the duct.

4) Do not route the control cables (controller and feedback) along metal structures which could be common with the motor support.

5) Isolate sensitive components (probes, sensors, etc) from metal structures which could be common with the motor support.

3.6.5.5 - Importance of ground wiring

The immunity and radio frequency emission level are directly linked to the quality of the ground connections. All metal grounds should be mechanically connected to each other with the largest possible electrical contact area. Under no circumstances can the ground connections which are designed to protect personnel (by connecting metal grounds to earth via a cable) serve as a substitute for ground connections.

UMV 4301

Open or closed loop speed controller for asynchronous and synchronous motors

3.6.6 - Additional precautions

Observing the basic precautions described in the previous paragraph generally ensures correct operation of the installation. However, its immunity can be increased by following the additional precautions below. These are listed in order of importance.

3.6.6.1 - Installation and wiring of a Self - MC choke

Most interference phenomena are caused by high frequency leakage currents escaping to earth via the controller / motor connection and via the metal structures supporting the motor.

Self - MC chokes are used to reduce these leakage currents. The longer the controller / motor cable, the more important their role becomes.

Use Self - MC chokes with a standard cable not exceeding 100m.

Install the choke as close to the controller as possible.

UMV 4301	Self - MC choke
1.5T to 3.5T - 1TL to 2TL	3.5T
5.5T to 11T - 3.5TL to 5.5TL	11T
16T to 27T - 8TL to 11TL	27T
33T to 50T - 16TL to 22TL	50T
60T to 75T - 33TL	75T
100T to 120T	120T

Note : for UMV 4301 1.5T to 16T controllers with cable lengths between 1 and 20m, it is possible to replace the Self-MC chokes with 2 ferrites ref. FRT 4200 in which the motor output cables should be wound twice.

3.6.6.2 - RFI filters

The use of an RFI filter reduces the emission level of radio frequency signals on the power supply cable, but its effect on interference phenomena is rather limited.

Depending on the type of controller, install the recommended RFI filter as described in the table below, between the mains and the controller input.

UMV 4301	Length of motor cable (m)	Reference of filter
1.5T to 5.5T 1TL to 3.5TL	1 to 100	FLT 5101-10
8T to 11T 4.5TL to 5.5TL	1 to 100	FLT 5106-16
16T 8TL	1 to 100	FLT 5106-25
22T to 33T 11TL to 16TL	1 to 100	FLT 5113-50
40T 22TL	1 to 100	FLT 5113-63
50T 33TL	1 to 100	FLT 5113-100
60T and 75T	1 to 100	FLT 5113-150
100T and 120T	1 to 100	FLT 5113-180

• Precautions when installing filters

- Place the filter as close to the controller as possible.
- Attach the filter directly on the same grille or base plate as the controller.

• Precautions for wiring the filter

- The maximum length of cable to the controller will be 0.3m.
- Keep the motor cables separate from the mains cables.
- Earth wiring : input at general earth of cubicle, output at controller earth.

3.6.6.3 - Controller - motor wiring

Use a shielded cable between the controller and the motor.

• Characteristics of the cable

Use a shielded or armed cable with 3 phases + earth, with a low leakage capacity between the cables and the shielding or the armature.

• Connecting the shielding

- Connect the shielding at both ends : to the motor earth terminal and the controller earth terminal (or to earth bus at the filter output).

- Strip the cable casing and fasten the shielding to the the grille or the base plate of the cubicle using a metal clamp.

- If possible, connect the shielding to the earth of the cubicle at the cable outlet by using for example brass cable glands and stripping the cable casing.

• Recommendations for the continuity of the shielding

- When the motor is connected using the intermediate terminal block in the cubicle, connect the shielding to a terminal not insulated from the grille or base plate. If the terminal is located further than 300 mm from the edge of the grille, fasten the shielding using a metal clamp.

- When a circuit-breaking device is used near the motor, use an earthing strip not exceeding 100mm to provide the continuity.

UMV 4301

Open or closed loop speed controller for asynchronous and synchronous motors

3.6.7 - Conformity to standards

Tests performed under the conditions stipulated by the standards show that UMV 4301 controllers conform to the EMC directive 89/336/EEC modified by 92/31/EEE, provided that they are installed and connected according to the instructions given in paragraphs 3.6.5 and 3.6.6.

3.6.7.1 - Immunity

UMV 4301 controllers conform to international immunity standards.

Standard	Type of immunity	Application	Level
EN 61000-4-2*	Electrostatic discharges	Product housing	Level 3 (industrial)
EN 61000-4-3 ENV 50140*	Radiated radio frequency	Product housing	Level 3 (industrial)
EN 61000-4-6 ENV 50141*	Conducted radio frequency	Control and power cables	Level 3 (industrial)
EN 61000-4-4*	Fast transient bursts	Control cables	Level 4 (industrial, reinf.)
		Power cables	Level 3 (industrial)
IEC 61000-4-5	Shock waves	Supply cables between phase and earth	Level 4
		Supply cables between phases	Level 4
EN 50082-1	Generic immunity standards Part 1 : residential, commercial and light industry	-	Conforms
EN 50082-2	Generic immunity standards Part 2 : industrial environment Concerns basic standards marked with *	-	Conforms
EN 61800-3 CEI 61800-3	Speed controller standards	Complies with the first and second environments	

3.6.7.2 - Conducted emissions

UMV 4301 used in conjunction with filters conform to the standards relating to conducted emissions under the conditions below. It is possible to add a ferrite to the controller output in order to improve the emission level.

UMV 4301 1.5T to 5.5T - 1TL to 3.5TL	Switching frequency (kHz)				
	3	4.5	6	9	12
Length of motor cables (m)	With FLT filter				
0 to 20	R	R	R	R	R
20 to 50	R	I	I	I	I
50 to 100	R	I	I	I	I
Length of motor cables (m)	With FLT filter + FRT ferrite				
20 to 100	R	R	R	I	I

WARNING :

Do not use a cable longer than the maximum cable length defined per rating in § 3.4.

UMV 4301 8T to 16T - 4.5TL to 8TL	Switching frequency (kHz)				
	3	4.5	6	9	12
Length of motor cables (m)	With FLT filter				
0 to 10	R	R	R	R	I
10 to 50	R	R	R	I	I
50 to 100	I	I	I	-	-
Length of motor cables (m)	With FLT filter + FRT ferrite				
0 to 10	R	R	R	R	R
10 to 50	R	R	R	R	I
50 to 100	R	I	I	I	I
100 to 150	I	I	I	-	-

UMV 4301

Open or closed loop speed controller for asynchronous and synchronous motors

UMV 4301 22T to 50T - 11TL to 33TL	Switching frequency (kHz)				
	3	4.5	6	9	12
Length of motor cables (m)	With FLT filter				
0 to 10	R	R	R	R	R
10 to 50	I	I	I	I	I
50 to 100	I	I	I	-	-

UMV 4301 60T to 120T	Switching frequency (kHz)				
	3	4.5	6	9	12
Length of motor cables (m)	With FLT filter				
0 to 50	R	-	-	-	-
50 to 100	I	-	-	-	-

Symboles	Standards	Description	Application
R	EN 50081 - 1	Generic emission standard for residential, commercial and light industrial environments	AC mains supply
	EN 61800 - 3 CEI 61800 - 3	Speed controller standards	Complies with the first and the second environments
I	EN 50081-2	Generic emission standard for industrial environments	AC mains supply
	EN 61800 - 3 CEI 61800 - 3	Speed controller standards	Complies with the first and the second environments

The conducted emissions levels specified in standards EN 50081-1 and 50081-2 are equivalent to the levels required by the following specific standards :

Conducted emissions from 150 kHz to 30 MHz		
Generic standard	Specific standard	
EN 50081-1	EN 55011 Class B CISPR 11 Class B	Industrial, scientific and medical equipment
	EN 55014 CISPR 14	Domestic electrical equipment
	EN 55022 Class B CISPR 22 Class B	Data processing equipment
EN 50081-2	EN 55011 Class A Group 1 CISPR 11 Class A Group 1	Industrial, scientific and medical equipment
	EN 55022 Class A CISPR 22 Class A	Data processing equipment

UMV 4301

Open or closed loop speed controller for asynchronous and synchronous motors

3.6.7.3 - Radiated emissions

When the controller is installed in a steel cubicle, and wiring precautions have been followed, it conforms to the radiated emission limits specified in the industrial environment part of the generic emission standard EN 50081-2.

Tests have been performed with a cubicle representing the most common types of installation. It is possible that, for a device with different characteristics, the radiated emission levels may not be the same as those measured during the tests.

The table below summarizes the results for radiated emissions and gives the six most unfavourable measurements between 30 and 1000 MHz.

Rating	Frequency (MHz)	Emissions (dB μ V/m)	Maximum level permitted by industrial standard EN 50081-2 at 10m
1.5T to 5.5T 1TL to 3.5TL	36	29	40
	37	29	40
	40	35	40
	41	31	40
	42	30	40
	60	34	40
8T to 16T 4.5TL to 8TL	35.1	34.4	40
	35.2	34.3	40
	34.6	34.2	40
	34.7	34.2	40
	34.85	34.2	40
	34.35	34.2	40
22T to 50T 11TL to 33TL	60.7	30	40
	60.35	29.5	40
	61.1	29.5	40
	50.2	28.5	40
	50.45	28.5	40
	61.4	28.5	40
60T to 120T	30.05	29.0	40
	30.2	29.0	40
	30.35	29.0	40
	32,8	28,0	40
	32,95	28,0	40
	34	34.0	40

The radiated emission levels specified in standards EN 50081-2 are equivalent to the levels required in following specific standards :

Radiated emissions from 30 to 1000 MHz		
Generic standard	Specific standard	
EN 50081-2	EN 55011 Class A Group 1 CISPR 11 Class A Group 1	Industrial, scientific and medical equipment
	EN 55022 Class A CISPR 22 Class A	Data processing equipment

3.6.8 - Recommendations in the event of interference phenomena

It is possible that, even though the basic precautions described in paragraph 3.6.5 have been followed, in a few rare cases some components of the installation may be affected by interference. This more generally concerns sensitive measurement probes.

Experience shows that the most costly solutions are not necessarily the most efficient and in most cases very simple remedies give the best results.

It is not necessary to perform all the following operations systematically. Stop once the phenomenon has disappeared.

- Check that the basic precautions described in paragraph 3.6.5 have been followed.

- Mounting of probes : insulation from the metal structure common to the motor.

- Interference suppression of probes.

Measurement probes are sensitive components that may be affected by interference.

Most of the problems can be solved with small decoupling capacitors (0.1 to 0.5 μ F) on the probe feedback signals. This solution is only possible with DC voltage signals (12, 24 or 48V) or with 50 Hz AC voltage up to 220V.

- Protection of sensitive devices

If the power of the controller is much higher than the power of sensitive devices connected on the same mains supply, it will be more economical to install an RFI filter on the supply of the low power devices than to install an RFI filter on the controller input. The installation precautions are the same : filter placed close to the device, earthing of the device using a short earth connection, separation of the filter input and output cables.

- Auxiliary cables for shielding the control electronics.

In the event of these connections passing through areas which are subject to high levels of interference, it may be advisable to double their shielding with an auxiliary cable connected at both ends. Circulating currents are thus concentrated in this cable and not in the shielding of the low level connections.

- Self - MC choke or ferrites

Depending on the controller rating and the distance between the motor and the controller, install and wire an Self - MC choke or 2 ferrites between the controller and the motor as described in section 3.6.6.1.

- RFI filter

Install and wire an RFI filter (mains) as described in section 3.6.6.2.

- Shielded motor cable

Between the motor and the controller, use a shielded cable in accordance with the recommendations in section 3.6.6.3.

3.6.9 - Additional information

LEROY-SOMER is available to systems integrators, installers or users to provide any additional information which does not appear in this documentation, as well as for any technical assistance for solving a specific problem.

UMV 4301

Open or closed loop speed controller for asynchronous and synchronous motors

3.7 - Block diagrams

3.7.1 - Control from operator console with factory configuration

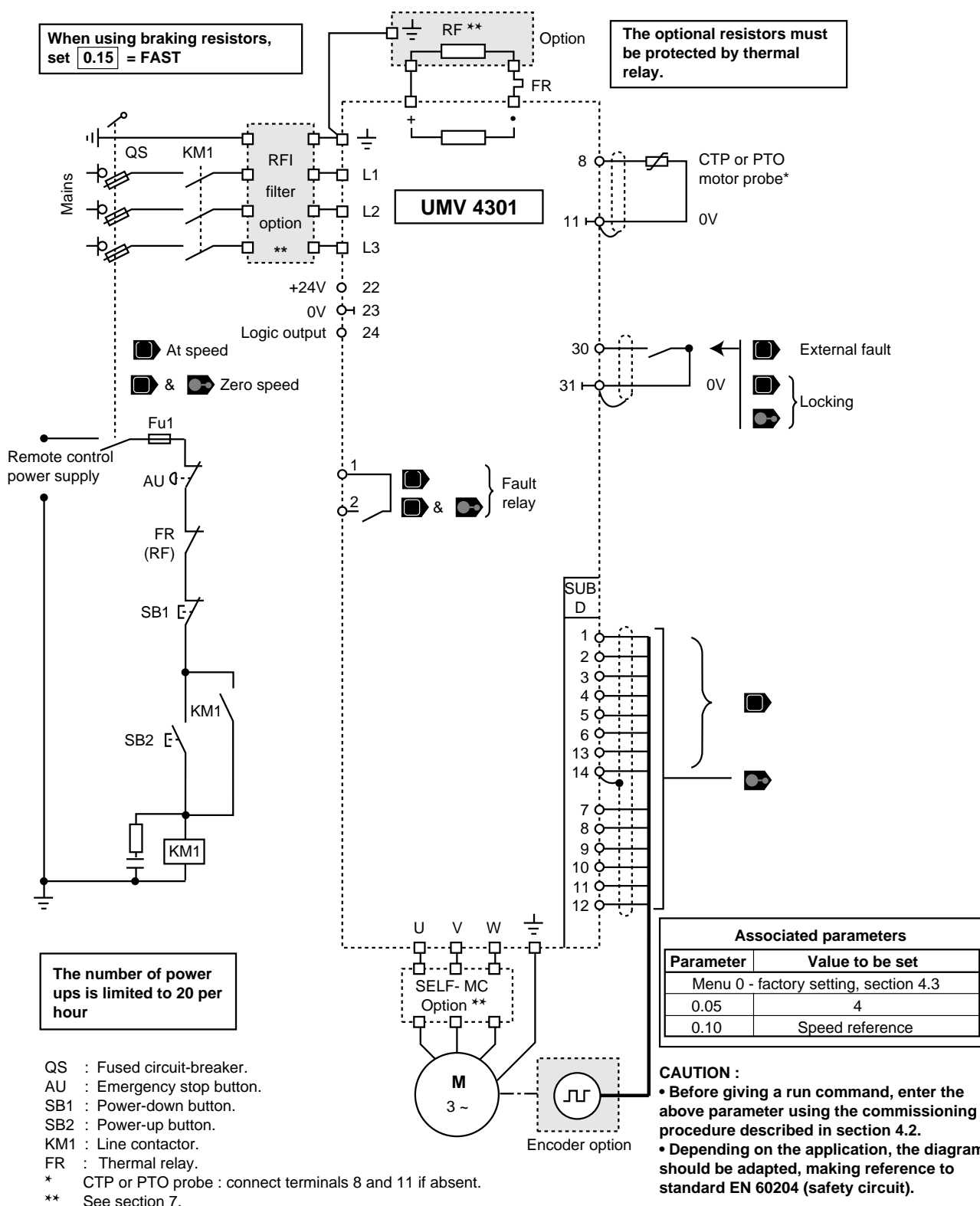

UMV 4301

Open or closed loop speed controller for asynchronous and synchronous motors

3.7.3 - Positive logic control from the terminal block

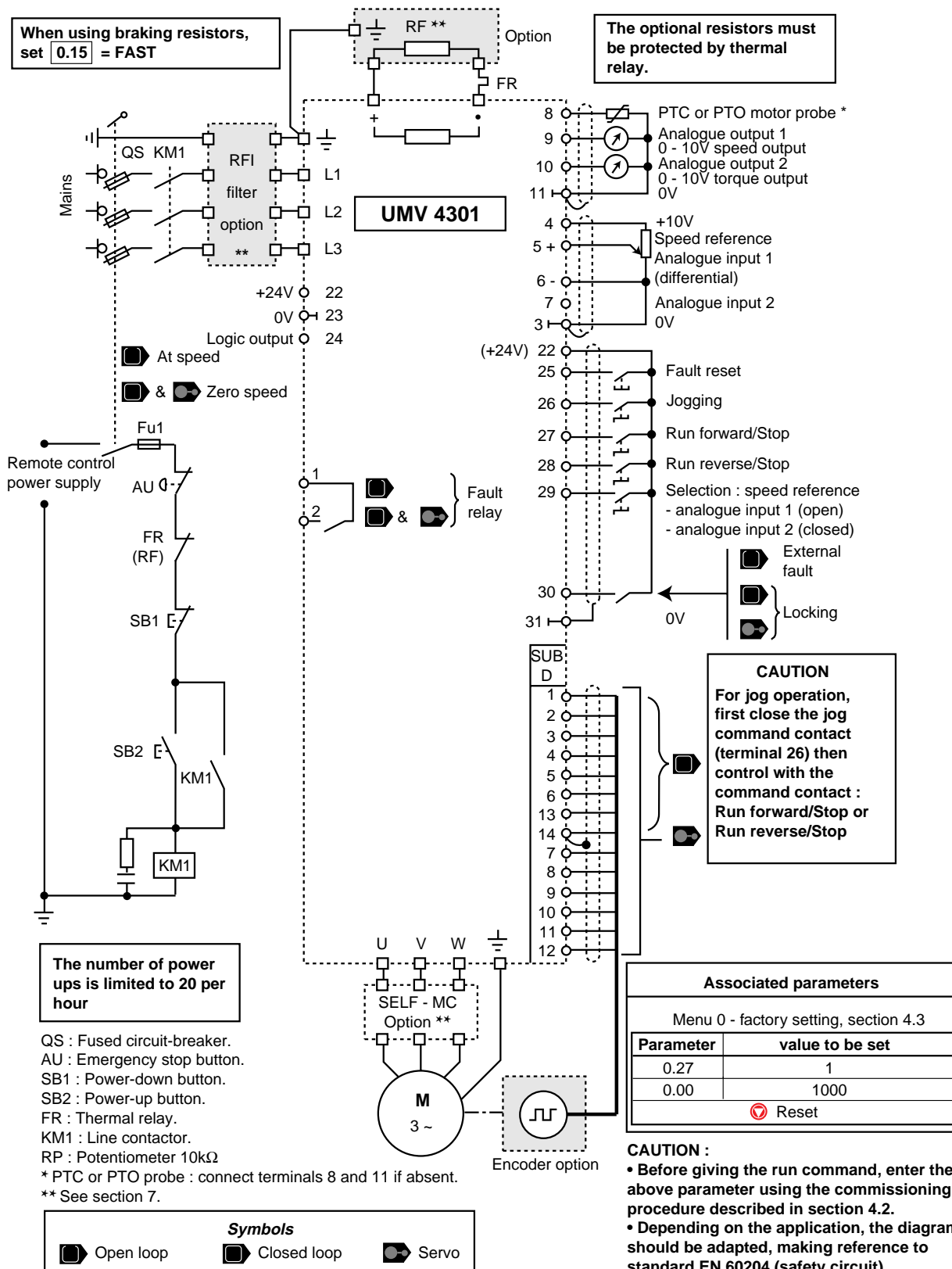

UMV 4301

Open or closed loop speed controller for asynchronous and synchronous motors

3.7.4 - Preset configuration 1 Simplified local/remote operation

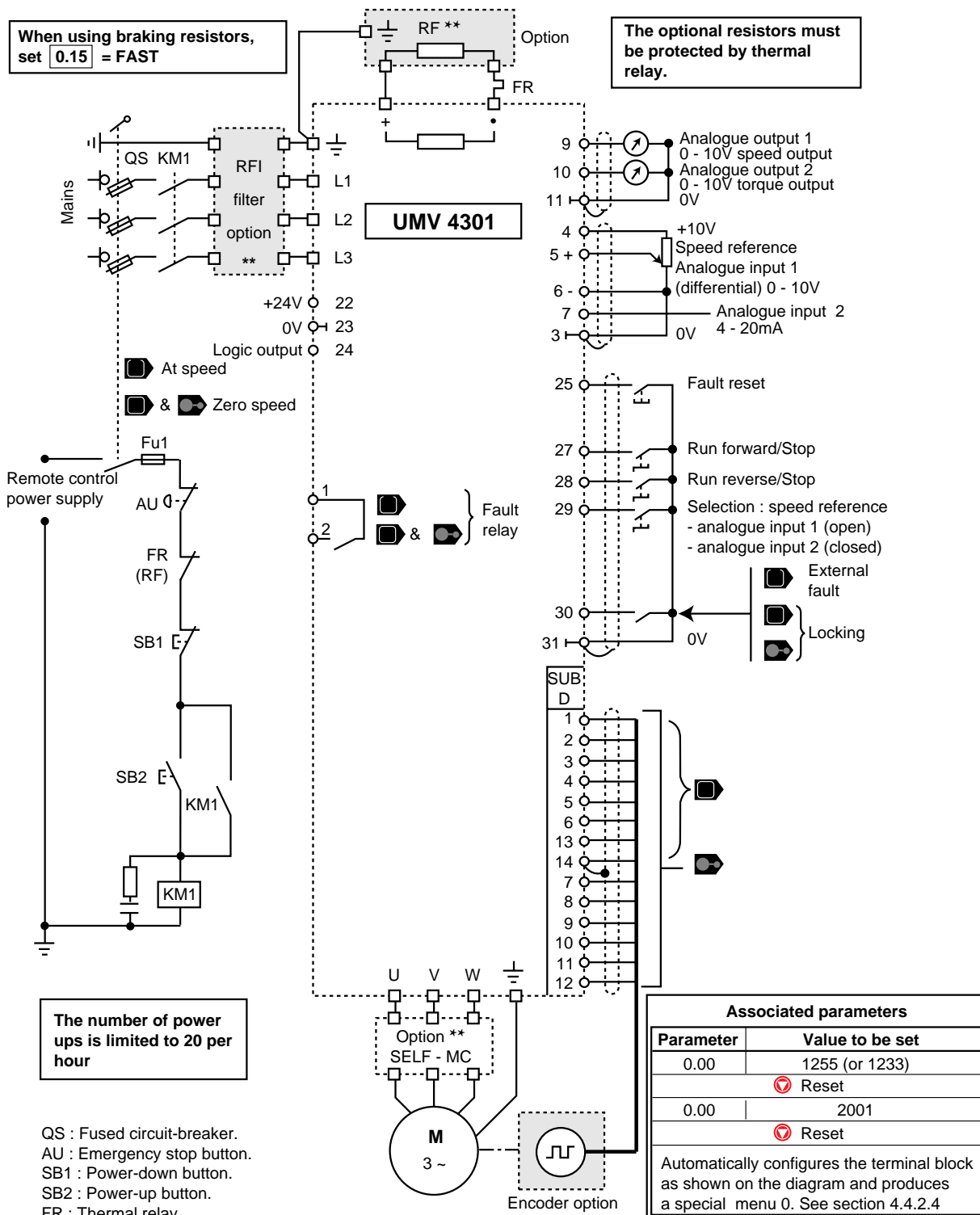

QS : Fused circuit-breaker.
 AU : Emergency stop button.
 SB1 : Power-down button.
 SB2 : Power-up button.
 FR : Thermal relay.
 KM1 : Line contactor.
 RP : Potentiometer 10kΩ
 * PTC or PTO probe : connect terminals 8 and 11 if absent.
 ** See section 7.

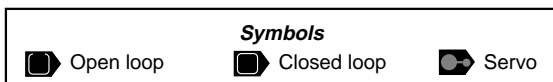

CAUTION :

- Before giving a run command, enter the above parameters using the commissioning procedure described in section 4.2.
- Depending on the application, the diagram should be adapted, making reference to standard EN 60204 (safety circuit).

UMV 4301

Open or closed loop speed controller for asynchronous and synchronous motors

3.7.5 - Preset configuration 2

Speed reference by analogue input or faster / slower command

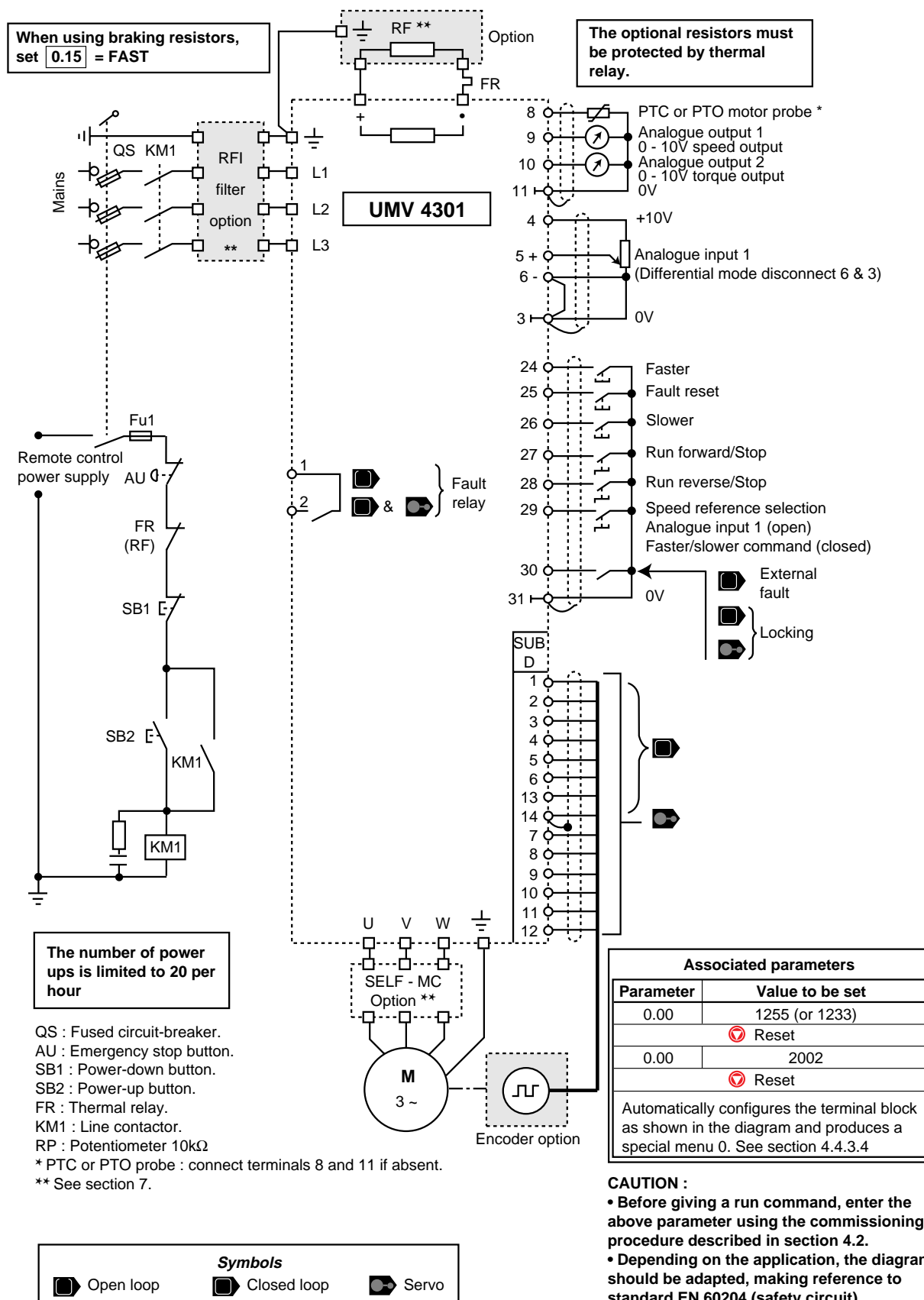

UMV 4301

Open or closed loop speed controller for asynchronous and synchronous motors

3.7.6 - Preset configuration 3

Speed reference by analogue input and 4 preset speeds

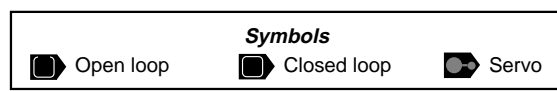
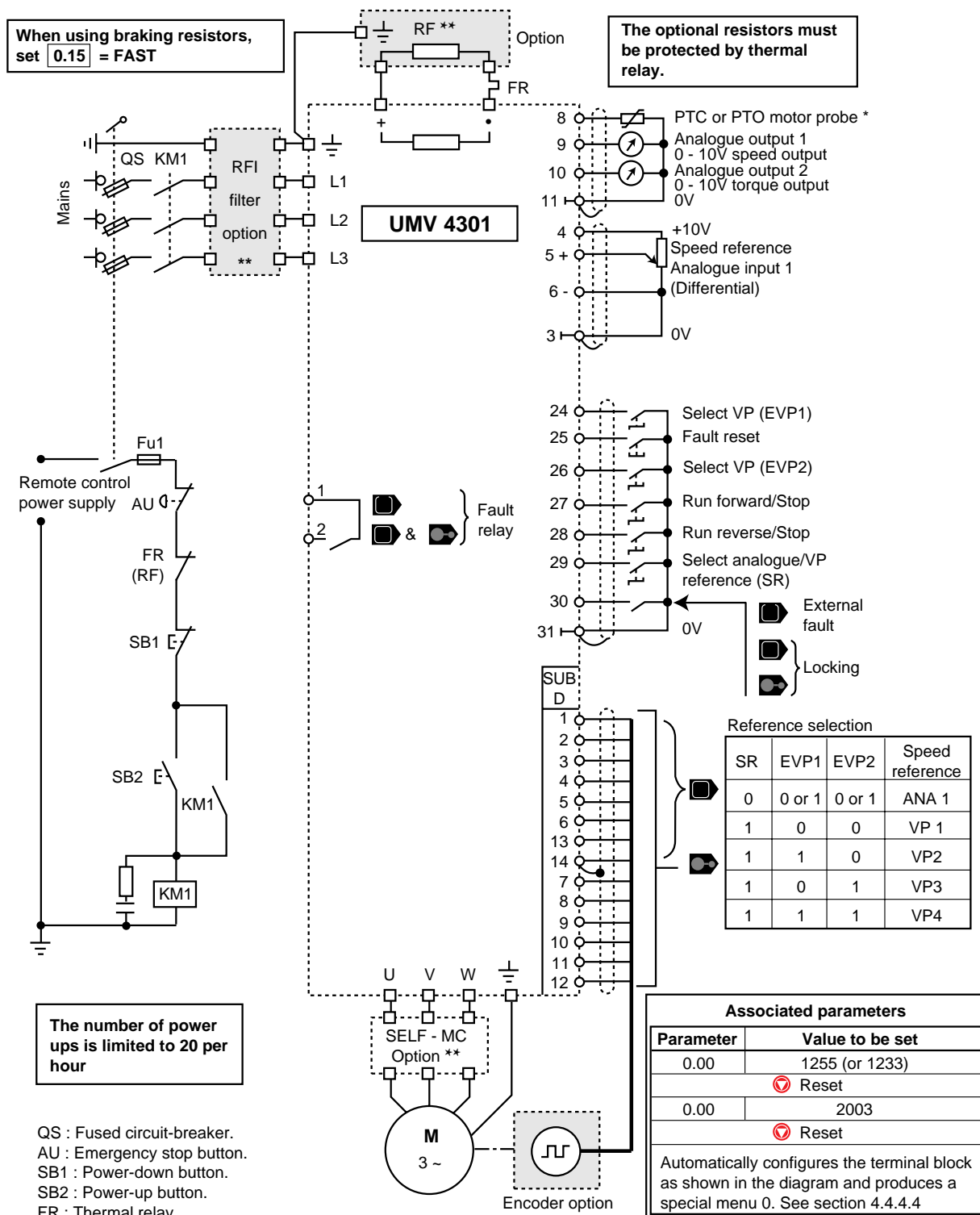

QS : Fused circuit-breaker.
 AU : Emergency stop button.
 SB1 : Power-down button.
 SB2 : Power-up button.
 FR : Thermal relay.
 KM1 : Line contactor.
 RP : Potentiometer 10kΩ
 * PTC or PTO probe : connect terminals 8 and 11 if absent.
 ** See section 7.

UMV 4301

Open or closed loop speed controller for asynchronous and synchronous motors

3.7.7 - Preset configuration 4

Torque control with speed limitation

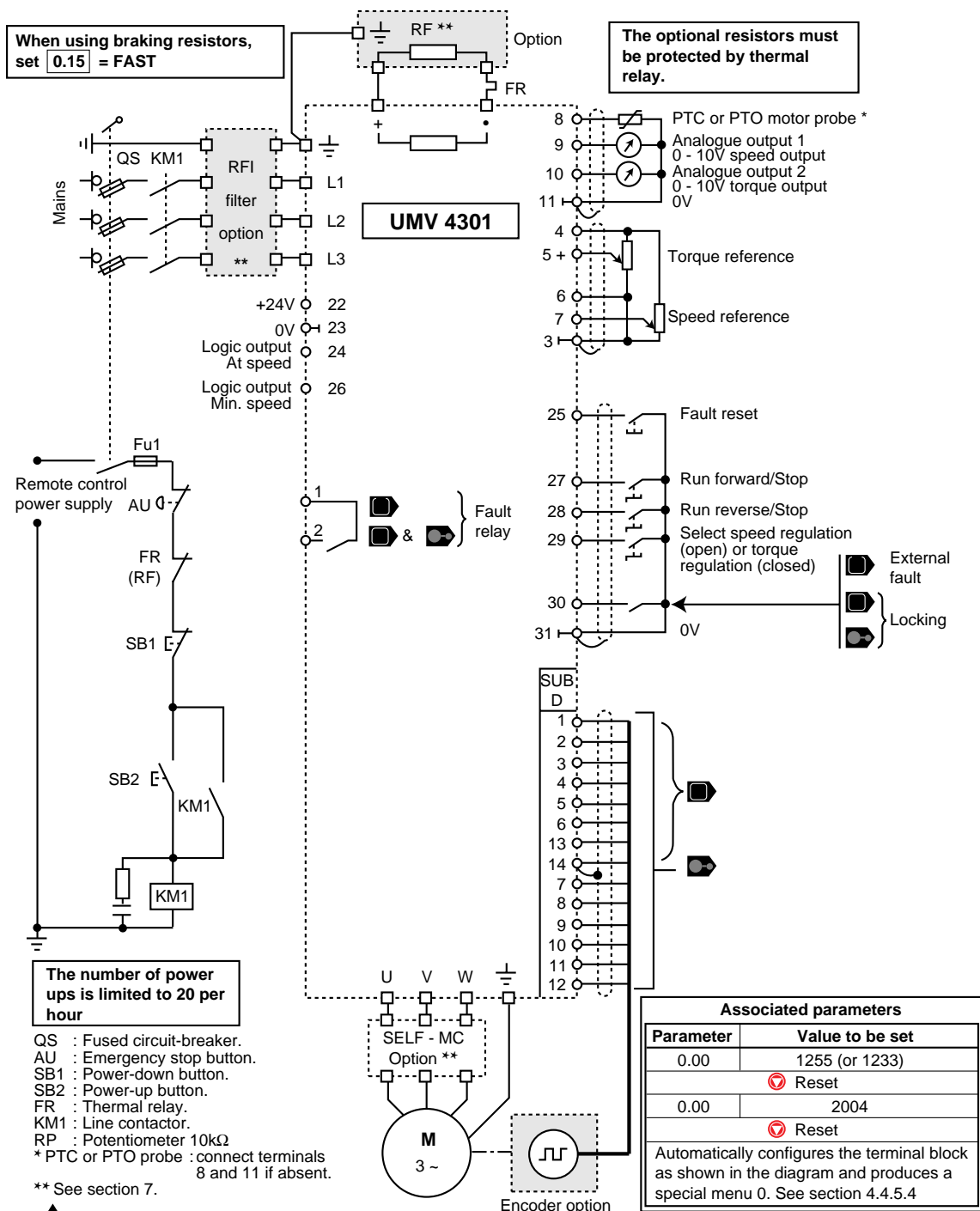

QS : Fused circuit-breaker.
 AU : Emergency stop button.
 SB1 : Power-down button.
 SB2 : Power-up button.
 FR : Thermal relay.
 KM1 : Line contactor.
 RP : Potentiometer 10kΩ
 * PTC or PTO probe : connect terminals 8 and 11 if absent.
 ** See section 7.

! When used in torque control mode, the motor will be overspeeding up to the speed limit set in 0.02 if there is no resisting torque.

For safety reasons, it is recommended to check the maximum speed of the driven machine and set the maximum speed threshold in 0.28.

CAUTION :

- Before giving a run command, enter the above parameter using the commissioning procedure described in section 4.2.
- Depending on the application, the diagram should be adapted, making reference to standard EN 60204 (safety circuit).

Mode	Parameter	Value to be set
[Symbol]	3.29	1
	0.28	Mechanical maximum speed
	0.00	1000
		Reset
[Symbol]	0.28	Mechanical maximum speed
	0.00	1000
		Reset

UMV 4301

Open or closed loop speed controller for asynchronous and synchronous motors

3.7.8 - Preset configuration 5 PID control

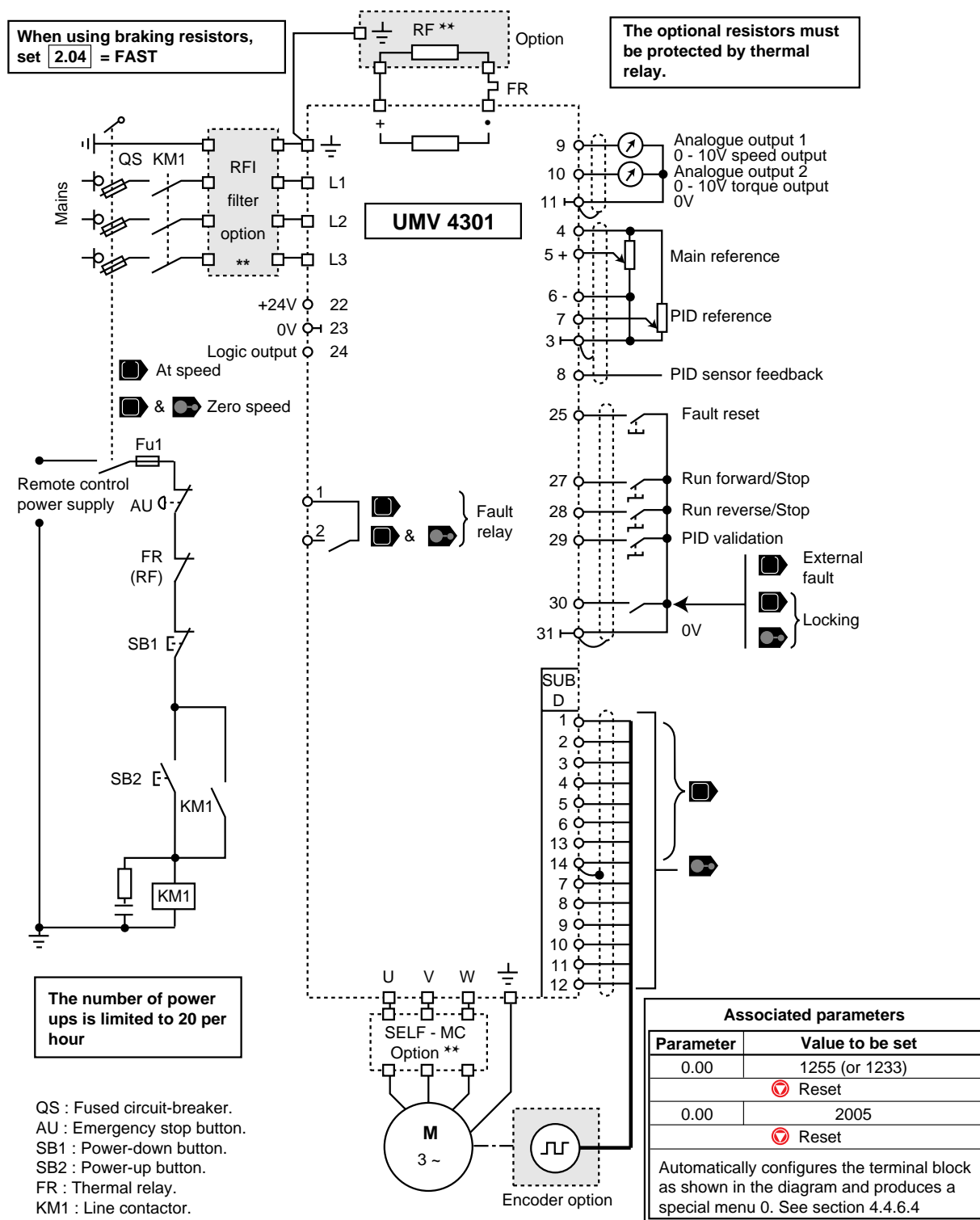

QS : Fused circuit-breaker.
 AU : Emergency stop button.
 SB1 : Power-down button.
 SB2 : Power-up button.
 FR : Thermal relay.
 KM1 : Line contactor.
 RP : Potentiometer 10kΩ
 * PTC or PTO probe : connect terminals 8 and 11 if absent.
 ** See section 7.

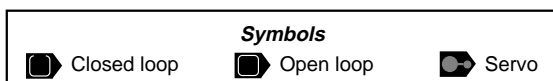

CAUTION :

- Before giving a run command, enter the above parameter using the commissioning procedure described in section 4.2.
- Depending on the application, the diagram should be adapted, making reference to standard EN 60204 (safety circuit).

UMV 4301

Open or closed loop speed controller for asynchronous and synchronous motors

3.7.9 - Preset configuration 6

Axis control - Limit switch positioning

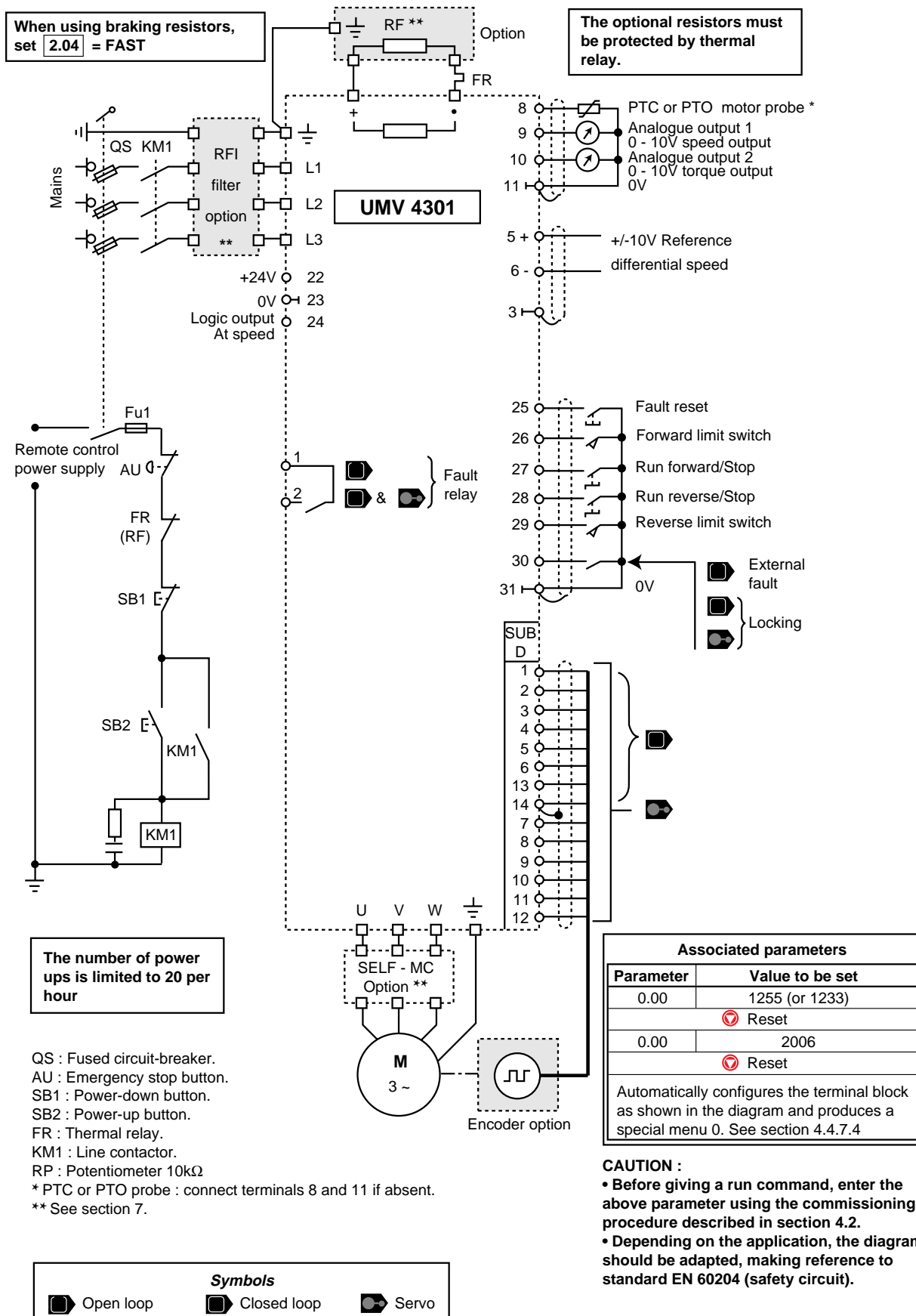

UMV 4301

Open or closed loop speed controller for asynchronous and synchronous motors

3.7.10 - Preset configuration 7

Brake control for horizontal movements

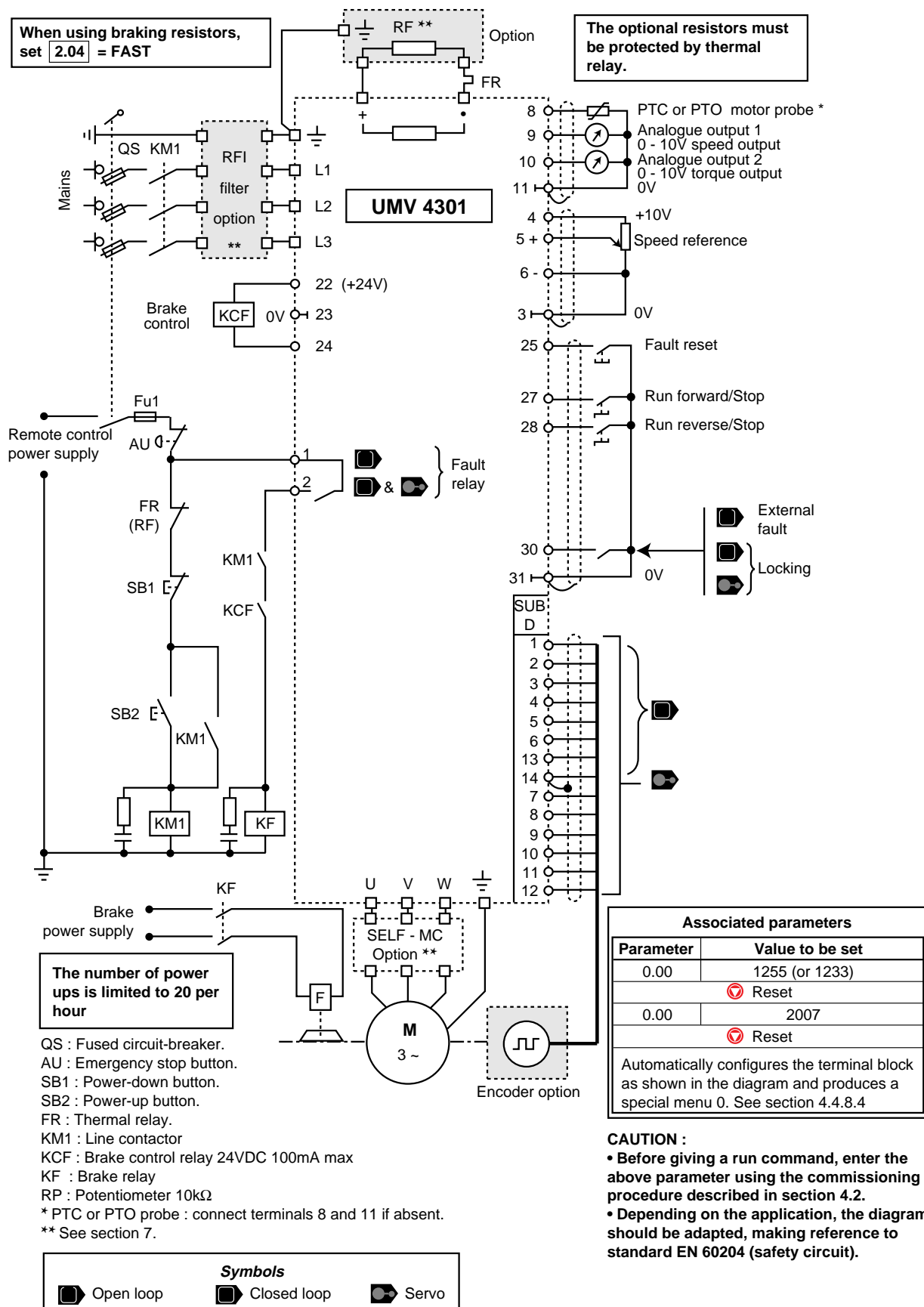

UMV 4301

Open or closed loop speed controller for asynchronous and synchronous motors

3.7.11 - Preset configuration 8

Electrical shaft - Synchronisation mode  and  only

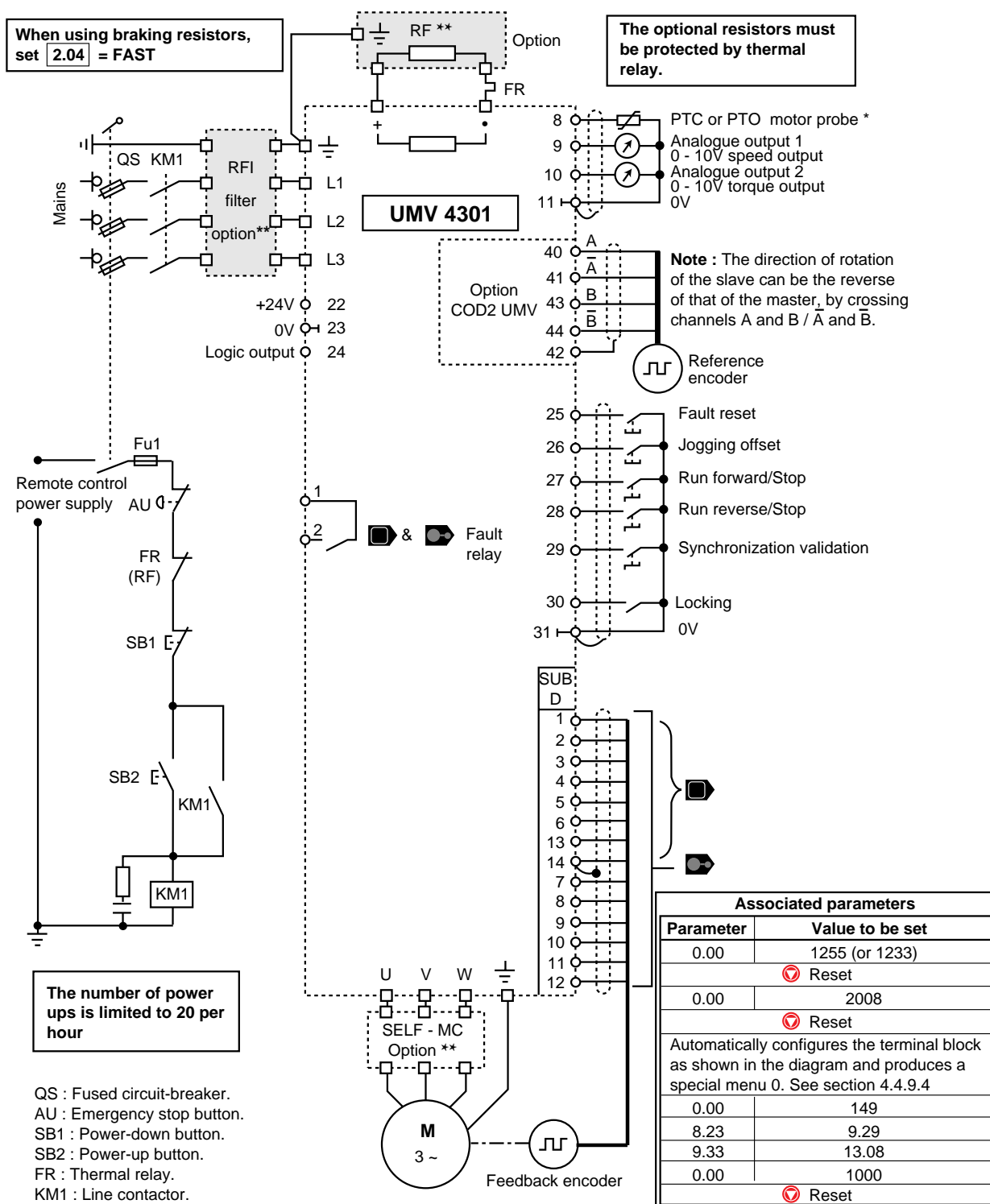

- QS : Fused circuit-breaker.
 AU : Emergency stop button.
 SB1 : Power-down button.
 SB2 : Power-up button.
 FR : Thermal relay.
 KM1 : Line contactor.
 RP : Potentiometer 10kΩ
 * PTC or PTO probe : connect terminals 8 and 11 if absent.
 ** See section 7.

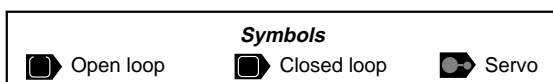

CAUTION :

- Before giving a run command, enter the above parameter using the commissioning procedure described in section 4.2.
- Depending on the application, the diagram should be adapted, making reference to standard EN 60204 (safety circuit).

UMV 4301

Open or closed loop speed controller for asynchronous and synchronous motors

4 - COMMISSIONING



- The controllers use software which is adjusted using parameters.
- The performance level depends on the parameter setting.
- Incorrect settings may have severe consequences for personnel and machinery.
- The parameters of the controllers should only be set by experienced and qualified personnel.

4.1 - Using the operator console

4.1.1 - Presentation

The console is identical for all controllers and is used to access the adjustment parameters and to control the drive.

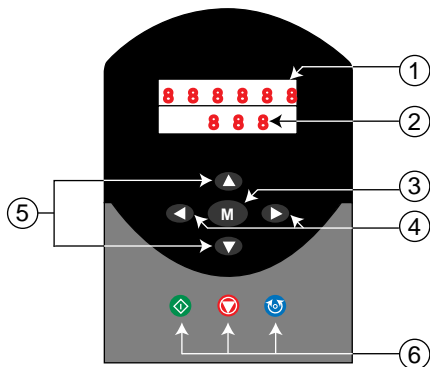

- 1 Upper display consisting of six 7-segment display lines for showing :
 - the operating mode,
 - the contents of the parameters,
 - the trip code.
- 2 Upper display consisting of four 7-segment display lines for showing :
 - the operating state of the controller,
 - the adjustment parameters, consisting of the menu and the parameter.
- 3 1 mode key **M** for switching from normal mode to parameter setting mode. (In parameter setting mode, the upper display flashes).
- 4 2 keys **◀ ▶** for moving under the 7-segment display lines in the upper display to modify its value or change from one menu to another.
- 5 2 keys **▲ ▼** for scrolling up or down through the parameters or their values.
- 6 3 keys **◊ ⚡ ⚙** for initiating the following commands from the operator console :
 - ◊** (green key) : Run,
 - ⚡** (red key) : Stop, fault reset,
 - ⚙** (blue key) : Reverse the direction of rotation.

4.1.2 - Adjustment parameters

The drive is configured for a given application by programming the parameters which are organized into menus.

Each menu corresponds to a group of parameters linked by a function.

This manual describes the parameters in menu 0, which contains the main parameters of the various menus which are used for quick and simple starting-up in the various standard operating modes.

The other menus and parameters are protected by an access code.

Access to the digital or bit (value 0 or 1) parameters is possible :

- either in " read only " mode (R), for example : motor speed or current output,
- or in " read write " mode (R/W), for example : acceleration ramp.

UMV 4301

Open or closed loop speed controller for asynchronous and synchronous motors



















4.1.3 - Modifying the parameters

Action		Display	Comments																																				
Power up controller		<table border="1"> <tr><td>O</td><td>P</td><td>E</td><td>N</td><td>L</td><td>P</td></tr> <tr><td></td><td></td><td>r</td><td>d</td><td>Y</td><td></td></tr> </table> <p>or</p> <table border="1"> <tr><td>C</td><td>L</td><td>V</td><td>E</td><td>C</td><td>t</td></tr> <tr><td></td><td></td><td>r</td><td>d</td><td>Y</td><td></td></tr> </table> <p>or</p> <table border="1"> <tr><td>S</td><td>E</td><td>r</td><td>V</td><td>o</td><td></td></tr> <tr><td></td><td></td><td>r</td><td>d</td><td>Y</td><td></td></tr> </table>	O	P	E	N	L	P			r	d	Y		C	L	V	E	C	t			r	d	Y		S	E	r	V	o				r	d	Y		For 1 second after power-up, the upper display shows the selected control mode.
O	P	E	N	L	P																																		
		r	d	Y																																			
C	L	V	E	C	t																																		
		r	d	Y																																			
S	E	r	V	o																																			
		r	d	Y																																			
1 second after power-up		<table border="1"> <tr><td></td><td></td><td></td><td></td><td></td><td>0</td></tr> <tr><td></td><td></td><td>r</td><td>d</td><td>Y</td><td></td></tr> </table>						0			r	d	Y		The upper display indicates the speed of the motor																								
					0																																		
		r	d	Y																																			
Switch to parameter mode		<table border="1"> <tr><td></td><td></td><td></td><td></td><td></td><td>0</td></tr> <tr><td></td><td></td><td>0.</td><td>1</td><td>0</td><td></td></tr> </table>						0			0.	1	0		Parameter 0.10 corresponds to the motor speed																								
					0																																		
		0.	1	0																																			
Access to the various parameters		<table border="1"> <tr><td></td><td></td><td></td><td></td><td></td><td>0</td></tr> <tr><td></td><td></td><td>0.</td><td>1</td><td>1</td><td></td></tr> </table>						0			0.	1	1		The key switches from one parameter to the next. The content of the parameters is displayed on the upper display.																								
						0																																	
			0.	1	1																																		
	<table border="1"> <tr><td></td><td></td><td></td><td></td><td></td><td>0</td></tr> <tr><td></td><td></td><td>0.</td><td>1</td><td>0</td><td></td></tr> </table>						0			0.	1	0		The key switches from one parameter to the previous parameter																									
					0																																		
		0.	1	0																																			
+ simultaneously	<table border="1"> <tr><td></td><td></td><td></td><td></td><td></td><td>0</td></tr> <tr><td></td><td></td><td>0.</td><td>0</td><td>0</td><td></td></tr> </table>						0			0.	0	0		Simultaneously pressing the and keys provides immediate access to parameter 0 in the menu which is currently selected																									
					0																																		
		0.	0	0																																			
Modification of a digital parameter		<table border="1"> <tr><td></td><td></td><td></td><td></td><td>0.</td><td>0</td></tr> <tr><td></td><td></td><td>0.</td><td>0</td><td>1</td><td></td></tr> </table>					0.	0			0.	0	1		Accesses parameter 0.01																								
				0.	0																																		
		0.	0	1																																			
Example : changing parameter 0.01 (minimum speed) to 5Hz		<table border="1"> <tr><td></td><td></td><td></td><td></td><td>0.</td><td>0</td></tr> <tr><td></td><td></td><td>0.</td><td>0</td><td>1</td><td></td></tr> </table>					0.	0			0.	0	1		Pressing accesses the contents of parameter 0.01																								
					0.	0																																	
			0.	0	1																																		
		<table border="1"> <tr><td></td><td></td><td></td><td></td><td>0.</td><td>0</td></tr> <tr><td></td><td></td><td>0.</td><td>0</td><td>1</td><td></td></tr> </table>					0.	0			0.	0	1		Moves the cursor onto the number to be modified																								
				0.	0																																		
		0.	0	1																																			
5 x	<table border="1"> <tr><td></td><td></td><td></td><td></td><td>5.</td><td>0</td></tr> <tr><td></td><td></td><td>0.</td><td>0</td><td>1</td><td></td></tr> </table>					5.	0			0.	0	1		Sets the required value																									
				5.	0																																		
		0.	0	1																																			
	<table border="1"> <tr><td></td><td></td><td></td><td></td><td>5.</td><td>0</td></tr> <tr><td></td><td></td><td>0.</td><td>0</td><td>1</td><td></td></tr> </table>					5.	0			0.	0	1		Confirms the selection and exits the contents of parameter 0.01																									
				5.	0																																		
		0.	0	1																																			
Modifying a bit parameter	8 x	<table border="1"> <tr><td></td><td></td><td>b</td><td>i</td><td>t</td><td>0</td></tr> <tr><td></td><td></td><td>0.</td><td>0</td><td>9</td><td></td></tr> </table>			b	i	t	0			0.	0	9		Selecting the dynamic V/F ratio corresponds to parameter 0.09																								
		b	i	t	0																																		
		0.	0	9																																			
Example : selection of dynamic V/F mode		<table border="1"> <tr><td></td><td></td><td>b</td><td>i</td><td>t</td><td>0</td></tr> <tr><td></td><td></td><td>0.</td><td>0</td><td>9</td><td></td></tr> </table>			b	i	t	0			0.	0	9		Accesses the contents of parameter 0.09																								
			b	i	t	0																																	
			0.	0	9																																		
	<table border="1"> <tr><td></td><td></td><td>b</td><td>i</td><td>t</td><td>1</td></tr> <tr><td></td><td></td><td>0.</td><td>0</td><td>9</td><td></td></tr> </table>			b	i	t	1			0.	0	9		Confirms the the dynamic V/F ratio by changing the bit to 1																									
		b	i	t	1																																		
		0.	0	9																																			
	<table border="1"> <tr><td></td><td></td><td>b</td><td>i</td><td>t</td><td>1</td></tr> <tr><td></td><td></td><td>0.</td><td>0</td><td>9</td><td></td></tr> </table>			b	i	t	1			0.	0	9		Confirms the selection and exits the contents																									
		b	i	t	1																																		
		0.	0	9																																			



UMV 4301

Open or closed loop speed controller for asynchronous and synchronous motors

4.1.3 - Modifying the parameters (end)

Action	Display	Comments												
Storing the parameters when the adjustments have been completed	 +  simultaneously	<table border="1"><tr><td></td><td></td><td></td><td></td><td>0</td></tr><tr><td>0.</td><td>0</td><td>0</td><td>0</td><td></td></tr></table>					0	0.	0	0	0		Accesses parameter 0.00	
					0									
	0.	0	0	0										
		<table border="1"><tr><td></td><td></td><td></td><td></td><td>0</td></tr><tr><td>0.</td><td>0</td><td>0</td><td>0</td><td></td></tr></table>					0	0.	0	0	0		Enters the contents of parameter 0.00	
					0									
0.	0	0	0											
3 x 	<table border="1"><tr><td></td><td></td><td>-</td><td></td><td>0</td></tr><tr><td></td><td></td><td></td><td></td><td></td></tr></table>			-		0						Moves the cursor onto the 4th digit from the right		
		-		0										
	<table border="1"><tr><td></td><td></td><td>1</td><td>0</td><td>0</td><td>0</td></tr><tr><td>0.</td><td>0</td><td>0</td><td>0</td><td></td><td></td></tr></table>			1	0	0	0	0.	0	0	0			Press the  key to display 1000 on the upper display
		1	0	0	0									
0.	0	0	0											
	<table border="1"><tr><td></td><td></td><td>1</td><td>0</td><td>0</td><td>0</td></tr><tr><td>0.</td><td>0</td><td>0</td><td>0</td><td></td><td></td></tr></table>			1	0	0	0	0.	0	0	0			Press the red key  to store the parameters
		1	0	0	0									
0.	0	0	0											
Switching from one menu to another		<table border="1"><tr><td></td><td></td><td></td><td></td><td>0</td></tr><tr><td>0.</td><td>0</td><td>0</td><td>0</td><td></td></tr></table>					0	0.	0	0	0			
					0									
	0.	0	0	0										
		<table border="1"><tr><td></td><td></td><td></td><td></td><td>0</td></tr><tr><td>0.</td><td>0</td><td>0</td><td>0</td><td></td></tr></table>					0	0.	0	0	0		Enters the contents of parameter 0.00	
					0									
	0.	0	0	0										
	9 x 	<table border="1"><tr><td></td><td></td><td></td><td></td><td>9</td></tr><tr><td></td><td></td><td></td><td></td><td></td></tr></table>					9						Displays 9	
					9									
		<table border="1"><tr><td></td><td></td><td></td><td>-</td><td>9</td></tr><tr><td></td><td></td><td></td><td></td><td></td></tr></table>				-	9						Moves the cursor to the digit located to the left of 9	
			-	9										
4 x 	<table border="1"><tr><td></td><td></td><td></td><td>4</td><td>9</td></tr><tr><td></td><td></td><td></td><td></td><td></td></tr></table>				4	9						Displays 49		
			4	9										
	<table border="1"><tr><td></td><td></td><td></td><td>-</td><td>4</td><td>9</td></tr><tr><td></td><td></td><td></td><td></td><td></td><td></td></tr></table>				-	4	9							Moves the cursor to the digit located to the left of 4
			-	4	9									
	<table border="1"><tr><td></td><td></td><td></td><td>1</td><td>4</td><td>9</td></tr><tr><td></td><td></td><td></td><td></td><td></td><td></td></tr></table>				1	4	9							Displays 149
			1	4	9									
	<table border="1"><tr><td></td><td></td><td></td><td>1</td><td>4</td><td>9</td></tr><tr><td>0.</td><td>0</td><td>0</td><td>0</td><td></td><td></td></tr></table>				1	4	9	0.	0	0	0			Confirms the selection
			1	4	9									
0.	0	0	0											
	<table border="1"><tr><td></td><td></td><td></td><td></td><td></td><td>0</td></tr><tr><td>1.</td><td>0</td><td>0</td><td>0</td><td></td><td></td></tr></table>						0	1.	0	0	0			The  key is used to move from one menu to the next
					0									
1.	0	0	0											
	<table border="1"><tr><td></td><td></td><td></td><td></td><td></td><td>0</td></tr><tr><td>0.</td><td>0</td><td>0</td><td>0</td><td></td><td></td></tr></table>						0	0.	0	0	0			The  key is used to move from one menu to the previous menu
					0									
0.	0	0	0											

Additional information

- If no operation is performed on the operator console for 8s, the display returns to parameter 0.10 (motor speed).
- For fast scrolling, hold down keys  or .

UMV 4301

Open or closed loop speed controller for asynchronous and synchronous motors

4.2 - Starting up the controller

- Before powering up the controller, ensure that all power connections are correct, that the motor is correctly connected and that the moving parts are mechanically protected.
- Users must take particular care to avoid accidental starts of the controller.
- Where braking resistors are used, check that they are correctly connected between the + and • terminals and that they are protected by a correctly sized thermal relay.

4.2.1 - Reset function

Notes :



The controller must be reset in the following situations :

- reset after a controller trip,
- after modification of the operating mode,
- to take account of new values for certain parameters marked with  .

New values can be activated and stored while the controller is running.

- Procedure :







via the terminal block : close the trip reset contact (terminal 25),

- from the operator console : press key  when the controller is stopped,
- hold down key  and press the reset key  while the controller is running.

4.2.2 - Using parameter 0.00

- Before returning to default settings, check that the safety of the system will not be affected.

Set the following values in parameter 0.00 to obtain the following functions :

Function	Setting/Action			
Access to other menus	0.00 = 149			
Storage of new values	0.00 = 1000	Reset 		
Return to US default settings	0.00 = 1244	Reset 	0.00 = 1000	Reset 
Modification of operating mode and return to European default settings in conjunction with 0.48	0.00 = 1253	See § 4.2.3		
Modification of operating mode and return to US default settings in conjunction with 0.48	0.00 = 1254	See § 4.2.3		
Return to European default settings	0.00 = 1255 (or 1233)	Reset 	0.00 = 1000	Reset 
Lock access to other menus	0.00 = 2000	Reset 		
Access to preset configurations 1 to 8	0.00 = 2001 to 2010	See § 4.2.9		

4.2.3 - Modifying the operating mode

- Modifying the operating mode will result in a return to default settings for the corresponding parameters in the new mode.
- The operating mode must be modified with the controller stopped or locked.

Parameter	Setting/Display	Description
0.00	1253	Modification of operating mode and return to European default settings
	1254	Modification of operating mode and return to US default settings
0.48	OPEN.LP	Open loop (default setting)
	CL.VECt	Closed loop vector control
	SerVO	Servo mode with Brushless motor
RESET 		

UMV 4301

Open or closed loop speed controller for asynchronous and synchronous motors

4.2.4 - Selecting the run command

- From the keypad (see wiring diagram in section 3.7.1) : run, stop and speed control command with the keys.



- Via the terminal block (see wiring diagram in section 3.7.2) : run, stop and speed control command via the terminal block (connector).

Parameter	Setting/Display	Description
	0	Selection of analogue reference 1 or 2 via terminal 29
0.05	1	Analogue speed reference 1
	2	Analogue speed reference 2
	4	Control via the keypad
0.00	1000	Store Reset 

4.2.5 - Programming the motor parameters



- The values of the motor parameters affect the motor protection and the safety of the system.
- The parameter values must be read on the nameplate of the motor being used.
- The motor parameters must be set with a minimum accuracy of 10% of the rated values in order to achieve good performance.
- After modifying the operating mode, the motor parameters must be entered before restarting.

Parameter	Description	default setting	Adjustment range	Unit
0.42	No. of poles	4 [6]	2 to 24	Poles
0.43	Power factor (cos φ)	0.92 [1]	0 to 1.0	-
0.44	Motor rated voltage	T : 400 (460) TL : 220 (264)	0 to 480	V
0.45	Motor rated speed	0	0 to 6000 (open loop) 0 to 30000 (Closed loop)	min ⁻¹
0.46	Motor rated current 	I _{max} contr.	0 to I _{max} controller	A
0.47	Motor rated frequency	50 (60)	0 to 1000	Hz
0.00	Storage	0	1000 +  reset	-

 With synchronous motors in servo mode, enter the stall current value in parameter 0.46.



- Before programming a high speed, check that the motor and the machine can withstand it.

() USA values.

[] Servo motor values.

4.2.6 - Autotune of controller to motor





- During the autotune phase, the controller supplies the motor, thus causing it to rotate. Ensure that this operation does not affect the safety of machinery or personnel.
- Autotune must be performed each time the operating mode is modified.

During autotune, the characteristics of the motor, and the encoder when used, are measured and the controller adapts automatically.

- Check that the motor is disconnected from its load.
- Power up the controller.
- Connect locking input (terminal 30) to terminal 0V (terminal 31).
- Set parameter 0.40 to 1. The autotune sequence begins.

- Depending on the selected operating mode, the following phase occurs :

 The motor accelerates up to 2/3 its rated speed. The controller measures the magnetizing current, then decelerates and stops the motor. The power factor is measured and automatically entered in parameter 0.43. Parameter 0.40 returns to 0.

 The same sequence as in open loop mode is performed with the addition of encoder control.

 The motor rotates 360° (1 revolution) with the encoder stalled.

When the autotune is completed, store the new value by setting 0.00 at 1000 +  Reset.

UMV 4301

Open or closed loop speed controller for asynchronous and synchronous motors

4.2.7 - Control from the terminal block

- Refer to the diagram in section 3.7.2.
- Make at least the following connections :

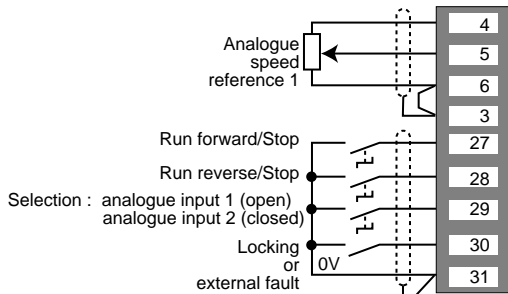

- Set the potentiometer to the minimum setting.
- Leave terminal 29 open to select Analogue reference 1.
- Power up the controller. The lower display shows "rdy".
- Display parameter 0.10 to give the speed measurement.
- Close locking contact (terminal 30).
- Give a run forward or run reverse command (terminal 27 or 28).
- Give a speed reference via the potentiometer. The upper display shows :
 - ▣ the frequency in Hertz,
 - ▣ , ▣ the speed in min^{-1} .
- Disable the run command (by opening terminal 27 or 28). The motor slows and stops. The display shows " rdy ".

4.2.8 - Control via the keypad

- Refer to the diagram in section 3.7.1.
- Make at least the following connections :

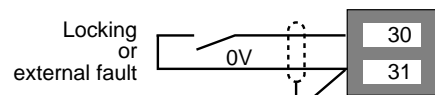











- Do not connect terminal 29 to 0V.
- Power up the controller, the display shows " rdy ".
- Program parameter 0.05 to 4 (selection of speed reference via the keypad).
- Display parameter 0.10 to give the speed measurement.
- Close locking contact (terminal 30) to 0V (terminal 31).
- Press the key to start.
- Press the key to increase the speed.
- Press the key to decrease the speed of the motor.
- To stop the motor press the key. The display shows " rdy " or " stop " for servo mode.

UMV 4301

Open or closed loop speed controller for asynchronous and synchronous motors

4.2.9 - Selecting a preset configuration

If the operation of the installation does not correspond to the factory configuration of the controller, it is possible to select another preset configuration. This causes automatic adaptation of the terminal block to the selected configuration and the production of a special menu 0.

Preset configuration	Description	Access	Diagram	Special menu 0	Storage
1	Simplified local/remote operation	0.00 = 2001 +  Reset	3.7.4	4.4.2.4	0.00 = 1000 +  Reset
2	Speed reference via analogue input or faster/slower command	0.00 = 2002 +  Reset	3.7.5	4.4.3.4	
3	Speed reference via analogue input or 4 preset speeds	0.00 = 2003 +  Reset	3.7.6	4.4.4.4	
4	Torque control with speed limitation	0.00 = 2004 +  Reset	3.7.7	4.4.5.4	
5	PID control	0.00 = 2005 +  Reset	3.7.8	4.4.6.4	
6	Axis control - Position control by limit switches	0.00 = 2006 +  Reset	3.7.9	4.4.7.4	
7	Brake control for horizontal movement	0.00 = 2007 +  Reset	3.7.10	4.4.8.4	
8	Electrical shaft - Synchronisation mode ( and ) only	0.00 = 2008 +  Reset	3.7.11	4.4.9.4	

For special configurations not covered in this manual, please refer to the " Parameter setting and block diagrams " manual ref. 2465 for access to all the parameters and possibilities of the UMV 4301 controller.

WARNING :

To change from one configuration to another, it is essential to return to default settings first (0.00 = 1255 +  Reset).

UMV 4301

Open or closed loop speed controller for asynchronous and synchronous motors

4.3 - Menu 0 - Factory configuration

4.3.1 - Open loop block diagram ()

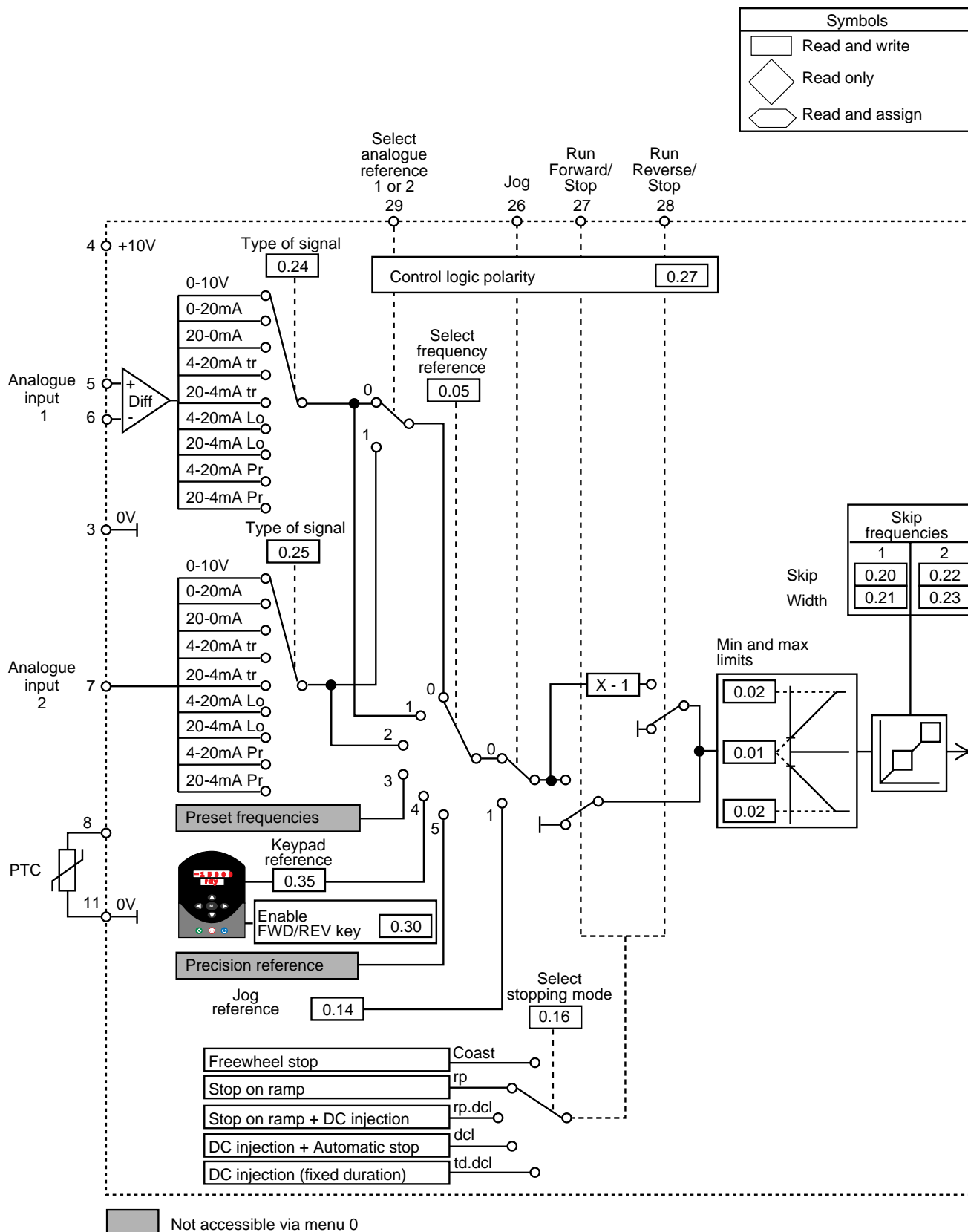

UMV 4301

Open or closed loop speed controller for asynchronous and synchronous motors

Symbols	
	Read and write
	Read only
	Read and assign

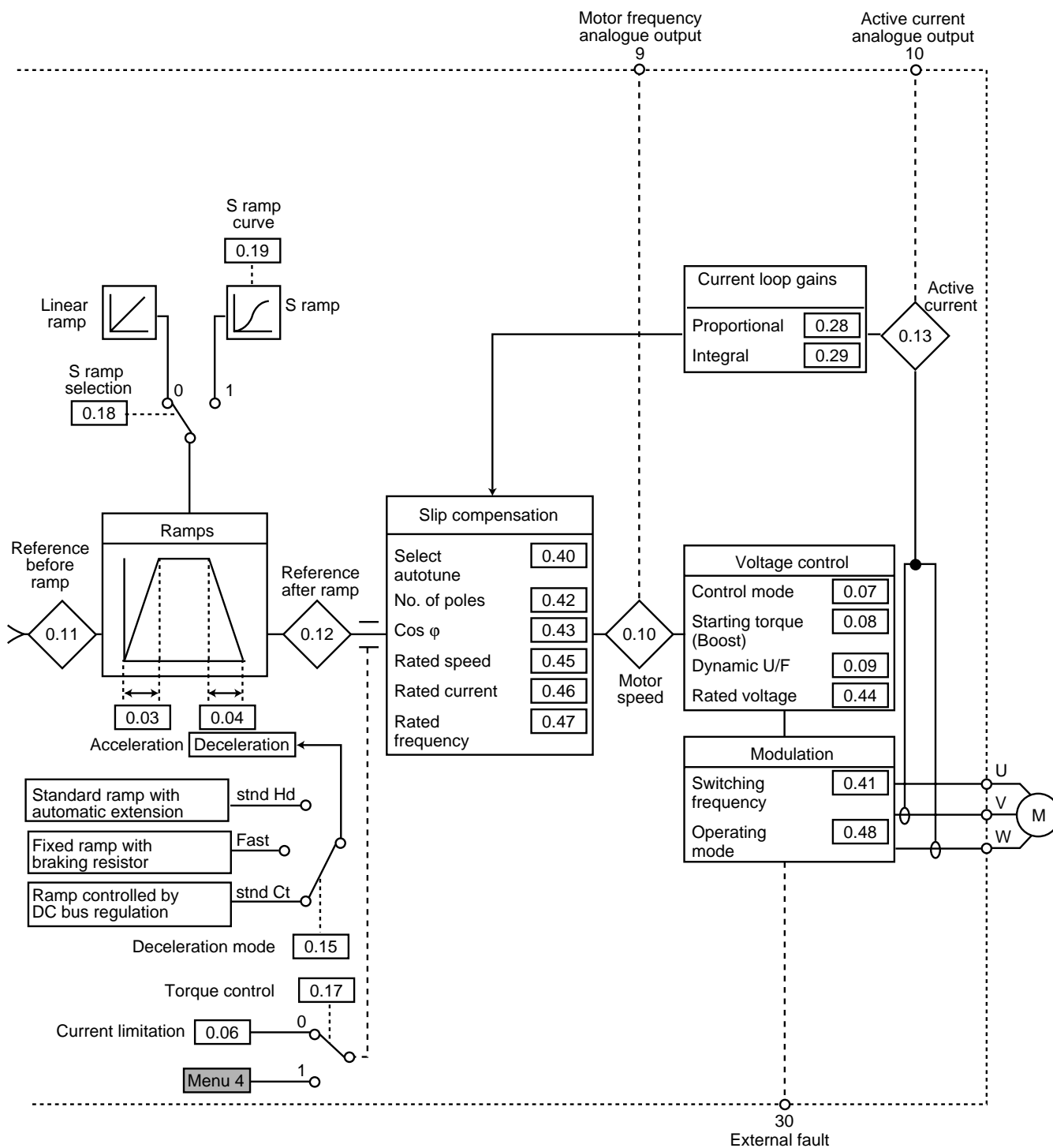

UMV 4301

Open or closed loop speed controller for asynchronous and synchronous motors

4.3.2 - List of open loop parameters ()

Parameter	Description	Address	Type	Adjustment range	default setting
0.00	Storage Return to default settings Selection of operating mode Code for access to other menus Selection of preset configurations		R/W	0 to 9999	0
0.01	Minimum speed limit	1.07	R/W	0 to 0.02	0
0.02	Maximum speed limit	1.06	R/W	0 to 1000.0 Hz	50 Hz
0.03	Acceleration ramp	2.11	R/W	0 to 3200.0s/100Hz	5.0s/100 Hz
0.04	Deceleration ramp	2.21	R/W	0 to 3200.0 s/100 Hz	10.0 s/100 Hz
0.05	Selection of frequency references	1.14	R/W	0 to 5	0
0.06	Current limitation	4.07	R/W	0 to 150%	150 %
0.07	Control mode	5.14	R/W	Urs, Ur1, Ur, Fd	Ur1
0.08	Starting torque (Boost)	5.15	R/W	0 to 25 %	3 %
0.09	Selection of dynamic V/F mode	5.13	R/W	0 or 1	0
0.10	Measurement of motor speed	5.04	RO	$\pm 6000 \text{ min}^{-1}$	-
0.11	Frequency reference before ramp	1.03	RO	$\pm 1000.0 \text{ Hz}$	-
0.12	Frequency reference after ramp	2.01	RO	$\pm 1000.0 \text{ Hz}$	-
0.13	Measurement of motor active current	4.02	RO	$\pm I \text{ max (A)}$	-
0.14	Jog reference	1.05	R/W	0 to 400.0 Hz	1.5 Hz
0.15	Selection of deceleration mode	2.04	R/W	Std.Hd, FAST, Std.Ct	Std.Ct
0.16	Selection of stopping mode	6.01	R/W	Coast, rp, rp.dc1, dc1, tdc1	rp
0.17	Selection of torque control	4.11	R/W	0 or 1	0
0.18	Linear ramp/S ramp selection	2.06	R/W	0 or 1	0
0.19	S ramp curve	2.07	R/W	0 to 3000.0 s ² /100 Hz	3.1 s ²
0.20	Skip frequency 1	1.29	R/W	0 to 1000.0 Hz	0
0.21	Width of skip frequency 1	1.30	R/W	0 to 5.0 Hz	0.5 Hz
0.22	Skip frequency 2	1.31	R/W	0 to 1000.0 Hz	0
0.23	Width of skip frequency 2	1.32	R/W	0 to 5.0 Hz	0.5 Hz
0.24	Selection of type of signal for analogue input 1	7.06	R/W	Volt, 0.20, 20.0, 4.20tr, 20.4tr, 4.20 lo, 20.4lo, 4.20Pr, 20.4Pr	Volt
0.25	Selection of type of signal for analogue input 2	7.11	R/W	Volt, 0.20, 20.0, 4.20tr, 20.4tr, 4.20 lo, 20.4lo, 4.20Pr, 20.4Pr	Volt
0.26	Destination of analogue input 2	7.14	R/W	0.00 to 20.50	1.37
0.27	Control logic polarity	8.27	R/W	0 or 1	0
0.28	Current loop proportional gain	4.13	R/W	0 to 30000	20
0.29	Current loop integral gain	4.14	R/W	0 to 30000	40
0.30	Enable keypad FWD/REV key	6.13	R/W	0 or 1	0

UMV 4301

Open or closed loop speed controller for asynchronous and synchronous motors



Parameter	Description	Address	Type	Adjustment range	Default setting
0.31	Selected preset configuration	11.37	RO	0 to 8	0
0.32	Type of communication	11.24	R/W	ANSI2, ANSI4, Output, Input	ANSI4
0.33	Controller rated current	11.32	RO	2.10 to 220.0	-
0.34	User security code	11.30	R/W	0 to 255	149
0.35	Reference via the keypad	1.17	R/W	0.01 to 0.02	0
0.36	Serial link transmission speed	11.25	R/W	4800, 9600, 19200 Bauds	4800 Bauds
0.37	Controller serial link address	11.23	R/W	0 to 9.9	1.1
0.38	Parameter displayed at power-up	11.22	R/W	0.00 to 0.50	0.10
0.39	Flying restart	6.09	R/W	0 or 1	0
0.40	Autotune	5.12	R/W	0 or 1	0
0.41	Switching frequency *	5.18	R/W	3 - 4.5 - 6 - 9 - 12 kHz	3 kHz
0.42	Number of motor poles	5.11	R/W	2 to 32 poles	4 poles
0.43	Power factor (cos φ)	5.10	R/W	0 to 1.000	0.92
0.44	Motor rated voltage	5.09	R/W	T : 0 to 480 V TL : 0 to 240V	T : 400V TL : 220V
0.45	Motor rated speed	5.08	R/W	0 to 6000.0 min ⁻¹	0
0.46	Motor rated current	5.07	R/W	0 to IN. CONTR.	IN. CONTROLLER
0.47	Motor rated frequency	5.06	R/W	0 to 1000.0 Hz	50.0 Hz
0.48	Controller operating mode	11.31	R/W	OPEN LP, CL. Vect., SERVO	OPEN LP
0.49	Security code access level		RO	-	1
0.50	Software version	11.29	RO	-	Depending on the software version of the product

* See the derating to be performed depending on the set frequency, section 1.3.2.

UMV 4301

Open or closed loop speed controller for asynchronous and synchronous motors

4.3.3 - Closed loop block diagram (and)

Symbols	
	Read and write
	Read only
	Read and assign

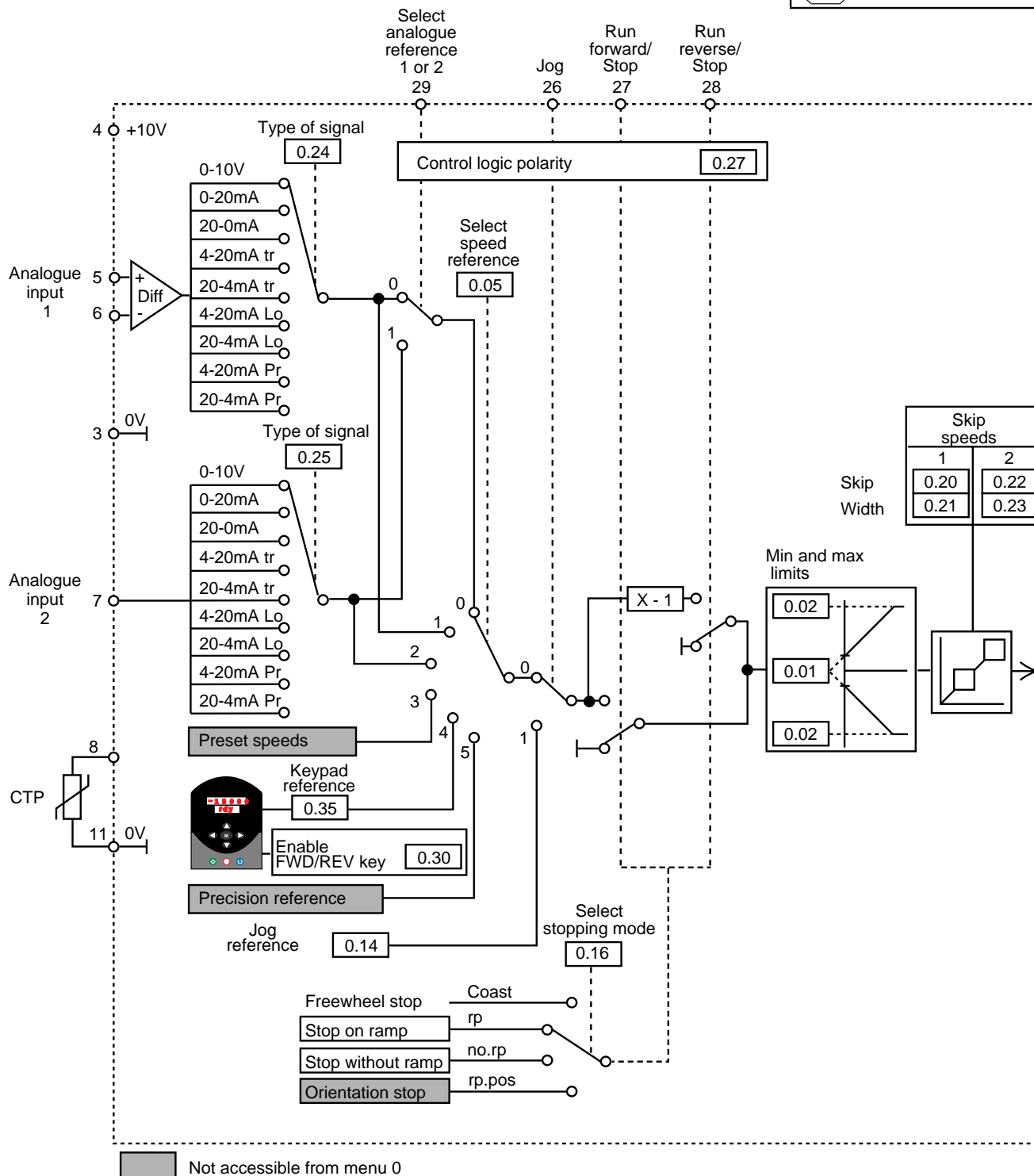

UMV 4301

Open or closed loop speed controller for asynchronous and synchronous motors



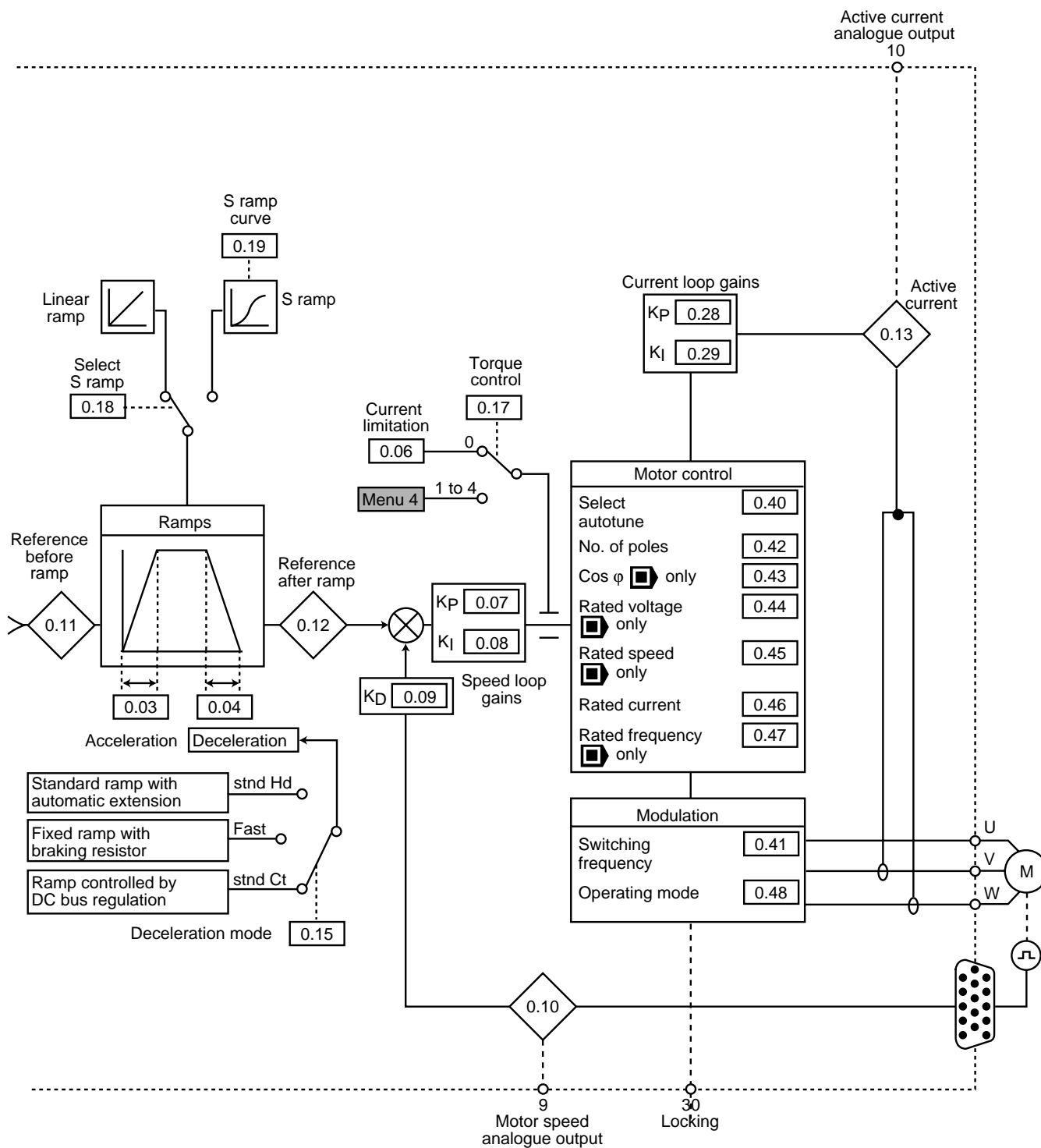















Symbols	
	Read and write
	Read only
	Read and assign



UMV 4301

















Open or closed loop speed controller for asynchronous and synchronous motors

4.3.4 - List of closed loop parameters (and)

Parameter	Description	Address	Type	Adjustment range	Default setting
0.00	Storage Default settings Selection of operating mode Code for access to other menus		R/W	0 to 9999	0
0.01	Minimum speed limit	1.07	R/W	0 to 0.02	0
0.02	Maximum speed limit	1.06	R/W	0 to 30000.0 min ⁻¹	 1500 min ⁻¹
					 3000 min ⁻¹
0.03	Acceleration ramp	2.11	R/W	 0 to 3200.0s/1000min ⁻¹	 2s
				 0 to 32.000s/1000min ⁻¹	 0.2s
0.04	Deceleration ramp	2.21	R/W	 0 to 3200.0s/1000min ⁻¹	 2s
				 0 to 32.000s/1000min ⁻¹	 0.2s
0.05	Selection of speed references	1.14	R/W	0 to 5	0
0.06	Current limitation	4.07	R/W	0 to 175%	 150 %
					 175 %
0.07	Speed loop proportional gain	3.10	R/W	0 to 32000	200
0.08	Speed loop integral gain	3.11	R/W	0 to 32000	100
0.09	Speed loop derivative gain	3.12	R/W	0 to 32000	0
0.10	Motor speed measurement	3.02	RO	± 30000 min ⁻¹	-
0.11	Speed reference before ramp	1.03	RO	± 30000 min ⁻¹	-
0.12	Speed reference after ramp	2.01	RO	± 30000 min ⁻¹	-
0.13	Measurement of motor active current	4.02	RO	± I max (A)	-
0.14	Jog reference	1.05	R/W	0 to 4000 min ⁻¹	50 min ⁻¹
0.15	Selection of deceleration mode	2.04	R/W	Stnd Hd, FAST, Stnd Ct	Stnd. Ct
0.16	Selection of stopping mode	6.01	R/W	Coast, rp, no rp, rp Pos	rp
0.17	Selection of torque control	4.11	R/W	0 to 4	0
0.18	Linear ramp/S ramp selection	2.06	R/W	0 or 1	0
0.19	S ramp curve	2.07	R/W	0 to 30.000s ² /1000 min ⁻¹	 1.5s ²
					 0.03s ²
0.20	Skip speed 1	1.29	R/W	0 to 30000 min ⁻¹	0
0.21	Width of skip speed 1	1.30	R/W	0 to 50 min ⁻¹	5 min ⁻¹
0.22	Skip speed 2	1.31	R/W	0 to 30000 min ⁻¹	0
0.23	Width of skip speed 2	1.32	R/W	0 to 50 min ⁻¹	5 min ⁻¹
0.24	Selection of type of signal for analogue input 1	7.06	R/W	Volt, 0-20, 20-0, 4-20tr, 20-4tr, 4-20lo, 20-4lo, 4-20Pr, 20-4Pr	Volt
0.25	Selection of type of signal for analogue input 2	7.11	R/W	Volt, 0-20, 20-0, 4-20tr, 20-4tr, 4-20lo, 20-4lo, 4-20Pr, 20-4Pr	Volt
0.26	Destination of analogue input 2	7.14	R/W	0.00 to 20.50	1.37
0.27	Control logic polarity	8.27	R/W	0 or 1	0
0.28	Current loop proportional gain	4.13	R/W	0 to 30000	 150
					 130
0.29	Current loop integral gain	4.14	R/W	0 to 30000	 2000
					 1200

UMV 4301

Open or closed loop speed controller for asynchronous and synchronous motors

0.30	Enable keypad FWD/REV key	6.13	R/W	0 or 1	0
0.31	Selected preset configuration	11.37	RO	0 to 8	0
0.32	Type of communication	11.24	R/W	ANSI2, ANSI4, Output, Input	ANSI4
0.33	Controller rated current	11.32	RO	2.10 to 220.0	-
0.34	User security code	11.30	R/W	0 to 255	149
0.35	Reference via the keypad	1.17	R/W	0.01 to 0.02	0
0.36	Transmission speed (serial link)	11.25	R/W	4800, 9600, 19200 Bauds	4800 Bauds
0.37	Controller serial link address	11.23	R/W	0 to 9.9	1.1
0.38	Parameter displayed at power-up	11.22	R/W	0.00 to 0.50	0.10
0.39	Flying restart	6.09	R/W	0 or 1	1
0.40	Autotune	5.12	R/W	0 or 1	0
0.41	Switching frequency *	5.18	R/W	3 - 4.5 - 6 - 9 - 12 kHz	3 kHz
0.42	Number of motor poles	5.11	R/W	2 to 32 poles	 4 poles
					 6 poles
0.43	Power factor (cos φ)	5.10	R/W	0 to 1.000	 0.92
					 1
0.44	Motor rated voltage	5.09	R/W	 T : 0 to 480 V TL : 0 to 240V	 T : 400 V TL : 220V
				 Not used	 0
0.45	Motor rated on-load speed	5.08	R/W	 0 to 30000 min ⁻¹	 1450 min ⁻¹
				 Not used	 0
0.46	Motor rated current	5.07	R/W	0 to IN.CONTR (A)	IN.CONTR (A)
0.47	Motor rated frequency	5.06	R/W	 0 to 1000.0 min ⁻¹	 50 Hz
				 Not used	 0
0.48	Controller operating mode	11.31	R/W	OPEN LP, CL Vect., SERVO	OPEN LP
0.49	Security code access level	-	RO	-	1
0.50	Software version	11.29	RO	-	Depending on the software version of the product



* See the derating to be performed depending on the set frequency, section 1.3.2.

UMV 4301

Open or closed loop speed controller for asynchronous and synchronous motors

4.3.5 - Description of the parameters in menu 0



Symbols :



- open loop mode 
- closed loop mode 
- servo mode 

0.00 : Parameter for storage, return to European and US default settings, modification of the operating mode.

- 149** : access to other menus,
- 1000** : storage,
- 1244** : return to US default settings,
- 1253** : selection of the operating mode and return to European default settings,
- 1255 (ou 1233)** : return to European default settings,
- 1254** : Selection of operating mode with return to US default settings,
- 2001 to 2008** : selection of a preset configuration.

0.01 : Minimum frequency or speed limit

Adjustment range :  : 0 to 0.02 Hz
 } 0 to 30000 min⁻¹

Default setting :  : 0
 } 0

This is the lowest operating frequency or speed. With the reference at the minimum, it is the output frequency or speed.

0.02 : Maximum frequency or speed limit



Adjustment range :  : 0 to 1000.0 Hz
 } 0 to 30000 min⁻¹

Default setting :  : 50 Hz
 : 1500 min⁻¹

This is the highest operating frequency or speed. With the reference at the maximum, it is the output frequency or speed.

0.03 : Acceleration ramp

Adjustment range :  : 0 to 3200.0s/100Hz
 : 0 to 3200.0s/1000 min⁻¹



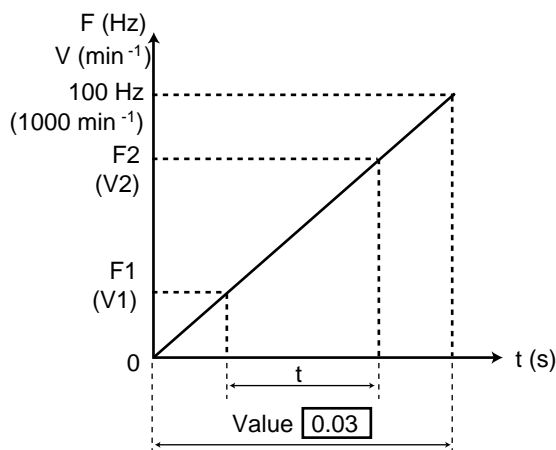

Default setting :  : 5.0 s
 : 2s

Adjustment of the time to accelerate from 0 to 100 Hz or from 0 to 1000 min⁻¹.

$$\begin{aligned} \text{Value of } 0.03 \text{ (s)} &= \frac{t(s) \times 100 \text{ Hz}}{(F2-F1) \text{ Hz}} \\ \text{Value of } 0.03 \text{ (s)} &= \frac{t(s) \times 1000 \text{ min}^{-1}}{(V2-V1) \text{ min}^{-1}} \end{aligned}$$



0.04 : Deceleration ramp

Adjustment range :  : 0 to 3200.0s/100Hz
 : 0 to 3200.0s/1000 min⁻¹

Default setting :  : 10.0 s
 : 2s

Adjustment of the time to decelerate from 100 Hz to 0 or from 1000 min⁻¹ to 0.

$$\begin{aligned} \text{Value of } 0.04 \text{ (s)} &= \frac{t(s) \times 100 \text{ Hz}}{(F2-F1) \text{ Hz}} \\ \text{Value of } 0.04 \text{ (s)} &= \frac{t(s) \times 1000 \text{ min}^{-1}}{(V2-V1) \text{ min}^{-1}} \end{aligned}$$

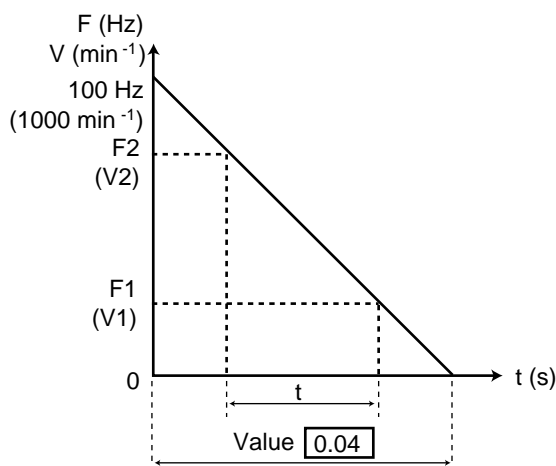

UMV 4301

Open or closed loop speed controller for asynchronous and synchronous motors

0.05 : Selection of frequency or speed reference

Adjustment range : 0 to 5
Default setting : 0

To choose the speed reference.

0 : selection of analogue reference 1 or analogue reference 2 via terminal 29.

1 : analogue reference 1 - differential input (terminals 5 and 6).

2 : analogue reference 2 - common mode input (terminals 7 and 11).



3 : preset speeds (not available with menu 0).

4 : speed reference via keypad.

5 : precision speed reference (not available with menu 0).

0.06 : Current limitation in motor and generator modes



Adjustment range :  : 0 to 150 % In controller

 }
 } 0 to 175 % In controller

Default setting :  }
 } 150 % of In motor

 : 175 % of In motor

Sets the maximum current supplied by the controller in motor and generator operating modes.

The output frequency () or the speed ( and ) are limited in order to keep the active current below or equal to the limit set by 0.06.

0.07

: Selection of the control mode

Adjustment range : 0 to 3

Default setting : 1

Modes 0 to 2 are used for vector control. Mode 3 corresponds to V/F control with a fixed boost (0.08).

The difference between modes 0 to 2 is the method used to identify the motor parameters, in particular the stator resistance. These parameters vary with the motor temperature and thus according to the motor operating cycle.

0 : Ur S mode : the stator resistance and the voltage offset are measured each time the controller is enabled. Parameters 5.17 (stator resistance) and 5.23 (voltage offset) are read-only.

These measurements are only valid if the machine is stationary, with totally reduced flux. The measurement is only taken when the run command is given less than 2 seconds after the previous stop.

This is the highest performance vector control mode. However, the operating cycle must be compatible with the 2 seconds required between a stop command and a new run command.

1 : Ur I mode : the stator resistance (5.17) and the voltage offset (5.23) are only measured each time the controller is powered up. 5.17 and 5.23 are read-only.

These measurements are only valid if the machine is stationary when it is powered down.

 • In mode 1 (Ur1), at power-up, a voltage is applied briefly to the motor without a run command being given. For safety reasons no electrical circuit should be accessible once the controller is powered up.

2 : Ur mode : neither the stator resistance (5.17) nor the voltage offset (5.23) is measured.

This mode offers the lowest the performance level. It is only used when the 2 preceding modes are not compatible with the operating cycle.

If this is the case, at start-up, Ur S or Ur I mode is used to store the values of 5.17 and 5.23 and then Ur mode is used for normal operation.

3 : Fd mode : fixed voltage boost that can be adjusted by parameter 0.08.

and : Speed loop proportional gain

Adjustment range : 0 to 32000

Default setting : 200

Adjusts the stability of the motor speed when there are sudden variations in the reference.

Increase the proportional gain until vibration occurs in the motor, then reduce the value by 20 to 30 %, checking that the stability of the motor is satisfactory when there are sudden variations in the speed reference, at no load as well as on-load.

UMV 4301

Open or closed loop speed controller for asynchronous and synchronous motors

0.08

0.08 : Starting torque (Boost)

Adjustment range : 0 to 25.0 % of Un motor (0.44)

Default setting : 3 % Un motor

For operation in V/F mode, (0.07 at 3:Fd) parameter 0.08 is used to overflux the motor at low speed so that it will supply more torque at start-up. This is a percentage of the motor rated voltage (0.44).

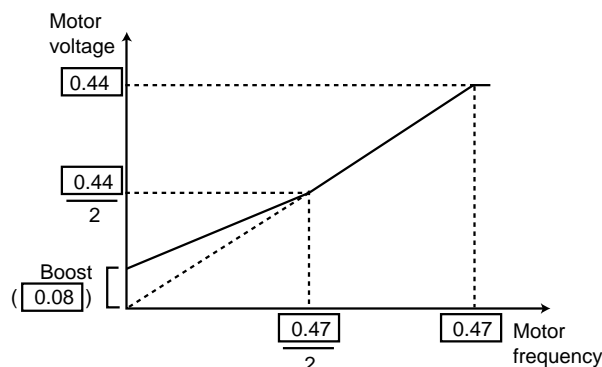

0.09 and 0.10 : Speed loop integral gain

Adjustment range : 0 to 32000

Default setting : 100

Sets the stability of the motor speed for a load impact.

Increase the integral gain to obtain the same speed on-load as at no load for a load impact.

0.09

0.09 : Selection of dynamic V/F mode

Adjustment range : 0 to 1

Default setting : 0

0 : the V/F ratio is set and adjusted by the basic frequency (0.47).

1 : dynamic V/F ratio.

Generates a voltage/frequency characteristic which varies with the load. It is used in quadratic torque applications (pumps/fans/compressors). It can be used in low dynamic constant torque applications to reduce motor noise.

0.11 and 0.12 : Speed loop derivative gain

Adjustment range : 0 to 32000

Default setting : 0

Sets the stability of the motor speed in the event of fast variations in the reference or load shedding. Reduces speed overshoots.

In general, the setting should be left at 0.

0.10 : Measurement of the motor speed

Adjustment range : 0 : ± 6000 min⁻¹

1 } ± 30000 min⁻¹
2 }

0 : The motor speed is calculated from the frequency reference after the ramp (in Hz as it is open loop operation) or from the final frequency reference when operating in frequency control (reference signal on the encoder input : 3.13 = 1).

$$0.10 \text{ (min}^{-1}\text{)} = \frac{60 \times \text{frequency}}{\text{number of pairs of motor poles}}$$

$$0.10 \text{ (min}^{-1}\text{)} = \frac{60 \times 0.12 \text{ (Hz)}}{(0.42/2)} \text{ if } 3.13 = 0$$

$$\text{or} = \frac{60 \times 3.01 \text{ (Hz)}}{(0.42/2)} \text{ if } 3.13 = 1$$

In the first case, the precision depends on the quality of the slip compensation setting.

In the second case, there will be error due to the slip.

0.11 and 0.12 : This parameter is used to read the actual speed coming either from the motor encoder, or the RLV UMV option when a resolver is used for speed feedback. In the latter case, the selection is automatic.

0.11 : Frequency or speed reference before ramp

Adjustment range : 0 : ± 1000.0 Hz

1 } ± 30000 min⁻¹
2 }

Measurement of the frequency (0.11) or speed (0.12, 0.13) reference, after the skips and before the ramp. Used for diagnostics.

0.12 : Frequency or speed reference after ramp

Adjustment range : 0 : ± 1000.0Hz

1 } ± 30000min⁻¹
2 }

By incrementing in 0.1Hz or min⁻¹ measures the reference after the ramps. Used for diagnostics.

0.13 : Measurement of the motor active current

Adjustment range : 0 : ± I max contr.

Reads the active current supplied by the controller. The active current gives a fairly precise image of the motor torque between 5 Hz and 50 Hz (0.11) and between 0 min⁻¹ and the rated speed of the motor (0.12 and 0.13).

UMV 4301

Open or closed loop speed controller for asynchronous and synchronous motors

0.14 : Jog reference

Adjustment range : : 0 to 400.0 Hz
 }
 } 0 to 4000.0 min⁻¹
 Default setting : : 1.5 Hz
 }
 } 50 min⁻¹

This is the operating frequency or speed when the jog input (terminal 26) is selected, with a Forward or Reverse run command.

WARNING :

- Close the jog select contact (terminal 26) before closing the Forward or Reverse run contact (terminal 27 or 28).
- The jog reference is not limited by 0.01 Minimum speed limit.

0.15 : Selection of deceleration mode

Adjustment range : 0 to 2
 Default setting : 2

- 0 : Stnd Hd - standard deceleration ramp with time extension to avoid overvoltage tripping of the DC bus.
- 1 : FAST - deceleration in keeping with the time up to the current limit. With a driving load, a braking resistor option is necessary.
- 2 : Stnd Ct - deceleration ramp with control of the voltage of the DC bus. Suitable for lightly loaded machines and provides better flexibility than the stnd.Hd setting.

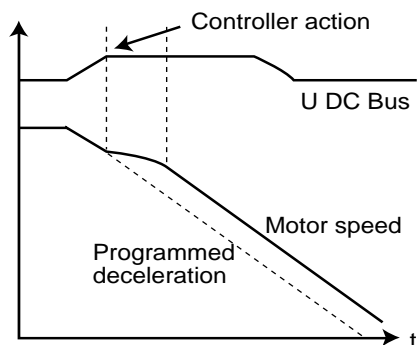

WARNING :

If a braking resistor is connected to the controller, 0.15 must be set to "FAST".

0.16 : Selection of the stopping mode

Adjustment range :

:

Setting	Display	Function
0	COAST	Freewheel stop
1	rp	Stop on deceleration ramp
2	rp. dcL	Deceleration ramp + DC injection for 1s
3	dcL	Stop by DC injection braking and elimination at zero speed
4	td. dcL	Stop by DC injection (fixed time)

}
 } :

Setting	Display	Function
0	COAST	Freewheel stop
1	rp	Stop on deceleration ramp
2	no - rp	Stop without ramp
3	rp - Pos	Orientation stop (indexing)

Default setting : 1 (rp)

0 (COAST) : freewheel stop

The power bridge is deactivated as soon as there is a stop command.

The controller cannot receive a new run command for 2s, which is the motor demagnetising time.

The display shows rdY 2s after the run command. The stopping time of the machine depends on its inertia.

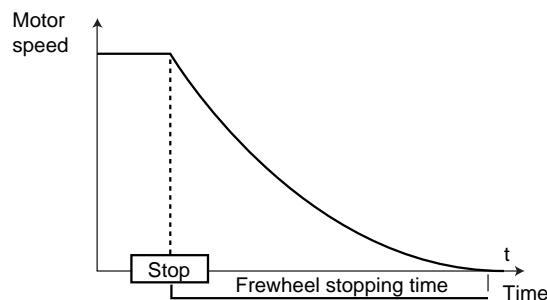

1 (rp) : stop on deceleration ramp

The controller decelerates the motor according to the deceleration mode selected in parameter 0.15. One second after stopping, the display indicates rdY.

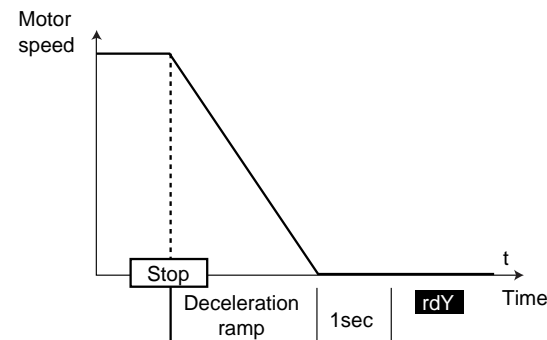

UMV 4301

Open or closed loop speed controller for asynchronous and synchronous motors

2 (rp.dcl) : stop on deceleration ramp with DC injection for 1s

The controller decelerates the motor according to the deceleration mode selected in parameter 0.15.

On stopping, the controller injects direct current into the motor with an amplitude of :

$$150 \times \frac{I_{n \text{ controller}}}{I_{n \text{ motor}}}$$

for 1 second. The controller then displays rdY.

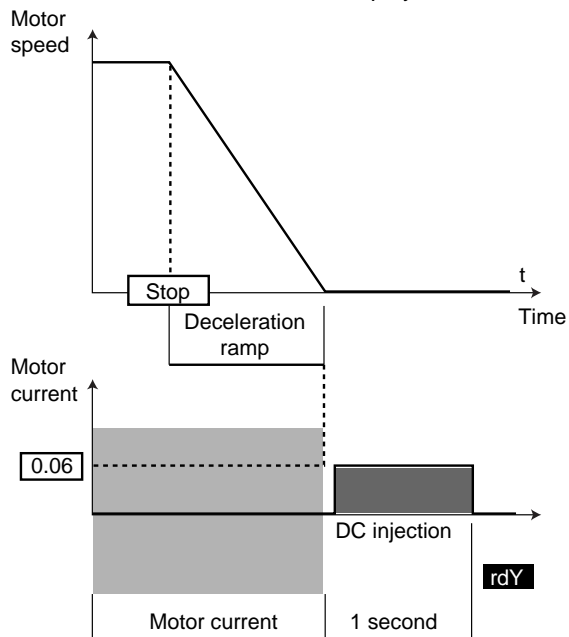

2 (no.rp) : stop without ramp

The controller stops the motor with the current limit set by 0.06.

When the motor stops, the display indicates rdY.

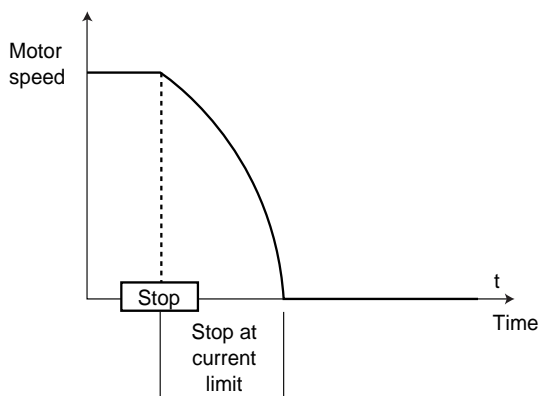

3 (dcl) : stop by DC injection braking, and elimination at zero speed

The controller decelerates the motor by applying a current defined as follows :

$$150 \times \frac{I_{n \text{ controller}}}{I_{n \text{ motor}}}$$

until a low speed is reached, then injects direct current into the motor until it stops, and eliminates the direct current automatically as soon as the motor stops. The controller then displays rdY. No run command can be taken into account until rdY is displayed.

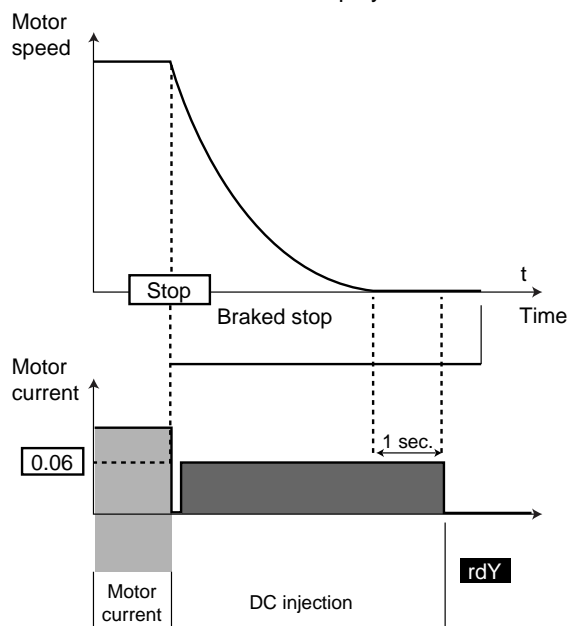

3 (rp.POS) : orientation stop (indexing)

The controller stops the motor with the current limit as defined in 0.06. The motor is stopped when the shaft is in the required position.

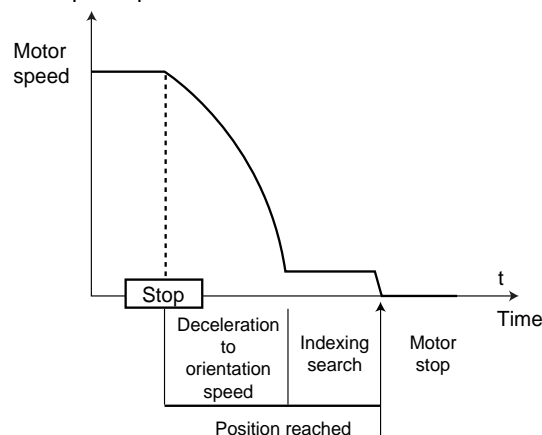

WARNING :

The parameters for the position cannot be accessed in menu 0. Refer to menu 13 in the "Parameter setting and diagrams" manual ref. 2465.

UMV 4301

Open or closed loop speed controller for asynchronous and synchronous motors

4 (td.dcl) : DC injection stop with fixed time
The controller decelerates the motor by applying a current defined as follows :

$$150 \times \frac{\text{In controller}}{\text{In motor}}$$

for 5 seconds, then injects direct current into the motor until it stops. The controller then displays rdY. No run command can be taken into account until rdY is displayed.

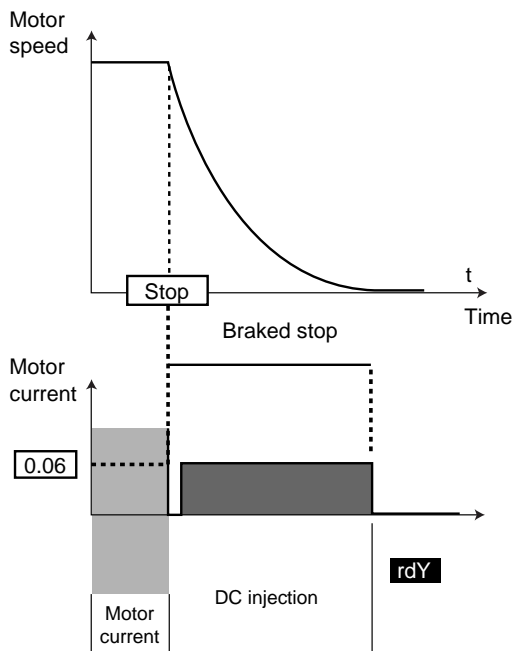

0.17 : Selection of torque control

Adjustment range : 0 to 1
Default setting : 0

0 : frequency control with current limitation by parameter 0.06.

1 : torque control. The frequency reference is no longer active and the torque reference can be given by analogue reference 2 (if it is programmed for the torque reference, parameter 4.08). The output frequency is set so that the active current measured by the controller is equal to the reference. With zero resistive torque the motor reaches overspeed, with tripping when the threshold set in 3.08 is reached.

0.18 and **0.19** :

Adjustment range : 0 to 4
Default setting : 0

0 : speed control with current limitation by parameter 0.06.

1 : torque control. The speed reference is no longer active and the torque reference can be given by analogue reference 2 (if it is programmed for the torque reference, parameter 4.08). The output speed is set so that the active current measured by the controller is equal to the reference.

With zero resistive torque the motor reaches overspeed, with tripping when the threshold set in 3.08 is reached.

2 : torque control with speed limitation. The torque reference can be given by analogue reference 2 (if it is programmed for the torque reference, parameter 4.08) with speed limitation by analogue reference 1.

3 : torque control for simple winder/unwinder applications (see manual ref. 2465).

4 : reserved.

! In torque control without speed control (0.17 = 1) the machine races if the resistive torque becomes zero. It is therefore essential to set a maximum speed threshold in parameter 3.08.

0.18 : Enable S ramp

Adjustment range : 0 to 1

Default setting : 0

0 : the ramp is linear.

1 : a curve (defined in 0.19) at the start and the end of the ramp prevents swinging of the loads.

WARNING :

The S ramp is deactivated during controlled deceleration (0.15 = Std.Ct).

0.19 : S ramp curve

Adjustment range : **0** : 0 to 3000.0s²/100Hz

1 } 0 to 30.000s²/1000min⁻¹
2 }

Default setting : **0** : 3.1s²

1 : 1.5s²

2 : 0.03s²

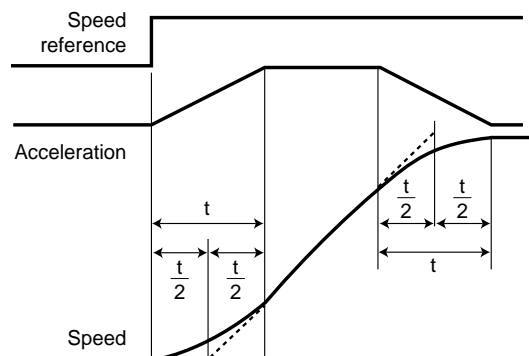

$$t = \boxed{0.19} + \boxed{0.03} \text{ for acceleration,}$$

$$t = \boxed{0.19} + \boxed{0.04} \text{ for deceleration.}$$

The value of 0.19 determines the maximum acceleration and deceleration slope, from the beginning to the end of the speed change. Compared with a linear ramp, the S ramp increases the total value of t (t/2 at the start and end of the linear ramp).

UMV 4301

Open or closed loop speed controller for asynchronous and synchronous motors

0.20 : Frequency or speed skip 1

0.22 : Frequency or speed skip 2

Adjustment range : : 0 to 1000.0 Hz

} 0 to 30000 min⁻¹

Default setting : : 0

} 0

Whatever the reference, this prevents operation at one of two critical frequencies () or speeds (and). Prevents the risks of mechanical resonance.

0.21 : Width of frequency or speed skip 1

0.23 : Width of frequency or speed skip 2

Adjustment range : : 0 to 5.0 Hz

} 0 to 50 min⁻¹

Default setting : : 0.5 Hz

} 5 min⁻¹

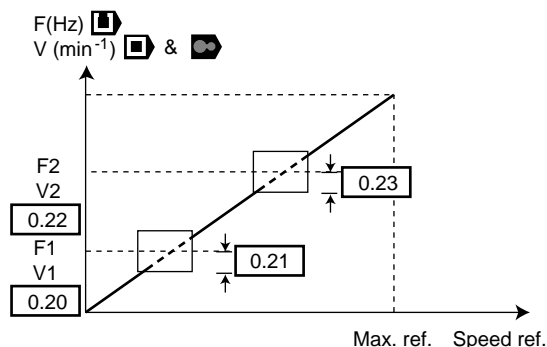

0.24 : Selection of type of signal on analogue input 1

0.25 : Selection of type of signal on analogue input 2

Adjustment range : See table

Default setting : VoLt

Analogiques speed reference inputs 1 and 2 can be configured differently according to the table below.

0	VOLt	Voltage input ± 10V
1	0-20	0-20mA
2	20-0	20-0mA
3	4-20.tr	4-20mA (trip if signal lost)
4	20-4.tr	20-4mA (trip if signal lost)
5	4-20.Lo	4-20mA (min. speed if signal lost)
6	20-4.Lo	20-4mA (min. speed if signal lost)
7	4-20.Pr	4-20mA (speed before trip if signal lost)
8	20-4.Pr	20-4mA (speed before trip if signal lost)

Note : For the 4-20 mA and 20-4 mA modes the signal loss threshold is 3 mA.

0.26 : Destination of analogue input 2

Adjustment range : } 0.00 to 20.50

Default setting : } 1.37

Enables analogue input 2 (terminal 7) to be used for something other than a speed reference.

Example : For torque control, set 4.08 in 0.26.

0.27 : Control logic polarity

Adjustment range : 0 or 1

Default setting : 0

This parameter is used to choose positive or negative control logic.

0 : negative logic : the input is activated when the terminal is at a low level (< 5V).

1 : positive logic : the input is activated when the terminal is at a high level (> 15V).



UMV 4301

Open or closed loop speed controller for asynchronous and synchronous motors

0.28 : Current loop proportional gain

0.29 : Current loop integral gain

Adjustment range : 0 to 30000

Default setting :	0.28	0.29
	20	40
	150	2000
	130	1200

In view of a number of factors internal to the controller, oscillations may occur in the following cases :

- Frequency regulation with current limitation around rated frequency and on load impacts.
- Torque regulation on lightly loaded machines and around rated speed.

- At a mains break or on controlled deceleration ramp when DC bus regulation is required.

To decrease these oscillations, it is advisable to perform the following operations, in the order given :

- increase the proportional gain **0.28**,
- decrease the integral gain **0.29**.

0.30 : Enable keypad FWD/REV key

Adjustment range : 0 or 1

Default setting : 0

This parameter enables the Forward/Reverse key on the keypad.

0 : FWD/REV key disabled.

1 : FWD/REV key enabled.

0.31 : Selected preset configuration

Adjustment range : 0 to 8

Default setting : 0

Displays the selected preset configuration.

0 : default setting

1 : simplified local/remote operation

2 : faster / slower control

3 : preset speeds

4 : torque control

5 : PID control

6 : axis control

7 : brake control

8 : electrical shaft

0.32 : Type of communication

Adjustment range : 0 to 3

Default setting : 1

This is the serial port operating mode.

0. ANSi2 : 2-wire half duplex serial link

1. ANSi4 : 4-wire half duplex serial link

2. OUPtU : output variable defined by **11.27** (CT protocol).

3. INPUt : input variable defined by **11.27** (CT protocol).

Modes 2 and 3 are used to transfer a variable from one controller to another.

Mode 2 :

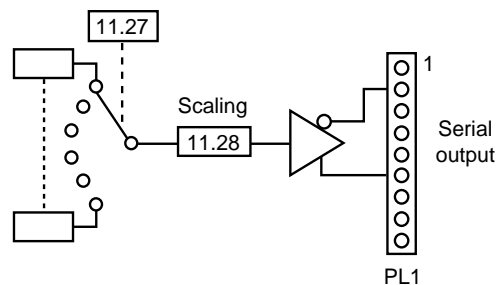

When the controller trips, the value 0 is transmitted.

Mode 3 :

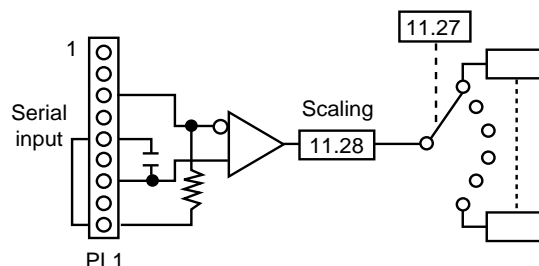

Once the data has been transmitted, a serial link fault will occur if there is a loss of line or if the last data item transmitted is other than 0.

0.33 : Controller rated current

Adjustment range : 2.10 to 220.0 A

This parameter indicates the rated current for continuous controller operation.

0.34 : User security code

Adjustment range : 0 to 255

Default setting : 149

This parameter enables a personal security code to be entered, which provides a lock against changing the parameters. The personal security code can only be read when it is being edited. In all other cases, code 149 is displayed.

Do not use code 0.



To access the parameters, enter the personal code selected in parameter **0.00**.

UMV 4301



Open or closed loop speed controller for asynchronous and synchronous motors

0.35 : Reference via the keypad

Adjustment range :  : 0.01 to 0.02 Hz

 }
 } 0.01 to 0.02 min⁻¹

Default setting : 0

This parameter is used to change the reference when setting via the keypad is selected (0.05 = 4). The  key is used to increase the reference and the  key to decrease it.

The value of the reference is stored when there is a power cut so that it is automatically reinitialised when the power returns.



0.36 : Serial link transmission speed

Adjustment range :  } 4800 Bauds or
 } 9600 Bauds or
 } 19200 Bauds

Default setting : 4800 Bauds

Used for ANSI communication to select the data transfer speed.

0.37 : Controller serial link address

Adjustment range :  }
 } 0 to 9.9
 }

Default setting : 1.1

Used for ANSI communication to define the address of the controller. Values containing a zero should be avoided as these are used for addressing groups of controllers.

This parameter is only effective when a COM1 UMV or CAP UMV option module is installed.

0.38 : Parameter displayed on power-up



Adjustment range :  }
 } 0.00 to 0.50
 }

Default setting : 0.10

Determines the parameter which will be displayed when the controller is powered up.

0.10 correspond to the motor speed.

0.39 : Enable flying restart

Adjustment range :  }
 } 0 or 1

Default setting :  : 0

 }
 } 1



If this parameter is enabled and 0.07 (Selection of the control mode) is set to 3, when a run command is given or after a power cut, the controller executes a procedure to calculate the frequency and direction of rotation of the motor. It automatically resets the output frequency to the measured value and reaccelerates the motor up to the reference frequency.



This is performed in closed loop mode by synchronising the ramp output with the actual rotation speed of the motor when the controller receives the start command.

0 : flying restart disabled.

1 : flying restart enabled.



In open loop mode, if the load is stationary when the run command is given or the mains supply reappears, this operation may cause the machine to rotate in both directions before the acceleration of the motor.

- Before enabling this function check that there is no danger to machinery and personnel.

- Do not enable the flying restart if the drive controls more than 1 motor.

0.40 : Autotune

Adjustment range : 0 or 1

Default setting : 0

1 : when started up for the first time, is used to measure the motor characteristics (magnetizing current, cos φ, leakage inductance, etc).

This operation must be performed with the motor uncoupled. The controller drives the motor at 2/3 its rated speed then stops.

In servo mode, the motor performs one complete revolution then stops.



During the autotune phase, the controller supplies the motor, causing it to rotate. Check that this operation does not affect safety.

- Autotune should be performed each time the operating mode is modified.

- Use the  reset key to stop the autotune at any time (the motor coasts to stop).

- In  mode and with a special motor, during the autotune the drive could reach the current limits and could trip " OI.AC ". To solve this problem, reduce the boost with parameter 0.08, and perform the autotune again.

UMV 4301

Open or closed loop speed controller for asynchronous and synchronous motors

0.41 : Switching frequency

Adjustment range : } 3 - 4.5 - 6 - 9 - 12 kHz

Default setting : 3 kHz

0.41 sets the PWM switching frequency and the sampling frequency of the digital and analogue inputs according to the following table :

Setting kHz	Sampling frequency	
	Condition A kHz	Condition B kHz
3	3	3
4.5	4.5	2.2
6	6	3
9	4.5	2.25
12	6	3

Sampling frequency of the digital and analogue inputs

• Condition A :

- open loop operation with frequency control,
- closed loop operation with torque control.

• Condition B :

- open loop operation with control of the analogue inputs by current signal,
- closed loop operation with speed control.

WARNING :

- It is necessary to derate the output current as a function of the switching frequency and the rating of the UMV 4301. See the table in section 1.3.2.
- A high switching frequency reduces the magnetic noise, however it increases the motor temperature rise and the level of emission of radio frequency interference and reduces the starting torque.
- When a switching frequency is set to 6, 9 or 12 kHz, and when the IGBT junction temperature has reached an alarm threshold, the switching frequency is automatically divided by 2 (0.41 remains to the set value). The drive returns to the set value as soon as the IGBT temperature has decreased below the alarm threshold.

0.42 : Motor polarity

Adjustment range : 2 to 32 poles

Default setting : } 4 poles
 : 6 poles

Motor rated speed (min ⁻¹)	Number of motor poles
3000	2
1500	4
1000	6
750	8

0.43 : Power factor (cos φ)

Adjustment range : } 0 to 1.000

Default setting : } 0.92
 : 1

The cos φ is measured automatically during the autotune phase and set in this parameter. If the autotune procedure has not been performed, enter the cos φ value from the motor nameplate.

Set 1 for Servo mode.

0.44 : Motor rated voltage

Adjustment range : } T : 0 to 480V
 } TL : 0 to 240V
 : not used

Default setting : } T : 400V
 } TL : 220V
 : 0

:
 Is used to define the voltage/frequency characteristic as follows :

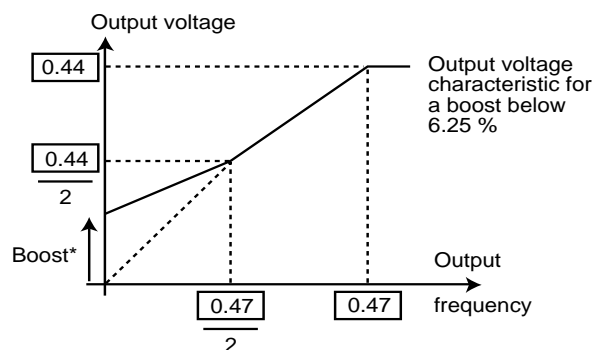

* If fixed boost is selected (0.44 = 3).

In open loop vector control mode (0.44 = 0.1 or 2) or closed loop mode, the motor rated voltage controls the flux in the motor.

Not used in servo mode.

UMV 4301

Open or closed loop speed controller for asynchronous and synchronous motors

0.45 : Motor rated speed

Adjustment range :  : 0 to 6000.0 min⁻¹
 : 0 to 30000 min⁻¹
 : not used

Default setting :  : 0
 : 1450 min⁻¹

This is the on-load motor speed given on the nameplate.

0.46 : Motor rated current

Adjustment range :  } 0 to In controller
 }

Default setting : In controller



This is the rated motor current value given on the nameplate. Overload starts from this value.

In Servo mode, the setting of 0.46 is the stall current, given on the motor nameplate.

WARNING :

At 50°C ambient temperature, check the setting of 0.46 which must not exceed the value of the table shown in § 1.3.2.

0.47 : Motor rated frequency

Adjustment range :  } 0 to 1000.0 Hz
 }
 : 0

Default setting :  } 50 Hz
 }
 : 0

This is the point where the motor operation changes from constant torque to constant power.

In standard operation, it is the frequency given on the motor nameplate.

Not used in servo mode.

0.48 : Selection of operating mode

Adjustment range : 0 to 2

Default setting : 0

0 : open loop vector control mode or V/F mode operation.

1 : closed loop vector control mode with encoder.

2 : servo mode with synchronous motor.

- This parameter is used to select the control mode.
- The control mode can only be modified after code 1253 has been entered in parameter 00 of any menu (xx.00).
- The default settings are automatically adjusted according to the selected control mode.
- A procedure to return to default settings does not modify the control mode.
- The control mode can only be selected when the controller is stopped.

0.49 : Security code access level

Default setting : 1

Parameter 0.49 consists of 3 digits and determines the level of protection of the parameters.

X	X	X
Code customized via 0.34 0 : no 1 : yes	Customized code active. Parameters cannot be modified 0 : no 1 : yes	Access to the other menus via 149 0 : no 1 : yes

0.50 : Software version 1

Adjustment range : 1.00 to 9.99.

Gives the first two numbers of the software version installed in the controller.

UMV 4301

Open or closed loop speed controller for asynchronous and synchronous motors

4.4 - Other preset configurations

4.4.1 - Introduction

In most cases the factory configuration of the UMV 4301 controller provides the operation required by the installation. However, in order to assist with setting the parameters of the controller in the event of special operation, eight configurations have been preset and may be selected by setting parameter 0.00 to 200X and performing a Reset (X being the number of the chosen configuration).

In this case, the controller adapts automatically to the selected configuration by adapting the remote control terminal block, changing the default setting of certain parameters and adding the special parameters to menu 0.

There is therefore a connection diagram and a menu 0 for each configuration.

Parameters 0.01 to 0.10 and 0.31 to 0.50 are common to all configurations.

Only parameters 0.11 to 0.30 depend on the selection made.

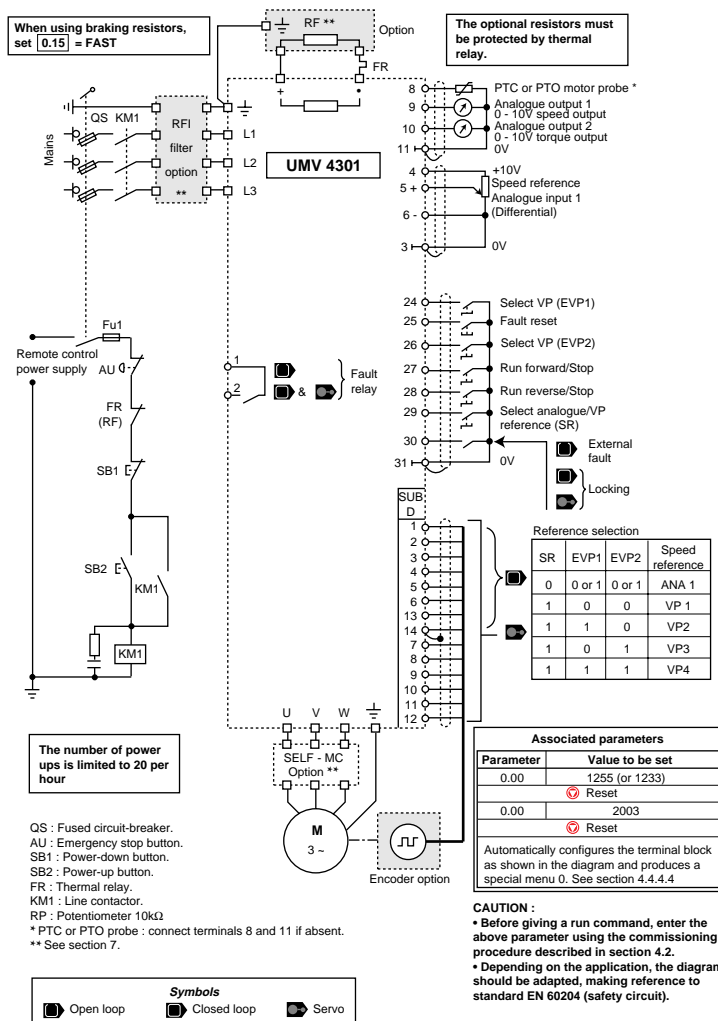

Parameter	Descrp.	Address	Type	Adjustment range	Default setting
0.01 to 0.10	Parameters common to all configurations				

Parameter	Descrp.	Address	Type	Adjustment range	Default setting
0.11 to 0.30	Parameters specific to the selected configuration				

Parameter	Descrp.	Address	Type	Adjustment range	Default setting
0.31 to 0.50	Parameters common to all configurations				

! Before enabling a preset configuration, make sure the drive is stopped.

UMV 4301

Open or closed loop speed controller for asynchronous and synchronous motors

4.4.2 - Preset configuration 1 : Simplified local/remote operation

4.4.2.1 - Introduction

This configuration provides very simplified operation of the controller. It provides :

- V/F ratio operation which avoids the use of autotune procedures and the measurement of stator resistance,
- the disabling of the PTC input in cases where they are not connected,
- the provision of a 4-20mA analogue input on terminal 7 of the control terminal block,
- the simplification of menu 0.

4.4.2.2 - Default settings automatically modified

Parameter	Default setting with configuration 1	Comment
0.07	3 (Fd)	V/F ratio
7.11	5 (4-20mA Lo)	4-20mA analogue input on terminal 7 instead of 0-10V
7.15	Volt (0-10V)	0-10V analogue input on terminal 8 instead of PTC

4.4.2.3 - Connection diagram

See diagram in section 3.7.4.

4.4.2.4 - Menu 0 of configuration 1 ()





























Parameter	Description	Address	Type	Adjustment range	Default setting
0.01	Minimum speed limit	1.07	R/W	0 to 0.02	0
0.02	Maximum speed limit	1.06	R/W	0 to 1000.0 Hz	50 Hz
0.03	Acceleration ramp	2.11	R/W	0 to 3200.0s/100Hz	5.0s
0.04	Deceleration ramp	2.21	R/W	0 to 3200.0 s/100 Hz	10.0 s
0.05	Selection of frequency references	1.14	R/W	0 to 5	0
0.06	Current limitation	4.07	R/W	0 to 150%	150%
0.07	Control mode	5.14	R/W	Urs, Ur1, Ur, Fd	Fd
0.08	Starting torque (Boost)	5.15	R/W	0 to 25 %	3 %
0.09	Selection of dynamic V/F mode	5.13	R/W	0 or 1	0
0.10	Measurement of motor speed	5.04	RO	$\pm 6000 \text{ min}^{-1}$	-
0.31	Selected preset configuration	11.37	RO	0 to 8	1
0.32	Type of communication	11.24	R/W	ANSI2, ANSI4, Output, Input	ANSI4
0.33	Controller rated current	11.32	RO	2.10 to 220.0	-
0.34	User security code	11.30	R/W	0 to 255	149
0.35	Reference via keypad	1.17	R/W	0.01 to 0.02	0
0.36	Serial link transmission speed	11.25	R/W	4800, 9600, 19200 Bauds	4800 Bauds
0.37	Controller serial link address	11.23	R/W	0 to 9.9	1.1
0.38	Parameter displayed on power-up	11.22	R/W	0.00 to 0.50	0.10
0.39	Flying restart	6.09	R/W	0 or 1	0
0.40	Autotune	5.12	R/W	0 or 1	0
0.41	Switching frequency *	5.18	R/W	3 - 4.5 - 6 - 9 - 12 kHz	3 kHz
0.42	Number of motor poles	5.11	R/W	2 to 32 poles	4 poles
0.43	Powr factor (cos φ)	5.10	R/W	0 to 1.000	0.92
0.44	Motor rated voltage	5.09	R/W	T : 0 to 480 V TL : 0 to 240V	T : 400 V TL : 220V
0.45	Motor rated speed	5.08	R/W	0 to 6000.0 min^{-1}	0
0.46	Motor rated current	5.07	R/W	0 to IN. CONTR.	IN. CONTROLLER
0.47	Motor rated frequency	5.06	R/W	0 to 1000.0 Hz	50.0 Hz
0.48	Controller operating mode	11.31	R/W	OPEN LP, CL. Vect., SERVO	OPEN LP
0.49	Security code access level		RO	-	1
0.50	Software version	11.29	RO	-	Software version

* See the derating to be performed according to the set frequency, in section 1.3.2.

UMV 4301

Open or closed loop speed controller for asynchronous and synchronous motors

4.4.2.5 - Menu 0 of configuration 1 (and)

Parameter	Description	Address	Type	Adjustment range	Default setting
0.01	Minimum speed limit	1.07	R/W	0 to 0.02	0
0.02	Maximum speed limit	1.06	R/W	0 to 30000.0 min ⁻¹	 1500 min ⁻¹  3000 min ⁻¹
0.03	Acceleration ramp	2.11	R/W	 0 to 3200.0s/1000min ⁻¹	 2s
				 0 to 32.000s/1000min ⁻¹	 0.2s
0.04	Deceleration ramp	2.21	R/W	 0 to 3200.0s/1000min ⁻¹	 2s
				 0 to 32.000s/1000min ⁻¹	 0.2s
0.05	Selection of speed references	1.14	R/W	0 to 5	0
0.06	Current limitation	4.07	R/W	0 to 175%	 150 %
					 175 %
0.07	Speed loop proportional gain	3.10	R/W	0 to 32000	200
0.08	Speed loop integral gain	3.11	R/W	0 to 32000	100
0.09	Speed loop derivative gain	3.12	R/W	0 to 32000	0
0.10	Measurement of motor speed	3.02	RO	± 30000 min ⁻¹	-
0.31	Selected preset configuration	11.37	RO	0 to 8	1
0.32	Type of communication	11.24	R/W	ANSI2, ANSI4, Output, Input	ANSI4
0.33	Controller rated current	11.32	RO	2.10 to 220.0	-
0.34	User security code	11.30	R/W	0 to 255	149
0.35	Reference via the keypad	1.17	R/W	0.01 to 0.02	0
0.36	Transmission speed (serial link)	11.25	R/W	4800, 9600, 19200 Bauds	4800 Bauds
0.37	Controller serial link address	11.23	R/W	0 to 9.9	1,1
0.38	Parameter displayed on power-up	11.22	R/W	0.00 to 0.50	0.10
0.39	Flying restart	6.09	R/W	0 or 1	1
0.40	Autotune	5.12	R/W	0 or 1	0
0.41	Switching frequency *	5.18	R/W	3 - 4.5 - 6 - 9 - 12 kHz	3 kHz
0.42	Number of motor poles	5.11	R/W	2 to 32 poles	 4 poles
					 6 poles
0.43	Power factor (cos φ)	5.10	R/W	0 to 1.000	 0.92
					 1
0.44	Motor rated voltage	5.09	R/W	 T : 0 to 480 V TL : 0 to 240V	 T : 400 V TL : 220V
				 Not used	 0
0.45	Motor on-load rated speed	5.08	R/W	 0 to 30000 min ⁻¹	 1450 min ⁻¹
				 Not used	 0
0.46	Motor rated current	5.07	R/W	0 to IN.CONTR (A)	IN.CONTR (A)
0.47	Motor rated frequency	5.06	R/W	 0 to 1000.0 min ⁻¹	 50 Hz
				 Not used	 0
0.48	Controller operating mode	11.31	R/W	OPEN LP, CL Vect., SERVO	OPEN LP
0.49	Security code access level	-	RO	-	1
0.50	Software version	11.29	RO	-	Software version

* See the derating to be performed according to the set frequency, in section 1.3.2.

UMV 4301

Open or closed loop speed controller for asynchronous and synchronous motors

4.4.3 - Preset configuration 2 : Faster / slower control

4.4.3.1 - Introduction

This configuration enables the speed reference to be produced from an analogue signal or a faster/slower command (function of a motorised potentiometer). In the default setting, the analogue input is configured as 0/10V but can be changed to a current signal (0-20mA or 4-20mA) via the parameter 0.24.

Menu 0 of the configuration contains in particular the parameters necessary for setting the faster / slower function.













4.4.3.2 - Default settings automatically modified

Parameter	Default setting with configuration 2	Comment
7.14	0.00	Cancels the destination of analogue input 2
8.10	9.26	Assignment of terminal 24 to the faster command
8.12	0	Configuration of terminal 24 as an input
8.16	9.27	Assignment of terminal 26 to the slower command
9.25	1.37	Assignment of the faster/slower command output to analogue reference 2

4.4.3.3 - Connection diagram

See the diagram in section 3.7.5

4.4.3.4 - Menu 0 de la configuration 2

Parameter	Description	Address	Type	Adjustment range	Default setting
0.00 to 0.10	Parameters identical to menu 0 default setting ( sect 4.3.2,  and  sect 4.3.4)				
0.11 to 0.16	Parameters identical to menu 0 default setting ( sect 4.3.2,  and  sect 4.3.4)				
0.17	Inversion of relay output	8.26	R/W	0 or 1	0
0.18 to 0.24	Parameters identical to menu 0 default setting ( sect 4.3.2,  and  sect 4.3.4)				
0.25	Manual reset of the faster / slower command reference	9.28	R/W	0 or 1	0
0.26	Reading of the reference produced by the faster / slower command	9.03	RO	± 100.0 %	-
0.27	Selection of automatic reset of the faster / slower command reference	9.21	R/W	0 or 1	0
0.28	Selection of the polarity of the faster / slower command reference	9.22	R/W	0 or 1	0
0.29	Ramp time of the faster / slower command reference	9.23	R/W	0 to 250s	20s
0.30	Scaling of the faster / slower command reference	9.24	R/W	0 to 4.000	1.000
0.31 to 0.50	Parameters identical to menu 0 default setting ( sect 4.3.2,  and  sect 4.3.4)				

UMV 4301

Open or closed loop speed controller for asynchronous and synchronous motors

4.4.3.5 - Explanation of the parameters specific to configuration 2

0.17 : Inversion of the relay output

Adjustment range : 0 or 1

Default setting : 0

0 : the relay output is not inverted.

1 : the relay output is inverted.

0.25 : Manual reset of the faster / slower command reference

Adjustment range : 0 or 1

Default setting : 0

When this parameter is at 1, the faster/slower command reference is reset to zero.

0.26 : Reading of the reference produced by the faster/slower command

Adjustment range : ± 100.0

Indicates the level of the reference from the motorised potentiometer before scaling.

0.27 : Selection of automatic reset of the faster/slower command reference

Adjustment range : 0 or 1

Default setting : 0

0 : the faster/slower command reference will be the same level on power-up as it was at power-down.

1 : the faster/slower command reference will be reset to zero each time the controller is powered up.

0.28 : Selection of the polarity of the faster / slower reference

Adjustment range : 0 or 1

Default setting : 0

0 : the faster/slower command reference is limited to positive values (0 to 100.0 %).

1 : the faster/slower command reference can change from -100 % to +100 %.

0.29 : Faster/slower command reference ramp time

Adjustment range : 0 to 250

Default setting : 20

This parameter defines the period of time required for the faster/slower command reference to change from 0 to 100.0 %.

A double period is required for the reference to change from -100.0 % to +100.0 %.

Defines the sensitivity of the command.

0.30 : Scaling of the faster/slower command reference

Adjustment range : 0 to 4.000

Default setting : 1.000

The maximum value of the faster/slower command reference automatically takes the maximum value of the analogue reference to which it is assigned.

This parameter is thus used to adapt the maximum value of the faster/slower command reference to the maximum value required by the application.

Example :

- The faster reference is addressed to a preset value.

- In , the maximum value of a preset speed is 1000 Hz.

- The user wishes the maximum value of the faster / slower command reference to be 50 Hz.

$$\Rightarrow 0.30 = \frac{50}{1000} = 0.05.$$

UMV 4301

Open or closed loop speed controller for asynchronous and synchronous motors

4.4.4 - Preset configuration 3 : Preset speeds

4.4.4.1 - Introduction

This configuration enables the speed reference to be produced from an analogue signal or 4 preset references selected by a combination of 2 logic inputs. In the default setting, the analogue input is configured at 0/10V but can be changed to a current signal (0-20mA or 4-20mA) via parameter 0.24. Menu 0 of configuration 3 contains in particular the 4 parameters for the preset speeds.

























4.4.4.2 - Default settings automatically modified

Parameter	Default setting with configuration 3	Comment
8.10	1.45	Assignment of terminal 24 to the selection of the preset speeds
8.12	0	Configuration of terminal 24 as an input
8.16	1.46	Assignment of terminal 26 to the selection of the preset speeds
8.23	1.42	Assignment of terminal 29 to the selection of the speed reference by analogue input or preset speeds

4.4.4.3 - Connection diagram

See the diagram in section 3.7.6

4.4.4.4 - Menu 0 of configuration 3

Parameter	Description	Address	Type	Adjustment range	Default setting
0.00 to 0.10	Parameters identical to menu 0 default setting ( sect 4.3.2,  and  sect 4.3.4)				
0.11 to 0.16	Parameters identical to menu 0 default setting ( sect 4.3.2,  and  sect 4.3.4)				
0.17	Inversion of relay output	8.26	R/W	0 or 1	0
0.18 to 0.24	Parameters identical to menu 0 default setting ( sect 4.3.2,  and  sect 4.3.4)				
0.25	 : Preset frequency 1	1.21	R/W	± 1000.0 Hz	0
	 &  : Preset speed 1			± 30000 min ⁻¹	
0.26	 : Preset frequency 2	1.22	R/W	± 1000.0 Hz	0
	 &  : Preset speed 2			± 30000 min ⁻¹	
0.27	 : Preset frequency 3	1.23	R/W	± 1000.0 Hz	0
	 &  : Preset speed 3			± 30000 min ⁻¹	
0.28	 : Preset frequency 4	1.24	R/W	± 1000.0 Hz	0
	 &  : Preset speed 4			± 30000 min ⁻¹	
0.29	Not used				
0.30	Not used				
0.31 to 0.50	Parameters identical to menu 0 default setting ( sect 4.3.2,  and  sect 4.3.4)				

UMV 4301

Open or closed loop speed controller for asynchronous and synchronous motors

4.4.4.5 - Explanation of the parameters specific to configuration 3



0.17 : Inversion of the relay output

Adjustment range : 0 or 1



Default setting : 0

0 : the relay output is not inverted.



1 : the relay output is inverted.

0.25 to **0.28** : Preset frequencies () or speeds ( and )

Adjustment range :  : ± 1000.0 Hz

 } ± 30000 min⁻¹

Default setting : 0



In order, **0.25** to **0.28** are used to define preset frequencies or speeds FP1 to FP4 () or VP 1 to VP4 ( and ).

UMV 4301

Open or closed loop speed controller for asynchronous and synchronous motors



4.4.5 - Preset configuration 4 : Torque control

4.4.5.1 - Introduction

This configuration is used for speed or torque control of the controller. In torque control, the speed is limited by 0.02 (Maximum speed limit), and by the analogue reference 2 in  and . The analogue inputs are configured as 0-10V but can be changed to a current signal (0-20mA or 4-20mA) via parameter 0.24 for the torque reference and 0.26 for the speed reference. In reverse operation, the torque reference is automatically reversed.

Menu 0 contains in particular the parameter for setting the overspeed threshold which is essential for torque operation.















4.4.5.2 - Default settings automatically modified

Parameter	Default setting with configuration 4	Comment
7.10	4.08	Assignment of analogue input 1 to torque reference
7.14	1.36	Assignment of analogue input 2 to speed reference
8.10	10.06	Assignment of terminal 24 to "at speed" output
8.16	10.04	Assignment of terminal 26 to "min. speed" output
8.18	1	Configuration of terminal 26 as an output
8.23	 9.29	Assignment of terminal 29 to the selection of speed control or torque control
	 &  9.30	
9.33	4.11	
9.04	6.32	Inversion of the sign of the torque reference when the direction of rotation is reversed
9.10	7.09	

4.4.5.3 - Connection diagram

See diagram in section 3.7.7

4.4.5.4 - Menu 0 of configuration 4

Parameter	Description	Address	Type	Adjustment range	Default setting
0.00 to 0.10	Parameters identical to menu 0 default setting ( sect 4.3.2,  and  sect 4.3.4)				
0.11 to 0.16	Parameters identical to menu 0 default setting ( sect 4.3.2,  and  sect 4.3.4)				
0.17	Inversion of relay output	8.26	R/W	0 or 1	0
0.18 to 0.23	Parameters identical to menu 0 default setting ( sect 4.3.2,  and  sect 4.3.4)				
0.24	Selection of the type of signal on analogue input 1	7.06	R/W	Volt, 0-20, 20-0, 4-20tr, 20-4tr, 4-20lo, 20-4lo, 4-20Pr, 20-4Pr	Volt
0.25	Analogue input 1	7.01	R	± 100 %	-
0.26	Selection of the type of signal on analogue input 2	7.11	R/W	Volt, 0-20, 20-0, 4-20tr, 20-4tr, 4-20lo, 20-4lo, 4-20Pr, 20-4Pr	Volt
0.27	Analogue input 2	7.02	R	± 100 %	-
0.28	 Max. frequency threshold	3.08	R/W	0 to (0.02 x 1.2) Hz	(0.02 x 1.2) Hz
	 Overspeed threshold			0 to 30000 min ⁻¹	2000 min ⁻¹ 4000 min ⁻¹
0.29	Scaling of analog input 1	7.08	L-E	0 to 4.000	1.000
0.30	Scaling of analog input 2	7.12	L-E	0 to 4.000	1.000
0.31 to 0.50	Parameters identical to menu 0 default setting ( sect 4.3.2,  and  sect 4.3.4)				

UMV 4301

Open or closed loop speed controller for asynchronous and synchronous motors

4.4.5.5 - Explanation of the parameters specific to configuration 4

0.17 : Inversion of relay output

Adjustment range : 0 or 1

Default setting : 0

0 : the relay output is not inverted.

1 : the relay output is inverted.

0.24 & 0.26 : Selection of the type of signal on the analogue inputs

Adjustment range : See table

Default setting : VoLt

Analogue speed reference inputs 1 and 2 can be configured differently according the table below.

0	VoLt	Voltage input $\pm 10V$
1	0-20	0-20mA
2	20-0	20-0mA
3	4-20.tr	4-20mA (trip if signal lost)
4	20-4.tr	20-4mA (trip if signal lost)
5	4-20.Lo	4-20mA (min. speed if signal lost)
6	20-4.Lo	20-4mA (min. speed if signal lost)
7	4-20.Pr	4-20mA (speed before trip if signal lost)
8	20-4.Pr	20-4mA (speed before trip if signal lost)
9	th.SC	Thermistor with trip on detection of short-circuit
10	th	Thermistor without detection of short-circuit

Nota : For the 4-20 mA and 20-4 mA modes the signal loss threshold is 3 mA.

0.25 & 0.27 : Analogue inputs

Adjustment range : $\pm 100\%$ of the adjustment range of the parameter assigned to the analogue input.



- Is used to read the corresponding analogue input.

- Analogue input 1 uses a Voltage-Frequency converter which provides a resolution of 12 bits + sign and better immunity to noise. Input 2 uses an Analogue - Digital converter with resolution of 10 bits + sign.

The adjustment range for the parameters is $\pm 100\%$ for voltage inputs and 0 - 100 % for current inputs.

0.28 : Maximum frequency () or overspeed (and) thresholds



Adjustment range :  : 0 to 1000.0 Hz

 } 0 to 30000 min⁻¹

Default setting :  : 1000.0 Hz

 : 2000 min⁻¹

 : 4000 min⁻¹

Defines the frequency () or the speed ( and ) above which the controller trips on an overspeed fault (0V.SpD).

 • In torque control, if there is no resisting torque, the machine overspeeds. For safety, it is recommended to set the maximum speed of the driven machine in 0.28.

In  , set 3.29 to 1 to enable this threshold.

UMV 4301

Open or closed loop speed controller for asynchronous and synchronous motors

4.4.6 - Preset configuration 5 : PID control

4.4.6.1 - Introduction

This configuration regulates a setpoint from an analogue reference and the measurement of the controlled value (temperature, pressure, flow rate, level, etc). The analogue inputs are configured as 0/10V but can be changed to a current signal (0-20mA or 4-20mA) using the following parameters : 0.14 for the main reference, 0.15 for the PID reference and 0.16 for the sensor feedback. Menu 0 contains in particular the parameters required for setting the PID controller.

4.4.6.2 - Default settings automatically modified















Parameter	Default setting with configuration 5	Comment
7.10	0	Removal of assignment from analogue input 1
7.14	1.27	Assignment of analogue input 2 to a preset reference
7.15	0	Changing of analogue input 3 to a voltage signal +/- 10V

Parameter	Default setting with configuration 5	Comment
7.18	1.28	Assignment of analogue input 3 to a preset reference
8.23	14.08	Assignment of terminal 29 to the enabling of PID control
14.02	7.01	Assignment of analogue input 1 to the main reference
14.03	1.27	Assignment of the preset speed which contains analogue input 2 to the PID reference
14.04	1.28	Assignment of the preset speed which contains analogue input 3 to the sensor feedback
14.16	1.36	Assignment of the PID controller output to analogue reference 1

4.4.6.3 - Connection diagram

See the diagram in section 3.7.8

4.4.6.4 - Menu 0 de la configuration 5

Parameter	Description	Address	Type	Adjustment range	Default setting
0.00 to 0.10	Parameters identical to menu 0 default setting ( sect 4.3.2,  and  sect 4.3.4)				
0.11 to 0.13	Parameters identical to menu 0 default setting ( sect 4.3.2,  and  sect 4.3.4)				
0.14	Selection of the type of signal on analogue input 1	7.06	R/W	Volt, 0-20, 20-0, 4-20tr, 20-4tr, 4-20lo, 20-4lo, 4-20Pr, 20-4Pr	Volt
0.15	Selection of the type of signal on analogue input 2	7.11	R/W	Volt, 0-20, 20-0, 4-20tr, 20-4tr, 4-20lo, 20-4lo, 4-20Pr, 20-4Pr	Volt
0.16	Selection of the type of signal on analogue input 3	7.15	R/W	Volt, 0-20, 20-0, 4-20tr, 20-4tr, 4-20lo, 20-4lo, 4-20Pr, 20-4Pr	Volt
0.17	Analogue input 1	7.01	RO	± 100 %	-
0.18	Analogue input 2	7.02	RO	± 100 %	-
0.19	Analogue input 3	7.03	RO	± 100 %	-
0.20	PID controller proportional gain	14.10	R/W	0 to 4.000	1.000
0.21	PID controller integral gain	14.11	R/W	0 to 4.000	0.500
0.22	PID controller derivative gain	14.12	R/W	0 to 4.000	0
0.23	PID output upper limit	14.13	R/W	0 to 100.0 %	100.0 %
0.24	PID output lower limit	14.14	R/W	± 100.0 %	- 100.0 %
0.25	Scaling of the PID output	14.15	R/W	0 to 4.000	1.000
0.26	Reading of the PID reference	1.27	RO	 ± 1000.0 Hz  &  ± 30000 min ⁻¹	-
0.27	Reading of the sensor feedback	1.28	RO	 ± 1000.0 Hz  &  ± 30000 min ⁻¹	-
0.28	Scaling of analogue input 2	7.12	R/W	0 to 4.000	1.000
0.29	Scaling of analogue input 3	7.16	R/W	0 to 4.000	1.000
0.30	Additional condition - enable PID	14.09	R/W	0.00 to 20.50	0.00
0.31 to 0.50	Parameters identical to menu 0 default setting ( sect 4.3.2,  and  sect 4.3.4)				

UMV 4301

Open or closed loop speed controller for asynchronous and synchronous motors

4.4.6.5 - Explanation of the parameters specific to configuration 5

to : Analogue inputs

Adjustment range : ± 100 % of the adjustment range of the parameter assigned to the analogue input.

- Is used to read the corresponding analogue input.
- Analogue input 1 uses a Voltage-Frequency converter which provides a resolution of 12 bits + sign and better immunity to noise. Inputs 2 and 3 use an Analogue - Digital converter with a resolution of 10 bits + sign. The adjustment range for the parameters is ± 100 % for voltage inputs and from 0 - 100 % for current inputs.

: PID proportional gain

Adjustment range : 0 to 4.000

Default setting : 1.000

This is the proportional gain applied to the PID error.

: PID integral gain

Adjustment range : 0 to 4.000

Default setting : 0.500

This is the gain applied to the PID error before integration.

: PID derivative gain

Adjustment range : 0 to 4.000

Default setting : 0

This is the gain applied to the PID error before derivation.

: PID upper limit

Adjustment range : 0 to 100.0 %

Default setting : 100.0 %

This parameter is used to limit the maximum value of the PID output.

: PID lower limit

Adjustment range : ± 100.0 %

Default setting : -100.0 %

This parameter is used to limit the maximum negative value or the minimum positive value of the PID output.

: Scaling of the PID output

Adjustment range : 0 to 4.000



Default setting : 1.000

This parameter is used to scale the PID output before being added to the main reference.

The sum of the two references will be automatically re-scaled according to the adjustment range of the parameter to which it is addressed.

: Reading the PID reference

Adjustment range :  : ± 1000.0 Hz

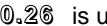

 } ± 30000 min⁻¹

The PID reference is addressed to preset reference 7. Addressing the PID reference to a preset reference enables the use of scaling of analogue input 2 to which the PID reference is connected.

 is used to read the value of the reference.

: Reading the sensor feedback

Adjustment range :  : ± 1000.0 Hz

 } ± 30000 min⁻¹

The sensor feedback is addressed to preset reference 8. Addressing the sensor feedback to a preset reference enables the use of scaling of analogue input 3 to which the sensor is connected.

 is used to read the value of the sensor feedback.

& : Scaling of the analogue inputs

Adjustment range : 0 to 4.000

Default setting : 1.000

These parameters are used, if required, to scale the analogue inputs. However, this is rarely necessary due to the fact that the maximum input level (100 %) automatically corresponds to the maximum value of the destination parameter.

: Additional condition : enable PID

Adjustment range : 0.00 to 20.50

Default setting : 0.00

This parameter is used to enable the PID controller on an additional condition on terminal 29.

For the PID controller to be enabled, terminal 29 and the run command must be at 1 and the additional condition assigned by  must be enabled.

Only bit parameters can be assigned.

If an incorrect parameter is chosen, the input will automatically take the value 1 to avoid blocking the enable output.

UMV 4301

Open or closed loop speed controller for asynchronous and synchronous motors

4.4.7 - Preset configuration 6 : Axis control

4.4.7.1 - Introduction

This configuration is used for stopping the controller on limit switches. When stopping on a limit switch, the deceleration ramp is different from the main ramp, and generally faster. This configuration is generally used for positioning axes. Menu 0 contains in particular the parameters for the state of the limit switches taken into account for stopping control and the setting of the special deceleration ramp.

4.4.7.2 - Default settings automatically modified

Parameter	Default setting with configuration 6	Comment
2.04	FAST	Due to the short ramps which are generally required, braking by resistor is necessary.
2.22	1.0	Setting a special deceleration ramp to 1 sec

Parameter	Default setting with configuration 6	Comment
1.10	1	With this configuration, the controller is as a rule controlled in +/- 10V (bi-polar) mode
8.16	6.35	Assignment of terminal 26 to management of the forward limit switch
8.23	6.36	Assignment of terminal 26 to management of the reverse limit switch
9.04		6.35
9.05		1
9.06		6.36
9.07		1
9.08		1
9.10		2.35

4.4.7.3 - Connection diagram

See the diagram in section 3.7.9

4.4.7.4 - Menu 0 of configuration 6

Parameter	Description	Address	Type	Adjustment range	Default setting
0.00 to 0.10	Parameters identical to menu 0 default setting (sect 4.3.2, and sect 4.3.4)				
0.11 to 0.13	Parameters identical to menu 0 default setting (sect 4.3.2, and sect 4.3.4)				
0.14	Reading the state of the forward limit switch	8.03	RO	0 or 1	-
0.15	Reading the state of the Run forward/ stop input	8.04	RO	0 or 1	-
0.16	Reading the state of the Run reverse/ stop input	8.05	RO	0 or 1	-
0.17	Reading the state of the reverse limit switch	8.06	RO	0 or 1	-
0.18	Selection of the stopping mode	6.01	R/W	0 to 4	and 1
				and 0 to 3	2
0.19	Stationary torque	6.08	R/W	0 or 1	and 0
					1
0.20	Special deceleration ramp	2.22	R/W	: 0 to 3200.0s/100Hz	1.0
				and : not available	
0.21	Inversion of the forward limit switch input	8.17	R/W	0 or 1	0
0.22	Inversion of the reverse limit switch input	8.24	R/W	0 or 1	0
0.23 to 0.30	Not used				
0.31 to 0.50	Parameters identical to menu 0 default setting (sect 4.3.2, and sect 4.3.4)				

UMV 4301

Open or closed loop speed controller for asynchronous and synchronous motors

4.4.7.5 - Explanation of the parameters specific to configuration 6

 to  : Reading the state of the inputs

Adjustment range : 0 or 1

Is used to display whether the input is enabled (1) or disabled (0).

0.14 : forward limit switch input

0.15 : run forward/stop input

0.16 : run reverse/stop input

0.17 : reverse limit switch input

 : Selection of the stopping mode



Adjustment range :

 :

Setting	Display	Function
0	COAST	Freewheel stop
1	rp	Stop on deceleration ramp
2	rp. dcL	Deceleration ramp + DC injection for 1s
3	dcL	Stop by DC injection braking and elimination of zero speed
4	td. dcL	Fixed time stop on DC injection

 }
 } :

Setting	Display	Function
0	COAST	Freewheel stop
1	rp	Stop on deceleration ramp
2	no - rp	Stop without ramp
3	rp - Pos	Orientation stop (indexing)



Default setting :  }
 } 1 (rp)

 : 2 (no.rp)

For explanations, refer to section 4.3.5, parameter 0.16.

 : Stationary torque



Adjustment range : 0 or 1

Default setting :  } 0
 }
 : 1

When this parameter is at 1, the controller will maintain the stationary torque after a stop command rather than locking the output bridge. The controller state will be " StoP " when the controller is stopped rather than " rdY ".

 : Special deceleration ramp

Adjustment range :  : 0 to 3200.0s/100 Hz

 } not available
 }

Default setting : 1.0

It is this deceleration ramp which will be automatically selected when stopping on limit switches.

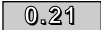
 : Inversion of the forward limit switch input

Adjustment range : 0 or 1

Default setting : 0

0 : a command to stop on special ramp will be triggered when the forward limit switch closes.

1 : a command to stop on special ramp will be triggered when the limit switch opens.

 : Inversion of the rear limit switch input

Adjustment range : 0 or 1

Default setting : 0

0 : a command to stop on special ramp will be triggered when the reverse limit switch closes.

1 : a command to stop on special ramp will be triggered when the limit switch opens.

UMV 4301

Open or closed loop speed controller for asynchronous and synchronous motors

4.4.8 - Preset configuration 7 : Brake control



4.4.8.1 - Introduction

This configuration is used to control the release and engagement of a brake via one of the controller logic outputs. In open loop mode () the brake is released when the controller is not tripped, the output frequency is higher than 2.2 Hz and the total motor current is above an adjustable threshold. The brake is engaged when the controller is tripped or after a stop command when the output frequency is lower than 1.8 Hz or when the motor current is below an adjustable threshold.

WARNING :

With this configuration, the brake will closed between +2Hz and -2Hz when direction is reversed. To avoid this, modify the settings as follows :















9.04 = 10.01, 9.14 = 1.11, 9.15 = 1, 9.17 = 0, 9.18 = 1.

In closed loop mode ( and ) the brake is released when the controller is not tripped and when the total current is above an adjustable threshold. The brake is engaged when the controller is tripped or when, after a stop command, the motor speed is below 1.8 min⁻¹. A time delay on release enables the brake response time to be taken into account. Menu 0 contains in particular the parameters for setting the brake release and engagement conditions.

 • As this configuration has no safety system, it should only be used for horizontal movements.

For hoisting movements, the use of the CAP UMV LVG option card will ensure the inherent safety of the controller. In all cases, it is the responsibility of the system designer, the installer or the user to ensure the overall safety of the installation.









4.4.8.2 - Default settings automatically modified

Parameter	Default setting with configuration 7	Comment
2.04	Fast	The use of braking resistors is often necessary with this configuration
3.05	 : 2.0Hz	Adjustment of the minimum speed threshold
	 &  : 2min ⁻¹	
6.08	1	Enables holding of the standstill torque
8.10	9.01	Assignment of terminal 24 to the brake control logic output
9.04	12.01	Creation of the brake control logic
9.06	9.02	
9.07	 : 0	
	 &  : 1	
9.14	 : 10.01	
	 &  : 1.11	
9.15	 : 0	
	 &  : 1	
9.16	10.03	
9.17	 : 1	
	 &  : 0	
9.19	0.2	
12.03	4.01	
12.04	10	
12.05	10	

4.4.8.3 - Connection diagram

See the diagram in section 3.7.10

4.4.8.4 - Menu 0 of configuration 7

Parameter	Description	Address	Type	Adjustment range	Default setting
0.00 to 0.10	Parameters identical to menu 0 default setting ( sect 4.3.2,  and  sect 4.3.4)				
0.11 to 0.13	Parameters identical to menu 0 default setting ( sect 4.3.2,  and  sect 4.3.4)				
0.14	Total motor current	4.01	RO	0 to I max controller	-
0.15	Current threshold reached	12.01	RO	0 or 1	-
0.16	Controller in operating state	10.01	RO	0 or 1	-
0.17	Minimum speed reached	10.03	RO	0 or 1	-
0.18	Active brake release command	9.01	RO	0 or 1	-
0.19	Brake release current threshold	12.04	R/W	0 to 100 % of I max controller	10.0 %
0.20	Brake release time delay	9.19	R/W	0 to 25.0s	0.2s
0.21 to 0.30	Not used				
0.31 to 0.50	Parameters identical to menu 0 default setting ( sect 4.3.2,  and  sect 4.3.4)				

UMV 4301

Open or closed loop speed controller for asynchronous and synchronous motors

4.4.8.5 - Explanation of the parameters specific to configuration 7

0.14 : Total motor current

Adjustment range : 0 to I max controller
Reading of the rms current in each output phase of the controller.

This is the result of the vectorial sum of the magnetizing current and the active current.

0.15 : Current threshold reached

Adjustment range : 0 or 1
0.15 is at 1 when the total motor current is greater than the threshold set in 0.19.

0.16 : Controller ready

Adjustment range : 0 or 1
This parameter is at 1 when the controller is not tripped. If parameter 0.36 is at 1, this bit will remain at 1 during the trip phase if an automatic trip reset is to occur. Once the number of automatic resets has been reached, the next trip will set this bit to zero.

0.17 : Zero speed

Adjustment range : 0 or 1
In open loop control mode this bit is at 1 when the absolute value of the ramp output is less than or equal to the threshold defined in parameter 3.05.
In closed loop control mode the speed feedback is taken into account.

0.18 : Active brake release command

Adjustment range : 0 or 1
0.18 is at 1 when all the brake release conditions are met. That is, the controller is in operating state (0.16 = 1), the output frequency is greater than 2.2 Hz (0.17 = 0 in open loop mode only) and the total motor current is greater than the threshold set in 0.19 (0.15 = 1).

0.19 : Brake release current threshold

Adjustment range : 0 to 100 % of I max controller

Default setting : 10.0 %

This is used to set the current threshold at which the brake will be released. This value must be sufficient to prevent backdriving of the maximum load when the brake is released.

0.20 : Brake release time delay

Adjustment range : 0 to 25.0s

Default setting : 0.2s

Time between the appearance of the speed conditions and the brake control.

This is used to take the brake response time into account.

UMV 4301

Open or closed loop speed controller for asynchronous and synchronous motors

4.4.9 - Preset configuration 8 : Electrical shaft (and only)

4.4.9.1 - Introduction

This configuration is used, in closed loop mode, to synchronise the motor fitted with an encoder with a master encoder mounted on another motor or at another location in the installation. Menu 0 contains in particular the parameters necessary for configuring the system.

WARNING :

This configuration requires the use of a COD2 UMV option for connecting the reference encoder.













4.4.9.2 - Default settings automatically modified

Parameter	Default setting with configuration 8	Comment
2.04	Fast	It is essential to use braking resistors in this configuration
3.20	1	Enables additional speed input used for correction of the position error
3.10	13.18	Assignment of terminal 24 to the end of indexing synchronisation
13.08	1	Enables position synchronisation mode with speed reference from the reference encoder and correction of error from the position loop

4.4.9.3 - Connection diagram

See diagram in section 3.7.11

4.4.9.4 - Menu 0 of configuration 8

Parameter	Description	Address	Type	Adjustment range	Default setting
0.00 to 0.10	Parameters identical to menu 0 default setting ( sect 4.3.2,  and  sect 4.3.4)				
0.11 to 0.13	Parameters identical to menu 0 default setting ( sect 4.3.2,  and  sect 4.3.4)				
0.14	Jogging reference	1.05	R/W	0 to 4000 min ⁻¹	50 min ⁻¹
0.15	Synchronisation mode	13.08	R/W	0 to 5	1
0.16	Encoder feedback number of points per rev.	3.21	R/W	256 to 4096 (for N = 3000 min ⁻¹)	 : 1024
					 : 4096
0.17	Synchronisation ratio	13.07	R/W	0 to 4.000	1.000
0.18	Reading the speed of the feedback encoder	3.26	RO	± 30000 min ⁻¹	-
0.19	Reading the position of the feedback encoder	3.27	RO	(0 to 16383)/16384 rev.	-
0.20	Reading the position error	13.01	RO	± 16384/16384 rev.	-
0.21	Reading the position of the ref. encoder	16.03	RO	(0 to 16383)/16384 rev.	-
0.22	Reading the speed of the ref. encoder	16.02	RO	± 30000 min ⁻¹	-
0.23	Ref. encoder number of points per rev.	16.04	R/W	0 to 16384	1024
0.24	Position loop gain	13.09	R/W	0 to 4.000	0.100
0.25	Limitation of position correction speed	13.10	R/W	0 to 250 min ⁻¹	150 min ⁻¹
0.26	Indexing reference	13.11	R/W	(0 to 4095)/4096 rev.	0
0.27	End of indexing signalling window	13.12	R/W	(0 to 200)/4096 rev.	20/4096 rev.
0.28	Selection of the stopping mode	6.01	R/W	Coast, rp, no rp, rp Pos	 : rp
					 : no rp
0.29	Reference encoder revolution counter	13.16	RO	0 to 16384 revolutions	-
0.30	Feedback encoder revolution counter	13.17	RO	0 to 16384 revolutions	-
0.31 to 0.50	Parameters identical to menu 0 default setting ( sect 4.3.2,  and  sect 4.3.4)				

UMV 4301

Open or closed loop speed controller for asynchronous and synchronous motors

4.4.9.5 - Explanation of the parameters specific to configuration 8

0.14 : Jogging reference

Adjustment range : 0 to 4000 min⁻¹

Default setting : 50 min⁻¹

This is used to adjust the speed reference which is added to the reference from the reference encoder.

Obtains an offset between the reference encoder and the controlled motor.

0.15 : Synchronisation mode

Adjustment range : 0 to 5

Default setting : 1

0 : desactivated.

1 : position synchronisation with the speed reference from the reference encoder and error correction from the position loop.

- The highest performance synchronisation mode when the speed of the reference encoder is high.

2 : position synchronisation with error correction only.

- Synchronisation mode used when the speed of the reference encoder is not sufficient for good synchronisation. In this case a main speed reference from an analogue input or from a preset speed can be added to the error correction.

3 : speed synchronisation with speed reference from the reference encoder and error correction from the position loop.

- The same as 1, but speed synchronisation only.

- With speed synchronisation, if there is an offset between the controlled motor and the reference encoder (overload, inertia, etc), the position error will be cancelled when the controlled motor reaches the reference speed.

With position synchronisation, the controlled motor will switch to overspeed to eliminate the position error.

4 : not operational

5 : indexing at a stop command

- If the rP.POS deceleration mode is selected (parameter 0.28), when there is a stop command the controller will immobilise the motor at the position set in parameter 0.26.

6 : indexing on a run or stop command

- The same as 5, but indexing is also possible on a run command.

- To do this, enable holding of the standstill torque (parameter 6.08).

Indexing procedure :

- The controller accelerates (mode 6) or decelerates (modes 5 and 6) to the speed set in 0.25, in the direction in which the motor was rotating before the indexing command.



- When the speed is reached, the ramps are automatically cancelled.

- When the position of the motor is close to the required position, the speed reference changes to 0 and the position loop is enabled.

- When the speed required to correct the error is less than 2 min⁻¹ and the position of the motor is within the window determined by 0.26 and 0.27, the indexing is stopped.

0.16 : Number of points per encoder revolution

Adjustment range : Depend on the motor speed

Default setting :  } 1024
 }
 : 4096

The adjustment range of this parameter is limited by the maximum speed of the motor.

Maximum speed (min ⁻¹)	0.16 maximum
0 - 3000	4096
3001 - 6000	2048
6001 - 12000	1024
12001 - 24000	512
24001 - 30000	256

This parameter is used to configure the number of encoder points in the controller.

An incorrect value for this parameter will cause incorrect reading of the motor speed and thus a controller fault.

0.17 : Synchronisation ratio

Adjustment range : 0 to 4.000

Default setting : 1.000

This parameter is used to obtain a ratio between the reference encoder and feedback which is other than 1.

0.18 : Reading the encoder speed

Adjustment range : ± 30000min⁻¹

This parameter indicates the speed of the machine whose encoder is connected to the main encoder input.

0.19 : Reading the encoder position

Adjustment range : (0 to 16383)/16384 revolution

This parameter indicates the position of the encoder connected to the main encoder input.

The measurement is taken in relation to the point at which the encoder was located when the controller was powered up.

UMV 4301

Open or closed loop speed controller for asynchronous and synchronous motors

0.20 : Position loop error

Adjustment range : $\pm 16384/16384$ revolutions
 This parameter indicates the position error when position control is used.

The adjustment range of this parameter is ± 1 revolution. If the position error exceeds one revolution, the parameter will display an error of one revolution and the sign corresponding to the direction of the error.

0.21 : Position of encoder 2

Adjustment range : (0 to 16383)/16384 revolutions
 Reading of the position of encoder 2 in $1/16384 \text{ min}^{-1}$.
 The origin is taken either from the position at power-up from the zero marker if it is detected.

0.22 : Speed of encoder 2

Adjustment range : $\pm 30000 \text{ min}^{-1}$
 Reading of the feedback speed of encoder 2 after decoding.

0.23 : Number of points/rev. of the ref. encoder

Adjustment range : 0 to 16384
 Default setting : 1024
 Enter the number of points per revolution of the second encoder. If the setting is incorrect all the position reading parameters will be incorrect.

0.24 : Position loop gain

Adjustment range : 0 to 4.000
 Default setting : 0.100
 Gain applied to the position loop to assist the correction of the position error.

0.25 : Limitation of the position correction speed

Adjustment range : 0 to 250 min^{-1}
 Default setting : 150 min^{-1}
 This parameter limits the speed which it is necessary to add to the reference speed in order to eliminate the position error.
 In closed loop mode, this parameter is also used as a speed reference when performing indexing.

0.26 : Indexing reference (&)

Adjustment range : (0 to 4095)/4096 revolutions
 Default setting : 0
 This parameter defines the position of the encoder when stopped.

0.27 : Indexing signalling window (&)

Adjustment range : (0 to 200)/4096 revolutions
 Default setting : 20/4096 revolutions
 During the indexing phase, the end of execution will be signalled when the absolute value of the speed is less than 2 min^{-1} and the position of the encoder is between $(0.26 - 0.27)$ and $(0.26 + 0.27)$.

0.28 : Selection of the stopping mode

Adjustment range :

Setting	Display	Function
0	COAST	Freewheel stop
1	rp	Stop on deceleration ramp
2	no - rp	Stop without ramp
3	rp - Pos	Orientation stop (indexing)

Default setting :  : 1 (rp)
 : 2 (no.rp)

For explanations, refer to section 4.3.5, parameter 0.16.

0.29 : Reference encoder revolution counter

Adjustment range : ± 32000 revolutions
 This variable is incremented for each clockwise revolution and decremented for each anti-clockwise revolution.
 When the parameter reaches its maximum value, it returns to 0 and not the maximum value of the opposite sign.

0.30 : Feedback encoder revolution counter

Adjustment range : ± 32000 revolutions
 This variable is incremented for each clockwise revolution and decremented for each anti-clockwise revolution. When the parameter reaches its maximum value, it returns to 0 and not the maximum value of the opposite sign.

UMV 4301

Open or closed loop speed controller for asynchronous and synchronous motors

4.5 - Fault processing

The controller has been factory configured for the most secure operation :

- memorization of all faults,
- fault reset by deliberate action,
- controlled start.

However, depending on the application and the operating conditions, it is possible to control the operation according to the table below.

Parameter	Function	Setting	Description	Default setting
6.02	Starting mode	diS	The start is controlled. If a run command is present at power-up, it will be necessary to perform a stop and then a run in order to obtain the start	diS
		ALYS	At power-up, the start is automatic if the controller has not tripped and if the run command is present	
		Pd.dP	At power-up, the controller will automatically start if it was running when the power supply disappeared, and if the run command is present. However, it will not start if it was stopped when the power break occurred.	
6.03	Processing of micro-breaks	diS	With a micro-break, the controller continues to operate as long as the DC bus voltage is sufficient	diS
		StoP	The controller detects the micro-break and causes a deceleration in order to recover motor energy and thus maintain the DC bus voltage. When normal operating conditions are restored, deceleration continues until the motor stops.	
		ridE.th	As above, but when normal conditions are restored, the motor reaccelerates up to the reference speed.	
6.09	Flying restart	bit 0	When starting or after a micro-break, the controller starts its ramp from 0.	bit 0
		bit 1	The controller measures the frequency of the remanent voltage in order to determine rotation speed and direction of the motor and sets its reference on the measured value. CAUTION : If the motor is stopped, this function can cause unexpected rotation of the motor for a period of 1 or 2 seconds.	
10.34	Number of automatic resets	0	After tripping, the controller waits for a reset before starting again.	0
		1 to 5	After tripping, the controller automatically tries to start again as many times as the programmed number. If the number of restarts is reached during a period of 5 minutes, the controller is locked.	
10.35	Automatic restart time delay	0 to 25s	Time between tripping and an automatic restart.	1
10.36	Processing of fault relay	bit 0	The fault relay changes to 0 between the occurrence of the fault and the automatic restart.	0
		bit 1	The fault relay remains at 1 between the occurrence of the fault and the automatic restart.	
10.37	Stopping mode for minor faults	bit 0	The controller initiates a freewheel stop for every fault.	0
		bit 1	On occurrence of a minor fault (fault 14 to 26, section 5), the controller decelerates before locking.	

UMV 4301

Open or closed loop speed controller for asynchronous and synchronous motors

4.6 - Other possibilities

The UMV 4301 controller offers many other possibilities which are not described in this manual. The list of all the parameters grouped into menus, together with explanations and operating diagrams, is given in a technical document which is available on request.

Example of additional possibilities

Menu 1 : Generation of speed references

- Possibility of having a speed reference with enhanced precision (0.001 Hz instead of 0.03 Hz as standard).
- Differentiation of forward and reverse speed stops.

Menu 2 : Generation of ramps

- Differentiation of acceleration and deceleration ramps in forward and reverse operation, preset speeds and jogging.

Menu 3 : Frequency reference via encoder input

In open loop mode, the speed reference is given by a frequency signal connected to the encoder input.

Menu 4 : Current selection and limitation

- Possibility of torque control mode.
- Differentiation of torque limitation in motor and generator operating mode.

Menu 5 : Motor control

Menu 6 : Processing and logic commands for controller and counters

- Special configuration for starting and stopping modes.
- Special processing of mains faults.
- Calculation of power consumption (kWh).
- With a given electricity cost, calculation of the running cost.
- Alarms on time meter.

Menu 7 : Assignment of analogue inputs and outputs

Menu 8 : Assignment of logic inputs and outputs

Menu 9 : Logic functions and faster / slower

- Integrated AND functions.
- Source inversion.
- Integrated time delays.
- Integrated binary / decimal converter.

Menu 10 : Logic status and diagnostics

Menu 12 : Programmable thresholds

Automatic modification of an internal controller bit when a threshold preset by an internal analogue value is exceeded.

Menu 13 : Synchronization and orientation ()

- Synchronization of a slave motor with a motor or a master encoder.
- Adjustment of synchronization ratio.
- Position error indication.

Menu 14 : PID loop

Menu 15 : Regeneration mode *

- Modification of the characteristics of the input bridge.

Menu 16 : Parameter setting for the I/O option

- When powered up, the controller automatically checks which type of option is present and automatically opens the parameters linked to this option.

Menu 17 : Parameter setting of intelligent option

- When powered up, the controller automatically checks which type of option is present and automatically opens the parameters linked to this option.

Menu 18 and 19 : Application menus

- Used with the intelligent option.
- Parameters stored in the non-volatile memory of the controller.

Menu 20 : Application menu

- Used with the intelligent option.
- Parameters stored in the memory of the intelligent option.

* Available later.

UMV 4301

Open or closed loop speed controller for asynchronous and synchronous motors

5 - FAULTS - DIAGNOSTICS

- Information relating to the status of the controller is given by the display, or via the logic outputs (relays and open collector transistors) for certain states.

- The information may be :

- the controller status
- alarm indications while the controller is operating
- faults in the form of mnemonics

5.1 - Display indication - error messages

No.	Display mnemonic	Reason for fault	Points to check	Solution
1	UU	DC bus undervoltage T : < 320Vcc TL : < 175Vcc	• Power supply terminals L1, L2, L3 mains undervoltage	• Check the mains power supply • Check the power components
2	OU	DC bus overvoltage T : > 830Vcc TL : > 415 Vcc	• Deceleration too fast (inertial load) • Terminals L1, L2, L3 mains overvoltage	• Program a longer deceleration time in 0.04 • Check the deceleration mode in 0.15 • Fit a braking resistor (optional) • Check the mains power supply
3	OI. AC	Overcurrent at controller output • Too high boost during the autotune phase	• Power terminal blocks U, V, W • Wiring • Parameter 0.08	• Eliminate the short-circuit at the controller output • Program a longer acceleration or deceleration time in 0.03 or 0.04 • Program a shorter gain in 0.07 () • Cable capacitance too high • Decrease the value of 0.08 and initiate again an autotune
4	OI. br	Braking resistor overcurrent	• Power terminal blocks +, •, – • Braking resistor, value	• Eliminate the short-circuit at the resistor output • Increase the resistor ohmic value
5	PS	Internal supply fault	• + 10V and + 24V terminals	• Check that the load on + 10V and + 24V is compatible with the maximum load rate • Eliminate the short-circuit on the + 10V or + 24V
6	Et	Forced external fault in open loop mode	• Terminal 30 in open loop mode	• Check that terminal 30 is connected to 0 V by external wiring (negative logic)
7	OV. Spd	Overspeed	• Motor speed higher than overspeed threshold	• Check that the load is not driving • Check that the overspeed threshold is set correctly • Adjust the speed loop gains • Program a longer deceleration time in 0.04 • Verify the setting of 0.16 • Decrease the value of 0.19
8	Prc 2	Microprocessor 2 fault when the CAP UMV option card is used	• CAP UMV option card	• Power down the controller, then power it up again - If the fault persists, consult LEROY-SOMER. • Perform a trip reset
9	SEP	Fault on option card : - ES UMV - RLV UMV - SINCOS-UMV	• Option card : - ES UMV - RLV UMV - SINCOS-UMV	• Check the following points : ES-UMV : overload on digital outputs RLV-UMV : reading of resolver feedback sig. SINCOS-UMV : serial link connections, encoder supply • Perform a trip reset • Power down the controller, then power it up again - If the fault persists, consult LEROY-SOMER.
10	ENC. OVL	Encoder ASIC fault (power supply, frequency and direction)	• Control card	• Perform a trip reset • Power down the controller, then power it up again - If the fault persists, consult LEROY-SOMER.

UMV 4301

Open or closed loop speed controller for asynchronous and synchronous motors

No.	Display mnemonic	Reason for fault	Points to check	Solution
11	ENC. PH1	U phase loss servo encoder	<ul style="list-style-type: none"> • Enc. f/back on 15-pin SUB-D • Encoder • Fault detected during autotune phase 	<ul style="list-style-type: none"> • Perform a trip reset • Repeat the autotune • Check the encoder / controller wiring • Check the connection of the encoder cable shielding
12	ENC. PH2	V phase loss servo encoder		
13	ENC. PH3	W phase loss servo encoder		
14	ENC. PH4	Incorrect connection of U, V, and W phases of servo encoder		
15	ENC. PH5	Encoder channel A missing	<ul style="list-style-type: none"> • Enc. f/back on 15-pin SUB-D • Encoder • Fault detected during autotune phase 	<ul style="list-style-type: none"> • Perform a trip reset • Repeat the autotune • Check the encoder / controller wiring • Check the connection of the encoder cable shielding
16	ENC. PH6	Encoder channel B missing		
17	ENC. PH7	Inversion of encoder channels A and B Inversion of U,V,W phases between the motor and the controller	<ul style="list-style-type: none"> • Enc. f/back on 15-pin SUB-D • Encoder • Fault detected during autotune phase. 	<ul style="list-style-type: none"> • Perform a trip reset • Repeat the autotune • Check the encoder / controller wiring • Check the encoder / controller U, V, W wiring
18	ENC. PH8	Interruption of autotune	<ul style="list-style-type: none"> • Stop commands • External faults 	<ul style="list-style-type: none"> • Perform a trip reset • Repeat the autotune
181	ENC. PH9	In servo mode, the phase sequencing is incorrect and an inverse torque is applied.	<ul style="list-style-type: none"> • Phase order at the power connection • Channel order at the speed feedback connection 	<ul style="list-style-type: none"> • Check the power wiring • Check the speed feedback connection
19	it. br	Braking resistor overload	<ul style="list-style-type: none"> • Braking resistor • Braking resistor wiring • Integrated braking transistor • Braking cycle too long 	<ul style="list-style-type: none"> • Increase the ohmic value • Check the wiring • Check the braking transistor • Increase the braking cycle
20	it. AC	Motor overload $I \times t$	<ul style="list-style-type: none"> • Motor load • Adjustment of IN motor 	<ul style="list-style-type: none"> • Check that the motor is not overloaded • Check that the motor rated current is set correctly (0.46)
21	Oh 1	Thermal simulation of the heatsink depending on $I \times t$	<ul style="list-style-type: none"> • Adjustment of IN motor 	<ul style="list-style-type: none"> • Reduce the motor load • Reduce the cycle
22	Oh 2	Heatsink overheating detected by thermal probe (above 95°C)	<ul style="list-style-type: none"> • Cooling fan (if fitted) • Ambient temperature 	<ul style="list-style-type: none"> • Check that : <ul style="list-style-type: none"> - the fans are rotating - the cooling apertures are not obstructed - that the temperature is below 50°C - there is suffic. space around the controller
23	OA	Overheating of the control card		
24	th	Tripping of the motor thermal probe	<ul style="list-style-type: none"> • Motor temperature too high : PTC > 3 kΩ or PTO open • Reset for R < 1.65kΩ 	<ul style="list-style-type: none"> • Check the motor load • Reduce the overload level • Check the ventilation of the motor and the ambient temperature • Check the wiring of the probe
25	thS	Short-circuit of the motor thermal probe PTC (terminal 8) with input configured for THS	<ul style="list-style-type: none"> • Motor PTC < 4 Ω 	<ul style="list-style-type: none"> • Check the ohmic value of the probe
26	OP.OVLd	Overload of + 24V power supply or digital outputs	<ul style="list-style-type: none"> • + 24V terminal 	<ul style="list-style-type: none"> • Check the + 24V charging circuit

UMV 4301

Open or closed loop speed controller for asynchronous and synchronous motors

No.	Display mnemonic	Reason for fault	Points to check	Solution
27	CL1	Loss of current reference on analogue input 1 with parameter 0.24 set at (4-20tr or 20-4tr)	<ul style="list-style-type: none"> Level of current reference 4.20 mA or 20.4 mA 	<ul style="list-style-type: none"> Check that the current reference is > 3mA
28	CL2	Loss of current reference on analogue input 2 with parameter 0.25 set at (4-20tr or 20-4tr)		
29	CL3	Loss of current reference on analogue input 3 with parameter 7.15 set at (4-20tr or 20-4tr)		
30	SCL	Loss of serial link communication	<ul style="list-style-type: none"> COM 1 UMV serial link option card PC link 	<ul style="list-style-type: none"> Power down then power up Delete by setting 0.00 to 1233 +  reset Check mounting and connection of card Transmission rate
31	EEF	EEPROM fault	<ul style="list-style-type: none"> Control card 	<ul style="list-style-type: none"> Power down then power up If the fault persists, consult LEROY-SOMER
32	Ph	Loss of one power supply phase	<ul style="list-style-type: none"> L1, L2, L3 	<ul style="list-style-type: none"> Check the mains power supply (motor stops before indication of fault)
33	rs	Fault during measurement of the stator resistance	<ul style="list-style-type: none"> Matching of motor power to controller power 	<ul style="list-style-type: none"> Adapt the controller power to the motor power Verify the motor cable connections
34	Reserved			
35	SEP EC	Incorrect serial communication with encoder option module	<ul style="list-style-type: none"> Option module Menu 16 	<ul style="list-style-type: none"> Ensure the option module is correctly fitted Check the encoder supply voltage
36	SEP EF	Fault in the encoder option module	<ul style="list-style-type: none"> Option module 	<ul style="list-style-type: none"> Ensure the option module is correctly fitted Replace the option module
37 to 39	Reserved			
40 to 99	tr xx	User trips with application modules	<ul style="list-style-type: none"> Application trips 	<ul style="list-style-type: none"> Check the reason of the trip as described in the application manual
100 to 158	Reserved			
159 to 179	tr xx	User trips with application modules	<ul style="list-style-type: none"> Application trips 	<ul style="list-style-type: none"> Check the reason of the trip as described in the application manual
180	SEP.diS	Option module parameters are set while no option module is fitted	<ul style="list-style-type: none"> Option module 	<ul style="list-style-type: none"> Power down the drive and fit the option module Return to the default settings if no module is needed
181	ENCPH9	<ul style="list-style-type: none"> Encoder trip with servo motor Trip on application with short accelerations and with a weakly loaded motor 	<ul style="list-style-type: none"> Encoder connections Menu 3 	<ul style="list-style-type: none"> Verify encoder connections (motor and drive connectors) Disable the trip at 3.31
182	FSH.Err	Clone option memory is corrupted	<ul style="list-style-type: none"> COPY-UMV manual 	<ul style="list-style-type: none"> Reset the settings and try again the storage procedure

UMV 4301

Open or closed loop speed controller for asynchronous and synchronous motors

No.	Display mnemonic	Reason for fault	Points to check	Solution
183	FSH.Dat	The clone option memory is empty	-	-
184	FSH.TyP	The operating mode of the drive and the one stored in the module are different	<ul style="list-style-type: none"> Parameter 0.48 	<ul style="list-style-type: none"> Check that the stored parameters are correct, then modify the operating mode (§ 4.2.3)
185	FSH.ACC	Write access to the clone option module is disabled	<ul style="list-style-type: none"> Clone option module terminal connector 	<ul style="list-style-type: none"> Link the terminals 40 and 41 of the COPY-UMV option
186	FSH.LO	The large option module is missing the Menu 20 parameters can't be transferred to the drive		
187	FSH.20	A large option module is fitted in the drive, while the Menu 20 parameters are missing in the COPY-UMV option		
188	FSH.rng	The rated current or the rated voltage of the drive is different from that relating to the selected parameter set, only a part of the parameters are transferred		
189 to 200	tr x	User trips with application modules		

Note : thermal devices should not be reset several times in succession

UMV 4301

Open or closed loop speed controller for asynchronous and synchronous motors

5.2 - Display of the controller status

Display	Output state	Operation
rdY	Inactive	The controller is waiting for a command The motor is ready to operate
run	Active	The motor is controlled
inh	Inactive	Freewheel stop
SCAn	Active	Flying restart of the motor after micro-break
ACUU	Active	Loss of mains supply and controller continues to supply the motor
dEC	Active	Deceleration after a stop command
triP	Inactive	Controller fault. The fault code is displayed
StoP	Active	The drive is holding the motor at zero speed
dc	Active	The drive is applying DC injection braking
POS	Active	The drive is positioning the motor shaft



Note : The above displays do not indicate a fault state, but give the status of the controller.

5.3 - Display of controller alarms

br.rs	Braking resistor overheating
OVLd	Motor overload I x t
hot	Heatsink overheating
Air	Control card excessive temperature

Note : When an alarm is displayed, the controller continues to operate, and the lower display alternately shows the normal message and the alarm code.

5.4 - Indication via logic outputs

Terminal	Type of output	Information given as standard
1	Relay	Fault indication
2		
24	Open collector transistor	 : At speed  } Zero speed  }

UMV 4301

Open or closed loop speed controller for asynchronous and synchronous motors

6 - MAINTENANCE

6.1 - Introduction and advice

! • All work concerning installation, commissioning and maintenance should be performed by experienced and qualified personnel.

• When a fault detected by the controller causes it to power down, residual voltages which may be fatal remain at the controller terminals and in the controller.

• Do not perform any work before the controller power supply has been opened and locked, and waiting 10 min for the capacitors to discharge.

• Ensure that the DC bus voltage is below 40V before performing any operation.

• During maintenance operations with the controller powered down, the operator must stand on an insulated surface which is not connected to earth.

• During work on a motor or its power supply cables, check that the power supply of the corresponding controller is open and locked.

• During tests, all protective covers must remain in place.

There are very few maintenance and emergency repair operations which the user can perform on UMV 4301 controllers. Listed below are the normal care operations together with simple methods for checking the correct operation of the controller.

6.2 - Care

Any controller may be subject to problems after being exposed to excessive heat, humidity, oil, dust, or if any external matter is allowed to penetrate.

Normally the printed circuits and their components do not require any maintenance. In the event of a problem, contact your nearest supplier or approved service centre.

DO NOT REMOVE PRINTED CIRCUIT BOARDS DURING THE WARRANTY PERIOD, AS THIS WILL IMMEDIATELY RENDER IT NULL AND VOID.

Do not touch integrated circuits or the microprocessor with your fingers or any charged or live material. Earth yourself, as well as the workbench or the soldering iron, before performing any operation on the circuits.

Periodically check that the power connections are correctly tightened.

Tightening torque :

- UMV 4301 1.5T to 16T and 1TL to 8TL = 0.5 Nm,

- UMV 4301 22T to 120T and 11TL to 33TL = 25 Nm.

After a 12 month storage time, the drive needs to be powered for 24 hours every 6 months.

6.3 - Voltage, current and power measurements

6.3.1 - Measurement of voltage at the controller output

The harmonics generated by the controller mean that it is not possible to obtain a correct measurement of the voltage at the motor input with a standard voltmeter. It is however possible to obtain an approximate value of the rms voltage of the fundamental wave (that which influences the torque) using a standard voltmeter connected as shown in the diagram below.

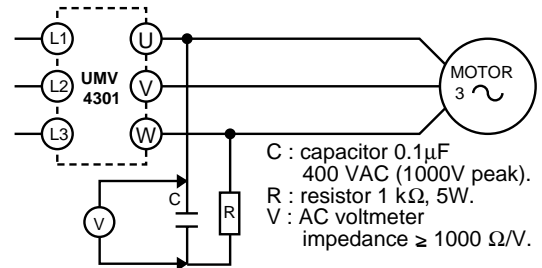

6.3.2 - Measurement of the motor current

The current drawn by the motor and the controller input current can be approximately measured using a standard moving coil ammeter.

6.3.3 - Measurement of the controller input and output power

The controller input and output powers can be measured using an electrodynamic instrument.

6.4 - Spare parts list

Consult LEROY-SOMER

6.5 - Replacement of products

WARNING :

The products must be returned in their original packaging or at least in similar packaging to prevent them being damaged. Otherwise, replacement under warranty could be refused.

UMV 4301

Open or closed loop speed controller for asynchronous and synchronous motors

7 - OPERATING EXTENSIONS

⚠ • All option modules must be inserted or removed with the controller powered down and isolated.

7.1 - Small option modules

These are option cards which are installed inside the UMV 4301 and are programmed via the keypad or a PC. There are 5 modules whose appearance is identical, but which cannot be used together.

- COD 2 UMV : 2nd encoder input.
- RLV UMV : Resolver feedback.
- ES UMV : Additional I/O, comprising :
 - 2 programmable relays,
 - 3 logic inputs,
 - 3 programmable logic I/O,
 - 2 analogue inputs,
 - 1 analogue output,
- SIN COS UMV : Sin Cos encoder feedback
- COPY UMV : Storage of 8 sets of parameters. Used to copy one of the stored sets of parameters to a controller after a return to default settings or after replacement.

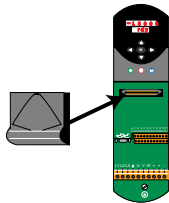

7.2 - Large option modules

These are options with a microprocessor which are installed in the UMV 4301 and programmed via the operator console or a PC.

There are 3 modules whose appearance is identical, but which cannot be used together.

- COM 1 UMV : " Slow " RS 232 - RS 485 serial link,
- CAP-UMV : * programmable card which may integrate different application software :
 - simple position control,
 - winder/unwinder,
 - synchronization,
 - lifting.
- CAP-UMV MOD : Modbus interface.
- COM 2 UMV : Programmable card + interface for connecting the UMV 4301 to a high-speed fieldbus :
 - Profibus DP,
 - Interbus S,
 - CT Net,
 - Modbus +,
 - Canbus - Device net.

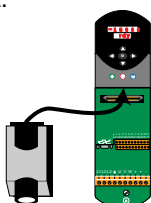

Note : A small and a large option module can be used in the same controller.

7.3 - RF braking resistors

⚠ • The braking resistor must be installed in such a way as to avoid damaging the neighbouring components by its heat dissipation.

• Special care must be taken with all operations close to the resistor, due to the high voltage and heat released (the temperature of the resistor is above 80°C).

• The braking resistor must be wired in series with a thermal relay calibrated to the rms current of the resistor to prevent the risk of fire which may result from a malfunction of the braking transistor or a short-circuit.

• The resistor must be connected between the + and ⊕ terminals of the controller.

• When a braking resistor is to be mounted outside the enclosure, make sure that it is mounted in a ventilated metal housing, preventing from any contact with the resistor.

7.3.1 - Electrical characteristics

RF rating	Ohmic value (Ω)	Thermal power (W)	Peak power (W)		Rms current (A)*
			400V	230V	
320T	180	320	2880	845	1.33
640T	90	640	5760	1690	2.66
1000T	68	1000	7620	2236	3.8
2000T	40	2000	12960	3800	7.07
3500T	40	3500	12960	3800	9.35
5500T	40	5500	12960	-	11.7
7500T	10	7500	51840	15200	27.4
11000T	10	11000	51840	-	33.2
18500T	10	18500	51840	-	43
22500T	5	22500	103680	-	67
27500T	10	27500	51840	-	52.4
37500T	5	37500	103680	-	86.6
55000T	5	55000	103680	-	104.8

* adjustment current of the thermal relay connected in series in the resistor.

• Minimum compatible resistor at 40°C

UMV 4301 controller rating	Minimum ohmic value (Ω)	Peak current (A)
1TL to 4.5TL	20	20
1.5TL to 5.5TL	40	20
8T	40	20
5.5T and 8TL	15	26
11T and 16T	30	25
11TL to 33TL	5	75
22T to 50T	10	75
60T to 120T	5	150

The minimum resistance allows the braking resistor to dissipate 150 % of the power rating of the drive for 60 seconds.

UMV 4301

Open or closed loop speed controller for asynchronous and synchronous motors

7.3.2 - Mechanical characteristics

• RF 320 T to 3500 T

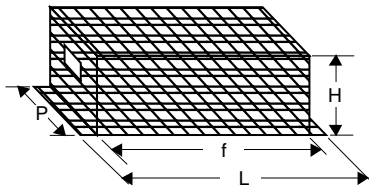

RF	Weight (kg)	Dimensions L x P x H (mm)	Mounting distance f (mm)
320 T	1.5	425 x 134 x 114	395
640 T	2.1	425 x 134 x 114	395
1000 T	3.6	565 x 224 x 180	535
2000 T	5.1	565 x 224 x 180	535
3500 T	7.5	565 x 370 x 180	535

• RF 5500 T to 55000 T

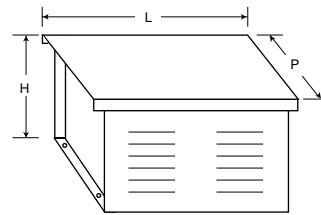

RF	L	P	H	Weight (kg)
5500 T	420	480	440	21
7500 T	500	480	440	25
11000 T	670	480	440	32
18500 T	960	480	440	53
22500 T	960	540	440	58
27500 T	860	480	690	66
37500 T	960	380	1150	77
55000 T	960	540	1150	105

7.4 - R.F.I. filters

These are used to reduce the electromagnetic emissions of the controllers and thus comply with the European standards EN-50081-2 over the whole available switching frequency range.

• Combination

UMV 4301	Filter reference	Motor cable length (m)
1.5T to 5.5T 1TL to 3.5TL	FLT 5101 - 10	1 to 100 WARNING : Do not use a longer motor cable than the maximum length defined by ratings in § 3.4.
8T to 11T 4.5TL to 5.5TL	FLT 5106 - 16	
16T 8TL	FLT 5106 - 25	
22T to 33T 11TL to 16TL	FLT 5113 - 50	
40T 22TL	FLT 5113 - 63	
50T 33TL	FLT 5113 - 100	
60T to 75T	FLT 5113 - 150	
100T to 120T	FLT 5113 - 180	

• Characteristics

Reference	FLT 5101-10	FLT 5106-16	FLT 5106-25	FLT 5113-50	FLT 5113-63	FLT 5113-100	FLT 5113-150	FLT 5113-180
Rated current (A)	10	16	25	50	63	100	150	180
Overload	150 % of In for 60s							
Supply voltage	200 to 480V 50-60Hz							
Phase/phase or phase/earth leakage current in steady state (mA) 480V 50Hz	31	31	35.5	31.0	29.0	48.5	48.5	31.0
Leakage current (μF)	1.7	1.7	2.0	1.7	1.5	2.4	2.4	1.7
Losses (W)	7.7	10.4	25.5	12.8	14.3	25.5	30.4	82.6
Enclosure protection	IP20							

UMV 4301

Open or closed loop speed controller for asynchronous and synchronous motors

• Dimensions

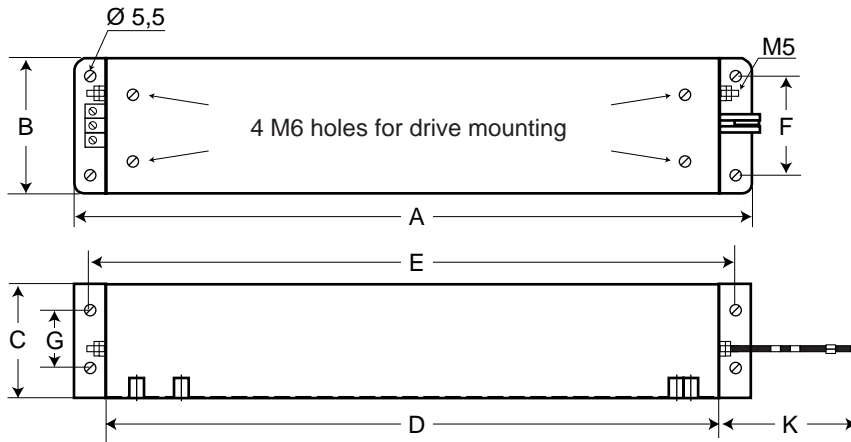

Filter reference	Dimensions (mm)								Weight (kg)
	A	B	C	D	E	F	G	K	
FLT 5101-10	390	85	68	364	380	60	35	300	2.05
FLT 5106-16	397	180	68	364	385	120	35	300	2.05
FLT 5106-25	397	180	68	364	385	120	35	300	2.05

FLT 5101-10 to FLT 5106-25 filters allow a 2 position mounting :

- on the drive right or left side,
- on the drive back side.

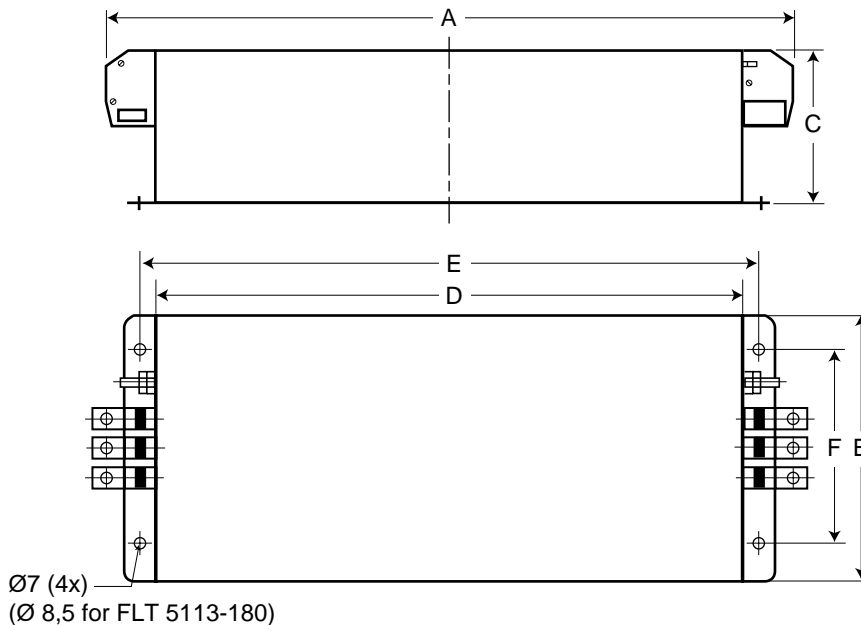

Filter reference	Dimensions (mm)						Weight (kg)
	A	B	C	D	E	F	
FLT 5113-50	337	90	100	259.5	275	50	3.8
FLT 5113-63	377	150	103	300	315	105	3.8
FLT 5113-100	380	150	107	294	310	105	7.8
FLT 5113-150	414	175	135	314	330	120	7.8
FLT 5113-180	523	170	157	400	420	110	15

UMV 4301

Open or closed loop speed controller for asynchronous and synchronous motors

7.5 - Three-phase motor chokes for attenuation of leakage currents : Self MC

These are wired directly to the controller output (terminal U, V, W) and help reduce leakage currents and interference.

They are cylindrical in shape and are fastened through a central untapped hole.

Self MC rating	UMV 4301 rating	Dimensions (mm)			Weight (kg)
		Diam	Height	Ø hole	
3.5T	1.5T to 3.5T 1TL to 2TL	80	50	5.1	0.5
11T	5.5T to 11T 3.5TL to 5.5TL	80	50	5.1	0.75
27T	16T to 27T 8TL to 11TL	125	55	6.2	1.9
50T	33T to 50T 16TL to 27TL	125	65	6.2	3
75T	60T to 75T	145	90	8.3	4.5
120T	100T to 120T	220	120	10 x 25	8

• Wiring

Self MC chokes are wired as close as possible to the controller, according to the diagram below.

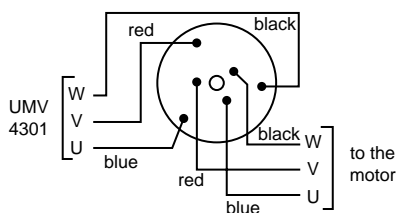

WARNING :

Self MC chokes are delivered with 30cm length cables.

7.6 - Motor and encoder ferrites for attenuation of leakage currents

For UMV 4301 1.5T to 16T supplying a motor with a cable length not exceeding 20m, it is possible to replace the Self MC chokes with 2 U, V and W cable runs in 2 ferrites ref. FRT 4200 mounted as close as possible to the controller.

• Dimensions

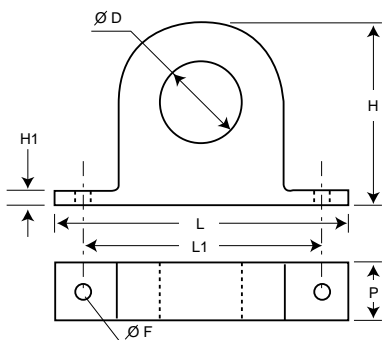

FRT 4200	H	H1	L	L1	P	ØF	ØD
Dimensions (mm)	62	5	105	90	24	5	28

• Connection

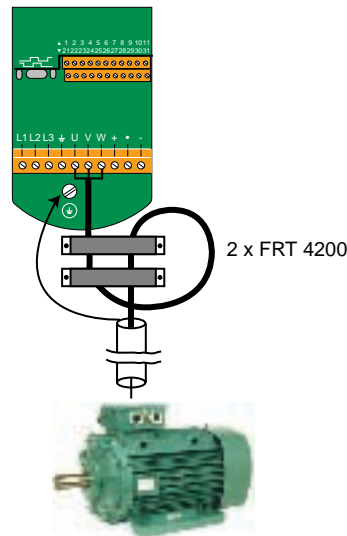

7.7 - INTERCOD 15 encoder connection interface

The INTERCOD 15 interface converts the 15-pin high density SUB-D encoder connector on the UMV 4301 controller to 15 flexible blade terminals.

It consists of one 1.5 m connection cable and an interface module which can be mounted on the outside of the controller, on a DIN or OMEGA rail.

The terminals on the interface are flexible blades and will take wires with cross-sections from 0.08 to 2.5 mm².

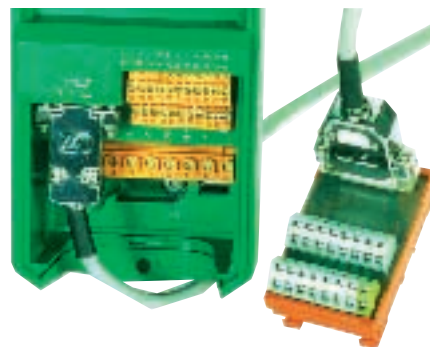

7.8 - UMVSOFT

Commissioning software UMVSOFT, developed on a windows platform, allows a user friendly drive setting with integrated help file. COM1-UMV option must be fitted when UMVSOFT is used.

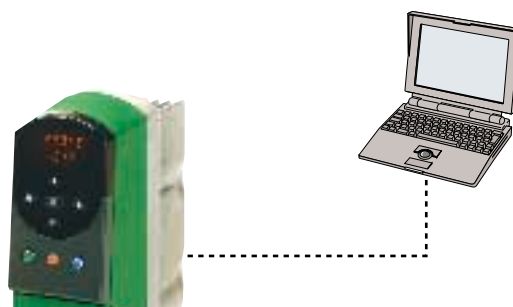

UMV 4301

Open or closed loop speed controller for asynchronous and synchronous motors

8 - SUMMARY OF SETTINGS FOR YOUR APPLICATION

UMV type	Rating	Software	Serial no.	Motor type	Motor no.	Option	Commissioning

Parameter	Description	Default setting	Setting date :	Setting date :
-----------	-------------	-----------------	----------------	----------------

Menu 0 parameters common to all configurations or Menu 0 configuration 1

0.00	Memorisation Return to default settings Selection of operating mode Code for access to other menus Selection of preset configurations	0		
0.01	Minimum speed limit	0		
0.02	Maximum speed limit	50 Hz		
0.03	Acceleration ramp	5.0s		
0.04	Deceleration ramp	10.0 s		
0.05	Selection of speed references	0		
0.06	Current limitation	150%		
0.07	Control mode	Ur1		
0.08	Starting torque (Boost)	3 %		
0.09	Selection of dynamic V/F	0		
0.32	Type of communication	0		
0.34	User security code	149		
0.35	Reference via keypad	0		
0.36	Serial link transmission speed	4800 Bauds		
0.37	Controller serial link address	1.1		
0.38	Parameter displayed at power-up	0.10		
0.39	Flying restart	0		
0.40	Autotune	0		
0.41	Switching frequency *	3 kHz		
0.42	Number of motor poles	4 poles		
0.43	Power factor (cos φ)	0.850		
0.44	Motor rated voltage	T : 400 V TL : 220V		
0.45	Motor rated speed	0		
0.46	Motor rated current	IN. CONTROLLER		
0.47	Motor rated frequency	50.0 Hz		
0.48	Controller operating mode	OPEN LP		

Other Menu 0 parameters, factory configuration

0.14	Jogging reference	1.5 Hz		
0.15	Selection of deceleration mode	Std.Ct		
0.16	Selection of stopping mode	rp		
0.17	Selection of torque control	0		
0.18	Linear ramp/S ramp selection	0		
0.19	S ramp curve	3.1 s ²		
0.20	Skip frequency 1	0		
0.21	Width of skip frequency 1	0.5 Hz		
0.22	Skip frequency 2	0		
0.23	Width of skip frequency 2	0.5 Hz		



UMV 4301

Open or closed loop speed controller for asynchronous and synchronous motors

Parameter	Description	Default setting	Setting date :	Setting date :
Other Menu 0 parameters, factory configuration (continued)				
0.24	Selection of type of signal for analogue input 1	Volt		
0.25	Selection of type of signal for analogue input 2	Volt		
0.26	Destination of analogue input 2	1.37		
0.27	Control logic polarity	0		
0.28	Current loop proportional gain	20		
0.29	Current loop integral gain	40		
0.30	Enable the keypad FWD/REV key	0		

Fault processing

6.02	Starting mode	diS		
6.03	Processing of micro-breaks	diS		
6.09	Flying restart	0		
10.34	Number of automatic resets	0		
10.35	Auto reset time delay	1		
10.36	Processing of fault relay	0		
10.37	Stopping mode on minor faults	0		

Parameters specific to Menu 0 Configuration 2









0.14	Jogging reference	1.5 Hz		
0.15	Selection of deceleration mode	Std.Ct		
0.16	Selection of stopping mode	rp		
0.17	Inversion of relay output	0		
0.18	Linear ramp/S ramp selection	0		
0.19	S ramp curve	3.1 s ²		
0.20	Skip frequency 1	0		
0.21	Width of skip frequency 1	0.5 Hz		
0.22	Skip frequency 2	0		
0.23	Width of skip frequency 2	0.5 Hz		
0.24	Selection of type of signal for analogue input 1	Volt		
0.25	Manual reset of faster / slower command reference	0		
0.27	Selection of automatic reset of faster / slower command reference	0		
0.28	Selection of the polarity of the faster / slower reference	0		
0.29	Ramp time of the faster / slower command reference	20s		
0.30	Scaling of the faster / slower command reference	1.000		

Parameters specific to Menu 0 Configuration 3

0.14	Jogging reference	1.5 Hz		
0.15	Selection of deceleration mode	Std.Ct		
0.16	Selection of stopping mode	rp		
0.17	Inversion of relay output	0		
0.18	Linear ramp/S ramp selection	0		
0.19	S ramp curve	3.1 s ²		
0.20	Skip frequency 1	0		
0.21	Width of skip frequency 1	0.5 Hz		
0.22	Skip frequency 2	0		

UMV 4301





Open or closed loop speed controller for asynchronous and synchronous motors

Parameter	Description	Default setting	Setting date :	Setting date :
Parameters specific to Menu 0 Configuration 3 (continued)				
0.23	Width of skip frequency 2	0.5 Hz		
0.24	Selection of type of signal for analogue input 1	Volt		
0.25	Preset speed 1	0		
0.26	Preset speed 2	-		
0.27	Preset speed 3	0		
0.28	Preset speed 4	0		
Parameters specific to Menu 0 Configuration 4				
0.14	Jogging reference	1.5 Hz		
0.15	Selection of deceleration mode	Stnd.Ct		
0.16	Selection of stopping mode	rp		
0.17	Inversion of relay output	0		
0.18	Linear ramp/S ramp selection	0		
0.19	S ramp curve	3.1 s ²		
0.20	Skip frequency 1	0		
0.21	Width of skip frequency 1	0.5 Hz		
0.22	Skip frequency 2	0		
0.23	Width of skip frequency 2	0.5 Hz		
0.24	Selection of type of signal on analogue input 1	Volt		
0.26	Selection of type of signal on analogue input 2	Volt		
0.28	 : Max. frequency threshold  &  : Overspeed threshold	1000.0 Hz 4000 min ⁻¹		
Parameters specific to Menu 0 Configuration 5				
0.14	Selection of type of signal on analogue input 1	Volt		
0.15	Selection of type of signal on analogue input 2	Volt		
0.16	Selection of type of signal on analogue input 3	Volt		
0.20	PID controller proportional gain	1.000		
0.21	PID controller integral gain	0.5		
0.22	PID controller derivative gain	0		
0.23	PID output upper limit	100.0 %		
0.24	PID output lower limit	- 100.0 %		
0.25	Scaling of the PID output	1.000		
0.28	Scaling of analogue input 2	1.000		
0.29	Scaling of analogue input 3	1.000		
0.30	Additional condition : enable PID control	0.00		
Parameters specific to Menu 0 Configuration 6				
0.18	Selection of stopping mode	 &  1  2		
0.19	Standstill torque	 &  0  1		
0.20	Special deceleration ramp	1.0		
0.21	Inversion of forward limit switch input	0		
0.22	Inversion of reverse limit switch input	0		



UMV 4301

Open or closed loop speed controller for asynchronous and synchronous motors

Parameter	Description	Default setting	Setting date :	Setting date :
Parameters specific to Menu 0 Configuration 7				
0.19	Brake release current threshold	10.0 %		
0.20	Brake release time delay	0.2s		
Parameters specific to Menu 0 Configuration 8				
0.14	Jogging reference	50 min ⁻¹		
0.15	Synchronization mode	1		
0.16	Number of points per rev. encoder feedback	 : 1024		
		 : 4096		
0.17	Synchronization ratio	1.000		
0.23	Number of points per rev. reference encoder	1024		
0.24	Position loop gain	1.000		
0.25	Limitation of position correction speed	150 min ⁻¹		
0.26	Indexing reference	0		
0.27	End of indexing signalling window	$\frac{20}{4095}$ rev.		
0.28	Selection of stopping mode	 : 1		
		 : 2		

UMV 4301
Open or closed loop speed
controller for asynchronous and
synchronous motors

NOTES

Notes



0447-0400



MOTEURS LEROY-SOMER 16015 ANGOULÊME CEDEX - FRANCE

RCS ANGOULÊME N° B 671 820 223
S.A. au capital de 131 910 700 F

<http://www.leroy-somer.com>

	TECHNICAL NOTIFICATION	Classification : UMV4301	
	UPDATES OF THE MANUAL UMV4301 Installation and maintenance ref. 2415GB – 4.33	Révision : A of : 19/04/01	Page 1 of 1 Chap : 9
DEPARTEMENT D.E.I.		<i>Type Document : T412-2 T004</i>	

Version	Updates	Paragraphs
a - 11.99	<ul style="list-style-type: none"> • Initial revision 	
b - 06.98	<ul style="list-style-type: none"> • Updated according to the French version ref.2321 (d-10.96) 	
c - 03.01	<ul style="list-style-type: none"> • Updated according to the French version ref.2321 (f-01.99 to h-06.00) • Modification of the drive software version • Correction of the rating of the 22kW 230V: modified in 33TL instead of 27TL • Correction of the encoder channels 	Page 2 1.3.2-1.3.3-1.4-3.3.1-3.4- 3.6.6-3.6.7-7.3.1-7.4-7.5 3.1.2.2