

8LS Three-phase Synchronous Motors User's Manual

Perfection in Automation
www.br-automation.com





8LS Three-phase Synchronous Motors

User's Manual

Version: **1.0 (Aug. 2005)**

Model No.: **MAMOT2-E**

We reserve the right to change the contents of this manual without warning. The information contained herein is believed to be accurate as of the date of publication; however, Bernecker + Rainer Industrie-Elektronik Ges.m.b.H. makes no warranty, expressed or implied, with regards to the products or the documentation contained within this book. In addition, Bernecker + Rainer Industrie-Elektronik Ges.m.b.H. shall not be liable in the event of incidental or consequential damages in connection with or resulting from the furnishing, performance, or use of these products. The software names, hardware names, and trademarks used in this document are registered by the respective companies.



Chapter 1: General Information

Chapter 2: Technical Data

Chapter 3: Installation

Chapter 4: Wiring

Chapter 5: Standards and Certifications

Figure Index



Table Index

Index

Model Number Index



Chapter 1: General Information	11
1. 8LS Three-phase Synchronous Motors	11
1.1 Feedback Systems Specified to Meet your Needs	12
1.2 Embedded Parameter Chip	13
1.3 Smooth Surface	13
1.4 Connection Technology	14
1.5 Custom Configurations	14
2. Safety Guidelines	15
2.1 General Information	15
2.2 Intended Use	16
2.3 Transport and Storage	16
2.4 Installation	16
2.5 Operation	17
2.5.1 Protection against Touching Electrical Parts	17
2.5.2 Protection from Dangerous Movements	18
2.5.3 Protection from Burns	19
2.6 Organization of Safety Notices	19
Chapter 2: Technical Data	21
1. 8LS Three-phase Synchronous Motors	21
1.1 General Description	21
1.1.1 Cooling Types	22
1.1.2 Sizes	22
1.1.3 Lengths	22
1.2 Motor Encoder Systems	23
1.2.1 EnDat Encoder	23
1.2.2 Resolver	24
1.3 Motor Options	25
1.3.1 Rated Speed	25
1.3.2 Oil Seal	26
1.3.3 Holding Brake	26
1.3.4 Type of Shaft End	27
1.3.5 Load Capacity of the Shaft End and Bearing	28
1.3.6 Connection Direction	31
1.3.7 Determining the Order Code for Motor Options (ff)	32
1.4 Special Motor Options	33
1.4.1 "Reinforced A side bearing" (in preparation)	33
1.5 Order Key	34
1.5.1 Example Order 1	35
1.5.2 Example Order 2	35
1.6 General Motor Data	36
1.7 Terminology and Formula Symbols	38
1.7.1 Connection Direction, Bearing	38
1.7.2 Definitions for Maximum Shaft Load Diagrams	38
1.7.3 Formula Symbols	39
1.8 Motor Data Overview Cooling Type A	41

Table of contents

1.9 Motor Data 8LSA2	47
1.9.1 Technical Data	47
1.9.2 Speed-Torque Characteristic Curves with 400 VAC Supply Voltage	48
1.9.3 Speed-Torque Characteristic Curves with 230 VAC Supply Voltage	50
1.9.4 Dimensions	52
1.9.5 Maximum Shaft Load	53
1.10 Motor Data 8LSA3	54
1.10.1 Technical Data	54
1.10.2 Speed-Torque Characteristic Curves with 400 VAC Supply Voltage	55
1.10.3 Speed-Torque Characteristic Curves with 230 VAC Supply Voltage	57
1.10.4 Dimensions	59
1.10.5 Maximum Shaft Load	60
1.11 Motor Data 8LSA4	61
1.11.1 Technical Data	61
1.11.2 Speed-Torque Characteristic Curves with 400 VAC Supply Voltage	62
1.11.3 Speed-Torque Characteristic Curves with 230 VAC Supply Voltage	64
1.11.4 Dimensions	66
1.11.5 Maximum Shaft Load	67
1.12 Motor Data 8LSA5	68
1.12.1 Technical Data	68
1.12.2 Speed-Torque Characteristic Curves with 400 VAC Supply Voltage	69
1.12.3 Speed-Torque Characteristic Curves with 230 VAC Supply Voltage	71
1.12.4 Dimensions	74
1.12.5 Maximum Shaft Load	75
1.13 Motor Data 8LSA6	76
1.13.1 Technical Data	76
1.13.2 Speed-Torque Characteristic Curves with 400 VAC Supply Voltage	77
1.13.3 Speed-Torque Characteristic Curves with 230 VAC Supply Voltage	79
1.13.4 Dimensions	81
1.13.5 Maximum Shaft Load	82
1.14 Motor Data 8LSA7	83
1.14.1 Technical Data	83
1.14.2 Speed-Torque Characteristic Curves with 400 VAC Supply Voltage	84
1.14.3 Speed-Torque Characteristic Curves with 230 VAC Supply Voltage	85
1.14.4 Dimensions	87
1.14.5 Maximum Shaft Load	88
1.15 Motor Data 8LSA8	89
1.15.1 Technical Data	89
1.15.2 Speed-Torque Characteristic Curves with 400 VAC Supply Voltage	90
1.15.3 Speed-Torque Characteristic Curves with 230 VAC Supply Voltage	92
1.15.4 Dimensions	94
1.15.5 Maximum Shaft Load	95
2. Cables	96
2.1 General Information	96
2.1.1 Prefabricated Cable	96
2.2 Motor Cables	97
2.2.1 Order Data	97

2.2.2 Technical Data	99
2.3 EnDat Cables	101
2.3.1 Order Data	101
2.3.2 Technical Data	101
2.4 Resolver Cables	103
2.4.1 Order Data	103
2.4.2 Technical Data	103
3. Connectors	105
3.1 General Information	105
3.2 Motor Connectors	106
3.2.1 Order Data	106
3.2.2 Technical Data for 8PM001.00-1 and 8PM002.00-1	107
3.2.3 Technical Data for 8PM003.00-1	108
3.3 Encoder Connectors	109
3.3.1 Order Data	109
3.3.2 Technical Data for EnDat Connector 8PE001.00-1	110
3.3.3 Technical Data for Resolver Connector 8PR001.00-1	111

Chapter 3: Installation 113

1. General Information	113
1.1 Mounting Drive Elements	113
1.2 Connection Plugs	114
2. Detailed Dimensions	115
2.1 Detailed Dimensions for "Top" Connection Direction	115
2.1.1 Motor Connector	115
2.1.2 Encoder Connection	115
2.2 Detailed Dimensions for "Swiveling" Connection Direction	116
2.2.1 Motor Connector	116
2.2.2 Encoder Connection	117
2.3 Outer Dimensions of the Connectors	117

Chapter 4: Wiring 119

1. 8LS Connection Assignments	119
1.1 Motor Cable Connection	120
1.1.1 8LSA2...8LSA7	120
1.1.2 8LSA8	120
1.2 Encoder Cable Connection	121
1.2.1 EnDat	121
1.2.2 Resolver	121
2. Cables	122
2.1 Motor Cables	122
2.1.1 Motor Cable Construction	122
2.1.2 Pin Assignments for 8CMxxx.12-1, 8CMxxx.12-3	123
2.1.3 Cable Schematic for 8CMxxx.12-1, 8CMxxx.12-3	123
2.1.4 Pin Assignments for 8CMxxx.12-5	124
2.1.5 Cable Schematic for 8CMxxx.12-5	124

Table of contents

2.2 EnDat Encoder Cables	125
2.2.1 EnDat Encoder Cable Construction	125
2.2.2 Pin Assignments	125
2.2.3 Cable Schematic	126
2.3 Resolver Cables	127
2.3.1 Resolver Cable Construction	127
2.3.2 Pin Assignments	127
2.3.3 Cable Schematic	128

Chapter 5: Standards and Certifications 129

1. Valid European Guidelines	129
2. Valid Standards for Servo Motors	129
3. International Certifications	130
4. Standards, Definitions for Safety Techniques	131

Chapter 1 • General Information

1. 8LS Three-phase Synchronous Motors

B&R 8LS three-phase synchronous motors have been specially developed for use in high-performance applications. They are now being used to produce consumer goods and products in the plastic, packaging, metal, food and beverage industries and then palletize them with material handling systems.

Complete solutions from one source, this requires the right components as well as the right configuration for the application environment. The large selection of available 8LS three-phase synchronous motors makes it possible to easily meet conditions such as reducing the variety of parts, guaranteeing ease of service and maintaining minimum requirements on space.

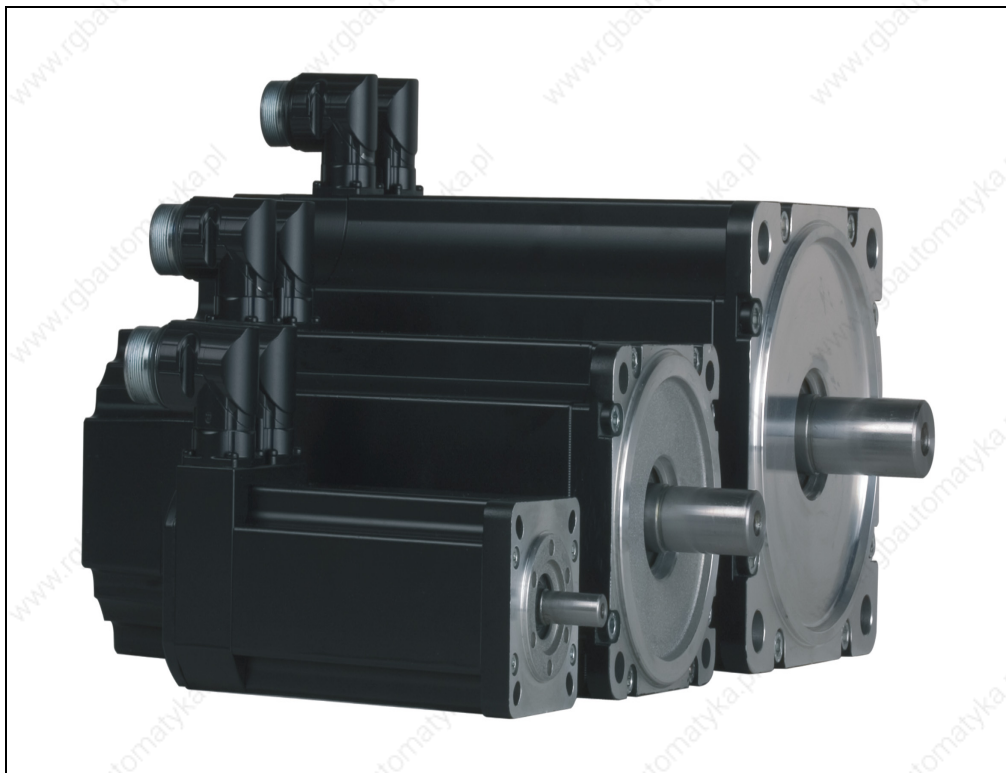

Figure 1: 8LS Three-phase synchronous motors

An optimally configured drive rounds off a successful design. To meet this goal, specialists are available in B&R subsidiaries all over the world who are eager to share their know-how in the area of mechatronics.

B&R automation components, the economical combination of mechanics, electronics, technology and innovation.

1.1 Feedback Systems Specified to Meet your Needs

The 8LS three-phase synchronous motors are available with different encoder systems. As standard, they are equipped with Heidenhain EnDat encoders. Depending on the application, the customer can select between normal and high-resolution encoders. Both types are also available as multi-turn encoders. They allow operation without requiring homing procedures or additional measurement systems on the work piece. The absolute encoder functions without a battery and is therefore absolutely maintenance free.

The 8LS three-phase synchronous motors are also available with resolvers for machines with lower precision and speed requirements.

1.2 Embedded Parameter Chip

All relevant mechanical and electrical information and data is stored in the encoder used for the 8LS three-phase synchronous motors. This means that the user doesn't have to make settings on the servo drive in the field. As soon as the encoder is connected to the servo drive and the power is applied to the electronics, the motor is automatically identified. The motor sends the rated and limit parameters to the servo drive. Then the drive automatically determines the current limits and current control parameters required for optimal control of the motor. The user only has to optimize the speed and position controller. The integrated start-up environment in B&R Automation Studio™ provides assistance.

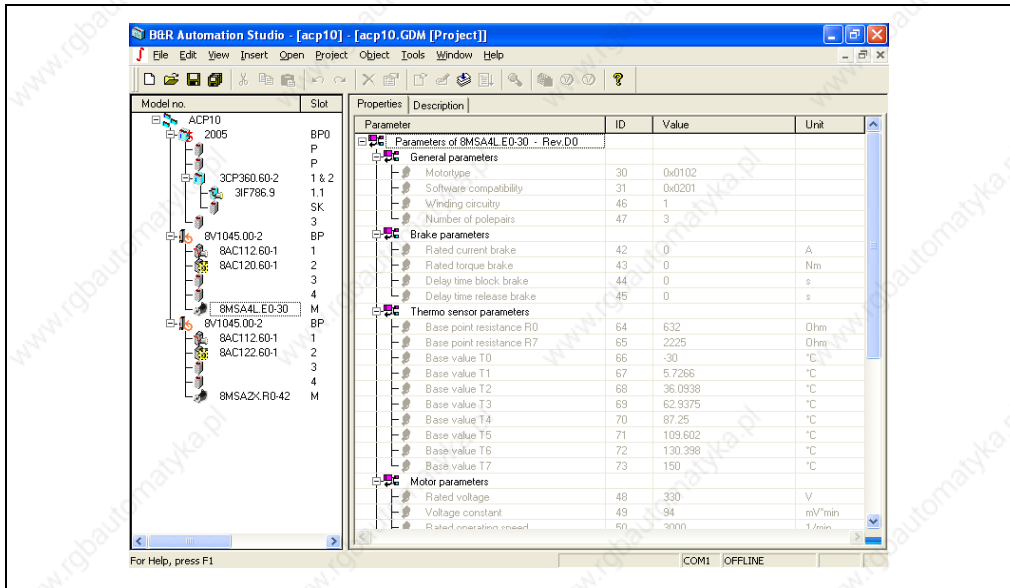

Figure 2: Start-up with B&R Automation Studio™

In addition to start-up assistance, routine service work is also made easier and motors can be exchanged without having to take extra time to set parameters.

1.3 Smooth Surface

The special construction of the surface of the 8LS three-phase synchronous motors allow them to be used in applications for the food and beverage branch. Depressions where liquid could collect were deliberately avoided.

1.4 Connection Technology

The uniform connection technology, the prefabricated cables and the embedded parameter chip described above allow plug and play operation of the power transmission system.

The angled connectors can be swiveled, which provides the maximum amount of flexibility during cabling.

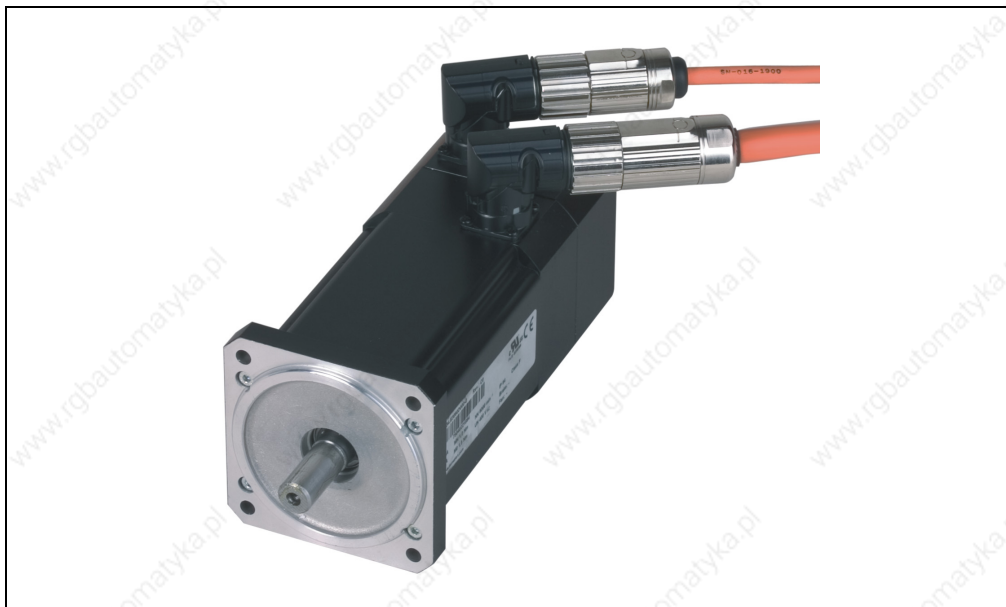

Figure 3: Swivel connectors

1.5 Custom Configurations

B&R has already developed successful projects where a custom drive configuration was required. An example is direct attachment of a pulley to the motor shaft. Using bearings that withstand the high radial forces required by the construction allows the motor and belt drive to be easily installed. High-alloy steel is used to keep the shaft diameter small for trouble free mounting of small belt disks (in spite of heavy loads).

An enthusiastic customer hit the nail on the head: "We are killing two birds with one stone by using this solution. Easier design, smaller installation dimensions, exemplary friendly service and all that with lower costs!".

2. Safety Guidelines

Information:

The following safety guidelines are valid for servo motors and servo drives with regard to uniform handling independent of the manual where they are listed.

2.1 General Information

B&R servo drives and servo motors have been designed, developed and manufactured for conventional use in industry. They were not designed, developed and manufactured for any use involving serious risks or hazards that could lead to death, injury, serious physical damage, or loss of any kind without the implementation of exceptionally stringent safety precautions. Such risks include in particular the use of these devices to monitor nuclear reactions in nuclear power plants, as well as flight control systems, flight safety, the control of mass transportation systems, medical life support systems, and the control of weapons systems.

Danger!

Servo drives and servo motors can have bare parts with voltages applied (e.g. terminals) or hot surfaces. Additional sources of danger result from moving machine parts. Improperly removing the required covers, inappropriate use, incorrect installation or incorrect operation can result in severe personal injury or damage to property.

All tasks, such as transport, installation, commissioning and service, are only permitted to be carried out by qualified personnel. Qualified personnel are persons familiar with transport, mounting, installation, commissioning and operation of the product and have the respective qualifications (e.g. IEC 60364). National accident prevention guidelines must be followed.

The safety guidelines, connection descriptions (type plate and documentation), and limit values listed in the technical data are to be read carefully before installation and commissioning and must be observed.

Danger!

Handling servo drives and servo motors incorrectly can cause severe personal injury or damage to property!

2.2 Intended Use

Servo drives are components designed to be installed in electrical systems or machines. They are not being used as intended unless the machine meets EG regulation 98/37/EG (machine regulation) as well as regulation 89/336/EWG (EMC regulation).

Servo drives are only permitted to be operated directly on grounded, three-phase industrial mains (TN, TT power mains). When using them in living areas, shops and small businesses, additional filtering measures must be implemented by the user.

Danger!

Servo drives are not permitted to be operated directly on IT and TN-S mains with a grounded phase conductor and protective ground conductor!

The technical data as well as the values for connection and environmental specifications can be found on the type plate and in the user's manual. The connection and environmental specifications must be met!

Danger!

Electronic devices are generally not failsafe. If the servo drive fails, the user is responsible for making sure that the motor is placed in a secure state.

2.3 Transport and Storage

During transport and storage, devices must be protected from excessive stress (mechanical load, temperature, humidity, aggressive atmosphere, etc.).

Servo drives contain components sensitive to electrostatic charges which can be damaged by inappropriate handling. It is therefore necessary to provide the required safety precautions against electrostatic discharges during installation or removal of servo drives.

2.4 Installation

The installation must take place according to the user's manual using suitable equipment and tools.

Devices may only be installed without voltage applied and by qualified personnel. Before installation, voltage to the switching cabinet should be switched off and prevented from being switched on again.

The general safety regulations and national accident prevention guidelines (e.g. VBG 4) must be observed when working with high voltage systems.

Electrical installation must be carried out according to the relevant guidelines (e.g. line cross section, fuse, protective ground connection).

2.5 Operation

2.5.1 Protection against Touching Electrical Parts

Danger!

To operate servo drives, it is necessary that certain parts are carrying voltages over 42 VDC. A life-threatening electrical shock could occur if you come into contact with these parts. This could result in death, severe injury, or material damage.

Before turning on a servo drive, make sure that the housing is properly connected to ground (PE rail). The ground connection must be made, even when testing the servo drive or when operating it for a short time!

Before turning the device on, make sure that all voltage-carrying parts are securely covered. During operation, all covers and switching cabinet doors must remain closed.

Control and high power contacts can have voltage applied, even when the motor is not turning. Touching the contacts when the device is switched on is not permitted.

Before working on servo drives, they must be disconnected from the power mains and prevented from being switched on again.

Danger!

After switching off the servo drive, wait until the DC bus discharge time of at least five minutes has passed. The voltage currently on the DC bus must be measured between -DC1 and +DC1 with a suitable measuring device before beginning work. This voltage must be less than 42 V DC to rule out danger. The Run LED going out does not indicate that voltage is not present on the device!

The servo drives are labeled with the following warning:

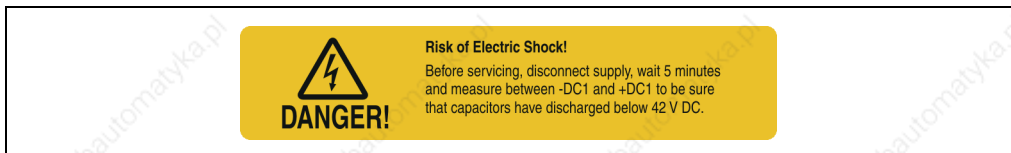

Figure 4: Warning on the servo drives

The connections for the signal voltages (5 to 30 V) found on the servo drives are isolated circuits. Therefore, the signal voltage connections and interfaces are only permitted to be connected to devices or electrical components with sufficient isolation according to IEC 60364-4-41 or EN 50178.

Never remove the electrical connections from the servo drive with voltage applied. In unfavorable conditions, arcs can occur causing personal injury and damage to contacts.

2.5.2 Protection from Dangerous Movements

Danger!

Incorrect control of motors can cause unwanted and dangerous movements! Such incorrect behavior can have various causes:

- **Incorrect installation or an error when handling the components**
- **Incorrect or incomplete wiring**
- **Defective devices (servo drive, motor, position encoder, cable, brake)**
- **Incorrect control (e.g. caused by software error)**

Some of these causes can be recognized and prevented by the servo drive using internal monitoring. However, it is generally possible for the motor shaft to move every time the device is switched on! Therefore protection of personnel and the machine can only be guaranteed using higher level safety precautions.

The movement area of machines must be protected to prevent accidental access. This type of protection can be obtained by using stable mechanical protection such as protective covers, protective fences, protective gates or photocells.

Removing, bridging or bypassing these safety features and entering the movement area is prohibited.

A sufficient number of emergency stop switches are to be installed directly next to the machine. The emergency stop equipment must be checked before commissioning the machine.

Remove shaft keys on free running motors or prevent them from being catapulted.

The holding brake built into the motors cannot prevent hoists from allowing the load to sink.

2.5.3 Protection from Burns

The surfaces of servo drives and servo motors can become very hot during operation.

Therefore, the servo drives are labeled with the following warning:



Figure 5: "Hot surface" warning

Information:

A "hot surface" warning sticker is provided with the servo motors. It must be applied so that it can be seen at any time after the motor has been mounted.

2.6 Organization of Safety Notices

The safety notices in this manual are organized as follows:

Safety notice	Description
Danger!	Disregarding the safety regulations and guidelines can be life-threatening.
Warning!	Disregarding the safety regulations and guidelines can result in severe injury or major damage to material.
Caution!	Disregarding the safety regulations and guidelines can result in injury or damage to material.
Information:	Important information for preventing errors.

Table 1: Description of the safety notices used in this manual

Chapter 2 • Technical Data

1. 8LS Three-phase Synchronous Motors

1.1 General Description

The three-phase synchronous motors from the 8LS series are permanently excited, electronically commutated synchronous motors for applications that require excellent dynamic characteristics and positioning precision as well as compact size and reduced weight.

- NdFeB permanent magnets
- Sinusoidal commutation with EnDat encoder or resolver as feedback unit
- Three-phase winding with star connection
- Compact sizes result in low weight
- Minimum moment of inertia because of favorable rotor construction results in very good dynamic properties
- High overload capability/peak torque
- Low torque ripple
- High dynamic torque at high speeds
- Long life-span, all motor parts except for bearings are free of wear
- Direct diversion of lost power generated in the stator over the housing to the flange
- Preloaded, grooved ball bearings which are sealed on both sides and greased
- Complete motor system with stall torque ranging from 0.2 Nm to 115 Nm
- Connection using two circular plugs
- Controlled by ACOPOS servo drives

Warning!

8LS three-phase synchronous motors are not permitted to be connected directly to the power mains, they are only permitted to be operated in combination with ACOPOS servo drives!

Warning!

High temperatures can occur on the surface of the 8LS three-phase synchronous motors ($> 100\text{ °C}$). If necessary, protection against accidental contact should be installed!

1.1.1 Cooling Types

Cooling Type A

8LS three-phase synchronous motors with cooling type A are self-cooling and have a long, slim design. The motors must be installed on the cooling surface (= flange).

Caution!

Free convection on the motor housing must be guaranteed!

1.1.2 Sizes

The 8LS three-phase synchronous motors are available in seven different sizes (2 to 8). They are different regarding dimensions (especially flange dimensions) and power rating.

The various sizes can be differentiated by a number (c) in the model number. The larger the number, the larger the flange dimensions and power rating for the respective motor.

1.1.3 Lengths

The 8LS three-phase synchronous motors are available in up to five different lengths. They have different power ratings with identical flange dimensions.

The various lengths can be differentiated by a number (d) in the model number.

Overview

Length		Available for Size						
Code	Description	2	3	4	5	6	7	8
3	Small rated torque	Yes	Yes	Yes	Yes	Yes	Yes	Yes
4	Medium rated torque	Yes	Yes	Yes	Yes	Yes	Yes	Yes
5	Large rated torque	Yes	Yes	Yes	Yes	Yes	Yes	Yes
6	Extra large rated torque	Yes	Yes	Yes	Yes	Yes	---	Yes
7	Exceptionally large rated torque	---	---	---	Yes	---	---	---

Table 2: Available lengths

1.2 Motor Encoder Systems

The 8LS three-phase synchronous motors are available with EnDat encoders and also with resolvers. The encoder system is listed as part of the model number in the form of a 2-digit code (ee).

1.2.1 EnDat Encoder

General Information

EnDat is a standard developed by Johannes Heidenhain GmbH (www.heidenhain.de), incorporating the advantages of absolute and incremental position measurement and also offers a read/write parameter memory in the encoder. With absolute position measurement (absolute position is read in serially), the homing procedure is usually not required. When necessary, a multi-turn encoder (4096 revolutions) should be installed. To save costs, a single-turn encoder and a reference switch can also be used. In this case, a homing procedure must be carried out.

The incremental process allows the short delay times necessary for position measurement on drives with exceptional dynamic properties. With the sinusoidal incremental signal and the fine resolution in the EnDat module, a very high positioning resolution is achieved in spite of the moderate signal frequencies used.

Technical Data

Different types of EnDat encoders can be used depending on the requirements:

Description	Order Code (ee)					
	E0 ¹⁾	E1 ¹⁾	E2 ²⁾	E3 ²⁾	E4 ³⁾	E5 ³⁾
Encoder Type	EnDat single-turn	EnDat multi-turn	EnDat single-turn	EnDat multi-turn	EnDat single-turn	EnDat multi-turn
Resolution	512 line		32 line		512 line	
Recognizable Revolutions	---	4096	---	4096	---	4096
Precision	±60"		±400"		±60"	
Frequency Limit	≥ 100 kHz (-3 dB)		≥ 6 kHz (-3 dB)		≥ 200 kHz (-3 dB)	
Manufacturer Internet Address	Dr. Johannes Heidenhain GmbH www.heidenhain.de					
Manufacturer's Product ID	ECN1313	EQN1325	ECl1317	EQI1329	ECN1113	EQN1125

Table 3: Technical data for EnDat encoders

- 1) Only available for size 3 to 8 motors.
- 2) Only available for size 3 to 7 motors.
- 3) Only available for size 2 motors.

1.2.2 Resolver

General Information

BRX type resolvers are used in the servo motors. These resolvers are fed with a single sinusoidal signal (reference signal) and deliver two sinusoidal signals as the result. The amplitude of these signals change with the angular position (sine or cosine form).

Technical Data

Description	Order Code (ee) R0
Precision	± 10 angular minutes
Non-linearity	±1 angular minute

Table 4: Technical data for the resolver

1.3 Motor Options

Depending on the size and length, the 8LS three-phase synchronous motors can be delivered

- with various rated speeds
- with or without oil seal
- with or without holding brake
- with a smooth shaft or a keyed shaft
- with two different connection directions.

The rated speed is listed as part of the model number in the form of a 3-digit code (nnn). The code represents the rated speed divided by 100.

The respective combination of other motor options is listed in the form of a 2-digit code (ff) as part of the model number (see section 1.3.7 "Determining the Order Code for Motor Options (ff)" on page 32).

1.3.1 Rated Speed

The 8LS three-phase synchronous motors can be delivered with up to four different rated speeds depending on the size and length. ¹⁾

Size	Available rated speeds n_N [min ⁻¹]																			
	2000			3000				4500				6000								
2	---			---				---				Yes			---					
3	---			Yes		---		Yes		---		Yes			---					
4	---			Yes		---		Yes		---		Yes			---					
5	---			Yes				Yes				---								
6	---			Yes		---		Yes		---		---								
7	---			Yes		---		Yes		---		---								
8	---	Yes		---	Yes		---		---				---							
Length	3	4	5	6	7	3	4	5	6	7	3	4	5	6	7	3	4	5	6	7

Table 5: Rated speeds available according to size and length

1) Other windings/rated speeds are possible after arrangements have been made with B&R.

1.3.2 Oil Seal

All 8LS three-phase synchronous motors are available with an optional form A oil seal according to DIN 3760.

When equipped with an oil seal, the motors have IP65 protection according to IEC 60034-5.

Information:

Proper lubrication of the oil seal must be guaranteed throughout the entire lifespan of the motor.

1.3.3 Holding Brake

All 8LS three-phase synchronous motors can be delivered with a holding brake. It is installed directly behind the A flange on the motor and is used to hold the motor shaft when no power is applied to the servo motor.

Functionality

The holding brake is controlled by the ACOPOS servo drive. It uses permanent magnets that are demagnetized when 24 VDC is applied to a magnet winding. This releases the brake.

The brake is designed as a holding brake. It is not permitted to be used for operational braking! If these conditions are met, the brake has a lifespan of approximately 5,000,000 cycles (opening and closing the brake again is one cycle).

Loaded braking during an emergency stop is permitted - but reduces the lifespan.

Information:

The required brake holding torque is determined based on the occurring load torque. If the load torque is not sufficiently known, it is recommended to assume a safety factor of 2.

Warning!

The holding brake is not intended for normal braking. The holding brake does not provide protection for personnel. The maximum motor torque far exceeds the holding torque.

Technical data for the standard holding brake

Description	Size of Motor						
	2	3	4	5	6	7	8
Holding Torque M_{Br} [Nm]	2.2	3.2	8	15	32		130
Installed Load P_{on} [W]	8	12	18	24	26		50
Highest Speed n_{max} [min ⁻¹]	12000	10000	10000	10000	10000	8000	8000
Installed Current I_{on} [A]	0.33	0.5	0.75	1	1.08		2.08
Installed Voltage U_{on} [V]	24 VDC +6 % / -10 %						
Activation Delay t_{on} [ms]	28	29	40	50	90		190
Release Delay t_{off} [ms]	14	19	7	10	22		65
Moment of Inertia J_{Br} [kgcm ²]	0.12	0.38	0.54	1.66	5.85		53
Weight m_{Br} [kg]	0.19	0.3	0.46	0.9	1.6		5.35

Table 6: Technical data for the standard holding brake

Warning!

If the holding brake is not used regularly for a long period of time, we recommend to periodically check the holding brake because the holding brake could fail in certain environmental conditions (e.g. humidity, oil vapor).

1.3.4 Type of Shaft End

All 8LS three-phase synchronous motor shafts comply to DIN 748. They can be delivered with a smooth shaft or a keyed shaft.

Smooth Shaft

A smooth shaft end is used for a force-fit shaft-hub connection that guarantees a zero-play connection between shaft and hub as well as smooth operation.

Information:

For connection of pinion gears, belt disks or similar drive elements, please use suitable clamping sets, pressure sleeves or other fastening elements.

Drive elements must be protected against unintentional removal.

The end of the shaft has a threaded center hole which can be used to remove drive elements.

Keyed Shaft

The keyed shaft can be used for a form-fit torque transfer with low demands on the shaft-hub connection and for handling torques with a constant direction.

The keyways for the 8LS three-phase synchronous motors conform to keyway form N1 according to DIN 6885-1. Form A shaft keys that conform to DIN 6885-1 are used. Balancing motors with keyways is done using the half-key convention according to DIN ISO 8821.

The end of the shaft has a threaded center hole which can be used to mount drive elements with shaft end disks.

Caution!

The shaft key can be deflected during heavy reverse operation. In extreme cases, this can cause the shaft end to break!

Smooth shaft ends should be used preferably.

1.3.5 Load Capacity of the Shaft End and Bearing

The 8LS three-phase synchronous motors are equipped with grooved ball bearings which are sealed on both sides and greased.

Caution!

To ensure proper lubrication of the grooved ball bearings after long storage times, the motor shaft must be turned a few revolutions manually at least every 2 years.

The radial and axial forces (F_r , F_a) that occur on the shaft end during operation and installation must be within the specifications listed below.

The bearing elements are not permitted to be subject to shocks or impacts! Incorrect handling will cause the lifespan of the bearings to be reduced or the bearing to be damaged.

Mounting

The axial forces F_a permitted during the installation of gearboxes, pinion gears, couplings, etc. depend on the motor size and can be found in the following table:

Motor Size	Permitted Axial Force F_a [N]	
	Standard Bearing	Special Motor Option "Reinforced A Side Bearing"
2	850	---
3	1400	---
4	2300	5050
5	2500	9500
6	2500	9500
7	5500	---
8	9500	18700

Table 7: Axial forces permitted during installation

Danger!

Because of the high axial forces on the motor shaft during installation, the bearings could be damaged and the operation of the motor holding brake could be so heavily influenced that it has no or only a reduced braking effect. Encoder errors could also occur.

Therefore, excessive pressure or shocks to the front shaft end or the rear housing cover should be avoided at all costs.

Loads caused by a hammer definitely exceed the permissible values!

Operation

Radial Force

The radial force F_r on the shaft end is made up of the installation forces (e.g. belt tension on pulleys) and operational forces (e.g. load torque on the pinion). The maximum radial force F_r depends on the shaft end type, bearing type, average speed, position where the radial force is applied and the desired lifespan of the bearings.

Warning!

Excessive radial force can cause premature wear on the bearings or, in extreme cases, can cause the shaft end to break.

Caution!

When installing drive elements on the motor shaft, avoid a hyperstatic arrangement of the motor shaft bearings. The tolerances that occur cause additional force on the motor shaft bearings.

This can significantly reduce the bearing's lifespan or damage the bearing!

Axial Force, Shift in Shaft Position caused by Axial Force

The axial force F_a on the shaft end is made up of the installation forces (e.g. stress caused by installation) and operational forces (e.g. thrust caused by slanted tooth pinions). The maximum axial force F_a depends on the bearing type and the desired lifespan of the bearings.

The fixed bearing is secured on the A flange with a retaining ring. The floating bearing is preloaded on the B flange with a spring in the direction of the A flange. Axial forces in the direction of the B flange can cause the spring bias to be overcome and the shaft is shifted by the amount of axial play in the bearing (approx. 0.1 - 0.2 mm). This shift can cause problems on motors with holding brakes or motors with EnDat encoders (E2 and E3). Therefore, **no** axial force is permitted in the direction of the B flange when using these motors.

Danger!

The shaft ends of motors with holding brakes are not permitted to have axial loads applied. Especially axial forces in the direction of the B flange should be prevented because these forces can cause the brake to fail!

Information:

The shaft ends of motors with EnDat encoders (E2 and E3) are not permitted to have axial loads applied. Especially axial forces in the direction of the B flange should be prevented because these forces can cause encoder errors!

Determining Permissible Values for F_r and F_a

Information to determine permissible values of F_r and F_a can be taken from the motor data for the respective three-phase synchronous motors (see section 1.9 "Motor Data 8LSA2" to section 1.15 "Motor Data 8LSA8"). Permissible values are based on a bearing lifespan of 20000 h (bearing lifespan calculation based on DIN ISO 281).

Warning!

Simultaneously loading the shaft end with the maximum values of F_r and F_a is not permitted! Contact B&R if this occurs.

1.3.6 Connection Direction

8LS three-phase synchronous motors can be delivered with "top" connection direction and also with axial swivel connectors.

1.3.7 Determining the Order Code for Motor Options (ff)

The respective code (ff) for the order key can be found in the following table:

Connection Direction	Motor Options			Code for Order Key (ff)
	Oil Seal	Holding brake	Shaft End	
Straight (upwards)	No	No	Smooth	C0
			Keyed	C1
		Normal	Smooth	C2
			Keyed	C3
	Yes	No	Smooth	C6
			Keyed	C7
		Normal	Smooth	C8
			Keyed	C9
Angled (swivel connector)	No	No	Smooth	D0
			Keyed	D1
		Normal	Smooth	D2
			Keyed	D3
	Yes	No	Smooth	D6
			Keyed	D7
		Normal	Smooth	D8
			Keyed	D9

Table 8: Order key code (ff) for the motor options

1.4 Special Motor Options

The 8LS three-phase synchronous motors can be delivered with the following special motor options depending on the cooling type, size and length: ¹⁾

- "Reinforced A side bearing"

The respective special motor option is listed as part of the model number in the form of a 2-digit code (gg). "00" has to be entered if no special motor options are required.

1.4.1 "Reinforced A side bearing" (in preparation)

8LS three-phase synchronous motors with special motor option "reinforced A side bearing" can handle increased radial and axial forces (F_r , F_a) on the end of the shaft.

Information to determine permissible values of F_r and F_a can be taken from the motor data for the respective 8LS three-phase synchronous motors (see section 1.9 "Motor Data 8LSA2" to section 1.15 "Motor Data 8LSA8").

The following motor sizes are available with special motor option "reinforced A side bearing":

Special Motor Option	Code (gg)	Available for Motor Size						
		2	3	4	5	6	7	8
"Reinforced A side bearing"	04	---	---	Yes	Yes	Yes	---	Yes

Table 9: Available motor sizes for special motor option "reinforced A side bearing"

Information:

Motors with special motor option "reinforced A side bearing" have increased values (in relation to motors with standard bearings) for the dimensions of the motor shaft.

The exact dimensions can be found in the motor data for the respective 8LS three-phase synchronous motors (see section 1.9 "Motor Data 8LSA2" to section 1.15 "Motor Data 8LSA8").

1) Other special options must be arranged with B&R.

1.5 Order Key

8LS **b** **c** **d** **.** **ee** **nnn** **ff** **gg** **-** **h**

Cooling type (see section 1.1.1 "Cooling Types" on page 22)

A self-cooling (no separate surface cooling)

Size (see section 1.1.2 "Sizes" on page 22)

Valid values: **2, 3, 4, 5, 6, 7, 8**

Length (see section 1.1.3 "Lengths" on page 22)

3 small rated torque
4 medium rated torque
5 large rated torque
6 extra large rated torque
7 exceptionally large rated torque

Encoder system (see section 1.2 "Motor Encoder Systems" on page 23)

E0 EnDat single-turn, 512 lines (ECN1313) ¹⁾
E1 EnDat multi-turn, 512 lines (EQN1325), 4096 revolutions ¹⁾
E2 EnDat single-turn, 32 lines, inductive (EC1317) ²⁾
E3 EnDat multi-turn, 32 lines, inductive (EQ1329), 4096 revolutions ²⁾
E4 EnDat single-turn, 512 lines (ECN1113) ³⁾
E5 EnDat multi-turn, 512 lines (EQN1125), 4096 revolutions ³⁾
R0 Resolver

- 1) Only available for size 3 to 8 motors.
- 2) Only available for size 3 to 7 motors.
- 3) Only available for size 2 motors.

Rated speed (see section 1.3 "Motor Options" on page 25)

nnnrated speed / 100; e.g.: 030 corresponds to a rated speed of 3000 min⁻¹

Motor Options (see section 1.3 "Motor Options" on page 25)

Special Motor Options (see section 1.4 "Special Motor Options" on page 33) ¹⁾

00 No special motor options
04 Reinforced A side bearing (in preparation)

- 1) Special motor options must be arranged with B&R.

Motor Version

Valid values: **0**

1.5.1 Example Order 1

A three-phase synchronous motor (type **8LSA45**) with a nominal speed of 3000 min^{-1} was selected for an application. Because of the construction, the cables can only be connected on the top of the motor ("top" connection direction). The motor should also be equipped with a holding brake, a keyed shaft and a 512 line EnDat single-turn encoder.

The code (ee) for the encoder system is **E0** (see table 3 "Technical data for EnDat encoders" on page 23).

The code (nnn) for a rated speed of 3000 min^{-1} is **030**.

The code (ff) for the other options (oil seal, holding brake, keyed shaft and connection direction) is **C3** (see table 8 "Order key code (ff) for the motor options" on page 32).

Therefore the model number for the motor required is: **8LSA45.E0030C300-0**

1.5.2 Example Order 2

A three-phase synchronous motor (type **8LSA56**) with a nominal speed of 4500 min^{-1} was selected for an application. Because of the construction, the cables can only be connected on the back of the motor (swivel connectors). The motor should also be equipped with a holding brake, a smooth shaft, an oil seal and a 512 line EnDat multi-turn encoder.

The code (ee) for the encoder system is **E1** (see table 3 "Technical data for EnDat encoders" on page 23).

The code (nnn) for a rated speed of 4500 min^{-1} is **045**.

The code (ff) for the other options (oil seal, holding brake, keyed shaft and connection direction) is **D8** (see table 8 "Order key code (ff) for the motor options" on page 32).

Therefore the model number for the motor required is: **8LSA56.E1045D800-0**

1.6 General Motor Data

Description	Cooling Type A
General Information	
C-UR-US Listed	Yes
Electrical Characteristics	
Mains Input Voltage on Servo Drive	3 x 400 VAC ... 3 x 480 VAC ± 10 %
Connection Technology Motor Connector Encoder Connection	Circular connector from Intercontec Size 1 (8LSA8: Size 1.5) Size 1
Thermal Characteristics	
Insulation Class according to IEC 60034-1	F
Methods of Cooling according to IEC 60034-6 (IC code)	Self-cooling No separate surface cooling (IC4A0A0)
Thermal Motor Protection according to IEC 60034-11	Maximum winding temperature is 145 °C (limited to 110 °C by the thermal motor protection in ACOPOS servo drive)
Mechanical Characteristics	
Vibration Severity according to IEC 60034-14	Vibration severity grade R ¹⁾
Roller Bearing, Dynamic Load Ratings and Rated Lifespan	Based on DIN ISO 281
Eye Bolt according to DIN 580	For size 8
Shaft End according to DIN 748 ²⁾	Form E
Oil Seal according to DIN 3760	Form A
Key and Keyway according to DIN 6885-1	Keyway form N1; key form A
Balancing the Shaft according to DIN ISO 8821	Half-key arrangement
Mounting Flange according to DIN 42948	Form A
Shaft End Concentricity, Coaxial Properties and Mounting Flange Plane according to DIN 42955	Tolerance R
Paint Description Color	Water-based paint 98160 *IDROLIN/E SM SEMIOPACO NERO RAL 9005-C.452 RAL 9005 flat; shaft end and flange front metallic glossy
Operational Conditions	
Rating Class, Operation Mode acc. to IEC 60034-1	S1 - continuous operation
Environmental temperature during operation	-15 °C to +40 °C
Reduction of the Rated Current and Stall Current at Temperatures above 40 °C	10 % per 10 °C
Maximum Environmental Temperature during Operation	+55 °C ³⁾
Relative Humidity During Operation	5 to 95% (non-condensing)
Reduction of the Nominal Current and Stall Current at Installation Altitudes over 1000 m above Sea Level	10 % per 1000 m
Maximum Installation Altitude	2000 m ⁴⁾

Table 10: General technical data

Technical Data • 8LS Three-phase Synchronous Motors

Description	Cooling Type A
Maximum Flange Temperature	65 °C
Protection Standards according to IEC 60034-5 (IP code) With Optional Oil Seal	IP64 IP65
Construction and Mounting Arrangement Type according to IEC 60034-7 (IM code)	Horizontal (IM3001) Vertical, motor hangs on the machine (IM3011) Vertical, motor stands on the machine (IM3031)
Storage and Transport Conditions	
Storage Temperature	-20 to +60 °C
Relative Humidity during Storage	Max. 90%, non-condensing
Transport Temperature	-20 to +60 °C
Relative Humidity during Transport	Max. 90%, non-condensing

Table 10: General technical data (cont.)

- 1) Valid for all motors with a shaft height of more than 56 mm.
- 2) Except motor sizes 2 and 7.
- 3) Continuous operation of the servo motors at environmental temperatures from +40 °C to max. +55 °C is possible, but results in a shorter lifespan.
- 4) Additional requirements are to be arranged with B&R.

1.7 Terminology and Formula Symbols

1.7.1 Connection Direction, Bearing

Angled (swivel connector)	Straight (upwards)
	

Table 11: Connection direction terminology, bearings

1.7.2 Definitions for Maximum Shaft Load Diagrams

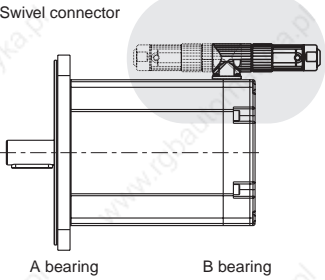
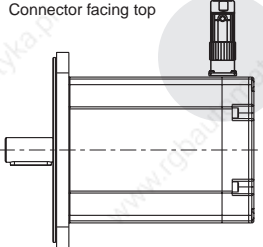
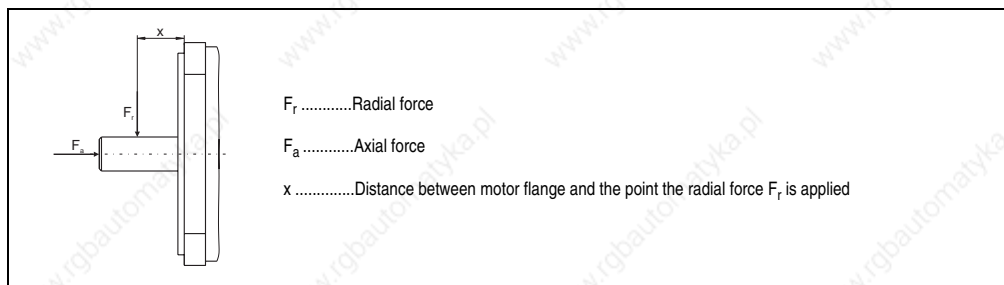

Figure 6: Definitions for maximum shaft load diagrams

1.7.3 Formula Symbols

Term	Symbol	Unit	Description
Rated speed	n_N	min^{-1}	Rated Speed of the Motor
Rated torque	M_N	Nm	The rated torque is output by the motor ($n = n_N$) when the rated current is being drawn. This is possible for any length of time if the environmental conditions are correct.
Rated power	P_N	kW	The rated power is output by the motor when $n = n_N$. This is possible for any length of time if the environmental conditions are correct.
Rated current	I_N	A	The rated current is the effective value for the phase current (current in the motor supply line) when generating the rated torque at the rated speed. This is possible for any length of time if the environmental conditions are correct.
Stall torque	M_0	Nm	The "stall torque" is output by the motor at the speed n_0 and when the "stall current" is being drawn. This is possible for any length of time if the environmental conditions are correct. The speed n_0 must be high enough so that the winding temperature in all windings is uniform and stationary ($n_0 = 50 \text{ min}^{-1}$ for B&R motors). The continuous torque is reduced while stationary.
Stall current	I_0	A	The "stall current" is the effective value of the phase current (current in the motor supply line) for the generation of the "stall torque" at the speed n_0 . This is possible for any length of time if the environmental conditions are correct. The speed n_0 must be high enough so that the winding temperature in all windings is uniform and stationary ($n_0 = 50 \text{ min}^{-1}$ for B&R motors). The continuous current is reduced while stationary.
Peak torque	M_{\max}	Nm	The peak torque is briefly output by the motor when the peak current is being drawn.
Maximum current	I_{\max}	A	The peak current is the effective value of the phase current (current in the motor supply line) for the generation of the peak torque. Only possible for a short time. The peak current is determined by the magnetic circuit. Exceeding this value for a short time can cause irreversible damage (demagnetize the magnet material).
Maximum angular acceleration without brake	a	rad/s^2	Maximum acceleration of the motor without load and without brake. Value for the dynamics of the motor (corresponds to M_{\max} / J).
Maximum speed	n_{\max}	min^{-1}	Maximum motor speed. This is a mechanical condition (centrifugal force, bearing wear).
Average speed	n_{aver}	min^{-1}	Average speed for one cycle
Torque constant	K_T	Nm/A	The torque constant determines the torque created by the motor with 1 A_{rms} phase current. This value applies at a motor temperature of 20°C. When the temperature increases, the torque constant is reduced (generally to 10%). When the current increases, the torque constant is reduced (generally starting at twice the value of the rated current).
Voltage constant	K_E	$\text{V}/1000\text{min}^{-1}$	The voltage constant determines the effective value (phase-phase) of the reverse voltage (EMF) induced by the motor with a speed of 1000 min^{-1} . This value applies at a motor temperature of 20°C. When the temperature increases, the voltage constant is reduced (generally to 5%). When the current increases, the voltage constant is reduced (generally starting at twice the value of the rated current).
Stator resistance	$R_{2\text{ph}}$	Ω	Resistance measured in ohms between two motor leads (phase-phase) at 20 °C winding temperature. On B&R motors, the windings use a star connection.
Stator inductance	$L_{2\text{ph}}$	mH	Winding inductance measured between two motor leads. Stator inductance depends on the rotor position.

Table 12: Formula symbols

Technical Data • 8LS Three-phase Synchronous Motors

Term	Symbol	Unit	Description
Electrical time constant	t_{el}	ms	Corresponds to 1/5 of the time needed for the stator current to stabilize with constant operating conditions.
Thermal time constant	t_{therm}	min	Corresponds to 1/5 of the time needed for the motor temperature to stabilize with constant operating conditions.
Moment of inertia without brake	J	kgcm ²	Moment of inertia for the motor without holding brake.
Weight without brake	m	kg	Weight of the motor without holding brake.
Moment of inertia of brake	J_{Br}	kgcm ²	Moment of inertia for the built-in holding brake.
Weight of brake	m_{Br}	kg	Weight of the built-in holding brake.
Brake holding torque	M_{Br}	Nm	Minimum torque required to hold the rotor when the brake is activated.
Installed load	P_{in}	W	Installed load for the built-in holding brake.
Installed current	I_{in}	A	Installed current for the built-in holding brake.
Installed voltage	U_{in}	V	Operating voltage for the built-in holding brake.
Activation delay	t_{on}	ms	Delay time required for the holding torque of the brake to be established after the operating voltage has been removed from the holding brake.
Release delay	t_{off}	ms	Delay time required until the holding torque of the holding brake is reduced by 90% (the brake is released) after the operating voltage has been returned to the holding brake.

Table 12: Formula symbols (cont.)

1.8 Motor Data Overview Cooling Type A

The technical data listed in this section (K_E , K_T , I_N , I_0 , I_{max} , R_{2PH} , L_{2PH} , t_{el} , t_{therm} , m , J) has a theoretical tolerance range of $\pm 10\%$. This is also valid for the speed - torque characteristic curves represented in the following sections.

	8LSA23.ee060f9g-0	8LSA24.ee060f9g-0	8LSA25.ee060f9g-0	8LSA26.ee060f9g-0	8LSA33.ee030f9g-0	8LSA33.ee045f9g-0	8LSA33.ee060f9g-0	8LSA34.ee030f9g-0	8LSA34.ee045f9g-0	8LSA34.ee060f9g-0
Rated Speed n_N [min^{-1}]	6000	6000	6000	6000	3000	4500	6000	3000	4500	6000
Number of Poles	4	4	4	4	4			4		
Rated Torque M_N [Nm]	0.17	0.35	0.52	0.69	0.7	0.67	0.6	1.4	1.3	1
Rated Power P_N [kW]	0.11	0.22	0.33	0.43	0.22	0.32	0.38	0.44	0.61	0.63
Rated Current I_N [A]	0.23	0.48	0.71	0.95	0.48	0.69	0.82	0.96	1.34	1.37
Stall Torque M_0 [Nm]	0.2	0.4	0.6	0.8	0.75			1.5		
Stalled Current I_0 [A]	0.27	0.55	0.82	1.1	0.52	0.77	1.03	1.03	1.55	2.06
Peak Torque M_{max} [Nm]	0.8	1.6	2.4	3.2	3			6		
Peak Current I_{max} [A]	1.25	2.5	3.7	5	2.22	3.32	4.43	4.43	6.65	8.87
Maximum Angular Acceleration without Brake a [rad/s^2]	114286	133333	150000	160000	85714			100000		
Maximum Speed n_{max} [min^{-1}]	12000	12000	12000	12000	12000			12000		
Torque Constant K_T [Nm/A]	0.73	0.73	0.73	0.73	1.46	0.97	0.73	1.46	0.97	0.73
Voltage Constant K_E [V/1000 min^{-1}]	43.98	43.98	43.98	43.98	87.96	58.64	43.98	87.96	58.64	43.98
Stator Resistance R_{2ph} [Ω]	190	62	29	20.8	108	44.48	27	34	15.56	8.5
Stator Inductance L_{2ph} [mH]	150	75	49.7	37.5	147.5	63.08	36.87	73.12	32.77	18.28
Electrical Time Constant t_{el} [ms]	0.79	1.21	1.71	1.8	1.37	1.4	1.37	2.15	2.2	2.15
Thermal Time Constant t_{therm} [min]	15	20	25	30	32			35		
Moment of Inertia without Brake J [kgcm^2]	0.07	0.12	0.16	0.2	0.35			0.6		
Weight without Brake m [kg]	1.5	1.7	1.9	2.1	1.4			2.2		
Moment of Inertia for Brake J_{Br} [kgcm^2]	0.12	0.12	0.12	0.12	0.38			0.38		
Weight of Brake m_{Br} [kg]	0.19	0.19	0.19	0.19	0.3			0.3		
Holding Torque of the Brake M_{Br} [Nm]	2.2	2.2	2.2	2.2	3.2			3.2		
Recommended Cable Cross Section for B&R Motor Cables [mm^2] ¹⁾	1.5	1.5	1.5	1.5	1.5			1.5		
Recommended ACOPOS Servo Drive 8Vxxx.00-x ²⁾	1010	1010	1010	1016	1010	1016	1016	1022	1045	

Tabelle 13: Motor data overview for cooling type A

- 1) The B&R motor cables with this cable cross section are produced optimally (cables stripped to the correct length) for the recommended ACOPOS servo drives (see next line). B&R motor cables with other cable cross sections can also be used (within the specified terminal cross section range) and can be obtained from B&R in the desired design on request.
- 2) The recommended servo drive is defined for the stall current of the motor; if more than double the stall torque is required during the acceleration phase, the next larger servo drive should be selected. This recommendation is only a guideline, detailed inspection of the corresponding speed - torque characteristic curve can result in deviations of the servo drive size (one size larger or smaller).

	8LSA35.ee030f1gg-0	8LSA35.ee045f1gg-0	8LSA35.ee060f1gg-0	8LSA36.ee030f1gg-0	8LSA36.ee045f1gg-0	8LSA36.ee060f1gg-0	8LSA43.ee030f1gg-0	8LSA43.ee045f1gg-0	8LSA43.ee060f1gg-0
Rated Speed n_N [min ⁻¹]	3000	4500	6000	3000	4500	6000	3000	4500	6000
Number of poles	4			4			10		
Rated Torque M_N [Nm]	2.1	1.8	1.6	2.7	2.2	1.8	3.1	2.7	2
Rated Power P_N [kW]	0.66	0.85	1.01	0.85	1.04	1.13	0.97	1.27	1.26
Rated Current I_N [A]	1.44	1.86	2.20	1.86	2.27	2.47	1.9	2.49	2.46
Stall Torque M_0 [Nm]	2.3			3			4		
Stalled Current I_0 [A]	1.58	2.37	3.16	2.07	3.09	4.12	2.46	3.7	4.91
Peak Torque M_{max} [Nm]	9.2			12			16		
Peak Current I_{max} [A]	6.8	10.2	13.6	8.9	13.3	17.73	10.61	15.96	21.23
Maximum Angular Acceleration without Brake a [rad/s ²]	102222			100000			91429		
Maximum Speed n_{max} [min ⁻¹]	12000			12000			12000		
Torque Constant K_T [Nm/A]	1.46	0.97	0.73	1.45	0.97	0.73	1.63	1.08	0.81
Voltage Constant K_E [V/1000 min ⁻¹]	87.96	58.64	43.98	87.96	58.64	43.98	98.43	65.45	49.22
Stator Resistance R_{2ph} [Ω]	19	8.1	4.5	11.45	5.16	2.9	5.43	2.42	1.36
Stator Inductance L_{2ph} [mH]	49.16	21.70	12.29	36.5	16.64	9.45	36.5	16.5	9.2
Electrical Time Constant t_{el} [ms]	2.59	2.68	2.73	3.19	3.23	3.26	6.72	6.83	6.77
Thermal Time Constant t_{therm} [min]	38			40			25		
Moment of Inertia without Brake J [kgcm ²]	0.9			1.2			1.75		
Weight without Brake m [kg]	3.1			4			3.9		
Moment of Inertia for Brake J_{Br} [kgcm ²]	0.38			0.38			0.54		
Weight of Brake m_{Br} [kg]	0.29			0.29			0.46		
Holding Torque of the Brake M_{Br} [Nm]	3.2			3.2			8		
Recommended Cable Cross Section for B&R Motor Cables [mm ²] ¹⁾	1.5			1.5			1.5		
Recommended ACOPOS Servo Drive 8Vxxx.00-x ²⁾	1022	1045	1045	1045	1090		1045	1090	

Table 13: Motor data overview for cooling type A (cont.)

- 1) The B&R motor cables with this cable cross section are produced optimally (cables stripped to the correct length) for the recommended ACOPOS servo drives (see next line). B&R motor cables with other cable cross sections can also be used (within the specified terminal cross section range) and can be obtained from B&R in the desired design on request.
- 2) The recommended servo drive is defined for the stall current of the motor; if more than double the stall torque is required during the acceleration phase, the next larger servo drive should be selected. This recommendation is only a guideline, detailed inspection of the corresponding speed - torque characteristic curve can result in deviations of the servo drive size (one size larger or smaller).

	8LSA44.ee030f/gg-0	8LSA44.ee045f/gg-0	8LSA44.ee060f/gg-0	8LSA45.ee030f/gg-0	8LSA45.ee045f/gg-0	8LSA45.ee060f/gg-0	8LSA46.ee030f/gg-0	8LSA46.ee045f/gg-0	8LSA46.ee060f/gg-0
Rated Speed n_N [min ⁻¹]	3000	4500	6000	3000	4500	6000	3000	4500	6000
Number of Poles	10			10			10		
Rated Torque M_N [Nm]	4.62	3.6	3	6.16	4.8	4	7.7	6	5
Rated Power P_N [kW]	1.45	1.7	1.88	1.94	2.26	2.51	2.42	2.83	3.14
Rated Current I_N [A]	2.84	3.33	3.69	3.78	4.43	4.91	4.73	5.54	6.14
Stall Torque M_0 [Nm]	6			8			10		
Stalled Current I_0 [A]	3.69	5.54	7.37	4.91	7.39	9.83	6.14	9.24	12.28
Peak Torque M_{max} [Nm]	24			32			40		
Peak Current I_{max} [A]	15.92	23.94	31.84	21.23	31.93	42.45	26.53	39.91	53.07
Maximum Angular Acceleration without Brake a [rad/s ²]	94118			95522			97561		
Maximum Speed n_{max} [min ⁻¹]	12000			12000			12000		
Torque Constant K_T [Nm/A]	1.63	1.08	0.81	1.63	1.08	0.81	1.63	1.08	0.81
Voltage Constant K_E [V/1000 min ⁻¹]	98.43	65.45	49.22	98.43	65.45	49.22	98.43	65.45	49.22
Stator Resistance R_{2ph} [Ω]	3.45	1.53	0.86	2.49	1.11	0.67	1.98	0.88	0.48
Stator Inductance L_{2ph} [mH]	24	10.8	6.2	21.8	9.69	5.45	17.44	7.75	4.36
Electrical Time Constant t_{ei} [ms]	6.96	7.04	7.19	8.76	8.76	8.13	8.81	8.79	9.08
Thermal Time Constant t_{therm} [min]	30			35			40		
Moment of Inertia without Brake J [kgcm ²]	2.55			3.35			4.1		
Weight without Brake m [kg]	5.26			6.7			8.1		
Moment of Inertia for Brake J_{Br} [kgcm ²]	0.54			0.54			0.54		
Weight of Brake m_{Br} [kg]	0.46			0.46			0.46		
Holding Torque of the Brake M_{Br} [Nm]	8			8			8		
Recommended Cable Cross Section for B&R Motor Cables [mm ²] ¹⁾	1.5			1.5			4		
Recommended ACOPOS Servo Drive 8Vxxx.00-x ²⁾	1045	1090		1090	1180	1090	1180		

Table 13: Motor data overview for cooling type A (cont.)

- 1) The B&R motor cables with this cable cross section are produced optimally (cables stripped to the correct length) for the recommended ACOPOS servo drives (see next line). B&R motor cables with other cable cross sections can also be used (within the specified terminal cross section range) and can be obtained from B&R in the desired design on request.
- 2) The recommended servo drive is defined for the stall current of the motor; if more than double the stall torque is required during the acceleration phase, the next larger servo drive should be selected. This recommendation is only a guideline, detailed inspection of the corresponding speed - torque characteristic curve can result in deviations of the servo drive size (one size larger or smaller).

	8LSA53.ee030f1gg-0	8LSA53.ee045f1gg-0	8LSA54.ee030f1gg-0	8LSA54.ee045f1gg-0	8LSA55.ee030f1gg-0	8LSA55.ee045f1gg-0	8LSA56.ee030f1gg-0	8LSA56.ee045f1gg-0	8LSA57.ee030f1gg-0	8LSA57.ee045f1gg-0
Rated Speed n_N [min ⁻¹]	3000	4500	3000	4500	3000	4500	3000	4500	3000	4500
Number of Poles	8		8		8		8		8	
Rated Torque M_N [Nm]	3.5	3	7	6	10.5	9	14	12	17.5	15
Rated Power P_N [kW]	1.1	1.41	2.2	2.83	3.3	4.24	4.4	5.65	5.5	7.07
Rated Current I_N [A]	2.15	2.73	4.29	5.45	6.44	8.18	8.59	10.91	10.74	13.64
Stall Torque M_0 [Nm]	4		8		12		16		20	
Stalled Current I_0 [A]	2.45	3.64	4.91	7.27	7.36	10.91	9.82	14.55	12.27	18.18
Peak Torque M_{max} [Nm]	12		24		36		48		60	
Peak Current I_{max} [A]	11.3	15.9	22	33.3	33.8	47.6	45	62.3	53.1	79.7
Maximum Angular Acceleration without Brake a [rad/s ²]	30000		40000		45000		48000		50420	
Maximum Speed n_{max} [min ⁻¹]	9000		9000		9000		9000		9000	
Torque Constant K_T [Nm/A]	1.63	1.1	1.63	1.1	1.63	1.1	1.63	1.1	1.63	1.1
Voltage Constant K_E [V/1000 min ⁻¹]	98.43	65.97	98.43	65.97	98.43	65.97	98.43	65.97	98.43	65.97
Stator Resistance R_{2ph} [Ω]	9.72	4.97	3.1	1.32	1.6	0.8	1.07	0.56	0.89	0.39
Stator Inductance L_{2ph} [mH]	55.4	28.4	23.34	9.02	14.01	7.03	10.51	5.48	8.5	3.78
Electrical Time Constant t_{ei} [ms]	5.7	5.71	7.53	6.83	8.76	8.79	9.82	9.84	9.55	9.69
Thermal Time Constant t_{therm} [min]	36		40		43		48		50	
Moment of Inertia without Brake J [kgcm ²]	4		6		8		10		11.9	
Weight without Brake m [kg]	10.2		12		14.1		16.4		18.6	
Moment of Inertia for Brake J_{Br} [kgcm ²]	1.66		1.66		1.66		1.66		1.66	
Weight of Brake m_{Br} [kg]	0.9		0.9		0.9		0.9		0.9	
Holding Torque of the Brake M_{Br} [Nm]	15		15		15		15		15	
Recommended Cable Cross Section for B&R Motor Cables [mm ²] ¹⁾	1.5		1.5		1.5		4		4	
Recommended ACOPOS Servo Drive 8Vxxx.x00-x ²⁾	1045		1090		1090		1180		1180	

Table 13: Motor data overview for cooling type A (cont.)

- 1) The B&R motor cables with this cable cross section are produced optimally (cables stripped to the correct length) for the recommended ACOPOS servo drives (see next line). B&R motor cables with other cable cross sections can also be used (within the specified terminal cross section range) and can be obtained from B&R in the desired design on request.
- 2) The recommended servo drive is defined for the stall current of the motor; if more than double the stall torque is required during the acceleration phase, the next larger servo drive should be selected. This recommendation is only a guideline, detailed inspection of the corresponding speed - torque characteristic curve can result in deviations of the servo drive size (one size larger or smaller).

	8LSA63.ee030f1gg-0		8LSA63.ee045f1gg-0		8LSA64.ee030f1gg-0		8LSA64.ee045f1gg-0		8LSA65.ee030f1gg-0		8LSA65.ee045f1gg-0		8LSA66.ee030f1gg-0		8LSA66.ee045f1gg-0	
Rated Speed n_N [min ⁻¹]	3000		4500		3000		4500		3000		4500		3000		4500	
Number of Poles	8		8		8		8		8		8		8		8	
Rated Torque M_N [Nm]	11.6	8.9	17.5	10.6	21	10.9	23.2	12	3.64	4.19	5.5	5	6.6	5.14	7.29	5.65
Rated Power P_N [kW]	7.12	8.09	10.74	9.64	12.88	9.91	14.23	10.91	3.64	4.19	5.5	5	6.6	5.14	7.29	5.65
Rated Current I_N [A]	12		20		24		28		12		20		24		28	
Stall Torque M_0 [Nm]	7.36	10.91	12.27	18.18	14.72	21.82	17.18	25.45	7.36	10.91	12.27	18.18	14.72	21.82	17.18	25.45
Stalled Current I_0 [A]	40.8		68		81.6		95.2		40.8		68		81.6		95.2	
Peak Torque M_{max} [Nm]	44	62	69	104	87	130	104	149	44	62	69	104	87	130	104	149
Peak Current I_{max} [A]	51000		57143		59130		60637		51000		57143		59130		60637	
Maximum Angular Acceleration without Brake a [rad/s ²]	6000		6000		6000		6000		6000		6000		6000		6000	
Maximum Speed n_{max} [min ⁻¹]	1.63	1.	1.63	1.1	1.63	1.1	1.63	1.1	1.63	1.	1.63	1.1	1.63	1.	1.63	1.1
Torque Constant K_T [Nm/A]	98.43	65.97	98.43	65.97	98.43	65.97	98.43	65.97	98.43	65.97	98.43	65.97	98.43	65.97	98.43	65.97
Voltage Constant K_E [V/1000 min ⁻¹]	1.6	0.8	0.89	0.39	0.65	0.29	0.5	0.25	1.6	0.8	0.89	0.39	0.65	0.29	0.5	0.25
Stator Resistance R_{2ph} [Ω]	14.01	7.03	8.5	3.78	6.53	2.9	5.29	2.59	14.01	7.03	8.5	3.78	6.53	2.9	5.29	2.59
Stator Inductance L_{2ph} [mH]	8.76	8.79	9.55	9.69	10.05	10.14	10.58	10.57	8.76	8.79	9.55	9.69	10.05	10.14	10.58	10.57
Electrical Time Constant t_{ei} [ms]	45		50		55		60		45		50		55		60	
Thermal Time Constant t_{therm} [min]	8		11.9		13.8		15.7		8		11.9		13.8		15.7	
Moment of Inertia without Brake J [kgcm ²]	14.1		18.6		20.8		23		14.1		18.6		20.8		23	
Weight without Brake m [kg]	5.85		5.85		5.85		5.85		5.85		5.85		5.85		5.85	
Moment of Inertia for Brake J_{Br} [kgcm ²]	1.6		1.6		1.6		1.6		1.6		1.6		1.6		1.6	
Weight of Brake m_{Br} [kg]	32		32		32		32		32		32		32		32	
Holding Torque of the Brake M_{Br} [Nm]	1.5		4		4		4		1.5		4		4		4	
Recommended Cable Cross Section for B&R Motor Cables [mm ²] ¹⁾	1090		1180		1180		1320		1090		1180		1180		1320	
Recommended ACOPOS Servo Drive 8Vxxx.00-x ²⁾	1090		1180		1180		1320		1090		1180		1180		1320	

Table 13: Motor data overview for cooling type A (cont.)

- 1) The B&R motor cables with this cable cross section are produced optimally (cables stripped to the correct length) for the recommended ACOPOS servo drives (see next line). B&R motor cables with other cable cross sections can also be used (within the specified terminal cross section range) and can be obtained from B&R in the desired design on request.
- 2) The recommended servo drive is defined for the stall current of the motor; if more than double the stall torque is required during the acceleration phase, the next larger servo drive should be selected. This recommendation is only a guideline, detailed inspection of the corresponding speed - torque characteristic curve can result in deviations of the servo drive size (one size larger or smaller).

Technical Data • Motor Data Overview Cooling Type A

	8LSA73.ee030f1gg-0	8LSA73.ee045f1gg-0	8LSA74.ee030f1gg-0	8LSA74.ee045f1gg-0	8LSA75.ee030f1gg-0	8LSA83.ee030f1gg-0	8LSA84.ee030f1gg-0	8LSA85.ee020f1gg-0	8LSA85.ee020f1gg-0
Rated Speed n_N [min ⁻¹]	3000	4500	3000	4500	3000	3000	3000	2000	2000
Number of Poles	6		6		6	6	6	6	6
Rated Torque M_N [Nm]	20	14.5	24	15	30	27	48.4	72	85
Rated Power P_N [kW]	6.28	6.83	7.54	7.07	9.42	8.48	15.21	15.08	17.8
Rated Current I_N [A]	12.27	13.18	14.72	13.64	18.4	16.56	29.69	29.39	34.69
Stall Torque M_0 [Nm]	26		32		40	40	69	94	115
Stalled Current I_0 [A]	15.95	23.64	19.63	29.09	24.54	24.54	42.33	38.37	46.94
Peak Torque M_{max} [Nm]	107		134		187	120	204	280	345
Peak Current I_{max} [A]	115	171	140	207	176	102	171	150.6	182
Maximum Angular Acceleration without Brake a [rad/s ²]	10918		11652		13357	18462	17895	18667	17969
Maximum Speed n_{max} [min ⁻¹]	6000		6000		4500	3600	3600	3600	3600
Torque Constant K_T [Nm/A]	1.63	1.1	1.63	1.1	1.63	1.63	1.63	2.45	2.45
Voltage Constant K_E [V/1000 min ⁻¹]	98.43	65.97	98.43	65.97	98.43	98.43	98.43	147.65	147.65
Stator Resistance R_{2ph} [Ω]	0.46	0.22	0.34	0.16	0.2	0.23	0.1	0.16	0.12
Stator Inductance L_{2ph} [mH]	5.55	2.62	4.42	2.2	3.07	5.4	3.11	5.18	4.04
Electrical Time Constant t_{el} [ms]	12.07	11.91	13	13.75	15.35	23.48	31.1	32.38	34.83
Thermal Time Constant t_{therm} [min]	55		60		65	50	65	80	90
Moment of Inertia without Brake J [kgcm ²]	98		115		140	65	114	150	192
Weight without Brake m [kg]	27		30		38	41.5	55	74	92
Moment of Inertia for Brake J_{Br} [kgcm ²]	5.85		5.85		5.85	53	53	53	53
Weight of Brake m_{Br} [kg]	1.6		1.6		1.6	5.35	5.35	5.35	5.35
Holding Torque of the Brake M_{Br} [Nm]	32		32		32	130	130	130	130
Recommended Cable Cross Section for B&R Motor Cables [mm ²] ¹⁾	4		4		4	4 ²⁾	10	10	10
Recommended ACOPOS Servo Drive 8Vxxx.00-x ³⁾	1180	1320	1320	1320	1320	1320	1640	1640	1640

Table 13: Motor data overview for cooling type A (cont.)

- 1) The B&R motor cables with this cable cross section are produced optimally (cables stripped to the correct length) for the recommended ACOPOS servo drives (see next line). B&R motor cables with other cable cross sections can also be used (within the specified terminal cross section range) and can be obtained from B&R in the desired design on request.
- 2) Special prefabricated motor cables must be used for this motor / servo drive combination (size of the motor plug is not the standard size). They are available from B&R on request.
- 3) The recommended servo drive is defined for the stall current of the motor; if more than double the stall torque is required during the acceleration phase, the next larger servo drive should be selected. This recommendation is only a guideline, detailed inspection of the corresponding speed - torque characteristic curve can result in deviations of the servo drive size (one size larger or smaller).

1.9 Motor Data 8LSA2

1.9.1 Technical Data

	8LSA23.ee060/fgg-0	8LSA24.ee060/fgg-0	8LSA25.ee060/fgg-0	8LSA26.ee060/fgg-0
Rated Speed n_N [min ⁻¹]	6000	6000	6000	6000
Number of Poles	4	4	4	4
Rated Torque M_N [Nm]	0.17	0.35	0.52	0.69
Rated Power P_N [kW]	0.11	0.22	0.33	0.43
Rated Current I_N [A]	0.23	0.48	0.71	0.95
Stall Torque M_0 [Nm]	0.2	0.4	0.6	0.8
Stalled Current I_0 [A]	0.27	0.55	0.82	1.1
Peak Torque M_{max} [Nm]	0.8	1.6	2.4	3.2
Peak Current I_{max} [A]	1.25	2.5	3.7	5
Maximum Angular Acceleration without Brake a [rad/s ²]	114286	133333	150000	160000
Maximum Speed n_{max} [min ⁻¹]	12000	12000	12000	12000
Torque Constant K_T [Nm/A]	0.73	0.73	0.73	0.73
Voltage Constant K_E [V/1000 min ⁻¹]	43.98	43.98	43.98	43.98
Stator Resistance R_{2ph} [Ω]	190	62	29	20.8
Stator Inductance L_{2ph} [mH]	150	75	49.7	37.5
Electrical Time Constant t_{el} [ms]	0.79	1.21	1.71	1.8
Thermal Time Constant t_{therm} [min]	15	20	25	30
Moment of Inertia without Brake J [kgcm ²]	0.07	0.12	0.16	0.2
Weight without Brake m [kg]	1.5	1.7	1.9	2.1
Moment of Inertia for Brake J_{Br} [kgcm ²]	0.12	0.12	0.12	0.12
Weight of Brake m_{Br} [kg]	0.19	0.19	0.19	0.19
Holding Torque of the Brake M_{Br} [Nm]	2.2	2.2	2.2	2.2
Recommended Cable Cross Section for B&R Motor Cables [mm ²] ¹⁾	1.5	1.5	1.5	1.5
Recommended ACOPOS Servo Drive 8Vxxxx.00-x ²⁾	1010	1010	1010	1016

Table 14: Technical data for 8LSA2

- 1) The B&R motor cables with this cable cross section are produced optimally (cables stripped to the correct length) for the recommended ACOPOS servo drives (see next line). B&R motor cables with other cable cross sections can also be used (within the specified terminal cross section range) and can be obtained from B&R in the desired design on request.
- 2) The recommended servo drive is defined for the stall current of the motor; if more than double the stall torque is required during the acceleration phase, the next larger servo drive should be selected. This recommendation is only a guideline, detailed inspection of the corresponding speed - torque characteristic curve can result in deviations of the servo drive size (one size larger or smaller).

1.9.2 Speed-Torque Characteristic Curves with 400 VAC Supply Voltage

8LSA23.eennffgg-0

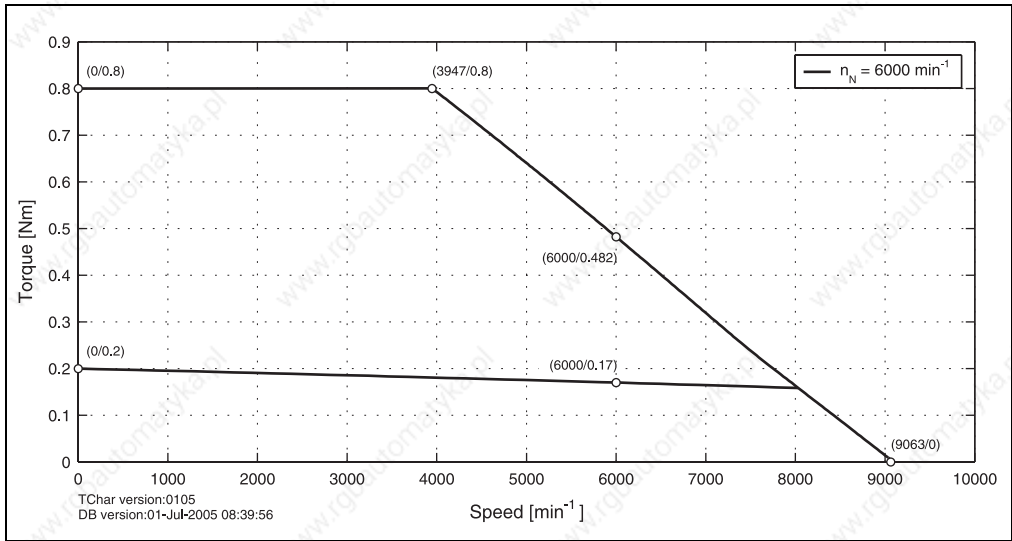

Figure 7: Speed - torque characteristic curve for 8LSA23.eennffgg-0

8LSA24.eennffgg-0

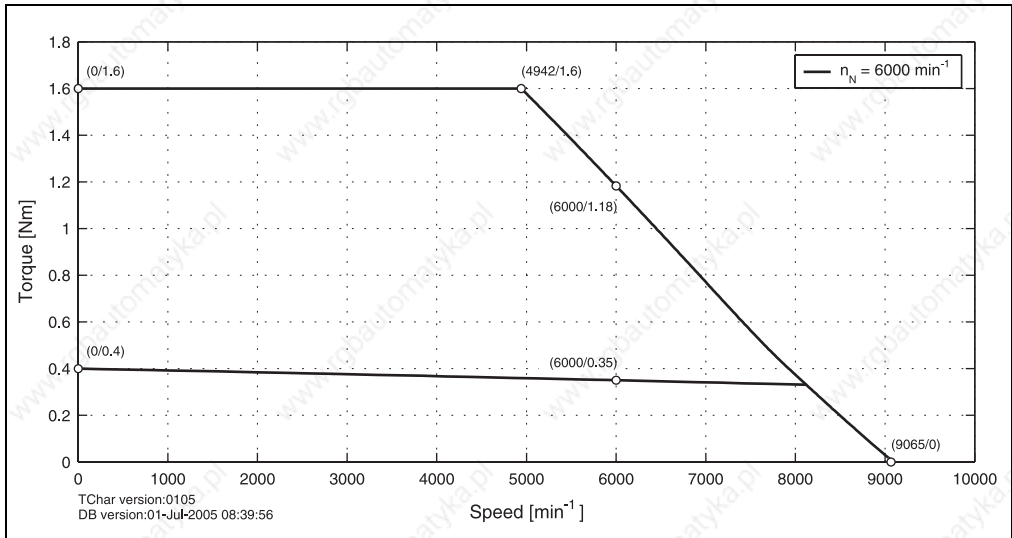

Figure 8: Speed - torque characteristic curve for 8LSA24.eennffgg-0

8LSA25.eennnffgg-0

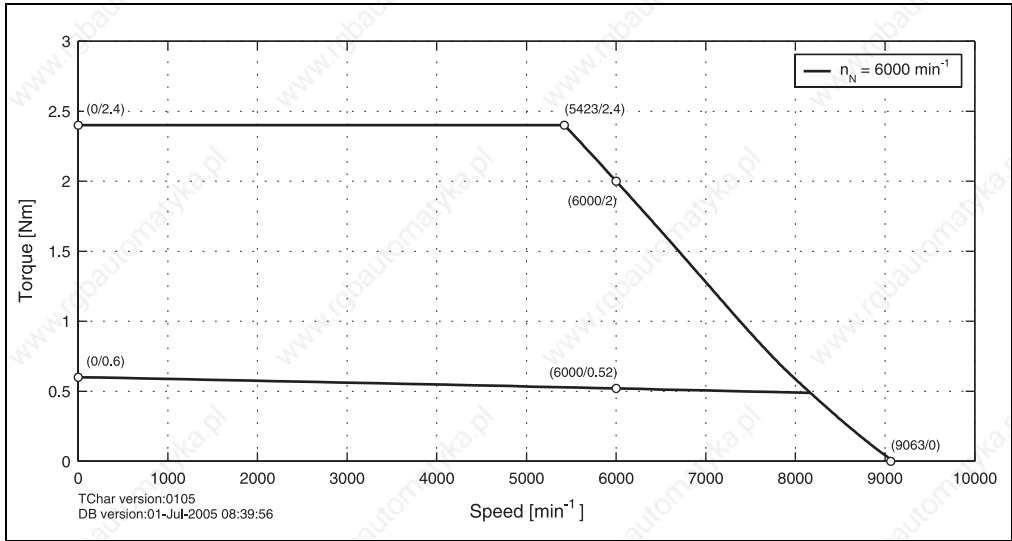

Figure 9: Speed - torque characteristic curve for 8LSA25.eennnffgg-0

8LSA26.eennnffgg-0

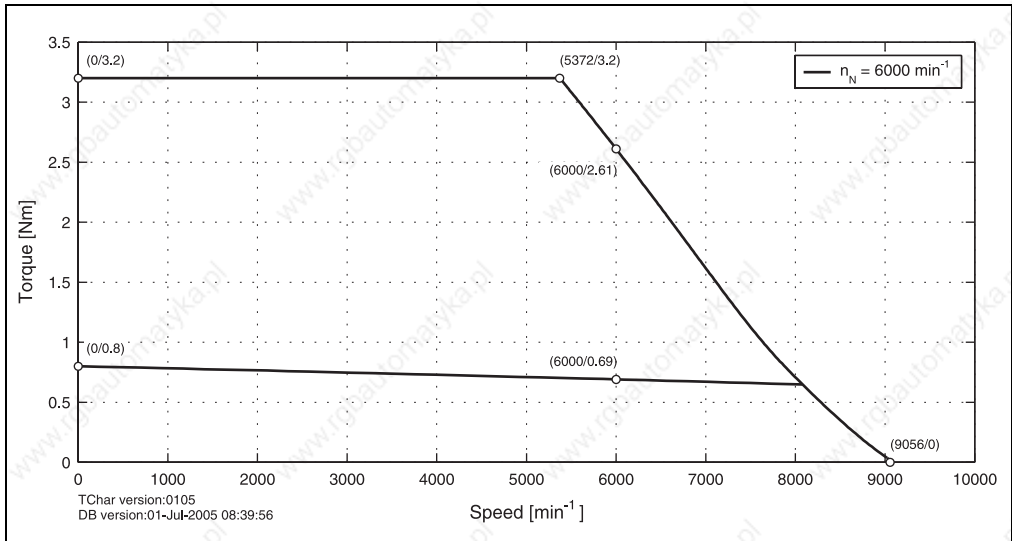

Figure 10: Speed - torque characteristic curve for 8LSA26.eennnffgg-0

1.9.3 Speed-Torque Characteristic Curves with 230 VAC Supply Voltage

8LSA23.eennffgg-0

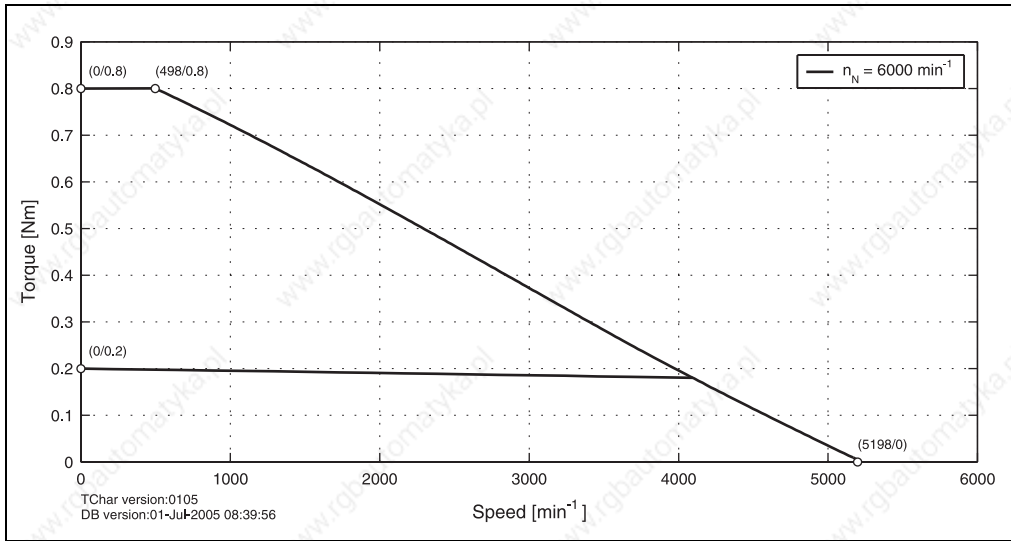

Figure 11: Speed - torque characteristic curve for 8LSA23.eennffgg-0

8LSA24.eennffgg-0

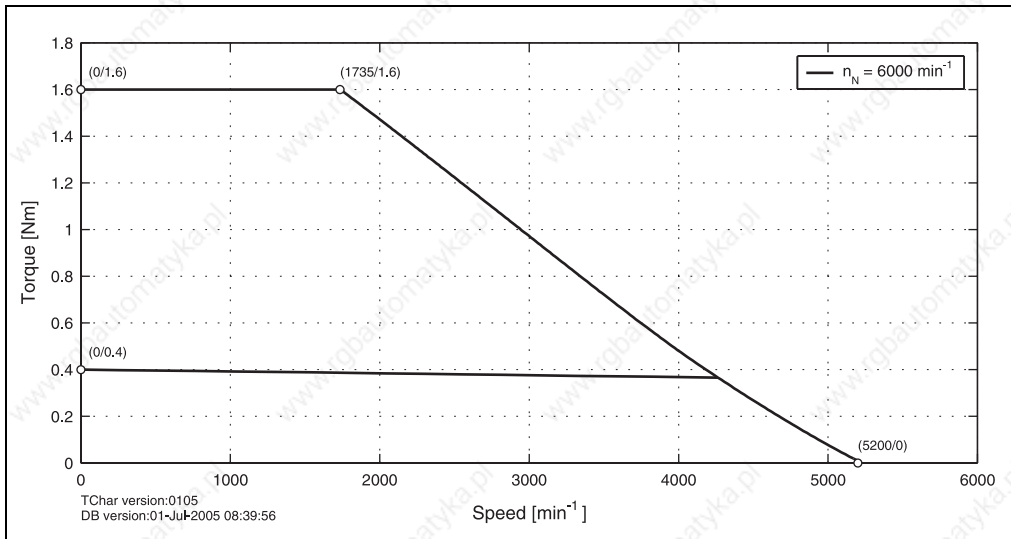

Figure 12: Speed - torque characteristic curve for 8LSA24.eennffgg-0

8LSA25.eennnffgg-0

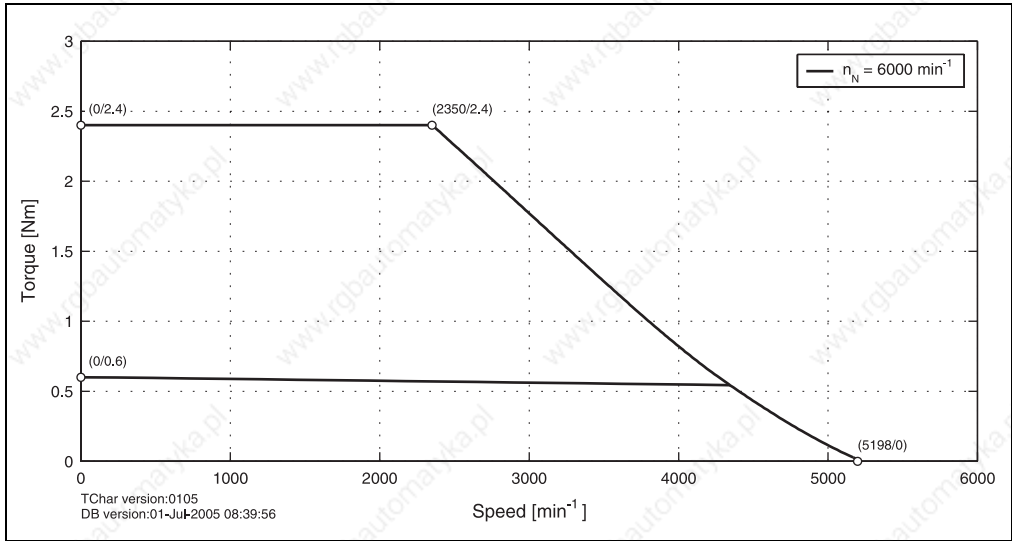

Figure 13: Speed - torque characteristic curve for 8LSA25.eennnffgg-0

8LSA26.eennnffgg-0

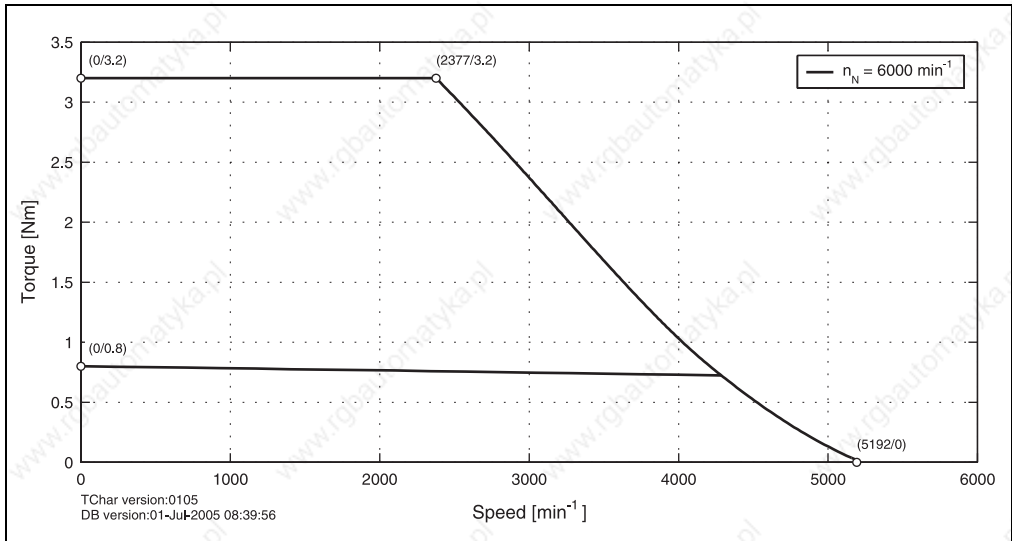
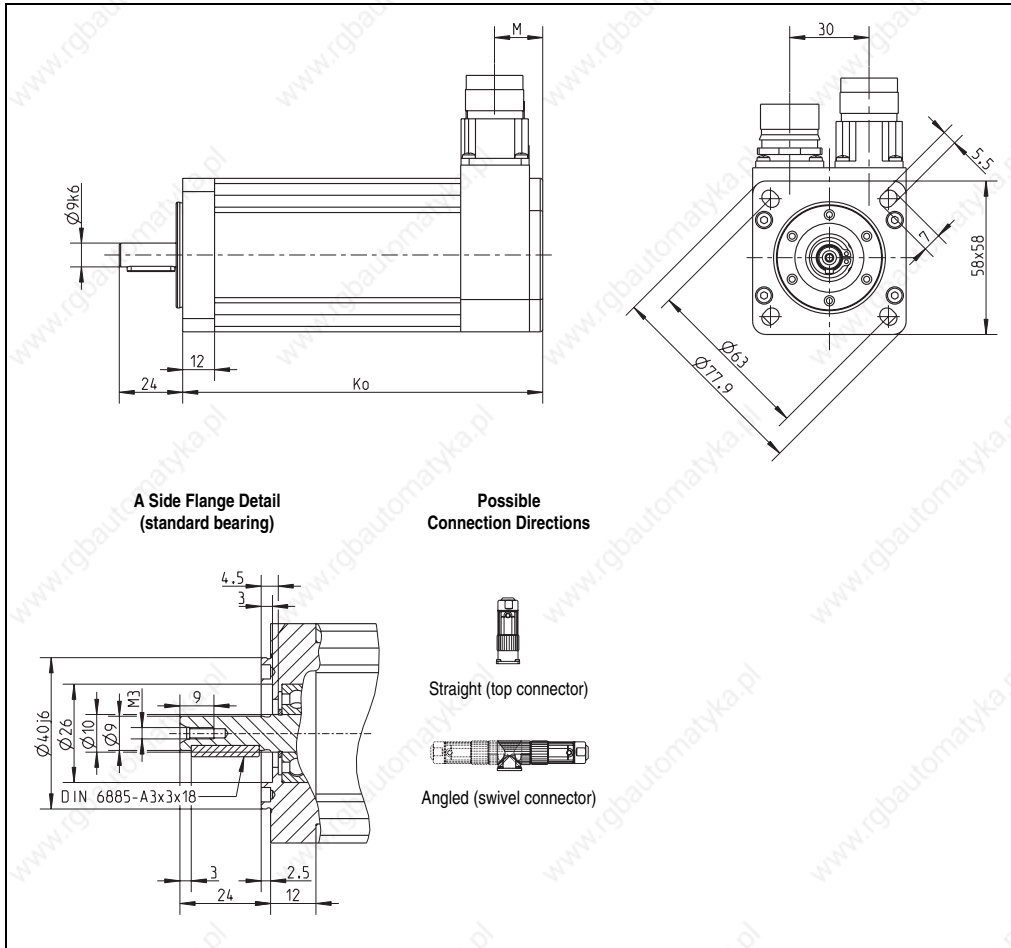

Figure 14: Speed - torque characteristic curve for 8LSA26.eennnffgg-0

1.9.4 Dimensions



EnDat Feedback			Resolver Feedback			Extension of K_0 depending on the Motor Option [mm] ¹⁾			
Model number	K_0	M	Model number	K_0	M	Holding brake	Oil seal	Reinforced A side bearing	
8LSA23.Exnnnffgg-0	126	28	8LSA23.R0nnnffgg-0	106	18	23.5	10	---	
8LSA24.Exnnnffgg-0	141		8LSA24.R0nnnffgg-0	121					
8LSA25.Exnnnffgg-0	156		8LSA25.R0nnnffgg-0	136					
8LSA26.Exnnnffgg-0	171		8LSA26.R0nnnffgg-0	151					

Table 15: 8LSA2 dimensions

1) If a combination of motor options is used (e.g. holding brake and oil seal), the sum of the extensions for the individual motor options must be added to K_0 .

1.9.5 Maximum Shaft Load

The values in the diagram below are based on a mechanical lifespan of the bearings of 20,000 operating hours.

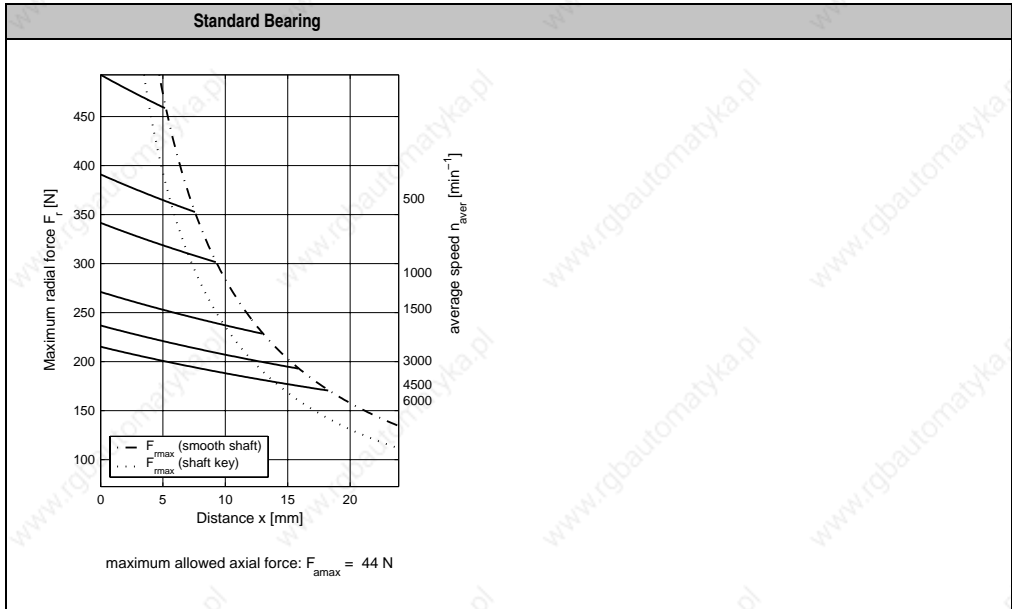

Table 16: Maximum shaft load for 8LSA2

1.10 Motor Data 8LSA3

1.10.1 Technical Data

	8LSA33.ee030/fgg-0			8LSA34.ee030/fgg-0			8LSA35.ee030/fgg-0			8LSA36.ee030/fgg-0		
	4500	4500	6000	4500	4500	6000	4500	4500	6000	4500	4500	6000
Rated Speed n_N [min ⁻¹]	3000			3000			3000			3000		
Number of Poles	4			4			4			4		
Rated Torque M_N [Nm]	0.7	0.67	0.6	1.4	1.3	1	2.1	1.8	1.6	2.7	2.2	1.8
Rated Power P_N [kW]	0.22	0.32	0.38	0.44	0.61	0.63	0.66	0.85	1.01	0.85	1.04	1.13
Rated Current I_N [A]	0.48	0.69	0.82	0.96	1.34	1.37	1.44	1.86	2.2	1.86	2.27	2.47
Stall Torque M_0 [Nm]	0.75			1.5			2.3			3		
Stalled Current I_0 [A]	0.52	0.77	1.03	1.03	1.55	2.06	1.58	2.37	3.16	2.07	3.09	4.12
Peak Torque M_{max} [Nm]	3			6			9.2			12		
Peak Current I_{max} [A]	2.22	3.32	4.43	4.43	6.65	8.87	6.8	10.2	13.6	8.9	13.3	17.73
Maximum Angular Acceleration without Brake a [rad/s ²]	85714			100000			102222			100000		
Maximum Speed n_{max} [min ⁻¹]	12000			12000			12000			12000		
Torque Constant K_T [Nm/A]	1.46	0.97	0.73	1.46	0.97	0.73	1.46	0.97	0.73	1.45	0.97	0.73
Voltage Constant K_E [V/1000 min ⁻¹]	87.96	58.64	43.98	87.96	58.64	43.98	87.96	58.64	43.98	87.96	58.64	43.98
Stator Resistance R_{2ph} [Ω]	108	44.48	27	34	15.56	8.5	19	8.1	4.5	11.45	5.16	2.9
Stator Inductance L_{2ph} [mH]	147.5	63.08	36.87	73.12	32.77	18.28	49.16	21.7	12.29	36.5	16.64	9.45
Electrical Time Constant t_{el} [ms]	1.37	1.4	1.37	2.15	2.2	2.15	2.59	2.68	2.73	3.19	3.23	3.26
Thermal Time Constant t_{therm} [min]	32			35			38			40		
Moment of Inertia without Brake J [kgcm ²]	0.35			0.6			0.9			1.2		
Weight without Brake m [kg]	1.4			2.2			3.1			4		
Moment of Inertia for Brake J_{Br} [kgcm ²]	0.38			0.38			0.38			0.38		
Weight of Brake m_{Br} [kg]	0.3			0.3			0.3			0.3		
Holding Torque of the Brake M_{Br} [Nm]	3.2			3.2			3.2			3.2		
Recommended Cable Cross Section for B&R Motor Cables [mm ²] ¹⁾	1.5			1.5			1.5			1.5		
Recommended ACOPOS Servo Drive 8Vxxxx.00-x ²⁾	1010	1016		1016	1022	1045	1022	1045		1045	1090	

Table 17: Technical data for 8LSA3

- 1) The B&R motor cables with this cable cross section are produced optimally (cables stripped to the correct length) for the recommended ACOPOS servo drives (see next line). B&R motor cables with other cable cross sections can also be used (within the specified terminal cross section range) and can be obtained from B&R in the desired design on request.
- 2) The recommended servo drive is defined for the stall current of the motor; if more than double the stall torque is required during the acceleration phase, the next larger servo drive should be selected. This recommendation is only a guideline, detailed inspection of the corresponding speed - torque characteristic curve can result in deviations of the servo drive size (one size larger or smaller).

1.10.2 Speed-Torque Characteristic Curves with 400 VAC Supply Voltage

8LSA33.eennffgg-0

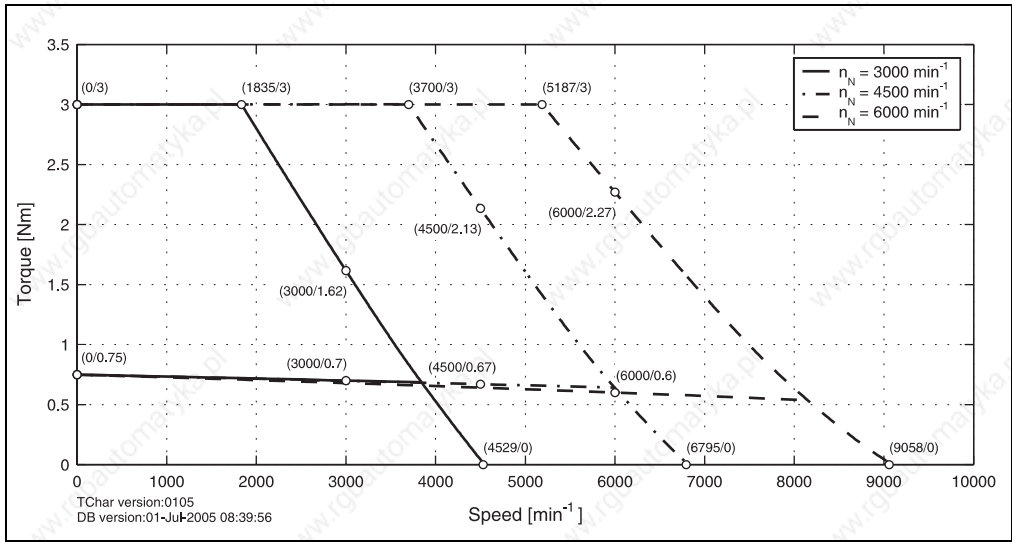

Figure 15: Speed - torque characteristic curve for 8LSA33.eennffgg-0

8LSA34.eennffgg-0

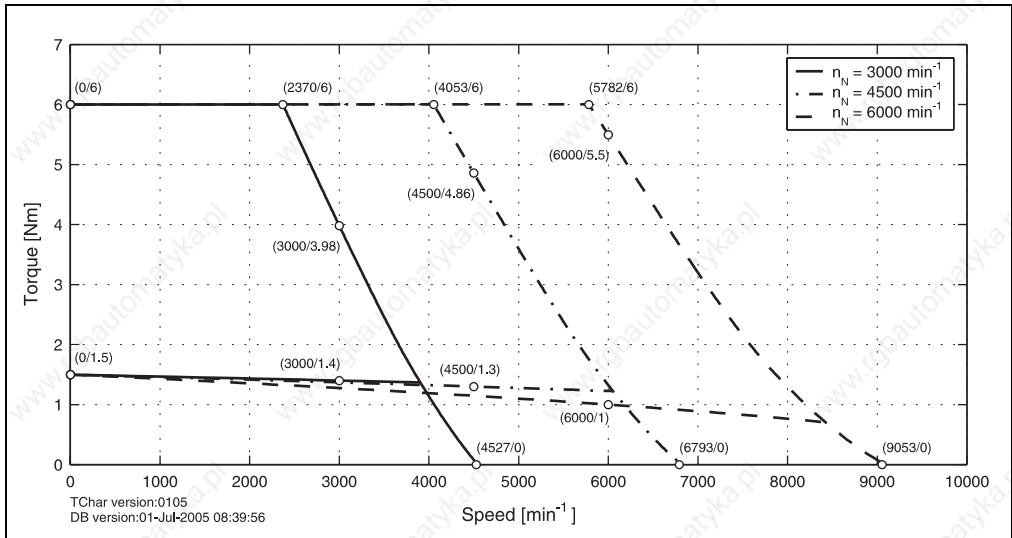

Figure 16: Speed - torque characteristic curve for 8LSA34.eennffgg-0

8LSA35.eennnffgg-0

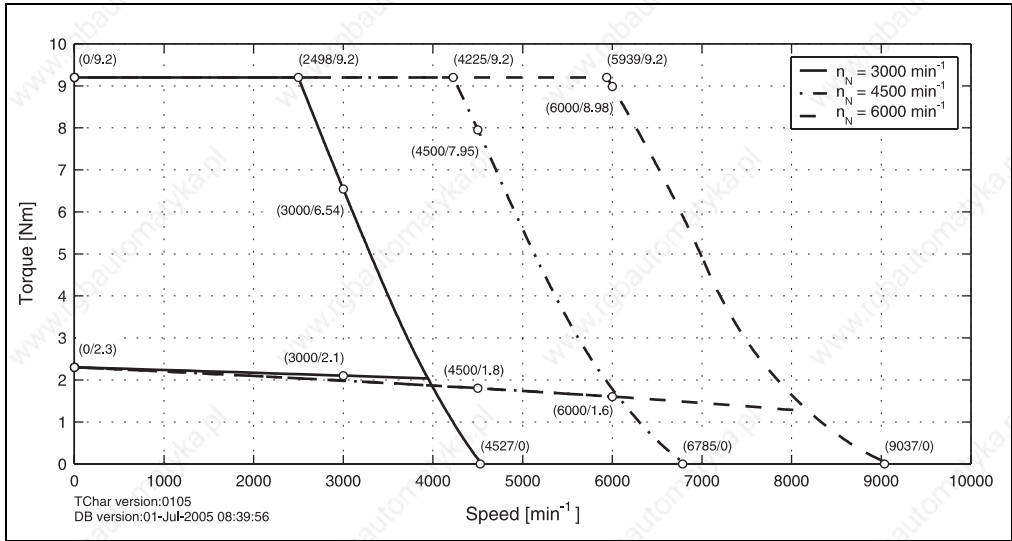

Figure 17: Speed - torque characteristic curve for 8LSA35.eennnffgg-0

8LSA36.eennnffgg-0

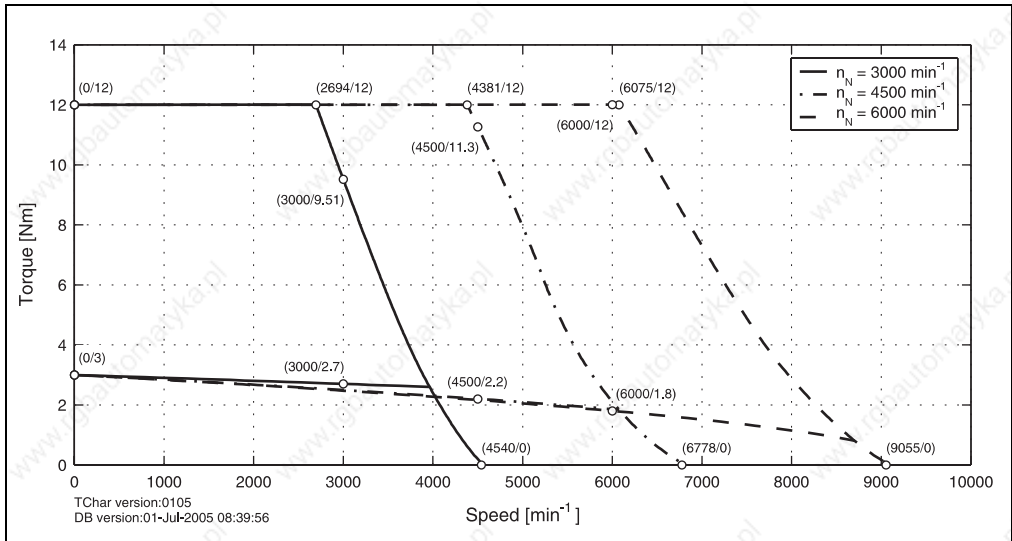

Figure 18: Speed - torque characteristic curve for 8LSA36.eennnffgg-0

1.10.3 Speed-Torque Characteristic Curves with 230 VAC Supply Voltage

8LSA33.eennffgg-0

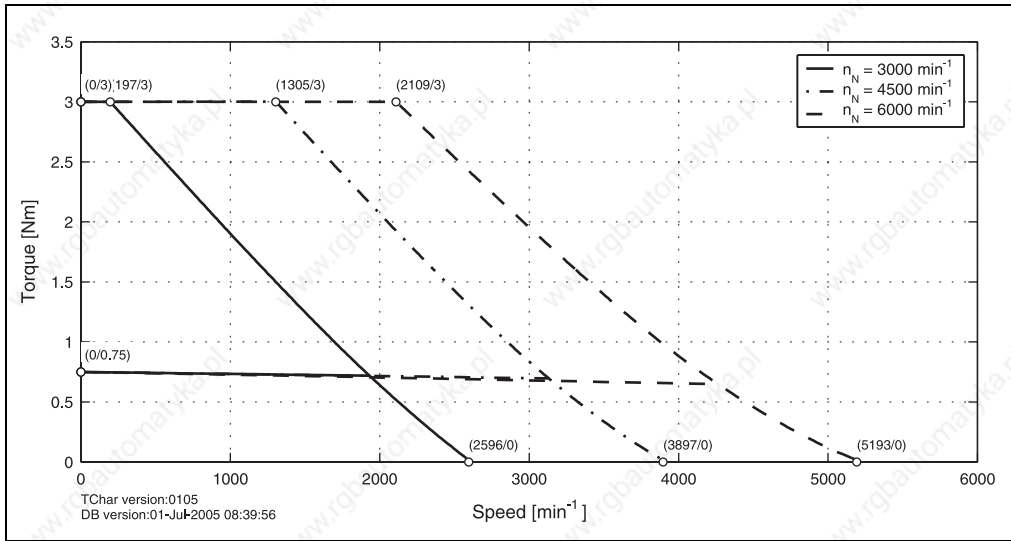

Figure 19: Speed - torque characteristic curve for 8LSA33.eennffgg-0

8LSA34.eennffgg-0

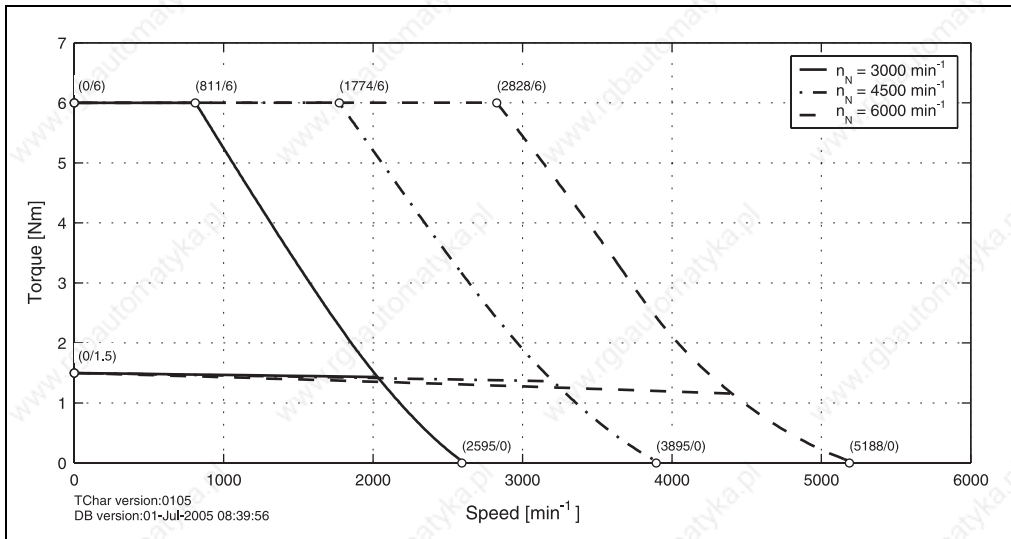

Figure 20: Speed - torque characteristic curve for 8LSA34.eennffgg-0

8LSA35.eennnffgg-0

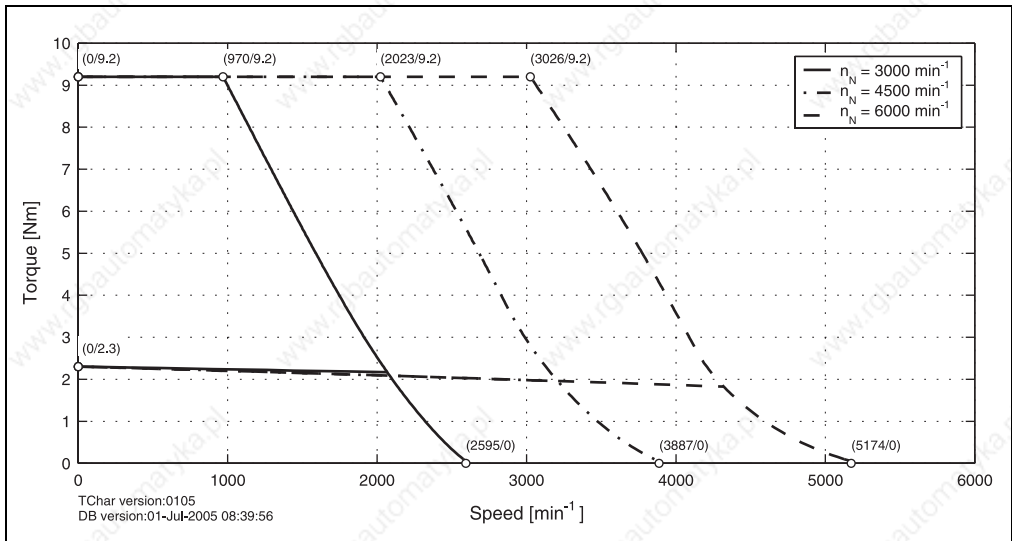

Figure 21: Speed - torque characteristic curve for 8LSA35.eennnffgg-0

8LSA36.eennnffgg-0

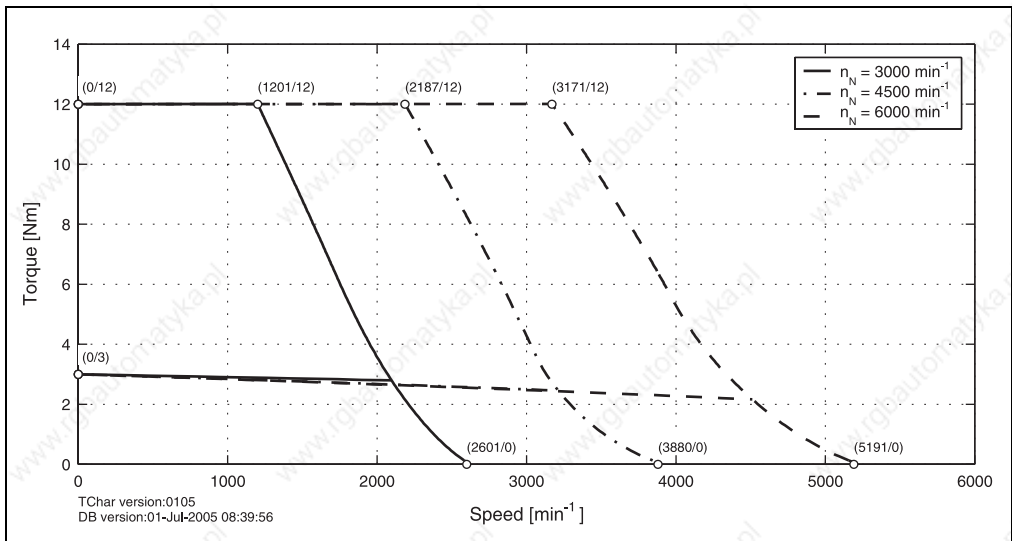
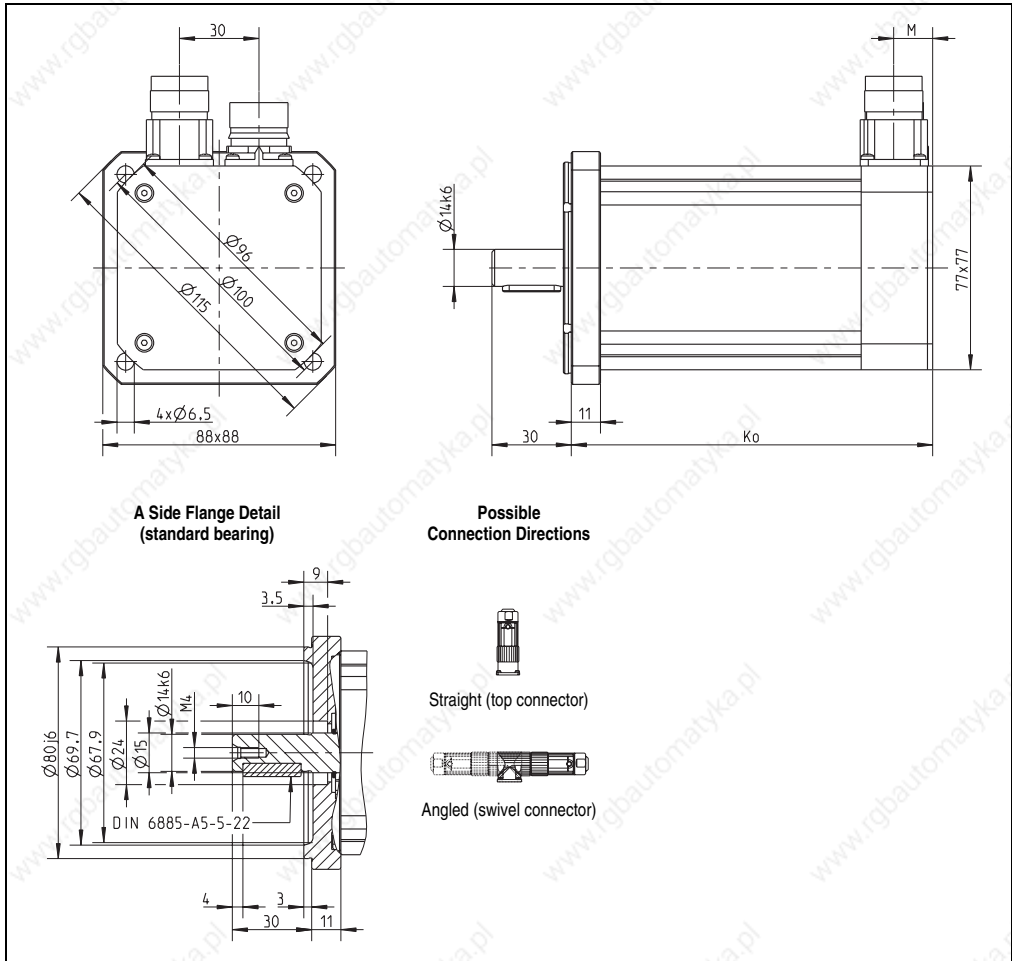

Figure 22: Speed - torque characteristic curve for 8LSA36.eennnffgg-0

1.10.4 Dimensions



EnDat Feedback			Resolver Feedback			Extension of K_0 depending on the Motor Option [mm]			
Model number	K_0	M	Model number	K_0	M	Holding brake	Oil seal	Reinforced A side bearing	
8LSA33.Exnnnfgg-0	161	32	8LSA33.R0nnnfgg-0	112	14.5	45	---	---	
8LSA34.Exnnnfgg-0	186		8LSA23.R0nnnfgg-0	137					
8LSA35.Exnnnfgg-0	211		8LSA35.R0nnnfgg-0	162					
8LSA36.Exnnnfgg-0	236		8LSA36.R0nnnfgg-0	187					

Table 18: 8LSA3 dimensions

1.10.5 Maximum Shaft Load

The values in the diagram below are based on a mechanical lifespan of the bearings of 20,000 operating hours.

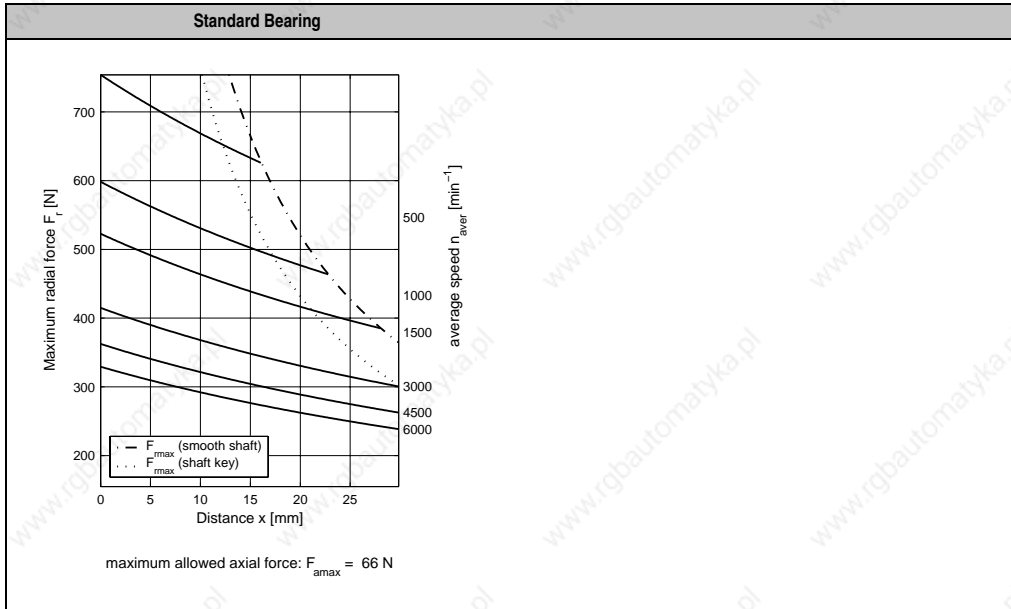

Table 19: Maximum shaft load for 8LSA3

1.11 Motor Data 8LSA4

1.11.1 Technical Data

	8LSA43.ee030/fgg-0			8LSA44.ee030/fgg-0			8LSA45.ee030/fgg-0			8LSA46.ee030/fgg-0		
	3000	4500	6000	3000	4500	6000	3000	4500	6000	3000	4500	6000
Rated Speed n_N [min ⁻¹]	3000	4500	6000	3000	4500	6000	3000	4500	6000	3000	4500	6000
Number of Poles	10			10			10			10		
Rated Torque M_N [Nm]	3.1	2.7	2	4.62	3.6	3	6.16	4.8	4	7.7	6	5
Rated Power P_N [kW]	0.97	1.27	1.26	1.45	1.7	1.88	1.94	2.26	2.51	2.42	2.83	3.14
Rated Current I_N [A]	1.9	2.49	2.46	2.84	3.33	3.69	3.78	4.43	4.91	4.73	5.54	6.14
Stall Torque M_0 [Nm]	4			6			8			10		
Stalled Current I_0 [A]	2.46	3.7	4.91	3.69	5.54	7.37	4.91	7.39	9.83	6.14	9.24	12.28
Peak Torque M_{max} [Nm]	16			24			32			40		
Peak Current I_{max} [A]	10.61	15.96	21.23	15.92	23.94	31.84	21.23	31.93	42.45	26.53	39.91	53.07
Maximum Angular Acceleration without Brake a [rad/s ²]	91429			94118			95522			97561		
Maximum Speed n_{max} [min ⁻¹]	12000			12000			12000			12000		
Torque Constant K_T [Nm/A]	1.63	1.08	0.81	1.63	1.08	0.81	1.63	1.08	0.81	1.63	1.08	0.81
Voltage Constant K_E [V/1000 min ⁻¹]	98.43	65.45	49.22	98.43	65.45	49.22	98.43	65.45	49.22	98.43	65.45	49.22
Stator Resistance R_{2ph} [Ω]	5.43	2.42	1.36	3.45	1.53	0.86	2.49	1.11	0.67	1.98	0.88	0.48
Stator Inductance L_{2ph} [mH]	36.5	16.5	9.2	24	10.8	6.2	21.80	9.69	5.45	17.44	7.75	4.36
Electrical Time Constant t_{ej} [ms]	6.72	6.83	6.77	6.96	7.04	7.19	8.76	8.76	8.13	8.81	8.79	9.08
Thermal Time Constant t_{therm} [min]	25			30			35			40		
Moment of Inertia without Brake J [kgcm ²]	1.75			2.55			3.35			4.1		
Weight without Brake m [kg]	3.9			5.26			6.7			8.1		
Moment of Inertia for Brake J_{Br} [kgcm ²]	0.54			0.54			0.54			0.54		
Weight of Brake m_{Br} [kg]	0.46			0.46			0.46			0.46		
Holding Torque of the Brake M_{Br} [Nm]	8			8			8			8		
Recommended Cable Cross Section for B&R Motor Cables [mm ²] ¹⁾	1.5			1.5			1.5	4		1.5	4	
Recommended ACOPOS Servo Drive 8Vxxxx.00-x ²⁾	1045	1090		1045	1090		1090	1180		1090	1180	

Table 20: Technical data for 8LSA4

- 1) The B&R motor cables with this cable cross section are produced optimally (cables stripped to the correct length) for the recommended ACOPOS servo drives (see next line). B&R motor cables with other cable cross sections can also be used (within the specified terminal cross section range) and can be obtained from B&R in the desired design on request.
- 2) The recommended servo drive is defined for the stall current of the motor; if more than double the stall torque is required during the acceleration phase, the next larger servo drive should be selected. This recommendation is only a guideline, detailed inspection of the corresponding speed - torque characteristic curve can result in deviations of the servo drive size (one size larger or smaller).

1.11.2 Speed-Torque Characteristic Curves with 400 VAC Supply Voltage

8LSA43.eennffgg-0

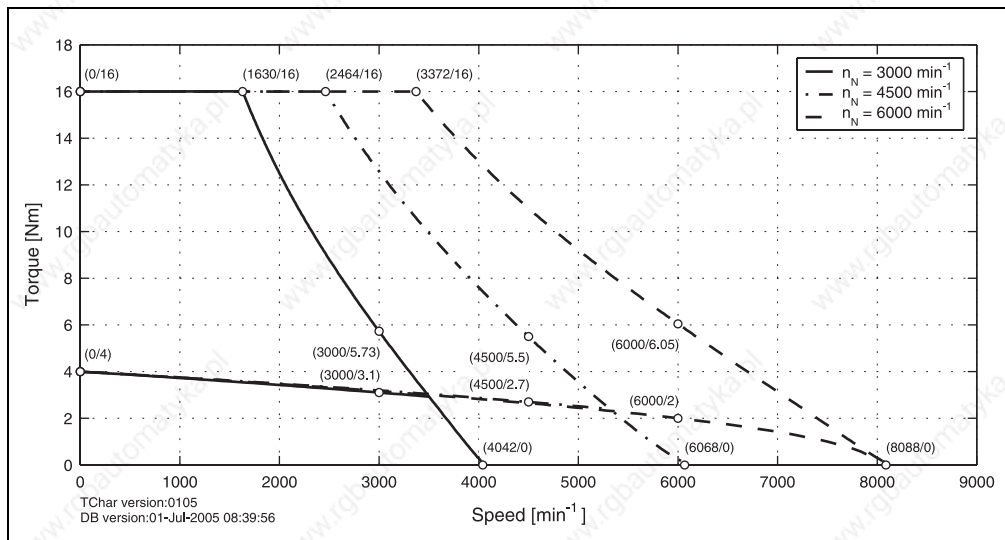

Figure 23: Speed - torque characteristic curve for 8LSA43.eennffgg-0

8LSA44.eennffgg-0

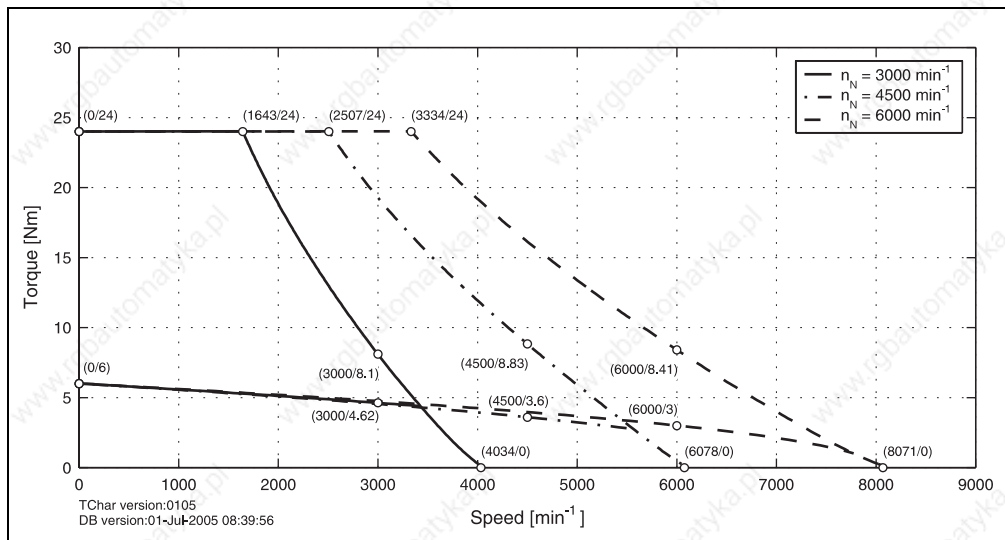

Figure 24: Speed - torque characteristic curve for 8LSA44.eennffgg-0

8LSA45.eennnffgg-0

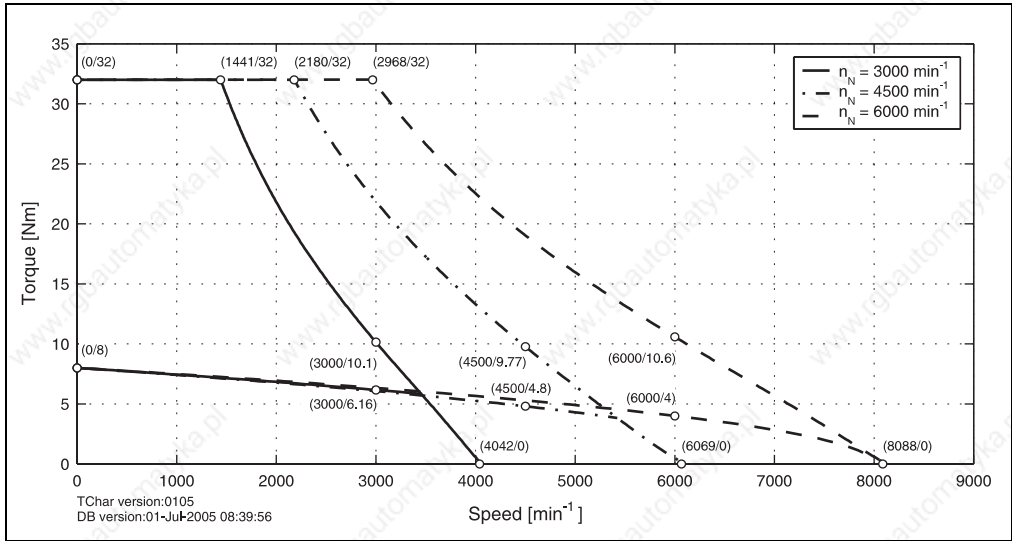

Figure 25: Speed - torque characteristic curve for 8LSA45.eennnffgg-0

8LSA46.eennnffgg-0

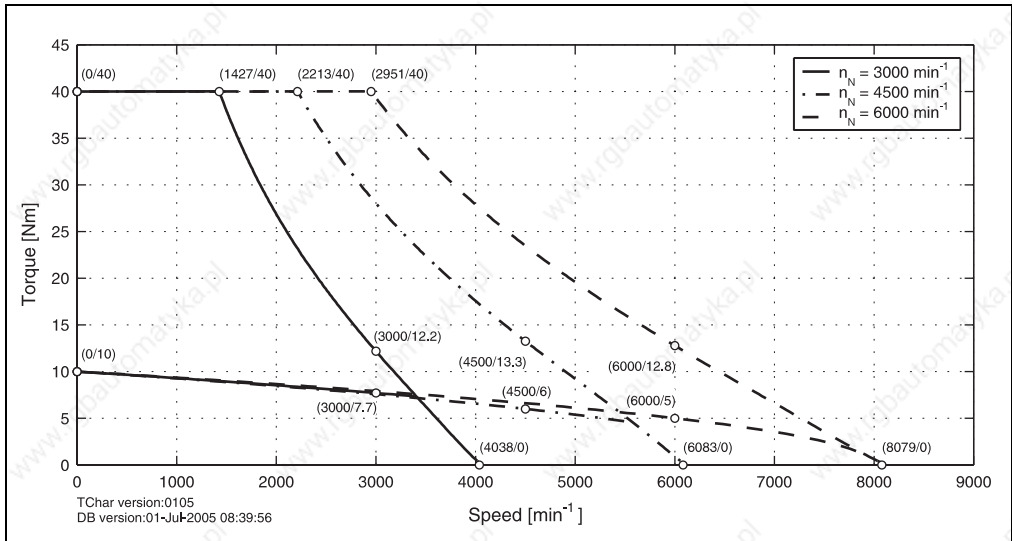

Figure 26: Speed - torque characteristic curve for 8LSA46.eennnffgg-0

1.11.3 Speed-Torque Characteristic Curves with 230 VAC Supply Voltage

8LSA43.eennffgg-0

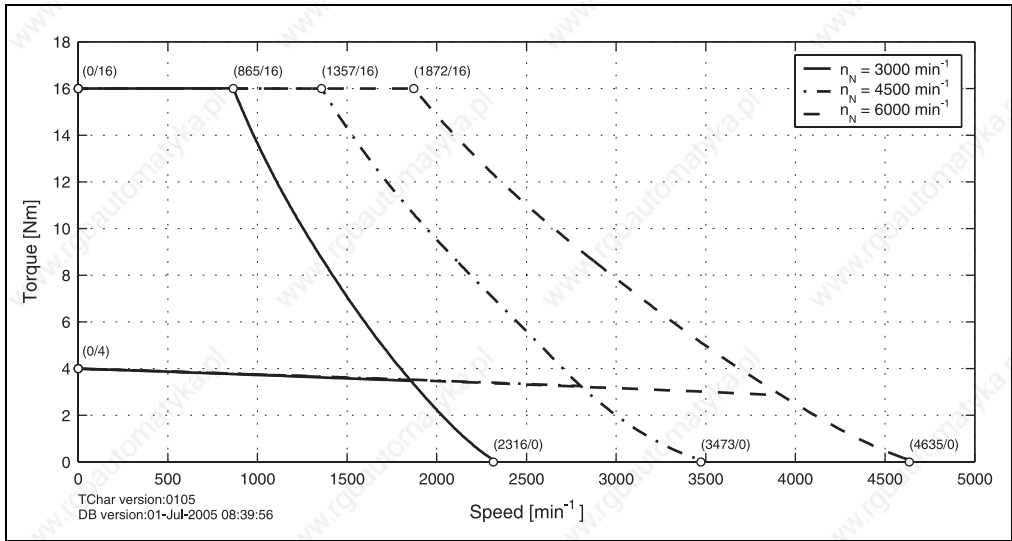

Figure 27: Speed - torque characteristic curve for 8LSA43.eennffgg-0

8LSA44.eennffgg-0

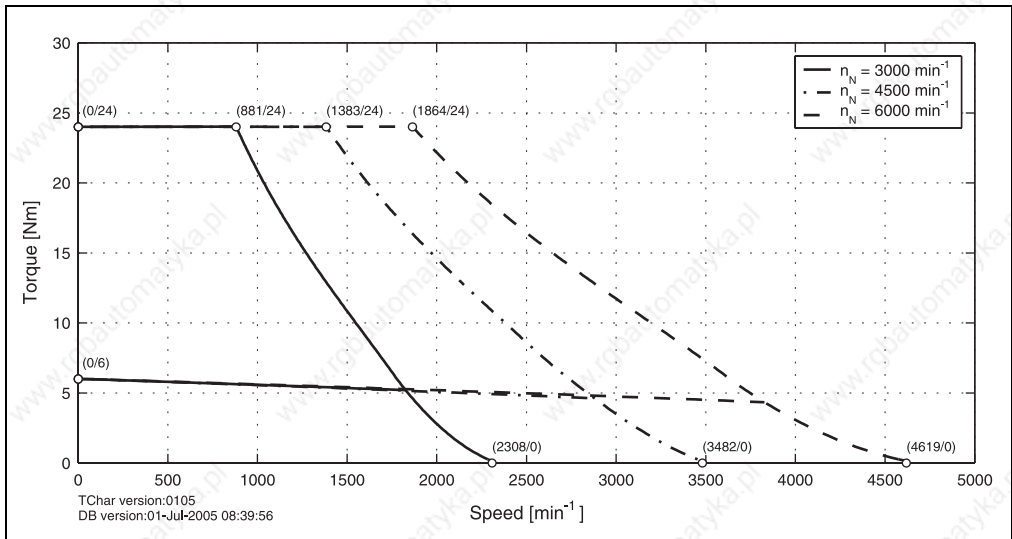

Figure 28: Speed - torque characteristic curve for 8LSA44.eennffgg-0

8LSA45.eennnffgg-0

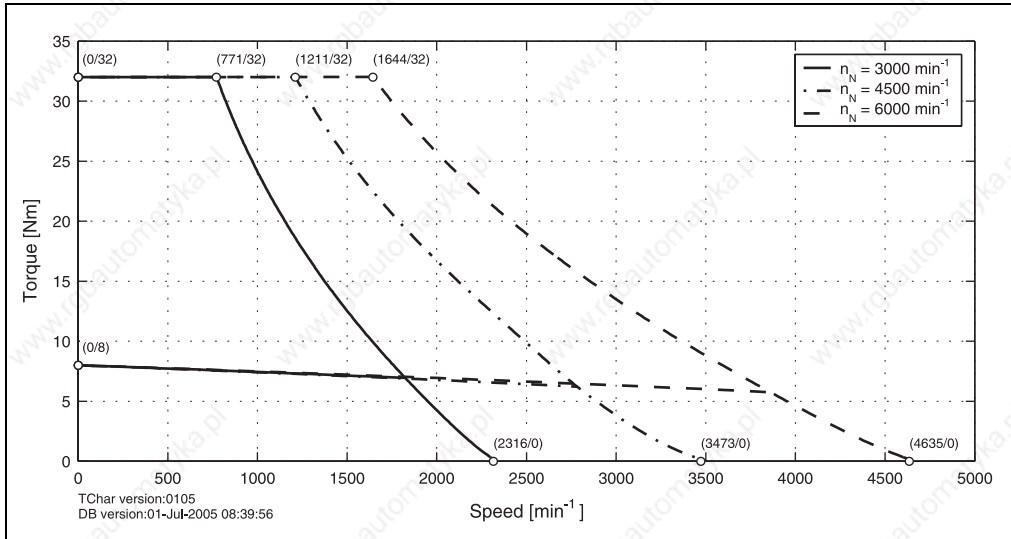

Figure 29: Speed - torque characteristic curve for 8LSA45.eennnffgg-0

8LSA46.eennnffgg-0

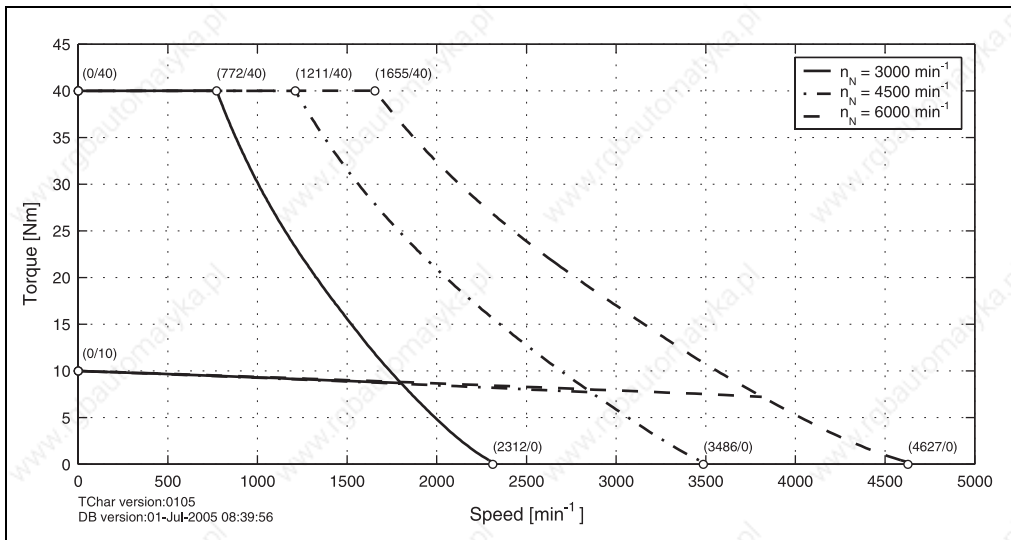

Figure 30: Speed - torque characteristic curve for 8LSA46.eennnffgg-0

1.11.5 Maximum Shaft Load

The values in the diagrams below are based on a mechanical lifespan of the bearings of 20,000 operating hours.

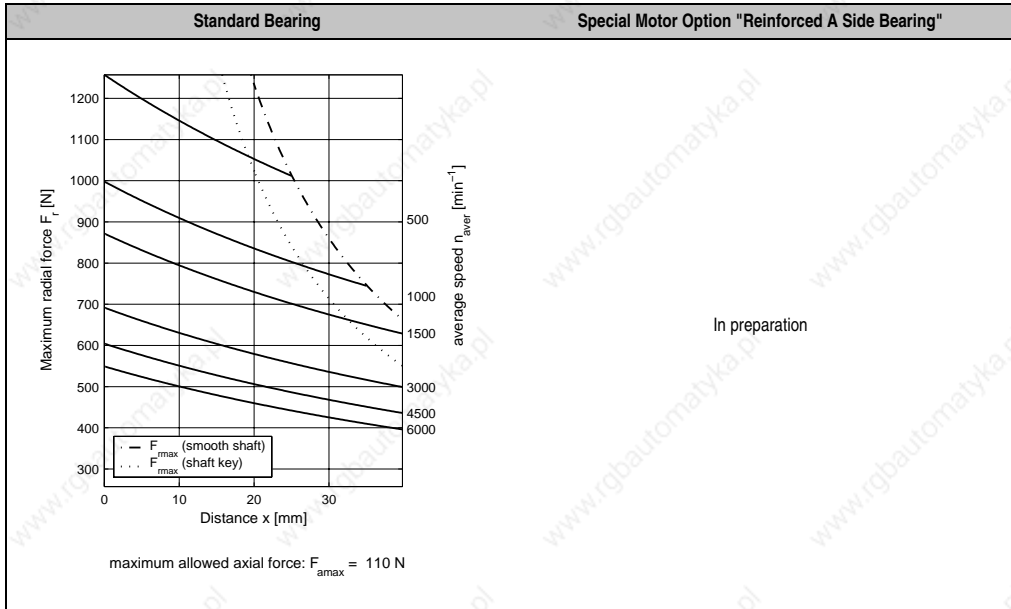

Table 22: Maximum shaft load for 8LSA4

1.12 Motor Data 8LSA5

1.12.1 Technical Data

	8LSA53.ee0307fgg-0	8LSA53.ee0457fgg-0	8LSA54.ee0307fgg-0	8LSA54.ee0457fgg-0	8LSA55.ee0307fgg-0	8LSA55.ee0457fgg-0	8LSA56.ee0307fgg-0	8LSA56.ee0457fgg-0	8LSA57.ee0307fgg-0	8LSA57.ee0457fgg-0
Rated Speed n_N [min ⁻¹]	3000	4500	3000	4500	3000	4500	3000	4500	3000	4500
Number of Poles	8		8		8		8		8	
Rated Torque M_N [Nm]	3.5	3	7	6	10.5	9	14	12	17.5	15
Rated Power P_N [kW]	1.1	1.41	2.2	2.83	3.3	4.24	4.4	5.65	5.5	7.07
Rated Current I_N [A]	2.15	2.73	4.29	5.45	6.44	8.18	8.59	10.91	10.74	13.64
Stall Torque M_0 [Nm]	4		8		12		16		20	
Stalled Current I_0 [A]	2.45	3.64	4.91	7.27	7.36	10.91	9.82	14.55	12.27	18.18
Peak Torque M_{max} [Nm]	12		24		36		48		60	
Peak Current I_{max} [A]	11.3	15.9	22.	33.3	33.8	47.6	45	62.3	53.1	79.7
Maximum Angular Acceleration without Brake a [rad/s ²]	30000		40000		45000		48000		50420	
Maximum Speed n_{max} [min ⁻¹]	9000		9000		9000		9000		9000	
Torque Constant K_T [Nm/A]	1.63	1.1	1.63	1.1	1.63	1.1	1.63	1.1	1.63	1.1
Voltage Constant K_E [V/1000 min ⁻¹]	98.43	65.97	98.43	65.97	98.43	65.97	98.43	65.97	98.43	65.97
Stator Resistance R_{2ph} [Ω]	9.72	4.97	3.1	1.32	1.6	0.8	1.07	0.56	0.89	0.39
Stator Inductance L_{2ph} [mH]	55.4	28.4	23.34	9.02	14.01	7.03	10.51	5.48	8.5	3.78
Electrical Time Constant t_{ei} [ms]	5.7	5.71	7.53	6.83	8.76	8.79	9.82	9.84	9.55	9.69
Thermal Time Constant t_{therm} [min]	36		40		43		48		50	
Moment of Inertia without Brake J [kgcm ²]	4		6		8		10		11.9	
Weight without Brake m [kg]	10.2		12		14.1		16.4		18.6	
Moment of Inertia for Brake J_{Br} [kgcm ²]	1.66		1.66		1.66		1.66		1.66	
Weight of Brake m_{Br} [kg]	0.9		0.9		0.9		0.9		0.9	
Holding Torque of the Brake M_{Br} [Nm]	15		15		15		15		15	
Recommended Cable Cross Section for B&R Motor Cables [mm ²] ¹⁾	1.5		1.5		1.5		4		4	
Recommended ACOPOS Servo Drive 8Vxxx.00-x ²⁾	1045		1090		1090		1180		1180	
									1320	

Table 23: Technical data for 8LSA5

- 1) The B&R motor cables with this cable cross section are produced optimally (cables stripped to the correct length) for the recommended ACOPOS servo drives (see next line). B&R motor cables with other cable cross sections can also be used (within the specified terminal cross section range) and can be obtained from B&R in the desired design on request.
- 2) The recommended servo drive is defined for the stall current of the motor; if more than double the stall torque is required during the acceleration phase, the next larger servo drive should be selected. This recommendation is only a guideline, detailed inspection of the corresponding speed - torque characteristic curve can result in deviations of the servo drive size (one size larger or smaller).

1.12.2 Speed-Torque Characteristic Curves with 400 VAC Supply Voltage

8LSA53.eennffgg-0

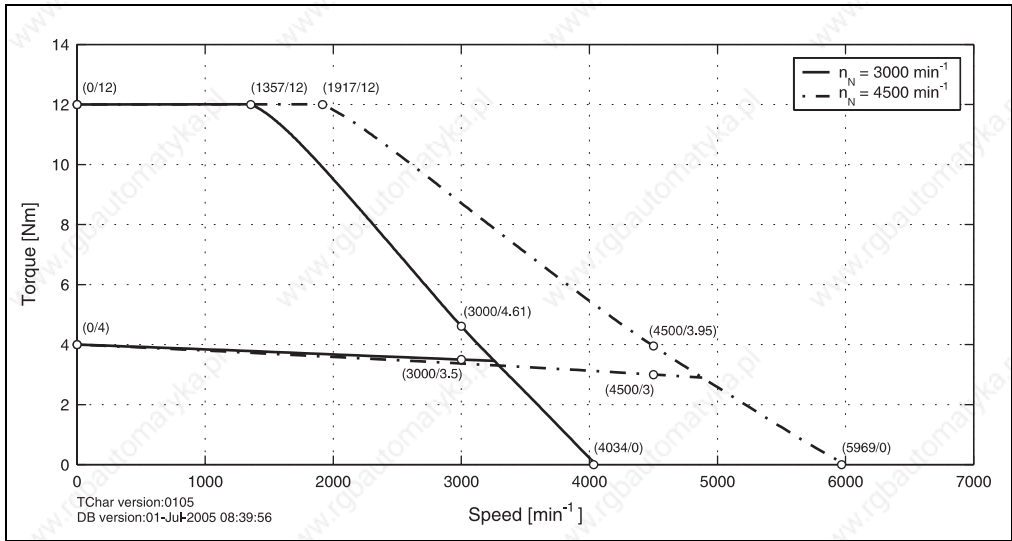

Figure 31: Speed - torque characteristic curve for 8LSA53.eennffgg-0

8LSA54.eennffgg-0

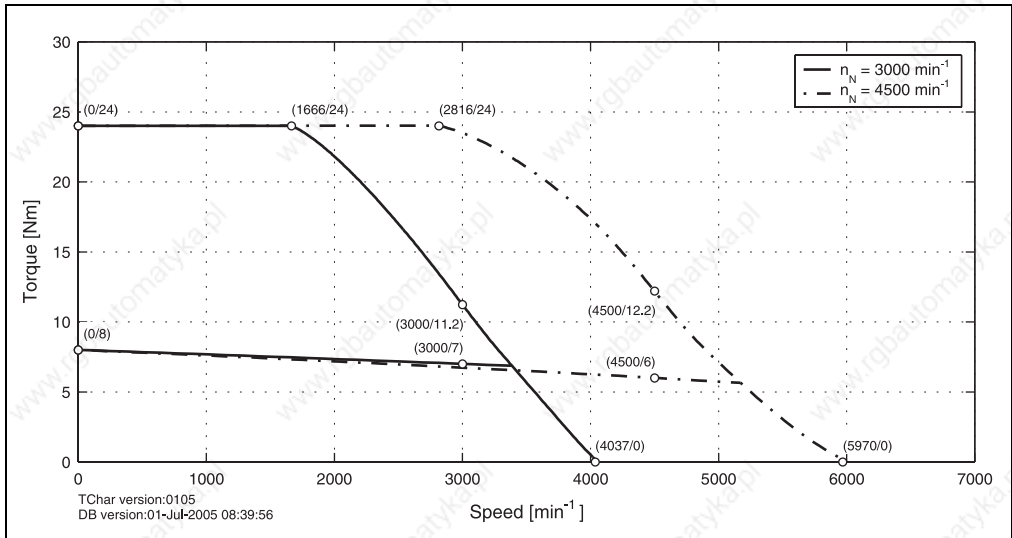

Figure 32: Speed - torque characteristic curve for 8LSA54.eennffgg-0

8LSA55.eennnffgg-0

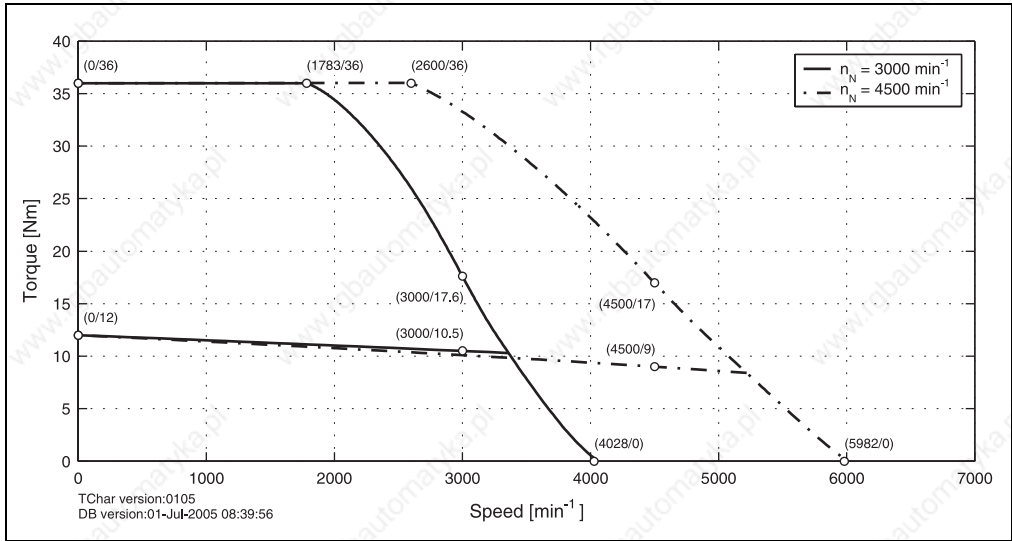

Figure 33: Speed - torque characteristic curve for 8LSA55.eennnffgg-0

8LSA56.eennnffgg-0

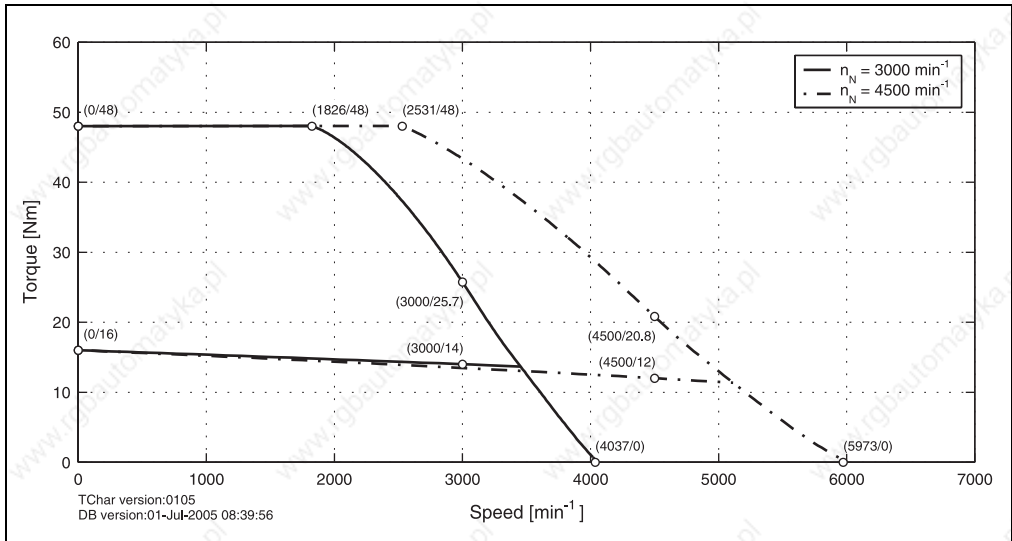

Figure 34: Speed - torque characteristic curve for 8LSA56.eennnffgg-0

8LSA57.eennnffgg-0

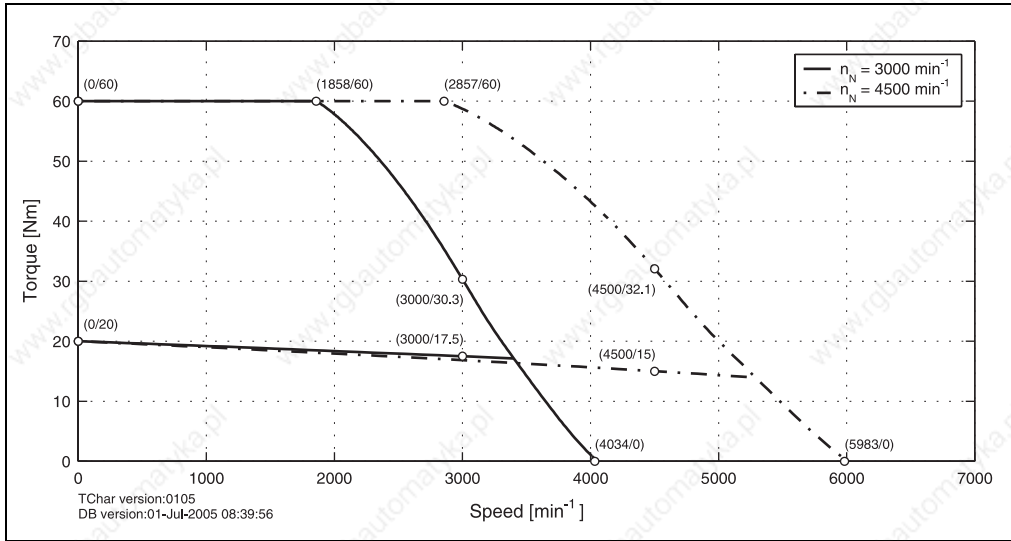

Figure 35: Speed - torque characteristic curve for 8LSA57.eennnffgg-0

1.12.3 Speed-Torque Characteristic Curves with 230 VAC Supply Voltage

8LSA53.eennnffgg-0

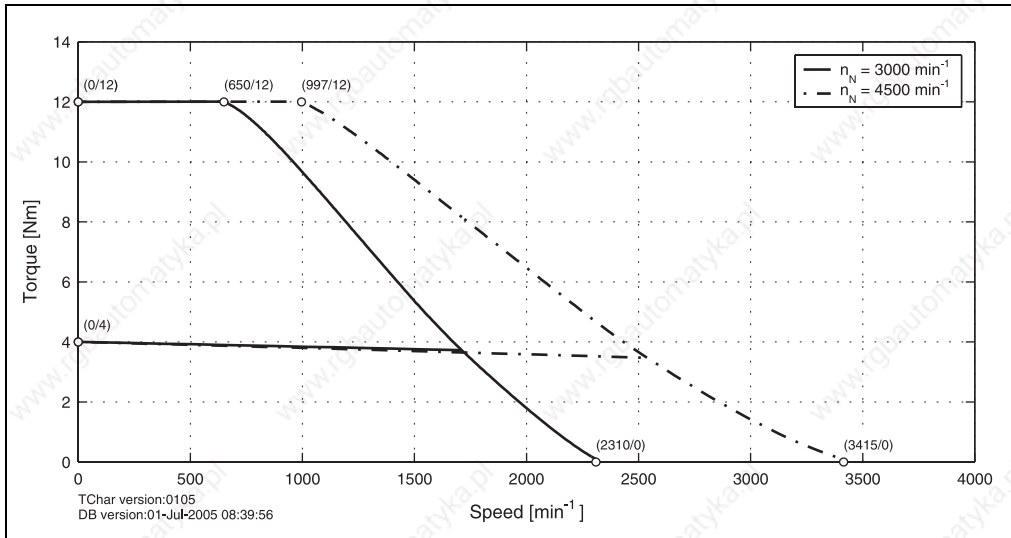

Figure 36: Speed - torque characteristic curve for 8LSA53.eennnffgg-0

8LSA54.eennnffgg-0

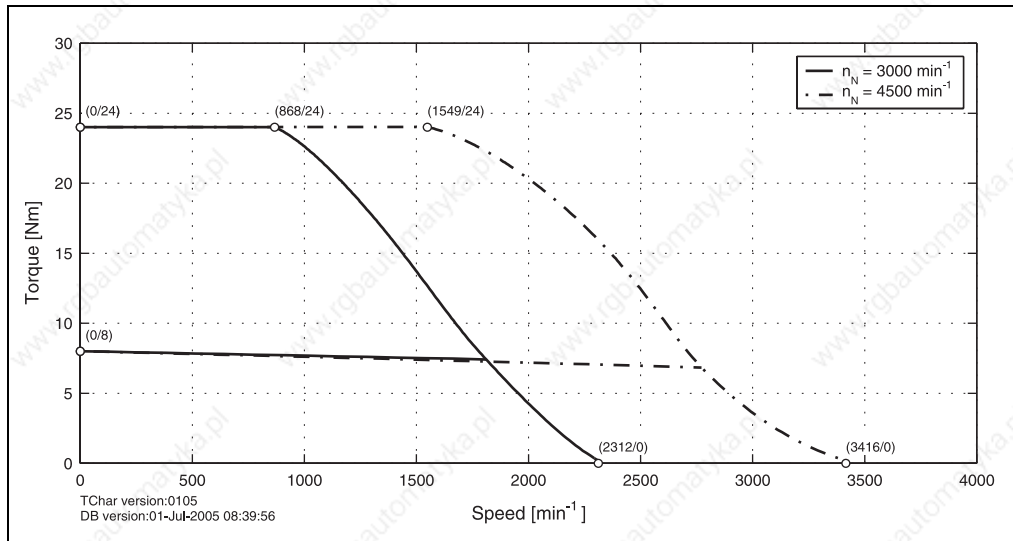

Figure 37: Speed - torque characteristic curve for 8LSA54.eennnffgg-0

8LSA55.eennnffgg-0

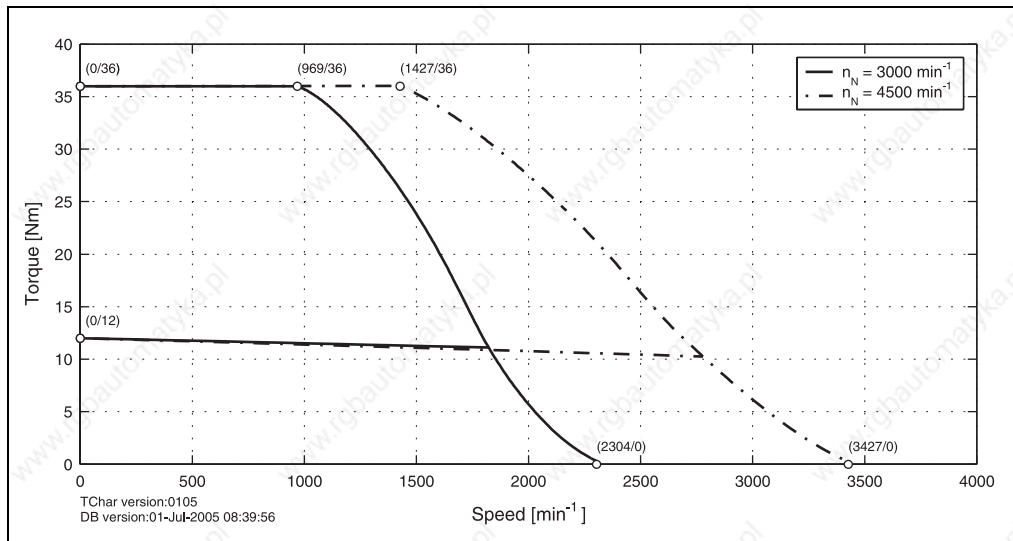

Figure 38: Speed - torque characteristic curve for 8LSA55.eennnffgg-0

8LSA56.eennnffgg-0

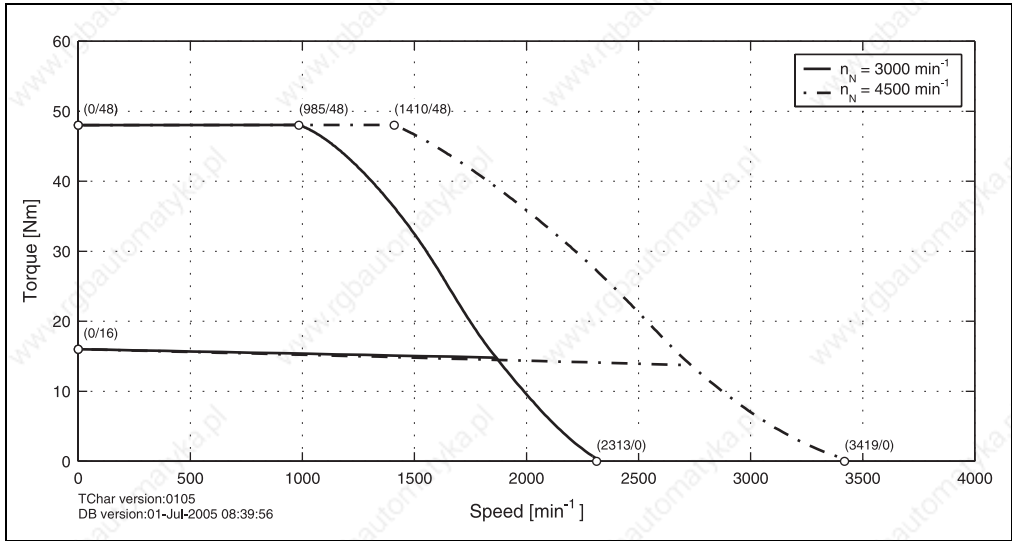

Figure 39: Speed - torque characteristic curve for 8LSA56.eennnffgg-0

8LSA57.eennnffgg-0

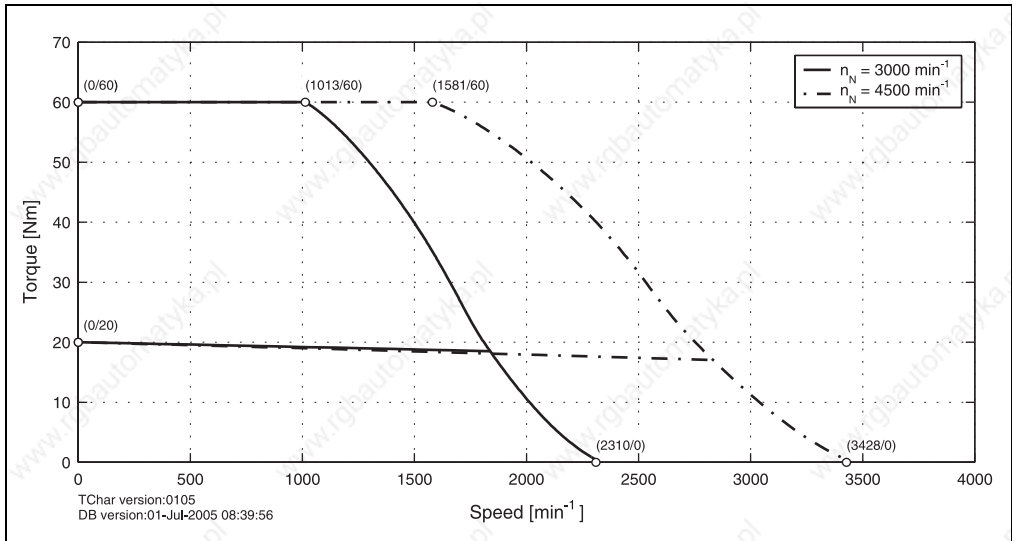
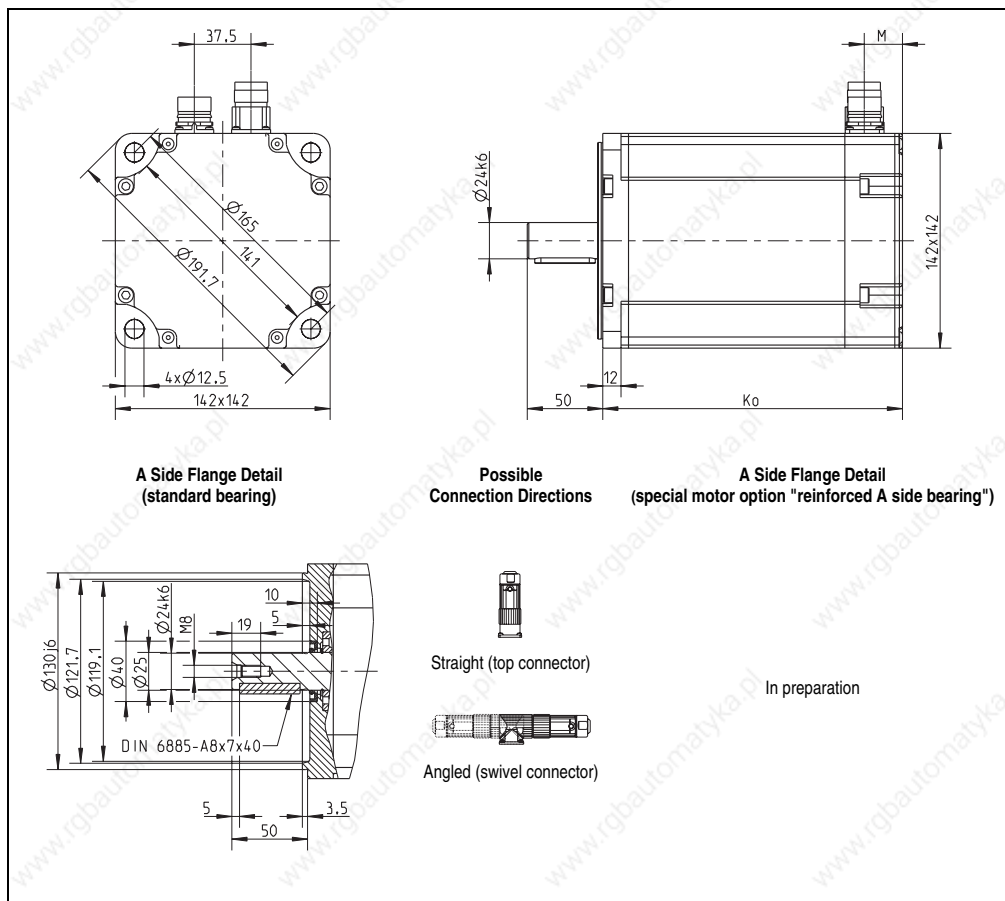

Figure 40: Speed - torque characteristic curve for 8LSA57.eennnffgg-0

1.12.4 Dimensions



EnDat Feedback			Resolver Feedback			Extension of K_0 depending on the Motor Option [mm]			
Model number	K_0	M	Model number	K_0	M	Holding brake	Oil seal	Reinforced A side bearing	
8LSA53.Exnnnfgg-0	203	55	8LSA53.R0nnnfgg-0	173	25	30	---	---	
8LSA54.Exnnnfgg-0	228		8LSA54.R0nnnfgg-0	198					
8LSA55.Exnnnfgg-0	253		8LSA55.R0nnnfgg-0	223					
8LSA56.Exnnnfgg-0	278		8LSA56.R0nnnfgg-0	248					
8LSA57.Exnnnfgg-0	303		8LSA57.R0nnnfgg-0	273					

Table 24: 8LSA5 dimensions

1.12.5 Maximum Shaft Load

The values in the diagrams below are based on a mechanical lifespan of the bearings of 20,000 operating hours.

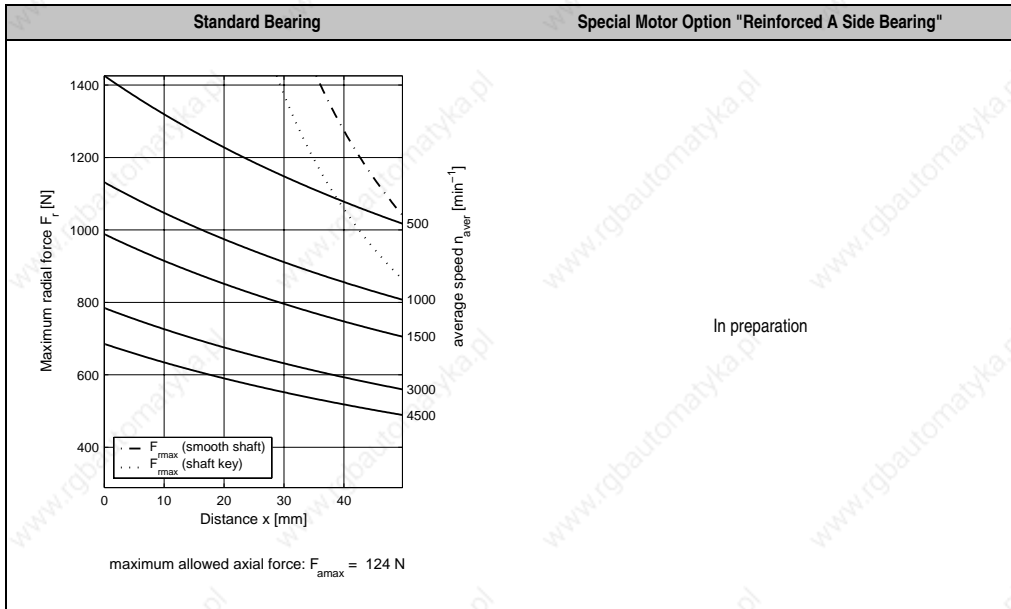

Table 25: Maximum shaft load for 8LSA5

1.13 Motor Data 8LSA6

1.13.1 Technical Data

	8LSA63.ee030/fgg-0	8LSA63.ee045/fgg-0	8LSA64.ee030/fgg-0	8LSA64.ee045/fgg-0	8LSA65.ee030/fgg-0	8LSA65.ee045/fgg-0	8LSA66.ee030/fgg-0	8LSA66.ee045/fgg-0
Rated Speed n_N [min ⁻¹]	3000	4500	3000	4500	3000	4500	3000	4500
Number of Poles	8		8		8		8	
Rated Torque M_N [Nm]	11.6	8.9	17.5	10.6	21	10.9	23.2	12
Rated Power P_N [kW]	3.64	4.19	5.5	5	6.6	5.14	7.29	5.65
Rated Current I_N [A]	7.12	8.09	10.74	9.64	12.88	9.91	14.23	10.91
Stall Torque M_0 [Nm]	12		20		24		28	
Stalled Current I_0 [A]	7.36	10.91	12.27	18.18	14.72	21.82	17.18	25.45
Peak Torque M_{max} [Nm]	40.8		68		81.6		95.2	
Peak Current I_{max} [A]	44	62	69	104	87	130	104	149
Maximum Angular Acceleration without Brake a [rad/s ²]	51000		57143		59130		60637	
Maximum Speed n_{max} [min ⁻¹]	6000		6000		6000		6000	
Torque Constant K_T [Nm/A]	1.63	1.1	1.63	1.1	1.63	1.1	1.63	1.1
Voltage Constant K_E [V/1000 min ⁻¹]	98.43	65.97	98.43	65.97	98.43	65.97	98.43	65.97
Stator Resistance R_{2ph} [Ω]	1.6	0.8	0.89	0.39	0.65	0.29	0.5	0.25
Stator Inductance L_{2ph} [mH]	14.01	7.03	8.5	3.78	6.53	2.9	5.29	2.59
Electrical Time Constant t_{el} [ms]	8.76	8.79	9.55	9.69	10.05	10.14	10.58	10.57
Thermal Time Constant t_{therm} [min]	45		50		55		60	
Moment of Inertia without Brake J [kgcm ²]	8		11.9		13.8		15.7	
Weight without Brake m [kg]	14.1		18.6		20.8		23	
Moment of Inertia for Brake J_B [kgcm ²]	5.85		5.85		5.85		5.85	
Weight of Brake m_B [kg]	1.6		1.6		1.6		1.6	
Holding Torque of the Brake M_B [Nm]	32		32		32		32	
Recommended Cable Cross Section for B&R Motor Cables [mm ²] ¹⁾	1.5	4	4		4		4	
Recommended ACOPOS Servo Drive 8Vxxx.00-x ²⁾	1090	1180	1180	1320	1180	1320	1180	1320

Table 26: Technical data for 8LSA6

- 1) The B&R motor cables with this cable cross section are produced optimally (cables stripped to the correct length) for the recommended ACOPOS servo drives (see next line). B&R motor cables with other cable cross sections can also be used (within the specified terminal cross section range) and can be obtained from B&R in the desired design on request.
- 2) The recommended servo drive is defined for the stall current of the motor; if more than double the stall torque is required during the acceleration phase, the next larger servo drive should be selected. This recommendation is only a guideline, detailed inspection of the corresponding speed - torque characteristic curve can result in deviations of the servo drive size (one size larger or smaller).

1.13.2 Speed-Torque Characteristic Curves with 400 VAC Supply Voltage

8LSA63.eennnffgg-0

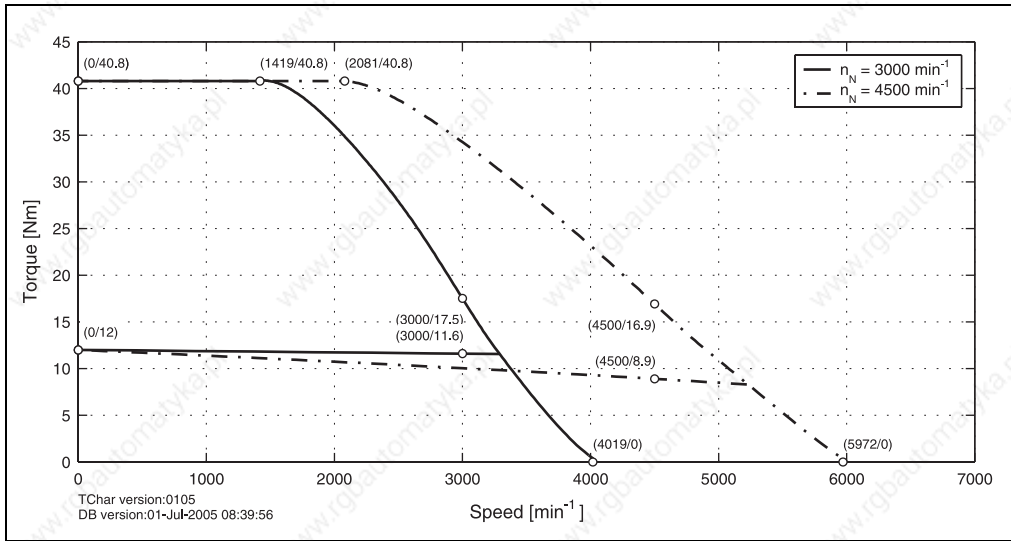

Figure 41: Speed - torque characteristic curve for 8LSA63.eennnffgg-0

8LSA64.eennnffgg-0

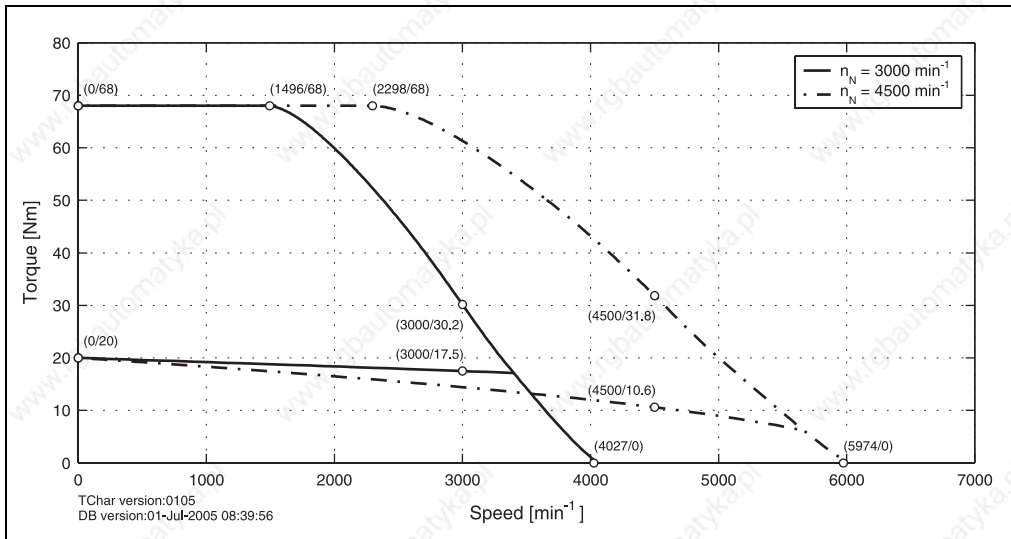

Figure 42: Speed - torque characteristic curve for 8LSA64.eennnffgg-0

8LSA65.eennnffgg-0

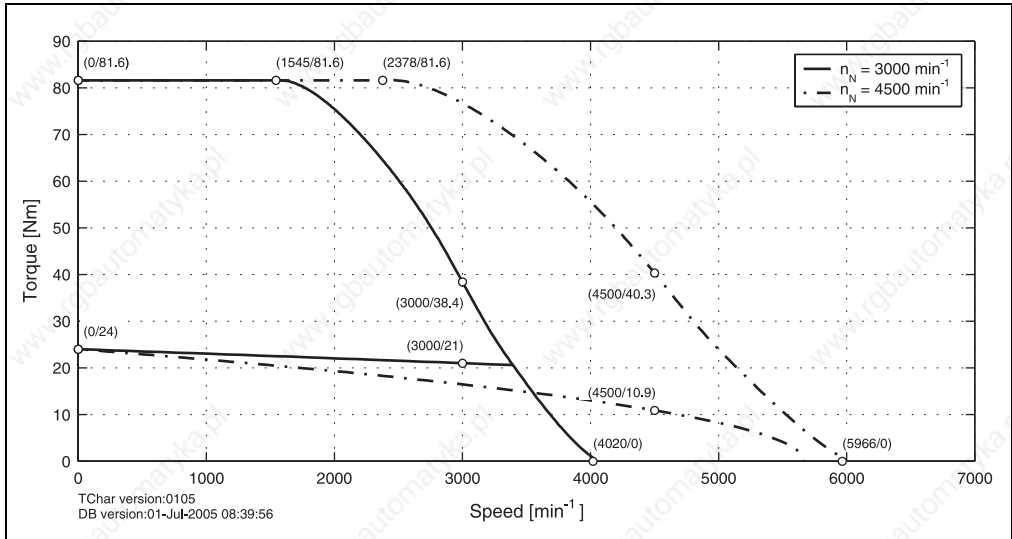

Figure 43: Speed - torque characteristic curve for 8LSA65.eennnffgg-0

8LSA66.eennnffgg-0

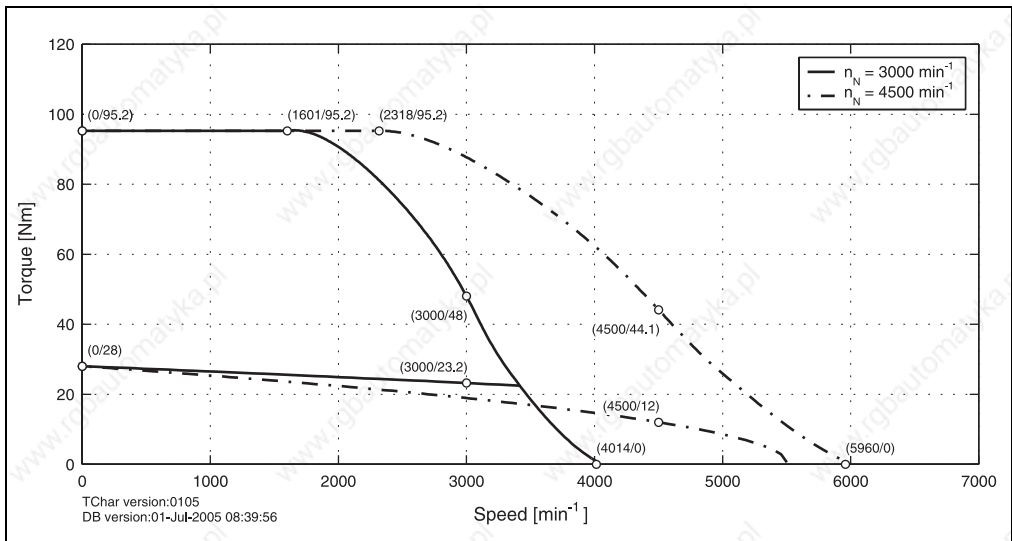

Figure 44: Speed - torque characteristic curve for 8LSA66.eennnffgg-0

1.13.3 Speed-Torque Characteristic Curves with 230 VAC Supply Voltage

8LSA63.eennffgg-0

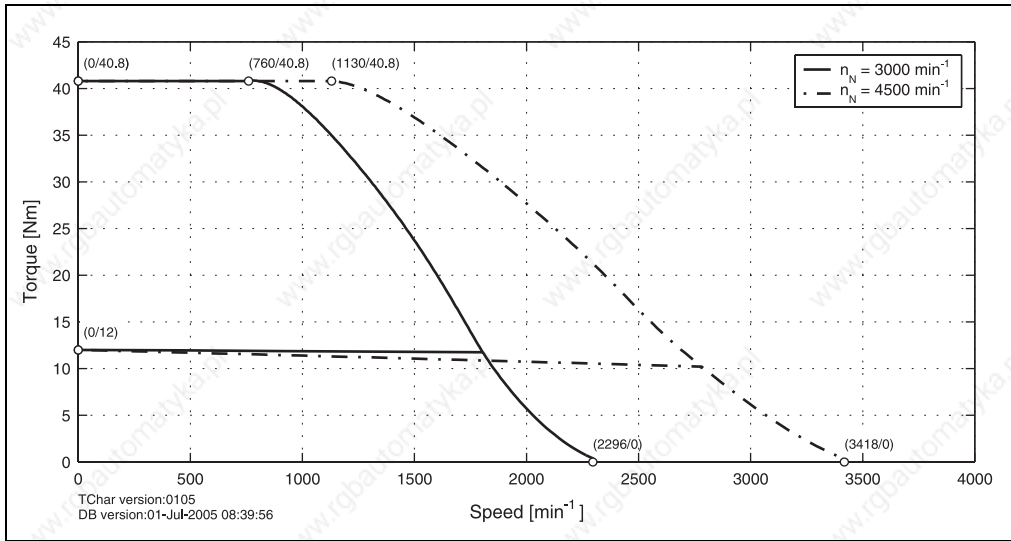

Figure 45: Speed - torque characteristic curve for 8LSA63.eennffgg-0

8LSA64.eennffgg-0

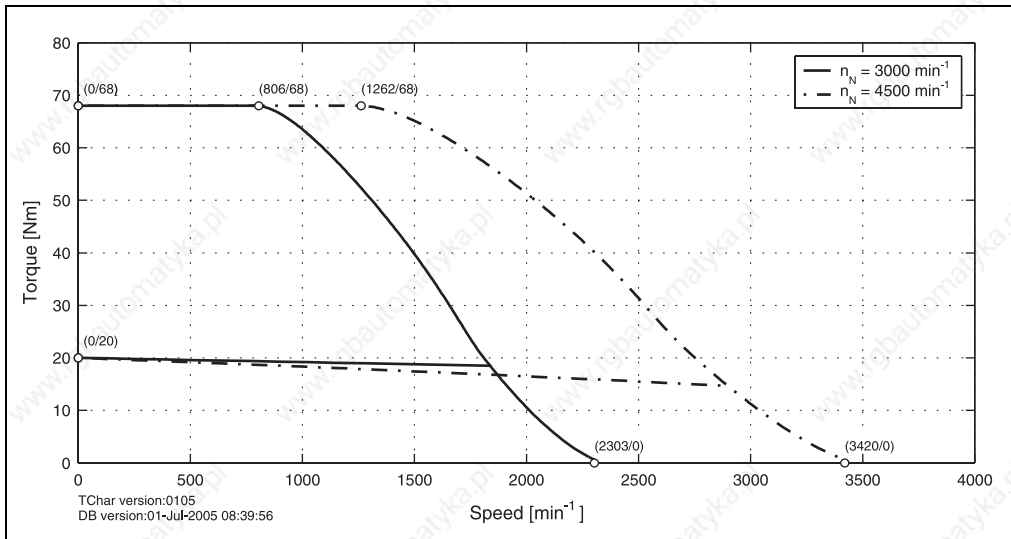

Figure 46: Speed - torque characteristic curve for 8LSA64.eennffgg-0

8LSA65.eennnffgg-0

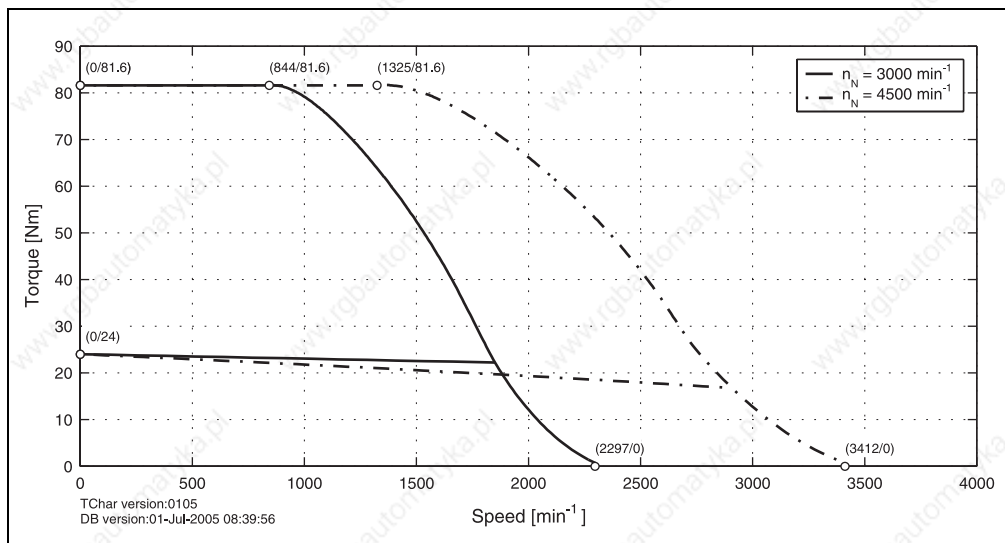

Figure 47: Speed - torque characteristic curve for 8LSA65.eennnffgg-0

8LSA66.eennnffgg-0

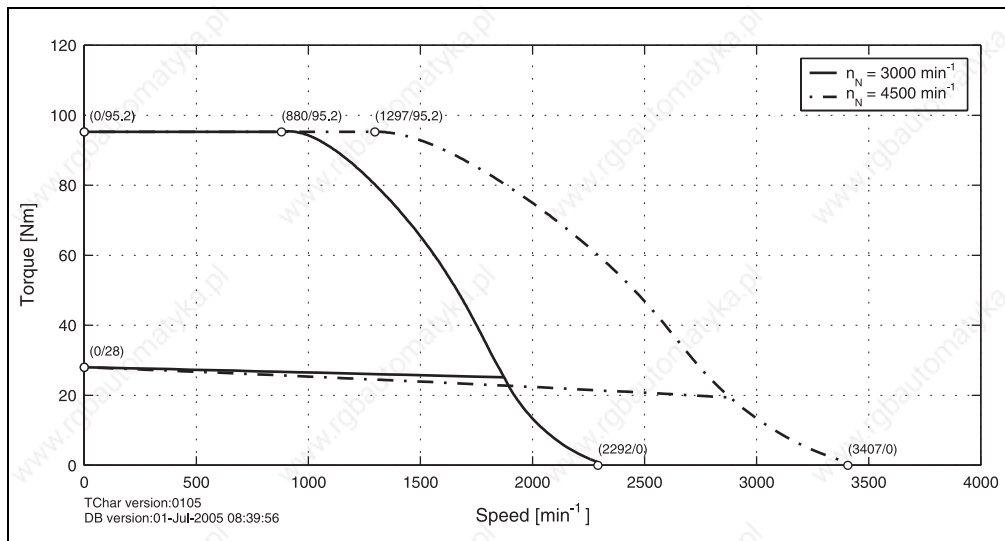
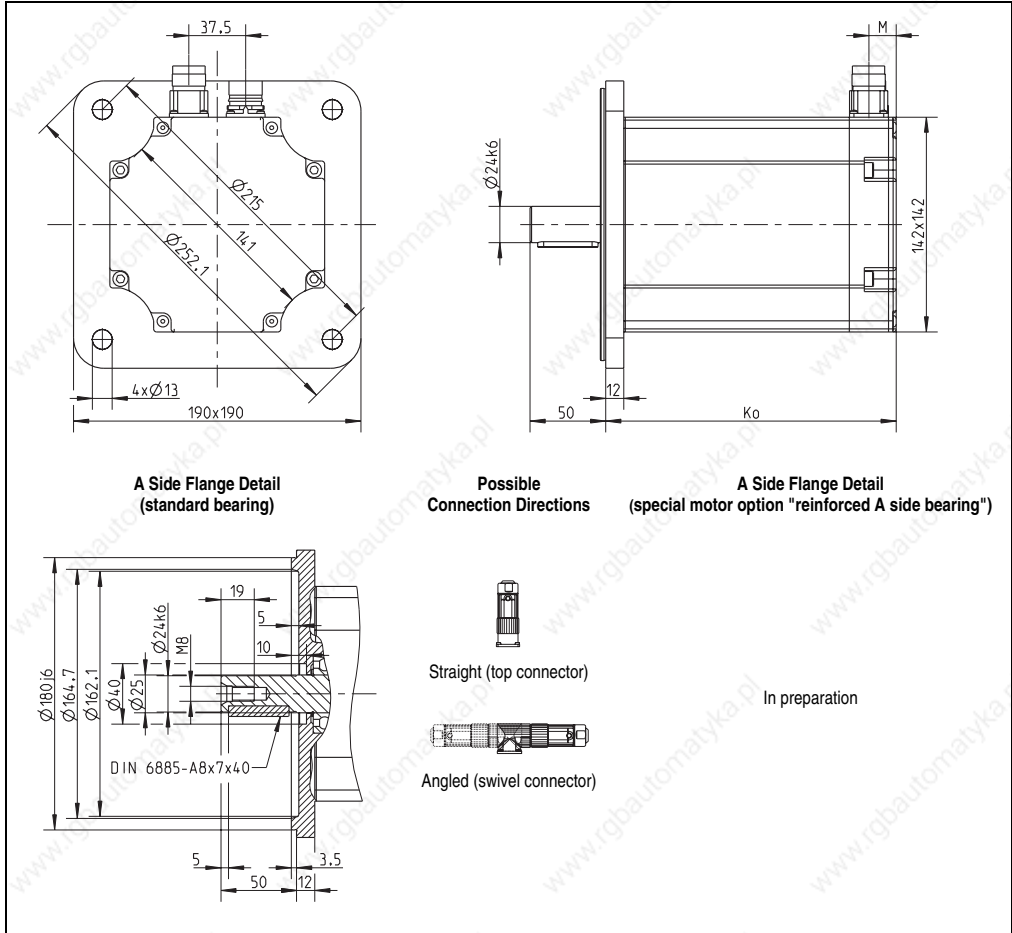

Figure 48: Speed - torque characteristic curve for 8LSA66.eennnffgg-0

1.13.4 Dimensions



EnDat Feedback			Resolver Feedback			Extension of K_0 depending on the Motor Option [mm]		
Model number	K_0	M	Model number	K_0	M	Holding brake	Oil seal	Reinforced A side bearing
8LSA63.Exnnnffgg-0	229	55	8LSA63.R0nnnffgg-0	192	18	63	---	---
8LSA64.Exnnnffgg-0	279		8LSA64.R0nnnffgg-0	242				
8LSA65.Exnnnffgg-0	304		8LSA65.R0nnnffgg-0	267				
8LSA66.Exnnnffgg-0	329		8LSA66.R0nnnffgg-0	292				

Table 27: 8LSA6 dimensions

1.13.5 Maximum Shaft Load

The values in the diagrams below are based on a mechanical lifespan of the bearings of 20,000 operating hours.

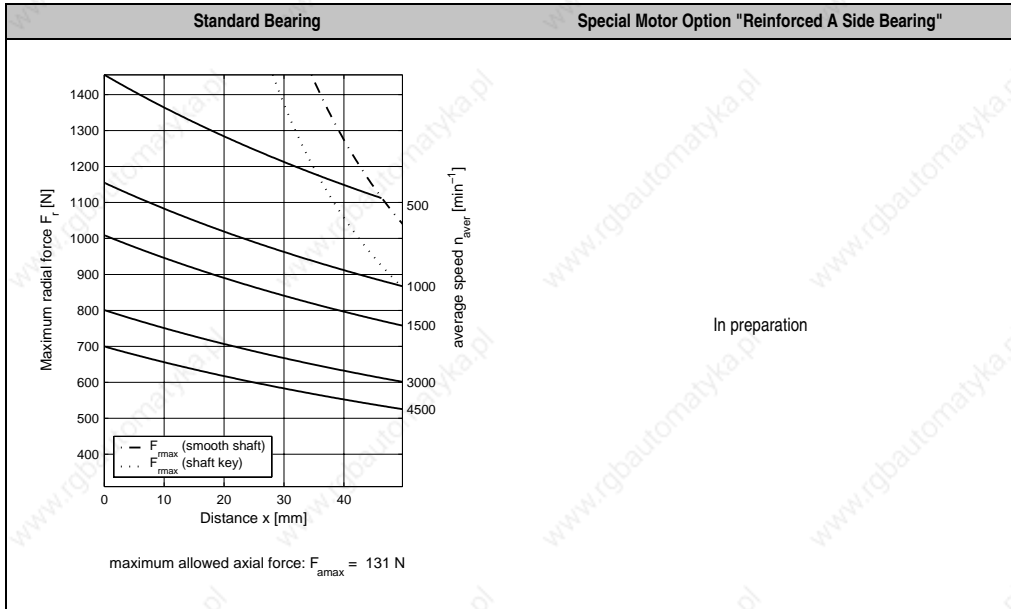

Table 28: Maximum shaft load for 8LSA6

1.14 Motor Data 8LSA7

1.14.1 Technical Data

	8LSA73.ee030/fgg-0	8LSA73.ee045/fgg-0	8LSA74.ee030/fgg-0	8LSA74.ee045/fgg-0	8LSA75.ee030/fgg-0
Rated Speed n_N [min ⁻¹]	3000	4500	3000	4500	3000
Number of Poles	6		6		6
Rated Torque M_N [Nm]	20	14.5	24	15	30
Rated Power P_N [kW]	6.28	6.83	7.54	7.07	9.42
Rated Current I_N [A]	12.27	13.18	14.72	13.64	18.4
Stall Torque M_0 [Nm]	26		32		40
Stalled Current I_0 [A]	15.95	23.64	19.63	29.09	24.54
Peak Torque M_{max} [Nm]	107		134		187
Peak Current I_{max} [A]	115	171	140	207	176
Maximum Angular Acceleration without Brake a [rad/s ²]	10918		11652		13357
Maximum Speed n_{max} [min ⁻¹]	6000		6000		4500
Torque Constant K_T [Nm/A]	1.63	1.1	1.63	1.1	1.63
Voltage Constant K_E [V/1000 min ⁻¹]	98.43	65.97	98.43	65.97	98.43
Stator Resistance R_{2ph} [Ω]	0.46	0.22	0.34	0.16	0.2
Stator Inductance L_{2ph} [mH]	5.55	2.62	4.42	2.2	3.07
Electrical Time Constant t_{ej} [ms]	12.07	11.91	13	13.75	15.35
Thermal Time Constant t_{therm} [min]	55		60		65
Moment of Inertia without Brake J [kgcm ²]	98		115		140
Weight without Brake m [kg]	27		30		38
Moment of Inertia for Brake J_{Br} [kgcm ²]	5.85		5.85		5.85
Weight of Brake m_{Br} [kg]	1.6		1.6		1.6
Holding Torque of the Brake M_{Br} [Nm]	32		32		32
Recommended Cable Cross Section for B&R Motor Cables [mm ²] ¹⁾	4		4		4
Recommended ACOPOS Servo Drive 8Vxxx.00-x ²⁾	1180	1320	1320		1320

Table 29: Technical data for 8LSA7

- 1) The B&R motor cables with this cable cross section are produced optimally (cables stripped to the correct length) for the recommended ACOPOS servo drives (see next line). B&R motor cables with other cable cross sections can also be used (within the specified terminal cross section range) and can be obtained from B&R in the desired design on request.
- 2) The recommended servo drive is defined for the stall current of the motor; if more than double the stall torque is required during the acceleration phase, the next larger servo drive should be selected. This recommendation is only a guideline, detailed inspection of the corresponding speed - torque characteristic curve can result in deviations of the servo drive size (one size larger or smaller).

1.14.2 Speed-Torque Characteristic Curves with 400 VAC Supply Voltage

8LSA73.eennffgg-0

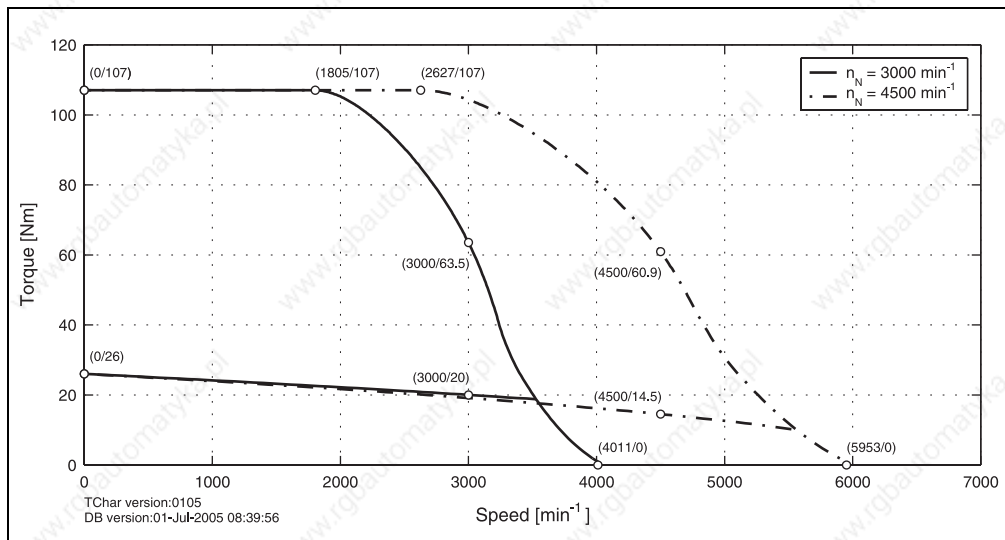

Figure 49: Speed - torque characteristic curve for 8LSA73.eennffgg-0

8LSA74.eennffgg-0

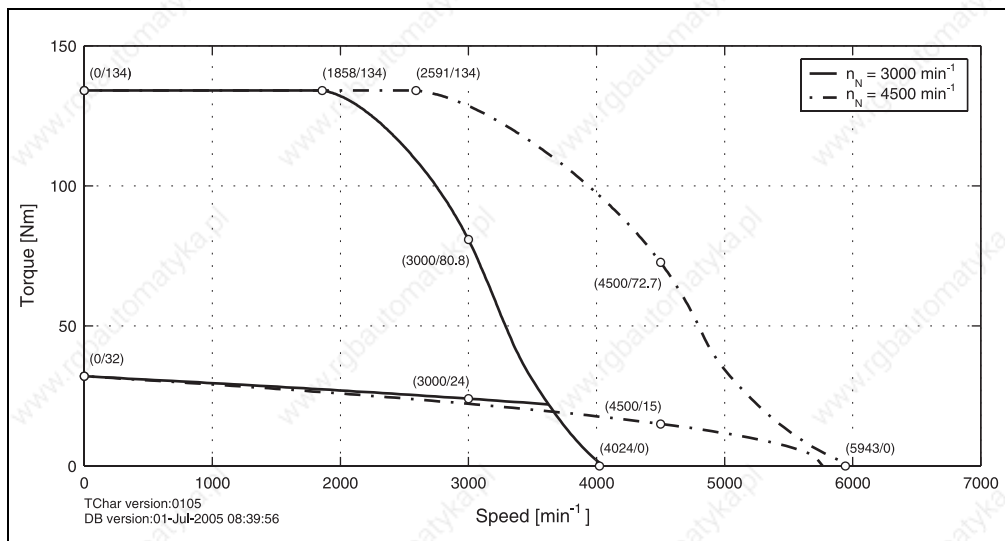

Figure 50: Speed - torque characteristic curve for 8LSA74.eennffgg-0

8LSA75.eennffgg-0

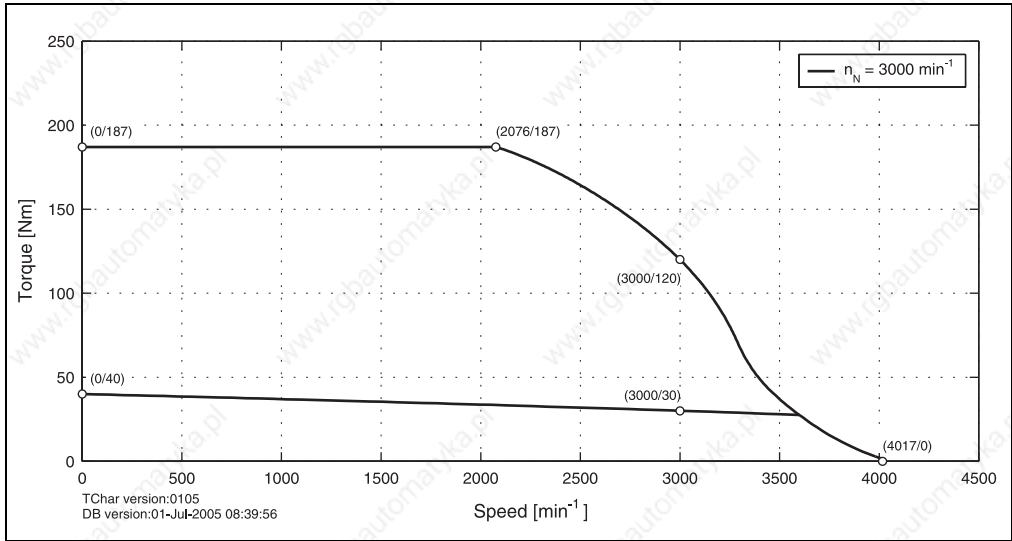

Figure 51: Speed - torque characteristic curve for 8LSA75.eennffgg-0

1.14.3 Speed-Torque Characteristic Curves with 230 VAC Supply Voltage

8LSA73.eennffgg-0

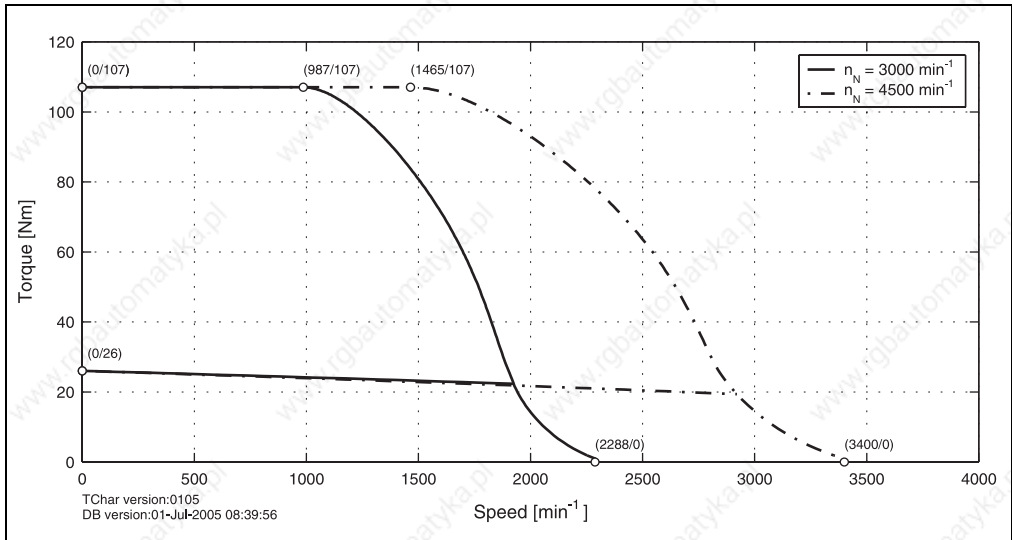

Figure 52: Speed - torque characteristic curve for 8LSA73.eennffgg-0

8LSA74.eennnffgg-0

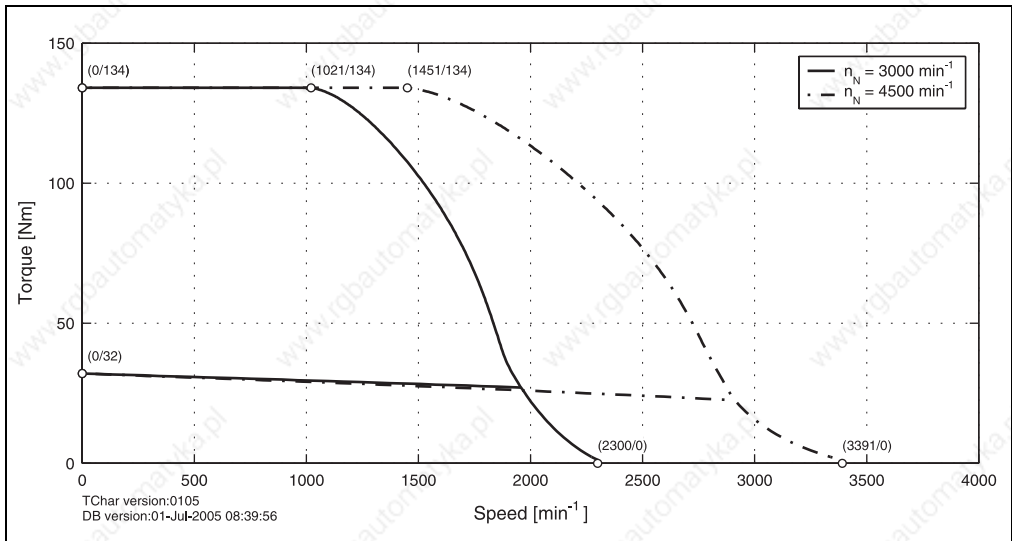

Figure 53: Speed - torque characteristic curve for 8LSA74.eennnffgg-0

8LSA75.eennnffgg-0

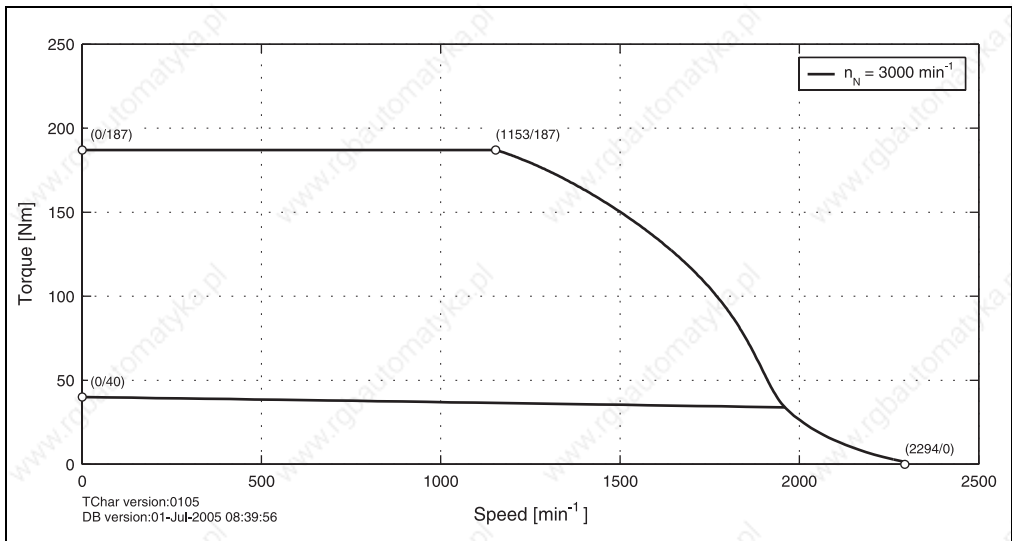
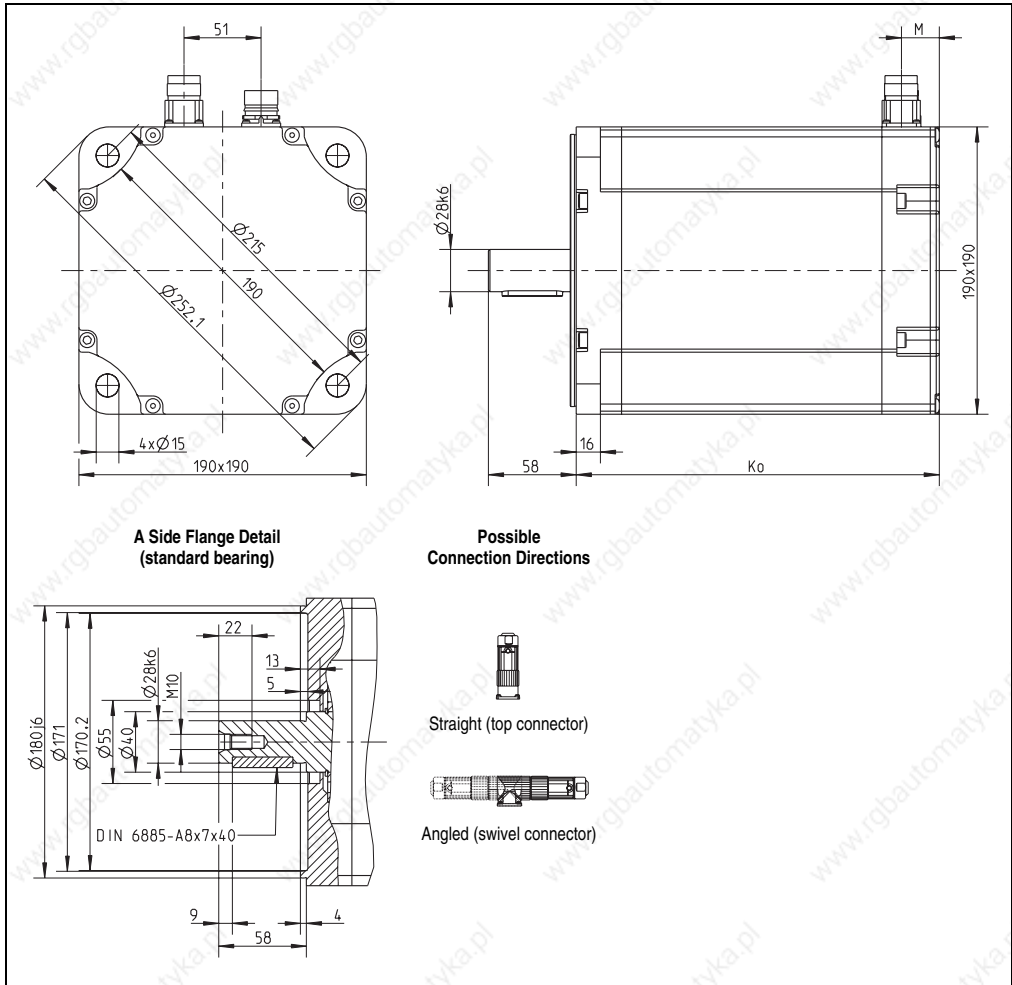

Figure 54: Speed - torque characteristic curve for 8LSA75.eennnffgg-0

1.14.4 Dimensions



EnDat Feedback			Resolver Feedback			Extension of K_0 depending on the Motor Option [mm]			
Model number	K_0	M	Model number	K_0	M	Holding brake	Oil seal	Reinforced A side bearing	
8LSA73.Exnnnfgg-0	268	53	8LSA73.R0nnnfgg-0	240	25	40	---	---	
8LSA74.Exnnnfgg-0	288		8LSA74.R0nnnfgg-0	260					
8LSA75.Exnnnfgg-0	328		8LSA75.R0nnnfgg-0	300					

Table 30: 8LSA7 dimensions

1.14.5 Maximum Shaft Load

The values in the diagrams below are based on a mechanical lifespan of the bearings of 20,000 operating hours.

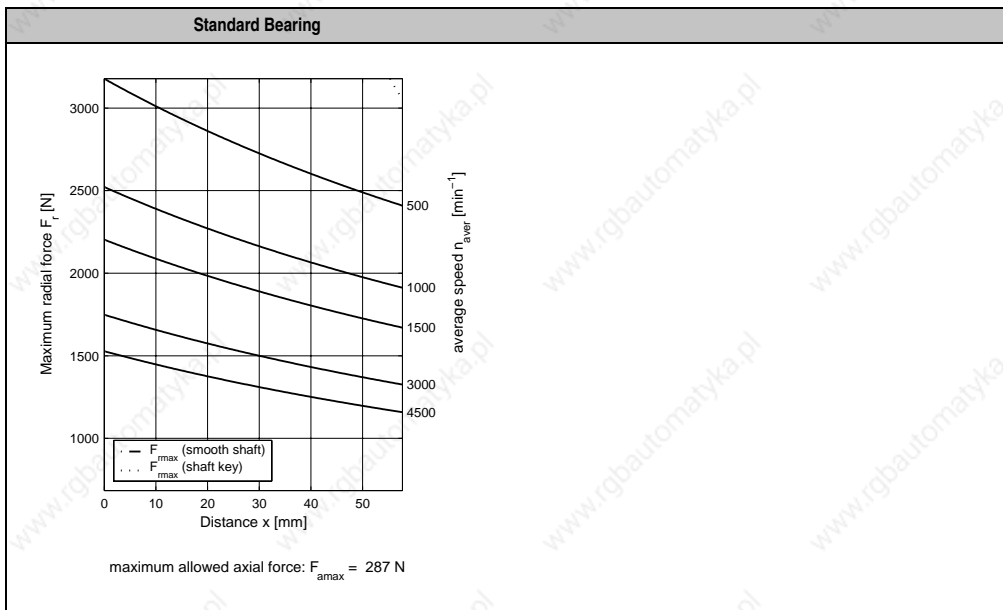

Table 31: Maximum shaft load for 8LSA7

1.15 Motor Data 8LSA8

1.15.1 Technical Data

	8LSA83.ee.030/fgg-0	8LSA84.ee.030/fgg-0	8LSA85.ee.020/fgg-0	8LSA85.ee.020/fgg-0
Rated Speed n_N [min ⁻¹]	3000	3000	2000	2000
Number of Poles	6	6	6	6
Rated Torque M_N [Nm]	27	48.4	72	85
Rated Power P_N [kW]	8.48	15.21	15.08	17.8
Rated Current I_N [A]	16.56	29.69	29.39	34.69
Stall Torque M_0 [Nm]	40	69	94	115
Stalled Current I_0 [A]	24.54	42.33	38.37	46.94
Peak Torque M_{max} [Nm]	120	204	280	345
Peak Current I_{max} [A]	102	171	150	182
Maximum Angular Acceleration without Brake a [rad/s ²]	18462	17895	18667	17969
Maximum Speed n_{max} [min ⁻¹]	3600	3600	3600	3600
Torque Constant K_T [Nm/A]	1.63	1.63	2.45	2.45
Voltage Constant K_E [V/1000 min ⁻¹]	98.43	98.43	147.65	147.65
Stator Resistance R_{2ph} [Ω]	0.23	0.1	0.16	0.12
Stator Inductance L_{2ph} [mH]	5.4	3.11	5.18	4.04
Electrical Time Constant t_{el} [ms]	23.48	31.1	32.38	34.83
Thermal Time Constant t_{therm} [min]	50	65	80	90
Moment of Inertia without Brake J [kgcm ²]	65	114	150	192
Weight without Brake m [kg]	41.5	55	74	92
Moment of Inertia for Brake J_{Br} [kgcm ²]	53	53	53	53
Weight of Brake m_{Br} [kg]	5.35	5.35	5.35	5.35
Holding Torque of the Brake M_{Br} [Nm]	130	130	130	130
Recommended Cable Cross Section for B&R Motor Cables [mm ²] ¹⁾	4 ²⁾	10	10	10
Recommended ACOPOS Servo Drive 8Vxxx.00-x ³⁾	1320	1640	1640	1640

Table 32: Technical data for 8LSA8

- 1) The B&R motor cables with this cable cross section are produced optimally (cables stripped to the correct length) for the recommended ACOPOS servo drives (see next line). B&R motor cables with other cable cross sections can also be used (within the specified terminal cross section range) and can be obtained from B&R in the desired design on request.
- 2) Special prefabricated motor cables must be used for this motor / servo drive combination (size of the motor plug is not the standard size). They are available from B&R on request.
- 3) The recommended servo drive is defined for the stall current of the motor; if more than double the stall torque is required during the acceleration phase, the next larger servo drive should be selected. This recommendation is only a guideline, detailed inspection of the corresponding speed - torque characteristic curve can result in deviations of the servo drive size (one size larger or smaller).

1.15.2 Speed-Torque Characteristic Curves with 400 VAC Supply Voltage

8LSA83.eennffgg-0

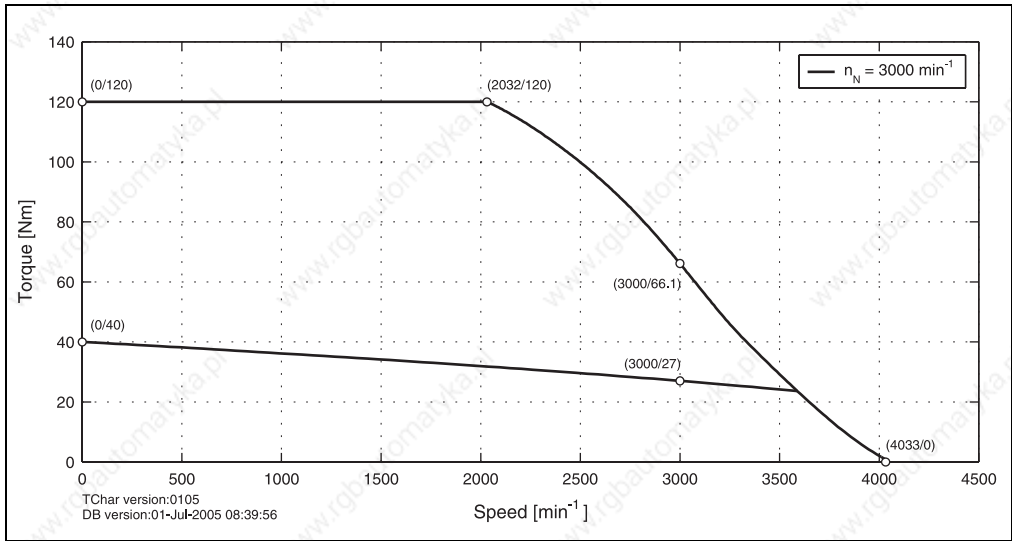

Figure 55: Speed - torque characteristic curve for 8LSA83.eennffgg-0

8LSA84.eennffgg-0

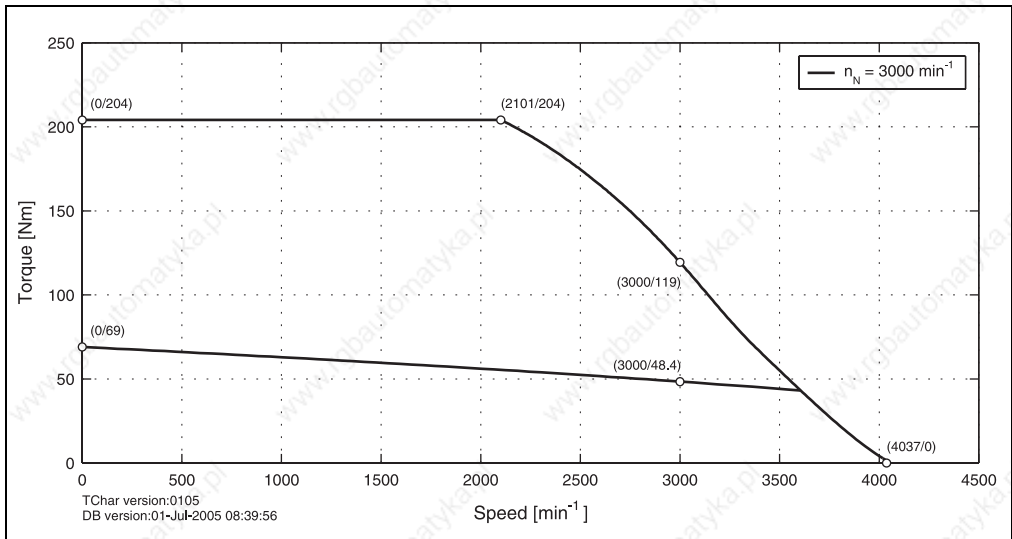

Figure 56: Speed - torque characteristic curve for 8LSA84.eennffgg-0

8LSA85.eennnffgg-0

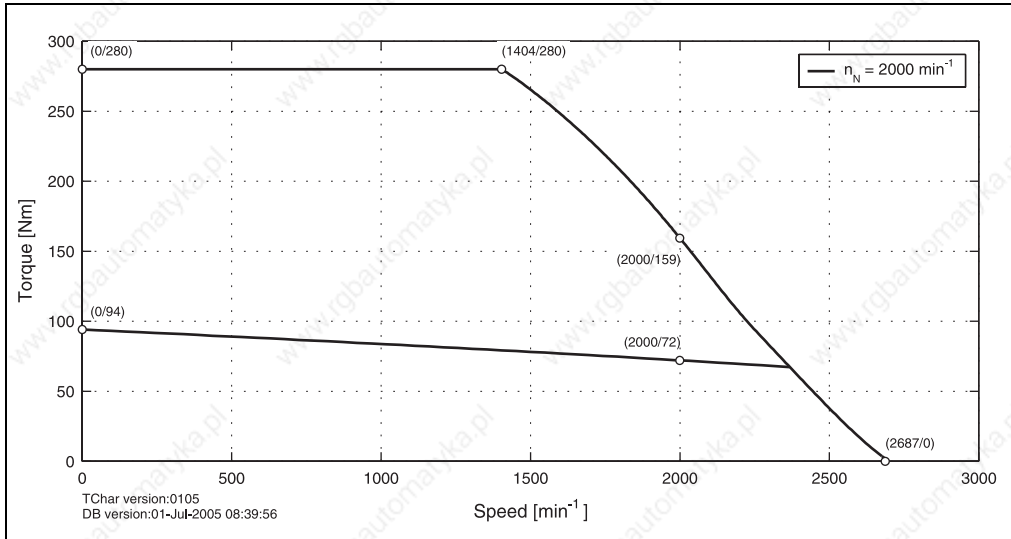

Figure 57: Speed - torque characteristic curve for 8LSA85.eennnffgg-0

8LSA86.eennnffgg-0

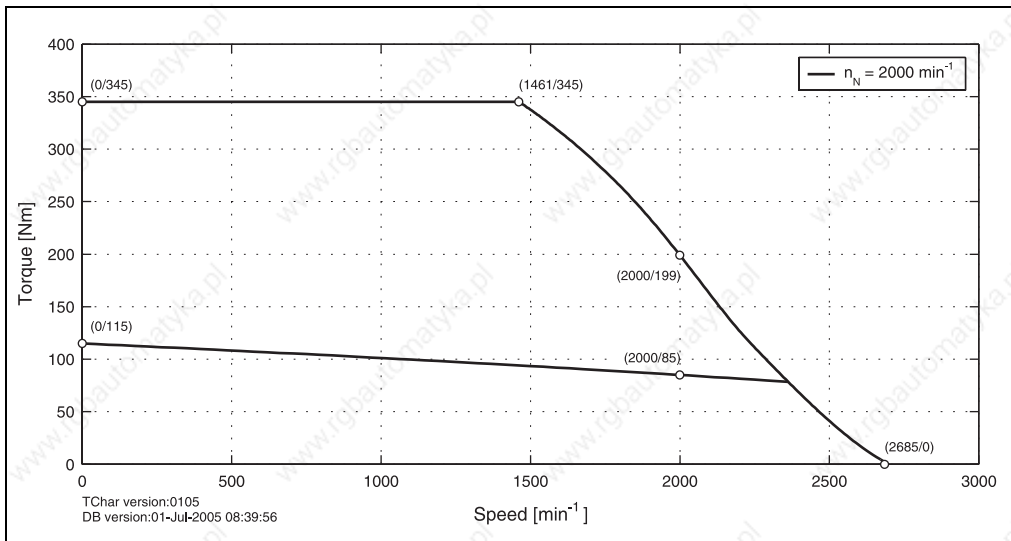

Figure 58: Speed - torque characteristic curve for 8LSA86.eennnffgg-0

1.15.3 Speed-Torque Characteristic Curves with 230 VAC Supply Voltage

8LSA83.eennffgg-0

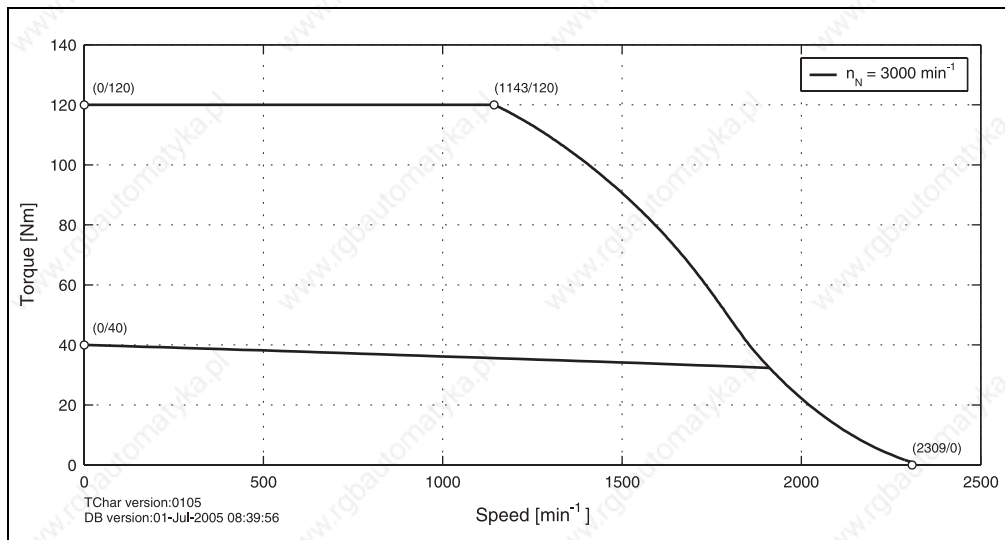

Figure 59: Speed - torque characteristic curve for 8LSA83.eennffgg-0

8LSA84.eennffgg-0

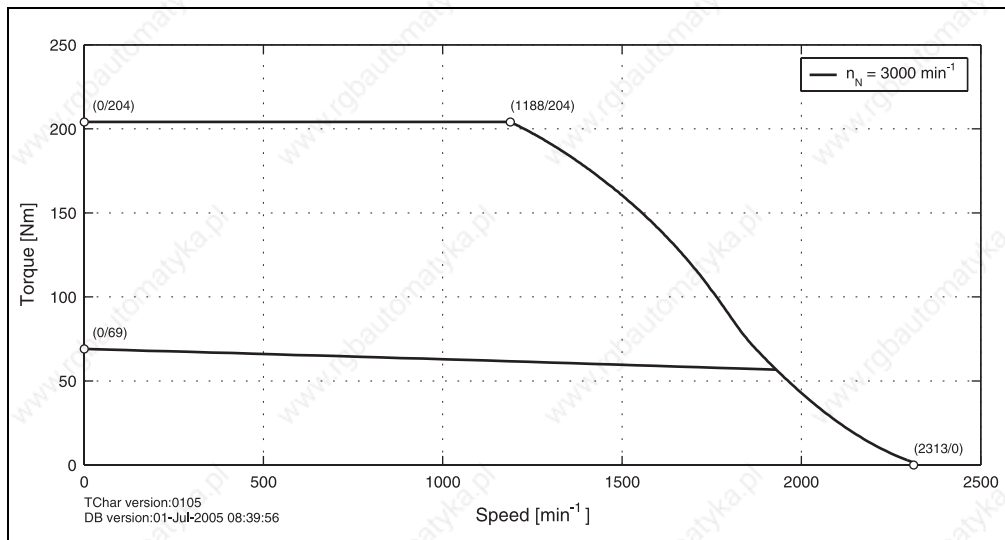

Figure 60: Speed - torque characteristic curve for 8LSA84.eennffgg-0

8LSA85.eennnffgg-0

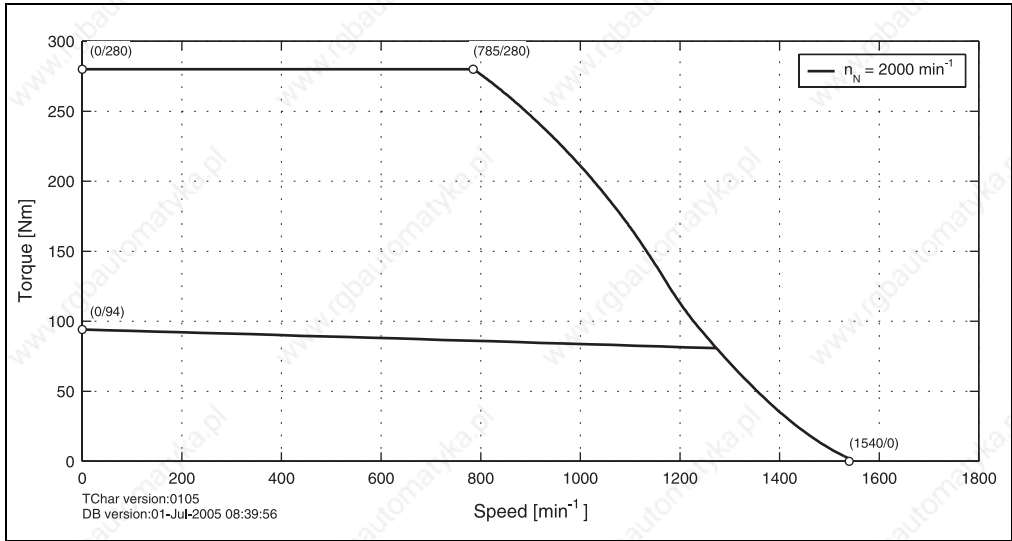

Figure 61: Speed - torque characteristic curve for 8LSA85.eennnffgg-0

8LSA86.eennnffgg-0

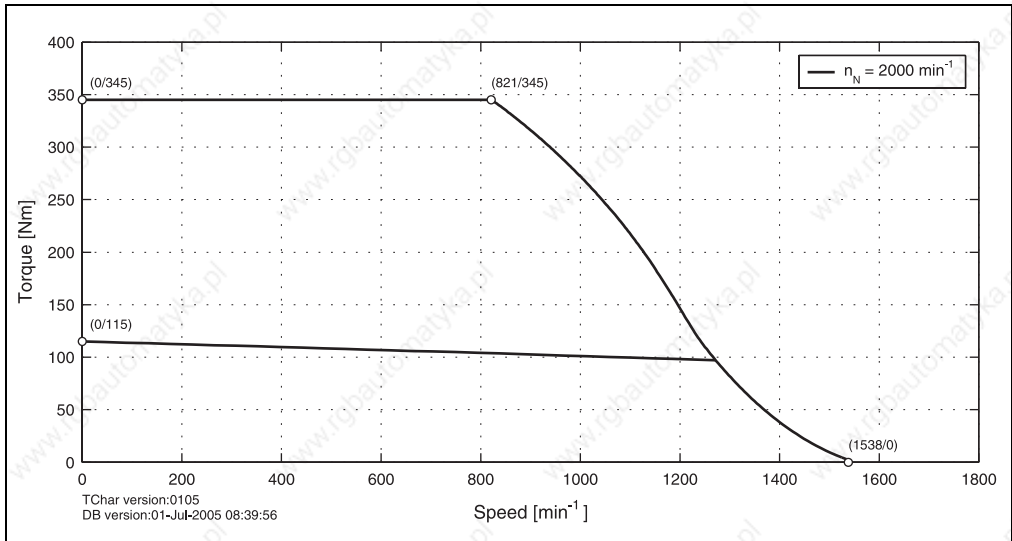
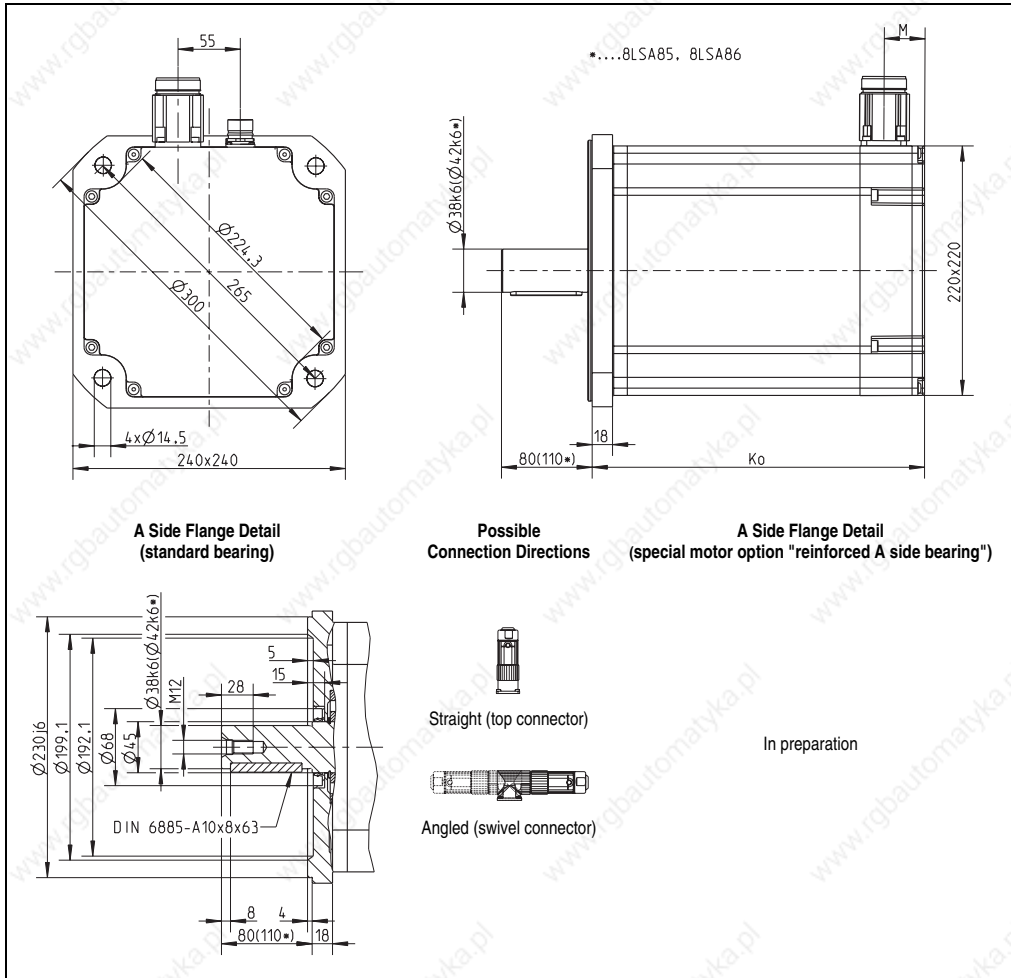

Figure 62: Speed - torque characteristic curve for 8LSA86.eennnffgg-0

1.15.4 Dimensions



EnDat Feedback			Resolver Feedback			Extension of K_0 depending on the Motor Option [mm]			
Model number	K_0	M	Model number	K_0	M	Holding brake	Oil seal	Reinforced A side bearing	
8LSA83.Exnnffgg-0	321	64	8LSA83.R0nnffgg-0	293	36	50	---	---	
8LSA84.Exnnffgg-0	401		8LSA84.R0nnffgg-0	373					
8LSA85.Exnnffgg-0	461		8LSA85.R0nnffgg-0	433					
8LSA86.Exnnffgg-0	521		8LSA86.R0nnffgg-0	493					

Table 33: 8LSA8 dimensions

1.15.5 Maximum Shaft Load

The values in the diagrams below are based on a mechanical lifespan of the bearings of 20,000 operating hours.

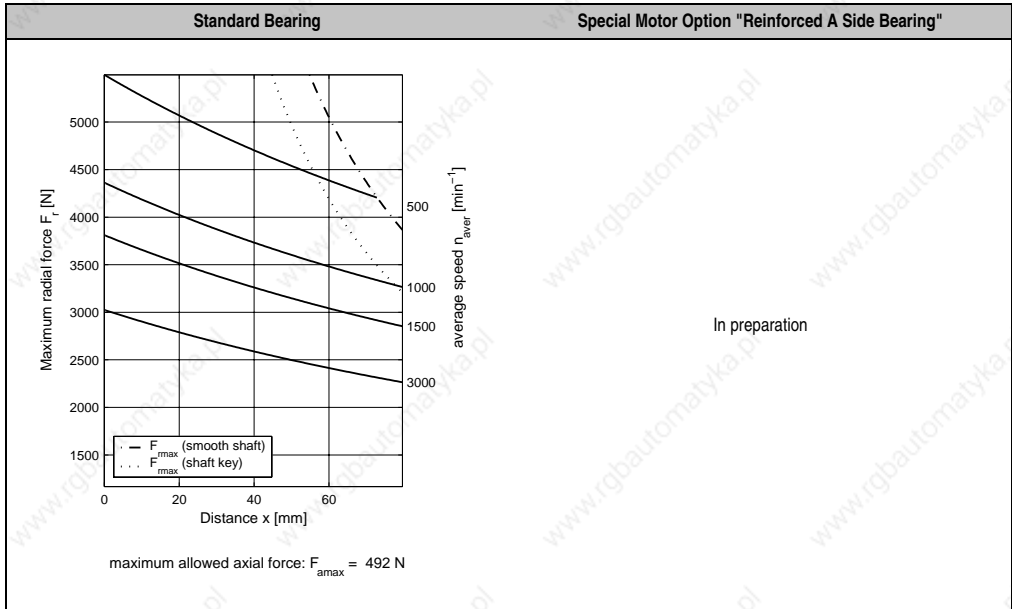

Table 34: Maximum shaft load for 8LSA8

2. Cables

2.1 General Information

B&R offers the cables for 8LS synchronous motors in six different lengths. All cables can be used for drag chain installations. ¹⁾

To prevent disturbances to encoder signals, the holding brake and temperature sensor wires are in the motor cable and not in the EnDat or resolver cable.

2.1.1 Prefabricated Cable

Using B&R cables guarantees that the EMC limits are not exceeded. The cables are prefabricated in the EU and are therefore subject to the strictest quality standards.

Information:

If other cables are used, make sure that they have the same wave parameters and the same design as the respective B&R cable. If deviations exist, additional measures are necessary to ensure that EMC guidelines are met.

1) Custom fabrication of motor cables is available on request. For custom fabrication of motor cables, the plug size must be matched to the motor used!

2.2 Motor Cables

2.2.1 Order Data

Model number	Short description	Image
Motor cable 1.5 mm² ¹⁾		
8CM005.12-1	Motor cable, length 5m, 4 x 1.5mm ² + 2 x 2 x 0.75mm ² , Motor connector 8pin Intercontec socket, can be used in cable drag chains, UL/CSA listed	
8CM007.12-1	Motor cable, length 7m, 4 x 1.5mm ² + 2 x 2 x 0.75mm ² , Motor connector 8pin Intercontec socket, can be used in cable drag chains, UL/CSA listed	
8CM010.12-1	Motor cable, length 10m, 4 x 1.5mm ² + 2 x 2 x 0.75mm ² , Motor connector 8pin Intercontec socket, can be used in cable drag chains, UL/CSA listed	
8CM015.12-1	Motor cable, length 15m, 4 x 1.5mm ² + 2 x 2 x 0.75mm ² , Motor connector 8pin Intercontec socket, can be used in cable drag chains, UL/CSA listed	
8CM020.12-1	Motor cable, length 20m, 4 x 1.5mm ² + 2 x 2 x 0.75mm ² , Motor connector 8pin Intercontec socket, can be used in cable drag chains, UL/CSA listed	
8CM025.12-1	Motor cable, length 25m, 4 x 1.5mm ² + 2 x 2 x 0.75mm ² , Motor connector 8pin Intercontec socket, can be used in cable drag chains, UL/CSA listed	
Motor cable 4 mm² ²⁾		
8CM005.12-3	Motor cable, length 5m, 4 x 4mm ² + 2 x 2 x 1mm ² , Motor connector 8pin Intercontec socket, can be used in cable drag chains, UL/CSA listed	
8CM007.12-3	Motor cable, length 7m, 4 x 4mm ² + 2 x 2 x 1mm ² , Motor connector 8pin Intercontec socket, can be used in cable drag chains, UL/CSA listed	
8CM010.12-3	Motor cable, length 10m, 4 x 4mm ² + 2 x 2 x 1mm ² , Motor connector 8pin Intercontec socket, can be used in cable drag chains, UL/CSA listed	
8CM015.12-3	Motor cable, length 15m, 4 x 4mm ² + 2 x 2 x 1mm ² , Motor connector 8pin Intercontec socket, can be used in cable drag chains, UL/CSA listed	
8CM020.12-3	Motor cable, length 20m, 4 x 4mm ² + 2 x 2 x 1mm ² , Motor connector 8pin Intercontec socket, can be used in cable drag chains, UL/CSA listed	
8CM025.12-3	Motor cable, length 25m, 4 x 4mm ² + 2 x 2 x 1mm ² , Motor connector 8pin Intercontec socket, can be used in cable drag chains, UL/CSA listed	
Motor cable 10 mm² ³⁾		
8CM005.12-5	Motor cable, length 5m, 4 x 10mm ² + 2 x 2 x 1.5mm ² , Motor connector 8pin Intercontec socket, can be used in cable drag chains, UL/CSA listed	
8CM007.12-5	Motor cable, length 7m, 4 x 10mm ² + 2 x 2 x 1.5mm ² , Motor connector 8pin Intercontec socket, can be used in cable drag chains, UL/CSA listed	
8CM010.12-5	Motor cable, length 10m, 4 x 10mm ² + 2 x 2 x 1.5mm ² , Motor connector 8pin Intercontec socket, can be used in cable drag chains, UL/CSA listed	
8CM015.12-5	Motor cable, length 15m, 4 x 10mm ² + 2 x 2 x 1.5mm ² , Motor connector 8pin Intercontec socket, can be used in cable drag chains, UL/CSA listed	
8CM020.12-5	Motor cable, length 20m, 4 x 10mm ² + 2 x 2 x 1.5mm ² , Motor connector 8pin Intercontec socket, can be used in cable drag chains, UL/CSA listed	
8CM025.12-5	Motor cable, length 25m, 4 x 10mm ² + 2 x 2 x 1.5mm ² , Motor connector 8pin Intercontec socket, can be used in cable drag chains, UL/CSA listed	

Table 35: Order data for motor cables

Technical Data • Cables

Model number	Short description	Image
	Motor cable 35 mm²	
8CM005.12-8	Motor cable, length 5m, 4 x 35mm ² + 2 x 2 x 1.5mm ² , can be used in cable drag chains, UL/CSA listed	
8CM007.12-8	Motor cable, length 7m, 4 x 35mm ² + 2 x 2 x 1.5mm ² , can be used in cable drag chains, UL/CSA listed	
8CM010.12-8	Motor cable, length 10m, 4 x 35mm ² + 2 x 2 x 1.5mm ² , can be used in cable drag chains, UL/CSA listed	
8CM015.12-8	Motor cable, length 15m, 4 x 35mm ² + 2 x 2 x 1.5mm ² , can be used in cable drag chains, UL/CSA listed	
8CM020.12-8	Motor cable, length 20m, 4 x 35mm ² + 2 x 2 x 1.5mm ² , can be used in cable drag chains, UL/CSA listed	
8CM025.12-8	Motor cable, length 25m, 4 x 35mm ² + 2 x 2 x 1.5mm ² , can be used in cable drag chains, UL/CSA listed	

Table 35: Order data for motor cables (cont.)

- 1) Standard fabrication; designed for use with ACOPOS servo drives 8V1010.xx-x, 8V1016.xx-x, 8V1022.00-x, 8V1045.00-x and 8V1090.00-x and motor sizes 2 to 7.
- 2) Standard fabrication; designed for use with ACOPOS servo drives 8V1180.00-x and 8V1320.00-x and motor sizes 2 to 7.
- 3) Standard fabrication; designed for use with ACOPOS servo drives 8V1640.00-x and 8V128M.00-x and motor size 8.

2.2.2 Technical Data

 1.5 and 4 mm² motor cables

Product ID	Motor cable 1.5 mm ²	Motor cable 4 mm ²
General Information		
Cable Cross Section	4 x 1.5 mm ² + 2 x 2 x 0.75 mm ²	4 x 4 mm ² + 2 x 2 x 1 mm ²
Durability	Oil resistant according to VDE 0472 part 803, as well as standard hydraulic oil	
Certification	UL AWM Style 20669, 90 °C, 600 V, E63216 and CSA AWM I/II A/B, 90 °C, 600 V, FT1 LL46064	
Lines		
Power Lines	1.5 mm ² , tinned Cu wire	4 mm ² , tinned Cu wire
Wire Insulation	Special thermoplastic material	
Wire Colors	Black, brown, blue, yellow/green	
Signal Lines	0.75 mm ² , tinned Cu wire	1 mm ² , tinned Cu wire
Wire Insulation	Special thermoplastic material	
Wire Colors	White, white/red, white/blue, white/green	
Cable Structure		
Power Lines		
Stranding	No	
Shield	No	
Signal Lines		
Stranding	White with white/red and white/blue with white/green	
Shield	Separate shielding for pairs, tinned Cu mesh, optical coverage > 85 % and foil banding	
Cable Stranding	With filler elements and foil banding	
Cable Shielding	Tinned Cu mesh, optical coverage > 85% and wrapped in isolating fabric	
Outer Sheathing		
Material	PUR	
Color	Orange, similar to RAL 2003 flat	
Labeling	BERNECKER + RAINER 4x1.5+2x2x0.75 FLEX	BERNECKER + RAINER 4x4.0+2x2x1.5 FLEX
Electrical Characteristics		
Conductor Resistance		
Power Lines	≤ 14 Ω/km	≤ 5.2 Ω/km
Signal Lines	≤ 29 Ω/km	≤ 14 Ω/km
Insulation Resistance	> 200 MΩ per km	
Isolation Voltage		
Wire/Wire	3 kV	
Wire/Shield	1 kV	
Operating Voltage	Max. 600 V	
Mechanical Characteristics		
Temperature Range		
Moving	-10 °C to +70 °C	
Static	-20 °C to +90 °C	
Outer Diameter	12.8 mm ± 0.4 mm	15.8 mm ± 0.5 mm
Flex Radius	> 96 mm	> 118.5 mm
Speed	≤ 4 m/s	
Acceleration	< 60 m/s ²	
Flex Cycles	≥ 3,000,000	
Weight	0.26 kg/m	0.45 kg/m

 Table 36: Technical data for motor cables 1.5 and 4 mm²

10 and 35 mm² motor cables

Product ID	Motor cable 10 mm ²	Motor cable 35 mm ²
General Information		
Cable Cross Section	4 x 10 mm ² + 2 x 2 x 1.5 mm ²	4 x 35 mm ² + 2 x 2 x 1.5 mm ²
Durability	Oil resistant according to VDE 0472 part 803, as well as standard hydraulic oil	
Certification	UL AWM Style 20669, 90 °C, 600 V, E63216 and CSA AWM I/II A/B, 90°C, 600 V, FT1 LL46064	
Lines		
Power Lines	10 mm ² , tinned Cu wire	35 mm ² , tinned Cu wire
Wire Insulation	Special thermoplastic material	
Wire Colors	Black, brown, blue, yellow/green	
Signal Lines	1.5 mm ² , tinned Cu wire	
Wire Insulation	Special thermoplastic material	
Wire Colors	White, white/red, white/blue, white/green	
Cable Structure		
Power Lines		
Stranding	No	
Shield	No	
Signal Lines		
Stranding	White with white/red and white/blue with white/green	
Shield	Separate shielding for pairs, tinned Cu mesh, optical coverage > 85 % and foil banding	
Cable Stranding	With filler elements and foil banding	
Cable Shielding	Tinned Cu mesh, optical coverage > 85% and wrapped in isolating fabric	
Outer Sheathing		
Material	PUR	
Color	Orange, similar to RAL 2003 flat	
Labeling	BERNECKER + RAINER 4x10.0+2x2x1.5 FLEX	BERNECKER + RAINER 4x35.0+2x2x1.5 FLEX
Electrical Characteristics		
Conductor Resistance		
Power Lines	≤ 2.1 Ω/km	≤ 0.6 Ω/km
Signal Lines	≤ 14 Ω/km	≤ 14 Ω/km
Insulation Resistance	> 200 MΩ per km	
Isolation Voltage		
Wire/Wire	3 kV	
Wire/Shield	1 kV	
Operating Voltage	Max. 600 V	
Mechanical Characteristics		
Temperature Range		
Moving	-10 °C to +70 °C	
Static	-20 °C to +90 °C	
Outer Diameter	20.1 mm ± 0.7 mm	32.5 mm ± 1 mm
Flex Radius	> 150.8 mm	> 243.8 mm
Speed	≤ 4 m/s	
Acceleration	< 60 m/s ²	
Flex Cycles	≥ 3,000,000	
Weight	0.77 kg/m	2.2 kg/m

 Table 37: Technical data for motor cables 10 and 35 mm²

2.3 EnDat Cables

2.3.1 Order Data

Model number	Model number	Image
8CE005.12-1	EnDat cable, length 5m, 10 x 0.14mm ² + 2 x 0.5mm ² , EnDat connector 17-pin Intercontec socket, servo connector 15-pin DSUB plug, can be used in cable drag chains, UL/CSA listed	
8CE007.12-1	EnDat cable, length 7m, 10 x 0.14mm ² + 2 x 0.5mm ² , EnDat connector 17-pin Intercontec socket, servo connector 15-pin DSUB plug, can be used in cable drag chains, UL/CSA listed	
8CE010.12-1	EnDat cable, length 10m, 10 x 0.14mm ² + 2 x 0.5mm ² , EnDat connector 17-pin Intercontec socket, servo connector 15-pin DSUB plug, can be used in cable drag chains, UL/CSA listed	
8CE015.12-1	EnDat cable, length 15m, 10 x 0.14mm ² + 2 x 0.5mm ² , EnDat connector 17-pin Intercontec socket, servo connector 15-pin DSUB plug, can be used in cable drag chains, UL/CSA listed	
8CE020.12-1	EnDat cable, length 20m, 10 x 0.14mm ² + 2 x 0.5mm ² , EnDat connector 17-pin Intercontec socket, servo connector 15-pin DSUB plug, can be used in cable drag chains, UL/CSA listed	
8CE025.12-1	EnDat cable, length 25m, 10 x 0.14mm ² + 2 x 0.5mm ² , EnDat connector 17-pin Intercontec socket, servo connector 15-pin DSUB plug, can be used in cable drag chains, UL/CSA listed	

Table 38: Order data for EnDat cables

2.3.2 Technical Data

Product ID	EnDat Cables
General Information	
Cable Cross Section	10 x 0.14 mm ² + 2 x 0.50 mm ²
Durability	Oil resistant according to VDE 0472 part 803, as well as standard hydraulic oil
Certification	UL AWM Style 20963, 80°C, 30 V, E63216 and CSA AWM I/II A/B, 90°C, 30 V, FT1 LL46064
Lines	
Signal Lines Wire Insulation Wire Colors	0.14 mm ² , tinned Cu wire Special thermoplastic material Blue, brown, yellow, gray, green, pink, red, black, violet, white
Supply Lines Wire Insulation Wire Colors	0.5 mm ² , tinned Cu wire Special thermoplastic material White/green, white/red
Cable Structure	
Signal Lines Stranding Shield	Green with brown, gray with yellow, white with violet, black with red, pink with blue No
Supply Lines Stranding Shield	White/red with white/green and filler elements No
Cable Stranding	With foil banding

Table 39: Technical data for EnDat cables

Technical Data • Cables

Product ID	EnDat Cables
Cable Shielding	Cu mesh, optical coverage > 85% and wrapped in isolating fabric
Outer Sheathing Material Color Labeling	PUR RAL 6018 BERNECKER + RAINER 10x0.14+2x0.50 FLEX
Electrical Characteristics	
Conductor Resistance Signal Lines Supply Lines	≤ 140 Ω/km ≤ 40 Ω/km
Insulation Resistance	> 200 MΩ per km
Isolation Voltage Wire/Wire Wire/Shield	1.5 kV 0.8 kV
Operating Voltage	Max. 30 V
Mechanical Characteristics	
Temperature Range Moving Static	-10 °C to +70 °C -20 °C to +90 °C
Outer Diameter	7.3 mm ± 0.25 mm
Flex Radius	> 55 mm
Speed	≤ 4 m/s
Acceleration	< 60 m/s ²
Flex Cycles	≥ 3,000,000
Weight	0.08 kg/m

Table 39: Technical data for EnDat cables (cont.)

2.4 Resolver Cables

2.4.1 Order Data

Model number	Short description	Image
8CR005.12-1	Resolver cable, length 5m, 3 x 2 x 24 AWG/19, resolver plug 12-pin Intercontec socket, servo plug 9-pin DSUB plug, can be used in cable drag chains, UL/CSA listed	
8CR007.12-1	Resolver cable, length 7m, 3 x 2 x 24 AWG/19, resolver plug 12-pin Intercontec socket, servo plug 9-pin DSUB plug, can be used in cable drag chains, UL/CSA listed	
8CR010.12-1	Resolver cable, length 10m, 3 x 2 x 24 AWG/19, resolver plug 12-pin Intercontec socket, servo plug 9-pin DSUB plug, can be used in cable drag chains, UL/CSA listed	
8CR015.12-1	Resolver cable, length 15m, 3 x 2 x 24 AWG/19, resolver plug 12-pin Intercontec socket, servo plug 9-pin DSUB plug, can be used in cable drag chains, UL/CSA listed	
8CR020.12-1	Resolver cable, length 20m, 3 x 2 x 24 AWG/19, resolver plug 12-pin Intercontec socket, servo plug 9-pin DSUB plug, can be used in cable drag chains, UL/CSA listed	
8CR025.12-1	Resolver cable, length 25m, 3 x 2 x 24 AWG/19, resolver plug 12-pin Intercontec socket, servo plug 9-pin DSUB plug, can be used in cable drag chains, UL/CSA listed	

Table 40: Order data for resolver cables

2.4.2 Technical Data

Product ID	Resolver Cables
General Information	
Cable Cross Section	3 x 2 x 24 AWG/19
Durability	Oil resistant according to VDE 0472 part 803, as well as standard hydraulic oil
Certification	UL AWM Style 20671, 90 °C, 30 V, E63216 and CSA AWM, 90 °C, 30 V, I/II A/B FT1 LL46064
Lines	
Signal Lines Wire Insulation Wire Colors	24 AWG/19, tinned Cu wire Special thermoplastic material White, brown, green, yellow, gray, pink
Cable Structure	
Signal Lines Stranding Shield	White with brown, green with yellow, gray with pink No
Cable Stranding	The 3 pairs together covered by foil banding
Cable Shielding	Cu mesh, optical coverage ≥ 90% and wrapped in isolating fabric
Outer Sheathing Material Color Labeling	PUR RAL 6018 BERNECKER + RAINER 3x2x24 AWG FLEX

Table 41: Technical data for resolver cables

Technical Data • Cables

Product ID	Resolver Cables
Electrical Characteristics	
Conductor Resistance 24 AWG	≤ 86 Ω/km
Insulation Resistance	> 200 MΩ per km
Isolation Voltage Wire/Wire Wire/Shield	1.5 kV 0.8 kV
Operating Voltage	Max. 30 V
Mechanical Characteristics	
Temperature Range Moving Static	-10 °C to +80 °C -40 °C to +90 °C
Outer Diameter	6.5 mm ± 0.2 mm
Flex Radius	≥ 50 mm
Speed	≤ 4 m/s
Acceleration	< 60 m/s ²
Flex Cycles	≥ 3,000,000
Weight	0.07 kg/m

Table 41: Technical data for resolver cables (cont.)

3. Connectors

3.1 General Information

B&R offers five different motor/encoder connectors for 8LS three-phase synchronous motors. All connectors have IP67 protection. The metallic housing provides a protective ground connection on the housing according to VDE 0627. All plastic used in the connector is UL94/V0 listed. High quality, gold plated cage connector contacts guarantee a high level of contact security even when reinserted many times.

Information:

Using B&R connectors guarantees that the EMC limits for the connection are not exceeded. Make sure that connectors are put together correctly including a proper shield connection.

3.2 Motor Connectors

3.2.1 Order Data

Model number	Short description	Image
Cable Diameter 9 - 17 mm		
8PM001.00-1	Motor plug 8-pin Intercontec socket, crimp range 4 x 0.5-2.5mm ² + 4 x 0.06-1.0mm ² , for cable ø 9-14mm, IP67, UL/CSA listed	
8PM002.00-1	Motor plug 8-pin Intercontec socket, crimp range 4 x 2.5-4.0mm ² + 4 x 0.06-1.0mm ² , for cable ø 14-17mm, IP67, UL/CSA listed	
Cable Diameter 17 - 26 mm		
8PM003.00-1	Motor plug 8-pin Intercontec socket, crimp range 4 x 1.5-10mm ² + 4 x 0.5-2.5mm ² , for cable ø 17-26mm, IP67, UL/CSA listed	

Table 42: Order data for motor connectors

3.2.2 Technical Data for 8PM001.00-1 and 8PM002.00-1

Product ID	8PM001.00-1	8PM002.00-1
General Information		
Connector Size	Size 1	
Contacts	8 (4 power and 4 signal contacts)	
Degree of Pollution	3	
Installation Altitude	Up to 2000 m	
Insulator	PA 6.6 / PBT, UL94/V0 listed	
Contacts	Gold plated brass	
Protective Ground Connection on Housing	According to VDE 0627	
Protection according to DIN 40050	IP67 when connected	
Certifications	UL/CSA	
Electrical Characteristics		
Overvoltage Category	3	
Power Contacts Rated Current Rated Voltage Isolation Voltage (L-L) Contact Resistance	30 A 630 VAC / VDC 6000 V <3 mΩ	
Signal Contacts Rated Current Rated Voltage Isolation Voltage (L-L) Contact Resistance	10 A 250 VAC / VDC 2500 V <5 mΩ	
Mechanical Characteristics		
Temperature Range	-20 °C to +130 °C	
Housing Material	Zinc die cast / brass, nickel plated	
Gaskets	FPM / HNBR	
Mating Cycles	> 50	
Crimp Range	4 x 0.5 - 2.5 mm ² + 4 x 0.06 - 1 mm ²	4 x 2.5 - 4 mm ² + 4 x 0.06 - 1 mm ²
Cable ø	9.5 - 14.5 mm	14 - 17 mm
Manufacturer Information		
Manufacturer Internet Address	INTERCONTEC www.intercontec.biz	
Manufacturer's Product ID	BSTA 108 FR 19 58 0036 000	BSTA 108 FR 35 59 0036 000

Table 43: Technical data for motor connectors 8PM001.00-1 and 8PM002.00-1

3.2.3 Technical Data for 8PM003.00-1

Product ID	8PM003.00-1
General Information	
Connector Size	Size 1.5
Contacts	8 (4 power and 4 signal contacts)
Degree of Pollution	3
Installation Altitude	Up to 2000 m
Insulator	PA 6.6 / PBT, UL94/V0 listed
Contacts	Gold plated brass
Protective Ground Connection on Housing	According to VDE 0627
Protection according to DIN 40050	IP67 when connected
Certifications	UL/CSA
Electrical Characteristics	
Overvoltage Category	3
Power Contacts Rated Current Rated Voltage Isolation Voltage (L-L) Contact Resistance	75 A 630 VAC / VDC 6000 V <1 mΩ
Signal Contacts Rated Current Rated Voltage Isolation Voltage (L-L) Contact Resistance	30 A 630 VAC / VDC 4000 V <3 mΩ
Mechanical Characteristics	
Temperature Range	-20 °C to +130 °C
Housing Material	Magnesium die cast / aluminum, nickel plated
Gaskets	FPM / HNBR
Mating Cycles	> 50
Crimp Range	4 x 1.5 - 10 mm ² + 4 x 0.5 - 2.5 mm ²
Cable ø	17 - 26 mm
Manufacturer Information	
Manufacturer Internet Address	INTERCONTEC www.intercontec.biz
Manufacturer's Product ID	CSTA 264 FR 48 25 0001 000

Table 44: Technical data for motor connector 8PM003.00-1

3.3 Encoder Connectors

3.3.1 Order Data

Model number	Short description	Image
EnDat Connector		
8PE001.00-1	EnDat Connector 17 pin Intercontec socket, crimp range 17 x 0.06-1,0mm ² , for cable ø 9-12mm, IP67, UL/CSA listed	
Resolver Connector		
8PR001.00-1	Resolver connector 12 pin Intercontec socket, crimp range 12 x 0.06-1,0mm ² , for cable ø 5.5-10.5mm, IP67, UL/CSA listed	

Table 45: Order data for encoder connectors

3.3.2 Technical Data for EnDat Connector 8PE001.00-1

Product ID	8PE001.00-1
General Information	
Connector Size	Size 1
Contacts	17 signal contacts
Degree of Pollution	3
Installation Altitude	Up to 2000 m
Insulator	PA 6.6 / PBT, UL94/V0 listed
Contacts	Gold plated brass
Protective Ground Connection on Housing	According to VDE 0627
Protection according to DIN 40050	IP67 when connected
Certifications	UL/CSA
Electrical Characteristics	
Overtoltage Category	3
Signal Contacts	
Rated Current	9 A
Rated Voltage	125 V
Isolation Voltage (L-L)	2500 V
Contact Resistance	<5 mΩ
Mechanical Characteristics	
Temperature Range	-20 °C to +130 °C
Housing Material	Zinc die cast / brass, nickel plated
Gaskets	FPM / HNBR
Mating Cycles	> 50
Crimp Range	17 x 0.06 - 1 mm ²
Cable ø	5.5 - 10.5 mm
Manufacturer Information	
Manufacturer	INTERCONTEC
Internet Address	www.intercontec.biz
Manufacturer's Product ID	ASTA 035 FR 11 10 0035 000

Table 46: Technical data for EnDat connector 8PE001.00-1

3.3.3 Technical Data for Resolver Connector 8PR001.00-1

Product ID	8PR001.00-1
General Information	
Connector Size	Size 1
Contacts	12 signal contacts
Degree of Pollution	3
Installation Altitude	Up to 2000 m
Insulator	PA 6.6 / PBT, UL94/V0 listed
Contacts	Gold plated brass
Protective Ground Connection on Housing	According to VDE 0627
Protection according to DIN 40050	IP67 when connected
Certifications	UL/CSA
Electrical Characteristics	
Overvoltage Category	3
Signal Contacts	
Rated Current	9 A
Rated Voltage	160 V
Isolation Voltage (L-L)	2500 V
Contact Resistance	<5 mΩ
Mechanical Characteristics	
Temperature Range	-20 °C to +130 °C
Housing Material	Zinc die cast / brass, nickel plated
Gaskets	FPM / HNBR
Mating Cycles	> 50
Crimp Range	12 x 0.06 - 1 mm ²
Cable ø	5.5 - 10.5 mm
Manufacturer Information	
Manufacturer	INTERCONTEC
Internet Address	www.intercontec.biz
Manufacturer's Product ID	ASTA 021 FR 11 10 0035 000

Table 47: Technical data for resolver connector 8PR001.00-1

Chapter 3 • Installation

1. General Information

Warning!

Three-phase synchronous motors 8LS are not permitted to be connected directly to the power mains, they are only permitted to be operated in combination with ACOPOS servo drives!

8LS three-phase synchronous motors must be installed on the cooling surface (= flange).

Caution!

Free convection on the motor housing must be guaranteed!

As specified in DIN 580, eye bolts are available on the upper and lower sides for lifting size 8 motors.

1.1 Mounting Drive Elements

Information:

For connection of pinion gears, belt disks or similar drive elements, please use suitable clamping sets, pressure sleeves or other fastening elements.

Drive elements must be protected against unintentional removal.

Caution!

The bearing elements are not permitted to be subject to shocks or impacts! Incorrect handling will cause the lifespan of the bearings to be reduced or the bearing to be damaged.

Mounting • General Information

The axial forces F_a permitted during the installation of gearboxes, pinion gears, couplings, etc. depend on the motor size and can be found in the following table:

Motor Size	Permitted Axial Force F_a [N]	
	Standard Bearing	Special Motor Option "Reinforced A Side Bearing"
2	850	---
3	1400	---
4	2300	5050
5	2500	9500
6	2500	9500
7	5500	---
8	9500	18700

Table 48: Axial forces permitted during installation

Caution!

When installing drive elements on the motor shaft, avoid a hyperstatic arrangement of the motor shaft bearings. The tolerances that occur cause additional force on the motor shaft bearings.

This can significantly reduce the bearing's lifespan or damage the bearing!

The end of the shaft has a threaded center hole which can be used to remove drive elements.

1.2 Connection Plugs

Caution!

The plugs must be connected and fastened correctly.

Incorrectly connecting the plugs and tightening the union nuts can cause problems and damage the servo motor or ACOPOS servo drive!

2. Detailed Dimensions

2.1 Detailed Dimensions for "Top" Connection Direction

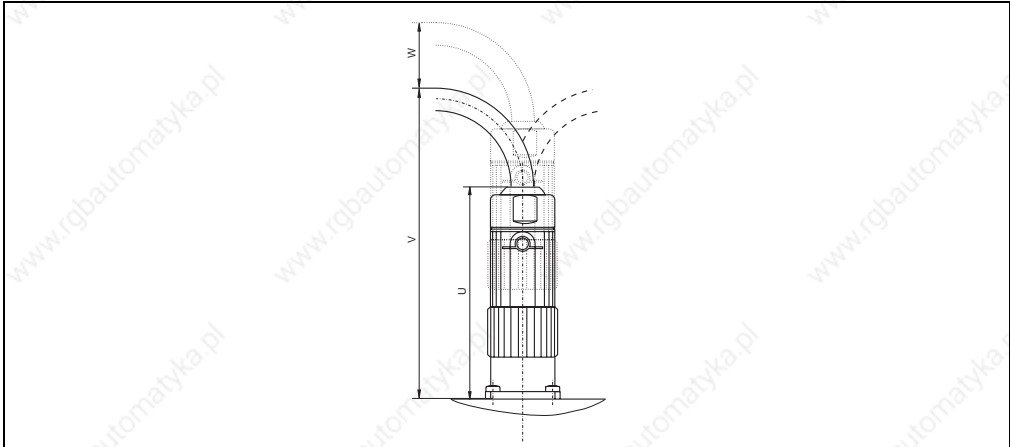

Figure 63: "Top" connection direction

2.1.1 Motor Connector

	Motor Size							
	2	3	4	5	6	7	8	
U [mm]	87						142	
V [mm]	87 + min. flex radius of the connection cable ¹⁾						142 + min. flex radius of the connection cable ¹⁾	
W [mm] ²⁾	Min. 18						Min. 20	

Table 49: Detailed dimensions for "Top" motor connection direction

- 1) For B&R cables, the min. flex radius can be taken from chapter 2 "Cables".
- 2) This minimum distance must be met to ensure proper connection and removal of the connection cable.

2.1.2 Encoder Connection

	Motor Size						
	2	3	4	5	6	7	8
U [mm]	68						
V [mm]	68 + min. flex radius of the connection cable ¹⁾						
W [mm] ²⁾	Min. 17						

Table 50: Detailed dimensions for "Top" encoder connection direction

- 1) For B&R cables, the min. flex radius can be taken from chapter 2 "Cables".
- 2) This minimum distance must be met to ensure proper connection and removal of the connection cable.

2.2 Detailed Dimensions for "Swiveling" Connection Direction

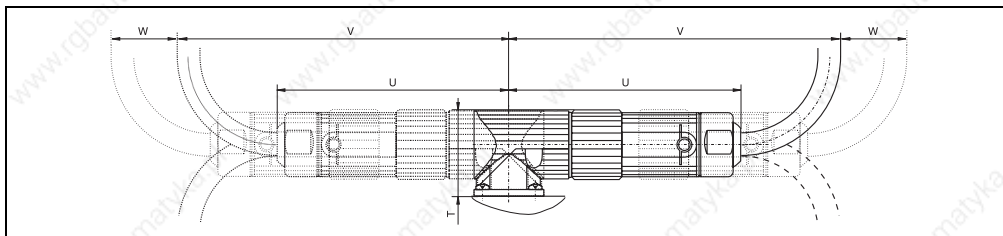

Figure 64: "Swiveling" connection direction

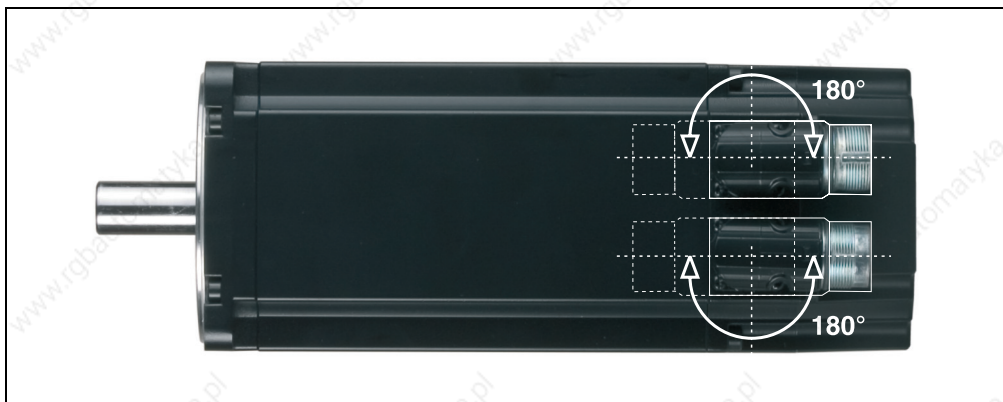

Figure 65: Swivel range of the connectors

2.2.1 Motor Connector

	Motor Size						
	2	3	4	5	6	7	8
T [mm]	39						62,5
U [mm]	95						152
V [mm]	95 + min. flex radius of the connection cable ¹⁾						152 + min. flex radius of the connection cable ¹⁾
W [mm] ²⁾	Min. 18						Min. 20

Table 51: Detailed Dimensions for "Swiveling" Motor Connection Direction

1) For B&R cables, the min. flex radius can be taken from chapter 2 "Cables".

2) This minimum distance must be met to ensure proper connection and removal of the connection cable.

2.2.2 Encoder Connection

	Motor Size						
	2	3	4	5	6	7	8
T [mm]	39						
U [mm]	86						
V [mm]	86 + min. flex radius of the connection cable ¹⁾						
W [mm] ²⁾	Min. 17						

Table 52: Detailed Dimensions for "Swiveling" Encoder Connection Direction

- 1) For B&R cables, the min. flex radius can be taken from chapter 2 "Cables".
- 2) This minimum distance must be met to ensure proper connection and removal of the connection cable.

2.3 Outer Dimensions of the Connectors

Motor Connectors		Encoder Connectors
Size 1 (8PM001.00-1, 8PM002.00-1)	Size 1.5 (8PM003.00-1)	Size 1 (8PE001.00-1, 8PR001.00-1)
 <p>Only for motor sizes 2 to 7</p>	 <p>Only for motor size 8</p>	 <p>For all motor sizes</p>

Table 53: Outer dimensions of the connectors

Chapter 4 • Wiring

1. 8LS Connection Assignments

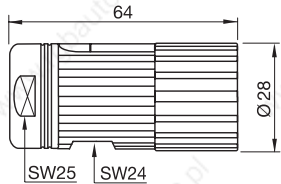
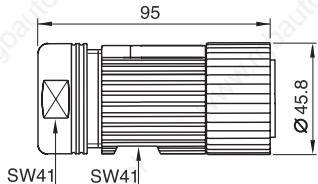
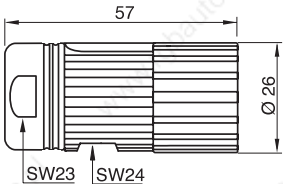
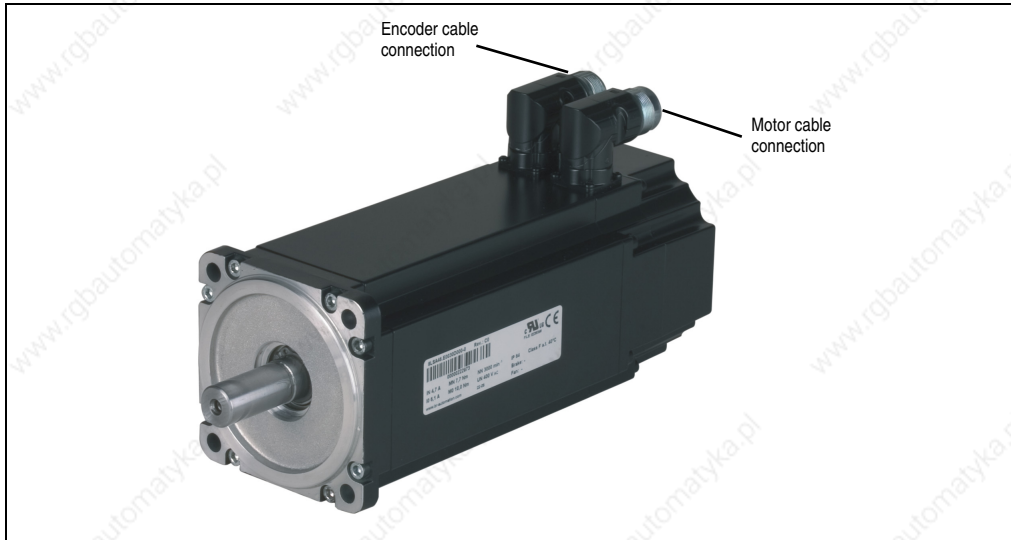

Figure 66: Overview

1.1 Motor Cable Connection

1.1.1 8LSA2...8LSA7

Size 1	Pin	Description	Function
	1	U	Motor connection U
	4	V	Motor connection V
	3	W	Motor connection W
	2	PE	Protective ground conductor
	A	T+	Temperature +
	B	T-	Temperature -
	C	B+	Brake +
	D	B-	Brake -

Table 54: Pin assignments for motor cable attachment size 1

1.1.2 8LSA8

Size 1.5	Pin	Description	Function
	U	U	Motor connection U
	V	V	Motor connection V
	W	W	Motor connection W
	PE	PE	Protective ground conductor
	1	T+	Temperature +
	2	T-	Temperature -
	+	B+	Brake +
	-	B-	Brake -

Table 55: Pin assignments for motor cable attachment size 1.5

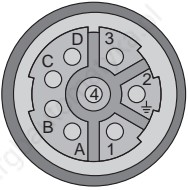
1.2 Encoder Cable Connection

1.2.1 EnDat

EnDat	Pin	Description	Function
	1	Sense +5V	Sense input +5 V
	2	---	---
	3	---	---
	4	Sense COM	Sense input 0 V
	5	---	---
	6	---	---
	7	+5V out / 0.25A	Encoder supply +5 V
	8	T	Clock output
	9	T\	Clock output inverted
	10	COM (1, 3 - 9, 11, 13 - 15)	Encoder supply 0 V
	11	---	---
	12	B	Channel B
	13	B\	Channel B inverted
	14	D	Data input
	15	A	Channel A
	16	A\	Channel A inverted
	17	D\	Data inverted

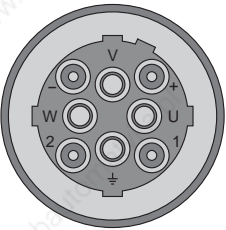
Table 56: Pin assignments for EnDat encoder cable attachment

1.2.2 Resolver

Resolver	Pin	Description	Function	Typical wire colors for the resolver
	1	---	---	---
	2	---	---	---
	3	S4	Sine input +	Blue
	4	S1	Cosine input -	Red
	5	R2	Reference output +	black/white (or yellow/white)
	6	---	---	---
	7	S2	Sine input -	Yellow
	8	S3	Cosine input +	Black
	9	R1	Reference output -	Red/white
	10	---	---	---
	11	---	---	---
	12	---	---	---

Table 57: Pin assignments for resolver encoder cable attachment

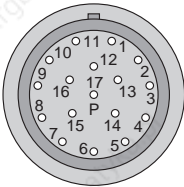
2. Cables

2.1 Motor Cables

2.1.1 Motor Cable Construction

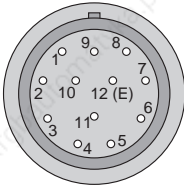
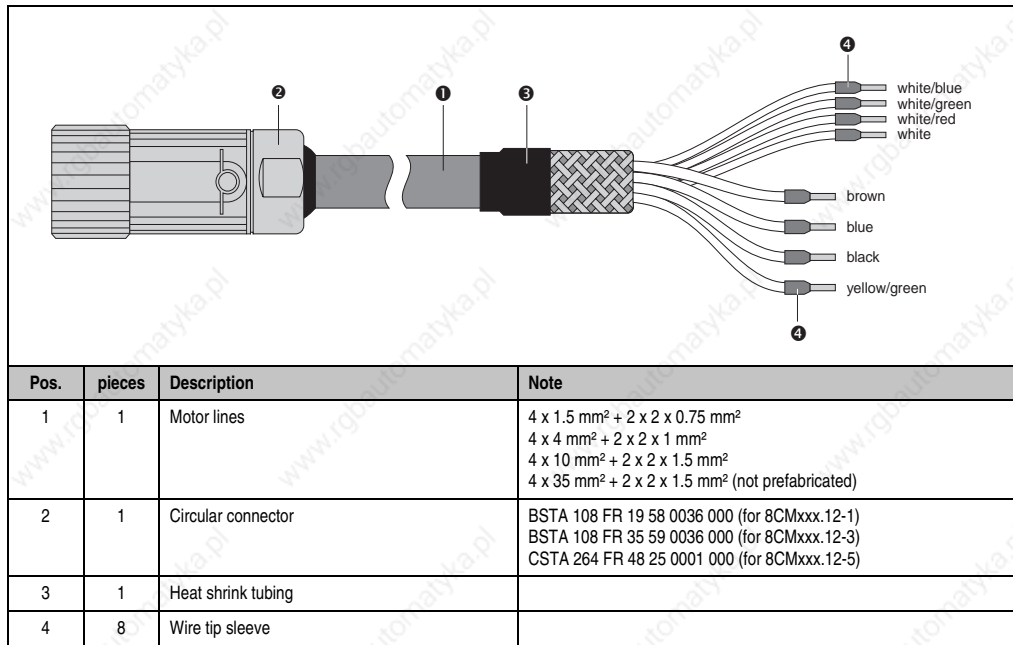

Table 58: Motor cable construction

2.1.2 Pin Assignments for 8CMxxx.12-1, 8CMxxx.12-3

Circular connector	Pin	Description	Function
	1	U	Motor connection U
	4	V	Motor connection V
	3	W	Motor connection W
	2	PE	Protective ground conductor
	A	T+	Temperature +
	B	T-	Temperature -
	C	B+	Brake +
	D	B-	Brake -

Table 59: Pin assignments for motor cable 8CMxxx.12-1, 8CMxxx.12-3

2.1.3 Cable Schematic for 8CMxxx.12-1, 8CMxxx.12-3

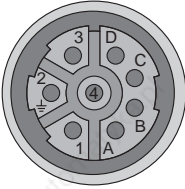
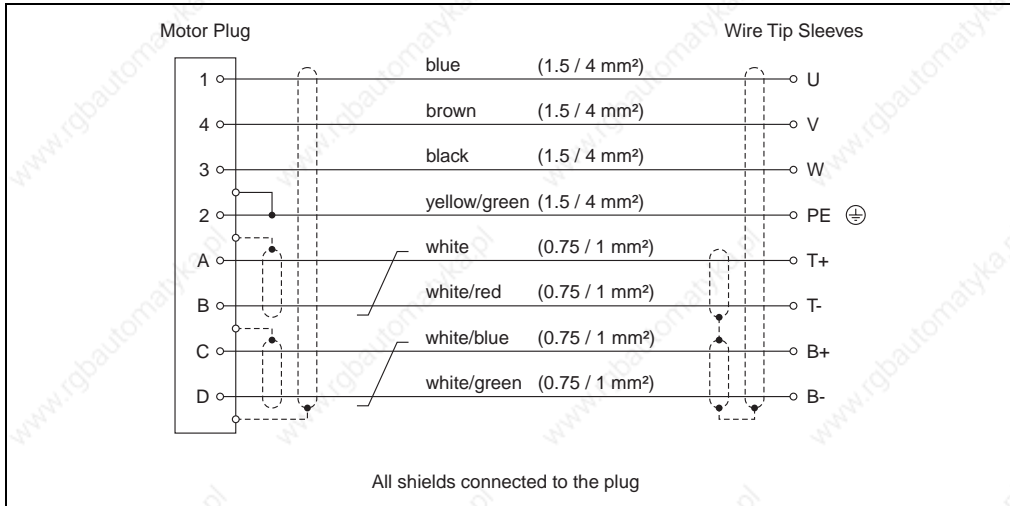

Figure 67: Cable schematic for motor cables 8CMxxx.12-1, 8CMxxx.12-3

2.1.4 Pin Assignments for 8CMxxx.12-5

Circular connector	Pin	Description	Function
	U	U	Motor connection U
	V	V	Motor connection V
	W	W	Motor connection W
	⊥	PE	Protective ground conductor
	1	T+	Temperature +
	2	T-	Temperature -
	+	B+	Brake +
	-	B-	Brake -

Table 60: Pin assignments for motor cables 8CMxxx.12-5

2.1.5 Cable Schematic for 8CMxxx.12-5

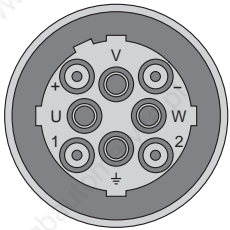
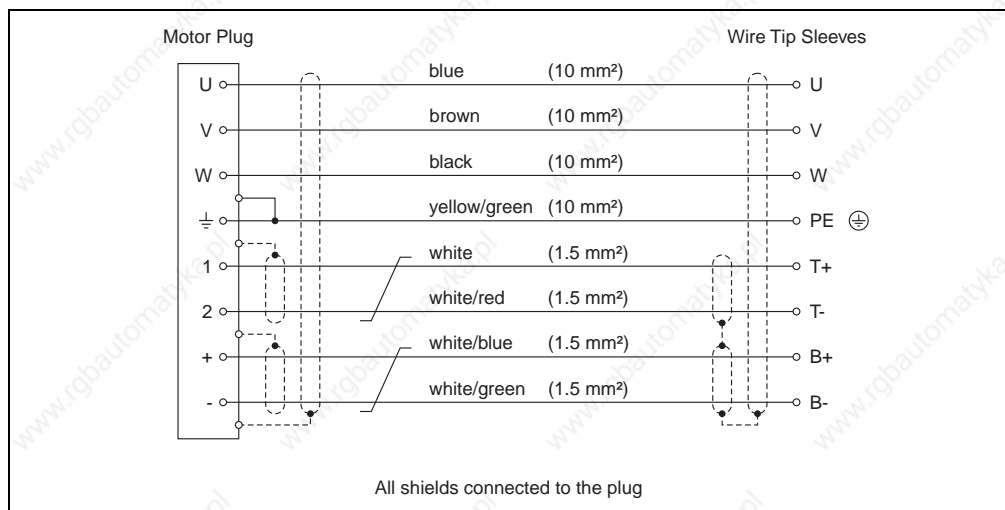
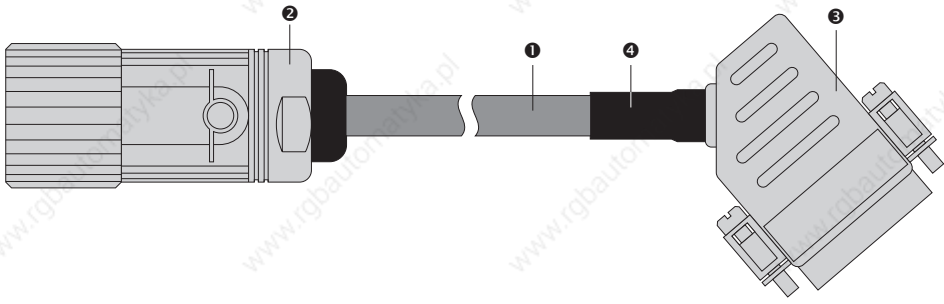

Figure 68: Cable schematic for motor cables 8CMxxx.12-5

2.2 EnDat Encoder Cables

2.2.1 EnDat Encoder Cable Construction



Pos.	pieces	Description	Note
1	1	Encoder cable	10 x 0.14 mm ² + 2 x 0.50 mm ²
2	1	Circular connector, 17 pin socket	ASTA 035 FR 11 10 0035 000
3	1	DSUB housing 45°, metal plated, 15-pin plug	
4	1	Heat shrink tubing	

Table 61: EnDat encoder cable construction

2.2.2 Pin Assignments

Circular connector	Pin	Description	Function	Pin	DSUB plug
	15	A	Channel A	1	
	10	COM (1, 3 - 9, 11, 13 - 15)	Encoder supply 0 V	2	
	12	B	Channel B	3	
	7	+5V out / 0.25A	Encoder supply +5 V	4	
	14	D	Data input	5	
	8	T	Clock output	8	
	16	A\	Channel A inverted	9	
	4	Sense COM	Sense input 0 V	10	
	13	B\	Channel B inverted	11	
	1	Sense +5V	Sense input +5 V	12	
	17	D\	Data inverted	13	
	9	T\	Clock output inverted	15	

Table 62: Pin assignments for EnDat encoder cables

2.2.3 Cable Schematic

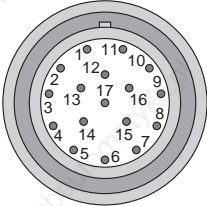
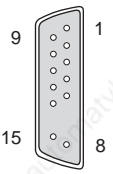
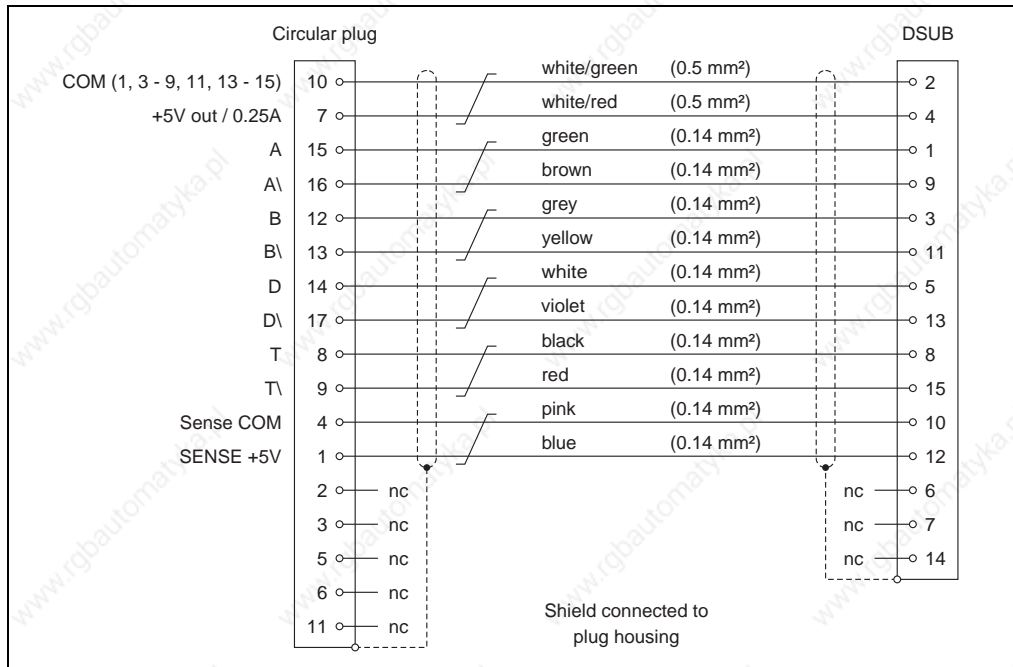
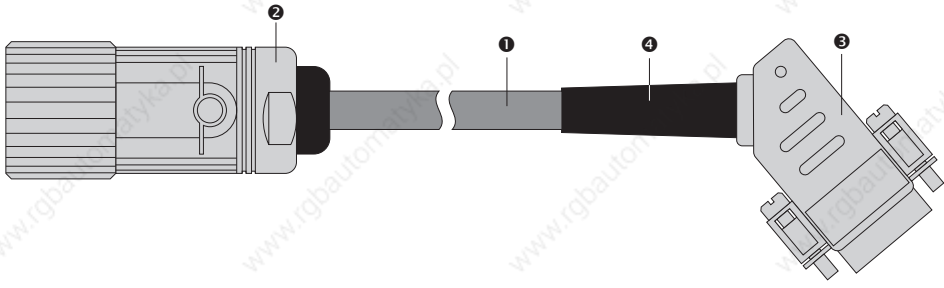

Figure 69: Cable schematic for EnDat encoder cables

2.3 Resolver Cables

2.3.1 Resolver Cable Construction



Pos.	pieces	Description	Note
1	1	Encoder cable	3 x 2 x 24 AWG/19
2	1	Circular connector, 12 pin socket	ASTA 021 FR 11 10 0035 000
3	1	DSUB housing 45°, metal plated, 9 pin plug	
4	1	Kink protection	

Table 63: Resolver cable construction

2.3.2 Pin Assignments

Circular connector	Pin	Description	Function	Pin	DSUB plug
	1	---			
	2	---			
	3	S4	Sine input +	3	
	4	S1	Cosine input -	4	
	5	R2	Reference output +	5	
	6	---			
	7	S2	Sine input -	7	
	8	S3	Cosine input +	8	
	9	R1	Reference output -	9	
	10	---			
	11	---			
	12	---			

Table 64: Pin assignments for resolver cable

2.3.3 Cable Schematic

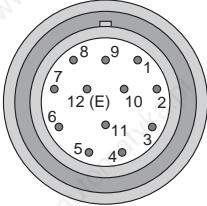
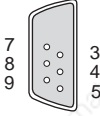
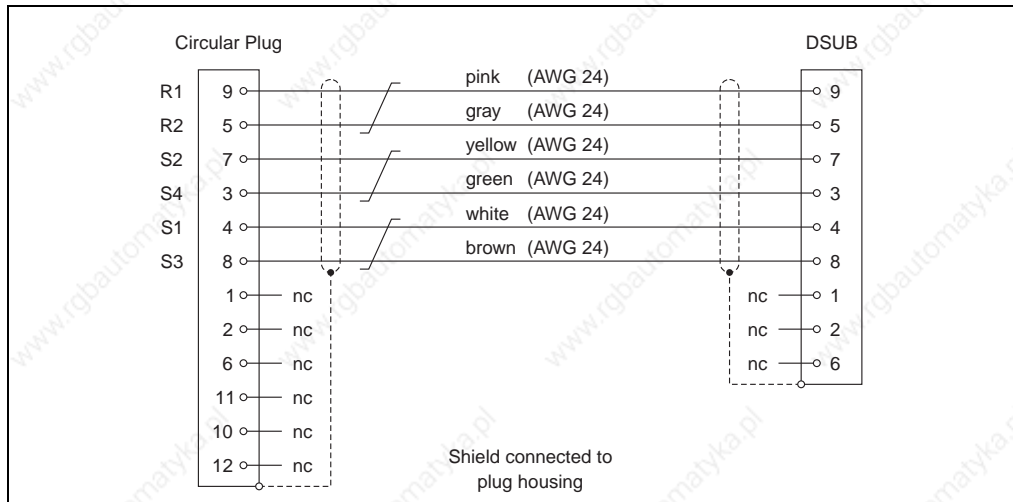

Figure 70: Cable schematic for resolver cables

Chapter 5 • Standards and Certifications

1. Valid European Guidelines

- EMC guidelines 89/336/EWG
- Low-voltage guidelines 73/23/EWG
- Machine guidelines 98/37/EG

2. Valid Standards for Servo Motors

Standard	Description
EN 60034-1	Rotating electrical machines <ul style="list-style-type: none"> • Part 1: measurement and operational behavior
EN 60034-5	Rotating electrical machines <ul style="list-style-type: none"> • Part 5: Degrees of protection provided by the integral design of rotating electrical machines (IP code)
EN 60034-6	Rotating electrical machines <ul style="list-style-type: none"> • Part 6: Methods of cooling (IC code)
EN 60034-7	Rotating electrical machines <ul style="list-style-type: none"> • Part 7: Classification of types of construction, mounting arrangements and terminal box position (IM code)
IEC 60034-11	Rotating electrical machines <ul style="list-style-type: none"> • Part 11: Built-in thermal protection
EN 60034-14	Rotating electrical machines <ul style="list-style-type: none"> • Part 14: Mechanical vibration of certain machines with shaft heights 56 mm and higher; measurement, evaluation and limits of vibration
DIN ISO 281	Roller Bearing, Dynamic Load Ratings and Rated Lifespan
DIN 580	Lifting eye bolts
DIN 748	Cylindrical shaft ends for electrical machines
DIN 3760	Rotary oil seals
DIN 6885-1	Drive type fastenings without taper action; keys, keyways, deep pattern
DIN ISO 8821	Mechanical vibration; convention for balancing shaft/fittings and key type
DIN 42948	Mounting flanges for electrical machines
DIN 42955	Concentricity of the shaft end, coaxial mounting flanges for rotary electrical machines; tolerances, tests
UL 1004	Standard for Electric Motors

Table 65: Valid standards for servo motors

3. International Certifications

B&R products and services comply with the applicable standards. They are international standards from organizations such as ISO, IEC and CENELEC, as well as national standards from organizations such as UL, CSA, FCC, VDE, ÖVE, etc. We give special consideration to the reliability of our products in an industrial environment.



Certifications	
USA and Canada 	All 8MS three-phase synchronous motors are tested and listed by Underwriters Laboratories. This mark is valid for the USA and Canada and eases certification of your machines and systems in these areas.
Europe 	All harmonized EN standards for the valid guidelines are met.

Table 66: International Certifications

4. Standards, Definitions for Safety Techniques

Stop Functions according to IEC 60204-1/11.98 (electrical equipment for machines, part 1: general requirements)

The following three stop function categories exist:

Category	Description
0	Stop by immediately switching off the power to the machine drive elements (i.e. uncontrolled stop).
1	A controlled stop, the power to the machine drive elements remains on until the stop procedure is completed. The power is switched off after the stop is complete.
2	A controlled stop, the power to the machine drive elements is not switched off.

Table 67: Overview of stop function categories

The necessary stop functions must be determined based on a risk evaluation for the machine. Stop functions in category 0 and category 1 must be able to function regardless of the operating mode. A category 0 stop must have priority. Stop functions must have priority over assigned start functions. Resetting the stop function is not permitted to cause a dangerous state.

Emergency stops according to IEC 60204-1/11.98 (electrical equipment for machines, part 1: general requirements)

The following requirements are valid for emergency stops in addition to the requirements for the stop functions:

- It must have priority over all other functions and operations in all operating modes.
- The power to the machine drive elements which can cause a dangerous state must be switched off as quickly as possible without creating other dangers.
- Resetting is not permitted to cause a restart.

Emergency stops must be category 0 or category 1 stop functions. The necessary stop function must be determined based on a risk evaluation for the machine.

For emergency stop function in stop category 0, only hard wired, electromechanical equipment can be used. Additionally, the function is not permitted to depend on electronic switching logic (hardware or software) or the transfer of commands via a communication network or data connection. ¹⁾

When using a category 1 stop function for the emergency stop function, it must be guaranteed that the power to the machine drive elements is completely switched off. These elements must be switched off using electromechanical equipment. ¹⁾

¹⁾ In accordance to the national foreword for the valid German version of IEC 60204-1/11.98, it is determined that electronic equipment (and also especially for emergency stop systems) can be used regardless of the stop category, if e.g. it provides the same safety using the standards EN 954-1 and/or IEC 61508 as required by IEC 60204-1.

Safety category according to EN 954-1/03.97 (safety of machines - safety related parts of control systems, part 1: general design principles) ¹⁾

The safety related parts of control systems must meet one or more of the requirements for five defined safety categories. The safety categories define the required behavior of safety related controller parts regarding their resistance to errors.

Safety Category (according to EN 954-1)	Safety integrity level - SIL (according to IEC 61508-2)	Short description	System Behavior
B	---	Safety related parts must be designed and built so that they can meet the expected operational requirements. (No specific safety measures are implemented.)	Caution! An error can cause the safety function to fail.
1	1	Safety related parts must be designed and built so that only reliable components and safety principles are used. (e.g. preventing short circuits by using sufficient distances, reducing the probability of errors by over-dimensioning components, defining the failure route - closed-circuit current principle, etc.)	Caution! An error can cause the safety function to fail.
2	1	Safety related parts must be designed so that their safety functions are checked in suitable intervals by the machine controller. (e.g. automatic or manual check during start-up)	Caution! An error between checks can cause the safety function to fail. If the safety function fails, it will be recognized during the check.
3	2	Safety related parts must be designed so that individual errors do not cause the safety function to fail. Individual errors should - if possible - be recognized the next time (or before) the safety function is required.	Caution! The safety function remains active when an error occurs. Some, but not all errors are recognized. A buildup of errors can cause the safety function to fail.
4	3	Safety related parts must be designed so that individual errors do not cause the safety function to fail. Individual errors must be recognized the next time (or before) the safety function is required. If this type of recognition is not possible, a buildup of errors is not permitted to cause the safety function to fail.	Information: The safety function remains active when an error occurs. Errors are recognized in time to prevent the safety function from failing.

Table 68: Safety category overview

1) To prevent confusing EN 951-1 categories with IEC 60204-1 stop categories, the term "safety categories" was used in the text shown above for EN 954-1 categories.

Selecting the suitable safety category must be done separately for each ACOPOS servo drive (or for each shaft) based on a risk evaluation. This risk evaluation is a part of the total risk evaluation for the machine.

The following risk graph (according to EN 954-1, Appendix B) provides a simplified procedure for risk evaluation:

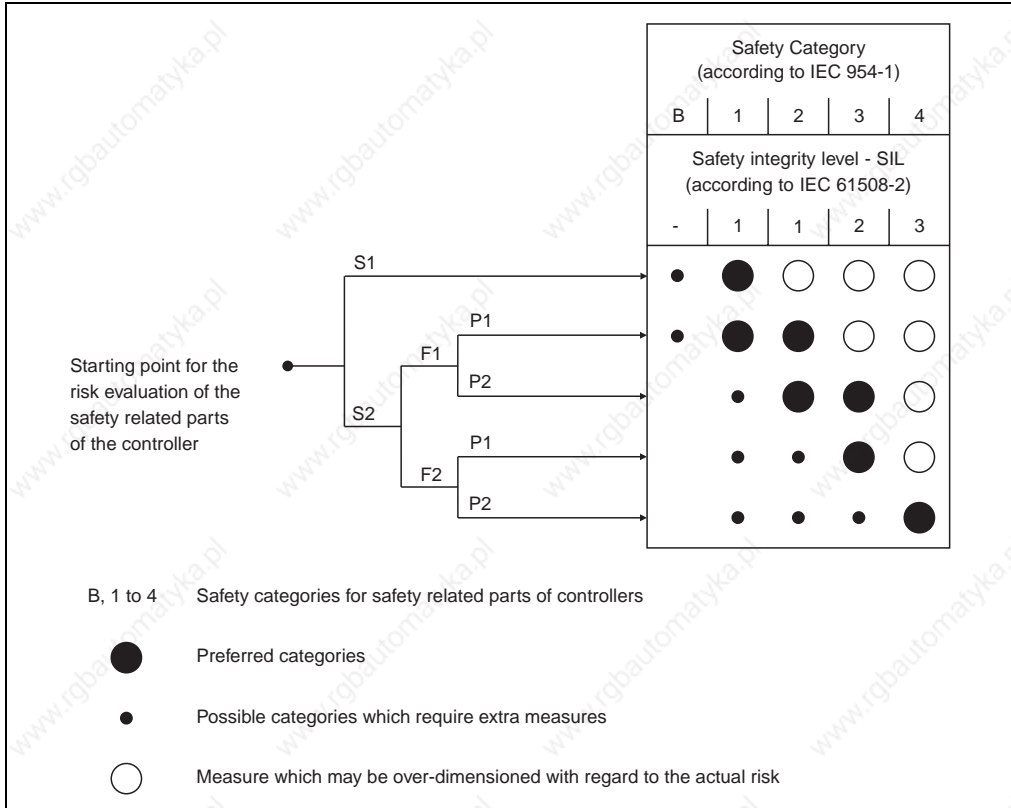

Figure 71: Risk graph according to EN 954-1, Appendix B

Begin at the starting point shown and follow the parameters S, F and P to the safety category to be used.

Parameter S ... Seriousness of injury	
S1	Light (usually reversible) injury.
S2	Serious (usually irreversible) injury.
Parameter F ... Frequency and/or duration of the danger exposure	
F1	Seldom to slightly more frequent and/or short exposure duration.
F2	Frequent to continuous and/or long exposure duration.
Parameter P ... Possibility to prevent danger	
P1	Possible under some conditions.
P2	Nearly impossible.

Table 69: Parameters S, F and P lead you to the safety category to be used

Restart inhibit according to EN 1037/04.96 (Safety of machinery - prevention of unexpected start-up)

Keeping a machine in an idle state when people are working in the danger zone is one of the most important requirements for safe operation of machines.

Starting refers to the transition of a machine or its parts from an idle state to moving state. Any start is unexpected if it is caused by:

- A start command sent because of a controller failure or because of external influences on the controller.
- A start command sent because of incorrect operation of a start element or another part of the machine.
- Restoration of power supply after an interruption.
- External/internal influences on parts of the machine.

To prevent unexpected starting of machines or parts of machines, power should be removed and dissipated. If this is not practical (e.g. frequent, short work in danger zone), other measures must be taken:

- Measures to prevent random start commands.
- Measures to prevent that random start commands cause unexpected starting.
- Measures to automatically stop dangerous parts of the machine before a dangerous situation can be caused by unexpected starting.

Figure 1:	8LS Three-phase synchronous motors	11
Figure 2:	Start-up with B&R Automation Studio™	13
Figure 3:	Swivel connectors	14
Figure 4:	Warning on the servo drives	17
Figure 5:	"Hot surface" warning	19
Figure 6:	Definitions for maximum shaft load diagrams	38
Figure 7:	Speed - torque characteristic curve for 8LSA23.eennnffgg-0	48
Figure 8:	Speed - torque characteristic curve for 8LSA24.eennnffgg-0	48
Figure 9:	Speed - torque characteristic curve for 8LSA25.eennnffgg-0	49
Figure 10:	Speed - torque characteristic curve for 8LSA26.eennnffgg-0	49
Figure 11:	Speed - torque characteristic curve for 8LSA23.eennnffgg-0	50
Figure 12:	Speed - torque characteristic curve for 8LSA24.eennnffgg-0	50
Figure 13:	Speed - torque characteristic curve for 8LSA25.eennnffgg-0	51
Figure 14:	Speed - torque characteristic curve for 8LSA26.eennnffgg-0	51
Figure 15:	Speed - torque characteristic curve for 8LSA33.eennnffgg-0	55
Figure 16:	Speed - torque characteristic curve for 8LSA34.eennnffgg-0	55
Figure 17:	Speed - torque characteristic curve for 8LSA35.eennnffgg-0	56
Figure 18:	Speed - torque characteristic curve for 8LSA36.eennnffgg-0	56
Figure 19:	Speed - torque characteristic curve for 8LSA33.eennnffgg-0	57
Figure 20:	Speed - torque characteristic curve for 8LSA34.eennnffgg-0	57
Figure 21:	Speed - torque characteristic curve for 8LSA35.eennnffgg-0	58
Figure 22:	Speed - torque characteristic curve for 8LSA36.eennnffgg-0	58
Figure 23:	Speed - torque characteristic curve for 8LSA43.eennnffgg-0	62
Figure 24:	Speed - torque characteristic curve for 8LSA44.eennnffgg-0	62
Figure 25:	Speed - torque characteristic curve for 8LSA45.eennnffgg-0	63
Figure 26:	Speed - torque characteristic curve for 8LSA46.eennnffgg-0	63
Figure 27:	Speed - torque characteristic curve for 8LSA43.eennnffgg-0	64
Figure 28:	Speed - torque characteristic curve for 8LSA44.eennnffgg-0	64
Figure 29:	Speed - torque characteristic curve for 8LSA45.eennnffgg-0	65
Figure 30:	Speed - torque characteristic curve for 8LSA46.eennnffgg-0	65
Figure 31:	Speed - torque characteristic curve for 8LSA53.eennnffgg-0	69
Figure 32:	Speed - torque characteristic curve for 8LSA54.eennnffgg-0	69
Figure 33:	Speed - torque characteristic curve for 8LSA55.eennnffgg-0	70
Figure 34:	Speed - torque characteristic curve for 8LSA56.eennnffgg-0	70
Figure 35:	Speed - torque characteristic curve for 8LSA57.eennnffgg-0	71
Figure 36:	Speed - torque characteristic curve for 8LSA53.eennnffgg-0	71
Figure 37:	Speed - torque characteristic curve for 8LSA54.eennnffgg-0	72
Figure 38:	Speed - torque characteristic curve for 8LSA55.eennnffgg-0	72
Figure 39:	Speed - torque characteristic curve for 8LSA56.eennnffgg-0	73
Figure 40:	Speed - torque characteristic curve for 8LSA57.eennnffgg-0	73
Figure 41:	Speed - torque characteristic curve for 8LSA63.eennnffgg-0	77
Figure 42:	Speed - torque characteristic curve for 8LSA64.eennnffgg-0	77
Figure 43:	Speed - torque characteristic curve for 8LSA65.eennnffgg-0	78
Figure 44:	Speed - torque characteristic curve for 8LSA66.eennnffgg-0	78
Figure 45:	Speed - torque characteristic curve for 8LSA63.eennnffgg-0	79
Figure 46:	Speed - torque characteristic curve for 8LSA64.eennnffgg-0	79
Figure 47:	Speed - torque characteristic curve for 8LSA65.eennnffgg-0	80

Figure Index

Figure 48:	Speed - torque characteristic curve for 8LSA66.eennnffgg-0	80
Figure 49:	Speed - torque characteristic curve for 8LSA73.eennnffgg-0	84
Figure 50:	Speed - torque characteristic curve for 8LSA74.eennnffgg-0	84
Figure 51:	Speed - torque characteristic curve for 8LSA75.eennnffgg-0	85
Figure 52:	Speed - torque characteristic curve for 8LSA73.eennnffgg-0	85
Figure 53:	Speed - torque characteristic curve for 8LSA74.eennnffgg-0	86
Figure 54:	Speed - torque characteristic curve for 8LSA75.eennnffgg-0	86
Figure 55:	Speed - torque characteristic curve for 8LSA83.eennnffgg-0	90
Figure 56:	Speed - torque characteristic curve for 8LSA84.eennnffgg-0	90
Figure 57:	Speed - torque characteristic curve for 8LSA85.eennnffgg-0	91
Figure 58:	Speed - torque characteristic curve for 8LSA86.eennnffgg-0	91
Figure 59:	Speed - torque characteristic curve for 8LSA83.eennnffgg-0	92
Figure 60:	Speed - torque characteristic curve for 8LSA84.eennnffgg-0	92
Figure 61:	Speed - torque characteristic curve for 8LSA85.eennnffgg-0	93
Figure 62:	Speed - torque characteristic curve for 8LSA86.eennnffgg-0	93
Figure 63:	"Top" connection direction.....	115
Figure 64:	"Swiveling" connection direction.....	116
Figure 65:	Swivel range of the connectors	116
Figure 66:	Overview	119
Figure 67:	Cable schematic for motor cables 8CMxxx.12-1, 8CMxxx.12-3.....	123
Figure 68:	Cable schematic for motor cables 8CMxxx.12-5.....	124
Figure 69:	Cable schematic for EnDat encoder cables	126
Figure 70:	Cable schematic for resolver cables	128
Figure 71:	Risk graph according to EN 954-1, Appendix B.....	133

Table 1:	Description of the safety notices used in this manual	19
Table 2:	Available lengths	22
Table 3:	Technical data for EnDat encoders	23
Table 4:	Technical data for the resolver	24
Table 5:	Rated speeds available according to size and length	25
Table 6:	Technical data for the standard holding brake	27
Table 7:	Axial forces permitted during installation	29
Table 8:	Order key code (ff) for the motor options	32
Table 9:	Available motor sizes for special motor option "reinforced A side bearing"	33
Table 10:	General technical data	36
Table 11:	Connection direction terminology, bearings	38
Table 12:	Formula symbols	39
Table 13:	Motor data overview for cooling type A	41
Table 14:	Motor data overview for cooling type A (cont.)	42
Table 15:	Motor data overview for cooling type A (cont.)	43
Table 16:	Motor data overview for cooling type A (cont.)	44
Table 17:	Motor data overview for cooling type A (cont.)	45
Table 18:	Motor data overview for cooling type A (cont.)	46
Table 19:	Technical data for 8LSA2	47
Table 20:	8LSA2 dimensions	52
Table 21:	Maximum shaft load for 8LSA2	53
Table 22:	Technical data for 8LSA3	54
Table 23:	8LSA3 dimensions	59
Table 24:	Maximum shaft load for 8LSA3	60
Table 25:	Technical data for 8LSA4	61
Table 26:	8LSA4 dimensions	66
Table 27:	Maximum shaft load for 8LSA4	67
Table 28:	Technical data for 8LSA5	68
Table 29:	8LSA5 dimensions	74
Table 30:	Maximum shaft load for 8LSA5	75
Table 31:	Technical data for 8LSA6	76
Table 32:	8LSA6 dimensions	81
Table 33:	Maximum shaft load for 8LSA6	82
Table 34:	Technical data for 8LSA7	83
Table 35:	8LSA7 dimensions	87
Table 36:	Maximum shaft load for 8LSA7	88
Table 37:	Technical data for 8LSA8	89
Table 38:	8LSA8 dimensions	94
Table 39:	Maximum shaft load for 8LSA8	95
Table 40:	Order data for motor cables	97
Table 41:	Technical data for motor cables 1.5 and 4 mm ²	99
Table 42:	Technical data for motor cables 10 and 35 mm ²	100
Table 43:	Order data for EnDat cables	101
Table 44:	Technical data for EnDat cables	101
Table 45:	Order data for resolver cables	103
Table 46:	Technical data for resolver cables	103
Table 47:	Order data for motor connectors	106

Table Index

Table 48:	Technical data for motor connectors 8PM001.00-1 and 8PM002.00-1	107
Table 49:	Technical data for motor connector 8PM003.00-1	108
Table 50:	Order data for encoder connectors	109
Table 51:	Technical data for EnDat connector 8PE001.00-1	110
Table 52:	Technical data for resolver connector 8PR001.00-1	111
Table 53:	Axial forces permitted during installation	114
Table 54:	Detailed dimensions for "Top" motor connection direction	115
Table 55:	Detailed dimensions for "Top" encoder connection direction	115
Table 56:	Detailed Dimensions for "Swiveling" Motor Connection Direction	116
Table 57:	Detailed Dimensions for "Swiveling" Encoder Connection Direction	117
Table 58:	Outer dimensions of the connectors	117
Table 59:	Pin assignments for motor cable attachment size 1	120
Table 60:	Pin assignments for motor cable attachment size 1.5	120
Table 61:	Pin assignments for EnDat encoder cable attachment	121
Table 62:	Pin assignments for resolver encoder cable attachment	121
Table 63:	Motor cable construction	122
Table 64:	Pin assignments for motor cable 8CMxxx.12-1, 8CMxxx.12-3	123
Table 65:	Pin assignments for motor cables 8CMxxx.12-5	124
Table 66:	EnDat encoder cable construction	125
Table 67:	Pin assignments for EnDat encoder cables	125
Table 68:	Resolver cable construction	127
Table 69:	Pin assignments for resolver cable	127
Table 70:	Valid standards for servo motors	129
Table 71:	International Certifications	130
Table 72:	Overview of stop function categories	131
Table 73:	Safety category overview	132
Table 74:	Parameters S, F and P lead you to the safety category to be used	134

Numbers

8LS Three-phase Synchronous Motors	21
8LSA2	47
8LSA3	54
8LSA4	61
8LSA5	68
8LSA6	76
8LSA7	83
8LSA8	89

A

A Side Bearing	
See Terminology	
Axial Force	30

B

B Side Bearing	
See Terminology	
Brake	
see Holding Brake	

C

Cable	
Encoder Cables	
EnDat	101, 125
Resolver	103, 127
General information	96
Motor Cables	97, 122
Certifications	130
Connection Direction	
also see Detailed Dimensions	
Connection Directions	
Swivel connector	38
Top	38
Connector	
see Connectors	
Connectors	
Encoder Connectors	
EnDat	109, 125
Resolver	109, 127
General information	105
Motor Connectors	106, 123

Outer Dimensions	117
------------------------	-----

D

Danger Warning	15
Detailed Dimensions	
"Swiveling" Connection Direction	116
"Top" Connection Direction	115
Encoder Connectors	117
Motor Connectors	117
Dimensions	
Motors	
8LSA2	52
8LSA3	59
8LSA4	66
8LSA5	74
8LSA6	81
8LSA8	94

E

Encoder Cables	
EnDat	101, 125
Resolver	103, 127
Encoder Connectors	
EnDat	109, 125
Resolver	109, 127
EnDat Cables	
Cable Schematic	126
Construction	125
Order data	101
Pin assignments	125
Technical data	101
EnDat Connector	
Order data	109
Pin assignments	125
Technical data	110

F

Formula Symbols	39
-----------------------	----

G

Guidelines	129
------------------	-----

H

Holding brake	
Functionality	26
Lifespan (cycles)	26
Technical data	27

L

Lengths	
see Motors	

M

Maximum Shaft Load	
8LSA2	53
8LSA3	60
8LSA4	67
8LSA5	75
8LSA6	82
8LSA7	88
8LSA8	95
Motor Cables	
Cable Schematic	123, 124
Construction	122
Order data	97
Pin assignments	123, 124
Technical data	99
Motor Characteristic Curves	
8LSA2	48, 50
8LSA3	55, 57
8LSA4	62, 64
8LSA5	69, 71
8LSA6	77, 79
8LSA7	84, 85
8LSA8	90, 92
Motor Connectors	
Order data	106
Pin assignments	123, 124
Technical data	107, 108
Motor Data	
see Technical Data	
Motor Data, General	36
Motors	
Cooling Types	22
Danger Warning	15
Dimensions	

 see Dimensions

Encoder Systems	23
Example Order	35
Holding brake	26
Lengths	22
Motor Data	
Cooling Type A	41
Mounting	16
Order Key	34
Safety notices	15
Sizes	22
Storage	16
Terminology	38
Transport	16
Mounting	16, 113

O

Oil Seal	
see Options for Standard Motors	
Options for Standard Motors	
Connection Directions	31
Determining the Order Code	32
Holding brake	26
Oil Seal	26
Rated speed	25
Shaft End	27
Order data	
Motors	
Example Order	35
Order Key	34

P

Pin assignments	
Cable and Plug	122

R

Radial Force	29
Rated Speed	
see Options for Standard Motors	
Resolver Cables	
Cable Schematic	128
Construction	127
Order data	103

Pin assignments	127	Shaft Key	27
Technical data	103	Sizes	
Resolver Connector		see Motors	
Order data	109	Speed - Torque Characteristic Curves	
Pin assignments	127	see Motor Characteristics Curves	
Technical data	111	Standards	
Restart inhibit	131	Servo Motors	129
Risk Evaluation	133	Storage	16

S

Safety Categories	132
Safety notices	15
Secure restart inhibit	131
Servo Motors	
See Motors	
Shaft End	
also see Options for Standard Motors	
Design	27
Keyed	28
Load Capacity	28
Smooth Shaft	27

T

Technical data	
Motors	
8LSA2	47
8LSA3	54
8LSA4	61
8LSA5	68
8LSA6	76
8LSA7	83
8LSA8	89
Terminology	38
Transport	16

8

8CE005.12-1.....	101	8CM020.12-3.....	97
8CE007.12-1.....	101	8CM020.12-5.....	97
8CE010.12-1.....	101	8CM020.12-8.....	98
8CE015.12-1.....	101	8CM025.12-1.....	97
8CE020.12-1.....	101	8CM025.12-3.....	97
8CE025.12-1.....	101	8CM025.12-5.....	97
8CM005.12-1.....	97	8CM025.12-8.....	98
8CM005.12-3.....	97	8CR005.12-1.....	103
8CM005.12-5.....	97	8CR007.12-1.....	103
8CM005.12-8.....	98	8CR010.12-1.....	103
8CM007.12-1.....	97	8CR015.12-1.....	103
8CM007.12-3.....	97	8CR020.12-1.....	103
8CM007.12-5.....	97	8CR025.12-1.....	103
8CM007.12-8.....	98	8LSA2.....	47
8CM010.12-1.....	97	8LSA3.....	54
8CM010.12-3.....	97	8LSA4.....	61
8CM010.12-5.....	97	8LSA5.....	68
8CM010.12-8.....	98	8LSA6.....	76
8CM015.12-1.....	97	8LSA7.....	83
8CM015.12-3.....	97	8LSA8.....	89
8CM015.12-5.....	97	8PE001.00-1.....	109
8CM015.12-8.....	98	8PM001.00-1.....	106
8CM020.12-1.....	97	8PM002.00-1.....	106
		8PM003.00-1.....	106
		8PR001.00-1.....	109

MAMOT2-E