

**APT2X101D100J**    **1000V**    **95A**  
**APT2X100D100J**    **1000V**    **95A**

## DUAL DIE ISOTOP<sup>®</sup> PACKAGE

### ULTRAFAST SOFT RECOVERY RECTIFIER DIODE

PRODUCT APPLICATIONS	PRODUCT FEATURES	PRODUCT BENEFITS
<ul style="list-style-type: none"> <li>• Anti-Parallel Diode               <ul style="list-style-type: none"> <li>-Switchmode Power Supply</li> <li>-Inverters</li> </ul> </li> <li>• Free Wheeling Diode               <ul style="list-style-type: none"> <li>-Motor Controllers</li> <li>-Converters</li> </ul> </li> <li>• Snubber Diode</li> <li>• Uninterruptible Power Supply (UPS)</li> <li>• Induction Heating</li> <li>• High Speed Rectifiers</li> </ul>	<ul style="list-style-type: none"> <li>• Ultrafast Recovery Times</li> <li>• Soft Recovery Characteristics</li> <li>• Popular SOT-227 Package</li> <li>• Low Forward Voltage</li> <li>• High Blocking Voltage</li> <li>• Low Leakage Current</li> </ul>	<ul style="list-style-type: none"> <li>• Low Losses</li> <li>• Low Noise Switching</li> <li>• Cooler Operation</li> <li>• Higher Reliability Systems</li> <li>• Increased System Power Density</li> </ul>

#### MAXIMUM RATINGS

All Ratings:  $T_C = 25^\circ\text{C}$  unless otherwise specified.

Symbol	Characteristic / Test Conditions	APT2X101_100D100J	UNIT
$V_R$	Maximum D.C. Reverse Voltage	1000	Volts
$V_{RRM}$	Maximum Peak Repetitive Reverse Voltage		
$V_{RWM}$	Maximum Working Peak Reverse Voltage		
$I_F(AV)$	Maximum Average Forward Current ( $T_C = 77^\circ\text{C}$ , Duty Cycle = 0.5)	95	Amps
$I_F(RMS)$	RMS Forward Current (Square wave, 50% duty)	131	
$I_{FSM}$	Non-Repetitive Forward Surge Current ( $T_J = 45^\circ\text{C}$ , 8.3ms)	1000	
$T_J, T_{STG}$	Operating and Storage Temperature Range	-55 to 175	$^\circ\text{C}$
$T_L$	Lead Temperature for 10 Sec.	300	

#### STATIC ELECTRICAL CHARACTERISTICS

Symbol		MIN	TYP	MAX	UNIT	
$V_F$	Forward Voltage		$I_F = 100\text{A}$	1.9	2.5	Volts
			$I_F = 200\text{A}$	2.2		
			$I_F = 100\text{A}, T_J = 125^\circ\text{C}$	1.7		
$I_{RM}$	Maximum Reverse Leakage Current		$V_R = V_R \text{ Rated}$		250	$\mu\text{A}$
			$V_R = V_R \text{ Rated}, T_J = 125^\circ\text{C}$		500	
$C_T$	Junction Capacitance, $V_R = 200\text{V}$		110		pF	

**DYNAMIC CHARACTERISTICS**

APT2X101\_100D100J

Symbol	Characteristic	Test Conditions	MIN	TYP	MAX	UNIT
$t_{rr}$	Reverse Recovery Time	$I_F = 1A, di_F/dt = -100A/\mu s, V_R = 30V, T_J = 25^\circ C$	-	43		ns
$t_{rr}$	Reverse Recovery Time	$I_F = 100A, di_F/dt = -200A/\mu s, V_R = 667V, T_C = 25^\circ C$	-	300		
$Q_{rr}$	Reverse Recovery Charge		-	800		nC
$I_{RRM}$	Maximum Reverse Recovery Current		-	7	-	Amps
$t_{rr}$	Reverse Recovery Time	$I_F = 100A, di_F/dt = -200A/\mu s, V_R = 667V, T_C = 125^\circ C$	-	360		ns
$Q_{rr}$	Reverse Recovery Charge		-	4050		nC
$I_{RRM}$	Maximum Reverse Recovery Current		-	19	-	Amps
$t_{rr}$	Reverse Recovery Time	$I_F = 100A, di_F/dt = -1000A/\mu s, V_R = 667V, T_C = 125^\circ C$	-	170		ns
$Q_{rr}$	Reverse Recovery Charge		-	7400		nC
$I_{RRM}$	Maximum Reverse Recovery Current		-	70		Amps

**THERMAL AND MECHANICAL CHARACTERISTICS**

Symbol	Characteristic / Test Conditions	MIN	TYP	MAX	UNIT
$R_{\theta JC}$	Junction-to-Case Thermal Resistance			.41	$^\circ C/W$
$R_{\theta JA}$	Junction-to-Ambient Thermal Resistance			20	
$W_T$	Package Weight		1.03		oz
			29.2		g
Torque	Maximum Terminal & Mounting Torque			10	lb•in
				1.1	N•m

Microsemi Reserves the right to change, without notice, the specifications and information contained herein.

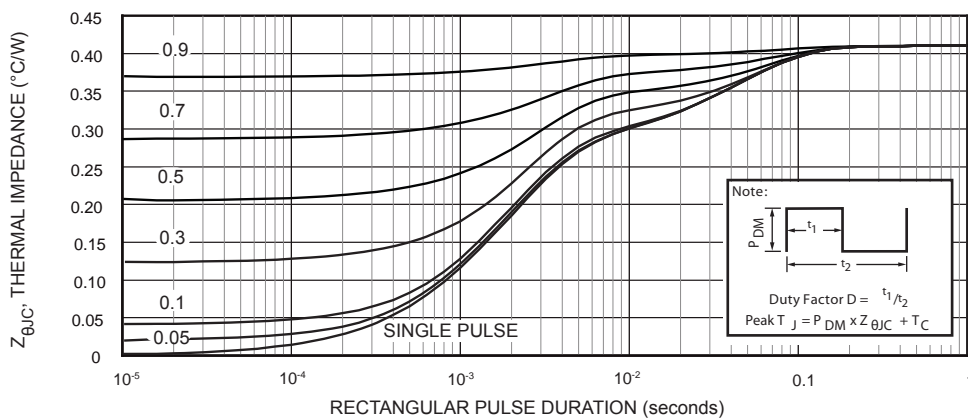

FIGURE 1. MAXIMUM EFFECTIVE TRANSIENT THERMAL IMPEDANCE, JUNCTION-TO-CASE vs. PULSE DURATION

# TYPICAL PERFORMANCE CURVES

APT2X101\_100D100J

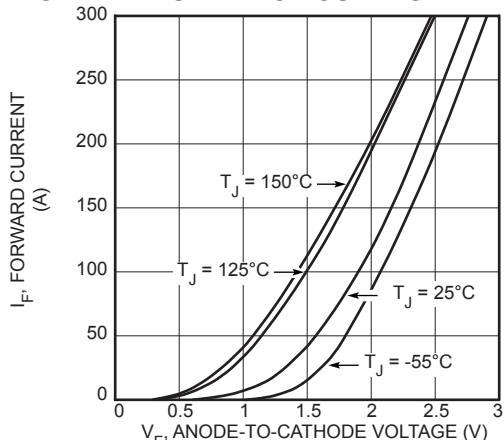

Figure 2. Forward Current vs. Forward Voltage

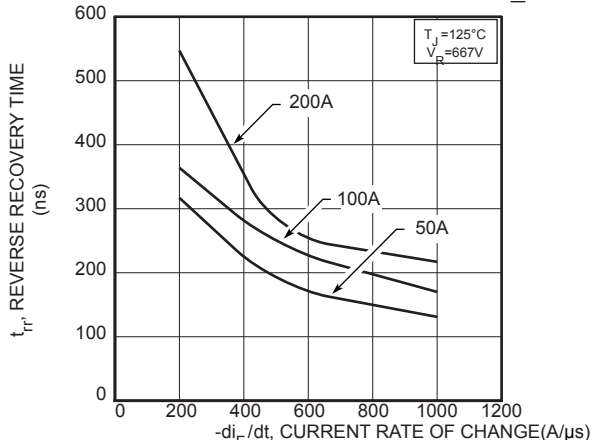

Figure 3. Reverse Recovery Time vs. Current Rate of Change

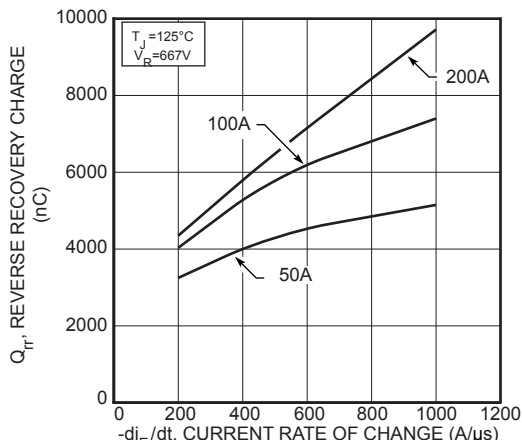

Figure 4. Reverse Recovery Charge vs. Current Rate of Change

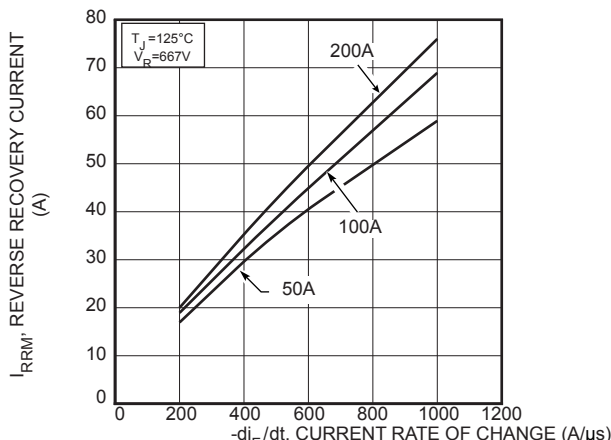

Figure 5. Reverse Recovery Current vs. Current Rate of Change

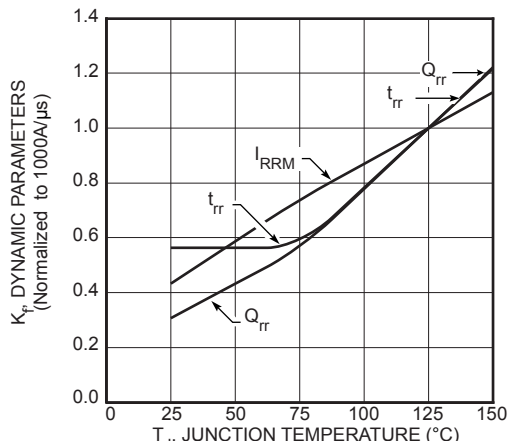

Figure 6. Dynamic Parameters vs. Junction Temperature

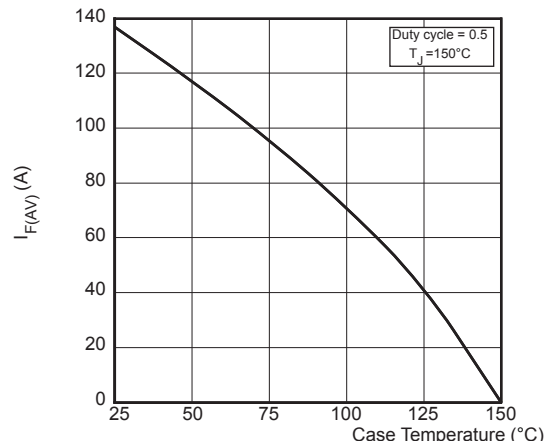

Figure 7. Maximum Average Forward Current vs. Case Temperature

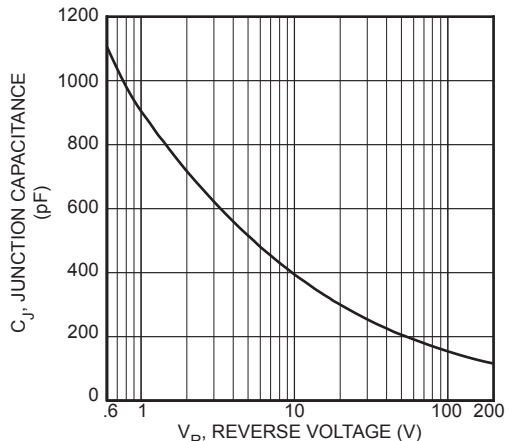

Figure 8. Junction Capacitance vs. Reverse Voltage

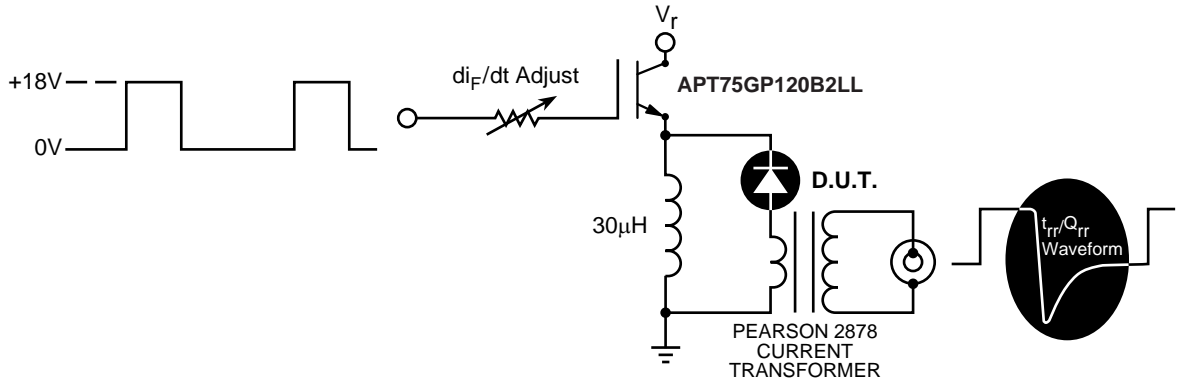

Figure 9. Diode Test Circuit

- 1  $I_F$  - Forward Conduction Current
- 2  $di_F/dt$  - Rate of Diode Current Change Through Zero Crossing.
- 3  $I_{RRM}$  - Maximum Reverse Recovery Current.
- 4  $t_{rr}$  - Reverse Recovery Time, measured from zero crossing where diode current goes from positive to negative, to the point at which the straight line through  $I_{RRM}$  and  $0.25 \cdot I_{RRM}$  passes through zero.
- 5  $Q_{rr}$  - Area Under the Curve Defined by  $I_{RRM}$  and  $t_{rr}$ .

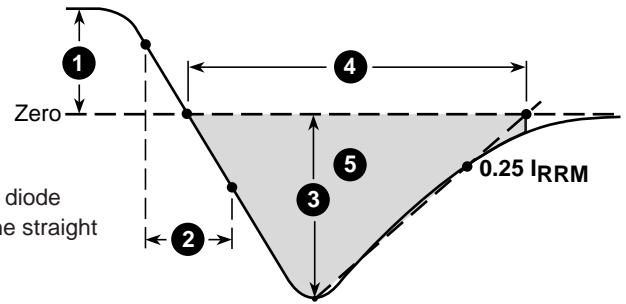

Figure 10, Diode Reverse Recovery Waveform and Definitions

SOT-227 (ISOTOP®) Package Outline

