

Dimensions

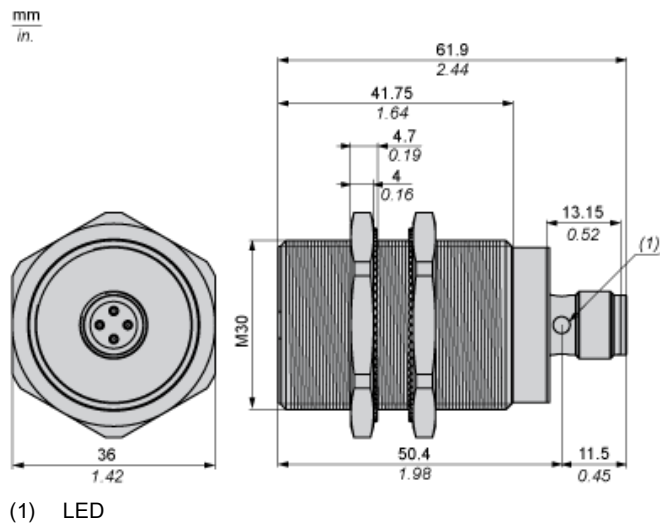

Minimum Mounting Distances

Side by side



e (1) 30 mm/1.18 in.

≥

Face to face



e (2) 180 mm/7.09 in.

≥

Facing a metal object



e (3) 45 mm/1.77 in.

≥