

# » User Guide «

## **CP-HDD-S-KIT**

**2.5" SATA HDD/SSD  
Carrier Sub-Assembly,  
Single/Dual Carrier Boards  
with Special Backplanes  
for 3U Systems**

Doc. ID:1027-5348, Rev. 2.0  
January 28, 2011



## Revision History

<b>Publication Title:</b>		CP-HDD-S-KIT: 2.5" SATA HDD/SSD Carrier Sub-Assembly, Single/Dual Carrier Boards with Special Backplanes for 3U Systems
<b>Doc. ID:</b>		1027-5348
Rev.	Brief Description of Changes	Date of Issue
1.0	Initial issue	19-Dec-2008
2.0	Updated to include single slot backplane and revised dual backplane and carrier board, plus new cabling	28-Jan-2011

## Imprint

Kontron Modular Computers GmbH may be contacted via the following:

### MAILING ADDRESS

Kontron Modular Computers GmbH  
Sudetenstraße 7  
D - 87600 Kaufbeuren Germany

### TELEPHONE AND E-MAIL

+49 (0) 800-SALESKONTRON  
sales@kontron.com

For information about other  
Kontron products, please  
visit our Internet web site:

[www.kontron.com](http://www.kontron.com)

## Disclaimer

Copyright © 2008 - 2011 Kontron AG. All rights reserved. All data is for information purposes only and not guaranteed for legal purposes. Information has been carefully checked and is believed to be accurate; however, no responsibility is assumed for inaccuracies. Kontron and the Kontron logo and all other trademarks or registered trademarks are the property of their respective owners and are recognized. Specifications are subject to change without notice.



## Table of Contents

<i>Revision History</i> .....	<i>ii</i>
<i>Imprint</i> .....	<i>ii</i>
<i>Disclaimer</i> .....	<i>ii</i>
<i>Table of Contents</i> .....	<i>iii</i>
<i>List of Tables</i> .....	<i>v</i>
<i>List of Figures</i> .....	<i>vii</i>
<i>Proprietary Note</i> .....	<i>ix</i>
<i>Trademarks</i> .....	<i>ix</i>
<i>Environmental Protection Statement</i> .....	<i>ix</i>
<i>Explanation of Symbols</i> .....	<i>x</i>
<i>For Your Safety</i> .....	<i>xi</i>
<i>High Voltage Safety Instructions</i> .....	<i>xi</i>
<i>Special Handling and Unpacking Instructions</i> .....	<i>xi</i>
<i>General Instructions on Usage</i> .....	<i>xii</i>
<i>Two Year Warranty</i> .....	<i>xiii</i>
<b>1. Introduction</b> .....	<b>1 - 3</b>
1.1 Overview .....	1 - 3
1.2 Components .....	1 - 4
1.3 Technical Specification .....	1 - 6
1.4 Standards .....	1 - 7
1.5 Related Publications .....	1 - 8
<b>2. Component Description</b> .....	<b>2 - 3</b>
2.1 CP-HDD-S Carrier Board .....	2 - 3
2.1.1 General .....	2 - 3
2.1.2 Connector J1 - Backplane .....	2 - 5
2.2 Backplane .....	2 - 6
2.3 Connector J4 of Kit Single Backplane and External Cable .....	2 - 11
2.4 Connector J4 of Kit Dual Backplane and External Cable .....	2 - 12
2.5 SATA Cables .....	2 - 13
2.6 Guide Rails .....	2 - 13
2.7 CP-HDD-S Carrier Board Dual LED Front Panel .....	2 - 14



---

<b>3. Installation</b> .....	<b>3 - 3</b>
3.1 General .....	3 - 3
3.2 Safety .....	3 - 5
3.3 Implementation Considerations .....	3 - 6
3.3.1 Cooling .....	3 - 6
3.3.2 Grounding .....	3 - 6
3.3.3 Mounting .....	3 - 6
3.3.4 CP-HDD-S-KIT Assembly .....	3 - 6
3.3.5 Hot-Plugging .....	3 - 6
3.4 CP-HDD-S-KIT Initial Installation Procedures .....	3 - 7
3.5 CP-HDD-S Carrier Board Replacement Procedures .....	3 - 9





## List of Tables

1-1	<i>CP-HDD-S-KIT Sub-Assembly Specifications</i> .....	1 - 6
1-2	<i>Standards</i> .....	1 - 7
1-3	<i>Related Publications</i> .....	1 - 8
2-1	<i>Connector J1 Pinout</i> .....	2 - 5
2-2	<i>Connector J1 Signal Description</i> .....	2 - 6
2-3	<i>Single Backplane Connector J4 Pinout</i> .....	2 - 11
2-4	<i>Dual Backplane Connector J4 Pinout</i> .....	2 - 12
3-1	<i>CP-HDD-S-KIT - Single Backplane Configuration</i> .....	3 - 3
3-2	<i>CP-HDD-S-KIT - Dual Backplane Configuration</i> .....	3 - 4



This page has been intentionally left blank.





## List of Figures

1-1	<i>CP-HDD-S-KIT Dual Slot Backplane Functional Block Diagram</i> .....	1 - 3
1-2	<i>CP-HDD-S-KIT Single Slot Backplane Functional Block Diagram</i> .....	1 - 4
1-3	<i>CP-HDD-S-KIT (Dual Slot) - Perspective View</i> .....	1 - 5
2-1	<i>CP-HDD-S Carrier Board - Front View</i> .....	2 - 3
2-2	<i>CP-HDD-S Carrier Board - Rear View</i> .....	2 - 4
2-3	<i>CP-HDD-S Carrier Board With HDD Mounted</i> .....	2 - 4
2-4	<i>CP-HDD-S-KIT Dual Backplane - Front View</i> .....	2 - 7
2-5	<i>CP-HDD-S-KIT Dual Backplane - Rear View</i> .....	2 - 8
2-6	<i>CP-HDD-S-KIT Single Backplane - Front View</i> .....	2 - 9
2-7	<i>CP-HDD-S-KIT Single Backplane - Rear View</i> .....	2 - 10
2-8	<i>Single Backplane J4 Connector</i> .....	2 - 11
2-9	<i>Single Backplane External Cable</i> .....	2 - 11
2-10	<i>Dual Backplane J4 Connector</i> .....	2 - 12
2-11	<i>Dual Backplane External Cable (Optional)</i> .....	2 - 12
2-12	<i>CP-HDD-S-KIT SATA Cables</i> .....	2 - 13
2-13	<i>CP-HDD-S-KIT SATA Cable - View of Locking Clip</i> .....	2 - 13
2-14	<i>CP-HDD-S-KIT Guide Rail Pair</i> .....	2 - 13
2-15	<i>Dual LED Front Panel Layout</i> .....	2 - 14



This page has been intentionally left blank.







---

## **Proprietary Note**

This document contains information proprietary to Kontron. It may not be copied or transmitted by any means, disclosed to others, or stored in any retrieval system or media without the prior written consent of Kontron or one of its authorized agents.

The information contained in this document is, to the best of our knowledge, entirely correct. However, Kontron cannot accept liability for any inaccuracies or the consequences thereof, or for any liability arising from the use or application of any circuit, product, or example shown in this document.

Kontron reserves the right to change, modify, or improve this document or the product described herein, as seen fit by Kontron without further notice.

## **Trademarks**

This document may include names, company logos and trademarks, which are registered trademarks and, therefore, proprietary to their respective owners.

## **Environmental Protection Statement**

This product has been manufactured to satisfy environmental protection requirements where possible. Many of the components used (structural parts, printed circuit boards, connectors, batteries, etc.) are capable of being recycled.

Final disposition of this product after its service life must be accomplished in accordance with applicable country, state, or local laws or regulations.



## Explanation of Symbols



### ***Caution, Electric Shock!***

This symbol and title warn of hazards due to electrical shocks (> 60V) when touching products or parts of them. Failure to observe the precautions indicated and/or prescribed by the law may endanger your life/health and/or result in damage to your material.

Please refer also to the section “High Voltage Safety Instructions” on the following page.



### ***Warning, ESD Sensitive Device!***

This symbol and title inform that electronic boards and their components are sensitive to static electricity. Therefore, care must be taken during all handling operations and inspections of this product, in order to ensure product integrity at all times.

Please read also the section “Special Handling and Unpacking Instructions” on the following page.



### ***Warning!***

This symbol and title emphasize points which, if not fully understood and taken into consideration by the reader, may endanger your health and/or result in damage to your material.



### ***Note ...***

This symbol and title emphasize aspects the reader should read through carefully for his or her own advantage.



## For Your Safety

Your new Kontron product was developed and tested carefully to provide all features necessary to ensure its compliance with electrical safety requirements. It was also designed for a long fault-free life. However, the life expectancy of your product can be drastically reduced by improper treatment during unpacking and installation. Therefore, in the interest of your own safety and of the correct operation of your new Kontron product, you are requested to conform with the following guidelines.

### High Voltage Safety Instructions



#### ***Warning!***

All operations on this device must be carried out by sufficiently skilled personnel only.



#### ***Caution, Electric Shock!***

Before installing your new Kontron product into a system always ensure that your mains power is switched off. This applies also to the installation of piggybacks.

Serious electrical shock hazards can exist during all installation, repair and maintenance operations with this product. Therefore, always unplug the power cable and any other cables which provide external voltages before performing work.

### Special Handling and Unpacking Instructions



#### ***ESD Sensitive Device!***

Electronic boards and their components are sensitive to static electricity. Therefore, care must be taken during all handling operations and inspections of this product, in order to ensure product integrity at all times.

Do not handle this product out of its protective enclosure while it is not used for operational purposes unless it is otherwise protected.

Whenever possible, unpack or pack this product only at EOS/ESD safe work stations. Where a safe work station is not guaranteed, it is important for the user to be electrically discharged before touching the product with his/her hands or tools. This is most easily done by touching a metal part of your system housing.

It is particularly important to observe standard anti-static precautions when changing piggybacks, ROM devices, jumper settings etc. If the product contains batteries for RTC or memory backup, ensure that the board is not placed on conductive surfaces, including anti-static plastics or sponges. They can cause short circuits and damage the batteries or conductive circuits on the board.



## General Instructions on Usage

In order to maintain Kontron's product warranty, this product must not be altered or modified in any way. Changes or modifications to the device, which are not explicitly approved by Kontron and described in this manual or received from Kontron's Technical Support as a special handling instruction, will void your warranty.

This device should only be installed in or connected to systems that fulfill all necessary technical and specific environmental requirements. This applies also to the operational temperature range of the specific board version, which must not be exceeded. If batteries are present, their temperature restrictions must be taken into account.

In performing all necessary installation and application operations, please follow only the instructions supplied by the present manual.

Keep all the original packaging material for future storage or warranty shipments. If it is necessary to store or ship the board, please re-pack it as nearly as possible in the manner in which it was delivered.

Special care is necessary when handling or unpacking the product. Please consult the special handling and unpacking instruction on the previous page of this manual.



## Two Year Warranty

Kontron grants the original purchaser of Kontron's products a ***TWO YEAR LIMITED HARDWARE WARRANTY*** as described in the following. However, no other warranties that may be granted or implied by anyone on behalf of Kontron are valid unless the consumer has the express written consent of Kontron.

Kontron warrants their own products, excluding software, to be free from manufacturing and material defects for a period of 24 consecutive months from the date of purchase. This warranty is not transferable nor extendible to cover any other users or long-term storage of the product. It does not cover products which have been modified, altered or repaired by any other party than Kontron or their authorized agents. Furthermore, any product which has been, or is suspected of being damaged as a result of negligence, improper use, incorrect handling, servicing or maintenance, or which has been damaged as a result of excessive current/voltage or temperature, or which has had its serial number(s), any other markings or parts thereof altered, defaced or removed will also be excluded from this warranty.

If the customer's eligibility for warranty has not been voided, in the event of any claim, he may return the product at the earliest possible convenience to the original place of purchase, together with a copy of the original document of purchase, a full description of the application the product is used on and a description of the defect. Pack the product in such a way as to ensure safe transportation (see our safety instructions).

Kontron provides for repair or replacement of any part, assembly or sub-assembly at their own discretion, or to refund the original cost of purchase, if appropriate. In the event of repair, refunding or replacement of any part, the ownership of the removed or replaced parts reverts to Kontron, and the remaining part of the original guarantee, or any new guarantee to cover the repaired or replaced items, will be transferred to cover the new or repaired items. Any extensions to the original guarantee are considered gestures of goodwill, and will be defined in the "Repair Report" issued by Kontron with the repaired or replaced item.

Kontron will not accept liability for any further claims resulting directly or indirectly from any warranty claim, other than the above specified repair, replacement or refunding. In particular, all claims for damage to any system or process in which the product was employed, or any loss incurred as a result of the product not functioning at any given time, are excluded. The extent of Kontron liability to the customer shall not exceed the original purchase price of the item for which the claim exists.

Kontron issues no warranty or representation, either explicit or implicit, with respect to its products' reliability, fitness, quality, marketability or ability to fulfil any particular application or purpose. As a result, the products are sold "as is," and the responsibility to ensure their suitability for any given task remains that of the purchaser. In no event will Kontron be liable for direct, indirect or consequential damages resulting from the use of our hardware or software products, or documentation, even if Kontron were advised of the possibility of such claims prior to the purchase of the product or during any period since the date of its purchase.

Please remember that no Kontron employee, dealer or agent is authorized to make any modification or addition to the above specified terms, either verbally or in any other form, written or electronically transmitted, without the company's consent.



This page has been intentionally left blank.





---

*Chapter*

---

**1**

---

# Introduction

---



This page has been intentionally left blank.







# 1. Introduction

## 1.1 Overview

The CP-HDD-S-KIT is a specially designed sub-assembly which provides the capability to add either one or two 2.5" SATA HDDs or SSDs to a CPCI system with SATA interfacing. It is comprised of one or two 3U CPCI-format carrier boards, a special single or dual slot backplane, one or two SATA interfacing cables, and a special 5-wire cable for power input and LED signals for the single slot backplane. Each carrier board accommodates one HDD/SSD. The special backplanes provide interfacing for drive power and host SATA signals for up to two carrier boards. Designed for more rugged environments, each carrier board is mounted on an aluminum frame assembly which provides excellent mechanical, shock and vibration stability.

The following figures illustrate the functional concept of the CP-HDD-S-KIT.

**Figure 1-1: CP-HDD-S-KIT Dual Slot Backplane Functional Block Diagram**

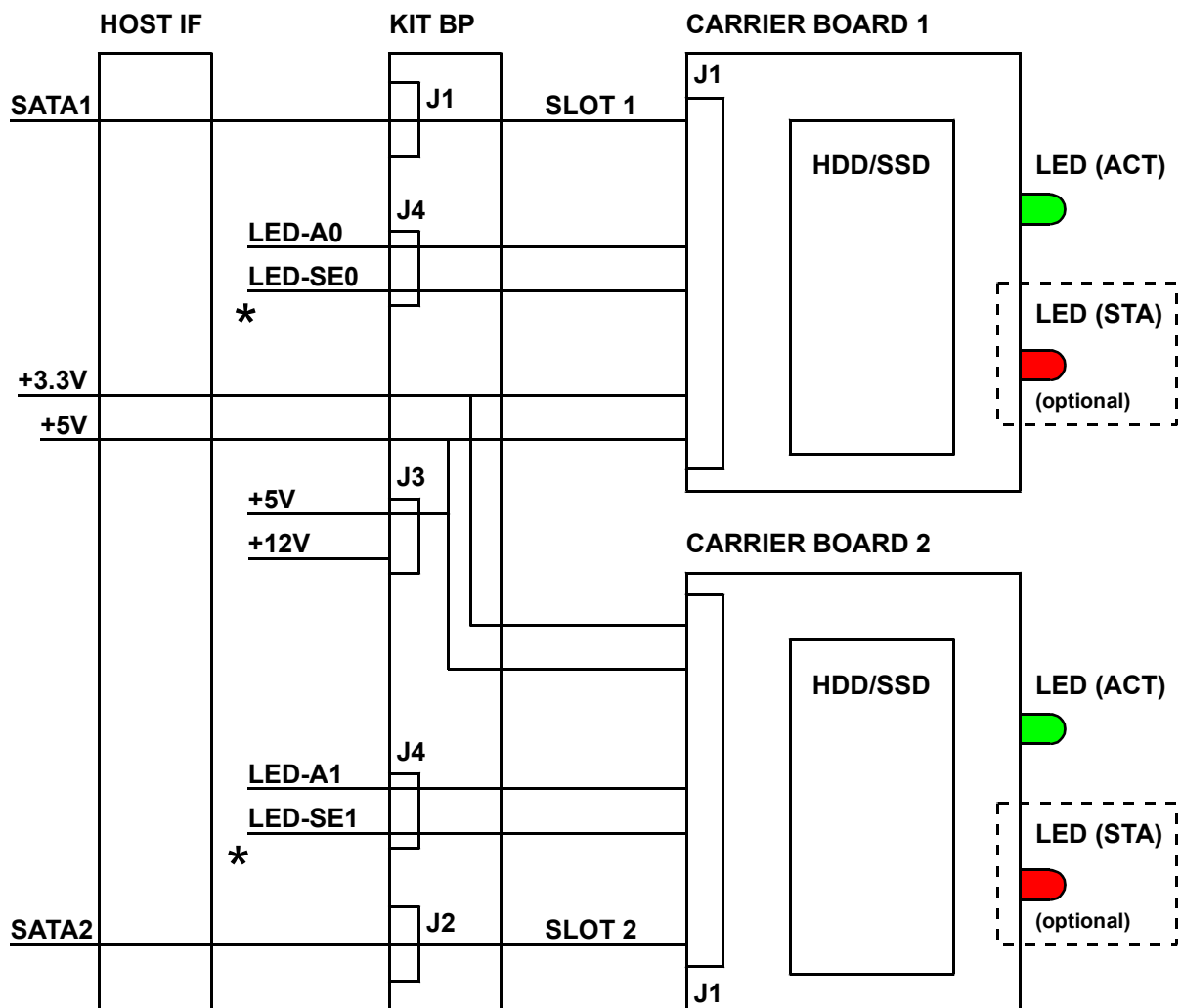

\* These are optional LED input signals which require implementation of appropriate external interfacing in order to be used.



Figure 1-2: CP-HDD-S-KIT Single Slot Backplane Functional Block Diagram

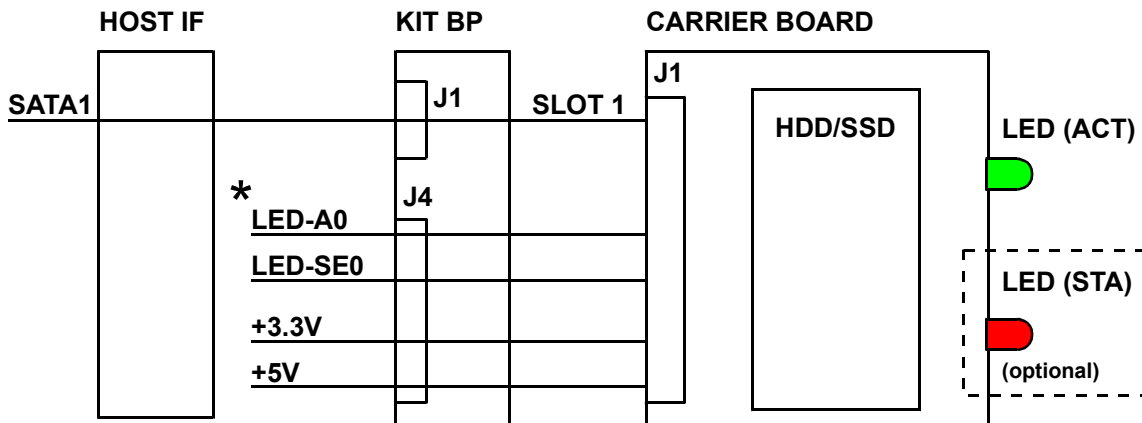

\* These are optional LED input signals which require implementation of appropriate external interfacing in order to be used.

Input power to the KIT dual backplane can either be supplied via the standard backplane type power terminal lugs or via connector J3. Terminal lugs are provided for the case that the power bus is extended further in the system chassis to provide mechanical support for the bus bars. If input power is supplied via J3 on the KIT dual backplane, only the +5V is used. In this case there is no +3.3V power available for the carrier boards.

The host side SATA interface to the KIT backplanes is done with standard SATA cables and the onboard SATA connectors J1 and J2. J1 SATA signals are routed to slot 1 (x1), and J2 SATA signals are routed to slot 2 (x2). The SATA cables may either be connected to the host directly, to a rear transition module (RTM), or the host backplane if appropriate interfacing there is available.

In the case of the KIT single backplane, power is provided via connector J4. A special 5-wire cable is provided with this KIT version for power and LED signals.

The KIT backplane itself uses standard horizontal pitch (HP) for rack mounting. However, the carrier connector is offset (both horizontally and vertically) to accommodate the carrier board and does not conform to the CPCI standard. The carrier boards themselves are CPCI form factor compliant (3U, 4HP) with the exception of the backplane connector placement.

## 1.2 Components

The CP-HDD-S-KIT is comprised of the following elements:

- One or two HDD/SSD carrier boards (without HDD/SSD mounted)
- Special one or two slot 3U backplanes (with guide pins)
- One or two standard SATA cables
- Two or four chassis guide rails (two for each carrier board)
- A special 5-wire cable for the single backplane for input power and LED signals
- Optionally, for the dual slot backplane, a special 5-wire cable for LED signals

The following figure illustrates the CP-HDD-S-KIT (with HDDs mounted), configured with the KIT dual slot backplane, four guide rails, and two 50 cm SATA cables.





Figure 1-3: CP-HDD-S-KIT (Dual Slot) - Perspective View

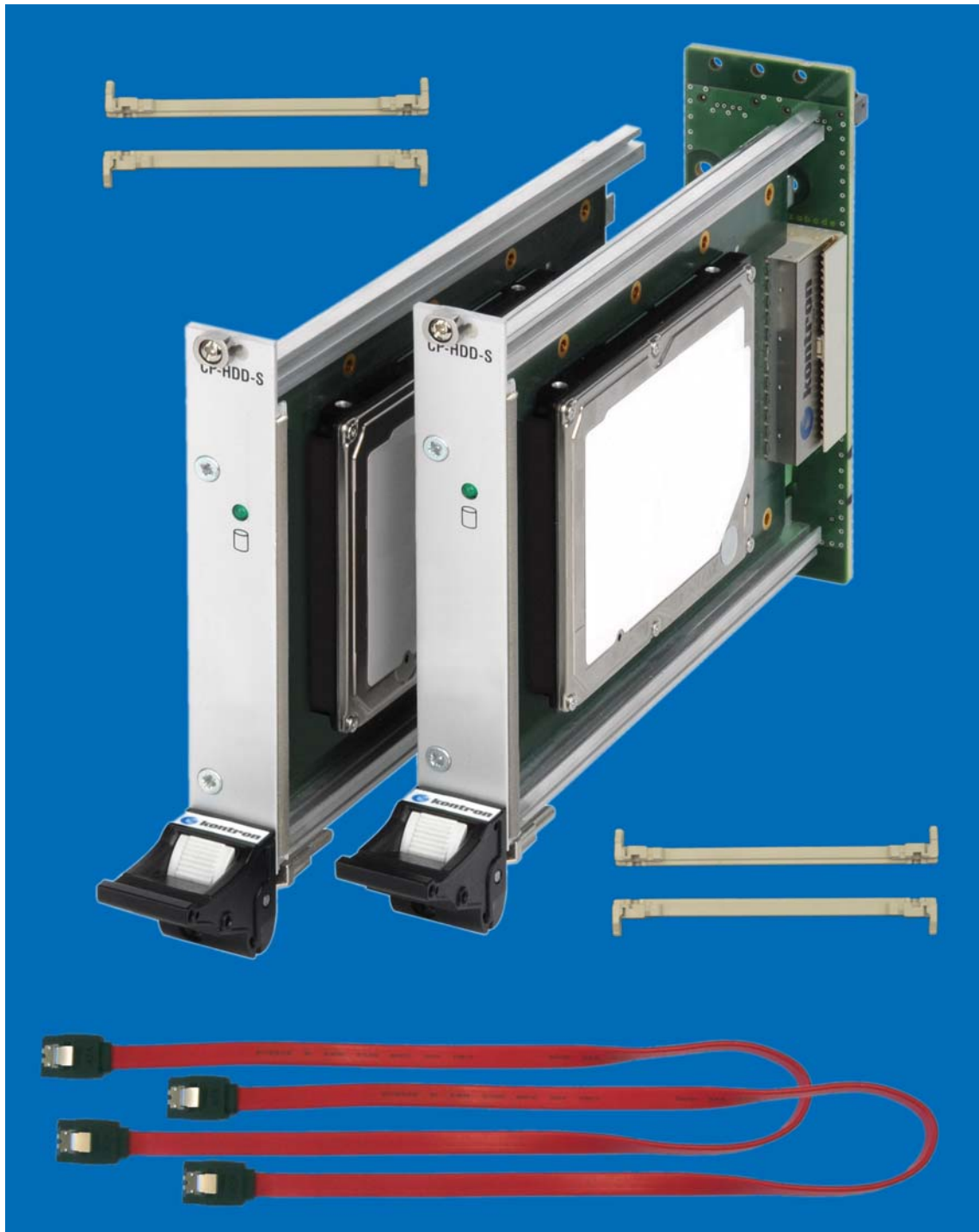

## 1.3 Technical Specification

**Table 1-1: CP-HDD-S-KIT Sub-Assembly Specifications**

FEATURES	SPECIFICATIONS
Carrier Board	<p>HDD/SSD carrier board designed for use with CPCI systems:</p> <ul style="list-style-type: none"> <li>• Form factor: 3U, 4HP</li> <li>• Supports one 2.5" SATA-I/II HDD or SSD (HDD/SSD must be ordered separately)</li> <li>• Maximum data transfer rate: SATA-II</li> <li>• Hot-pluggable; can be used to create a RAID system</li> <li>• Special aluminum profile frame for mounting carrier PCB, HDD/SSD, and front-panel</li> <li>• Standard 2.5" SATA HDD/SSD onboard drive connector (7S/12P)</li> <li>• Single CPCI-style rear connector; custom pinout; horizontal and vertical offset</li> <li>• Single green LED to indicate HDD/SSD activity</li> <li>• Optional red LED to indicate operational status of HDD/SSD (requires external input)</li> <li>• +3.3V and +5V power routing on HDD/SSD connector (no +12V routing)</li> <li>• Power consumption: depends on HDD/SSD installed (typ. +5V: 5 watt)</li> <li>• Temperature Ranges: Carrier Board with HDD mounted               <ul style="list-style-type: none"> <li>• Operating: +5°C to +55°C -25°C to +75°C (extended - E1x)</li> <li>• Storage: -40°C to +65°C</li> </ul> <p>The above values are typical for HDDs and may vary depending on the HDD manufacturer's specifications.</p> </li> <li>• Temperature Ranges: Carrier Board with SSD mounted               <ul style="list-style-type: none"> <li>• Operating: 0°C to +70°C (commercial grade device) -40°C to +85°C (enhanced - E2) -25°C to +75°C (extended - E1x)</li> <li>• Storage: -55°C to +95°C</li> </ul> <p>The above values are typical for SSDs and may vary depending on the SSD manufacturer's specifications.</p> </li> <li>• Dimensions: carrier frame w/o frontpanel: 171.0 mm x 111.5 mm carrier PCB: 162.5 mm x 95.0 mm</li> <li>• Weight: ca. 200 g (without HDD/SSD)</li> </ul>
Backplanes	<p>Specially designed 4 and 8HP backplane modules to support one or two HDD/SSD carrier boards:</p> <ul style="list-style-type: none"> <li>• Form factor: 3U, 4HP single slot, 8HP dual slot</li> <li>• Slot geometry (front, left side of the backplane): slot 1: supports SATA channel interfacing from rear connector J1 slot 2: supports SATA channel interfacing from rear connector J2</li> <li>• One or two CPCI-type (J1) front connectors (x1 and x2) with customized pinout</li> <li>• One or two standard SATA interface rear connectors (J1 and J2)</li> <li>• Input power distribution:               <ul style="list-style-type: none"> <li>• Bus-bar terminal lugs for: GND, +5V, +3.3V</li> <li>• Molex connector (J3, 4-pin) for: GND, +5V, +12V (+12V is not routed in the backplane itself)</li> </ul> </li> <li>• Two or four special metal guide pins which provide additional mounting stability for the carrier frames</li> <li>• Temperature Ranges:               <ul style="list-style-type: none"> <li>• Operating: -40°C to +85°C</li> <li>• Storage: -40°C to +85°C</li> </ul> </li> <li>• Dimensions: 129.0 mm x 20.0 mm (4HP) or 40.0mm (8HP)</li> <li>• Weight: ca. 31 g single slot; 69 g dual slot</li> </ul>

**Table 1-1: CP-HDD-S-KIT Sub-Assembly Specifications (Continued)**

FEATURES	SPECIFICATIONS
SATA cable	Standard SATA cable, 50 cm length, with connector locking clips; one or two cables pro KIT
Guide rails	CPCI compliant guide rails without coding blocks
Dual slot IF cable (LED inputs)	Optional, keyed blue 5-pin connector with 5-wires colored, ca. 50 cm length
Single slot IF cable (LED inputs and power)	Standard, keyed black 5-pin connector with 5-wires colored, ca. 50 cm length

### 1.4 Standards

This Kontron CP-HDD-S-KIT complies with the requirements of the following standards.

**Table 1-2: Standards**

COMPLIANCE	TYPE	STANDARD	TEST LEVEL
CE	Emission	EN55022, EN61000-6-3	--
	Immission	EN55024, EN61000-6-2	--
	Electrical Safety	EN60950-1	--
Environmental	Vibration (Sinusoidal)	IEC60068-2-6	10 - 58 Hz: ± 0,075 mm amplitude 58 - 500 Hz: 1g / 3 axis / 1x
	Shock	IEC60068-2-27	15g/11ms/18/5s peak acceleration / shock duration half sine / number of shocks / recovery time
	Climatic Humidity	IEC60068-2-78	93% RH at 40°C, non-condensing <b>(see note below)</b>
	WEEE	Directive 2002/96/EC	Waste electrical and electronic equipment
	RoHS	Directive 2002/95/EC	Restriction of the use of certain hazardous substances in electrical and electronic equipment



**Note ...**

Kontron performs comprehensive environmental testing of its products in accordance with applicable standards.

Customers desiring to perform further environmental testing of Kontron products must contact Kontron for assistance prior to performing any such testing. This is necessary, as it is possible that environmental testing can be destructive when not performed in accordance with the applicable specifications.

In particular, for example, boards **without conformal coating** must not be exposed to a change of temperature exceeding 1K/minute, averaged over a period of not more than five minutes. Otherwise, condensation may cause irreversible damage, especially when the board is powered up again.

Kontron does not accept any responsibility for damage to products resulting from destructive environmental testing.



## 1.5 Related Publications

The following publications contain information relating to this product.

**Table 1-3: Related Publications**

PRODUCT	PUBLICATION
CompactPCI Systems and Boards	CompactPCI Specification 2.0, Rev. 3.0
	Kontron's CompactPCI System Manual, ID 19954
Serial ATA	Serial ATA 2.0 Specification
All Kontron products	Product Safety and Implementation Guide, ID 1021-9142



*Chapter*

**2**

---

# Component Description

---



This page has been intentionally left blank.





## 2. Component Description

### 2.1 CP-HDD-S Carrier Board

#### 2.1.1 General

Specially designed for high shock and vibration environments, the CP-HDD-S carrier board provides a unique aluminum frame for mounting of a carrier PCB with a single HDD or SSD drive as well as a standard 3U CPCI front panel. The carrier PCB provides interfacing for the HDD/SSD and the backplane for power, SATA signalling, and when available LED signal inputs. In addition, there are provisions for up to two front panel LED indicators. One green front panel LED is available which is used to indicate HDD/SSD activity. An optional red LED is available to indicate the operational status of the HDD/SSD.

The following figures illustrate the mechanical design of the CP-HDD-S carrier board.

**Figure 2-1: CP-HDD-S Carrier Board - Front View**

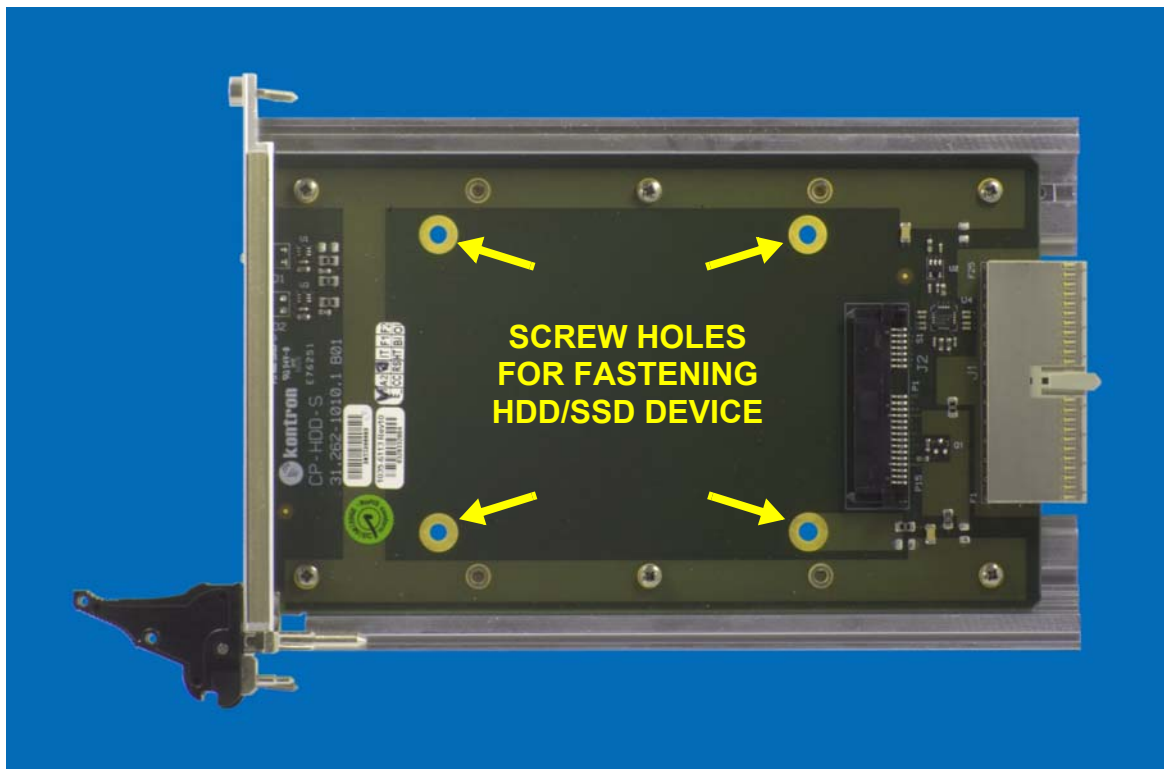



Figure 2-2: CP-HDD-S Carrier Board - Rear View



Figure 2-3: CP-HDD-S Carrier Board With HDD Mounted



### 2.1.2 Connector J1 - Backplane

This is a standard CPCI-J1 connector (25-pin, zabcdef columns, without keying for VIO).

The following tables provide pinout and signal information for this connector.

**Table 2-1: Connector J1 Pinout**

PIN	ROW Z	ROW A	ROW B	ROW C	ROW D	ROW E	ROW F
25	NC	NC	NC	GND	GND	GND	GND
24	NC	NC	NC	GND	GND	SATA <sub>n</sub> _A+	GND
23	NC	NC	NC	GND	GND	SATA <sub>n</sub> _A-	GND
22	NC	NC	NC	GND	GND	GND	GND
21	NC	NC	NC	GND	GND	SATA <sub>n</sub> _B+	GND
20	NC	NC	NC	GND	GND	SATA <sub>n</sub> _B-	GND
19	NC	NC	NC	GND	GND	GND	GND
18	NC	NC	NC	GND	GND	GND	GND
17	NC	NC	NC	GND	GND	GND	GND
16	NC	NC	NC	GND	GND	GND	GND
15	NC	NC	NC	GND	GND	GND	GND
12-14	Key Area						
11	NC	3.3V	3.3V	NC	NC	NC	GND
10	NC	3.3V	3.3V	NC	NC	NC	GND
9	NC	3.3V	3.3V	NC	NC	NC	GND
8	NC	3.3V	3.3V	NC	NC	NC	GND
7	NC	3.3V	3.3V	NC	NC	NC	GND
6	NC	5V	5V	NC	NC	NC	GND
5	NC	5V	5V	NC	NC	NC	GND
4	NC	5V	5V	NC	NC	NC	GND
3	NC	5V	5V	NC	NC	NC	GND
2	NC	5V	5V	NC	NC	NC	GND
1	NC	LED-A <sub>n</sub>	LED-SE <sub>n</sub>	NC	NC	NC	GND

**Table 2-2: Connector J1 Signal Description**

SIGNAL	DESCRIPTION
5V	+5V supply voltage from power supply unit
3.3V	+3.3V supply voltage from power supply unit
GND	Signal ground
SATAn_A+/A-	SATA transmit pair (differential 100 Ohm) driven by CPU
SATAn_B+/B-	SATA receive pair (differential 100 Ohm) driven by HDD/SSD
LED-An	Activity LED for SATA channel n (Is external input signal. If not connected, HDD/SSD device provides input to LED-An.)
LED-SEn	Status LED for SATA channel n (Is external input signal. If not connected and red LED is available, LED remains off)

## 2.2 Backplane

The CP-HDD-S-KIT backplanes are special designs which although they fit the CPCI 3U/4-8HP format raster, they are not CPCI compliant backplanes. The placement of the front connectors is offset to accommodate the carrier boards and the connector pinouts allow only for HDD/SSD drive input power, the SATA signals, and if available the LED input signals.

On the rear side of the backplane are up to two standard SATA connectors (J1 and J2) with cable locking shrouds, power input terminals (CPCI style and raster for GND, +3.3V, +5V), and in the case of the dual slot backplane, a MOLEX PC-type drive power connector for +5V.

The +5V power and GND input from the MOLEX connector J3 are routed in the backplane to the +5V and GND power terminal lugs respectively. The +12V power is not connected anywhere in the backplane.

The single slot backplane only has provision for +5V input power via J4.

For enhanced mechanical stability (shock and vibration), up to four metal guide pins are installed in the backplane to provide additional physical support for the carrier boards. These guide pins are installed at the factory to ensure proper alignment with the carrier boards.

The following figures illustrate the basic layout of the CP-HDD-S-KIT backplanes.



Figure 2-4: CP-HDD-S-KIT Dual Backplane - Front View

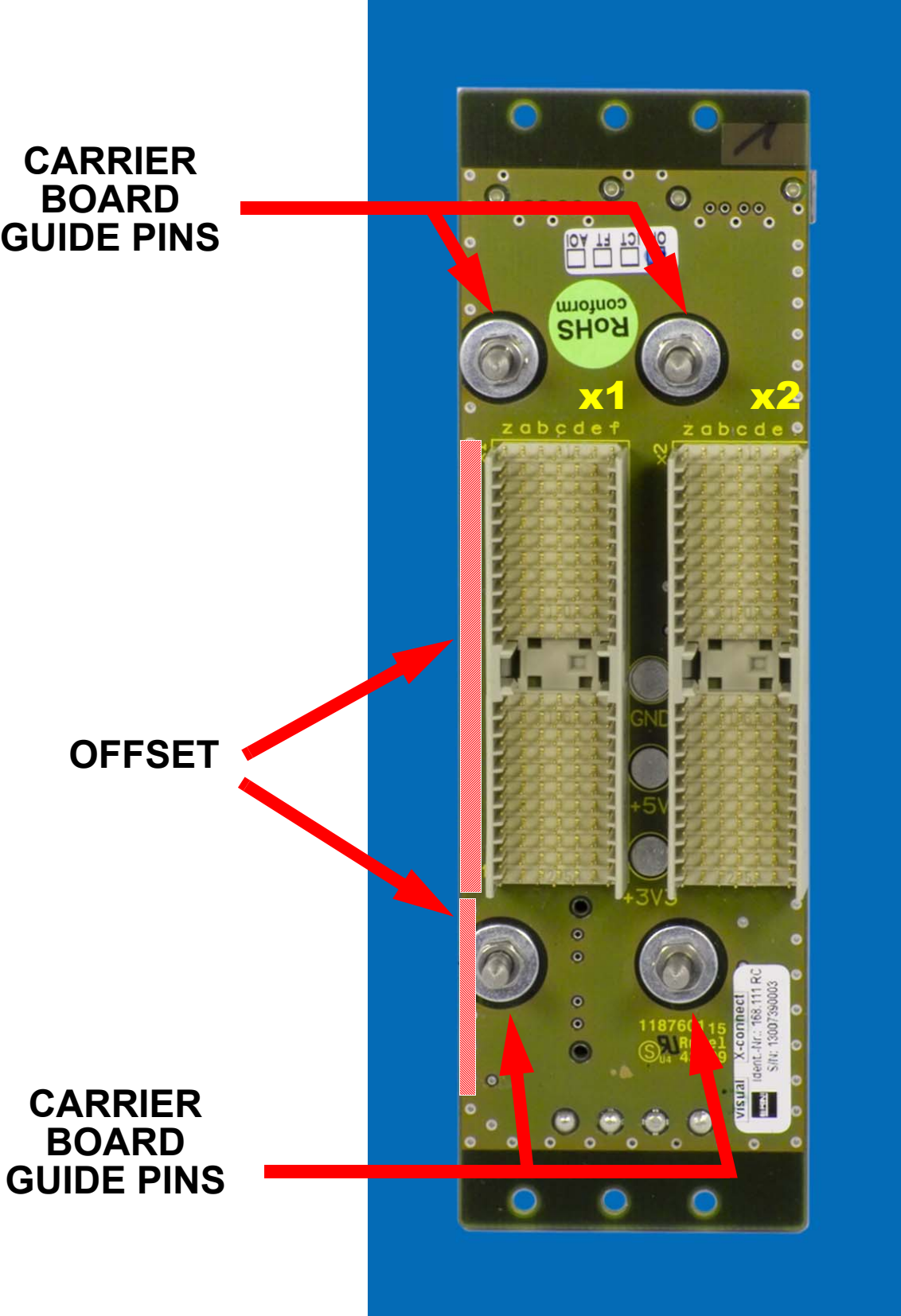

Figure 2-5: CP-HDD-S-KIT Dual Backplane - Rear View

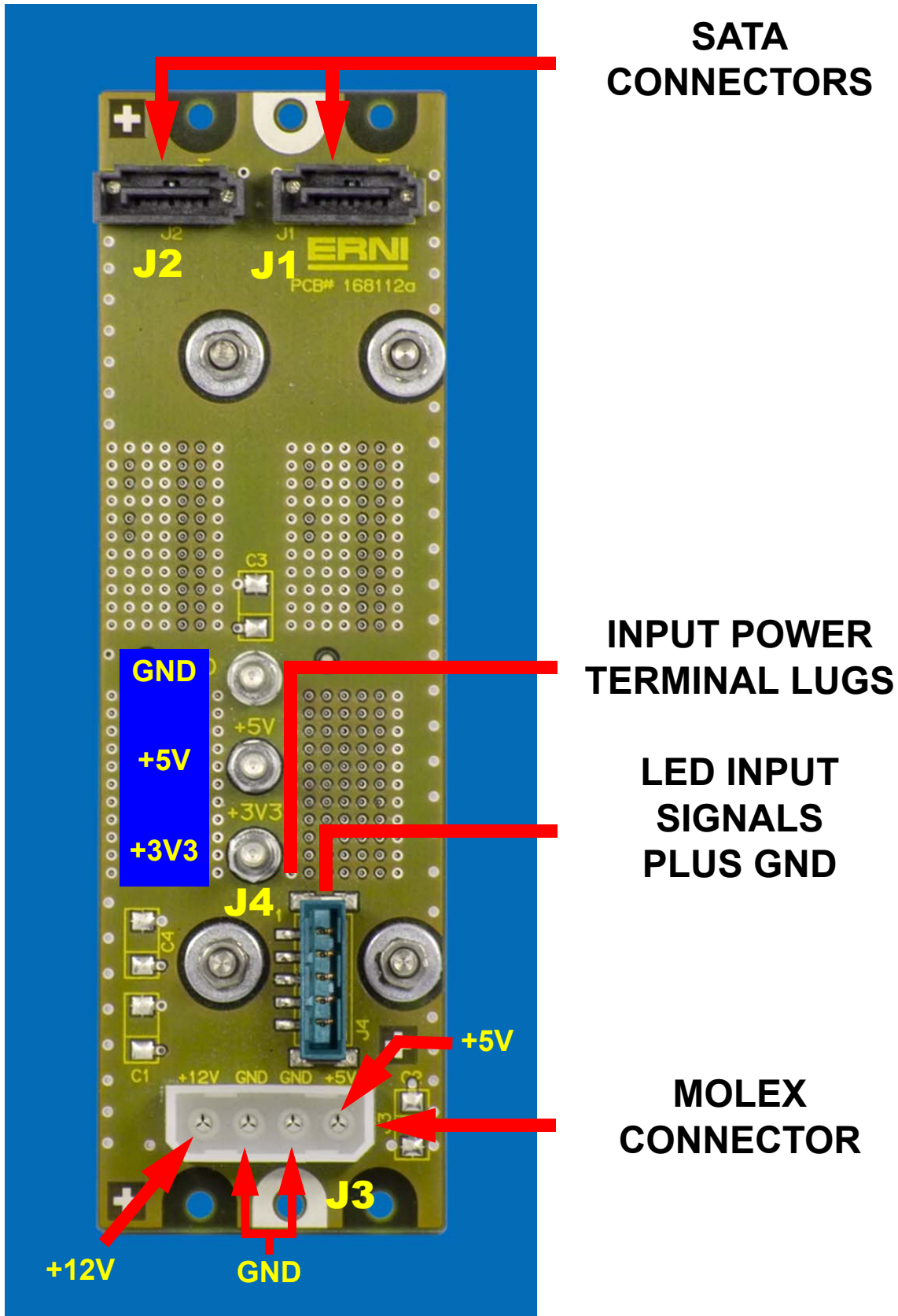





Figure 2-6: CP-HDD-S-KIT Single Backplane - Front View

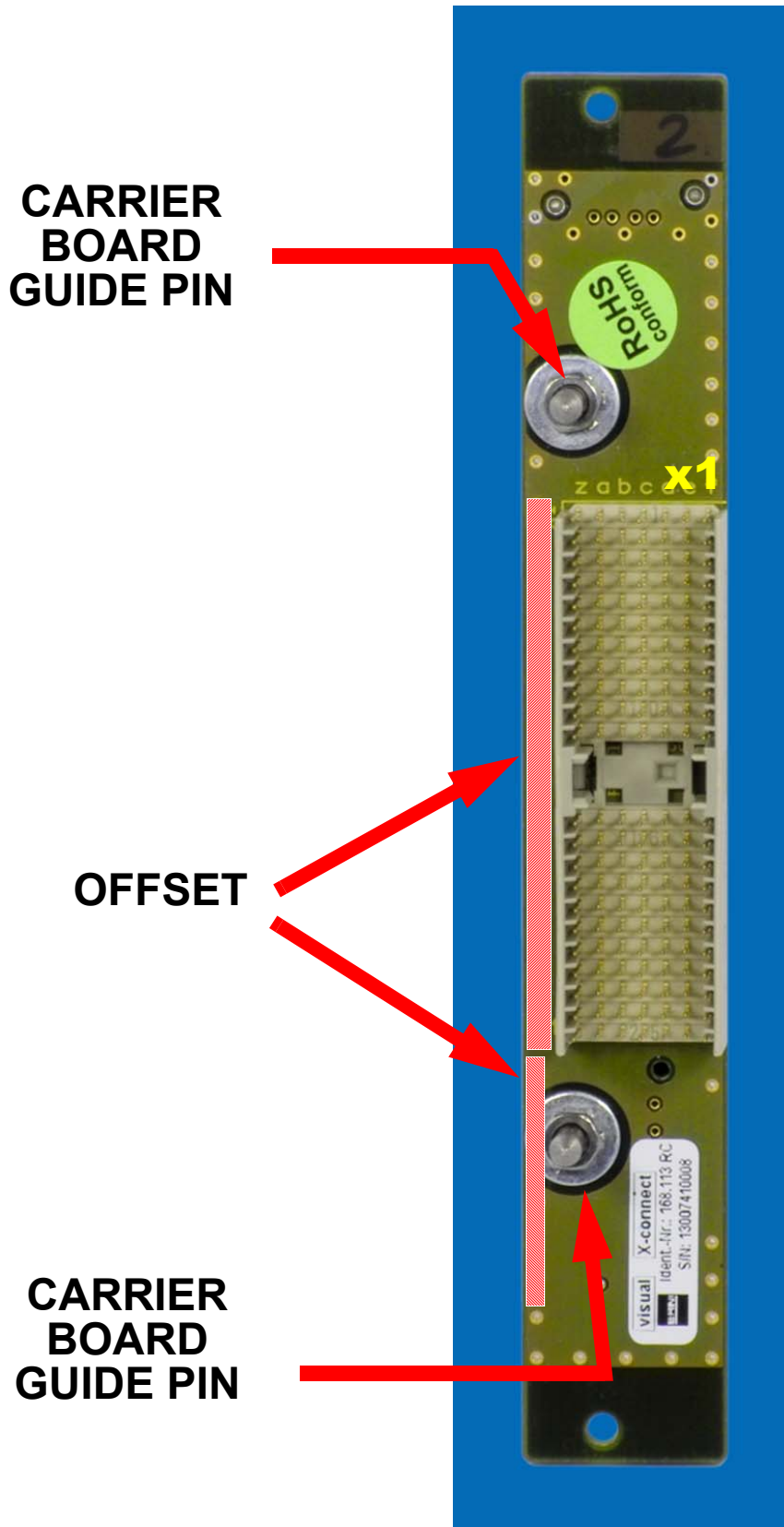
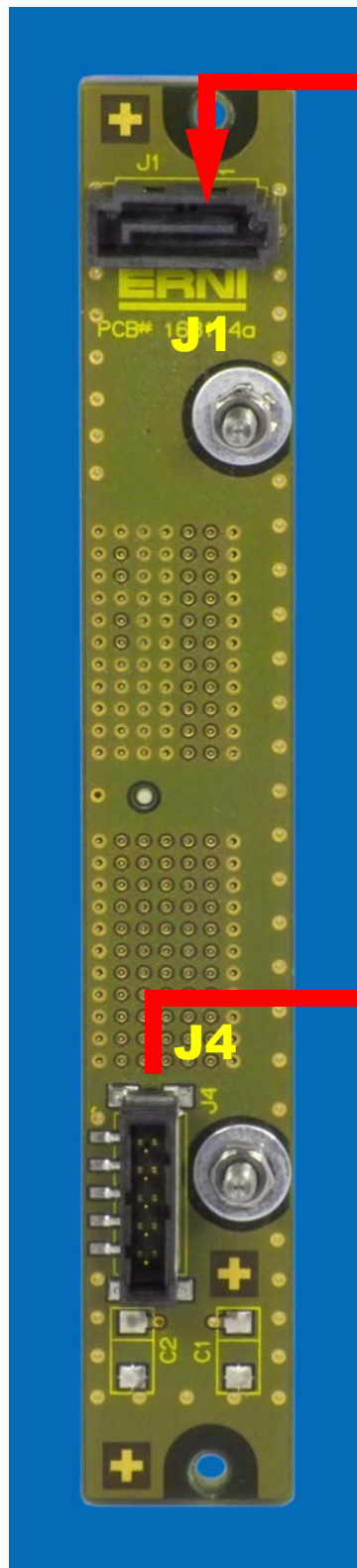

Figure 2-7: CP-HDD-S-KIT Single Backplane - Rear View



**SATA  
CONNECTOR**

**LED INPUT  
SIGNALS  
PLUS GND  
AND +5V**





### 2.3 Connector J4 of Kit Single Backplane and External Cable

This connector and associated external cable provides interfacing for +5V input power and LED operational status input signals. The following figures and table provide connector pinout and cabling information.

**Figure 2-8: Single Backplane J4 Connector**

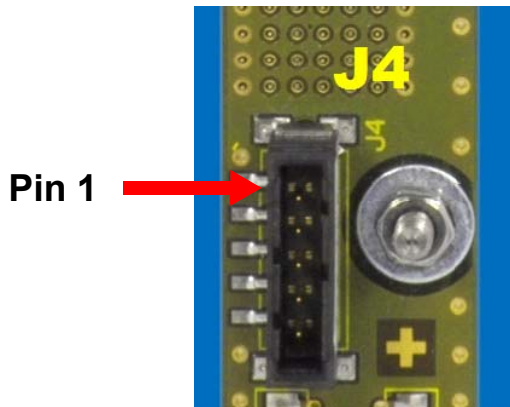

**Table 2-3: Single Backplane Connector J4 Pinout**

SIGNAL	DESCRIPTION
1	Activity LED input for SATA channel n
2	Status LED input for SATA channel n
3	Ground
4	+5V input voltage from power supply unit
5	+3.3V input voltage from power supply unit

**Figure 2-9: Single Backplane External Cable**

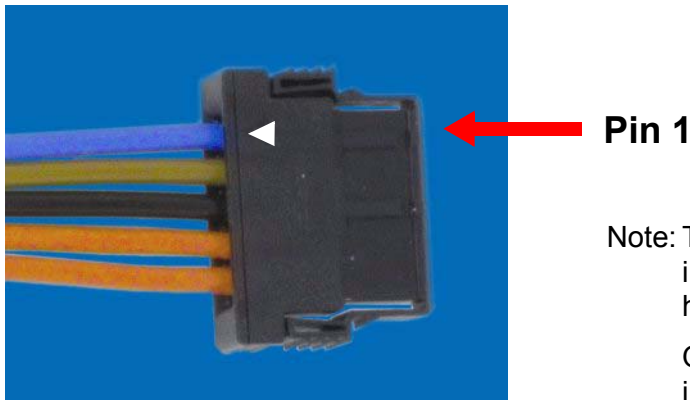

Note: This connector is keyed and cannot be installed improperly. The triangle shown here indicates the pin 1 position.

On the connector itself there is a triangle in the molding indicating pin 1.



## 2.4 Connector J4 of Kit Dual Backplane and External Cable

This connector and associated external cable provides interfacing for the LED operational status input signals for the two SATA channels. The following figures and table provide connector pinout and cabling information.

**Figure 2-10: Dual Backplane J4 Connector**

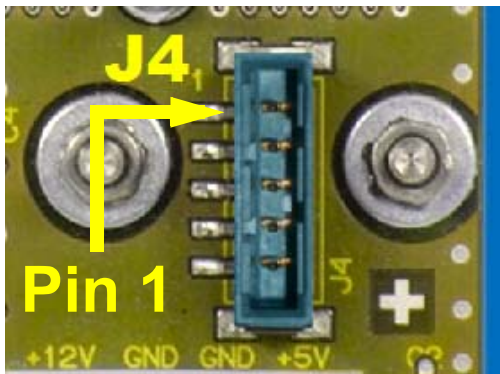

**Table 2-4: Dual Backplane Connector J4 Pinout**

SIGNAL	DESCRIPTION
1	Activity LED input for SATA channel connected to J1
2	Status LED input for SATA channel connected to J1
3	Ground
4	Activity LED input for SATA channel connected to J2
5	Status LED input for SATA channel connected to J2

**Figure 2-11: Dual Backplane External Cable (Optional)**

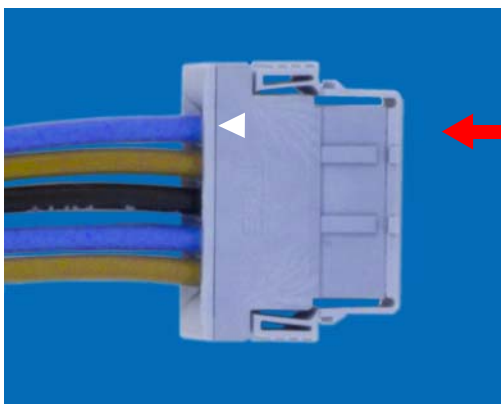

Note: This connector is keyed and cannot be installed improperly. The triangle shown here indicates the pin 1 position.

On the connector itself there is a triangle in the molding indicating pin 1.





## 2.5 SATA Cables

The CP-HDD-S-KIT is supplied with one or two, 50 cm length, standard SATA cables. These cables have a locking clip on their connectors which ensures that they remain connected when installed.

The following figures show the cables and the locking clip.

**Figure 2-12: CP-HDD-S-KIT SATA Cables**

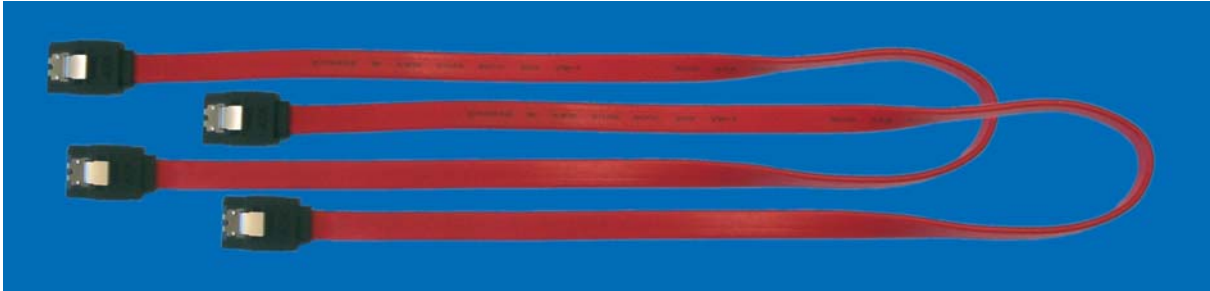

**Figure 2-13: CP-HDD-S-KIT SATA Cable - View of Locking Clip**



## 2.6 Guide Rails

The CP-HDD-S-KIT is supplied with two or four guide rails (without coding blocks) for mounting the carrier boards in a chassis. Each board requires two rails for mounting.

The following figure shows a guide rail pair for one carrier board.

**Figure 2-14: CP-HDD-S-KIT Guide Rail Pair**

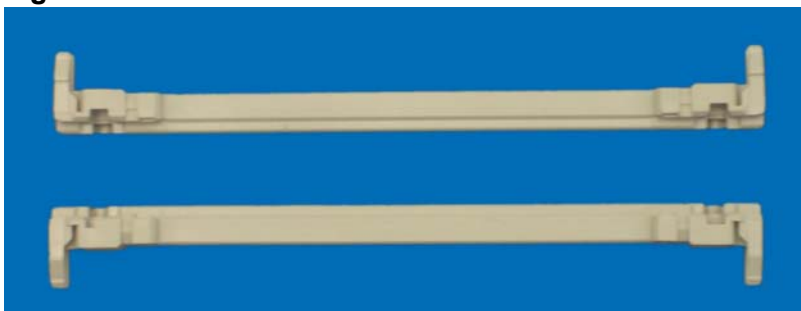



## 2.7 CP-HDD-S Carrier Board Dual LED Front Panel

The **CP-HDD-S** carrier board is optionally available with two LEDs on the front panel of the HDD/SSD carrier board. The second LED (red) provides the capability to indicate the operational status of the HDD/SSD device on the carrier board or the mass storage system itself.

The control input signal for this LED must be provided from an external source via the J4 connector on rear side of the backplane. The figure below indicates the layout of the dual LED front panel.

**Figure 2-15: Dual LED Front Panel Layout**

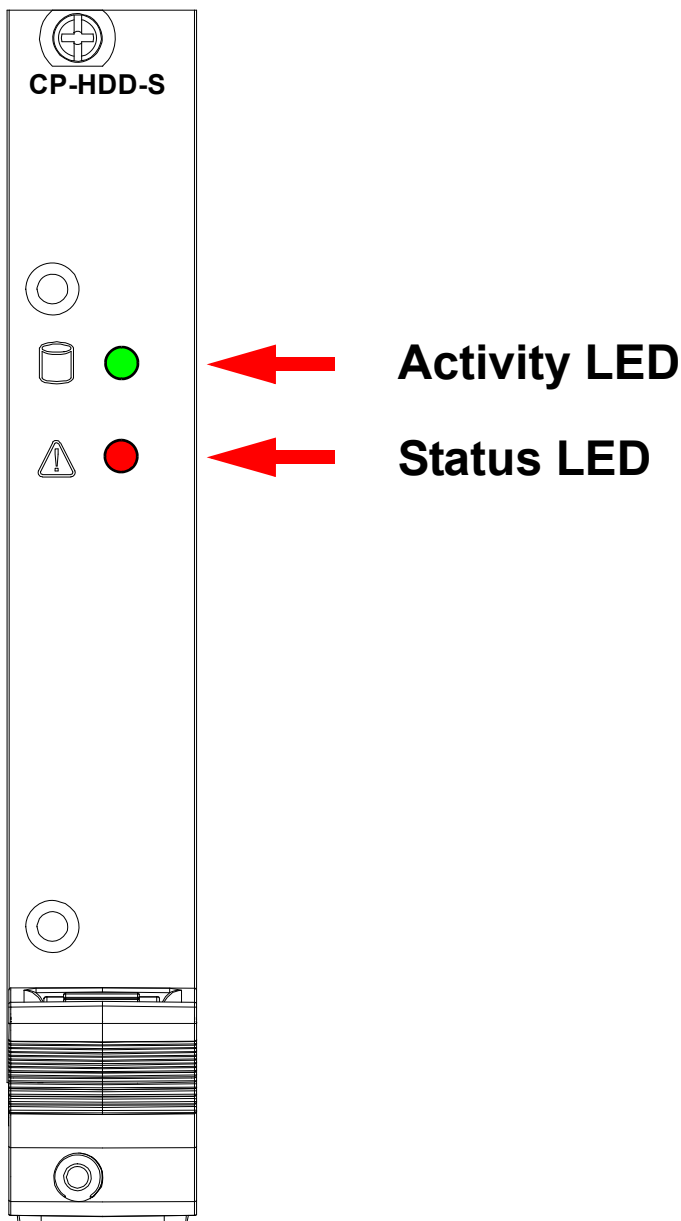



*Chapter* **3**

---

# Installation

---



This page has been intentionally left blank.





## 3. Installation

### 3.1 General

The CP-HDD-S-KIT provides an excellent basis for implementing 3U mass storage sub-systems. With its one or two slot backplanes, it is suitable for practically any CPCI mass storage configuration including RAID systems.

Basically the KIT is provided without HDD/SSD devices. The customer has the choice of ordering such devices at the time the KIT is ordered and have Kontron install them or the customer may install their own HDD/SSDs at a later time as required.

The KIT comes in one of two configurations: with a single slot backplane and one carrier board or with a dual slot backplane and two carrier boards. Additional hardware is provided accordingly for mounting and supplying power to the backplane.

The following tables provide the hardware configuration of the two KIT versions.

**Table 3-1: CP-HDD-S-KIT - Single Backplane Configuration**

ITEM	QTY	ARTICLE
1	1	Carrier board: single LED front panel, aluminum frame, carrier PCB
2	1	Backplane: single slot, one SATA connector, one input power connector, two guide pins
3	2	Screw: M2.5, 10mm; for backplane mounting
4	4	Screw: M3, 5mm; for HDD/SSD device mounting
5	2	Guide rail: CPCI-compliant, no coding blocks; for carrier mounting in chassis
6	1	Cable: standard SATA, locking clips on both end connectors
7	1	Cable: keyed 5-pin black connector with pre-confectioned colored wiring, 5-wires, 50 cm long
8	1	Optional: Harddisk drive or Solid-state drive: 2.5" SATA-I or II; capacity and type: customer specified (Only one device per carrier board; must be ordered separately, not in price of KIT)
9	1	Optional: Carrier board: dual LED front panel, aluminum frame, carrier PCB (Must be specified at time KIT is ordered.)

**Table 3-2: CP-HDD-S-KIT - Dual Backplane Configuration**

ITEM	QTY	ARTICLE
1	2	Carrier board: single LED front panel, aluminum frame, carrier PCB
2	1	Backplane: dual slot, two SATA connectors, three input power terminals (GND, 3.3V, 5V), one Molex input power connector, one LED operational status input connector, four guide pins
3	6	Screw: M2.5, 10mm; for backplane mounting
4	8	Screw: M3, 5mm; for HDD/SSD device mounting
5	4	Guide rail: CPCI-compliant, no coding blocks; for carrier mounting in chassis
6	2	Cable: standard SATA, locking clips on both end connectors
7	1	Optional: Cable: keyed 5-pin blue connector with pre-confectioned colored wiring, 5-wires, 50 cm long
8	1	Optional: Harddisk drive or Solid-state drive: 2.5" SATA-I or II; capacity and type: customer specified (Only one device per carrier board; must be ordered separately, not in price of KIT)
9	1	Optional: Carrier board: dual LED front panel, aluminum frame, carrier PCB (Must be specified at time KIT is ordered.)

Assembly of the backplane in the system chassis and the installation of the carrier boards (including all required hardware: guide rails, cable installation, etc.) is the responsibility of the system implementer.





## 3.2 Safety

The following precautions must be observed.



### ***Caution, Electric Shock Hazard!***

Installation of the CP-HDD-S-KIT backplane requires access to the interior of the system chassis in which it is to be installed. Therefore it is mandatory that all power be removed from the chassis before beginning installation.

**All input power cables must be disconnected**, it is not enough to just turn off power.

Failure to comply with the above could endanger your life or health and may cause damage to the CP-HDD-S-KIT or other system components including process-side signal conditioning equipment.



### ***ESD Equipment!***

The CP-HDD-S-KIT contains electrostatic sensitive devices. Ensure that the following precautions are observed to avoid damaging the CP-HDD-S-KIT:

Discharge clothing before touching the assembly. Tools must also be discharged before use.

Do not touch any board components, connector pins, or board conductive circuits.

If working at an anti-static workbench with professional discharging equipment, ensure compliance with its usage when handling this product.



### ***Note ...***

Personnel performing the installation of the CP-HDD-S-KIT backplane must be experienced in such operations. Inexperienced personnel must not attempt to perform the backplane installation due to the risk of damage to the backplane front connector(s).



### 3.3 Implementation Considerations

#### 3.3.1 Cooling

The maximum operational temperature of the CP-HDD-S-KIT is a function of the temperature of the installed HDD/SSD device and not necessarily the ambient air temperature of the system. Each HDD/SSD has its own specified operating temperature which is usually that measured at the middle of the drive side of the assembly. As this is specified by the drive manufacturer, it is imperative that the implementer consult the drive documentation to ascertain the drive's requirement.

How this relates to a specific application depends on the system's configuration and environment. Most applications will require some form of forced-air convection cooling which takes into consideration that the aluminum frame is not a heat sink/spreader. In any event, the implementer is responsible for providing adequate cooling of the CP-HDD-S-KIT.



#### **Warning!**

Failure to comply with the above can result in improper operation or damage to the CP-HDD-S-KIT HDD/SSDs.

Kontron rejects any and all liability for damage resulting from inadequate cooling of the CP-HDD-S-KIT HDD/SSDs.

#### 3.3.2 Grounding

The design of the CP-HDD-S-KIT is such that the metal housing (device enclosure) of an installed HDD/SSD does not make contact with the system chassis via the aluminum frame and front panel contact.

#### 3.3.3 Mounting

The CP-HDD-S-KIT is designed to be mounted in a 3U, 4HP or 8HP chassis slot depending on the KIT version. The allowable orientation of the chassis is a function of the installed HDD/SSD. In most cases, these devices may be operated in any orientation. Refer to the device manufacturer's documentation for specific information.

#### 3.3.4 CP-HDD-S-KIT Assembly

With the exception of the HDD/SSD device, the CP-HDD-S carrier board and the backplane guide pins must be assembled at the factory. This is necessary to ensure proper alignment with the backplane connectors. Except for the installation or replacement of a HDD/SSD device, neither the carrier board nor the backplane are field serviceable.

The backplane itself is a field assembly item which requires special assembly procedures which are provided in chapter 3.4. Compliance with the procedures set forth in this chapter is mandatory to avoid damage to the backplane connector pins

#### 3.3.5 Hot-Plugging

Basically the HDDs/SSDs as SATA devices are "hot-pluggable" meaning they can be inserted or removed from a system with power applied to the drive device. Hot-Plugging is, however, not necessarily the same as hot-swapping.





Implementations requiring hot-plugging or hot-swapping must be specified accordingly to ensure proper operation. It is the responsibility of the implementer to ensure that system functionality is available to support the required operation.

The CP-HDD-S-KIT carrier board is not compliant with the CPCI specification for hot swapping. There is no handle switch nor is there a blue “Hot-Swap” LED available on the board’s front panel. In addition, it has no connections to the CPCI bus on the system’s backplane. Therefore, if hot-swapping is required, the application must provide by other means the functionality required to support hot-swapping and take into consideration that replacement of a HDD/SSD containing the currently used operating system will not function (exception: RAID systems).

As hot-plugging and hot-swapping are application dependent, procedures for performing these functions are not provided as part of this user guide.

Please contact Kontron for further assistance regarding hot-swap capability and required functionality.

### 3.4 CP-HDD-S-KIT Initial Installation Procedures

This procedure applies to both versions of the CP-HDD-S-KIT. It covers the initial installation of the backplane, the SATA cable(s), carrier board(s) and where applicable the installation of the power input cable for the single slot backplane.

To perform the installation of the CP-HDD-S-KIT in a system proceed as follows:

1. Ensure that the safety requirements indicated Chapter 3.2 are observed.



#### **Warning!**

Failure to comply with the above could endanger your life or health and may cause damage to the CP-HDD-S-KIT or other system components including process-side signal conditioning equipment.

2. Ensure that both the front and the rear interior areas of the system chassis are freely accessible. Remove any chassis covers, front plates, or other system elements that may be obstructing access to the front slots or the rear area of the chassis where the backplane is to be installed.
3. Ensure that the chassis guide rails (top and bottom) for the CP-HDD-S carrier boards are installed properly in the slots where the carrier boards are to be installed.
4. Install the backplane as follows:

First position the backplane at the slot position where it is to be installed. Then install all of the M2.5 backplane mounting screws supplied with the CP-HDD-S-KIT but do not tighten them completely. They must have some play as to allow the backplane front connector(s) and guide pins to be aligned properly with the carrier board connector(s) and the carrier board frame.

**Warning!**

When performing the next step, if the carrier board(s) are properly aligned with the backplane connector(s) and the guide pins, the carrier board(s) should be able to be inserted with a relative minimum amount of force.

If this is not case, then the situation must be resolved before proceeding. Refer to step 6 for further assistance.

Kontron rejects any and all liability for damage resulting from improper assembly of the CP-HDD-S-KIT.

5. Install the carrier board(s) as follows:

Insert each board carefully in its designated slot until it makes contact with its respective backplane connector. Ensure that each board is properly aligned with its respective backplane connector. Now seat each board in its backplane connector using the board's ejector handle. Fasten each carrier board's retaining screws.

If for whatever reason it is not possible to seat a carrier board properly, proceed with step 6, otherwise proceed with step 7.

6. Remedial measures for improper seating of (a) carrier board(s):

1. Ensure that both the backplane and the carrier board guide rails are installed at the correct location within the chassis subrack. Repeat step 5 as required, or continue with the next step.
  2. Ensure that the carrier board backplane connector is properly aligned with the backplane connector. If the connectors are properly aligned proceed with the next step, otherwise loosen the backplane mounting screws a little bit more and repeat step 5.
  3. As required, loosen both of the backplane guide pins for the slot in question and repeat step 5, otherwise continue with the next step.
  4. If none of the above remedial measures were successful, contact Kontron Support for further assistance.
7. Using a torque screwdriver set to 0.500 Nm, fasten all of the backplane's mounting screws.
8. As required, using a torque nut driver (5.5 mm) set to 0.800 Nm, fasten all of the backplane's guide pins that were loosened during installation.
9. Install all SATA cables according to system specifications ensuring that all of the cable locking clips are properly engaged.

Accomplishment of this step assumes that host side connectors (host, RTM, or host backplane) are available. Route and fix the cables within the chassis as specified for the system.

If the SATA host side cable ends are not connected at this time, it must be assured that prior to system operation that the cables are connected. It is the responsibility of the system integrator to ensure a properly connected system.

10. Install power connections and as required the LED connections to the backplane:

Requirements for accomplishment of this step are a function of the system as well as the installed HDDs or SSDs.



Refer to the system and HDD/SSD device documentation for further information on the type of power connections required. Proceed according to the requirements specified. Refer also to chapter 2 for information regarding possible types of power connections to the backplane.

11. Installation of the CP-HDD-S-KIT: backplane, carrier board(s) (with HDD/SSD), and cables is now completed. Assuming that all required cables and power connections have been installed the CP-HDD-S-KIT with HDD/SSDs is now ready for operation.

Any chassis covers, front plates, or other elements that were removed to allow access to the front and rear chassis areas may now be reinstalled as required.

### 3.5 CP-HDD-S Carrier Board Replacement Procedures

The following procedures apply for a standard replacement of the CP-HDD-S carrier board. To replace the carrier board proceed as follows:

1. Ensure that the safety requirements indicated in Chapter 3.2 are observed.



#### **Warning!**

Care must be taken when applying the procedures below to ensure that neither the carrier board nor system boards are physically damaged by the application of these procedures.

2. Ensure that no power is applied to the system before proceeding.
3. Unscrew the front panel retaining screws.
4. Disengage the board from the backplane by first unlocking the board ejection handle and then by pressing the handle as required until the board is disengaged.
5. After disengaging the board from the backplane, pull the board out of the slot.
6. Dispose of the “old” board as required observing the safety requirements indicated in Chapter 3.2.
7. Obtain the replacement CP-HDD-S-KIT board.



#### **Warning!**

When performing the next step, **DO NOT** push the board into the backplane connector. Use the ejector handle to seat the board into the backplane connector.

8. Carefully insert the “new” board into the “old” board slot until it makes contact with the backplane connector.
9. Using the ejector handle, engage the board with the backplane. When the ejector handle is locked, the board is engaged.
10. Fasten the front panel retaining screws. Replacement of the carrier board is now completed.



This page has been intentionally left blank.

