

MOVIDRIVE[®] *compact* MCF41A

Operating Instructions

Edition 01/2000



02531AXX



SEW EURODRIVE

0919 911X / 012000



	Page
1 Important Notes	4
2 Safety Notes	6
3 Installation	7
3.1 Unit designation, nameplates and scope of supply	7
3.2 Unit design, size 1	8
3.3 Unit design, size 2	9
3.4 Unit design, size 3	10
3.5 Unit design, sizes 4 and 5 (MCF41A0370...0750):	11
3.6 Installation instructions for basic unit	12
3.7 Installation instructions for PROFIBUS-DP interface	14
3.8 EMC-compliant installation	17
3.9 UL-compliant installation	18
3.10 Power shield clamp	19
3.11 Touch guard	20
3.12 Diagram of connections, basic unit	21
3.13 Removing the terminal unit	24
3.14 Assignment of braking resistors, chokes, filters	25
3.15 System bus (SBus) connection	28
3.16 Connection option USS21A (RS-232 and RS-485)	29
4 Startup	30
4.1 General startup instructions	30
4.2 Preliminary work and tools	31
4.3 Startup with the DBG11A keypad	32
4.4 Startup with a PC and MX_SHELL	36
4.5 Startup with PC and MOVITOOLS (from version 2.20)	38
4.6 PROFIBUS-DP startup	39
4.7 Manual mode	40
4.8 Parameter list.....	41
4.9 Configuring the PROFIBUS-DP interface	47
4.10 External diagnosis.....	49
4.11 Slave diagnostic data	50
4.12 Identity number	51
4.13 Control via PROFIBUS-DP	52
4.14 Parameter setting via PROFIBUS-DP	55
4.15 Return codes for parameterization.....	58
4.16 Reading and writing parameters with PROFIBUS-DP	61
5 Operation and Service	64
5.1 Operating displays	64
5.2 Fault information	69
5.3 List of faults	70
5.4 PROFIBUS-DP fault diagnosis	72
5.5 SEW electronics service	74
6 Technical Data	75
6.1 General technical data	75
6.2 MCF41A....-2_3 (230 V units)	76
6.3 MCF41A....-5_3 (400/500 V units)	78
6.4 Electronics data	83
7 Index	84
Service and spare parts	86



Important Notes

Safety and warning instructions / Designated use

1 Important Notes

Safety and warning instructions

Always follow the safety and warning instructions contained in this publication!



Electrical hazard

Possible consequences: Severe or fatal injuries.



Hazard

Possible consequences: Severe or fatal injuries.



Hazardous situation

Possible consequences: Slight or minor injuries.



Harmful situation

Possible consequences: Damage to the unit and the environment.



Tips and useful information



A requirement of fault-free operation and fulfillment of any rights to claim under guarantee is that the information in the **operating instructions** is adhered to. Consequently, **read the operating instructions** before you start working with the unit!

The **operating instructions** contain **important information about servicing**; as a result, they should be kept **in the vicinity of the unit**.

Designated use:

MOVIDRIVE[®] compact MCF41A drive inverters are units for industrial systems in which asynchronous AC motors with squirrel-cage rotors are operated. These motors must be suitable for operation with frequency inverters. No other loads may be connected to the units.



MOVIDRIVE[®] compact MCF41A drive inverters are units intended for stationary installation in switch cabinets. Comply with all information in the technical data and the permitted conditions where the unit is operated.

Do not start up the unit (take it into operation in the designated fashion) until you have established that the machine complies with the EMC Directive 89/336/EEC and that the conformity of the end product has been determined in accordance with the Machinery Directive 89/392/EEC (with reference to EN 60204).



The following uses are forbidden unless measures are expressly taken to make them possible:

- Use in explosion-proof areas
- Use in areas exposed to harmful oils, acids, gases, vapors, dust, radiation, etc.
- Use in non-stationary applications which are subject to mechanical vibration and shock loads in excess of the requirements in EN 50178.
- Use in applications in which the inverter undertakes independent safety functions (without master safety systems) for ensuring the safety of machinery and people.

Waste disposal



Please follow the current instructions:

Dispose in accordance with the material structure and the regulations in force, e.g. as: electronic scrap (printed-circuit boards), plastic (housing), sheet metal, copper, etc.

PROFIBUS-DP

Please also follow the instructions in the “MOVIDRIVE® Drive Inverter – Fieldbus Unit Profile with List of Parameters” manual which can be ordered from SEW under publication number 0919 1607. This manual contains important information about project planning and about operating fieldbus systems. It describes how the MOVIDRIVE® drive inverter behaves when it is linked into a higher-level automation system.

MOVIDRIVE® *compact* MCF41A units operated as slaves are compliant with the PROFIBUS-DP standard EN 50170. Consequently, the inverter can be controlled and have its parameters set by means of an automation system. Transmission rates of 9.6 kbaud to 12 Mbaud are supported (automatic detection of baud rate).

The GSD diskette is supplied for project planning for the DP master. The SEW_6002.GSD file must be copied into a special folder for your project planning software. Please refer to the manuals of your project planning software for information about the precise procedures.

The standardized unit master data files for all PROFIBUS-DP masters can be downloaded from the PROFIBUS users' organization.

Application of the GSD and type files with different project planning tools:

Project planning tool	DP master	File name
All DP project planning tools to EN 50170 (V2)	For DP master standard	SEW_6002.GSD
Siemens S7 hardware configuration	For all S7 DP masters	
Siemens S5 COM PROFIBUS	For IM 308C u. a.	SE_6002AX.200*
Siemens COMET200 V2.x Windows	For IM 308C u. a.	
Siemens COMET200 V4.x DOS	For IM 308B (A5)	

* On request, since the program versions are no longer supported by Siemens.

The latest versions of the GSD files for SEW inverters can be downloaded from the SEW homepage, URL <http://www.SEW-EURODRIVE.de>.



Safety Notes

Installation and startup / Operation and service / Bus systems

2 Safety Notes

Installation and startup

- **Never install damaged products or take them into operation.** Please submit a complaint to the transport company immediately in the event of damage.
- Only **electrical specialists** with the relevant accident prevention training are allowed to perform **installation, startup and service work** on the unit. They must also comply with the regulations in force (e.g. EN 60204, VBG 4, DIN-VDE 0100/0113/0160).
- Follow the specific instructions during **installation** and **startup** of the motor and the brake!



- Make sure that **preventive measures** and **protection devices** correspond to the **applicable regulations** (e.g. EN 60204 or EN 50178).
Required preventive measures: Grounding the unit
Required protection device: Overcurrent protection devices
- **The units meets all requirements for reliable isolation** of power and electronics connections in accordance with EN 50178. **All connected circuits** must also **satisfy the requirements for reliable isolation** so as to guarantee reliable isolation.
- Take **suitable measures (e.g. connect tl. X10:9 /CONTROLLER INHIBIT to DGND)** to ensure that the connected **motor does not start up automatically when the inverter is switched on.**

Operation and service



- **Disconnect the unit from the supply system** prior to **removing the protective cover.** **Dangerous voltages** may still be present for up to **10 minutes after mains disconnection.**
- The unit has **IP 00** enclosure with the **protective cover removed.** **Dangerous voltages** are present at all subassemblies except for the control electronics. The unit must be closed during operation.
- **Dangerous voltages** are present at the **output terminals** and the **cables and motor terminals connected to them when the unit is switched on.** This also applies even when the unit is inhibited and the motor at a standstill.
- The fact that the **V1 operation LED** and other display elements **have gone out** is **no indication** that the unit has been disconnected from the supply system and is **de-energized.**



- **Safety functions inside the unit** or a **mechanical blockage** may cause the **motor to stop.** The **removal of the source of the malfunction** or a **reset** can result in an **automatic restart of the drive.** If, for safety reasons, this is **not permissible,** the **unit must be disconnected from the supply system** before correcting the fault. In such cases, it is also forbidden for the **“Auto reset” function (P841)** to be activated.

Bus systems

- With bus systems, there is a danger of **invisible,** external (as far as the inverter is concerned) **modifications to the parameters which give rise to changes in the inverter's behavior.** This may result in **unexpected** (not uncontrolled, though!) **system behavior.**



3 Installation

3.1 Unit designation, nameplates and scope of supply

Sample unit designation

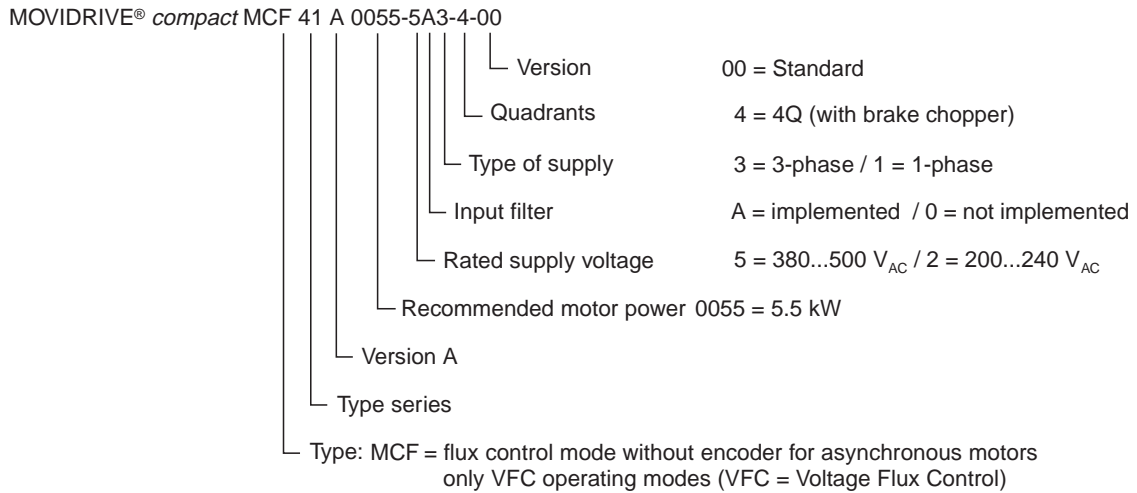

02886AEN

Sample name-plate

The collective nameplate is attached to the side of the unit.



02887AXX

Fig. 1: Collective nameplate (example)

Furthermore, a rating label is attached to the front of the control module (above the TERMINAL option slot).



02888AXX

Fig. 2: Rating label (example)

Scope of delivery

- In addition, with size 1: Plug housing for the power terminals (X1 – X4), plugged on.
- In addition, with sizes 1 and 2: Power shield clamp (→ Sec. 3.10).
- In addition, with sizes 4 and 5 (MCF41A0370...0750): Protection against contact for the power terminals (→ Sec. 3.11).

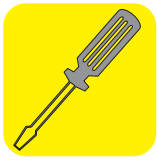

3.2 Unit design, size 1

MCF41A...-2A3 (230 V units): 0015...0037

MCF41A...-5A3: (400/500 V units): 0015...0040

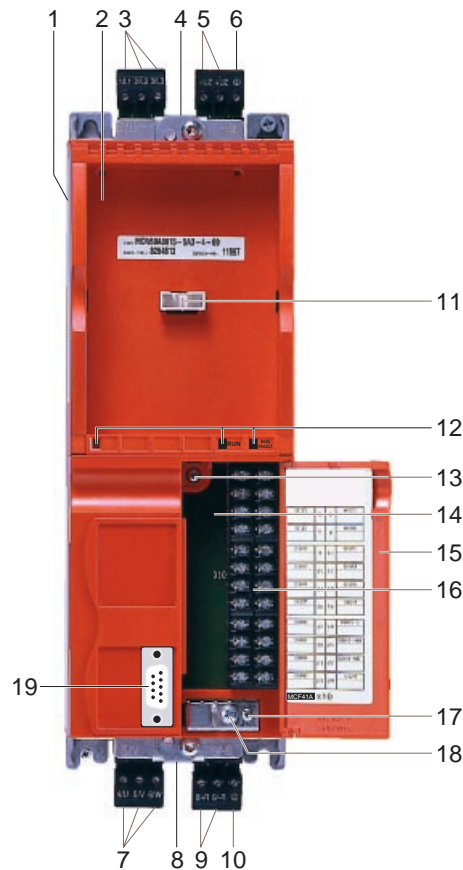
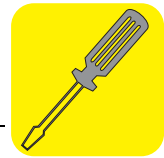

Fig. 3: Unit design, MOVIDRIVE® compact MCF41A, size 1

02889AXX

1. Power section
2. Control module
3. X1: Supply system connection L1 (1) / L2 (2) / L3 (3), separable
4. X5: Connection for power shield clamp (not visible)
5. X4: DC link connection $-U_Z / +U_Z$, separable
6. X4: PE connection (⊕), separable
7. X2: Motor connection U (4) / V (5) / W (6), separable
8. X6: Connection for power shield clamp (not visible)
9. X3: Braking resistor connection R+ (8) / R- (9), separable
10. X3: PE connection (⊕), separable
11. TERMINAL: Option slot for DBG11A keypad or USS21A serial interface
12. V1 operating LED and PROFIBUS-DP diagnostic LEDs "RUN" and "BUS FAULT"
13. Retaining screw A for terminal unit
14. Terminal unit for control leads, detachable
15. Flap on terminal unit with labeling tile
16. X10: Electronics terminal strip
17. Retaining screw B for terminal unit
18. Screw for electronics shield clamp
19. X30: PROFIBUS-DP connection, 9-pin sub D socket



3.3 Unit design, size 2

MCF41A...-2A3 (230 V units): 0055/0075

MCF41A...-5A3: (400/500 V units): 0055...0110

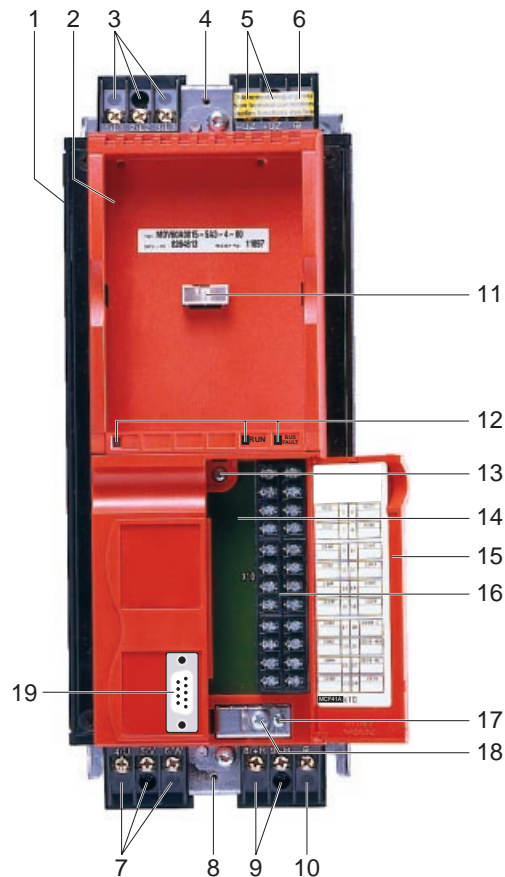
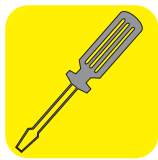

Fig. 4: Unit design, MOVIDRIVE® compact MCF41A, size 2

02890AXX

1. Power section
2. Control module
3. X1: Supply system connection L1 (1) / L2 (2) / L3 (3)
4. X5: Connection for power shield clamp
5. X4: DC link connection $-U_Z$ / $+U_Z$
6. X4: PE connection (\oplus)
7. X2: Motor connection U (4) / V (5) / W (6)
8. X6: Connection for power shield clamp
9. X3: Braking resistor connection R+ (8) / R- (9)
10. X3: PE connection (\oplus)
11. TERMINAL: Option slot for DBG11A keypad or USS21A serial interface
12. V1 operating LED and PROFIBUS-DP diagnostic LEDs "RUN" and "BUS FAULT"
13. Retaining screw A for terminal unit
14. Terminal unit for control leads, detachable
15. Flap on terminal unit with labeling tile
16. X10: Electronics terminal strip
17. Retaining screw B for terminal unit
18. Screw for electronics shield clamp
19. X30: PROFIBUS-DP connection, 9-pin sub D socket



3.4 Unit design, size 3

MCF41A...-203 (230 V units): 0110

MCF41A...-503: (400/500 V units): 0150...0300

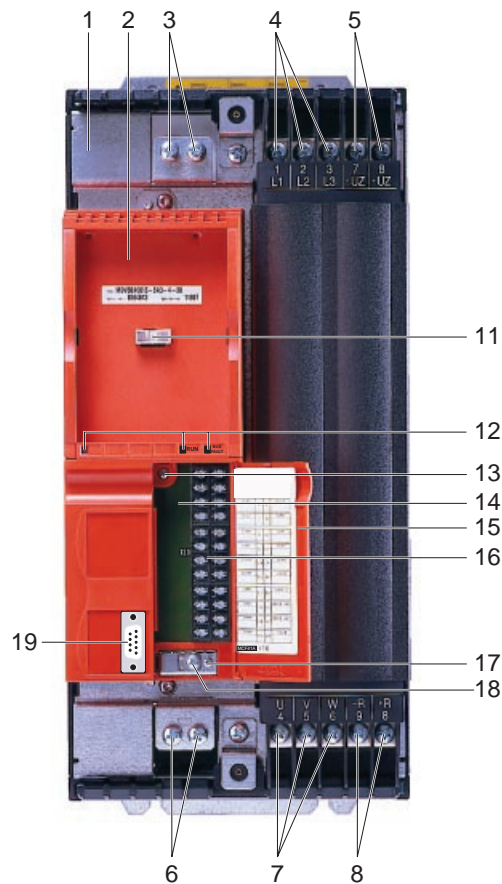
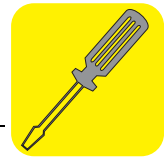

Fig. 5: Unit design, MOVIDRIVE® compact MCF41A, size 3

02891AXX

1. Power section
2. Control module
3. PE connections (⊕)
4. X1: Supply system connection L1 (1) / L2 (2) / L3 (3)
5. X4: DC link connection -U_Z (7) / +U_Z (8)
6. PE connections (⊕)
7. X2: Motor connection U (4) / V (5) / W (6)
8. X3: Braking resistor connection R+ (8) / R- (9)
11. TERMINAL: Option slot for DBG11A keypad or USS21A serial interface
12. V1 operating LED and PROFIBUS-DP diagnostic LEDs "RUN" and "BUS FAULT"
13. Retaining screw A for terminal unit
14. Terminal unit for control leads, detachable
15. Flap on terminal unit with labeling tile
16. X10: Electronics terminal strip
17. Retaining screw B for terminal unit
18. Screw for electronics shield clamp
19. X30: PROFIBUS-DP connection, 9-pin sub D socket



3.5 Unit design, sizes 4 and 5 (MCF41A0370...0750):

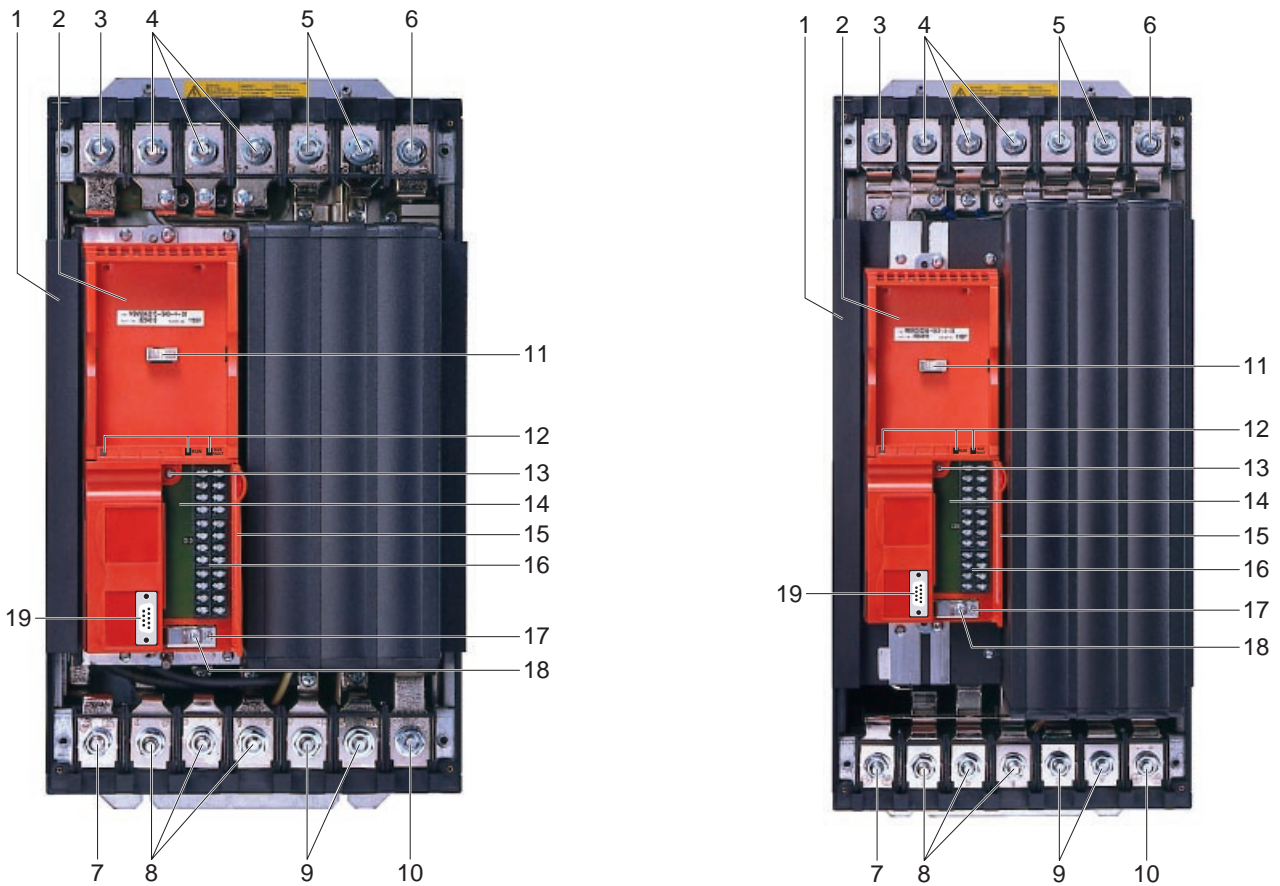

02892AXX

Bild 6: Unit design, MOVIDRIVE® compact MCF41A, sizes 4 and 5

1. Power section
2. Control module
3. X1: PE connection (⊕)
4. X1: Supply system connection L1 (1) / L2 (2) / L3 (3)
5. X4: DC link connection -U_Z (7) / +U_Z (8)
6. X4: PE connection (⊕)
7. X2: PE connection (⊕)
8. X2: Motor connection U (4) / V (5) / W (6)
9. X3: Braking resistor connection R+ (8) / R- (9)
10. X3: PE connection (⊕)
11. TERMINAL: Option slot for DBG11A keypad or USS21A serial interface
12. V1 operating LED and PROFIBUS-DP diagnostic LEDs "RUN" and "BUS FAULT"
13. Retaining screw A for terminal unit
14. Terminal unit for control leads, detachable
15. Flap on terminal unit with labeling tile
16. X10: Electronics terminal strip
17. Retaining screw B for terminal unit
18. Screw for electronics shield clamp
19. X30: PROFIBUS-DP connection, 9-pin sub D socket



Installation instructions for basic unit

Tightening torques / Tools / Minimum clearance, mounting position / More than 4 units

3.6 Installation instructions for basic unit



It is essential to comply with the safety notes during installation (→ Sec. 2, page 6).

Tightening torques

- Only use **genuine connection elements**.
Note the tightening torques of the MOVIDRIVE® MCF41A power terminals:
 Size 1 → 0.6 Nm (5.3 in lbs) / Size 2 → 1.5 Nm (13.3 in lbs) /
 Size 3 → 3.5 Nm (31 in lbs) / Sizes 4 and 5 → 14 Nm (124 in lbs)

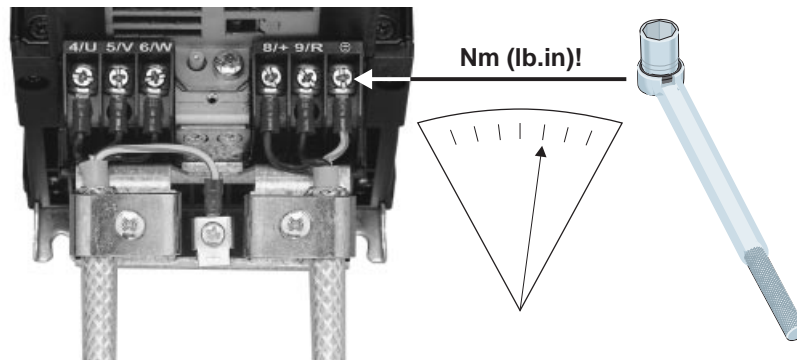

02475AXX

Fig. 7: Note the tightening torques

Recommended tools for the electronics terminal strip

- Only use the following tools for connecting the electronics terminal strip X10: Other tools will lead to irreparable damage to the screw head.
 - Phillips Posidrive screwdriver size 1 to DIN 5262 PH1
 - Straight blade screwdriver to DIN 5265, size 4.0 x 0.8 or 4.5 x 0.8

Minimum clearance and mounting position

- Leave **100 mm (4 in) clearance at the top and bottom** for optimum cooling. No clearance is required at the sides; the units can be lined up in rows. With sizes 4 and 5, do not install any components which are sensitive to high temperatures within 300 mm (11.81 in) of the top of the unit. Install the units **vertically**. You must not install them horizontally, tilted or upside down!

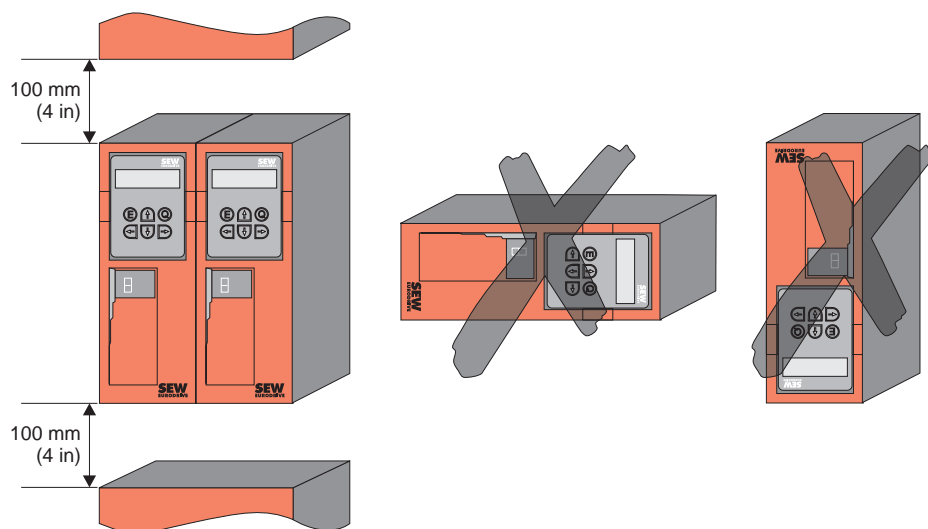

02474AXX

Fig. 8: Minimum clearance and installation position of the units

More than 4 units

- **More than 4 units** on a supply system contactor designed to cope with the total current: **Insert a 3-phase line choke in the circuit** to limit the inrush current.

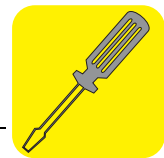

Separate cable ducts

- Route power current cables and electronics cables in separate cable ducts.

Input fuses and earth leakage circuit-breakers

- Install **input fuses at the start of the supply system cable** after the supply bus junction (→ Sec. 3.12 F11/F12/F13). Use D, DO, NH or power circuit breakers. Using an **earth leakage circuit-breaker as the sole protection device is not permitted**. Earth-leakage currents > 3.5 mA can arise during normal operation of the inverter.

PE supply system connection (→ EN 50178)

- If the supply system lead is < 10 mm² (AWG8), lay a second PE conductor with the cross section of the supply system lead in parallel to the protective earth using separate terminals. Alternatively, use a protective earth conductor with a cross section of 10 mm² (AWG8) Cu. If the supply system lead is 10 mm², use 2 (AWG8) Cu protective earths with the cross section of the supply system lead. Earth-leakage currents > 3.5 mA may arise in service.

IT systems

- SEW recommends using **earth-leakage monitors with a pulse code measuring process** in voltage power systems with a non-earthed star point (**IT systems**). This avoids mis-tripping of the earth-leakage monitor due to the earth capacitance of the inverter.

Supply system and motor lead

- Supply system lead: **Cross section according to nominal input current I_{system}** at rated load. Motor lead: **Cross section according to output rated current I_N** (data → Sec. 5).

Unit output

- Only connect an **ohmic/inductive load (motor)**; do not connect a capacitive load!

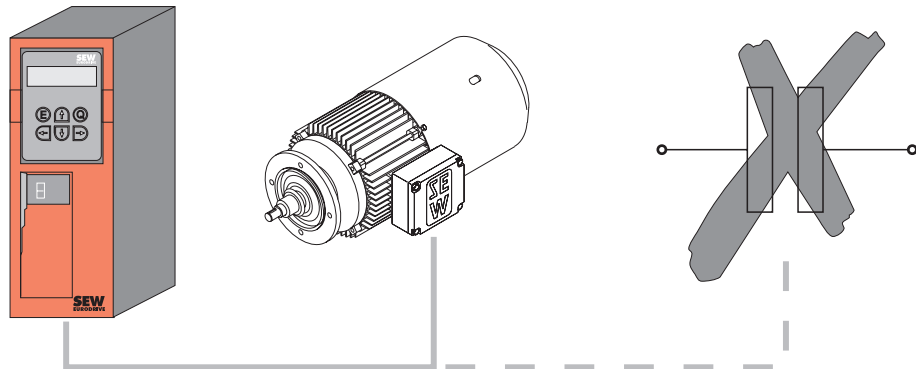

02476AXX

Fig. 9: Only connect an ohmic/inductive load; do not connect a capacitive load!

Connection of braking resistors

- Use two closely twisted cables or 2-core shielded power current cables. Cross section according to the rated current of the inverter (data → Sec. 5). **Protect the braking resistor with a bimetallic relay** (→ Sec. 3.12: F16), **trip current according to the technical data for braking resistors** (→ Sec. 3.14).

Operation of braking resistors

- The connection leads to the braking resistor carry a **high DC voltage (approx. 900 V)** during rated operation. If necessary, fit flat-type braking resistors together with appropriate shock-hazard protection. The **surfaces** of the braking resistors get **very hot** when the braking resistors are loaded with P_N . Select a suitable installation location. As a rule, braking resistors are mounted on the switch cabinet roof.

Binary inputs / binary outputs

- **Binary inputs** are **electrically isolated** by optocouplers. The **binary outputs** are **short-circuit proof**, although they are **not interference-voltage proof**. They can suffer irreparable damage from external voltage!

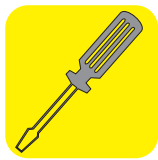

Installation instructions for PROFIBUS-DP interface

Pin assignment / Shielding and routing of the bus cables

3.7 Installation instructions for PROFIBUS-DP interface

Pin assignment

The MOVIDRIVE[®] *compact* is connected to the PROFIBUS network using a 9-pin sub D plug according to EN 50170. The T-bus connection must be made using a plug with the corresponding configuration.

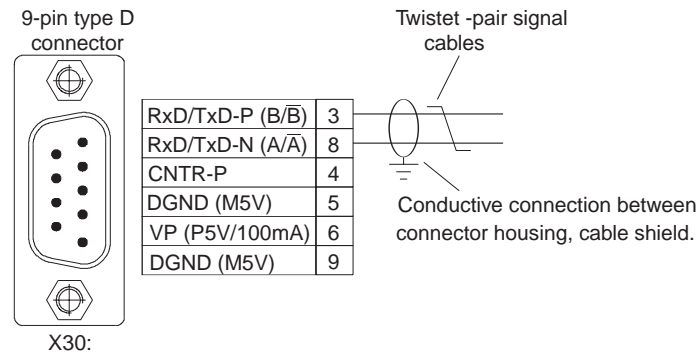

Fig. 10: Assignment of 9-pin sub D plug to EN 50170

02893AEN

As a rule, the MOVIDRIVE[®] *compact* drive inverter is connected to the PROFIBUS system using a shielded twisted-pair cable. Note the maximum supported transmission rate when you are selecting the bus connector.

The two-core cable is connected to the PROFIBUS connector using pin 8 (A/A) and pin 3 (B/B). Communication takes place via these two contacts. The RS-485 signals A/A and B/B must be connected to the same contacts in all PROFIBUS stations. Otherwise, communication via the bus will not function.

The PROFIBUS interface sends a TTL control signal via pin 4 (CNTR-P) for a repeater or FO adapter (reference = pin 9).

Shielding and routing of the bus cables

The PROFIBUS interface supports RS-485 transmission technology and requires the cable type A to EN 50170 specified as the physical medium for PROFIBUS. This cable must be a shielded, twisted-pair two-core cable.

Having the bus cable correctly shielded cuts out parasitic interference which can occur in an industrial environment. The following measures enable the best possible shielding to be achieved:

- Tighten the retaining screws of plugs, modules and equipotential bonding conductors until finger-tight.
- Only use connectors with a metal housing or a metallized housing.
- Connect the shield in the connector over a large surface area.
- Apply the bus cable shielding on both ends.
- Do not route the signal and bus cables in parallel to the power cables (motor leads); use separate cable ducts if at all possible.
- Only use metal, grounded cable racks in industrial environments.
- Join the signal cables and the associated equipotential bonding together at closely spaced intervals by the shortest route.
- Avoid using plug connections to extend bus cables.
- Route the bus cables closely adjacent to available grounding surfaces.



In the event of fluctuations in the ground potential, a compensating current may flow along the shield which is connected at both ends and to the ground potential (PE). In this case, make adequate provision for equipotential bonding in accordance with the relevant VDE regulations.

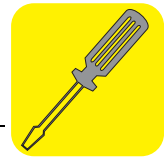

Bus termination

If the MOVIDRIVE® *compact* drive inverter is located at the start of or the end of a PROFIBUS segment, then the connection to the PROFIBUS network is not generally made using a T-bus connection with an incoming and outgoing PROFIBUS cable. Instead, the connection is a direct one with only one PROFIBUS cable. In order to avoid disruptions in the bus system due to reflections, etc., the PROFIBUS segment must be terminated with bus terminating resistors at the first and last physical participants.

It is not necessary to use a sub D plug with integrated terminating resistors because the bus terminating resistors on the inverter can be switched on (DIP switches below the terminal unit → Sec. 3.13, page 24).

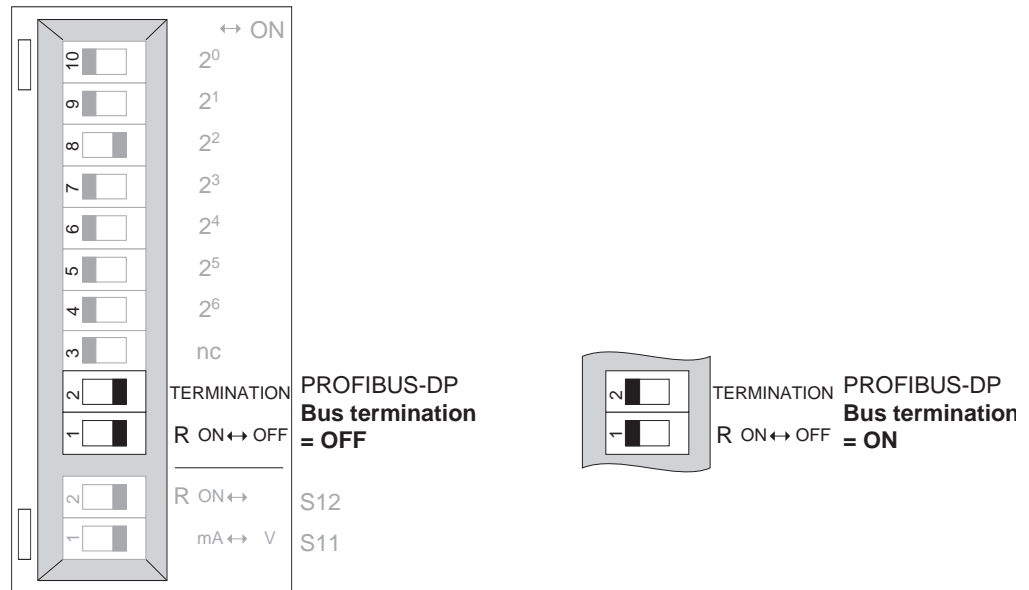

Fig. 11: Activating the bus termination with the DIP switches

02894AEN



Both DIP switches (TERMINATION 1 and 2) must be switched!

Bus termination is implemented for cable type A to EN 50170 (V2).



Installation instructions for PROFIBUS-DP interface

Setting the station address

Setting the station address

The PROFIBUS station address is set using DIP switches 4 – 10 (valency $2^6 - 2^0$) below the terminal unit (→ Sec. 3.13, page 24). MOVIDRIVE[®] compact supports the address range 0 – 125.

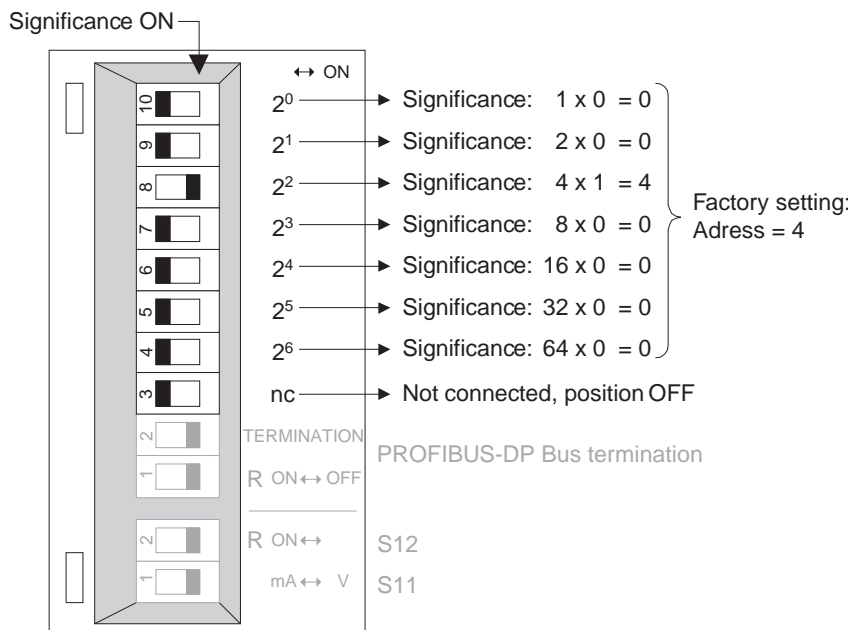

02895AEN

Fig. 12: Setting the PROFIBUS station address

The PROFIBUS station address can only be set using the DIP switches when the terminal unit has been removed. This means the address cannot be altered during ongoing operation. The change comes into effect when the drive inverter is switched back on (power system + 24 V OFF/ON). The drive inverter displays the current station address in fieldbus monitor parameter P092 "Fieldbus address" (display with DBG11A, MX_SHELL or MOVITOOLS).

For example: Setting station address 17

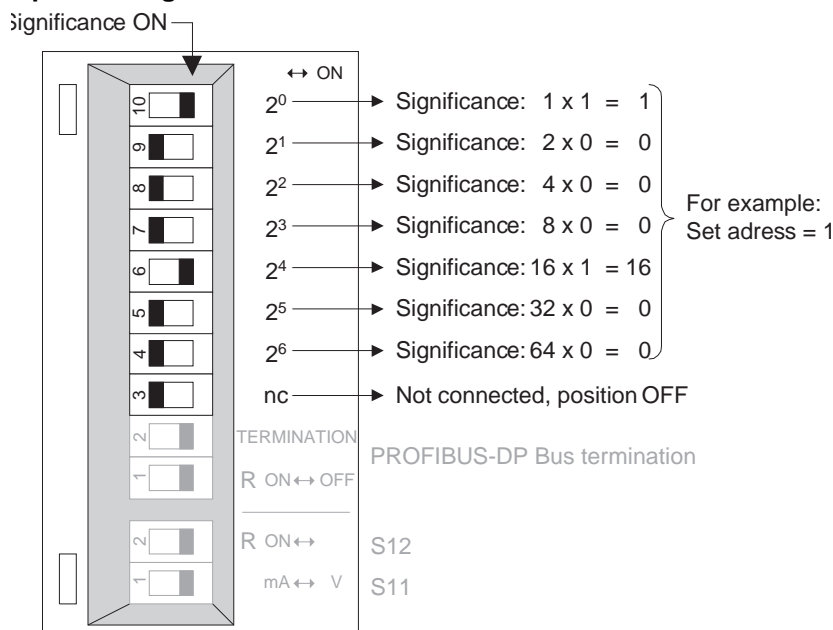

03003AEN

Fig. 13: Setting station address 17

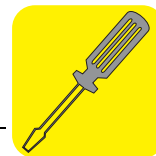

3.8 EMC-compliant installation

Shielding and earthing

- The control cables must be shielded.
- Connect the shield by the shortest possible route and make sure it is earthed over a wide area. To avoid ground loops, it is possible to earth one end of the shield via a suppression capacitor (220 nF / 50 V). If using double-shielded cables, earth the outer shield on the MOVIDRIVE[®] end and the inner shield on the other end.
- Another basic requirement for shielding is that all cables must be laid separately in individual, earthed sheet metal ducts or pipes.
- Provide high frequency-compatible earthing for MOVIDRIVE[®] compact and all additional units (wide area metal-on-metal contact between the unit housing and ground, e.g. unpainted switch cabinet mounting panel).

NF...-... mains filter

- MOVIDRIVE[®] size 1 and 2 are fitted with a mains filter as standard. This mains filter ensures that limit value class A is maintained on the supply side.
- Fit the mains filter close to MOVIDRIVE[®] compact **beyond the minimum clearance**.
- Restrict the length of the cable between the mains filter and MOVIDRIVE[®] Compact to the absolute minimum needed; max. 400 mm (15.8 in) is permitted. Unshielded, twisted cables are sufficient. Also, only use unshielded cables for the supply system lead.
- The mains filter must be mounted either directly at the entry point into the switch cabinet or in the immediate vicinity of the inverter if several inverters are connected to the same mains filter. The mains filter must be chosen on the basis of the total current of the inverters.

HD... output choke

- Fit the output choke close to MOVIDRIVE[®] compact **beyond the minimum clearance**.
- Always route all three phases and the PE together through the output choke.

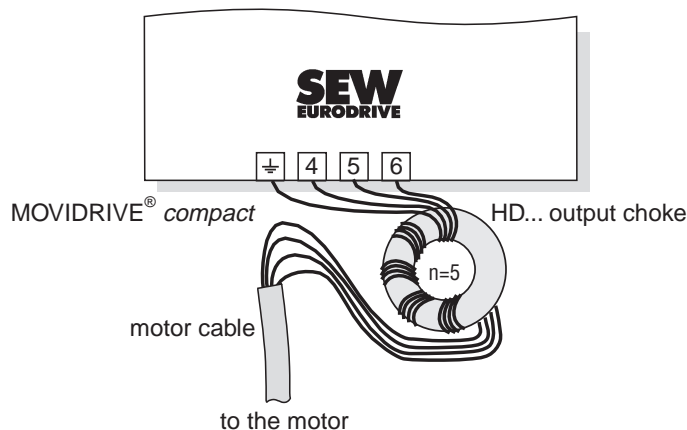

Fig. 14: Connecting HD... output chokes

02395AEN



No EMC limits are specified for interference emission in voltage supply systems without an earthed star point (IT systems). The effectiveness of mains filters is severely limited.



UL-compliant installation

400/500 V units

3.9 UL-compliant installation

Please note the following points for UL-compliant installation:

- Only use copper cables with the following temperature ranges as connection leads:
 - For MOVIDRIVE[®] compact MCF41A0015...0300 temperature range 60/75 °C.
 - For MOVIDRIVE[®] compact MCF41A0370...0750 temperature range 75/90 °C.
- The permitted tightening torques for MOVIDRIVE[®] compact power terminals are:
 - For size 1 → 0.6 Nm (5.3 in lbs)
 - For size 2 → 1.5 Nm (13.3 in lbs)
 - For size 3 → 3.5 Nm (31 in lbs)
 - For size 4 → 14 Nm (124 in lbs)
 - For size 5 → 14 Nm (124 in lbs)
- MOVIDRIVE[®] compact drive inverters are suitable for operation in voltage power systems with an earthed star point (TN and TT systems) which can supply a max. current in accordance with the following tables and which have a max. voltage of 240 V_{AC} for MOVIDRIVE[®] compact MCF41A...-2_3 (230 V units) and 500 V_{AC} for MOVIDRIVE[®] compact MCF41A...-5_3 (400/500 V units). The ratings of the fuses must not exceed the values in the table.

230 V units

MOVIDRIVE [®] compact MCF41A...-2_3	Max. supply current	Max. supply voltage	Fuses
0015/0022/0037	5 000 A _{AC}	240 V _{AC}	30 A / 250 V
0055/0075	5 000 A _{AC}	240 V _{AC}	30 A / 250 V
0110	5 000 A _{AC}	240 V _{AC}	175 A / 250 V

400/500 V units

MOVIDRIVE [®] compact MCF41A...-5_3	Max. supply current	Max. supply voltage	Fuses
0015/0022/0030/0040	10 000 A _{AC}	500 V _{AC}	30 A / 600 V
0055/0075/0110	10 000 A _{AC}	500 V _{AC}	30 A / 600 V
0150/0220	5 000 A _{AC}	500 V _{AC}	175 A / 600 V
0300	5 000 A _{AC}	500 V _{AC}	225 A / 600 V
0370/0450	10 000 A _{AC}	500 V _{AC}	350 A / 600 V
0550/0750	10 000 A _{AC}	500 V _{AC}	500 A / 600 V

- Only use tested units with a limited output voltage ($U_{\max} = 30 \text{ V}_{\text{DC}}$) and limited output current ($I \leq 8 \text{ A}$) as an external 24 V_{DC} voltage source.



UL certification does not apply to operation in voltage power systems with a non-earthed star point (IT systems).

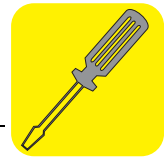

3.10 Power shield clamp

For size 1

A power shield clamp is supplied as standard with MOVIDRIVE® compact size 1. Mount the power shield clamp using the unit's retaining screws.

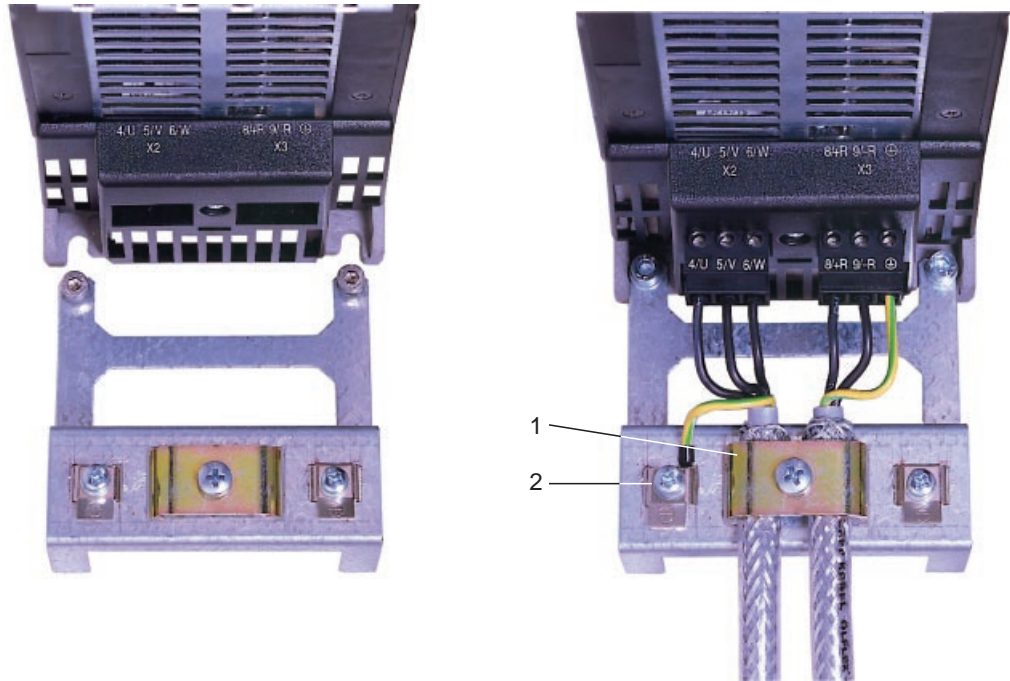

- 1 Shield clamp
- 2 PE connection (⊕)

02012BXX

Fig. 15: Power shield clamp for MOVIDRIVE® compact size 1

For size 2

A power shield clamp with 2 retaining screws is supplied as standard with MOVIDRIVE® compact size 2. Attach the power shield clamp to X6.

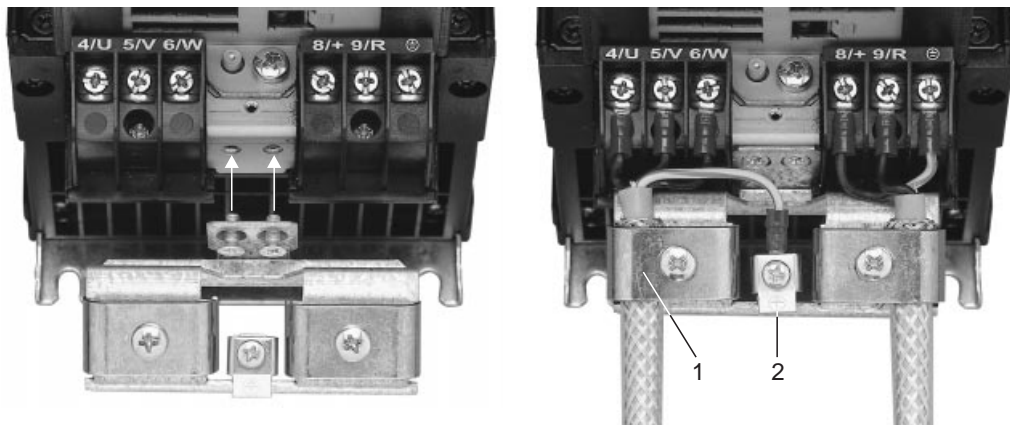

- 1 Shield clamp
- 2 PE connection (⊕)

01469BXX

Fig. 16: Power shield clamp for MOVIDRIVE® compact size 2

The shielding for the motor lead and the lead for the braking resistor can be mounted extremely conveniently, in particular for EMC-compliant installation. Position the shield and the PE conductor as shown in Fig. 15 and Fig. 16.

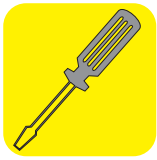

3.11 Touch guard

As standard, 2 contact protection units including 8 retaining screws are supplied with MOVIDRIVE[®] compact size 4 (0370/0450) and size 5 (0550/0750). Mount the touch guard contact on both hood covers of the power section terminals.

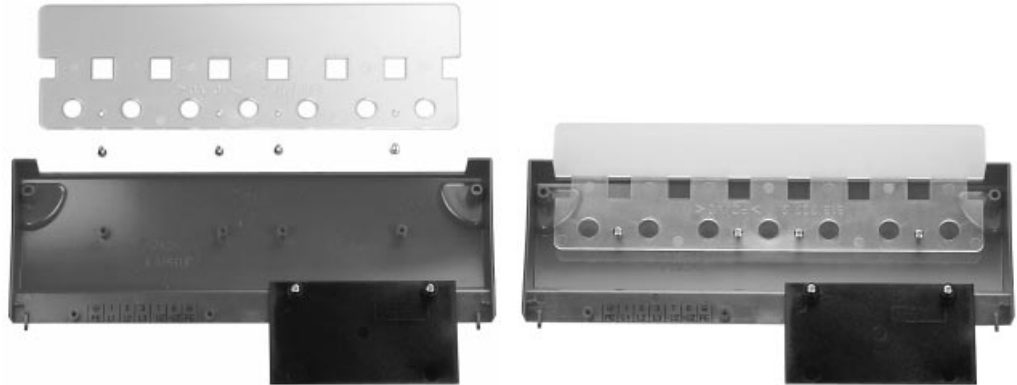
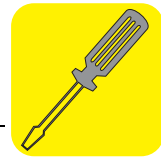

Fig. 17: Touch guard contact for MOVIDRIVE[®] compact sizes 4 and 5

01470BXX

With installed touch guard, MOVIDRIVE[®] compact sizes 4 and 5 units achieve IP10 enclosure (IP00 without protection against contact).



3.12 Diagram of connections, basic unit

Connection of the power section and brake

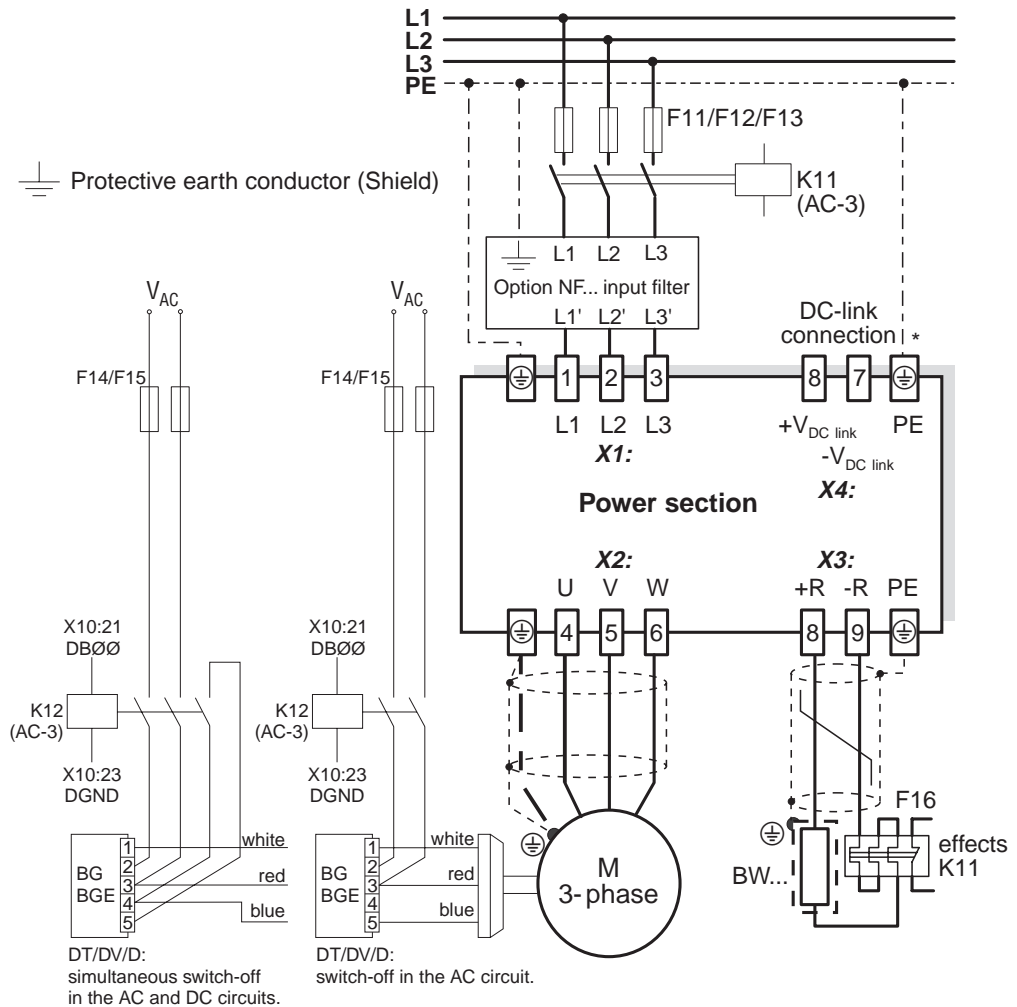

02396AEN

* With sizes 1 and 2, there is no PE connection next to the power system connection terminals. In this case, use the PE terminal next to the DC link connection.

Fig. 18: Diagram of connection, power section and brake



A separate supply system lead is required for connecting the brake rectifier; supply from the motor voltage is not permitted!

Only use contactors in utilization category AC-3 (IEC158-1) for K11 and K12.

Always switch off the brake on the DC **and** AC sides under the following conditions:

- all hoist applications,
- drives which require a rapid brake reaction time.

Route the connection cables between the brake rectifier and the brake separately from other power cables if the brake rectifier is installed in the switch cabinet. Routing together with other cables is only permitted if the other cables are shielded.

The relevant connection regulations must be followed for brakes without BG/BGE or BME. Refer to "Drive Engineering – Practical Implementation, Vol. 4", publication number 0920 220X for detailed information about SEW brakes.

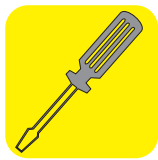
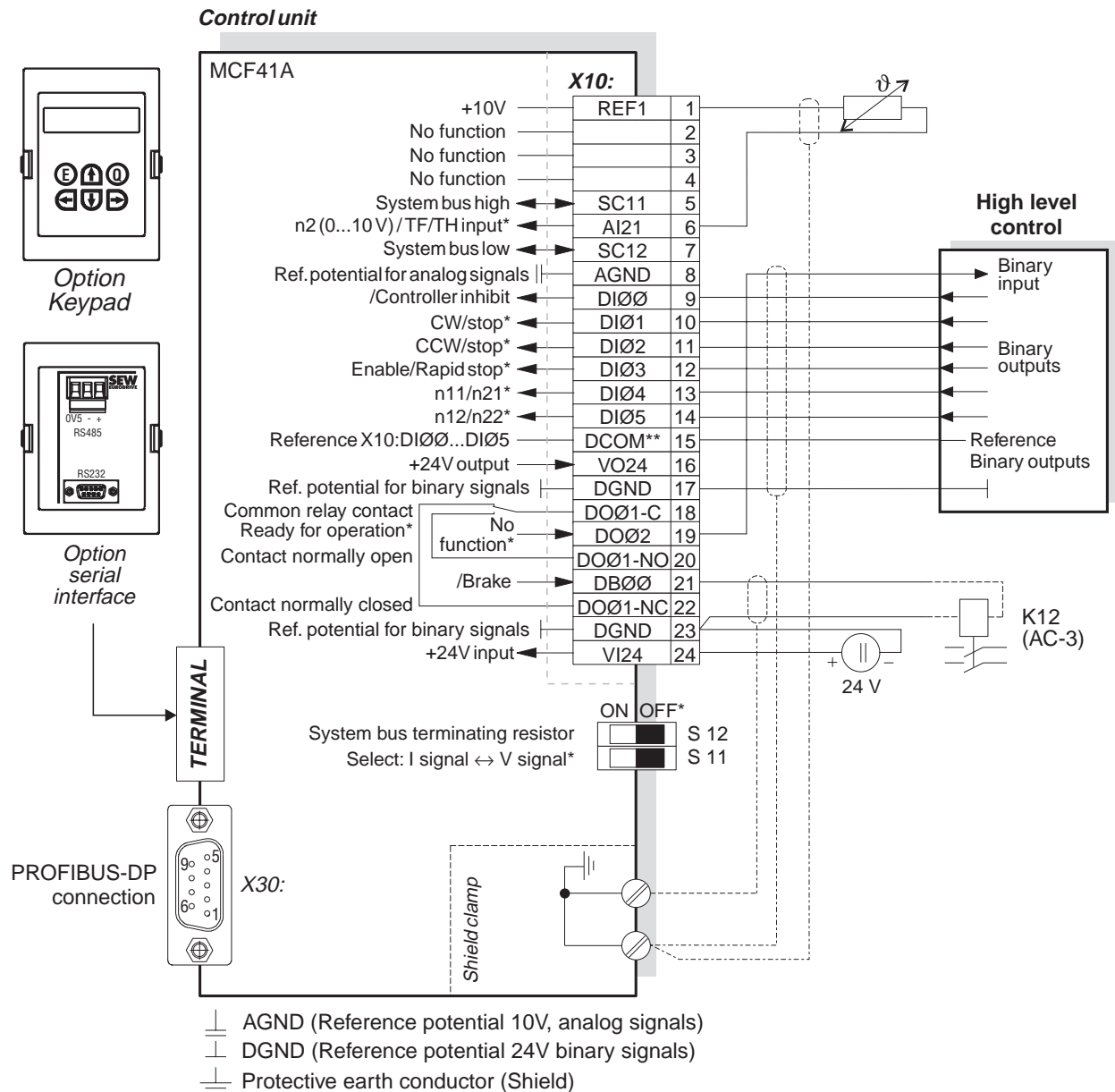

Diagram of connections, basic unit

Connection of the MOVIDRIVE® compact MCF41A control module

Connection of the MOVIDRIVE® compact MCF41A control module



* Factory setting

** If the binary inputs are connected to the 24 V_{DC} voltage supply X10:16 "VO24" then jumper X10:15 to X10:17 (DCOM to DGND) on MOVIDRIVE® compact MCF41A.

02896AEN

Fig. 19: Diagram of connections, control module



- **Always connect a 24 V voltage supply according to EN 61131-2 (U_N = +24 V -15 %/+20 %) to X10:24 (VI24).**
- Analog input AI21 can be used either as a 0 – 10 V voltage input or as a TF/TH input. It is set using parameter P120.
- DIP switches S11, S12 and 1 – 10 cannot be accessed unless the terminal unit is removed (→ Sec. 3.13, page 24).
- DIP switch S11 (changeover I signal ↔ U signal) does not have any function.
- The function of DIP switches 1 – 10 (PROFIBUS-DP) is explained in Sec. 3.7, page 14.

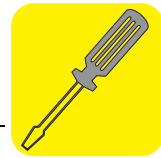

Functional description of the terminals (power terminals and electronics terminals)

Terminal	Function
X1: 1/2/3 X2: 4/5/6 X3: 8/9 X4:	L1/L2/L3 U/V/W +R/-R +U _Z /-U _Z Supply system connection Motor connection Braking resistor connection DC link connection
X10: 5/7 6 8 9 10 11 12 13 14 15 16 17 18 19 20 21 22 23 24	SC11/SC12 AI21 AGND DIØØ DIØ1 DIØ2 DIØ3 DIØ4 DIØ5 DCOM VO24 DGND DOØ1-C DOØ2 DOØ1-NO DBØØ DOØ1-NC DGND VI24 System bus high/low Analog input n2 (reference AGND), optionally 0 – 10 V or TF/TH (→ P120) Reference potential for analog signals (AI21) Binary input 1, with fixed assignment/Controller inhibit Binary input 2, factory setting CW/stop Binary input 3, CCW/stop Binary inputs 4 Enable/rapid stop Binary input 5 n11/n21 Binary input 6 n12/n22 Reference for binary inputs DIØØ – DIØ5 Switching of binary inputs using +24 V from VO24: Switching of binary inputs with external voltage +24 V: Auxiliary supply output +24 V (max. 200 mA) Reference potentials for binary signals Binary output 1, factory setting Ready Binary output 2, /Fault Binary output 1, NO contact Binary output 0, with fixed assignment/Brake Binary output 1, NC contact Reference potential for binary signals Input +24 V voltage supply (backup voltage)
X30:	PROFIBUS-DP connection, 9-pin sub D socket, pin assignment → Sec. 3.7, page 14
1 – 10	PROFIBUS-DP DIP switches (setting address and switching bus term. resistor ON/OFF) → Sec. 3.7, page 14
S11 S12	No function in MCF41A Switch system bus terminating resistor on or off, factory setting: switched off
TERMINAL	Option slot for DBG11A keypad or serial port USS21A (RS-232 and RS-485)

Assignment of electronics terminals and labeling tile

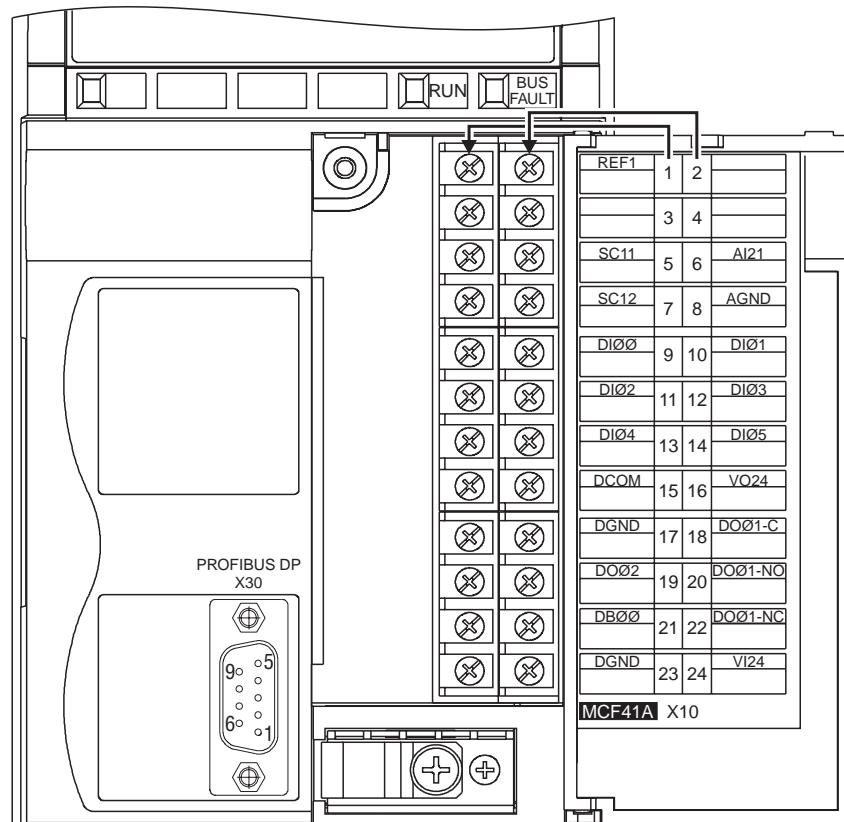
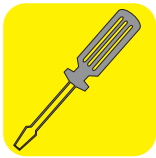

Fig. 20: Electronics terminals and labeling tile

02897AXX



3.13 Removing the terminal unit



Important:

Only take off or put on the terminal unit when the unit is switch off (mains off)!

You can remove the complete terminal unit from the control module to facilitate installation of the control leads and to make it easy to replace the inverter if it has to be serviced. You have to take off the terminal unit in order to set the DIP switches for PROFIBUS-DP and the system bus. Proceed as follows to do this:

1. Open the flap on the terminal unit.
2. Unscrew retaining screws A and B; they are captive screws and cannot fall out.
3. Pull the terminal unit off the control module.

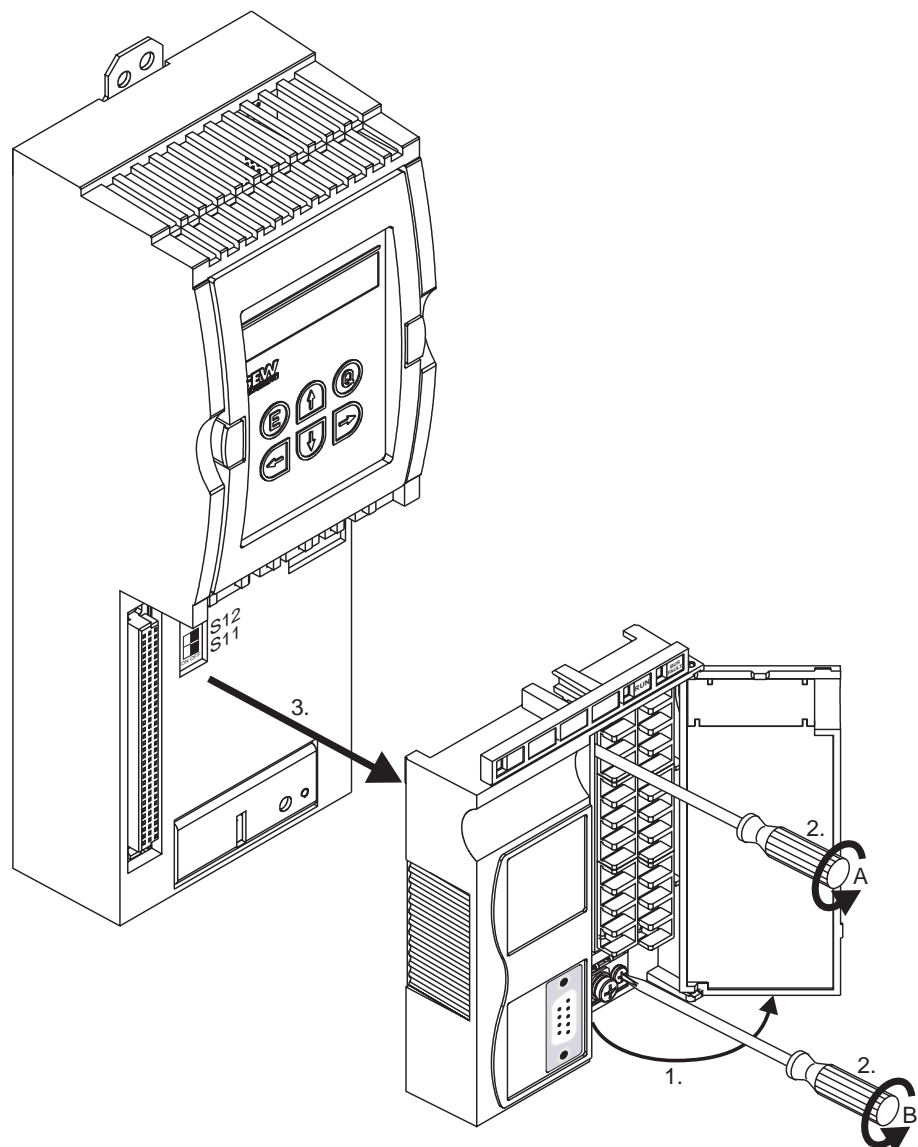

02898AXX

Fig. 21: Removing the terminal unit

Follow the instructions in reverse order when replacing the terminal unit.

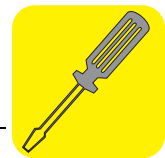

3.14 Assignment of braking resistors, chokes, filters

230 V units, sizes 1, 2 and 3

MOVIDRIVE® compact MCF 40A....-2_3			0015	0022	0037	0055	0075	0110
Size			1			2		3
Braking resistors	Trip current	Part number						
BW039-003	$I_F = 2.0 A_{RMS}$	821 687 8						
BW039-006	$I_F = 3.2 A_{RMS}$	821 688 6						
BW039-012	$I_F = 4.2 A_{RMS}$	821 689 4						
BW039-026	$I_F = 7.8 A_{RMS}$	821 690 8						
BW027-006	$I_F = 2.5 A_{RMS}$	822 422 6						
BW027-012	$I_F = 4.4 A_{RMS}$	822 423 4						
BW018-015	$I_F = 4.0 A_{RMS}$	821 684 3						C
BW018-035	$I_F = 8.1 A_{RMS}$	821 685 1						C
BW018-075	$I_F = 14 A_{RMS}$	821 686 X						C
BW915	$I_F = 28 A_{RMS}$	821 260 0						C
BW012-025	$I_F = 10 A_{RMS}$	821 680 0						
BW012-050	$I_F = 19 A_{RMS}$	821 681 9						
BW012-100	$I_F = 27 A_{RMS}$	821 682 7						
Line chokes		Part number						
ND020-013	$\Sigma I_{system} = 20 A_{AC}$	826 012 5				A		
ND045-013	$\Sigma I_{system} = 45 A_{AC}$	826 013 3				B		A
ND085-013	$\Sigma I_{system} = 85 A_{AC}$	826 014 1						B
Line filters		Part number						
NF008-443	$U_{max} = 440 V_{AC}$	825 721 3	A	A				
NF016-443		825 719 1	B	B	A			
NF025-443		825 718 3			B	A		
NF036-443		825 717 5				B		
NF050-443		825 716 7						A
NF080-443		825 830 9						B
Output chokes		Inside diameter	Part number					
HD001	$d = 50 \text{ mm (1.97 in)}$	813 325 5	For cable cross sections 1.5 – 16 mm ² (AWG16 – 6)					
HD002	$d = 23 \text{ mm (0.91 in)}$	813 557 6	For cable cross sections $\leq 1.5 \text{ mm}^2$ (AWG16)					
HD003	$d = 88 \text{ mm (4.46 in)}$	813 558 4	For cable cross sections $\geq 16 \text{ mm}^2$ (AWG6)					

- A With rated operation (100 %)
- B With variable torque load (125 %)
- C Connect two braking resistors in parallel and set twice the trip current on F16!

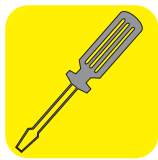

Assignment of braking resistors, chokes, filters

400/500 V units, sizes 1 and 2

400/500 V units, sizes 1 and 2

MOVIDRIVE [®] compact MCF 40A....-5A3			0015	0022	0030	0040	0055	0075	0110
Size			1			2			
Braking resistors	Trip current	Part number							
BW100-005	$I_F = 0.8 A_{RMS}$	826 269 1							
BW100-006	$I_F = 1.8 A_{RMS}$	821 701 7							
BW168	$I_F = 2.5 A_{RMS}$	820 604 X							
BW268	$I_F = 3.4 A_{RMS}$	820 715 1							
BW147	$I_F = 3.5 A_{RMS}$	820 713 5							
BW247	$I_F = 4.9 A_{RMS}$	820 714 3							
BW347	$I_F = 7.8 A_{RMS}$	820 798 4							
BW039-012	$I_F = 4.2 A_{RMS}$	821 689 4							
BW039-026	$I_F = 7.8 A_{RMS}$	821 690 8							
BW039-050	$I_F = 11 A_{RMS}$	821 691 6							
Line chokes		Part number							
ND020-013	$\Sigma I_{system} = 20 A_{AC}$	826 012 5							
ND045-013	$\Sigma I_{system} = 45 A_{AC}$	826 013 3							
Line filters		Part number							
NF008-443	$U_{max} = 440 V_{AC}$	825 721 3							
NF016-443		825 719 1					A		
NF025-443		825 718 3					B	A	
NF036-443		825 717 5						B	
NF008-503	$U_{max} = 550 V_{AC}$	825 831 7							
NF016-503		825 832 5					A		
NF025-503		825 833 3					B	A	
NF036-503		825 834 1						B	
Output chokes	Inside diameter	Part number							
HD001	$d = 50 \text{ mm (1.97 in)}$	813 325 5	For cable cross sections 1.5 – 16 mm ² (AWG16 – 6)						
HD002	$d = 23 \text{ mm (0.91 in)}$	813 557 6	For cable cross sections $\leq 1.5 \text{ mm}^2$ (AWG16)						
HD003	$d = 88 \text{ mm (4.46 in)}$	813 558 4	For cable cross sections $\geq 16 \text{ mm}^2$ (AWG6)						
Output filters		Part number							
HF015-503		826 030 3	A						
HF022-503		826 031 1	B	A					
HF030-503		826 032 X		B	A				
HF040-503		826 311 6			B	A			
HF055-503		826 312 4				B	A		
HF075-503		826 313 2					B	A	
HF023-403		825 784 1						B	A
HF033-403		825 785 X							B

A With rated operation (100 %)

B With variable torque load (125 %)



400/500 V units, sizes 3 – 5

MOVIDRIVE® compact MCF41A....-503			0150	0220	0300	0370	0450	0550	0750
Size			3			4		5	
Braking resistors	Trip current	Part number							
BW018-015	$I_F = 4.0 A_{RMS}$	821 684 3				C	C		
BW018-035	$I_F = 8.1 A_{RMS}$	821 685 1				C	C		
BW018-075	$I_F = 14 A_{RMS}$	821 686 X				C	C		
BW915	$I_F = 28 A_{RMS}$	821 260 0							
BW012-025	$I_F = 6.1 A_{RMS}$	821 680 0							
BW012-050	$I_F = 12 A_{RMS}$	821 681 9							
BW012-100	$I_F = 22 A_{RMS}$	821 682 7							
BW106	$I_F = 38 A_{RMS}$	821 050 0							
BW206	$I_F = 14 A_{RMS}$	821 051 9							
Line chokes		Part number							
ND045-013	$\Sigma I_{system} = 45 A_{AC}$	826 013 3		A					
ND085-013	$\Sigma I_{system} = 85 A_{AC}$	826 014 1		B			A		
ND1503	$\Sigma I_{system} = 150 A_{AC}$	825 548 2					B		
Line filters		Part number							
NF050-443	$U_{max} = 440 V_{AC}$	825 716 7	B	A					
NF080-443		825 830 9		B		A			
NF110-443		826 353 1				B		A	
NF050-503	$U_{max} = 550 V_{AC}$	825 835 X	B	A					
NF080-503		826 077 X		B		A			
NF110-503		826 354 X				B		A	
NF180-503		826 455 4						B	
Output chokes	Inside diameter	Part number							
HD001	d = 50 mm (1.97 in)	813 325 5	For cable cross sections 1.5 – 16 mm ² (AWG16 – 6)						
HD003	d = 88 mm (4.46 in)	813 558 4	For cable cross sections ≥ 16 mm ² (AWG6)						
Output filters		Part number							
HF033-403		825 785 X	A	B / D	A / D				
HF047-403		825 786 8	B	A	B / D	D	A / D		

- A With rated operation (100 %)
- B With variable torque load (125 %)
- C Connect two braking resistors in parallel!
- D Connect two output filters in parallel and set twice the trip current on F16!

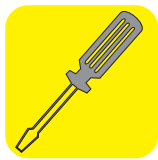

System bus (SBus) connection

Cable specification / Shield contact / Permitted cable length / Terminating resistor

3.15 System bus (SBus) connection

Max. 64 CAN bus stations can be interconnected using the system bus (SBus). The SBus supports transmission systems compliant with ISO 11898.

The "System Bus (SBus)" manual contains detailed information about the system bus. This manual can be obtained from SEW, publication number 0918 0907.

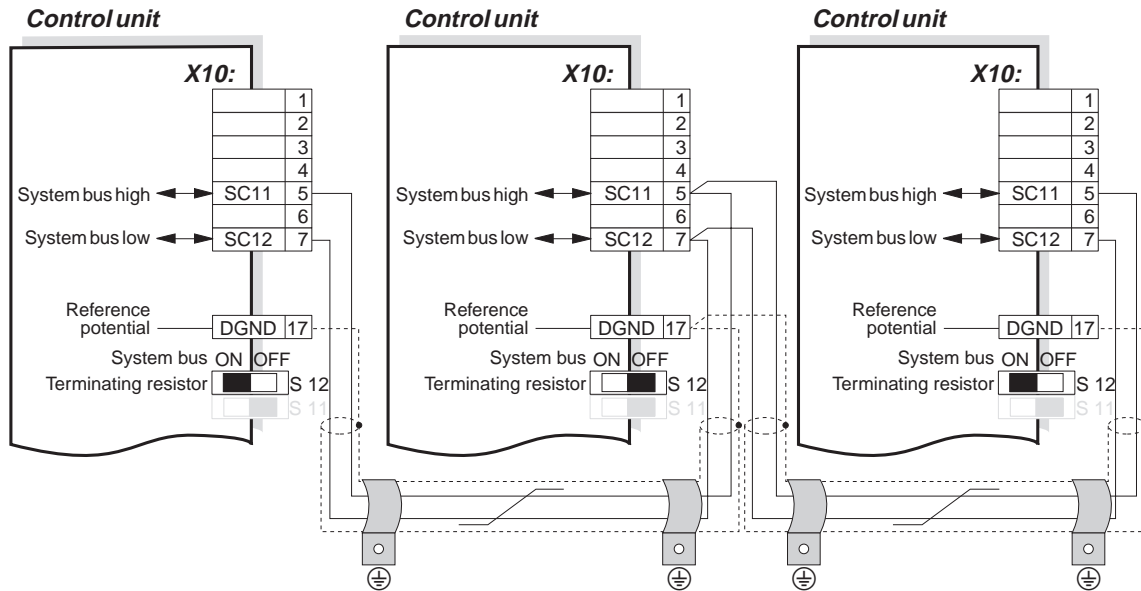

Fig 22: System bus connection

02411AEN

Cable specification

- Use a 2-core twisted and shielded copper cable (data transmission cable with shield comprising copper braiding). The cable must meet the following specifications:
 - Conductor cross section 0.75 mm^2 (AWG18)
 - Cable resistance 120Ω at 1 MHz
 - Capacitance per unit length $\leq 40 \text{ pF/m}$ (12 pF/ft) at 1 kHz
 Suitable cables are CAN bus or DeviceNet cables, for example.

Shield contact

- Connect the shield at either end to the electronics shield clamp of MOVIDRIVE[®] MCF41A or the master control and ensure the shield is connected over a large area. Also connect the ends of the shield to DGND.

Permitted total cable length

- The permitted total cable length depends on the baud rate setting of the SBus:

250 kbaud	→	160 m (528 ft)
500 kbaud	→	80 m (264 ft)
1000 kbaud	→	40 m (132 ft)

Terminating resistor

- Switch on the system bus terminating resistor (S12 = ON) at the start and finish of the system bus connection. Switch off the terminating resistor on the other units (S12 = OFF).
- There must not be any potential displacement between the units which are connected together using the SBus. Take suitable measures to avoid a potential displacement, e.g. by connecting the unit ground connectors using a separate lead.



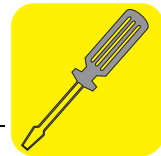

3.16 Connection option USS21A (RS-232 and RS-485)

(Part number 822 914 7)

RS-232 connection

9-pin standard interface cable (shielded!) for the RS-232 connection:

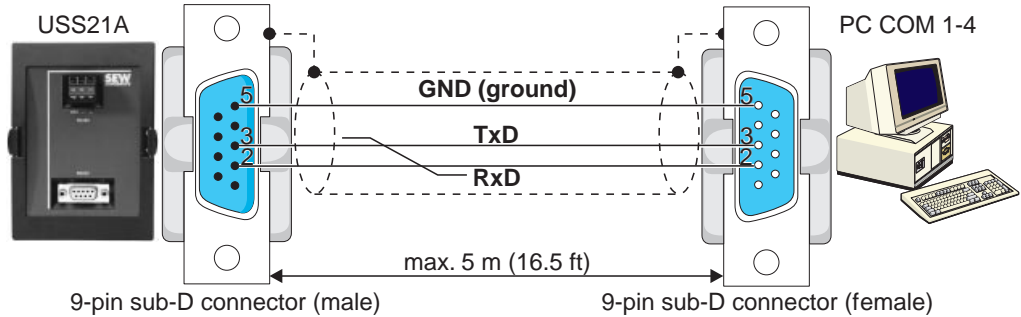

02399AEN

Fig. 23: Connection cable USS21A – PC

RS-485 connection

Connection recommendations for the RS-485 interface:

- Use a 4-core data cable with a copper braid shield.
- Twist the signal leads together in pairs.
- Route 0V5 along the second pair of leads as well.
- Connect the shield to PE potential at either end (electronics shield clamp of MOVIDRIVE® compact MCF41A or a suitable place in the switch cabinet). Ensure the shield is connected over a large area.

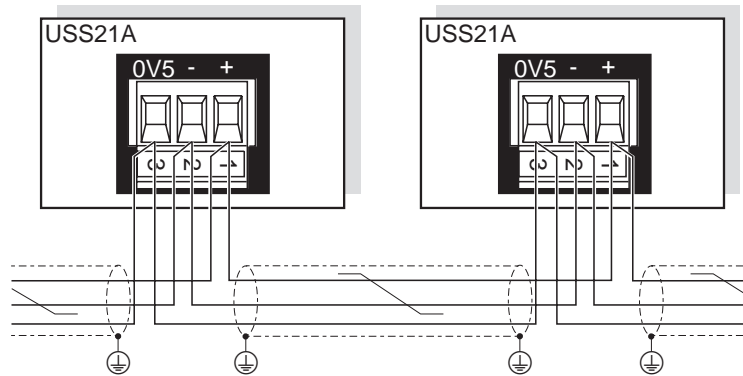

00997CXX

Fig. 24: RS-485 interface

USS21A terminal assignment:

- + ⇒ + RS-485
- ⇒ - RS-485
- 0V5 ⇒ Reference potential

Permitted line cross section:

- Single core → 0.20 – 1.5 mm² (AWG24 – 16)
- Double core → 0.20 – 1.0 mm² (AWG24 – 17)

RS-485 interface to EIA standard:

- Max. transmission rate 9600 baud
- Max. 32 participants (each unit with USS21A counts as 2 participants)
- Max. cable length 200 m (660 ft) in total
- Dynamic terminating resistor with fixed installation



General startup instructions

Pre-requisite / Inverter/motor combinations

4 Startup

4.1 General startup instructions



Pre-requisite

It is essential to comply with the safety notes during startup (→ Sec. 2, page 6).

Correct project planning of the drive is the pre-requisite for successful startup. Refer to the MOVIDRIVE[®] compact system manual for detailed project planning instructions and an explanation of the parameters (publication no.: 0918 2403).

MOVIDRIVE[®] compact drive inverters are factory set to be taken into operation with the SEW motor (MCF41A...-2_3: 4-pole and rated voltage $3 \times 230 V_{AC} / 60 \text{ Hz}$ or MCF41A...-5_3: 4-pole and rated voltage $3 \times 400 V_{AC} / 50 \text{ Hz}$) which is adapted to the correct power level. The motor can be connected and the drive started immediately in accordance with Sec. "PROFIBUS-DP startup" on page 39.

Inverter/motor combinations

The following tables indicate which inverter/motor combinations this applies to.

230 V units:

MOVIDRIVE [®] compact	SEW motor
MCF41A0015-2A3-4	DT90L4
MCF41A0022-2A3-4	DT100LS4
MCF41A0037-2A3-4	DT100L4
MCF41A0055-2A3-4	DV132S4
MCF41A0075-2A3-4	DV132M4
MCF41A0110-203-4	DV160M4

400/500 V units:

MOVIDRIVE [®] compact MCF41A	SEW motor
MCF41A0015-5A3-4	DT90L4
MCF41A0022-5A3-4	DT100LS4
MCF41A0030-5A3-4	DT100L4
MCF41A0040-5A3-4	DV112M4
MCF41A0055-5A3-4	DV132S4
MCF41A0075-5A3-4	DV132M4
MCF41A0110-5A3-4	DV160M4
MCF41A0150-503-4	DV160L4
MCF41A0220-503-4	DV180L4
MCF41A0300-503-4	DV200L4
MCF41A0370-503-4	DV225S4
MCF41A0450-503-4	DV225M4
MCF41A0550-503-4	D250M4
MCF41A0750-503-4	D280S4



The startup functions described in this section are used for setting the inverter so it is optimally adapted to the motor which is actually connected and to the given boundary conditions.



4.2 Preliminary work and tools

- Check the installation (→ Sec. 3, Installation).
- Take appropriate measures to prevent the motor from starting up inadvertently (e.g. connect tl. X10:9 /CONTROLLER INHIBIT to DGND). Furthermore, additional safety precautions must be taken depending on the application in order to avoid endangering people and machinery.
- For **startup with the DBG11A keypad**:
Connect the DBG11A keypad to the TERMINAL option slot.
- For **startup with a PC and MX_SHELL or MOVITOOLS**:
Connect the USS21A option to the TERMINAL option slot and use an interface cable (RS-232) to connect it to the PC. MOVIDRIVE® MCF41A and the PC must be de-energized when you do this, otherwise undefined states may be adopted. Then switch on both units. Install MX_SHELL or MOVITOOLS on the PC if you have not already done so. Start the program.
- Switch on the power system and, if necessary, the 24 V supply.
If you are using the DBG11A keypad, the following message appears for about 13 s:

```

SELFTEST
MOVIDRIVE

```

- Undertake the correct preliminary parameter setting (e.g. factory setting).
- Check the terminal assignment which has been set (→ P60_ / P61_).



Startup automatically changes a group of parameter values. The parameter description P700 "Operating modes" explains which parameters are affected by this. Refer to the MOVIDRIVE® *compact* system manual (publication number 0918 2403) for the parameter description.



Startup with the DBG11A keypad

General information / Startup functions of the DBG11A / Language change

4.3 Startup with the DBG11A keypad

General information

The following data are required for successful startup:

- Motor type (SEW motor or non-SEW motor)
- Motor data
 - Rated voltage and rated frequency.
 - In addition, with a non-SEW motor: Rated current, rated power, power factor $\cos\phi$ and rated speed.
- Rated supply system voltage

Startup functions of the DBG11A

Detailed description of the keypad → Sec. 5.1, page 64:

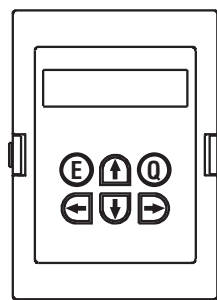

01406AXX

- ← + → at the same time: Commence startup.
- ↑ key: Next menu command or alter (increase) value in edit mode.
- ↓ key: Previous menu command or alter (decrease) value in edit mode.
- key: One menu level down or activate edit mode for the menu command.
- ← key: One menu level up or deactivate edit mode for the menu command.
- Q key: Cancel startup and return to main display.
- E key: Cancel startup and return to main display.

Language change on the DBG11A keypad

- The main display of the keypad is in German.
- Press the ↓ key twice to display parameter group 8...
- Press the → key twice and the ↑ key once to display parameter 801 (Language). Press the → key to activate edit mode. Press the ↓ or ↑ key to select the language you want and then press the ← key to exit edit mode.
- Press the Q key to return to the main display.

```
CONTROL . INHIBIT
CURRENT:          0 A
```

```
8. . UNIT
      FUNCTIONS
```

```
801 DEUTSCH
      LANGUAGE
```



Structure of the startup menu

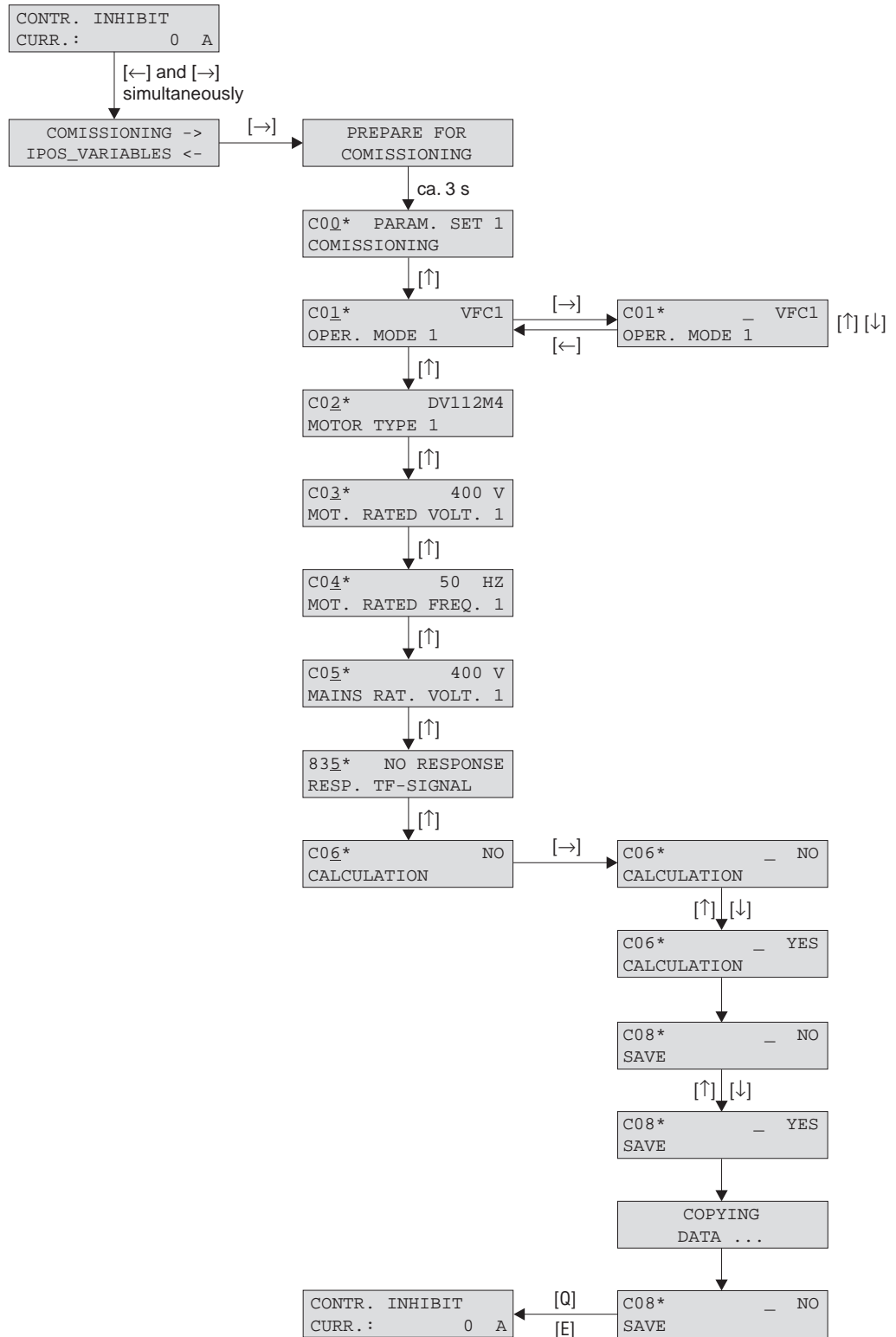

02400AEN

Fig. 25: Structure of the startup menu



Startup with the DBG11A keypad

Startup procedure

Startup procedure

1. "0" signal at terminal X10:9 (DIØØ "Controller inhibit").

```
CONTROL . INHIBIT
CURRENT:          0 A
```

2. Activate the startup menu by pressing the ← and → keys on the DBG11A at the same time.

```
STARTUP ->
IPOS_VARIABLE <-
```

3. Press the → key to commence the startup. The first window of the startup menu appears. The menu commands are identified by an * in the 4th position. Menu commands which only appear in the startup menu start with C, the other menu commands have the number in the parameter list (Sec. 4.8). Press the ↑ key to jump to the next menu command when you have worked through a menu command.

```
STARTUP IS
BEING PREPARED
```

4. Select a parameter set, e.g. parameter set 1.

```
C00*   PARAM. SET 1
STARTUP
```

5. Set the operating mode, e.g. VFC1

```
C01*           VFC1
OPER. MODE 1
```

6. Select the motor which is connected. If a 2 or 4-pole SEW motor is connected, select the correct motor from the list. In the case of a non-SEW motor or an SEW motor with more than four poles, choose NON-SEW MOTOR in the selection list.

```
C02*           DV112M4
MOT. TYPE 1
```

```
C02*   NON-SEW MOTOR
MOT. TYPE 1
```

7. Refer to the rating plate of the motor and enter the rated motor voltage for the selected connection type.

```
C03*           400 V
RATED MOT. VOLT. 1
```

Example: Rating plate 230Δ/400Υ 50 Hz
 Δ connection, 50 Hz characteristic curve → Enter 230 V
 Δ connection, 87 Hz characteristic curve → Enter 400 V
 Υ connection → Enter 400 V

Example: Rating plate 400Δ/690Υ 50 Hz
 Only Δ connection possible → Enter 400 V
 Υ connection is not possible.

8. Enter the rated frequency specified on the motor rating plate. However, in the case of the 87 Hz characteristic curve, set 87 Hz and the maximum speed 1 (P302) is automatically set correctly.

```
C04*           50 HZ
RATED MOT. FREQ. 1
```

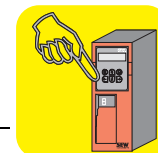

WITH SEW MOTORS

9. These values are stored for SEW 2 and 4-pole motors and do not have to be entered.

10. Enter the rated voltage of the supply system

C05* 400 V
RATED SYS. VOLT. 1

11. Set NO RESP. if no TF/TH is connected to X10:6 (AI21). Set the required fault response if a TF/TH is connected to X10:6 (AI21).

835* NO RESP.
RESP. TF MESSAGE

12. Commence the startup calculation by selecting YES.

C06* NO
CALCULATION

13. The calculation is performed (SEW motor).

13. The calculation for non-SEW motors requires a calibration procedure.

- When prompted, give a “1” signal on terminal X10:9 (DIØØ “/Controller inhibit”).
- Give a “0” signal on terminal X10:9 again after the calibration is complete.
- The motor parameters are estimated if motor cannot be calibrated (energized).

14. The SAVE menu command appears automatically. The keypad is already in edit mode.

C08* NO
SAVE

15. Set SAVE to YES with ↑. The data (motor parameters) are copied into the non-volatile memory of MOVIDRIVE® compact MCF41A.

DATA ARE BEING
COPIED...

16. This completes the startup. Press the E or Q key to exit the startup menu. The main display then appears.

C08* NO
SAVE

CONTROL . INHIBIT
CURRENT : 0 A

Recommendation

- Copy the parameter set from MOVIDRIVE® compact into the DBG11A keypad after completing the startup (P807 “MDX → DBG”). In this way, it is possible to use the DBG11A to transfer the parameter set to other MOVIDRIVE® compact units (P806 “DBG → MDX”).
- Enter any parameter settings which differ from the factory settings in the parameter list (→ Sec. 4.8).
- In the case of non-SEW motors, set the correct brake reaction time (P732 / P735).
- Perform the startup routine for PROFIBUS-DP (→ Sec. 4.6, page 39).



Startup with a PC and MX_SHELL

General information / Operating mode VFC1 / With SEW motors

4.4 Startup with a PC and MX_SHELL

General information

Refer to the MX_SHELL manual for information about how to use the MX_SHELL PC program. Press <F1> to call up explanations of the startup settings.

- Terminal X10:9 (DIØØ “/Controller inhibit”) must get a “0” signal!
- In MX_SHELL, use the [Communication] / [PC-interface] menu command to select the interface to which MOVIDRIVE® MCF41A is connected.
- In MX_SHELL, use the [Communication] / [Change address] menu command to set the POINT-TO-POINT inverter address.
- The connected inverter type must be displayed in the status bar.
- The status bar must display ONLINE, POINT-TO-POINT and CONTROLLER INHIBIT or 24 V operation.
- In MX_SHELL, select the [Parameter] / [Startup] menu command.
- Select “Startup parameter set 1” from the list.

Operating mode VFC1

1. Select the type of AC motor from the list:
“Asynchronous” = all DT, DV, D motors and, possibly, non-SEW motors.
2. Select “VFC1” operating mode from the list.
3. Select the connected motor: SEW motor or non-SEW motor.
Enter the information for SEW motors not in the list in the same way as for non-SEW motors.

With SEW motors

4. The startup/commissioning window appears (without user parameters). Enter the correct values there (motor nameplate).

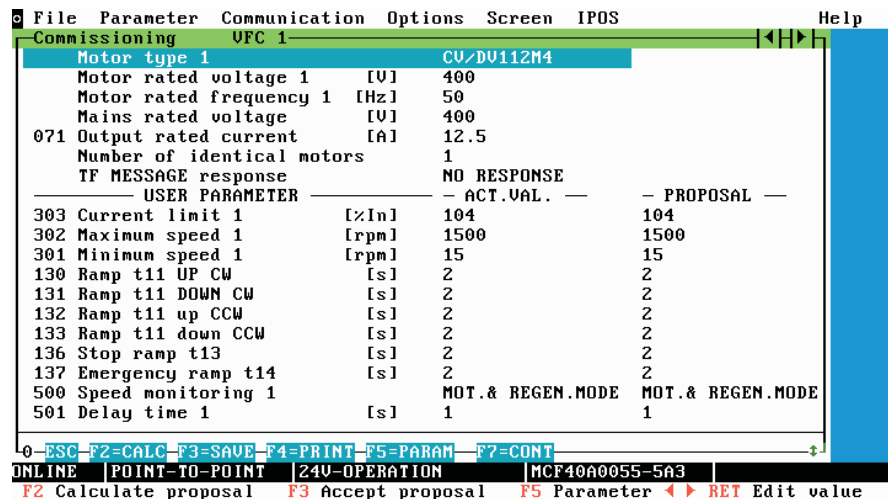

02402AEN

Fig. 26: Startup window for an SEW motor with user parameters

5. Press <F2=CALC> to calculate the startup.
6. Press <F5=PARAM> to display the user parameters. In this window, it is possible to set extra parameters required for the startup. This can be done in the ACT. VAL column. Changes to parameters take effect immediately. The PROPOSAL column lists the parameter values calculated using <F2=CALC>. Press <F3=SAVE> to overwrite the ACT. VAL. data with the values in the PROPOSAL column and to have the information loaded into the inverter.
7. Press <F7=CONT> to complete the startup.



With non-SEW motors

- The startup/commissioning window appears (without user parameters). Enter the correct values there (motor nameplate).

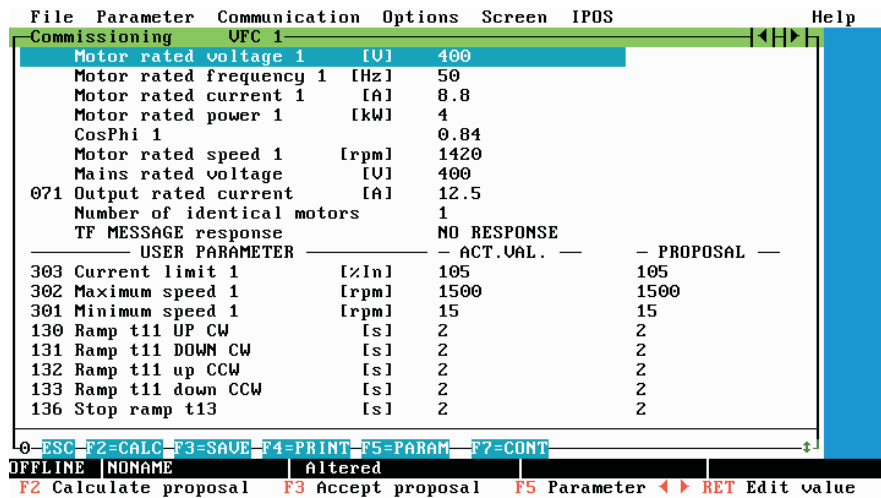

02403AEN

Fig. 27: Startup window for non-SEW motor with user parameters

- Press <F2=CALC> to calculate the startup. The motor has to be calibrated to do this. When prompted, give a "1" signal on terminal X10:9 (DIØØ "/Controller inhibit").
- Give a "0" signal on terminal X10:9 again after the calibration is complete.
- Press <F5=PARAM> to display the user parameters. In this window, it is possible to set extra parameters required for the startup. This can be done in the ACT. VAL column. Changes to parameters take effect immediately. The PROPOSAL column lists the parameter values calculated using <F2=CALC>. Press <F3=SAVE> to overwrite the ACT. VAL. data with the values in the PROPOSAL column and to have the information loaded into the inverter.
- Press <F7=CONT> to complete the startup.

Recommendation

- Save the parameter set using the [File] / [Save to new file] menu command. The parameter set can be transferred to other MOVIDRIVE® units using [File] / [Load file] and [File] / [Save to inverter].
- Print out the set parameters using [File] / [Print].
- In the case of non-SEW motors, set the correct brake reaction time (P732 / P735).
- Perform the startup routine for PROFIBUS-DP (→ Sec. 4.6, page 39).



Startup with PC and MOVITOOLS (from version 2.20)

General information / Commencing startup

4.5 Startup with PC and MOVITOOLS (from version 2.20)

General information

- Terminal X10:9 (DIØØ “/Controller inhibit”) must get a “0” signal!
- Start the MOVITOOLS program.
- Set the language.
- Select the PC port (PC COM) to which the inverter is connected.
- Select <Update> to display the connected inverter.

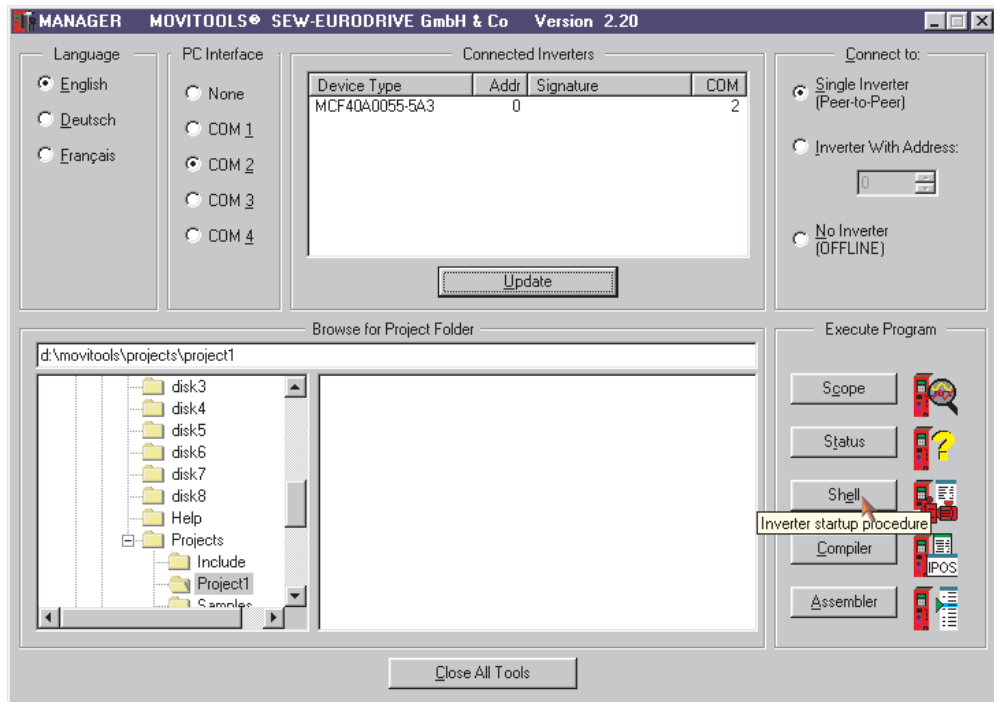

Fig. 28: MOVITOOLS startup window

02901AEN

Commencing startup

- Click on <Shell> in “Run Program”. The Shell program is started.
- Select the “Startup” function.
- Select asynchronous as the motor type.
- Select parameter set 1 or 2.
- Set the operating mode.
- Select an SEW motor (2 or 4-pole) or a non-SEW motor. SEW motors with more than four poles must be set as non-SEW motors.
- Enter the motor type data.
- Press <Finish> to complete the startup.
- Make any necessary parameter settings using the main menu or the user menu.
- Save the parameter set. The parameter set can be transferred to other MOVIDRIVE® compact units.
- Print out the set parameters using [File] / [Print Unit Data].
- Perform the startup routine for PROFIBUS-DP (→ Sec. 4.6, page 39).



4.6 PROFIBUS-DP startup

DP master

- Refer to the instructions in the README.TXT file on the GSD diskette.
- Install the GSD file "SEW_6002.GSD" according to the instructions of the project planning software for the DP master. After installation, the MOVIDRIVE[®] compact unit appears in the list of slave stations.
- Add the interface module under the name "MOVIDRIVE[®] compact" into the PROFIBUS structure and assign the station address.
- Select the process data configuration required for your application (→ Sec. 4.9, page 47).
- Enter the I/O or periphery addresses for the data widths in the project planning.

Inverter

Provided you have performed the startup as described in the previous chapters, you can set the parameters of the encoder and control it directly via PROFIBUS-DP. Proceed as follows to do this:

- Switch on the 24 V voltage supply on X10:24 (VI24) and switch off the system supply on L1, L2 and L3. You can now set the parameters of the inverter without the motor starting up inadvertently.
- Set parameters P100 "Setpoint source" and P101 "Control signal source" to FIELD-BUS.
P100 "Setpoint source" = FIELDBUS
P101 "Control signal source" = FIELDBUS
The inverter now reacts to the process output data sent by the PROFIBUS master.
- Set binary inputs DIØ1, DIØ2 and DIØ3 to NO FUNCTION.
P600 "Binary input DIØ1" = NO FUNCTION
P601 "Binary input DIØ2" = NO FUNCTION
P602 "Binary input DIØ3" = NO FUNCTION
- Terminal X10:9 (DIØØ "/Controller inhibit") must get a "1" signal! For safety reasons, the inverter must also be enabled using the terminals in fieldbus operation. You can stop the inverter independently of the fieldbus by means of a "0" signal at X10:9 (DIØØ "/Controller inhibit").
- Check the parameter settings.
- Switch on the system voltage on L1, L2 and L3. The motor then starts according to the parameter setting and the process output data of the PROFIBUS master.



4.7 Manual mode

The inverter can be controlled using the DBG11A keypad using the manual operation function. In order for manual operation to be started, there must be a “0” signal sent to binary inputs X10:10 (DIØ1) CW/stop, X10:11 (DIØ2) CCW/stop and X10:12 (DIØ3) Enable/rapid stop, if programmed. The binary inputs are then without any functions for the duration of manual operation, with the exception of X10:9 (DIØØ) /Controller inhibit. Binary input X10:9 (DIØØ) /Controller inhibit must get a “1” signal to enable the drive to be started in manual operation. The drive can also be stopped in manual operation by X10:9 = “0”.

The direction of rotation is not determined by the “CW/stop” or “CCW/stop” binary inputs. Instead, you select the direction of rotation using the keypad (→ Fig. 29).

Manual mode remains active even after the supply system power has been switched off/on. The inverter is then inhibited, however. A change of direction command using the → or ← key produces an enable and a start in the selected sense of rotation at n_{\min} . The speed is increased and decreased using the ↑ and ↓ keys. The modification speed is 150 rpm per second.

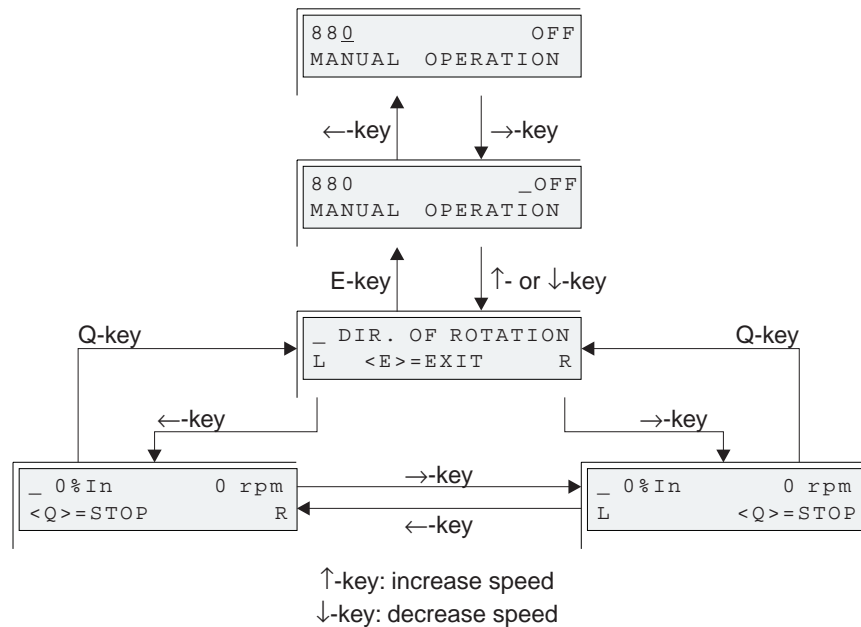

Fig. 29: Manual mode with DBG11A

02406AEN



Important:

The signals at the binary inputs take effect as soon as manual operation is finished. Binary input X10:9 (DIØØ) /Controller inhibit does not have to be switched from “1” to “0” and back to “1”. The drive can start according to the signals at the binary inputs and the setpoint sources.



4.8 Parameter list

The quick menu parameters (→ page 67) are identified with /.

Par.	Name	Value range	Par.	Name	Value range
0__	DISPLAY VALUES		03_	Binary inputs basic unit	
00_	Process values		030	Binary input DI00	/CONTROL.INHIBIT
000	Speed	-5000...0...5000 rpm	031	Binary input DI01	
001/	User display	[Text]	032	Binary input DI02	
002	Frequency	0...400 Hz	033	Binary input DI03	
003	Actual position	0...±2 ³¹ -1 inc	034	Binary input DI04	
004	Output current	0...200 % I _N	035	Binary input DI05	
005	Active current	-200...0...200 % I _N	036/	Status binary inputs basic unit	
006/	Motor utilization 1	0...200 %	05_	Binary outputs basic unit	
007	Motor utilization 2	0...200 %	050	Binary output DB00	/BRAKE
008	DC link voltage	0...1000 V	051	Binary output DO01	
009	Output current	A	052	Binary output DO02	
01_	Status displays		053/	Status binary outputs basic unit	
010	Inverter status		07_	Unit data	
011	Operational status		070	Unit type	
012	Fault status		071	Unit rated current	
013	Active parameter set	1/2	076	Firmware basic unit	
014	Heat sink temperature	-20...0...100 °C	077	Firmware DBG11A	Only in DBG11A
015	Mains ON operating time	0...25000 h	08_	Fault memory	
016	Operating time (enabled)	0...25000 h	080/	Fault t-0	
017	Electrical energy	kWh	081	Fault t-1	
02_	Analog setpoints		082	Fault t-2	
021	Analog input AI2	0...10 V	083	Fault t-3	
022	External current limit	0...100 %	09_	Bus diagnosis	
			090	PD configuration	
			091	Fieldbus type	
			092	Fieldbus baud rate	
			093	Fieldbus address	
			094	PO1 setpoint	
			095	PO2 setpoint	
			096	PO3 setpoint	
			097	PI1 actual value	
			098	PI2 actual value	
			099	PI3 actual value	



Parameter list

1__ Setpoints/ramp generators

Par.	Name	Setting range Factory setting	After startup	Par.	Name	Setting range Factory setting	After startup
	Variable par. Parameter set 1				Parameter set 2		
1__ SETPOINTS / RAMP GENERATORS							
10_ Setpoint selection							
100/	Setpoint source	BIPOL./FIXED / UNIPOL./FIXED / FIELDBUS / MOTOR POT. / MOTPOT. + AI1 / FIXED + AI1 / FIXED x AI1 / MASTER SBus / SBus					
101	Control signal source	TERMINALS / FIELDBUS / SBus					
12_ Analog input AI2							
120	AI2 operation mode	NO FUNCT. / 0...10V+INP1 / 10V EXT I-GR / TF SENSOR					
13_ Speed ramps 1				14_ Speed ramps 2			
130/	Ramp t11 UP CW	0... 2 ...2000 s		140	Ramp t21 UP CW	0... 2 ...2000 s	
131/	Ramp t11 DOWN CW	0... 2 ...2000 s		141	Ramp t21 DOWN CW	0... 2 ...2000 s	
132/	Ramp t11 UP CCW	0... 2 ...2000 s		142	Ramp t21 UP CCW	0... 2 ...2000 s	
133/	Ramp t11 DOWN CCW	0... 2 ...2000 s		143	Ramp t21 DOWN CCW	0... 2 ...2000 s	
134/	Ramp t12 UP=DOWN	0... 10 ...2000 s		144	Ramp t22 UP=DOWN	0... 10 ...2000 s	
135	S pattern t12	0 ...3		145	S pattern t22	0 ...3	
136/	Stop ramp t13	0... 2 ...20 s		146	Stop ramp t23	0... 2 ...20 s	
137/	Emergency ramp t14	0... 2 ...20 s		147	Emergency ramp t24	0... 2 ...20 s	
15_ Motor potentiometer (parameter set 1 and 2)							
150	Ramp t3 UP	0.2... 20 ...50 s					
151	Ramp t3 DOWN	0.2... 20 ...50 s					
152	Save last setpoint	ON / OFF					
16_ Fixed setpoints 1				17_ Fixed setpoints 2			
160/	Internal setpoint n11	-5000...0... 150 ...5000 rpm		170	Internal setpoint n21	-5000...0... 150 ...5000 rpm	
161/	Internal setpoint n12	-5000...0... 750 ...5000 rpm		171	Internal setpoint n22	-5000...0... 750 ...5000 rpm	
162/	Internal setpoint n13	-5000...0... 1500 ...5000 rpm		172	Internal setpoint n23	-5000...0... 1500 ...5000 rpm	

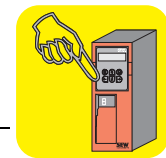

Par.	Name	Setting range Factory setting	After startup	Par.	Name	Setting range Factory setting	After startup
	Variable par. Parameter set 1				Parameter set 2		
3__ MOTOR PARAMETERS							
30_ Limits 1				31_ Limits 2			
300/	Start/stop speed 1	0... 60 ...150 rpm		310	Start/stop speed 2	0... 60 ...150 rpm	
301/	Minimum speed 1	0..... 605500 rpm		311	Minimum speed 2	0... 60 ...5500 rpm	
302/	Maximum speed 1	0... 1500 ...5500 rpm		312	Maximum speed 2	0... 1500 ...5500 rpm	
303/	Current limit 1	0... 150 %I _N		313	Current limit 2	0... 150 %I _N	
32_ Motor compensat. 1 (asynchr.)				33_ Motor compensat. 2 (asynchr.)			
320/	Automatic adjust- ment 1	ON / OFF		330	Automatic adjust- ment 2	ON / OFF	
321	Boost 1	0 ...100 %		331	Boost 2	0 ...100 %	
322	IxR compensation 1	0 ...100 %		332	IxR compensation 2	0 ...100 %	
323	Premagnetizing time 1	0... 0.1 ...2 s		333	Premagnetizing time 2	0... 0.1 ...2 s	
324	Slip compensation 1	0 ...500 rpm		334	Slip compensation 2	0 ...500 rpm	
34_ Motor protection							
340	Motor protection 1	ON / OFF		342	Motor protection 2	ON / OFF	
341	Cooling type 1	SELF-VENTILATION / FORCED-COOLING		343	Cooling type 2	SELF-VENTILATION / FORCED-COOLING	
35_ Motor sense of rotation							
350	Change direction of rotation 1	ON / OFF		351	Change direction of rotation 2	ON / OFF	
360	Startup	YES / NO		Only available in DBG11A, not in MX_SHELL!			
4__ REFERENCE SIGNALS							
40_ Speed reference signal							
400	Speed ref. value	0... 1500 ...5000 rpm					
401	Hysteresis	0... 100 ...500 rpm					
402	Delay time	0... 1 ...9 s					
403	Signal = "1" if:	n < n _{ref} / n > n _{ref}					
41_ Speed window signal							
410	Window center	0... 1500 ...5000 rpm					
411	Range width	0 ...5000 rpm					
412	Delay time	0... 1 ...9 s					
413	Signal = "1" if:	INSIDE / OUTSIDE					
42_ Speed setp./act. val. comp.							
420	Hysteresis	1... 100 ...300 rpm					
421	Delay time	0... 1 ...9 s					
422	Signal = "1" if:	n <> n _{set} / n = n _{set}					
43_ Current reference signal							
430	Current reference value	0... 100 ...150 %I _N					
431	Hysteresis	0... 5 ...30 %I _N					
432	Delay time	0... 1 ...9 s					
433	Signal = "1" if:	I < I _{ref} / I > I _{ref}					
44_ I_{max} signal							
440	Hysteresis	0... 5 ...50 %I _N					
441	Delay time	0... 1 ...9 s					
442	Signal = "1" if:	I = I _{max} / I < I _{max}					



Parameter list

5__ Monitoring functions / 6__ Terminal assignment

Par.	Name	Setting range Factory setting	After startup	Par.	Name	Setting range Factory setting	After startup
	Variable par. Parameter set 1				Parameter set 2		
5__ MONITORING FUNCTIONS							
50_ Speed monitoring							
500	Speed monitoring 1	OFF MOTOR MODE REGENERAT. MODE MOT.& REGEN.MODE		502	Speed monitoring 2	OFF MOTOR MODE REGENERAT. MODE MOT.& REGEN.MODE	
501	Delay time 1	0...1...10 s		503	Delay time 2	0...1...10 s	
52_ Mains OFF monitoring							
520	Mains OFF response time	0...5 s					
521	Mains OFF response	/CONTROL.INHIBIT EMERGENCY STOP					
6__ TERMINAL ASSIGNMENT							
60_ Binary inputs basic unit							
-	Binary input DI00	With fixed assignment: /CON- TROL.INHIBIT					
600	Binary input DI01	CW/STOP		The following functions can be programmed: NO FUNCTION • ENABLE/RAP. STOP • CW/STOP • CCW/STOP • n11(n13) • n21(n23) • n12(n13) • n22(n23) • FIX SETP SELECT • PAR. SWITCHOVER • RAMP SELECTION • MOTOR POT UP • MOTOR POT DOWN • /EXT. FAULT • FAULT RESET • /LIM. SWITCH CW • /LIM. SWITCH CCW SETPOINT TAKE OVER • MAINS ON •			
601	Binary input DI02	CCW/STOP					
602	Binary input DI03	ENABLE/RAP. STOP					
603	Binary input DI04	n11/n21					
604	Binary input DI05	n12/n22					
62_ Binary outputs basic unit							
-	Binary output DB00	With fixed assignment: /BRAKE					
620	Binary output DO01	READY		The following signals can be programmed: NO FUNCTION • /FAULT • READY • OUTP. STAGE ON • ROT. FIELD ON • BRAKE RELEASED • BRAKE APPLIED • MOTOR STANDSTILL • PARAMETER SET • SPEED REFERENCE • SPEED WINDOW • SP/ACT.VAL.COMP. • CURR. REFERENCE • I _{max} -SIGNAL • /UTILIZATION 1 • /UTILIZATION 2 •			
621	Binary output DO02	NO FUNCTION					
64_ Analog output							
640	Analog output AO1	ACTUAL SPEED		The following functions can be programmed: NO FUNCTION • RAMP INPUT • SPEED SETPOINT • ACTUAL SPEED • ACTUAL FREQUENCY • OUTPUT CURRENT • ACTIVE CURRENT • UTILIZATION			
641	Scaling AO1	-10...0...1...10					
642	Operating mode A01	OFF / 0...20 mA / 4...20 mA					

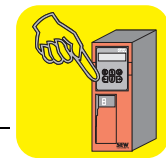

Par.	Name	Setting range Factory setting	After startup	Par.	Name	Setting range Factory setting	After startup
	Variable par. Parameter set 1				Parameter set 2		
7__ CONTROL FUNCTIONS							
70_ Operating modes							
700	Operating mode 1	VFC 1 VFC 1 & GROUP VFC 1 & HOIST VFC 1 & DC BRAK. VFC 1 & FLY.START		701	Operating mode 2	VFC 2 VFC 2 & GROUP VFC 2 & HOIST VFC 2 & DC BRAK. VFC 2 & FLY.START	
71_ Current at standstill							
710	Standstill current 1	0...50 %I _{mot}		711	Standstill current 2	0...50 %I _{mot}	
72_ Setpoint stop function							
720	Setpoint stop function 1	ON / OFF		723	Setpoint stop function 2	ON / OFF	
721	Stop setpoint 1	0...30...500 rpm		724	Stop setpoint 2	0...30...500 rpm	
722	Start offset 1	0...30...500 rpm		725	Start offset 2	0...30...500 rpm	
73_ Brake function							
730	Brake function 1	ON / OFF		733	Brake function 2	ON / OFF	
731	Brake release time 1	0...2 s		734	Brake release time 2	0...2 s	
732	Brake application time 1	0...0.2...2 s		735	Brake application time 2	0...0.2...2 s	
74_ Speed skip							
740	Skip window center 1	0...1500...5000 rpm		742	Skip window center 2	0...1500...5000 rpm	
741	Skip width 1	0...300 rpm		743	Skip width 2	0...300 rpm	
75_ Master-Slave function							
750	Slave setpoint	MASTER-SLAVE OFF SPEED (SBus) LOAD DIV. (SBus)					
751	Scaling slave setpoint	-10...0...1...10					
8__ UNIT FUNCTIONS							
80_ Setup							
802/	Factory setting	YES / NO					
803/	Parameter lock	ON / OFF					
804	Reset statistic data	NO FAULT MEMORY KWH METER OPERATING HOURS					
800/	Quick menu	ON / OFF		These parameters are only available in the DBG11A keypad, not in MX_SHELL			
801/	Language	DE / EN / FR					
806	Copy DBG→MDX	YES / NO					
807	Copy MDX→DBG	YES / NO					



Parameter list

8__ Unit functions

Par.	Name	Setting range Factory setting	After startup	Par.	Name	Setting range Factory setting	After startup
	Variable par. Parameter set 1				Parameter set 2		
81_	Serial communication						
810	RS-485 address	0...99					
811	RS-485 group addr.	100...199					
812	RS-485 timeout delay	0...650 s					
813	SBus address	0...63					
814	SBus group address	0...63					
815	SBus timeout delay	0...0.1...650 s					
816	SBus baud rate	125/250/500/1000 kbaud					
817	CAN synchron. ID	0...1023					
819	Fieldbus timeout delay	0...0.5...650 s					
82_	Brake operation						
820/	4-Q operation 1	ON / OFF		821	4-Q operation 2	ON / OFF	
83_	Fault response						
830	Response EXT. FAULT	EMERG. STOP/ FAULT		The following fault responses can be programmed: NO RESPONSE DISPLAY FAULT IMM. STOP/FAULT EMERG. STOP/FAULT RAPID STOP/FAULT IMM. STOP/WARN. EMERG. STOP/WARN. RAPID STOP/WARN.			
831	Fieldbus timeout response	RAPID STOP/WARN.					
832	MOTOR OVERLOAD response	EMERG. STOP/ FAULT					
833	RS-485 TIMEOUT response	RAPID STOP/WARN.					
835/	TF SIGNAL response	NO RESPONSE					
836	SBus TIMEOUT response	EMERG. STOP/ FAULT					
84_	Reset response						
840/	Manual reset	YES / NO					
841	Auto reset	ON / OFF					
842	Restart time	1...3...30 s					
85_	Scaling speed actual value						
850	Scaling factor numerator	1...65535					
851	Scaling factor denominator	1...65535					
852	User dimension	rpm		Can only be set using MX_SHELL			
86_	Modulation						
860	PWM frequency 1	4/8/12/16 kHz		861	PWM frequency 2	4/8/12/16 kHz	
862	PWM fix 1	ON / OFF		863	PWM fix 2	ON / OFF	
87_	Process data description						
870	Setpoint descr. PO1	CTRL. WORD 1					
871	Setpoint descr. PO2	SPEED					
872	Setpoint descr. PO3	NO FUNCT.					
873	Actual value descr. PI1	STATUS WORD 1					
874	Actual value descr. PI2	SPEED					
875	Actual value descr. PI3	OUTPUT CURRENT					
876	PO data enable	ON / OFF					
88_	Manual mode						
880	Manual mode	ON / OFF					



4.9 Configuring the PROFIBUS-DP interface

General information

It is necessary for the DP master to send the drive inverter a certain DP configuration in order to be able to define the type and number of input and output data used for transfer. In doing this, you have the opportunity to

- control the drive using process data
- read and write all drive parameters using the parameter channel.

Fig. 30 shows a schematic of the data exchange between the programmable controller (DP master) and the MOVIDRIVE® drive inverter (DP slave) with the process data and parameter channel.

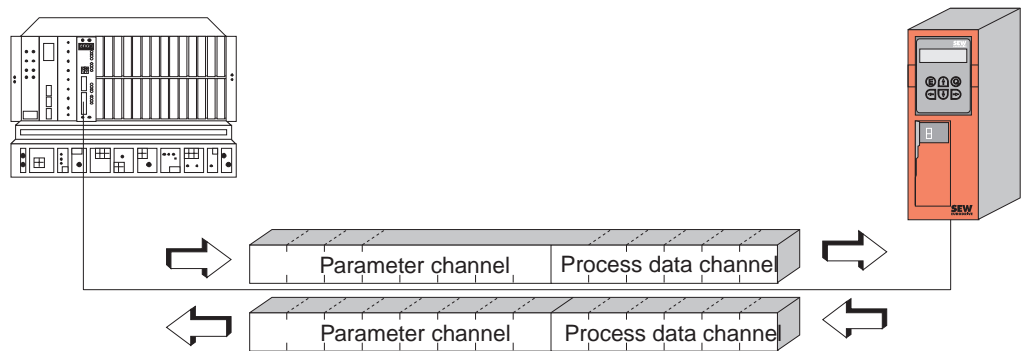

01065BEN

Fig. 30: Communication via PROFIBUS-DP

Process data configuration

MOVIDRIVE® compact drive inverters make it possible to have different DP configurations for exchanging data between the DP master and the inverter. The following table provides additional information about all possible DP configurations for the MOVIDRIVE compact range. The “Process data configuration” column lists the names of the configurations. These texts also appear as a selection list in your project planning software for the DP master. The DP configurations column shows which configuration data are sent to the inverter when the PROFIBUS-DP connection is being established.

Process data configuration	Meaning / information	DP configurations	
		0	1
1 PD	Control by 1 process data word	240 _{dec}	-
2 PD	Control by 2 process data words	241 _{dec}	-
3 PD	Control by 3 process data words	242 _{dec}	-
6 PD	Control by 6 process data words (PD4 – PD6 cannot be used with MCF41A)	0 _{dec}	245 _{dec}
10 PD	Control by 10 process data words (PD4 – PD10 cannot be used with MCF41A)	0 _{dec}	249 _{dec}
Param + 1 PD	Control by 1 process data word Parameter setting using 8-byte parameter channel	243 _{dec}	240 _{dec}
Param + 2 PD	Control by 2 process data words Parameter setting using 8-byte parameter channel	243 _{dec}	241 _{dec}
Param + 3 PD	Control by 3 process data words Parameter setting using 8-byte parameter channel	243 _{dec}	242 _{dec}
Param + 6 PD	Control by 6 process data words Parameter setting using 8-byte parameter channel (PD4 – PD10 cannot be used with MCF41A)	243 _{dec}	245 _{dec}
Param + 10 PD	Control by 10 process data words Parameter setting using 8-byte parameter channel (PD4 – PD10 cannot be used with MCF41A)	243 _{dec}	249 _{dec}
Universal configuration	Reserved for special configurations (See chapter)	0 _{dec}	0 _{dec}



4.10 External diagnosis

For MOVIDRIVE[®] compact, it is possible to activate automatic generation of external diagnostic alarms via PROFIBUS-DP during the project planning in the DP master. If this function has been activated, MOVIDRIVE[®] compact sends an external diagnostic signal to the DP master every time a malfunction occurs. It is then necessary to program corresponding algorithms in the program of the DP master system in order to evaluate the diagnostic information. These algorithms can sometimes be quite complex.

Recommendation It is basically not necessary to activate the external diagnostic function because MOVIDRIVE[®] compact transmits the current drive status in status word 1 during every PROFIBUS-DP cycle.

Note regarding Simatic S7 master systems Diagnostic alarms may be triggered by the PROFIBUS-DP system in the DP master at any time even when external diagnostic signal generation is inactive. This means the corresponding operation blocks (e.g. OB84 for S7-400 or OB82 for S7-300) should always be created in the controller.

Activation procedure Additional application-specific parameters can be defined in every DP master during the configuration of a DP slave. These parameters are transferred to the slave when the PROFIBUS-DP starts up. Ten application-specific parameter data items are provided for MOVIDRIVE[®] compact. Their functions are as follows:

Byte	Permitted value	Function
0	00 hex	Reserved
1	00 hex 01 hex	MOVIDRIVE [®] compact generates diagnostic alarm due to a malfunction. MOVIDRIVE [®] compact does not generate diagnostic alarm due to a malfunction (factory setting in the GSD file).
2 – 9	00 hex	Reserved

No unlisted values are permitted. They can lead to malfunctions!

Project planning example: The project planning programs of the DP master systems either offer the option of activating the external diagnosis in plain text format, such as with STEP7, or of stating the information directly in hex code.

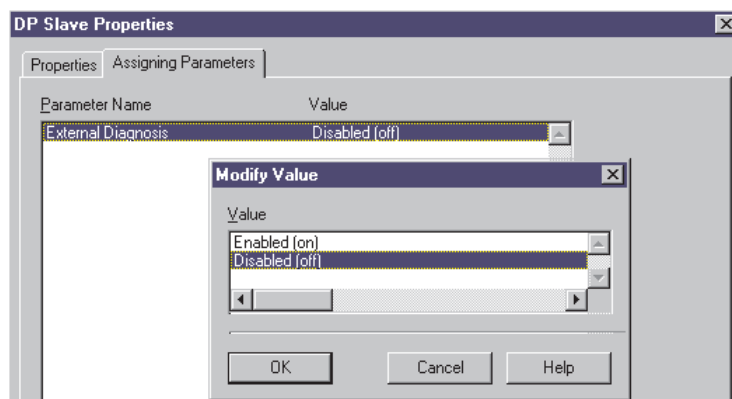

02903AEN

Fig. 32: Activating external diagnosis with STEP7

Hex code for activating external diagnosis generation:

Parameteriz. data (hex)	Function
00,00,00,00,00,00,00,00,00,00,	Diagnostic alarms are also generated if there is a fault (enabled = on)
00,01,00,00,00,00,00,00,00,00,	Diagnostic alarms are not generated if there is a fault (disabled = off, factory setting in the GSD file)



Slave diagnostic data

Recommendation / Note regarding Simatic S7 / Procedure / Example

4.11 Slave diagnostic data

MOVIDRIVE[®] compact drive inverters signal all faults which occur to the DP master via the diagnostic channel of the PROFIBUS-DP when external diagnosis generation is active. These fault messages can then be evaluated within the controller by means of corresponding system functions (e.g. with the diagnosis alarm OB 84 / SFC 13 in the S7-400). Fig. 33 shows the structure of the diagnostic data which are made up of diagnostic information to EN 50170 (V2) and (in the event of a MOVIDRIVE[®] fault) of the diagnostic data for the specific unit.

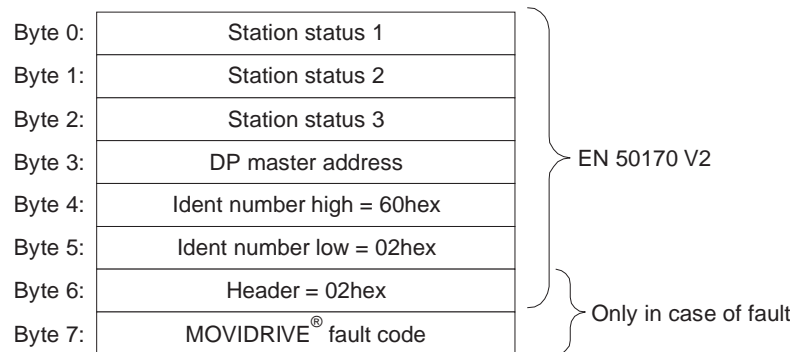

02904AEN

Fig. 33: Structure of the DP slave diagnostic information

The coding of bytes 0 – 3 is defined in EN 50170 (V2). Bytes 4, 5 and 6 always contain the constant codes shown in Fig. 33. Byte 7 is unit-specific and contains the MOVIDRIVE[®] fault code in the event of a malfunction.



4.12 Identity number

Each DP master and DP slave must have its individual identity number which is assigned by the PROFIBUS users' organization. This is used for uniquely identifying the connected unit. When the PROFIBUS-DP master starts up, it compares the identity numbers of the connected DP slaves with the identity numbers the user has entered in the project planning. User data transfer is not activated until the DP master has made sure that the connected station addresses and unit types (identity numbers) correspond to the project planning data. As a result, this process provides a high degree of protection against project planning mistakes.



MOVIDRIVE[®] compact
Ident number: 6002_{hex} or 24578_{dec}

02905AEN

Fig. 34: Identity number of the MOVIDRIVE[®] compact range of units

The identity number is defined as an unsigned 16-bit number. The PROFIBUS users' organization has defined identity number 6002 hex (24578 dec) for the MOVIDRIVE[®] compact drive inverter range of units.



4.13 Control via PROFIBUS-DP

The drive inverter is controlled via the process data channel which is one, two or three I/O words in length. These process data words are reproduced in the I/O or peripheral area of the controller, for example when a programmable logic controller is used as the DP master. As a result, they can be addressed in the usual manner (Fig. 35).

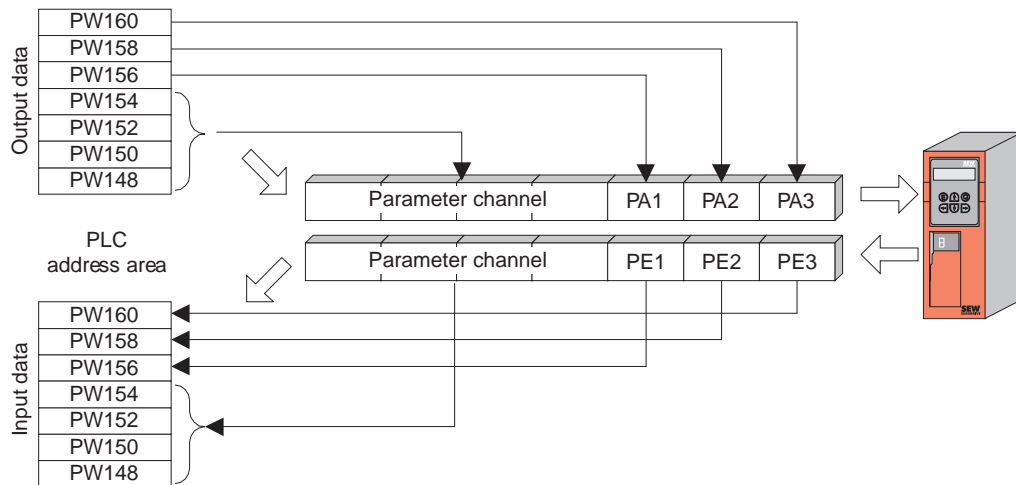

02906AEN

Fig. 35: Assignment of the I/O area of the PLC

Control example for Simatic S5

While the process input data (actual values) are being read in, e.g. using load commands with the Simatic S5, it is possible to send the process output data (setpoints) using the transfer commands. Starting from Fig. 35, the example shows the syntax for processing the process input data and process output data of the MOVIDRIVE® drive inverter. The factory setting for the process data channel is specified in the remark.

STEP5 program example

In this example, the project planning for MOVIDRIVE® has the process data configuration "3 PD" on input addresses PW156 – 161 and output addresses PW156 – 161. In this case, for example, consistent access takes place in the "last byte first" sequence.



In the Simatic S5, data consistency is principally determined by the CPU type. Please refer to the manuals for the CPU or the DP master module of the Simatic S5 for information about correct programming with data consistency.

```
//Read in actual values consistently
L PW 160      //Load PI3 (no function)
L PW 158      //Load PI2 (actual speed value)
L PW 156      //Load PI1 (status word 1)

//Output setpoints consistently
L KH 0
T PW 160      //Write 0hex on PO3 (no function, however)

L KF +1500
T PW 158      //Write 1500dec on PO2 (speed setpoint = 300 rpm)

L KH 0006
T PW 156      //Write 6hex on PO1 (control word = enable)
```



Control example for Simatic S7

The drive inverter is controlled using Simatic S7 in accordance with the selected process data configuration either directly using load and transfer commands or by means of special system functions, *SFC 14 DPRD_DAT* and *SFC15 DPWR_DAT*.

In principle with S7, data lengths of 3 bytes or more have to be transferred as 4 bytes using the SFC14 and SFC15 system functions. The following table therefore applies:

Process data configuration	Program access
1 PD	Load/transfer commands
2 PD	Load/transfer commands
3 PD	System functions SFC14/15 (length 6 bytes)
6 PD	System functions SFC14/15 (length 12 bytes)
10 PD	System functions SFC14/15 (length 20 bytes)
Param + 1 PD	Parameter channel: System functions SFC14/15 (length 8 bytes) Process data: Load/transfer commands
Param + 2 PD	Parameter channel: System functions SFC14/15 (length 8 bytes) Process data: Load/transfer commands
Param + 3 PD	Parameter channel: System functions SFC14/15 (length 8 bytes) Process data: System functions SFC14/15 (length 6 bytes)
Param + 6 PD	Parameter channel: System functions SFC14/15 (length 8 bytes) Process data: System functions SFC14/15 (length 12 bytes)
Param + 10 PD	Parameter channel: System functions SFC14/15 (length 8 bytes) Process data: System functions SFC14/15 (length 20 bytes)

STEP7 program example

In this example, the project planning for MOVIDRIVE[®] compact has the process data configuration “3 PD” on input addresses PIW576 – and output addresses POW576 –. A data block DB3 is created with about 50 data words.

When SFC14 is called, the process input data are copied into data block DB3, data words 0, 2 and 4. When SFC15 is called after the control program has been processed, the process output data are copied from data words 20, 22 and 24 into output address POW 576 –.

Note the length information in bytes in the case of the RECORD parameter. This must correspond to the configured length.

Please refer to the online help for STEP7 for further information about the system functions.



Control via PROFIBUS-DP

Control example for Simatic S7

```

//Start of cyclical program processing in OB1
BEGIN
NETWORK
TITLE = Copy PI data from inverter to DB3, word 0/2/4
CALL SFC 14 (DPRD_DAT) //Read DP slave record
  LADDR := W#16#240 //Input address 576
  RET_VAL:= MW 30 //Result in flag word 30
  RECORD := P#DB3.DBX 0.0 BYTE 6 //Pointer

NETWORK
TITLE = PLC program with drive application
// PLC program uses the process data in DB3 for
// controlling the drive
L DB3.DBW 0 //LOAD PI1 (status word 1)
L DB3.DBW 2 //Load PI2 (actual speed value)
L DB3.DBW 4 //Load PI3 (no function)

L W#16#0006
T DB3.DBW 20 //Write 6hex on PO1 (control word = enable)
L 1500
T DB3.DBW 22 //Write 1500dec on PO2 (speed setpoint = 300 rpm)
L W#16#0000
T DB3.DBW 24 //Write 0hex on PO3 (no function, however)

//End of cyclical program processing in OB1
NETWORK
TITLE = Copy PO data from DB3, word 20/22/24 to inverter
CALL SFC 15 (DPWR_DAT) //Write DP slave record
  LADDR := W#16#240 //Output address 576 = 240hex
  RECORD := P#DB3.DBX 20.0 BYTE 6//Pointer to DB/DW
  RET_VAL:= MW 32 //Result in flag word 32

```



Please refer to the Fieldbus Unit Profile manual (publication number 0919 1607) for more detailed information and sample applications for control via the process data channel, in particular concerning the coding of the control and status word.



4.14 Parameter setting via PROFIBUS-DP

With PROFIBUS-DP, the drive parameters are accessed via the MOVILINK[®] parameter channel. This offers extra parameter services in addition to the conventional READ and WRITE services.

Structure of the parameter channel

In order to set the parameters of peripheral units via fieldbus systems which do not provide an application layer, it is necessary to recreate the most important functions and services such as READ and WRITE for reading and writing parameters. To do this with PROFIBUS-DP, for example, a parameter process data object (PPO) is defined. This PPO is transmitted cyclically. In addition to the process data channel, it contains a parameter channel by means of which the acyclical parameter values can be exchanged (Fig. 36).

Fig. 37 shows the structure of the parameter channel. In principle, it is made up of a management byte, an index word, a reserved byte and four data bytes.

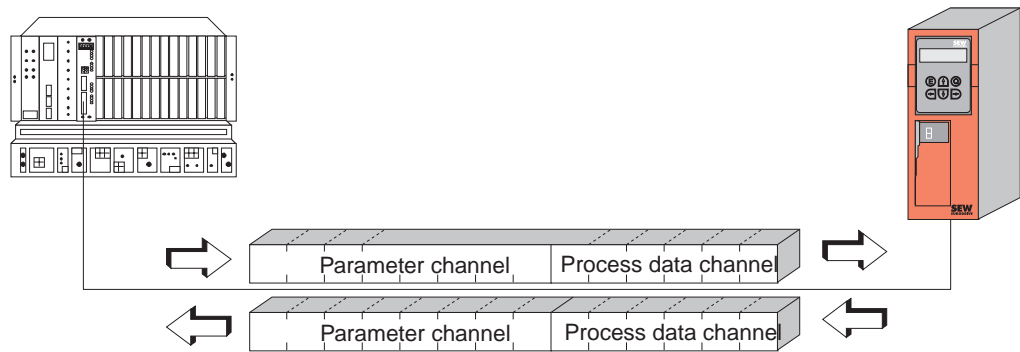

01065BEN

Fig. 36: Parameter process data object for PROFIBUS-DP

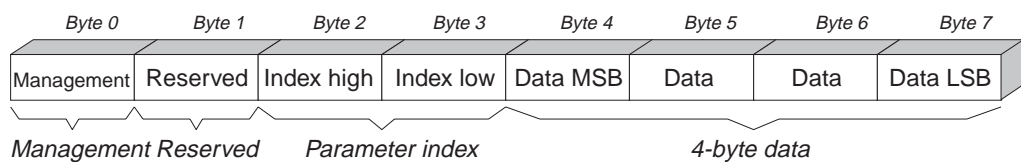

00146BEN

Fig. 37: Structure of the parameter channel



Data range

The data are located in byte 4 to byte 7 of the parameter channel, as shown in Fig. 39. This means up to 4 bytes of data can be transmitted per service. The data are always entered with right-justification, i.e. byte 7 contains the least significant data byte (data-LSB) whereas byte 4 is the most significant data byte (data-MSB).

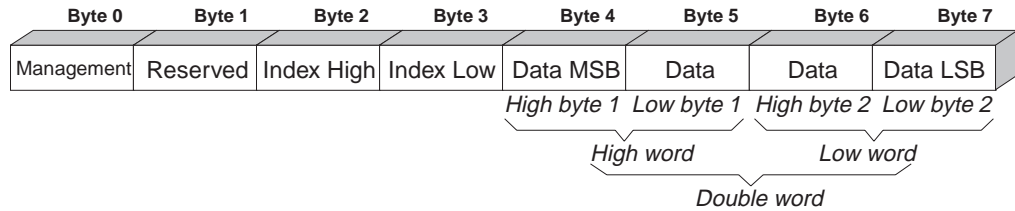

Fig. 39: Definition of the data range in the parameter channel

00148BDE

Incorrect performance of service

The status bit in the management byte is set to signal that a service has been performed incorrectly. The service was performed by the drive inverter if the received handshake bit is the same as the sent handshake bit. If the status bit now signals an error, the error code is entered in the data range of the parameter message (Fig. 40). Bytes 4 – 7 send back the return code in a structured format (see the return codes section).

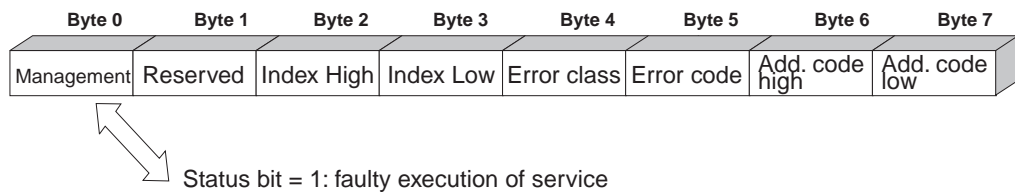

Fig. 40: Structure of the parameter channel in case a service is performed incorrectly

00149BEN



Return codes for parameterization

Data range / Incorrect performance of service

4.15 Return codes for parameterization

In the event of an incorrect parameter setting, the drive inverter sends back various return codes to the master which set the parameters. These codes provide detailed information about what caused the fault. All of these return codes are structured in accordance with EN 50170. The system distinguishes between the following elements:

- Error class
- Error code
- Additional code

These return codes apply to **all** communications interfaces of MOVIDRIVE®.

Error class

The error class element classifies the type of fault more precisely. MOVIDRIVE® compact supports the following error classes as defined in EN 50170 (V2):

Class (hex)	Name	Meaning
1	vfd-state	Status error of the virtual field unit
2	application-reference	Error in application program
3	definition	Definition error
4	resource	Resource error
5	service	Error when performing service
6	access	Access error
7	OV	Error in object list
8	other	Other error (see additional code)

The error class is generated if there is a fault in communication by the communications software of the fieldbus interface. This does not apply to error class 8, "Other error", however. Return codes sent from the drive inverter system are all in error class 8, "Other error". The error can be more precisely identified using the additional code element.

Error code

The error code element provides a means for more precisely identifying the cause of the error within the error class. It is generated by the communications software of the fieldbus card in the event of an error in communication. Only error code 0 (Other error code) is defined for error class 8, "Other error". In this case, detailed identification is made using the additional code.



Additional code

The additional code contains the return codes specific to SEW dealing with incorrect parameter settings of the drive inverter. They are sent back to the master in error class 8, "Other error". The following table shows all possible codings for the additional code.

Error class: 8 = "Other error"

Add. code high (hex)	Add. code low (hex)	Meaning
00	00	No error
00	10	Invalid parameter index
00	11	Function/parameter not implemented
00	12	Only read access allowed
00	13	Parameter lock is active
00	14	Factory setting is active
00	15	Value for parameter too large
00	16	Value for parameter too small
00	17	Option pcb required for this function/parameter is missing
00	18	Error in system software
00	19	Parameter access only via RS-485 process interface on X13
00	1A	Parameter access only via RS-485 diagnostic interface
00	1B	Parameter has access protection
00	1C	Controller inhibit required
00	1D	Impermissible value for parameter
00	1E	Factory setting was activated
00	1F	Parameter was not saved in EEPROM
00	20	Parameter cannot be changed with output stage enabled

Special return codes (special cases)

Faults in parameter settings which cannot be identified either automatically by the application layer of the fieldbus system or by the system software of the drive inverter are treated as special cases. This refers to the following possible errors:

- Incorrect coding of a service via parameter channel
- Incorrect length specification of a service via parameter channel
- Internal communications error

Incorrect service coding in the parameter channel

A non-defined coding was specified in the management or reserved byte during parameter setting via the parameter channel. The following table shows the return code for this special case.

	Code (dec)	Meaning
Error class:	5	Service
Error code:	5	Illegal parameter
Add. code high:	0	-
Add. code low:	0	-

Correcting the fault:

Check bytes 0 and 1 in the parameter channel.



Return codes for parameterization

Additional code / Special return codes / Incorrect service coding

Incorrect length specification in the parameter channel

A data length other than 4 data bytes was specified in a write service during parameter setting via the parameter channel. The following table displays the return code.

	Code (dec)	Meaning
Error class:	6	Access
Error code:	8	Type conflict
Add. code high:	0	-
Add. code low:	0	-

Correcting the fault:

Check bit 4 and bit 5 for the data length in the management byte of the parameter channel.

Internal communications error

The return code listed in the following table is sent back if a communications error has occurred within the system. The requested parameter service may not have been performed and should be repeated. If this error reoccurs, it is necessary to switch off the drive inverter completely and then back on again so it is re-initialized.

	Code (dec)	Meaning
Error class:	6	Access
Error code:	2	Hardware fault
Add. code high:	0	-
Add. code low:	0	-

Correcting the fault:

Repeat the parameter service. De-energize the drive inverter if the error reoccurs (system voltage + ext. 24 V_{DC}) and then switch it back on. Contact SEW Service for advice if this error occurs continuously.



4.16 Reading and writing parameters with PROFIBUS-DP

Reading a parameter with PROFIBUS-DP (Read)

In order to perform a READ service using the parameter channel, the handshake bit must not be changed until the entire parameter channel has been prepared in accordance with the service. This is because cyclical transfer takes place on the parameter channel. As a result, adhere to the following sequence in order to read a parameter:

1. Enter the index of the parameter to be read in byte 2 (Index high) and byte 3 (Index low).
2. Enter the service identifier for the read service in the management byte (byte 0).
3. Transfer the read service to the inverter by changing the handshake bit.

Since this is a read service, the sent data bytes (bytes 4 – 7) and the data length (in the management byte) are ignored and consequently do not need to be set.

The inverter now processes the read service and sends the service confirmation back by changing the handshake bit.

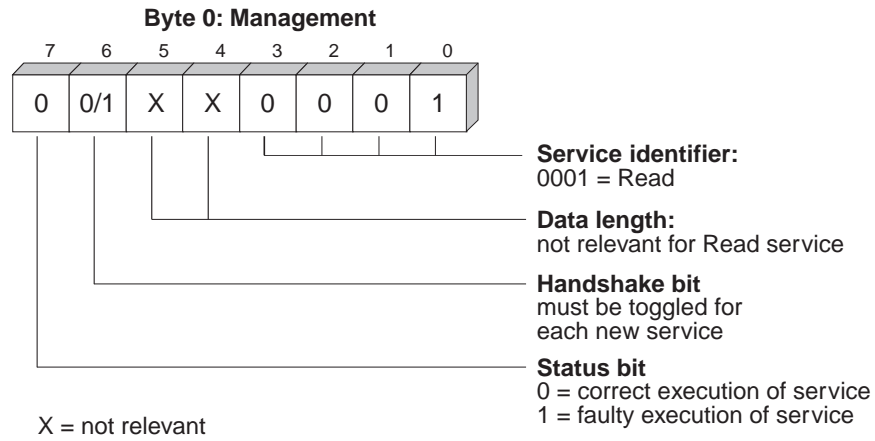

01230BEN

Fig. 41: READ service coding in the management byte

Fig. 41 shows how a READ service is coded in the management byte. The data length is not relevant; only the service identifier for the READ service should be entered. This service is now activated in the drive inverter when the handshake bit changes. For example, it would be possible to activate the read service with the management byte coding 01hex or 41hex.



Writing a parameter with PROFIBUS-DP (Write)

In order to perform a WRITE service using the parameter channel, the handshake bit must not be changed until the entire parameter channel has been prepared in accordance with the service. This is because cyclical transfer takes place on the parameter channel. As a result, adhere to the following sequence in order to write a parameter:

1. Enter the index of the parameter to be written in byte 2 (Index high) and byte 3 (Index low).
2. Enter the data to be written in bytes 4 – 7.
3. Enter the service identifier and the data length for the write service in the management byte (byte 0).
4. Transfer the write service to the inverter by changing the handshake bit.

The inverter now processes the write service and sends the service confirmation back by changing the handshake bit.

Fig. 42 shows how a WRITE service is coded in the management byte. The data length is 4 bytes for all parameters in SEW drive inverters. This service is now transferred to the drive inverter when the handshake bit changes. As a result, a write service on SEW drive inverters always has the management byte coding 32hex or 72hex.

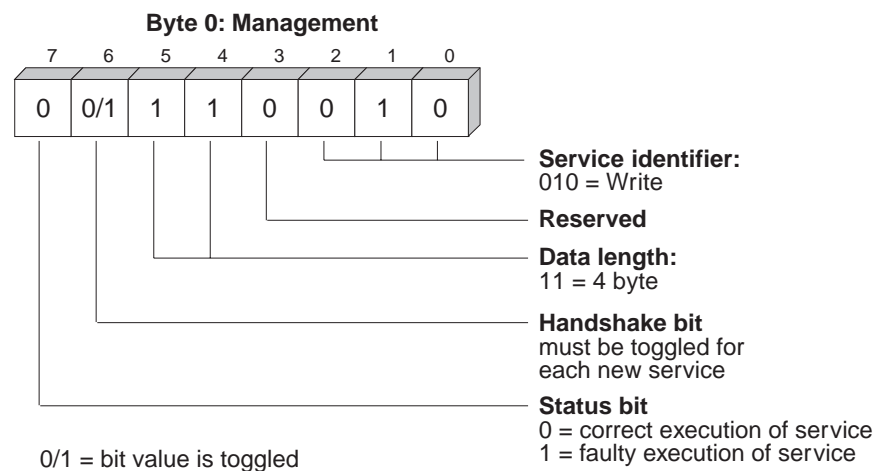

Fig. 42: WRITE service coding in the management byte

00151BEN



Procedure for setting parameters with PROFIBUS-DP

Taking the example of the WRITE service, Fig. 43 is intended to represent a process of setting parameters between the control and the drive inverter via PROFIBUS-DP. To simplify the sequence, Fig. 43 only shows the management byte of the parameter channel.

The parameter channel is only received and returned by the drive inverter whilst the controller is preparing the parameter channel for the write service. The service is not activated until the moment when the handshake bit is changed (in this example, when it changes from 0 to 1). The drive inverter now interprets the parameter channel and processes the write service; however, it continues to respond to all telegrams with handshake bit = 0. Confirmation that the service has been performed occurs when the handshake bit in the response telegram of the drive inverter is changed. The controller now detects that the received handshake bit is once again the same as the one which was sent. It can now prepare another parameter setting procedure.

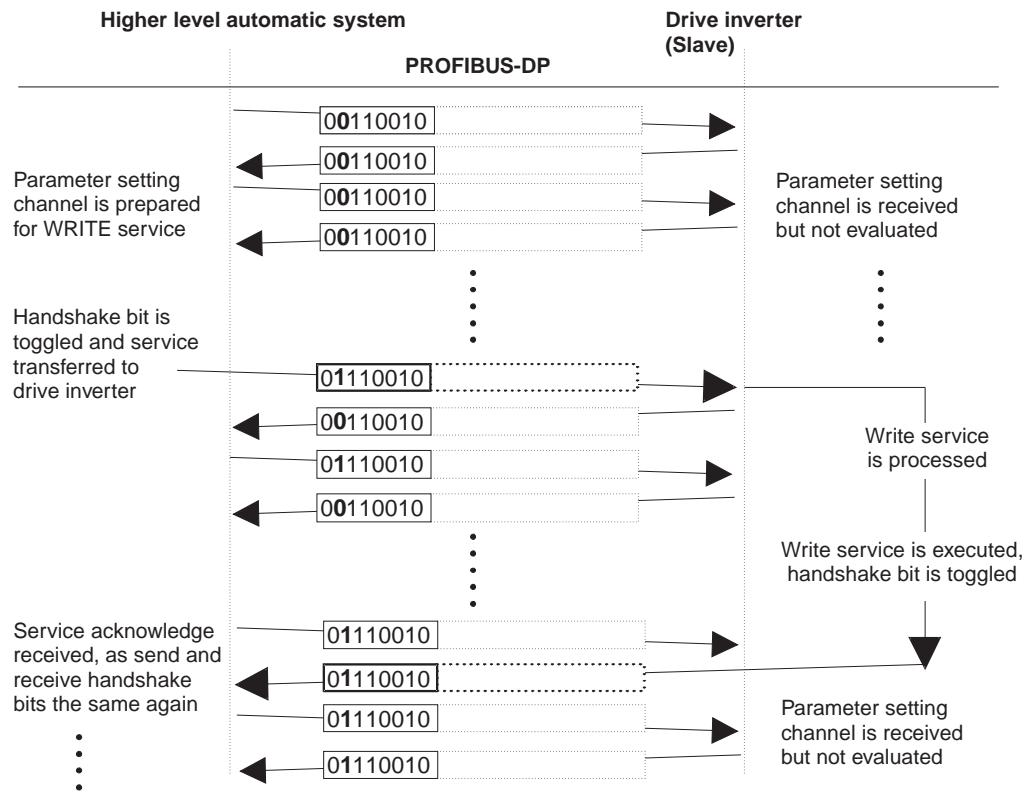

Fig. 43: Procedure for setting parameters with PROFIBUS-DP

00152BEN

Parametric data format

When parameters are set via the fieldbus interface, the same parameter coding is used as with the serial RS-485 interfaces or the system bus.

The data formats and ranges of values for the individual parameters are to be found in the MOVIDRIVE[®] parameter list published by SEW.



Operating displays

Operation LED V1 / PROFIBUS-DP LEDs

5 Operation and Service

5.1 Operating displays

Three LEDs on the MOVIDRIVE[®] compact MCF41A display the operating status.

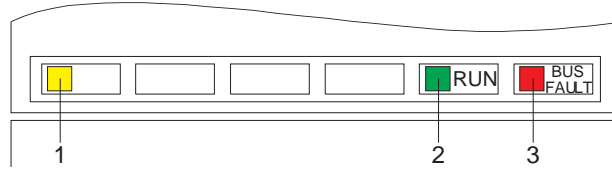

1. Operation LED V1 (three colors: green/red/yellow)
2. PROFIBUS-DP "RUN" LED (green)
3. PROFIBUS-DP "BUS FAULT" LED (red)

02902AXX

Fig. 44: Operation indicators of MOVIDRIVE[®] compact MCF41A

Operation LED V1

The operational states of MOVIDRIVE[®] compact MCF41A are displayed using the three-color LED V1 (green/red/yellow).

Color		Operational status	Description
-	OFF	No voltage	No supply voltage and no 24 V _{DC} backup voltage.
Yellow	Steady light	Controller inhibit	Unit ready but controller inhibit active (DIØØ = "0").
Green	Steady light	Enable	Motor is energized.
Red	Steady light	Interlocking system error	Error leads to unit being switched off.
Yellow	Flashing	Unit not ready	Factory setting in progress or 24 V _{DC} backup mode w/o supply voltage.
Green	Flashing	Flying start in progress	Operating mode VFC & FLYING START is set and inverter connected to rotating motor.
Green/red	Flashing 0.5 s green / 0.5 s red	Limit switch reached.	Limit switch reached in "enable" operating status.
Yellow/red	Flashing 0.5 s yellow / 0.5 s red	Limit switch reached	Limit switch reached in "controller inhibit" operating status.
Green/red	Flashing Green - green - red - red	System error leading to display or wait status	Fault in "enable" operating status which is only displayed and does not lead to a switch-off.
Yellow/red	Flashing Yellow - yellow - red - red	System error leading to display or wait status	Fault in "controller inhibit" operating status which is only displayed and does not lead to a switch-off.
Green/yellow	0.75 s green / 0.75 s yellow	Timeout active	Enable ineffective, inverter is waiting for a valid message.

PROFIBUS-DP LEDs

The "RUN" LED (green) indicates that the bus electronics are operating correctly. The "BUS FAULT" LED (red) indicates a PROFIBUS-DP fault.

RUN	BUS FAULT	Meaning
ON	ON	<ul style="list-style-type: none"> • Connection to the DP master has failed, check the bus connection. • Unit does not detect a baud rate, check the setting in the DP master. • Bus interruption or DP master not functioning.
ON	OFF	<ul style="list-style-type: none"> • Unit is currently exchanging data with the DP master (data exchange).
ON	FLASHING	<ul style="list-style-type: none"> • Unit has detected the baud rate, however it is not being addressed by the DP master. Make sure the address set on the unit (P092) matches the address set in the project planning software of the DP master. • Unit was not configured in DP master or configured incorrectly. Check the configuration, use the SEW_6002.GSD GSD file.
OFF	-	<ul style="list-style-type: none"> • Hardware defect in bus electronics. Switch the unit off and on again. Contact SEW Service for advice if this reoccurs.
FLASH.	-	<ul style="list-style-type: none"> • PROFIBUS address is set higher than 125 Set address ≤ 125.

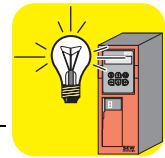

DBG11A keypad

Basic displays:

```

CONTROL . INHIBIT
CURRENT:          0 A
    
```

Display when X10:9 (DIØØ “/Controller inhibit”) = “0”.

```

NO ENABLE
CURRENT:          0 A
    
```

Display when X10:9 (DIØØ “/Controller inhibit”) = “1” and inverter is not enabled (“Enable/rapid stop” = “0”).

```

SPEED            942 rpm
CURRENT:         2.51 A
    
```

Display when inverter enabled.

```

NOTE XX:
XXXXXXXXXXXXXXXXXX
    
```

Information message

```

FAULT            XX
XXXXXXXXXXXXXXXXXX
    
```

Fault indication

Copy function of the DBG11A

The DBG11A keypad can be used for copying complete parameter sets from one MOV-DRIVE[®] compact unit to another MOV-DRIVE[®] compact. To do this, copy the parameter set onto the keypad using P807 (MDX → DBG). Connect the keypad to another MOV-DRIVE[®] compact unit and copy the parameter set onto the MOV-DRIVE[®] compact using P806 (DBG → MDX). The keypad can be disconnected and plugged in during operation.

The COMMUNIC. ERROR NO SERIAL LINK fault message appears on the display if no communication can be established with the inverter after the supply system or the 24 V_{DC} power supply is switched on. Try to establish the connection by connecting the DBG11A again.



Selected via menu:

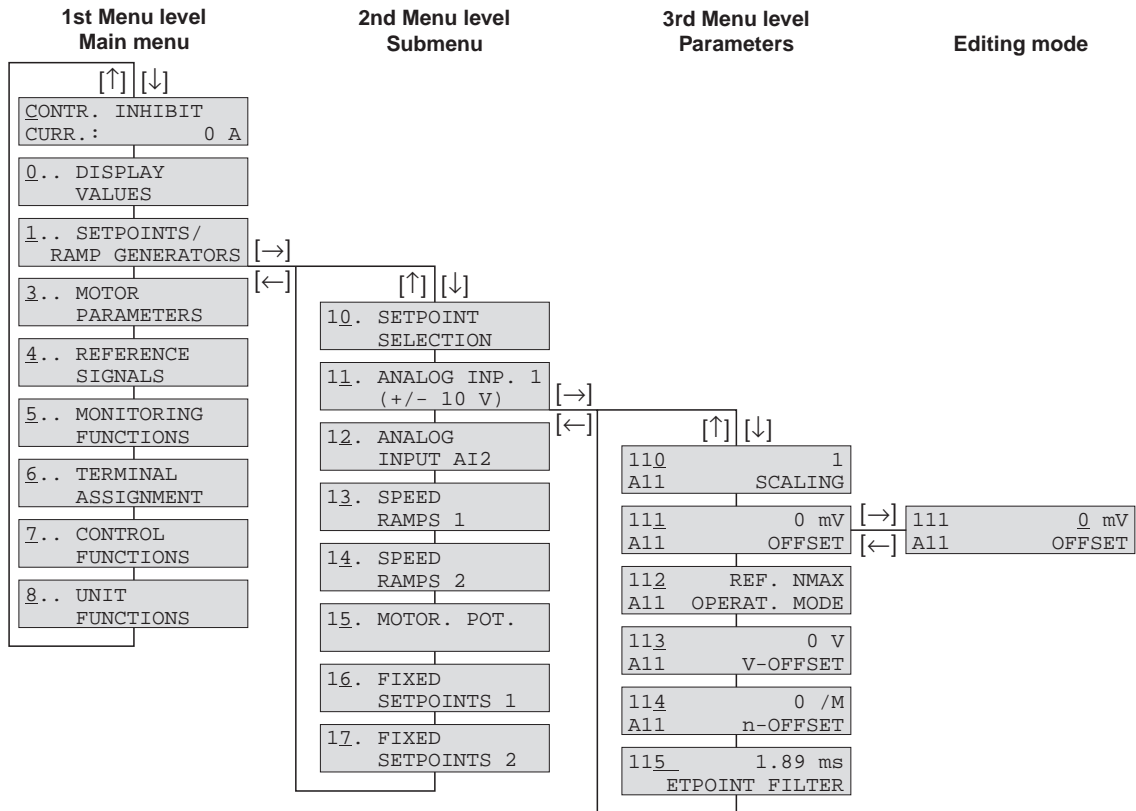
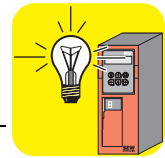

Fig. 45: Menu structure

02407AEN

- [←] [→] Change menu level, in 3rd menu level (parameter) entry to ([→]) or exit from ([←]) edit mode. The parameter can only be changed in edit mode. Startup is commenced if the [←] [→] keys are pressed at the same time (→ Sec. 4.3).
- [↑] [↓] Select menu command, increase or decrease values in edit mode. The new value comes into effect in edit mode when the [↑] or [↓] key is released.
- [Q] Back to main display; in startup mode, cancel startup.
- [E] Startup: Cancel startup
 Normal mode: Signature display; the signature can only be entered or edited in MX_SHELL and is used for identifying the parameter set or the unit.
 Manual mode: Exit manual mode
 Malfunction: Call up reset parameter P840



Quick menu of the DBG11A

The DBG11A keypad has a detailed parameter menu and a clearly structured quick menu with the most frequently used parameters. It is possible to switch between both menus using P800 ("Quick menu"). This can be done in any operating status. The default setting is for the quick menu to be active. The quick menu is shown on the display by a "/" after the parameter number. The parameters in the quick menu are identified by a "/" in the parameter list (→ Sec. 4.8).

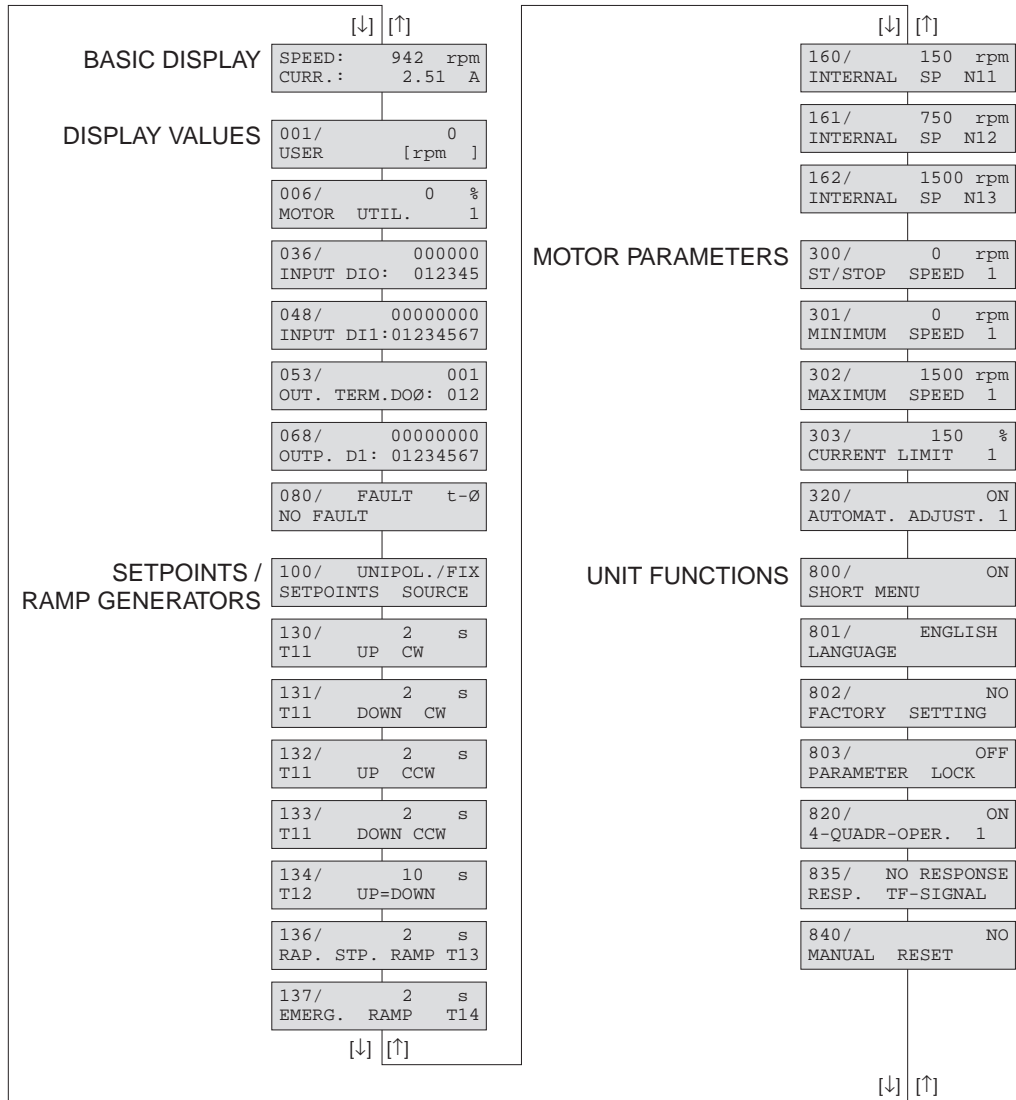

Fig. 46: DBG11A quick menu

02408ADE



Operating displays

Information messages

Information messages

Information messages on the DBG11A (approx. 2 s in duration) or in MX_SHELL (message which can be acknowledged):

No	Text DBG11A/ MX_SHELL	Description
1	ILLEGAL INDEX	Index addressed via interface is not available
2	NOT IMPLEMENTED	- Attempt to execute a non-implemented function. - An incorrect communication service has been selected. - Manual mode selected via impermissible interface (e.g. fieldbus).
3	READ ONLY VALUE	Attempt to edit a read only value.
4	PARAM. LOCKED	Parameter lock P803 = "ON". Parameter cannot be altered.
5	SETUP ACTIVE	Attempt to alter parameters during active factory setting.
6	VALUE TOO LARGE	Attempt to enter a value which is too large.
7	VALUE TOO SMALL	Attempt to enter a value which is too small.
8	REQ. PCB MISSING	The option pcb required for the selected function is missing.
--		
--		
11	TERMINAL ONLY	Manual mode must be completed using TERMINAL (DBG11A or USS21A).
12	NO ACCESS	Access to selected parameter refused.
13	NO CTRLER. INHIBIT	Set terminal DIØØ "/Controller inhibit" = "0" for the selected function.
14	INVALID VALUE	Attempt to enter an invalid value.
--		
16	PARAM. NOT SAVED	EEPROM buffer overrun, e.g. due to cyclical write accesses. Parameter is saved in EEPROM and is not protected against loss following POWER OFF.

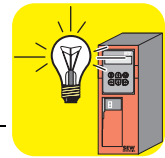

5.2 Fault information

Fault memory	<p>The fault memory (P080) stores the last five fault messages (faults t-0 – t-4). The fault message of longest standing is deleted whenever more than five fault messages have occurred. The following information is stored when a malfunction takes place:</p> <p>Fault which occurred • Status of the binary inputs/outputs • Operating status of the inverter • Inverter status • Heat sink temperature • Speed • Output current • Active current • Unit utilization • DC link circuit voltage • ON hours • Enable hours • Parameter set • Motor utilization.</p>
Shut-off responses	<p>There are three shut-off responses depending on the fault; the inverter is inhibited when in fault status:</p>
<i>Immediate shut-off:</i>	<p>The unit can no longer brake the drive; the output stage goes to high resistance in the event of a fault and the brake is applied immediately (DBØØ “/Brake” = “0”).</p>
<i>Rapid stop:</i>	<p>The drive is braked with the stop ramp t13/t23. Once the stop speed is reached, the brake is applied (DBØØ “/Brake” = “0”). The output stage goes to high-resistance after the brake reaction time has elapsed (P732 / P735).</p>
<i>Emergency stop:</i>	<p>The drive is braked with the emergency ramp t14/t24. Once the stop speed is reached, the brake is applied (DBØØ “/Brake” = “0”). The output stage goes to high-resistance after the brake reaction time has elapsed (P732 / P735).</p>
Reset	<p>A fault message can be acknowledged by:</p> <ul style="list-style-type: none"> • Switching the mains power off and on again. Recommendation: Observe a minimum switch-off time of 10 s for the main contactor K11. • Reset via input terminals, i.e. via an appropriately assigned binary input (DIØ1 – DIØ5) • Manual reset in MX_SHELL (P840 = “YES” or [Parameter] / [Manual reset]) • Manual reset using the DBG11A (pressing the <E> key in the event of a fault gives direct access to parameter P840) • Auto reset performs up to five unit resets with an adjustable restart time. Not to be used with drives where an automatic restart represents a risk of injury to people or damage to equipment.
Timeout active	<p>If the inverter is controlled via a communications interface (PROFIBUS-DP, RS-485 or SBus) and the power was switched off and back on again or a fault reset was performed, then the enable remains ineffective until the inverter once again receives valid data via the interface which is monitored with a timeout. “t - Waiting for Data” is displayed on the MX_SHELL and MOVITOOLS software; the DGB11A keypad displays “t”.</p>
PROFIBUS-DP timeout	<p>The response monitoring time elapses in MOVIDRIVE® <i>compact</i> (if configured in the DP master) if data transfer via PROFIBUS-DP is disrupted or interrupted. The “BUS FAULT” LED lights up to indicate that no new user data are being received. At the same time, the inverter performs the fault response selected with P831 “Fieldbus timeout response”.</p> <p>P819 “Fieldbus timeout” displays the response monitoring time specified by the DP master during the PROFIBUS-DP startup. It is only possible to alter this timeout time using the DP master. Although modifications made using the DBG11A keypad, MX_SHELL or MOVITOOLS are displayed, they do not have any effect and they are overwritten when the DP is next started up.</p>



5.3 List of faults

A dot in the “P” column means that the response is programmable (P83_ Fault response).
The factory set fault response is listed in the “Response” column.

Fault code	Name	Res- ponse	P	Possible cause	Action
00	No fault	-			
01	Over-current	Instant dis-connection		<ul style="list-style-type: none"> - Short circuit on output - Motor too large - Defective output stage 	<ul style="list-style-type: none"> - Eliminate short circuit - Connect a smaller motor - Call SEW Service for advice if the fault still cannot be reset.
03	Ground fault	Instant dis-connection		Ground fault <ul style="list-style-type: none"> - in feeder cable - in inverter - in motor 	<ul style="list-style-type: none"> - Eliminate ground fault - Replace MOVIDRIVE® compact - Replace motor
04	Brake chopper	Instant dis-connection		<ul style="list-style-type: none"> - Regenerative power excessive - Braking resistor circuit interrupted, short circuit in braking resistor circuit - Excessively high brake resistance - Brake chopper defective 	<ul style="list-style-type: none"> - Extend deceleration ramps - Check feeder cable to braking resistor, eliminate short circuit - Check technical data of braking resistor - Replace MOVIDRIVE® compact
07	DC link over-voltage	Instant dis-connection		DC link voltage too high	<ul style="list-style-type: none"> - Extend deceleration ramps - Check feeder cable to braking resistor - Check technical data of braking resistor
08	n-monitoring	Instant dis-connection		Current controller is operating at the setting limit due to: <ul style="list-style-type: none"> - Mechanical overload - Phase failure in power system - Phase failure on motor 	<ul style="list-style-type: none"> - Reduce load - Increase set delay time (P501 or P503) - Check current limitation - Extend ramps if necessary - Check mains phases - Check motor feeder and motor
09	Startup	Instant dis-connection		Inverter startup not yet performed for selected operating mode	Perform startup for appropriate operating mode
11	Over-temperature	Emergency stop		Thermal overload of inverter	Reduce load and/or ensure adequate cooling.
13	Control signal source	Instant dis-connection		Control signal source not defined or defined incorrectly	Set correct control signal source (P101).
15	Internal 24 V	Instant dis-connection		No internal 24 V _{DC} supply voltage	Check the power system connection. Contact SEW Service for advice if this reoccurs.
17-24	System failure	Instant dis-connection		Inverter electronics disrupted. Possibly due to EM interference.	Check ground connections and shields; improve them if necessary. Contact SEW Service for advice if this reoccurs.
25	EEPROM	Rapid stop		Fault when accessing EEPROM	Call up default setting, perform reset and set parameters again. Contact SEW Service for advice if this reoccurs.
26	External terminal	Emergency stop	•	External fault signal read in via programmable input	Eliminate specific cause of fault; reprogram terminal if appropriate.
27	Limit switches missing	Emergency stop		<ul style="list-style-type: none"> - Open circuit/both switches missing. - Limit switches swapped over in relation to motor direction of rotation 	<ul style="list-style-type: none"> - Check wiring of limit switches. - Swap over limit switch connections. - Reprogram terminals
28	Fieldbus timeout	Rapid stop		No master-slave communication took place within the configured response monitoring period.	<ul style="list-style-type: none"> - Check master communication routine. - Extend fieldbus timeout time (P819) or switch off.
30	Emergency stop timeout	Instant dis-connection		<ul style="list-style-type: none"> - Drive overloaded - Emergency stop ramp too short 	<ul style="list-style-type: none"> - Check project planning - Extend emergency stop ramp
31	TF sensor	No response	•	<ul style="list-style-type: none"> - Motor too hot, TF has tripped - TF of motor not connected or not connected properly - Connection of MOVIDRIVE® compact and TF interrupted on motor - Jumper missing X10:6 & X10:17. 	<ul style="list-style-type: none"> - Let motor cool down and reset fault - Check connections/link between MOVIDRIVE® compact and TF. - If no TF is connected: Jumper X10:6 to X10:17. - Set P834 to “No response”.

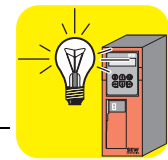

Fault code	Name	Response	P	Possible cause	Action
33	Setpoint source	Instant disconnection		Setpoint source not defined or defined incorrectly	Set correct setpoint source (P100).
35	Operating mode	Instant disconnection		Operating mode not defined or defined incorrectly	Use P700 or P701 to set correct operating mode
37	System watchdog	Instant disconnection		Fault in system software procedure	Contact SEW Service for advice.
38	System software	Instant disconnection		System malfunction	Contact SEW Service for advice.
43	RS-485 timeout	Rapid stop		• Communication between inverter and PC interrupted	Check connection between inverter and PC. Contact SEW Service for advice if necessary.
44	Unit utilization	Instant disconnection		Unit utilization (IxT value) exceeds 125 %	- Reduce power output. - Extend ramps - If these points are not possible: use a larger inverter.
45	Initialization	Instant disconnection		No parameters set for EEPROM in power section or parameters set incorrectly.	Restore default settings. Call SEW Service for advice if the fault still cannot be reset.
47	System bus timeout	Rapid stop		• Fault during communication via system bus.	Check system bus connection.
81	Start condition	Instant disconnection		Only in "VFC hoist" operating mode: Insufficient current could be injected into motor during pre-magnetization time: - Motor rated power too small in relation to inverter rated power. - Motor cable cross section too small	- Check commissioning data and repeat startup procedure if necessary. - Check connection between inverter and motor. - Check cross section of motor feeder and increase if necessary.
82	Output open	Instant disconnection		Only in "VFC hoist" operating mode: - Two or all output phases interrupted. - Motor rated power too small in relation to inverter rated power.	- Check connection between inverter and motor. - Check commissioning data and repeat startup procedure if necessary.
84	Motor protection	Emergency stop		• Motor utilization too high.	- Reduce load. - Extend ramps. - Observe longer pause times.
85	Copy	Instant disconnection		Fault when copying parameters.	Check connection between inverter and PC.
94	EEPROM checksum	Instant disconnection		Inverter electronics disrupted. Possibly due to EM interference or defect.	Send the unit in for repair.



5.4 PROFIBUS-DP fault diagnosis

The following diagnostic procedures indicate the troubleshooting methods for the most frequent problems.

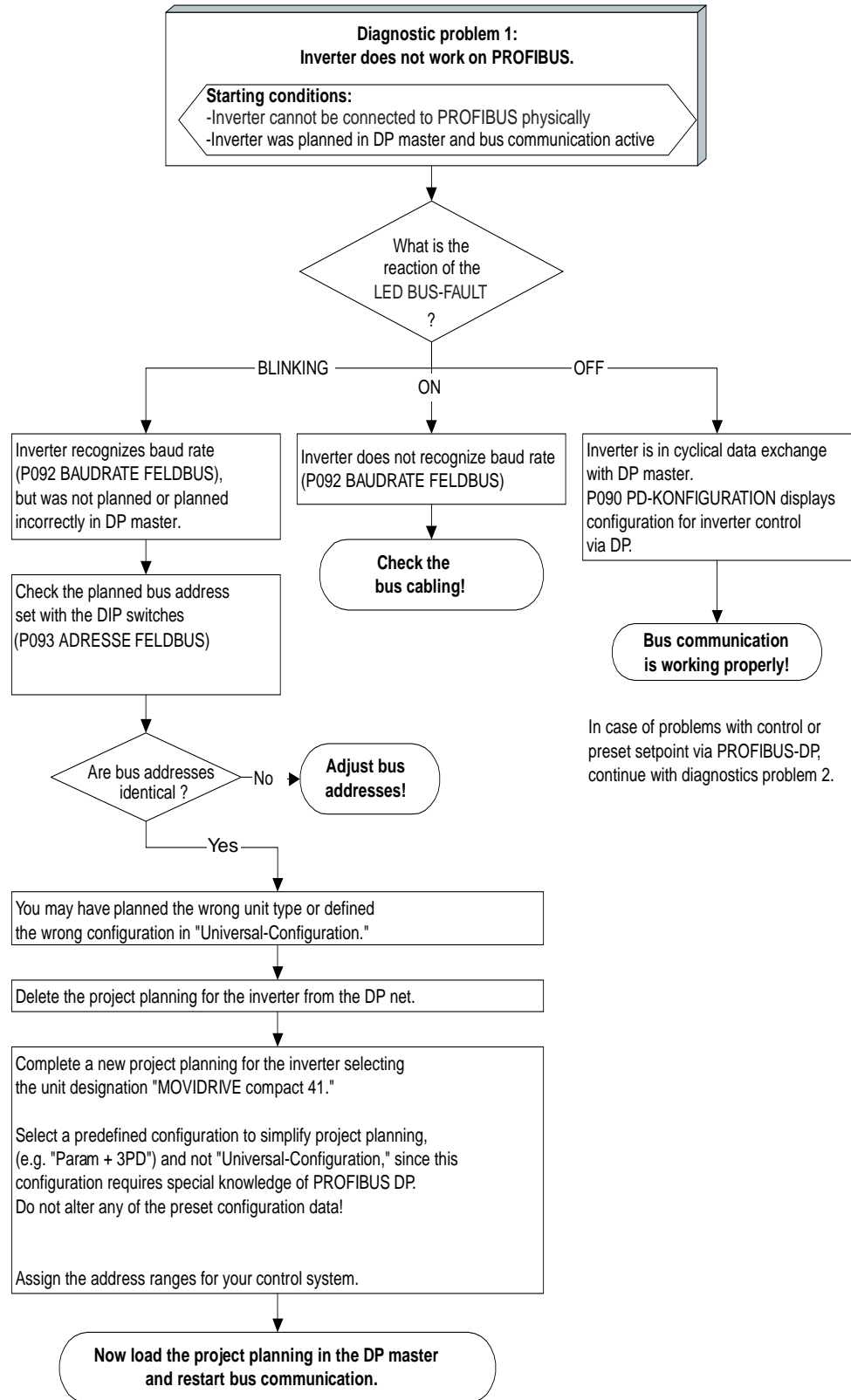

Fig. 47: Diagnostic procedure for "Inverter does not work on PROFIBUS-DP"EN

02909AEN

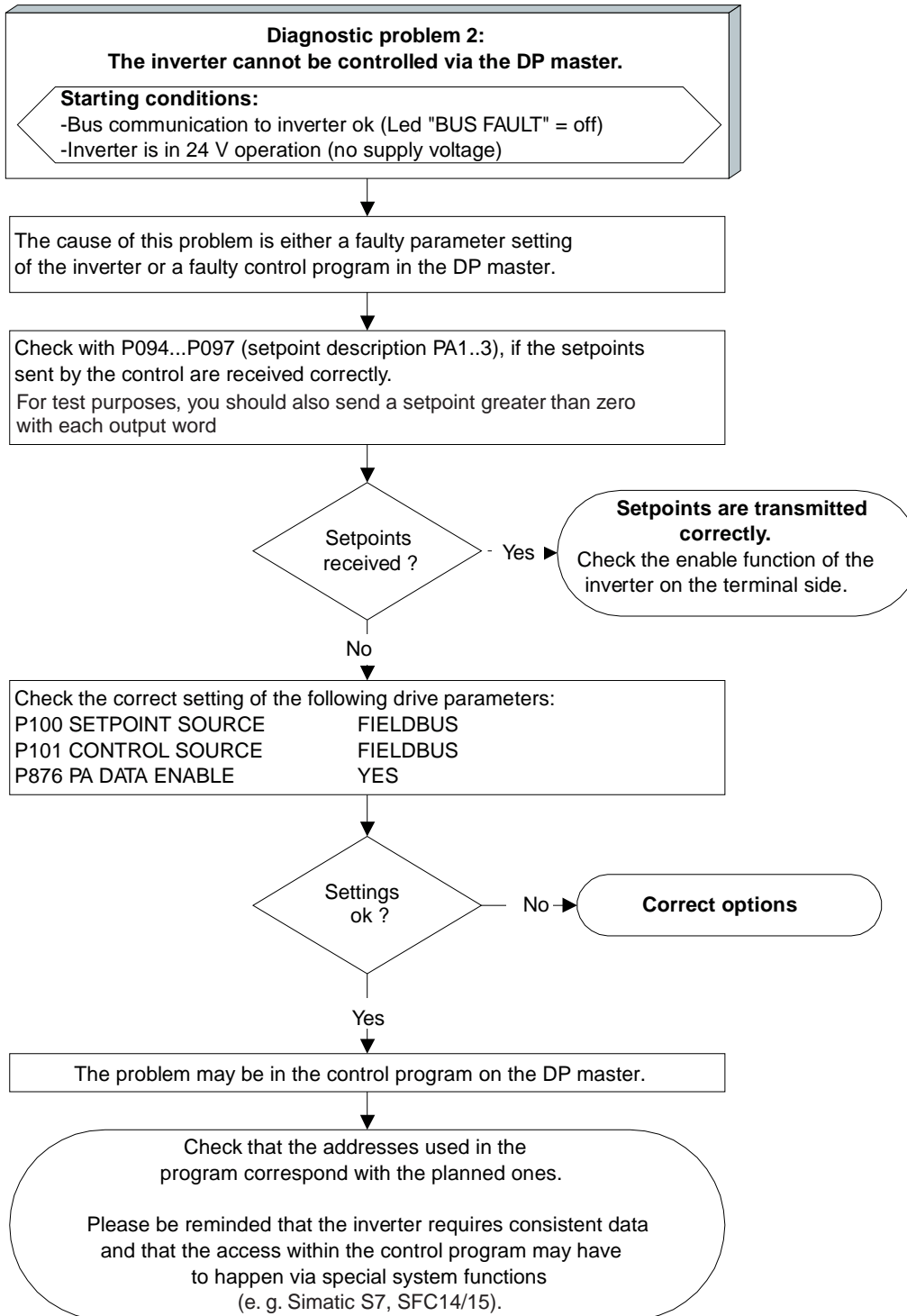

Fig. 48: Diagnostic procedure for "Inverter cannot be controlled using the DP master"

02911AEN



SEW electronics service

Send in for repair / Service label

5.5 SEW electronics service

Send in for repair Please contact the SEW electronics service if a fault cannot be rectified (→ “Customer and spare parts service”).

When contacting the SEW electronics service, please always quote the digits of your service code to enable our service personnel to assist you more effectively.

Please provide the following information if you are sending the unit in for repair:

- Serial number (→ nameplate)
- Unit designation
- Digits of the service code
- Brief description of the application (application, control via terminals or serial)
- Connected motor (motor voltage, Υ or Δ circuit)
- Nature of the fault
- Peripheral circumstances
- Your own presumption of what has happened
- Any unusual events, etc. preceding the fault

Service label

MOVIDRIVE® units have service labels attached to them; one for the power section and another for the control module. These are located on the side next to the rating plate.

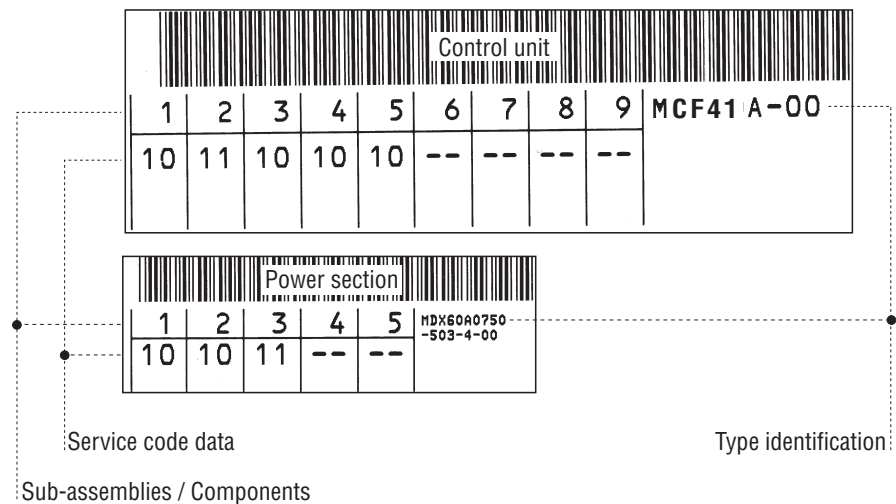
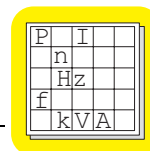

Fig. 49: Service label

03034AEN



6 Technical Data

6.1 General technical data

The following table lists the technical data applicable to all MOVIDRIVE[®] compact MCF41A drive inverters, irrespective of their size and performance.

MOVIDRIVE [®] compact MCF41A	All sizes
Interference immunity	To EN 61800-3
Interference emission with EMC-compliant installation	According to limit value class B to EN 55011 and EN 55014 To EN 61800-3 Sizes 1 and 2 on line side according to limit value class A to EN 55011 and EN 55014 without further measures
Ambient temperature ϑ_U Derating ambient temperature Climate class	0° – +50 °C at $I_D = 100\% I_N$ and $f_{PWM} = 4$ kHz 0° – +40 °C at $I_D = 125\% I_N$ and $f_{PWM} = 4$ kHz P_N reduction: 3.0 % I_N per K to max. 60 °C EN 60721-3-3, class 3K3
Storage temperature^{*)} ϑ_L	-25 °C – +70 °C (EN 60721-3-3, class 3K3) DBG keypad: -20 °C – +60 °C
Enclosure Sizes 1 to 3: Sizes 4 and 5:	IP20 IP00 (power connections) or IP10 with standard plexiglass cover mounted
Operating mode	DB (EN 60149-1-1 and 1-3)
Installation altitude	$h \leq 1000$ m (3300 ft) I_N reduction: 1 % per 100 m (330 ft) from 1000 m (3300 ft) to max. 2000 m (6600 ft)

^{*)} Connect to mains voltage for min. 5 minutes every 2 years if stored for long periods, otherwise the unit's service life may be reduced.

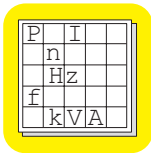

6.2 MCF41A....-2_3 (230 V units)

Size 1

MOVIDRIVE® MCF41A	0015-2A3-4-00	0022-2A3-4-00	0037-2A3-4-00
Part number	826 853 3	826 854 1	826 855 X
INPUT			
Supply voltage V_{in} Approved range	3 x 230 V _{AC} $V_{in} = 200 V_{AC} - 10\% - 240 V_{AC} + 10\%$		
Supply frequency f_{supply}	50 Hz – 60 Hz ± 5 %		
Rated system current I_{system} (at $V_{in} = 3 \times 230 V_{AC}$)	100 % 6.7 A _{AC} 125 % 8.4 A _{AC}	7.8 A _{AC} 9.8 A _{AC}	12.9 A _{AC} 16.1 A _{AC}
OUTPUT			
Output rated power P_N (at $V_{in} = 3 \times 200 - 240 V_{AC}$)	2.7 kVA	3.4 kVA	5.8 kVA
Output rated current I_N (at $V_{in} = 3 \times 230 V_{AC}$)	7.3 A _{AC}	8.6 A _{AC}	14.5 A _{AC}
Speed range Resolution	-5000 – 0 – 5000 rpm 0.2 rpm over the entire range		
Constant load Recommended motor power P_{mot}	1.5 kW (2.0 HP)	2.2 kW (3.0 HP)	3.7 kW (5.0 HP)
Variable torque load and constant load without overload Recommended motor power P_{mot}	2.2 kW (3.0 HP)	3.7 kW (5.0 HP)	5.0 kW (6.8 HP)
Continuous output current = 125 % I_N *) I_D (at $V_{in} = 3 \times 400 V_{AC}$)	9.1 A _{AC}	10.8 A _{AC}	18.1 A _{AC}
Current limitation I_{max}	Motor: 150 % I_N Regenerative: 150 % I_N Duration dependent on utilization		
Internal current limitation	$I_{max} = 0 - 150\%$ can be set in menu (P303 / P313)		
Minimum approved braking resistance in 4Q operation R_{BR}	27 Ω		
Output voltage V_O	max. V_{in}		
PWM frequency f_{PWM}	Adjustable: 4/8/12/16 kHz (P860/P861)		
GENERAL			
Power loss at P_N P_{Vmax}	110 W	126 W	210 W
Type of cooling (DIN 41751) Forced cooling / cooling air consumption	40 m ³ /h (24 ft ³ /min)		
Weight	2.8 kg (6.16 lb)		
Dimensions $W \times H \times D$	105 × 315 × 155 mm (4.13 × 12.40 × 6.10 in)		

*) applies to $f_{PWM} = 4$ kHz

The performance data refer to the standard PWM frequency = 4 kHz (P860 / P861).

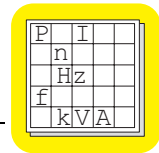

Sizes 2 and 3

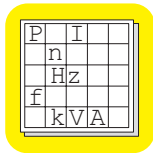

MOVIDRIVE® MCF41A	0055-2A3-4-00	0075-2A3-4-00	0110-203-4-00
Part number	826 856 8	826 857 6	826 858 4
Size	2		3
INPUT			
Supply voltage V_{in}	3 x 230 V _{AC}		
Approved range	$V_{in} = 200 V_{AC} - 10\% - 240 V_{AC} + 10\%$		
Supply frequency f_{system}	50 Hz – 60 Hz ± 5 %		
Rated system current I_{system} 100 % (at $V_{in} = 3 \times 230 V_{AC}$) 125 %	19.5 A _{AC} 24.4 A _{AC}	27.4 A _{AC} 34.3 A _{AC}	40 A _{AC} 50.0 A _{AC}
OUTPUT			
Output rated power P_N (at $V_{in} = 3 \times 200 - 240 V_{AC}$)	8.8 kVA	11.6 kVA	17.1 kVA
Output rated current I_N (at $V_{in} = 3 \times 230 V_{AC}$)	22 A _{AC}	29 A _{AC}	42 A _{AC}
Speed range n_A	-5000 – 0 – 5000 rpm		
Resolution Δn_A	0.2 rpm over the entire range		
Constant load Recommended motor power P_{mot}	5.5 kW (7.5 HP)	7.5 kW (10 HP)	11 kW (15 HP)
Variable torque load and constant load without overload Recommended motor power P_{mot}	7.5 kW (10 HP)	11 kW (15 HP)	15 kW (20 HP)
Continuous output current = 125 % I_N *) I_D (at $V_{in} = 3 \times 400 V_{AC}$)	27.5 A _{AC}	36.3 A _{AC}	52.5 A _{AC}
Current limitation I_{max}	Motor: 150 % I_N Regenerative: 150 % I_N Duration dependent on utilization		
Internal current limitation	$I_{max} = 0 - 150\%$ can be set in menu (P303 / P313)		
Minimum approved braking resistance in 4Q operation R_{BR}	12 Ω		7.5 Ω
Output voltage V_O	max. V_{in}		
PWM frequency f_{PWM}	Adjustable: 4/8/12/16 kHz (P860/P861)		
GENERAL			
Power loss at P_N P_{Vmax}	300 W	380 W	580 W
Type of cooling (DIN 41751) Forced cooling / cooling air consumption	80 m ³ /h (48 ft ³ /min)		180 m ³ /h (108 ft ³ /min)
Weight	5.9 kg (12.98 lb)		14.3 kg (31.46 lb)
Dimensions $W \times H \times D$	130 × 335 × 207 mm (5.12 × 13.19 × 8.15 in)		200 × 465 × 227 mm (7.87 × 18.31 × 8.94 in)

*) applies to $f_{PWM} = 4$ kHz
 The performance data refer to the standard PWM frequency = 4 kHz (P860 / P861).



6.3 MCF41A....-5_3 (400/500 V units)

Size 1

MOVIDRIVE® MCF41A	0015-5A3-4-00	0022-5A3-4-00	0030-5A3-4-00	0040-5A3-4-00
Part number	826 835 5	826 836 3	826 837 1	826 838 X
INPUT				
Supply voltage V_{in} Approved range	3 x 380 V _{AC} / 400 V _{AC} / 415 V _{AC} / 460 V _{AC} / 480 V _{AC} / 500 V _{AC} $V_{in} = 380 \text{ V}_{AC} - 10\% - 500 \text{ V}_{AC} + 10\%$			
Supply frequency f_{system}	50 Hz – 60 Hz ± 5 %			
Rated system current I_{system} 100 % (at $V_{in} = 3 \times 400 \text{ V}_{AC}$) 125 %	3.6 A _{AC} 4.5 A _{AC}	5.0 A _{AC} 6.2 A _{AC}	6.3 A _{AC} 7.9 A _{AC}	8.6 A _{AC} 10.7 A _{AC}
OUTPUT				
Output rated power P_N (at $V_{in} = 3 \times 380 - 500 \text{ V}_{AC}$)	2.8 kVA	3.8 kVA	4.9 kVA	6.6 kVA
Output rated current I_N (at $V_{in} = 3 \times 400 \text{ V}_{AC}$)	4.0 A _{AC}	5.5 A _{AC}	7.0 A _{AC}	9.5 A _{AC}
Speed range n_A Resolution Δn_A	-5000 – 0 – 5000 rpm 0.2 rpm over the entire range			
Constant load Recommended motor power P_{mot} 	1.5 kW (2.0 HP)	2.2 kW (3.0 HP)	3.0 kW (4.0 HP)	4.0 kW (5.0 HP)
Variable torque load and constant load without overload Recommended motor power P_{mot} 	2.2 kW (3.0 HP)	3.0 kW (4.0 HP)	4.0 kW (5.0 HP)	5.5 kW (7.5 HP)
Continuous output current = 125 % I_N^* I_D (at $V_{in} = 3 \times 400 \text{ V}_{AC}$)	5.0 A _{AC}	6.9 A _{AC}	8.8 A _{AC}	11.9 A _{AC}
Current limitation I_{max}	Motor: 150 % I_N Regenerative: 150 % I_N Duration dependent on utilization			
Internal current limitation	$I_{max} = 0 - 150\%$ can be set in menu (P303 / P313)			
Minimum approved braking resistance in 4Q operation R_{BR}	68 Ω			
Output voltage V_O	max. V_{in}			
PWM frequency f_{PWM}	Adjustable: 4/8/12/16 kHz (P860/P861)			
GENERAL				
Power loss at P_N P_{Vmax}	85 W	105 W	130 W	180 W
Type of cooling (DIN 41751) Forced cooling / cooling air consumption	40 m ³ /h (24 ft ³ /min)			
Weight	2.8 kg (6.16 lb)			
Dimensions $W \times H \times D$	105 × 315 × 155 mm (4.13 × 12.40 × 6.10 in)			

*) applies to $f_{PWM} = 4 \text{ kHz}$

The performance data refer to the standard PWM frequency = 4 kHz (P860 / P861).

The permitted supply system and output currents are 20 % below the rated data at $V_{in} = 3 \times 500 \text{ V}_{AC}$.

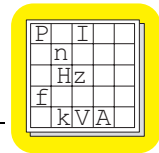

Size 2

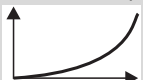
MOVIDRIVE® MCF41A	0055-5A3-4-00	0075-5A3-4-00	0110-5A3-4-00
Part number	826 839 8	826 840 1	826 841 X
INPUT			
Supply voltage V_{in} Approved range	3 x 380 V _{AC} / 400 V _{AC} / 415 V _{AC} / 460 V _{AC} / 480 V _{AC} / 500 V _{AC} $V_{in} = 380 \text{ V}_{AC} - 10\% - 500 \text{ V}_{AC} + 10\%$		
Supply frequency f_{system}	50 Hz – 60 Hz ± 5 %		
Rated system current I_{system} 100 % (at $V_{in} = 3 \times 400 \text{ V}_{AC}$) 125 %	11.3 A _{AC} 14.1 A _{AC}	14.4 A _{AC} 18.0 A _{AC}	21.6 A _{AC} 27.0 A _{AC}
OUTPUT			
Output rated power P_N (at $V_{in} = 3 \times 380 - 500 \text{ V}_{AC}$)	8.7 kVA	11.2 kVA	16.8 kVA
Output rated current I_N (at $V_{in} = 3 \times 400 \text{ V}_{AC}$)	12.5 A _{AC}	16 A _{AC}	24 A _{AC}
Speed range n_A Resolution Δn_A	-5000 – 0 – 5000 rpm 0.2 rpm over the entire range		
Constant load Recommended motor power P_{mot} 	5.5 kW (7.5 HP)	7.5 kW (10 HP)	11 kW (15 HP)
Variable torque load and constant load without overload Recommended motor power P_{mot} 	7.5 kW (10 HP)	11 kW (15 HP)	15 kW (20 HP)
Continuous output current = 125 % I_N^* I_D (at $V_{in} = 3 \times 400 \text{ V}_{AC}$)	15.6 A _{AC}	20 A _{AC}	30 A _{AC}
Current limitation I_{max}	Motor: 150 % I_N Regenerative: 150 % I_N Duration dependent on utilization		
Internal current limitation	$I_{max} = 0 - 150\%$ can be set in menu (P303 / P313)		
Minimum approved braking resistance in 4Q operation R_{BR}	47 Ω		22 Ω
Output voltage V_O	max. V_{in}		
PWM frequency f_{PWM}	Adjustable: 4/8/12/16 kHz (P860/P861)		
GENERAL			
Power loss at P_N P_{Vmax}	220 W	290 W	400 W
Type of cooling (DIN 41751) Forced cooling / cooling air consumption	80 m ³ /h (48 ft ³ /min)		
Weight	5.9 kg (12.98 lb)		
Dimensions $W \times H \times D$	130 × 335 × 207 mm (5.12 × 13.19 × 8.15 in)		

*) applies to $f_{PWM} = 4 \text{ kHz}$

The performance data refer to the standard PWM frequency = 4 kHz (P860 / P861).

The permitted supply system and output currents are 20 % below the rated data at $V_{in} = 3 \times 500 \text{ V}_{AC}$.

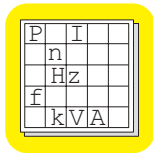

Size 3

MOVIDRIVE® MCF41A	0150-503-4-00	0220-503-4-00	0300-503-4-00
Part number	826 842 8	826 843 6	826 844 4
INPUT			
Supply voltage V_{in} Approved range	3 x 380 V _{AC} / 400 V _{AC} / 415 V _{AC} / 460 V _{AC} / 480 V _{AC} / 500 V _{AC} $V_{in} = 380 V_{AC} - 10\% - 500 V_{AC} + 10\%$		
Supply frequency f_{system}	50 Hz – 60 Hz ± 5 %		
Rated system current I_{system} (at $V_{in} = 3 \times 400 V_{AC}$)	100 % 125 % 28.8 A _{AC} 36.0 A _{AC}	41.4 A _{AC} 51.7 A _{AC}	54.0 A _{AC} 67.5 A _{AC}
OUTPUT			
Output rated power P_N (at $V_{in} = 3 \times 380 - 500 V_{AC}$)	22.2 kVA	31.9 kVA	41.6 kVA
Output rated current I_N (at $V_{in} = 3 \times 400 V_{AC}$)	32 A _{AC}	46 A _{AC}	60 A _{AC}
Speed range Resolution	-5000 – 0 – 5000 rpm 0.2 rpm over the entire range		
Constant load Recommended motor power P_{mot}	15 kW (20 HP)	22 kW (30 HP)	30 kW (40 HP)
Variable torque load and constant load without overload Recommended motor power P_{mot}	22 kW (30 HP)	30 kW (40 HP)	37 kW (50 HP)
Continuous output current = 125 % $I_N^{*)}$ I_D (at $V_{in} = 3 \times 400 V_{AC}$)	40.0 A _{AC}	57.5 A _{AC}	75.0 A _{AC}
Current limitation I_{max}	Motor: 150 % I_N Regenerative: 150 % I_N Duration dependent on utilization		
Internal current limitation	$I_{max} = 0 - 150\%$ can be set in menu (P303 / P313)		
Minimum approved braking resistance in 4Q operation R_{BR}	15 Ω	12 Ω	
Output voltage V_O	max. V_{in}		
PWM frequency f_{PWM}	Adjustable: 4/8/12/16 kHz (P860/P861)		
GENERAL			
Power loss at P_N P_{Vmax}	550 W	750 W	950 W
Type of cooling (DIN 41751) Forced cooling / cooling air consumption	180 m ³ /h (108 ft ³ /min)		
Weight	14.3 kg (31.46 lb)		
Dimensions $W \times H \times D$	200 × 465 × 227 mm (7.87 × 18.31 × 8.94 in)		

*) applies to $f_{PWM} = 4$ kHz

The performance data refer to the standard PWM frequency = 4 kHz (P860 / P861).

The permitted supply system and output currents are 20 % below the rated data at $V_{in} = 3 \times 500 V_{AC}$.

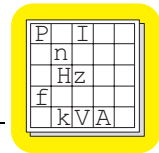

Size 4

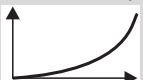
MOVIDRIVE® MCF41A	0370-503-4-00	0450-503-4-00
Part number	826 845 2	826 846 0
INPUT		
Supply voltage V_{in} Approved range	3 x 380 V _{AC} / 400 V _{AC} / 415 V _{AC} / 460 V _{AC} / 480 V _{AC} / 500 V _{AC} $V_{in} = 380 \text{ V}_{AC} - 10 \% - 500 \text{ V}_{AC} + 10 \%$	
Supply frequency f_{system}	50 Hz – 60 Hz ± 5 %	
Rated system current I_{system} 100 % (at $V_{in} = 3 \times 400 \text{ V}_{AC}$) 125 %	65.7 A _{AC} 81.9 A _{AC}	80.1 A _{AC} 100.1 A _{AC}
OUTPUT		
Output rated power P_N (at $V_{in} = 3 \times 380 - 500 \text{ V}_{AC}$)	51.1 kVA	62.3 kVA
Output rated current I_N (at $V_{in} = 3 \times 400 \text{ V}_{AC}$)	73 A _{AC}	89 A _{AC}
Speed range n_A Resolution Δn_A	-5000 – 0 – 5000 rpm 0.2 rpm over the entire range	
Constant load Recommended motor power P_{mot} 	37 kW (50 HP)	45 kW (60 HP)
Variable torque load and constant load without overload Recommended motor power P_{mot} 	45 kW (60 HP)	55 kW (75 HP)
Continuous output current = 125 % $I_N^{*)}$ I_D (at $V_{in} = 3 \times 400 \text{ V}_{AC}$)	91 A _{AC}	111 A _{AC}
Current limitation I_{max}	Motor: 150 % I_N Regenerative: 150 % I_N Duration dependent on utilization	
Internal current limitation	$I_{max} = 0 - 150 \%$ can be set in menu (P303 / P313)	
Minimum approved braking resistance in 4Q operation R_{BR}	6 Ω	6 Ω
Output voltage V_O	max. V_{in}	
PWM frequency f_{PWM}	Adjustable: 4/8/12/16 kHz (P860/P861)	
GENERAL		
Power loss at P_N P_{Vmax}	1200 W	1450 W
Type of cooling (DIN 41751) Forced cooling / cooling air consumption	180 m ³ /h (108 ft ³ /min)	
Weight	26.3 kg (57.86 lb)	
Dimensions $W \times H \times D$	280 × 522 × 227 mm (11.02 × 20.55 × 8.94 in)	

*) applies to $f_{PWM} = 4 \text{ kHz}$

The performance data refer to the standard PWM frequency = 4 kHz (P860 / P861).

The permitted supply system and output currents are 20 % below the rated data at $V_{in} = 3 \times 500 \text{ V}_{AC}$.

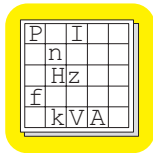

Size 5

MOVIDRIVE® MCF41A	0550-503-4-00	0750-503-4-00
Part number	826 847 9	826 848 7
INPUT		
Supply voltage V_{in}	3 x 230 V _{AC}	
Approved range	$V_{in} = 200 V_{AC} - 10\% - 240 V_{AC} + 10\%$	
Supply frequency f_{system}	50 Hz – 60 Hz ± 5 %	
Rated system current I_{system} 100 % (at $V_{in} = 3 \times 400 V_{AC}$) 125 %	94.5 A _{AC} 118.1 A _{AC}	117.0 A _{AC} 146.3 A _{AC}
OUTPUT		
Output rated power P_N (at $V_{in} = 3 \times 380 - 500 V_{AC}$)	73.5 kVA	91 kVA
Output rated current I_N (at $V_{in} = 3 \times 400 V_{AC}$)	105 A _{AC}	130 A _{AC}
Speed range n_A	-5000 – 0 – 5000 rpm	
Resolution Δn_A	0.2 rpm over the entire range	
Constant load Recommended motor power P_{mot}	55 kW (75 HP)	75 kW (100 HP)
Variable torque load and constant load without overload Recommended motor power P_{mot}	75 kW (100 HP)	90 kW (120 HP)
Continuous output current = 125 % $I_N^*)$ I_D (at $V_{in} = 3 \times 400 V_{AC}$)	131 A _{AC}	162 A _{AC}
Current limitation I_{max}	Motor: 150 % I_N Regenerative: 150 % I_N Duration dependent on utilization	
Internal current limitation	$I_{max} = 0 - 150\%$ can be set in menu (P303 / P313)	
Minimum approved braking resistance in 4Q operation R_{BR}	6 Ω	4 Ω
Output voltage V_O	max. V_{in}	
PWM frequency f_{PWM}	Adjustable: 4/8/12/16 kHz (P860/P861)	
GENERAL		
Power loss at P_N P_{Vmax}	1700 W	2000 W
Type of cooling (DIN 41751) Forced cooling / cooling air consumption	360 m ³ /h (216 ft ³ /min)	
Weight	34.3 kg (75.46 lb)	
Dimensions $W \times H \times D$	280 × 610 × 330 mm (11.02 × 24.02 × 12.99 in)	

*) applies to $f_{PWM} = 4$ kHz

The performance data refer to the standard PWM frequency = 4 kHz (P860 / P861).

The permitted supply system and output currents are 20 % below the rated data at $V_{in} = 3 \times 500 V_{AC}$.

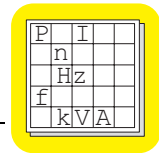

6.4 Electronics data

MOVIDRIVE® compact MCF41A		General electronics data																					
Setpoint entry via PROFIBUS-DP interface		PROFIBUS-DP to EN 50170 V2 (DIN E 19245 P3). Automatic detection of baud rate from 9.6 kbaud to 12 Mbaud. 9-pin sub D connector, pin assignment to EN 50170 (DIN 19245 P1). Can be activated for cable type A to EN 50170 (DIN E 19245 P3) 0 – 125, can be set using DIP switch. SEW_6002.GSD 6002hex (24578dez)																					
Setpoint input n2 / TF/TH input	X10:6	Analog input 0 – 10 V or optionally (→ P120) TF/TH input with response threshold at $R_{TF} \geq 2.9 \text{ k}\Omega \pm 10 \%$																					
Internal setpoints		n11/n12/n13 or n21/n22/n23 = -5000 – 0 – +5000 rpm																					
Speed ramps – time ranges at $\Delta n = 3000 \text{ rpm}$		<table border="0"> <tr> <td>1st ramp</td> <td>t11/t21</td> <td>Up: 0.0 – 2000 s</td> <td>Down: 0.0 – 2000 s</td> </tr> <tr> <td>2nd ramp</td> <td>t12/t22</td> <td colspan="2">Up=Down: 0.0 – 2000 s</td> </tr> <tr> <td>Stop ramp</td> <td>t13/t23</td> <td colspan="2">Down: 0 – 20 s</td> </tr> <tr> <td>Emergency ramp</td> <td>t14/t24</td> <td colspan="2">Down: 0 – 20 s</td> </tr> <tr> <td>Motor potentiometer</td> <td>t3</td> <td>Up: 0.2 – 50 s</td> <td>Down: 0.2 – 50 s</td> </tr> </table>		1st ramp	t11/t21	Up: 0.0 – 2000 s	Down: 0.0 – 2000 s	2nd ramp	t12/t22	Up=Down: 0.0 – 2000 s		Stop ramp	t13/t23	Down: 0 – 20 s		Emergency ramp	t14/t24	Down: 0 – 20 s		Motor potentiometer	t3	Up: 0.2 – 50 s	Down: 0.2 – 50 s
1st ramp	t11/t21	Up: 0.0 – 2000 s	Down: 0.0 – 2000 s																				
2nd ramp	t12/t22	Up=Down: 0.0 – 2000 s																					
Stop ramp	t13/t23	Down: 0 – 20 s																					
Emergency ramp	t14/t24	Down: 0 – 20 s																					
Motor potentiometer	t3	Up: 0.2 – 50 s	Down: 0.2 – 50 s																				
Auxiliary power supply output VO24**)	X10:16	U = 24 V _{DC} , current carrying capacity $I_{\max} = 200 \text{ mA}$																					
External voltage supply VI24*)	X10:24	$U_N = 24 \text{ V}_{DC} -15 \% / +20 \%$ (range 19.2 – 30 V _{DC}) to EN 61131-2																					
Binary inputs DIØØ – DIØ5		Isolated via optocoupler (EN 61131-2)	$R_i \approx 3.0 \text{ k}\Omega$ $I_E \approx 10 \text{ mA}$ Sampling Interval: 5 ms PLC compatible																				
Signal level		+13 – +30 V \triangleq "1" -3 – +5 V \triangleq "0"	= Contact closed = Contact open To EN 61131-2																				
Control functions		X10:9 DIØØ: with fixed assignment "/Controller inhibit" X10:10 – X10:14 DIØ1 – DIØ5: → Menu P60_																					
Binary outputs DBØØ**)/DOØ2**)		PLC compatible (EN 61131-2), response time: 5 ms																					
Signal level		X10:21/X10:19 "0" = 0 V "1" = 24 V	Important: Do not apply external voltage!																				
Control functions		X10:21*) DBØØ: with fixed assignment "/Brake", $I_{\max} = 150 \text{ mA}$ (short-circuit proof) X10:19*) DOØ2: → Menu P62_, $I_{\max} = 50 \text{ mA}$ (short-circuit proof)																					
Relay output DOØ1		X10:18 DOØ1-C: Shared relay contact → Menu P62_ X10:20 DOØ1-NO: NO contact X10:22 DOØ1-NC: NC contact	Load capacity: $U_{\max} = 30 \text{ V}$ $I_{\max} = 800 \text{ mA}$																				
System bus SC		X10:5 SC11: High X10:7 SC12: Low	CAN bus to CAN specification 2.0, parts A and B, transmission technology to ISO 11898, default setting 500 kbaud (P816) connection → Sec. 3.15, max. 64 participants Terminating resistor (120 Ω) can be activated via DIP switch (S12)																				
Reference terminals		X10:8 AGND: Reference potential for analog signal n2 X10:17/X10:23 DGND: Reference potential for binary signals X10:15 DCOM: Reference for binary inputs X10:9 – X10:14																					
Permitted line cross section		Single core: 0.20 – 1.5 mm ² (AWG24 – 16) Double core: 0.20 – 1 mm ² (AWG24 – 17)																					

*) The unit must always be supplied with 24 V_{DC} at terminal X10:24 (VI24). This external 24 V voltage supply must be able to provide a current of 2.5 A for supplying the unit's electronics and the 24 V outputs X10:16 VO24, X10:21 DBØØ and X10:19 DOØ2.

**) The maximum total current which may be applied to the 24 V outputs X10:16 VO24, X10:21 DBØØ and X10:19 DOØ2 is I_{\max} 400 mA.



A

Accessories

- Power shield clamp 19
- Touchguard 20

Assignment of braking resistors, chokes, filters

- 230 V units 25
- 400/500 V units 26

C

Connection

- Control module 22
- Option USS21A (RS-232 and RS-485) 29
- Power section and brake 21
- System bus (SBus) 28

D

DBG11A keypad

- Basic displays 65
- Copy function 65
- Menu structure 66
- Quick menu 67

F

Fault information

- Fault memory 69
- Reset 69
- Shut-off responses 69

G

GSD file 5

I

Important Notes 4

Information messages 68

Installation

- EMC compliant 17
- Instructions 12
- PROFIBUS system 14
- UL compliant 18

L

List of faults 70

M

Manual mode 40

N

Nameplate 7

O

Operation LED V1 64

P

Parameter list

- 0__ Display values 41
- 1__ Setpoints/ramp generators 42
- 3__ Motor parameters / 4__ Reference signals 43

5__ Monitoring functions / 6__ Terminal assignment 44

7__ Control functions / 8__ Unit functions 45

8__ Unit functions 46

Parameter setting

- Incorrect performance 57
- Parameter index 55
- Return codes 58
- via parameter channel 55
- via PROFIBUS-DP 55

PROFIBUS

- Data consistency 48
- Diagnostic LEDs 64
- External diagnosis 49
- Fault diagnosis 72
- Parameter setting data 49
- Process data configuration 47
- Reading drive parameter 61
- Simatic S7 49
- Startup DP master 5, 39
- Startup inverter 39
- writing drive parameter 62

R

Read

- via DP 61

Removing the terminal unit 24

S

Safety Notes 6

Scope of delivery 7

Serial interface 29

Service

- Send in for repair 74
- Service label 74

Startup

- General instructions 30
- Language change on the DBG11A 32
- Preliminary work and tools 31

Startup with DBG11A

- General 32
- Startup procedure 34
- Structure of the startup menu 33
- with non-SEW motors 35
- with SEW motors 35

Startup with MX_SHELL

- General 36
- with non-SEW motors 37
- with SEW motors 36

System bus 28

T

Technical Data

- 230 V units 76
- Size 1 76
- Sizes 2 and 3 77
- 400/500 V units 78
- Size 1 78



Size 2	79
Size 3	80
Size 4	81
Size 5	82
Electronics data	83
General	75

Terminals

Functional description	23
------------------------	----

U

Unit design

Size 1	8
Size 2	9
Size 3	10
Sizes 4 and 5	11

Unit designation 7

W

Write

via DP	62
--------	----



Index

Service and spare parts



Germany	Headquarters Manufacture Sales, Service	Bruchsal	SEW-EURODRIVE GmbH & Co Ernst-Blickle-Straße 42 D-76646 Bruchsal Postfach 3023, D-76642 Bruchsal	Tel. (0 72 51) 75-0 Telefax (0 72 51) 75-19 70 Telex 7 822 391 http://www.SEW-EURODRIVE.com sew @ sew-eurodrive.com
	Manufacture	Graben	SEW-EURODRIVE GmbH & Co Ernst-Blickle-Straße 1 D-76676 Graben-Neudorf Postfach 1220, D-76671 Graben-Neudorf	Tel. (0 72 51) 75-0 Telefax (0 72 51) 75-29 70 Telex 7 822 276
	Assembly Service	Garbsen (near Hannover)	SEW-EURODRIVE GmbH & Co Alte Ricklinger Straße 40-42 D-30823 Garbsen Postfach 110453, D-30804 Garbsen	Tel. (0 51 37) 87 98-30 Telefax (0 51 37) 87 98-55
		Kirchheim (near München)	SEW-EURODRIVE GmbH & Co Domagkstraße 5 · D-85551 Kirchheim	Tel. (0 89) 90 95 52-10 Telefax (0 89) 90 95 52-50
Langenfeld (near Düsseldorf)		SEW-EURODRIVE GmbH & Co Siemensstraße 1, D-40764 Langenfeld	Tel. (0 21 73) 85 07-30 Telefax (0 21 73) 85 07-55	
		Meerane (near Zwickau)	SEW-EURODRIVE GmbH & Co Dänkritzer Weg 1, D-08393 Meerane	Tel. (0 37 64) 76 06-0 Telefax (0 37 64) 76 06-30
France	Headquarters Manufacture Service	Haguenau	SEW-USOCOME S.A. 48-54, route de Soufflenheim B. P. 185 F-67506 Haguenau Cedex	Tel. 03 88 73 67 00 Telefax 03 88 73 66 00 Telex: 870 033 http://www.usocome.com sew@usocome.com
	Manufacture	Forbach	SEW-EUROCOME S.A. Zone industrielle Technopole Forbach Sud B. P. 30269, F-57604 Forbach Cedex	
	Assembly Service Technical Offices	Bordeaux	SEW-USOCOME Parc d'activités de Magellan 62, avenue de Magellan - B. P. 182 F-33607 Pessac Cedex	Tel. 05 57 26 39 00 Telefax 05 57 26 39 09
Paris		SEW-USOCOME Zone industrielle, 2, rue Denis Papin F-77390 Verneuil l' Etang	Tel. 01 64 42 40 80 Telefax 01 64 42 40 88	
Australia	Assembly Sales, Service	Melbourne	SEW-EURODRIVE PTY. LTD. 27 Beverage Drive Tullamarine, Victoria 3043	Tel. (03) 93 38-79 11 Telefax (03) 93 30-32 31 + 93 35 35 41
		Sydney	SEW-EURODRIVE PTY. LTD. 9, Sleigh Place, Wetherill Park Sydney N. S. W. 2164	Tel. (02) 97 56 10 55 Telefax (02) 97 56 10 05
Austria	Assembly Sales, Service	Wien	SEW-EURODRIVE Ges.m.b. H. Industriestraße B4 A-2345 Brunn a. Geb. bei Wien	Tel. (0 22 36) 3 16 31 Telefax (0 22 36) 3 33 85
Belgium	Assembly Sales, Service	Bruxelles	CARON-VECTOR S.A. Avenue Eiffel 5 B-1300 Wavre	Tel. (010) 23 13 11 Telefax (010) 23 13 36 http://www.caron-vector.be info@caron-vector.be
Brazil	Manufacture Sales, Service	São Paulo	SEW DO BRASIL Motores-Redutores Ltda. Caixa Postal 201-0711-970 Rodovia Presidente Dutra km 213 CEP 07210-000 Guarulhos-SP	Tel. (011) 64 60-6433 Telefax (011) 64 80-43 43 E-Mail: sew.brasil@originet.com.br
Canada	Assembly Sales, Service	Toronto	SEW-EURODRIVE CO. OF CANADA LTD. 210 Walker Drive, Bramalea, Ontario L6T3W1	Tel. (905) 7 91-15 53 Telefax (905) 7 91-29 99
		Vancouver	SEW-EURODRIVE CO. OF CANADA LTD. 7188 Honeyman Street, Delta. B.C. V4G 1 E2	Tel. (604) 2 72 42 88 + 9 46 55 35 Telefax (604) 946-2513
		Montreal	SEW-EURODRIVE CO. OF CANADA LTD. 2555 Rue Leger Street LaSalle, Quebec H8N 2V9	Tel. (514) 3 67-11 24 Telefax (514) 3 67-36 77
Chile	Assembly Sales, Service	Santiago de Chile	SEW-EURODRIVE CHILE Motores-Redutores LTDA. Panamericana Norte Nº 9261 Casilla 23-Correo Quilicura RCH-Santiago de Chile	Tel. (02) 6 23 82 03 + 6 23 81 63 Telefax (02) 6 23 81 79
China	Manufacture Assembly Sales, Service	Tianjin	SEW-EURODRIVE (Tianjin) Co., LTD No. 46, 7th Avenue, TEDA Tianjin 300457	Tel. (022) 25 32 26 12 Telefax (022) 25 32 26 11
Denmark	Assembly Sales, Service	Kopenhagen	SEW-EURODRIVE A/S Geminivej 28-30, P.O. BoX 100 DK-2670 Greve	Tel. 4395 8500 Telefax 4395 8509
Finland	Assembly Sales, Service	Lahti	SEW-EURODRIVE OY Vesimäentie 4, FIN-15860 Hollola2	Tel. (3) 58 93 00 Telefax (3) 7 80 62 11
Great Britain	Assembly Sales, Service	Normanton	SEW-EURODRIVE Ltd. Beckbridge Industrial Estate P.O. Box No. 1 GB-Normanton, West-Yorkshire WF61 QR	Tel. 1 9 24 89 38 55 Telefax 1 9 24 89 37 02
Hong Kong	Assembly Sales, Service	Hong Kong	SEW-EURODRIVE LTD. Unit No.801-806, 8th Floor Hong Leong Industrial Complex No. 4, Wang Kwong Road Kowloon, Hong Kong	Tel. 2-7 96 04 77 + 7 96 04 65 Telefax 2-795-91 29

Service and spare parts



Italy	Assembly Sales, Service	Milano	SEW-EURODRIVE di R. Blickle & Co. s.a.s. Via Bernini, 14, I-20020 Solaro (Milano)	Tel. (02) 96 79 97 71 Telefax (02) 96 79 97 81
Japan	Assembly Sales, Service	Toyoda-cho	SEW-EURODRIVE JAPAN CO., LTD. 250-1, Shimoman-no, Toyoda-cho, Iwata-gun Shizuoka prefecture, P.O. Box 438-0818	Tel. (053 83) 7 38 11-13 Telefax (053 83) 7 38 14
Korea	Assembly Sales, Service	Ansan	SEW-EURODRIVE CO., LTD. B 601-4, Banweol Industrial Estate 1048-4, Shingil-dong, Ansan 425-120	Tel. (03 45) 4 92-80 51 Telefax (03 45) 4 92-80 56
Malaysia	Assembly Sales, Service	Johore	SEW-EURODRIVE Sdn. Bhd. 95, Jalan Seroja 39 81100 Johore Bahru, Johore	Tel. (07) 3 54 57 07 + 3 54 94 09 Telefax (07) 3 5414 04
Netherlands	Assembly Sales, Service	Rotterdam	VECTOR Aandrijftechniek B.V. Industrieweg 175 NL-3044 AS Rotterdam Postbus 10085, N L-3004 AB Rotterdam	Tel. (010) 4 46 37 00 Telefax (010) 4 15 55 52
New Zealand	Assembly Sales, Service	Auckland	SEW-EURODRIVE NEW ZEALAND LTD. P.O. Box 58-428 82 Greenmount Drive, East Tamaki, Auckland	Tel. (09) 2 74 56 27 2 74 00 77 Telefax (09) 2 74 01 65
Norway	Assembly Sales, Service	Moss	SEW-EURODRIVE A/S Solgaard skog 71, N-1539 Moss	Tel. (69) 24 10 20 Telefax (69) 24 10 40
Portugal	Assembly Sales, Service	Coimbra	SEW-EURODRIVE, LDA. Apartado 15, 3050 Mealhada	Tel. (031) 20 96 70 Telefax (031) 20 36 85
Singapore	Assembly Sales, Service	Singapore	SEW-EURODRIVE PTE. LTD. No 9, Tuas Drive 2, Jurong Industrial Estate Singapore 638644 Jurong Point Post Office, P.O. Box 813 Singapore 916428	Tel. 86 21 701-705 Telefax 8 61 28 27 Telex: 38 659
South Africa	Assembly Sales, Service	Johannesburg	SEW-EURODRIVE (PROPRIETARY) LIMITED Eurodrive House Cnr. Adcock Ingram and Aerodrome Roads Aeroton Ext. 2, Johannesburg 2013 P.O. Box 27032, 2011 Benrose, Johannesburg	Tel. (2711) 4 94 43 80 Telefax (2711) 4 94 23 00
		Capetown	Gearedmotors of South Africa Pty. Ltd. Rainbow Park Cnr. Racecourse & Omuramba Road Montague Gardens, 7441 Cape Town P.O.Box 53 573 Racecourse Park, 7441 Cape Town	Tel. (021) 5 11 09 87 Telefax (021) 5 11 44 58 Telex: 576 062
		Durban	Gearedmotors of South Africa Pty. Ltd. 39 Circuit Road, Westmead, Pinetown P.O. Box 10433, Ashwood 3605	Tel. (031) 7 00 34 51 Telex: 622 407
Spain	Assembly Sales, Service	Bilbao	SEW-EURODRIVE ESPAÑA, S.L. Parque Tecnológico, Edificio, 302 E-48170 Zamudio (Vizcaya)	Tel. 9 44 31 84 70 Telefax 9 44 31 84 71
Sweden	Assembly Sales, Service	Jönköping	SEW-EURODRIVE AB Gnejsvägen 6-8 S-55303 Jönköping	Tel. (036) 16 50 70 Telefax (036) 16 44 69 Telex: 70162
Switzerland	Assembly Sales, Service	Basel	Alfred Imhof A.G. Jurastrasse 10 CH-4142 Munchenstein bei Basel	Tel. (061) 4 17 17 17 Telefax (061) 4 17 17 00
Thailand	Assembly	Chon Buri	SEW-EURODRIVE (Thailand) Ltd. Bangpakong Industrial Park 2 700/456, M007, Tambol Bonhwaroh Muang District, Chon Buri 20000	Tel. 0066-38 21 45 29/30 Telefax 0066-38 21 45 31
Turkey	Assembly Sales, Service	Istanbul	SEW-EURODRIVE Hareket Sistemleri Ticaret Ltd. Sirketi Bagdat Cad. Koruma Cikmazi No. 3 TR-81540 Maltepe ISTANBUL	Telefon (216) 4 41 91 63 + 4 41 91 64 + 3 83 80 14 + 3 83 80 15 Telefax (216) 3 05 58 67
USA	Manufacture Assembly Sales, Service	Greenville	SEW-EURODRIVE INC. 1275 Old Spartanburg Highway P.O. Box 518 Lyman, S.C. 29365	Tel. (864) 4 39-75 37 Telefax Sales (864)439-78 30 Telefax Man. (864) 4 39-99 48 Telefax Ass. (864) 4 39-05 66 Telex: 805 550
		San Francisco	SEW-EURODRIVE INC. 30599 San Antonio Road P.O. Box 3910, Hayward California 94544	Tel. (510) 4 87-35 60 Telefax (510) 4 87-63 81
	Assembly Sales, Service	Philadelphia/PA	SEW-EURODRIVE INC. Pureland Ind. Complex 200 High Hill Road, P.O. Box 481 Bridgeport, New Jersey 08014	Tel. (609) 4 67-22 77 Telefax (609) 8 45-31 79
		Dayton	SEW-EURODRIVE INC. 2001 West Main Street Troy, Ohio 45373	Tel. (513) 3 35-00 36 Telefax (513) 2 22-41 04 Telex: 6 874 204
		Dallas	SEW-EURODRIVE INC. 3950 Platinum Way, Dallas, Texas 75237	Tel. (214) 3 30-48 24 Telefax (214) 3 30-47 24
Venezuela	Assembly Sales, Service	Caracas	Edif. Asea Brown Boveri Av. Diego Cisneros Los Ruices	Tel. (02) 2 39 64 33 + 2 38 24 22 + 2 38 24 11 Telefax (02) 2 39 63 83 + 2 39 58 34 Telex: 2 52 49 + 2 52 65

**We are available, wherever you need us.
Worldwide.**

SEW-EURODRIVE right around the globe is
your competent partner in matters of power

transmission with manufacturing and assem-
bly plants in most major industrial countries.



**SEW
EURODRIVE**

SEW-EURODRIVE GmbH & Co · P.O.Box 30 23 · D-76642 Bruchsal/Germany
Tel. +49-7251-75-0 · Fax +49-7251-75-19 70 · Telex 7 822 391
<http://www.SEW-EURODRIVE.com> · sew@sew-eurodrive.com