



11/91 AWA 27-772

## SUCOS PS 316

### Allgemeine Hinweise

#### Transport, Lagerung, Austausch

Zur Verhinderung elektrostatischer Entladungen empfehlen wir, die Baugruppen nur am Griff und/oder an der Frontplatte anzufassen.



**Die Baugruppen nur bei spannungsloser PS ziehen oder stecken.  
Baugruppencodierung beachten!**

### General notes

#### Transport, storage, exchange

In order to prevent cards being damaged, we recommend that you hold the cards only by the handle and/or the front plate.



**Switch off PS316 before inserting or removing the cards.  
Note the coding of the cards!**

### Remarques générales

#### Transport, stockage, remplacement

Afin d'éviter les décharges électrostatiques, il est recommandé de ne saisir les modules que par la poignée et/ou le plastron.



**Avant d'embrocher ou de débrocher un module, mettre toujours l'automate  
hors tension.  
Attention au codage des modules!**

### Istruzioni generali

#### Trasporto, montaggio, sostituzione

Per evitare che le schede vengano danneggiate si raccomanda di prenderle solo per l'impugnatura e/o sulla piastra frontale.



**Togliere tensione al PS 316 prima di inserire o rimuovere i moduli.  
Fare attenzione alla codifica della scheda!**

### Indicaciones generales

#### Transporte, almacenamiento, sustitución

Para evitar daños en la tarjeta, recomendamos sujetarla solo desde la maneta y/o de la placa frontal.



**Las tarjetas deben insertarse o extraerse sólo con el PS desconectado.  
¡Atención a la codificación de las tarjetas!**

## Baugruppenträgeranordnung

## Rack arrangement

## Disposition des racks

## Disposizione dei rack

## Disposición de los racks

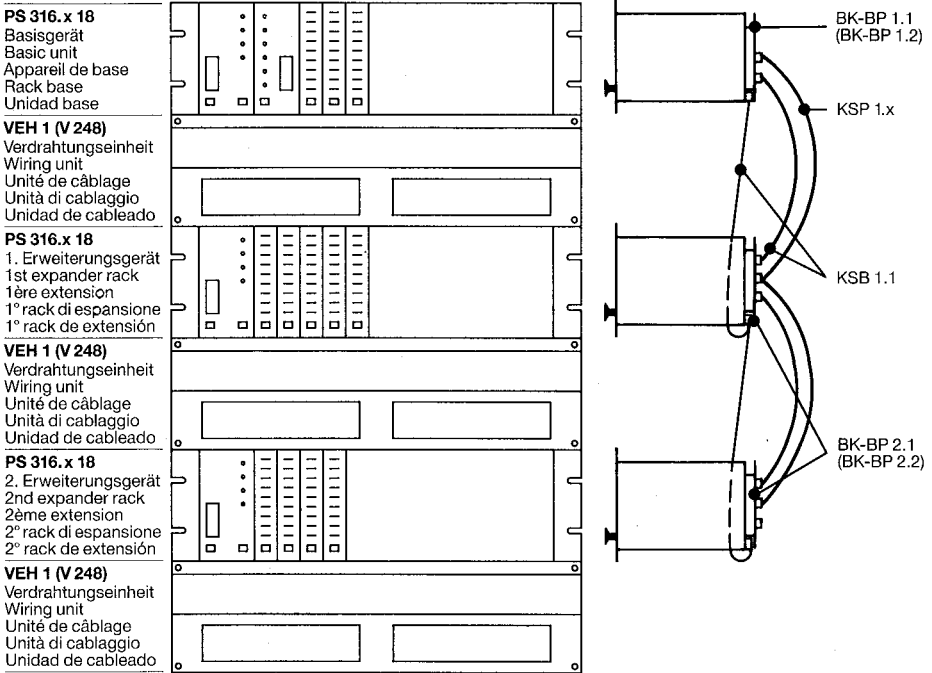

### Achtung:

Typen BK-BPx.1 und BK-BPx.2 nicht gemischt in einem Aufbau verwenden.

### Attention:

Types BK-BPx.1 and BK-BPx.2 cannot be mixed.

### Attention:

Les types BK-BPx.1 et BK-BPx.2 ne doivent pas être combinés.

### Attenzione:

I tipi BK-BPx.1 e BK-BPx.2 non possono essere utilizzati assieme.

### Atención:

Los tipos BK-BPx.1 y BK-BPx.2 no deben mezclarse.

### Montage der Basisgeräte PS 316.x 08 und PS 316.x 12

Kabelklammern aufkleben, Klebestellen vorher mit fettlösendem Reinigungsmittel säubern.

### Fitting the PS 316.x 08 and PS 316.x 12 basic units

Stick the cable clamp in place after cleaning area with a degreasing agent.

### Montage des appareils de base PS 316.x 08 et PS 316.x 12

Coller les attaches de câbles après avoir nettoyé les emplacements avec un solvant de graisses.

### Montaggio dei rack base PS 316.x 08 e PS 316.x 12

Incollare il guida cavo dopo aver pulito la superficie con un solvente per grassi.

### Montaje de las unidades base PS 316.x 08 y PS 316.x 12

Pegar los sujetacables después de limpiar el área con un desengrasante.

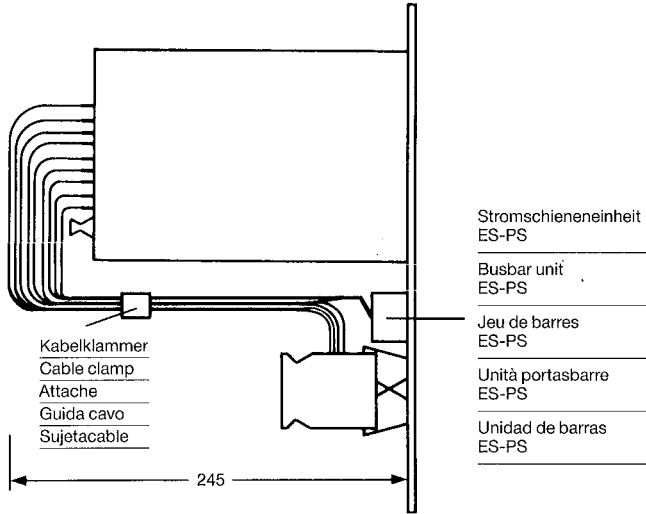

### Verdrahtung

110-V-/220-V- AC-Leitungen sind getrennt von 24-V-DC-Leitungen zu verlegen.

### Wiring

110V/220V a.c. cables are to be laid separately from 24V d.c. cables.

### Câblage

Les lignes 110V/220V CA doivent être posées séparément des lignes 24V CC.

### Cablaggio

Le linee a 110V/220V AC devono essere separate dalle linee a 24V DC

### Conexión

Los cables de 110V/220V AC deben quedar separados de los cables de 24V DC.

# Steckplatzbelegung des Basisgerätes

## Module location of the basic unit

## Affectation des postes d'enchâfrage de l'appareil de base

## Inserimento dei moduli sul rack base

## Ubicación de las tarjetas en la unidad base

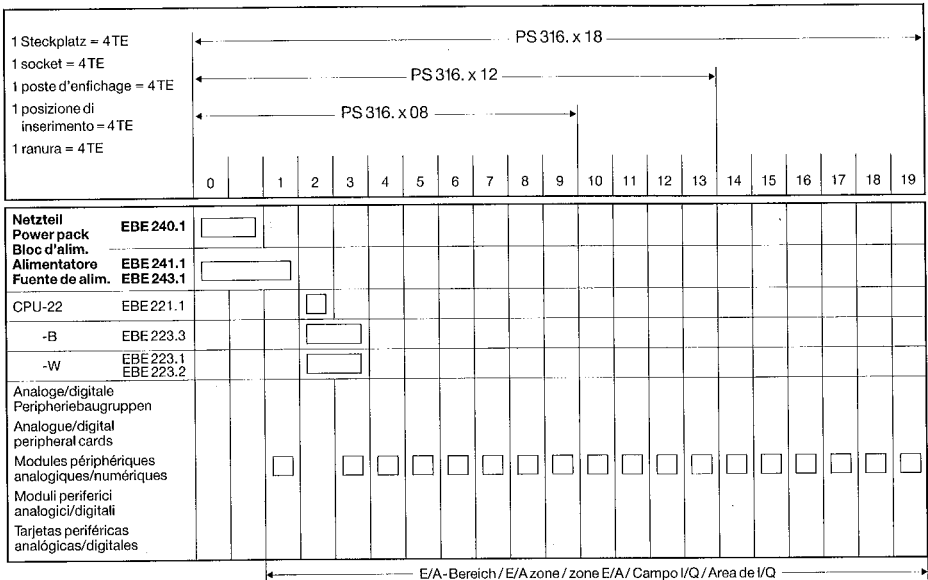

## Systemausbau

Maximal 1 Basisgerät + 4 Erweiterungsgeräte mit BK-BP x. 1  
maximal 1 Basisgerät + 7 Erweiterungsgeräte mit BK-BP x.2  
Bei mehr als 2 Erweiterungsgeräten muß ein Netzfilter FIL-PS vor die Netzteile EBE 241.1 geschaltet werden.

**ACHTUNG:**  
Bei Aufbauten mit mehr als 4 Erweiterungsgeräten müssen für alle Geräte die Buskoppeleinheiten BK-BP x.2 verwendet werden.

---

## System Expansion

Max. 1 basic unit + 4 expander racks with BK-BP x.1  
Max. 1 basic unit + 7 expander racks with BK-BP x.2  
An FIL-PS mains filter must be connected in front of the EBE 241.1 power supply units if more than 2 expander racks are used.

**CAUTION:**  
The BK-BP x.2 bus coupling units must be used for all systems involving more than 4 expander racks.

---

## Extension du système

Max. 1 appareil de base + 4 appareils d'extension avec BK-BP x.1  
Max. 1 appareil de base + 7 appareils d'extension avec BK-BP x.2  
S'il y a plus de 2 appareils d'extension, un filtre d'alimentation doit être connecté en série avec les blocs d'alimentation EBE 241.1

**ATTENTION:**  
Pour les systèmes avec plus de 4 appareils d'extension, les unités de couplage pour bus BK-BP x.2 doivent être utilisés pour tous les appareils.

---

## Espansione del sistema

Max. 1 rack base + 4 rack espansione con BK-BP x.1  
Max. 1 rack base + 7 rack espansione con BK-BP x.2  
Se vengono utilizzati più di 2 rack di espansione deve essere montato un filtro di alimentazione sul lato frontale dell'alimentatore EBE 241.1.

**ATTENZIONE:**  
Per i sistemi con più di 4 rack di espansione devono essere utilizzate le unità di accoppiamento bus BK-BP x.2.

---

## Configuración del sistema

1 unidad base + 4 racks de extensión con BK-BP x.1 como máximo  
1 unidad base + 7 racks de extensión con BK-BP x.2 como máximo  
En sistemas con más de 2 racks de extensión debe utilizarse un filtro FIL-PS para las fuentes de alimentación EBE 241.1

**ATENCION:**  
En sistemas con más de 4 racks de extensión deben utilizarse en todos los racks las tarjetas de acoplamiento de bus BK-BP x.2.

# Buskopplung zu Erweiterungsgeräten

## Bus coupling for expander racks

### Couplage des bus pour appareils d'extension

### Collegamento bus per rack di espansione

### Acoplamiento de bus a racks de extensión

#### Montage

#### Installation

#### Montage

#### Montaggio

#### Montaje

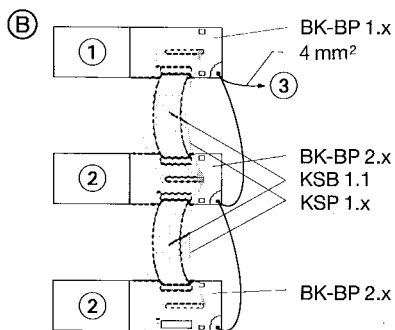
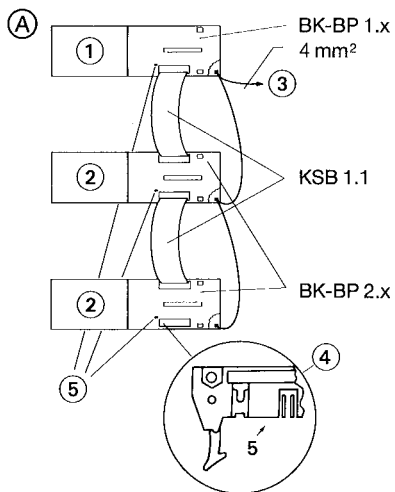
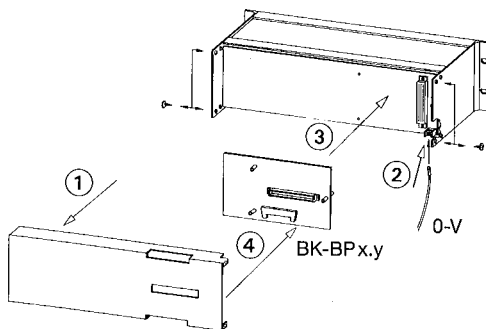

## Kodierung / Kabelanschluß

- Ⓐ Bit-I/O-Buskopplung
  - Ⓑ Parallelbuskopplung
- ① Basisgerät (Rückseite)
  - ② Erweiterungsgerät (Rückseite)
  - ③ Bei Betrieb mit potentialgebundenen Baugruppen (z. B. EBE 200, EBE 250): 0-V-Brücke zur Spannungsversorgung der potentialgebundenen Baugruppe.
  - ④ Jumper auf Stiftpaar Nr. 5 (von links)
  - ⑤ Kodierbrücke: immer offen
- 

## Coding / Cable connection

- Ⓐ Bit-I/O-Bus coupling
  - Ⓑ Parallel bus coupling
- ① Basic unit (rear)
  - ② Expander unit (rear)
  - ③ For potential-dependent modules, e. g. EBE 200 and EBE 250, connect the 0V-bridge to the power supply of the potential-dependent module concerned.
  - ④ Jumper on pin pair No. 5 (from left)
  - ⑤ Coding: always open
- 

## Codage / Raccordement des câbles

- Ⓐ Couplage de bus bit E/S
  - Ⓑ Couplage de bus parallèle
- ① Appareil de base (face arrière)
  - ② Appareil d'extension (face arrière)
  - ③ Pour opération sous potentiel (EBE 200, EBE 250): Pont 0V pour bloc d'alimentation des modules sous potentiel.
  - ④ Shunt sur paire de broches no. 5 (vu de gauche)
  - ⑤ Codage: toujours ouvert
- 

## Codifica / collegamento cavi

- Ⓐ Collegamento del bus a bit I/O
  - Ⓑ Collegamento del bus parallelo
- ① Rack di base (retro)
  - ② Rack di espansione (retro)
  - ③ Per il funzionamento con moduli non separati galvanicamente (p. es. EBE 200, EBE 250) ponte 0V per l'alimentazione dei moduli non separati galvanicamente.
  - ④ Jumper su coppia di spine N° 5 (da sinistra)
  - ⑤ Ponte di codifica: sempre aperto.
- 

## Codificación / Conexión de cables

- Ⓐ Acoplamiento del bus de I/Q de bit
  - Ⓑ Acoplamiento del bus paralelo
- ① Unidad base (parte posterior)
  - ② Rack de extensión (parte posterior)
  - ③ Al usar tarjetas con potencial (p. e. EBE 200, EBE 250): puente 0V a la alimentación de la tarjeta con potencial.
  - ④ Puente en pins N° 5 (desde la izquierda)
  - ⑤ Codificación: siempre abierto
-

## Stromversorgungen

Eine Kombination der Typen EBE241.1 und EBE243.1 in einem Aufbau ist unzulässig. EBE 240.1 nur für Einzelgeräte verwenden.

### Kodierung der EBE 241.1 / EBE 243.1

- ① Überwachungsfunktionen (BUS aktiv und LOOP)

---

## Power supplies

A combination of types EBE 241.1 and EBE 243.1 is not permissible. Use type EBE 240.1 only for basic units without expander racks.

### Coding of EBE 241.1 / EBE 243.1

- ① Monitoring functions (BUS ACTIVE with LOOP)

---

## Alimentations

L'utilisation simultanée des EBE 241.1 et EBE 243.1 est interdite. Utiliser EBE 240.1 seulement pour appareils de base sans appareils d'extension.

### Codage de l'EBE 241.1 / EBE 243.1

- ① Fonctions de surveillance (BUS ACTIVE et LOOP)

---

## Alimentazione

Non è possibile la combinazione dei moduli EBE 241.1 e EBE 243.1 nella stessa configurazione. Utilizzare il tipo EBE 240.1 solo per rack base senza rack espansione.

### Codifica dell'EBE 241.1 / EBE 243.1

- ① Funzioni di controllo (BUS ATTIVO e LOOP)

---

## Fuentes de alimentación

Una combinación de las tarjetas EBE 241.1 y EBE 243.1 en el mismo sistema no está permitido. La tarjeta EBE 240.1 debe utilizarse solo en unidades base (sin racks de extensión).

### Codificación de la EBE 241.1 / EBE 243.1

- ① Función de supervisión (BUS ACTIVO y LOOP)



EBE 241.1/  
EBE 243.1

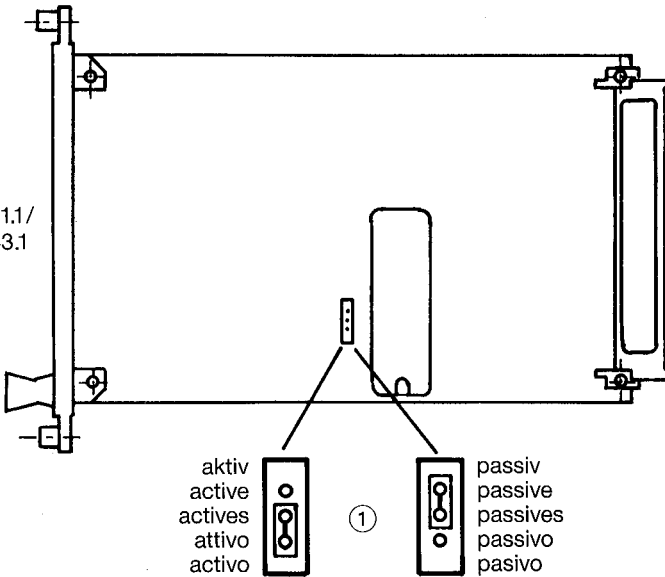

**Achtung!**

Bei Parallelbusbetrieb ist nur die Kodierung „aktiv“ erlaubt!

**Caution!**

Only “active” coding permissible with parallel bus operation.

**Attention!**

En cas de fonctionnement avec bus parallèle, seul le codage «actives» est admis.

**Attenzione!**

In caso di funzionamento con bus parallelo è ammessa soltanto una codifica “attiva”.

**¡Atención!**

En caso de funcionamiento con el bus paralelo, sólo se permite la codificación “activo”.

# Maßtabellen / Dimensions / Encombres / Dimensioni / Dimensiones

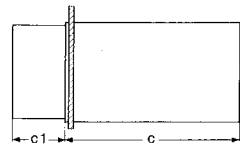
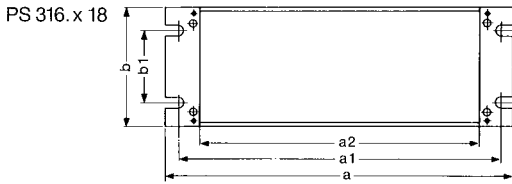

PS 316. x 18

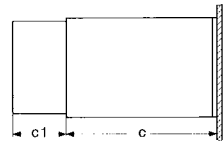
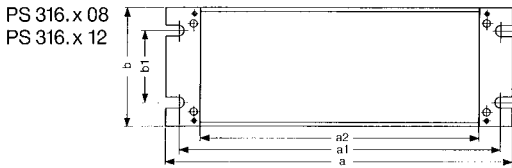

PS 316. x 08/ . x 12

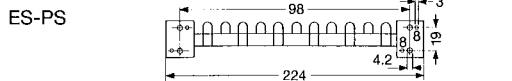
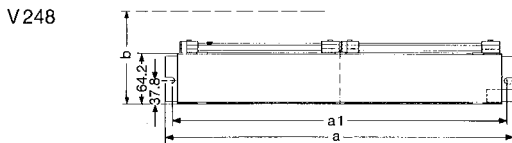
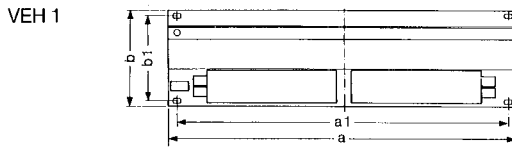

**Typ/Type/Référence**

| Tipo/Tipo           | a   | a1  | a2  | b     | b1    | c   | c1 |
|---------------------|-----|-----|-----|-------|-------|-----|----|
| <b>PS 316. x 08</b> | 288 | 275 | 255 | 132,5 | 100   | 205 | —  |
| <b>dito +SAM</b>    |     |     |     |       |       | —   | 50 |
| <b>dito +SEM</b>    |     |     |     |       |       | —   | 68 |
| <b>dito +S2...</b>  |     |     |     |       |       | —   | 70 |
| <b>PS 316. x 12</b> | 362 | 350 | 336 | 132,5 | 100   | 205 | —  |
| <b>dito +SAM</b>    |     |     |     |       |       | —   | 50 |
| <b>dito +SEM</b>    |     |     |     |       |       | —   | 68 |
| <b>dito +S2...</b>  |     |     |     |       |       | —   | 70 |
| <b>PS 316. x 18</b> | 483 | 465 | 427 | 132,5 | 57    | 230 | —  |
| <b>dito +SAM</b>    |     |     |     |       |       | —   | 50 |
| <b>dito +SEM</b>    |     |     |     |       |       | —   | 68 |
| <b>dito +S2...</b>  |     |     |     |       |       | —   | 70 |
| <b>VEH 1</b>        | 483 | 465 | —   | 132,5 | 120,5 | —   | —  |
| <b>V248</b>         | 483 | 465 | —   | 88    | —     | —   | —  |
| <b>MBP 3</b>        | 483 | 465 | —   | 132,5 | 120,5 | —   | —  |
| <b>MBP 1</b>        | 483 | 465 | —   | 43,6  | 31,7  | —   | —  |



**Codierung** Alle Baugruppen dürfen nur bei ausgeschalteter Versorgungsspannung ausgewechselt werden.

**Coding** Cards must be exchanged only while the supply voltage is disconnected.

**Codage** Les modules doivent tous être remplacés hors tension.

**Codifica** Togliere tensione prima di inserire o rimuovere i moduli.

**Codificación** Las tarjetas deben insertarse o extraerse sólo con la alimentación desconectada.

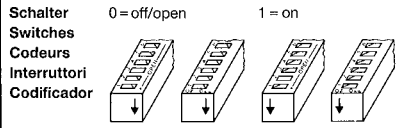

**Baugruppentyp / Module Type / Type de module /  
Tipi di moduli / Tipo de tarjeta**

**Schalternummer / Switch Number / No. de microrupteur /  
N° interruptore / N° de codificador**

| A             | B            | C            | D             | 1            |             |             |   |   | 2 |   |   |   |    |    |    |
|---------------|--------------|--------------|---------------|--------------|-------------|-------------|---|---|---|---|---|---|----|----|----|
|               |              |              |               | 1            | 2           | 3           | 4 | 5 | 6 | 7 | 8 | 9 | 10 | 11 | 12 |
|               |              |              |               | 1            | 2           | 3           | 4 | 5 | 6 | 7 | 8 | 9 | 10 | 11 | 12 |
| 10.0...11.15  | 10.0...10.15 | 10.0...10.7  | 10.0...10.3   | 1            | 1           | 1           | 0 | 1 | 0 | 1 | 0 | 1 | 1  |    |    |
|               |              |              | 10.4...10.7   | 0            | 1           | 1           | 0 | 1 | 0 | 1 | 0 | 1 | 1  |    |    |
|               |              |              | 10.8...10.15  | 1            | 0           | 1           | 0 | 1 | 0 | 1 | 0 | 1 | 1  |    |    |
| 11.0...11.15  | 11.0...11.15 | 11.0...11.7  | 10.12...10.15 | 0            | 0           | 1           | 0 | 1 | 0 | 1 | 0 | 1 | 1  |    |    |
|               |              |              | 11.0...11.3   | 1            | 1           | 0           | 0 | 1 | 0 | 1 | 0 | 1 | 1  |    |    |
|               |              |              | 11.4...11.7   | 0            | 1           | 0           | 0 | 1 | 0 | 1 | 0 | 1 | 1  |    |    |
|               |              |              | 11.8...11.15  | 1            | 0           | 0           | 0 | 1 | 0 | 1 | 0 | 1 | 1  |    |    |
|               |              |              | 11.12...11.15 | 0            | 0           | 0           | 0 | 1 | 0 | 1 | 0 | 1 | 1  |    |    |
|               |              |              | 12.0...12.15  | 12.0...12.15 | 12.0...12.7 | 12.0...12.3 | 1 | 1 | 1 | 1 | 0 | 0 | 1  | 0  | 1  |
| 12.4...12.7   | 0            | 1            | 1             |              |             | 1           | 0 | 0 | 1 | 0 | 1 |   |    |    |    |
| 12.8...12.15  | 1            | 0            | 1             |              |             | 1           | 0 | 0 | 1 | 0 | 1 |   |    |    |    |
| 12.12...12.15 | 0            | 0            | 1             |              |             | 1           | 0 | 0 | 1 | 0 | 1 |   |    |    |    |
| 13.0...13.7   | 1            | 1            | 0             |              |             | 1           | 0 | 0 | 1 | 0 | 1 |   |    |    |    |
| 13.4...13.7   | 0            | 1            | 0             |              |             | 1           | 0 | 0 | 1 | 0 | 1 |   |    |    |    |
| 13.8...13.15  | 13.8...13.15 | 13.8...13.15 | 13.8...13.11  | 1            | 0           | 0           | 1 | 0 | 0 | 1 | 0 | 1 |    |    |    |
|               |              |              | 13.12...13.15 | 0            | 0           | 0           | 1 | 0 | 0 | 1 | 0 | 1 |    |    |    |
|               |              |              | 14.0...14.7   | 1            | 1           | 1           | 0 | 0 | 0 | 1 | 0 | 1 |    |    |    |
|               |              |              | 14.4...14.7   | 0            | 1           | 1           | 0 | 0 | 0 | 1 | 0 | 1 |    |    |    |
|               |              |              | 14.8...14.15  | 1            | 0           | 1           | 0 | 0 | 0 | 1 | 0 | 1 |    |    |    |
|               |              |              | 14.12...14.15 | 0            | 0           | 1           | 0 | 0 | 0 | 1 | 0 | 1 |    |    |    |
| 15.0...15.15  | 15.0...15.15 | 15.0...15.7  | 15.0...15.3   | 1            | 1           | 0           | 0 | 0 | 0 | 1 | 0 | 1 |    |    |    |
|               |              |              | 15.4...15.7   | 0            | 1           | 0           | 0 | 0 | 0 | 1 | 0 | 1 |    |    |    |
|               |              |              | 15.8...15.15  | 1            | 0           | 0           | 0 | 0 | 0 | 1 | 0 | 1 |    |    |    |
|               |              |              | 15.12...15.15 | 0            | 0           | 0           | 0 | 0 | 0 | 1 | 0 | 1 |    |    |    |
|               |              |              | 16.0...16.7   | 1            | 1           | 1           | 1 | 1 | 1 | 0 | 1 | 0 |    |    |    |
|               |              |              | 16.4...16.7   | 0            | 1           | 1           | 1 | 1 | 1 | 0 | 1 | 0 |    |    |    |
| 16.8...16.15  | 16.8...16.15 | 16.8...16.15 | 16.8...16.11  | 1            | 0           | 1           | 1 | 1 | 1 | 0 | 1 |   |    |    |    |
|               |              |              | 16.12...16.15 | 0            | 0           | 1           | 1 | 1 | 1 | 0 | 1 |   |    |    |    |
|               |              |              | 17.0...17.7   | 1            | 1           | 0           | 1 | 1 | 1 | 0 | 1 |   |    |    |    |
|               |              |              | 17.4...17.7   | 0            | 1           | 0           | 1 | 1 | 1 | 0 | 1 |   |    |    |    |
|               |              |              | 17.8...17.15  | 1            | 0           | 0           | 1 | 1 | 1 | 0 | 1 |   |    |    |    |
|               |              |              | 17.12...17.15 | 0            | 0           | 0           | 1 | 1 | 1 | 0 | 1 |   |    |    |    |
| 18.0...18.15  | 18.0...18.15 | 18.0...18.7  | 18.0...18.3   | 1            | 1           | 1           | 0 | 1 | 1 | 0 | 1 |   |    |    |    |
|               |              |              | 18.4...18.7   | 0            | 1           | 1           | 0 | 1 | 1 | 0 | 1 |   |    |    |    |
|               |              |              | 18.8...18.15  | 1            | 0           | 1           | 0 | 1 | 1 | 0 | 1 |   |    |    |    |
|               |              |              | 18.12...18.15 | 0            | 0           | 1           | 0 | 1 | 1 | 0 | 1 |   |    |    |    |
|               |              |              | 19.0...19.3   | 1            | 1           | 0           | 0 | 1 | 1 | 0 | 1 |   |    |    |    |
|               |              |              | 19.4...19.7   | 0            | 1           | 0           | 0 | 1 | 1 | 0 | 1 |   |    |    |    |
| 19.8...19.15  | 19.8...19.15 | 19.8...19.15 | 19.8...19.11  | 1            | 0           | 0           | 0 | 1 | 1 | 0 | 1 |   |    |    |    |
|               |              |              | 19.12...19.15 | 0            | 0           | 0           | 0 | 1 | 1 | 0 | 1 |   |    |    |    |
|               |              |              | 20.0...20.7   | 1            | 1           | 1           | 1 | 0 | 1 | 0 | 1 |   |    |    |    |
|               |              |              | 20.4...20.7   | 0            | 1           | 1           | 0 | 1 | 0 | 1 | 0 |   |    |    |    |
|               |              |              | 20.8...20.15  | 1            | 0           | 1           | 0 | 1 | 0 | 1 | 0 |   |    |    |    |
|               |              |              | 20.12...20.15 | 0            | 0           | 1           | 0 | 1 | 0 | 1 | 0 |   |    |    |    |
| 21.0...21.15  | 21.0...21.15 | 21.0...21.7  | 21.0...21.3   | 1            | 1           | 0           | 1 | 0 | 1 | 0 | 1 |   |    |    |    |
|               |              |              | 21.4...21.7   | 0            | 1           | 0           | 1 | 0 | 1 | 0 | 1 |   |    |    |    |
|               |              |              | 21.8...21.15  | 1            | 0           | 0           | 1 | 0 | 1 | 0 | 1 |   |    |    |    |
|               |              |              | 21.12...21.15 | 0            | 0           | 0           | 1 | 0 | 1 | 0 | 1 |   |    |    |    |
|               |              |              | 22.0...22.7   | 1            | 1           | 1           | 0 | 0 | 1 | 0 | 1 |   |    |    |    |
|               |              |              | 22.4...22.7   | 0            | 1           | 1           | 0 | 0 | 1 | 0 | 1 |   |    |    |    |
| 22.8...22.15  | 22.8...22.15 | 22.8...22.15 | 22.8...22.11  | 1            | 0           | 1           | 0 | 0 | 1 | 0 | 1 |   |    |    |    |
|               |              |              | 22.12...22.15 | 0            | 0           | 1           | 0 | 0 | 1 | 0 | 1 |   |    |    |    |
|               |              |              | 23.0...23.3   | 1            | 1           | 0           | 0 | 1 | 0 | 1 | 0 |   |    |    |    |
|               |              |              | 23.4...23.7   | 0            | 1           | 0           | 0 | 1 | 0 | 1 | 0 |   |    |    |    |
|               |              |              | 23.8...23.11  | 1            | 0           | 0           | 0 | 1 | 0 | 1 | 0 |   |    |    |    |
|               |              |              | 23.12...23.15 | 0            | 0           | 0           | 0 | 1 | 0 | 1 | 0 |   |    |    |    |

|                     |   |                     |              |        |
|---------------------|---|---------------------|--------------|--------|
| <b>Codierung</b>    | Alle Baugruppen dürfen nur bei ausgeschalteter Versorgungsspannung ausgetauscht werden. | <b>Schalter</b>     | 0 = off/open | 1 = on |
| <b>Coding</b>       | Cards must be exchanged only while the supply voltage is disconnected.                  | <b>Switches</b>     |              |        |
| <b>Codage</b>       | Les modules doivent tous être remplacés hors tension.                                   | <b>Codeurs</b>      |              |        |
| <b>Codifica</b>     | Togliere tensione prima di inserire o rimuovere i moduli.                               | <b>Interruttori</b> |              |        |
| <b>Codificación</b> | Las tarjetas deben insertarse o extraerse sólo con la alimentación desconectada.        | <b>Codificador</b>  |              |        |

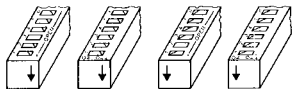

Baugruppentyp / Module Type / Type de module /  
Tipi di moduli / Tipo de tarjeta

Schalternummer / Switch Number / No. de microrrupteur /  
N° interruttore / N° de codificador

| A            | B             | C             | D             |   |   |   |   |   |   |   |   |   |   |
|--------------|---------------|---------------|---------------|---|---|---|---|---|---|---|---|---|---|
|              |               |               | 1             |   | 2 |   | 3 |   | 4 |   |   |   |   |
|              |               |               | 1             | 2 | 3 | 4 | 5 | 6 | 7 | 8 |   |   |   |
|              |               |               | 1             | 2 | 3 | 4 | 5 | 6 | 7 | 8 |   |   |   |
| 24.0...25.15 | 24.0...24.15  | 24.0...24.7   | 24.0...24.3   | 1 | 1 | 1 | 1 | 1 | 0 | 0 | 0 | 1 |   |
|              |               |               | 24.4...24.7   | 0 | 1 | 1 | 1 | 1 | 0 | 0 | 0 | 1 |   |
|              |               |               | 24.8...24.15  | 1 | 0 | 1 | 1 | 1 | 0 | 0 | 0 | 1 |   |
|              | 25.0...25.15  | 25.0...25.7   | 24.12...24.15 | 0 | 0 | 1 | 1 | 1 | 0 | 0 | 0 | 1 |   |
|              |               |               | 25.0...25.3   | 1 | 1 | 0 | 1 | 1 | 0 | 0 | 0 | 1 |   |
|              |               |               | 25.4...25.7   | 0 | 1 | 0 | 1 | 1 | 0 | 0 | 0 | 1 |   |
| 26.0...27.15 | 26.0...26.15  | 26.0...26.7   | 25.8...25.15  | 1 | 0 | 0 | 1 | 1 | 0 | 0 | 0 | 1 |   |
|              |               |               | 26.0...26.3   | 1 | 1 | 1 | 0 | 1 | 0 | 0 | 0 | 1 |   |
|              |               |               | 26.4...26.7   | 0 | 1 | 1 | 0 | 1 | 0 | 0 | 0 | 1 |   |
|              | 27.0...27.15  | 26.8...26.15  | 26.8...26.11  | 1 | 0 | 1 | 0 | 1 | 0 | 0 | 0 | 1 |   |
|              |               |               | 26.12...26.15 | 0 | 0 | 1 | 0 | 1 | 0 | 0 | 0 | 1 |   |
|              |               |               | 27.0...27.7   | 1 | 1 | 0 | 0 | 1 | 0 | 0 | 0 | 1 |   |
| 28.0...29.15 | 27.0...27.15  | 27.0...27.7   | 27.4...27.7   | 0 | 1 | 0 | 0 | 1 | 0 | 0 | 0 | 1 |   |
|              |               |               | 27.8...27.11  | 1 | 0 | 0 | 0 | 1 | 0 | 0 | 0 | 1 |   |
|              |               |               | 27.12...27.15 | 0 | 0 | 0 | 0 | 1 | 0 | 0 | 0 | 1 |   |
|              | 28.0...28.15  | 28.0...28.7   | 28.0...28.3   | 1 | 1 | 1 | 1 | 0 | 0 | 0 | 0 | 1 |   |
|              |               |               | 28.4...28.7   | 0 | 1 | 1 | 1 | 0 | 0 | 0 | 0 | 1 |   |
|              |               |               | 28.8...28.15  | 1 | 0 | 1 | 1 | 0 | 0 | 0 | 0 | 1 |   |
| 29.0...29.15 | 28.12...28.15 | 28.12...28.15 | 0             | 0 | 1 | 1 | 0 | 0 | 0 | 0 | 1 |   |   |
|              |               | 29.0...29.7   | 1             | 1 | 0 | 1 | 0 | 0 | 0 | 0 | 1 |   |   |
|              |               | 29.4...29.7   | 0             | 1 | 0 | 1 | 0 | 0 | 0 | 0 | 1 |   |   |
| 30.0...31.15 | 29.0...29.15  | 29.8...29.15  | 29.8...29.11  | 1 | 0 | 0 | 1 | 0 | 0 | 0 | 0 | 1 |   |
|              |               |               | 29.12...29.15 | 0 | 0 | 0 | 1 | 0 | 0 | 0 | 0 | 1 |   |
|              |               |               | 30.0...30.7   | 1 | 1 | 1 | 0 | 0 | 0 | 0 | 0 | 1 |   |
|              | 31.0...31.15  | 30.0...30.15  | 30.4...30.7   | 0 | 1 | 1 | 0 | 0 | 0 | 0 | 0 | 1 |   |
|              |               |               | 30.8...30.11  | 1 | 0 | 1 | 0 | 0 | 0 | 0 | 0 | 1 |   |
|              |               |               | 30.12...30.15 | 0 | 0 | 1 | 0 | 0 | 0 | 0 | 0 | 1 |   |
| 32.0...33.15 | 31.0...31.15  | 31.0...31.7   | 31.0...31.3   | 1 | 1 | 0 | 0 | 0 | 0 | 0 | 0 | 1 |   |
|              |               |               | 31.4...31.7   | 0 | 1 | 0 | 0 | 0 | 0 | 0 | 0 | 1 |   |
|              |               |               | 31.8...31.11  | 1 | 0 | 0 | 0 | 0 | 0 | 0 | 0 | 1 |   |
|              | 32.0...32.15  | 31.12...31.15 | 31.12...31.15 | 0 | 0 | 0 | 0 | 0 | 0 | 0 | 0 | 0 | 1 |
|              |               |               | 32.0...32.7   | 1 | 1 | 1 | 1 | 1 | 1 | 1 | 1 | 0 |   |
|              |               |               | 32.4...32.7   | 0 | 1 | 1 | 1 | 1 | 1 | 1 | 1 | 0 |   |
| 33.0...33.15 | 32.8...32.15  | 32.8...32.15  | 32.8...32.11  | 1 | 0 | 1 | 1 | 1 | 1 | 1 | 1 | 0 |   |
|              |               |               | 32.12...32.15 | 0 | 0 | 1 | 1 | 1 | 1 | 1 | 1 | 0 |   |
|              |               |               | 33.0...33.7   | 1 | 1 | 0 | 1 | 1 | 1 | 1 | 1 | 0 |   |
|              | 33.8...33.15  | 33.0...33.15  | 33.4...33.7   | 0 | 1 | 0 | 1 | 1 | 1 | 1 | 1 | 0 |   |
|              |               |               | 33.8...33.11  | 1 | 0 | 0 | 1 | 1 | 1 | 1 | 1 | 0 |   |
|              |               |               | 33.12...33.15 | 0 | 0 | 0 | 1 | 1 | 1 | 1 | 1 | 0 |   |
| 34.0...35.15 | 34.0...34.15  | 34.0...34.7   | 34.0...34.3   | 1 | 1 | 1 | 0 | 1 | 1 | 1 | 1 | 0 |   |
|              |               |               | 34.4...34.7   | 0 | 1 | 1 | 0 | 1 | 1 | 1 | 1 | 0 |   |
|              |               |               | 34.8...34.15  | 1 | 0 | 1 | 0 | 1 | 1 | 1 | 1 | 0 |   |
|              | 35.0...35.15  | 34.12...34.15 | 34.12...34.15 | 0 | 0 | 1 | 0 | 1 | 1 | 1 | 1 | 0 |   |
|              |               |               | 35.0...35.7   | 1 | 1 | 0 | 0 | 1 | 1 | 1 | 1 | 0 |   |
|              |               |               | 35.4...35.7   | 0 | 1 | 0 | 0 | 1 | 1 | 1 | 1 | 0 |   |
| 36.0...37.15 | 35.8...35.15  | 35.8...35.15  | 35.8...35.11  | 1 | 0 | 0 | 0 | 1 | 1 | 1 | 1 | 0 |   |
|              |               |               | 35.12...35.15 | 0 | 0 | 0 | 0 | 1 | 1 | 1 | 1 | 0 |   |
|              |               |               | 36.0...36.7   | 1 | 1 | 1 | 1 | 0 | 1 | 1 | 1 | 0 |   |
|              | 37.0...37.15  | 36.4...36.7   | 36.4...36.7   | 0 | 1 | 1 | 1 | 0 | 1 | 1 | 1 | 0 |   |
|              |               |               | 36.8...36.15  | 1 | 0 | 1 | 1 | 0 | 1 | 1 | 1 | 0 |   |
|              |               |               | 36.12...36.15 | 0 | 0 | 1 | 1 | 0 | 1 | 1 | 1 | 0 |   |
| 37.8...37.15 | 37.0...37.15  | 37.0...37.7   | 37.0...37.3   | 1 | 1 | 0 | 1 | 0 | 1 | 1 | 1 | 0 |   |
|              |               |               | 37.4...37.7   | 0 | 1 | 0 | 1 | 0 | 1 | 1 | 1 | 0 |   |
|              |               |               | 37.8...37.11  | 1 | 0 | 0 | 1 | 0 | 1 | 1 | 1 | 0 |   |
|              | 37.12...37.15 | 37.8...37.15  | 37.12...37.15 | 0 | 0 | 0 | 1 | 0 | 1 | 1 | 1 | 0 |   |

**Codierung** Alle Baugruppen dürfen nur bei ausgeschalteter Versorgungsspannung ausgetauscht werden.

**Coding** Cards must be exchanged only while the supply voltage is disconnected.

**Codage** Les modules doivent tous être remplacés hors tension.

**Codifica** Togliere tensione prima di inserire o rimuovere i moduli.

**Codificación** Las tarjetas deben insertarse o extraerse sólo con la alimentación desconectada.

**Schalter** 0 = off/open      1 = on

**Switches**

**Codeurs**

**Interruttori**



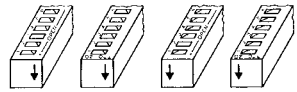

**Codificador**



**Baugruppentyp / Module Type / Type de module /  
Tipi di moduli / Tipo de tarjeta**

**Schalternummer / Switch Number / No. de microrrupteur /  
N° interruttore / N° de codificador**

| A            | B            | C             | D             |   |   |   |   |   |   |   |   |  |  |  |  |  |  |  |  |
|--------------|--------------|---------------|---------------|---|---|---|---|---|---|---|---|--|--|--|--|--|--|--|--|
|              |              |               |               | 1 |   |   |   | 2 |   |   |   |  |  |  |  |  |  |  |  |
|              |              |               |               | 1 | 2 | 3 | 4 | 5 | 6 | 7 | 8 |  |  |  |  |  |  |  |  |
|              |              |               |               | 1 | 2 | 3 | 4 | 5 | 6 | 7 | 8 |  |  |  |  |  |  |  |  |
| 38.0...39.15 | 38.0...38.15 | 38.0...38.7   | 38.0...38.3   | 1 | 1 | 1 | 0 | 0 | 1 | 1 | 0 |  |  |  |  |  |  |  |  |
|              |              |               | 38.4...38.7   | 0 | 1 | 1 | 0 | 0 | 1 | 1 | 0 |  |  |  |  |  |  |  |  |
|              |              |               | 38.8...38.15  | 1 | 0 | 1 | 0 | 0 | 1 | 1 | 0 |  |  |  |  |  |  |  |  |
|              | 39.0...39.15 | 39.0...39.7   | 38.12...38.15 | 0 | 0 | 1 | 0 | 0 | 1 | 1 | 0 |  |  |  |  |  |  |  |  |
|              |              |               | 39.0...39.3   | 1 | 1 | 0 | 0 | 0 | 1 | 1 | 0 |  |  |  |  |  |  |  |  |
|              |              |               | 39.4...39.7   | 0 | 1 | 0 | 0 | 0 | 1 | 1 | 0 |  |  |  |  |  |  |  |  |
| 40.0...41.15 | 40.0...40.15 | 40.0...40.7   | 39.8...39.15  | 1 | 0 | 0 | 0 | 0 | 1 | 1 | 0 |  |  |  |  |  |  |  |  |
|              |              |               | 40.0...40.3   | 1 | 1 | 1 | 1 | 1 | 0 | 1 | 0 |  |  |  |  |  |  |  |  |
|              |              |               | 40.4...40.7   | 0 | 1 | 1 | 1 | 1 | 0 | 1 | 0 |  |  |  |  |  |  |  |  |
|              | 41.0...41.15 | 41.0...41.7   | 40.8...40.15  | 1 | 0 | 1 | 1 | 1 | 0 | 1 | 0 |  |  |  |  |  |  |  |  |
|              |              |               | 40.12...40.15 | 0 | 0 | 1 | 1 | 1 | 0 | 1 | 0 |  |  |  |  |  |  |  |  |
|              |              |               | 41.0...41.3   | 1 | 1 | 0 | 1 | 1 | 0 | 1 | 0 |  |  |  |  |  |  |  |  |
| 42.0...43.15 | 42.0...42.15 | 42.0...42.7   | 41.4...41.7   | 0 | 1 | 0 | 1 | 1 | 0 | 1 | 0 |  |  |  |  |  |  |  |  |
|              |              |               | 41.8...41.15  | 1 | 0 | 0 | 1 | 1 | 0 | 1 | 0 |  |  |  |  |  |  |  |  |
|              |              |               | 41.12...41.15 | 0 | 0 | 0 | 1 | 1 | 0 | 1 | 0 |  |  |  |  |  |  |  |  |
|              | 43.0...43.15 | 43.0...43.7   | 42.0...42.3   | 1 | 1 | 1 | 0 | 1 | 0 | 1 | 0 |  |  |  |  |  |  |  |  |
|              |              |               | 42.4...42.7   | 0 | 1 | 1 | 0 | 1 | 0 | 1 | 0 |  |  |  |  |  |  |  |  |
|              |              |               | 42.8...42.15  | 1 | 0 | 1 | 0 | 1 | 0 | 1 | 0 |  |  |  |  |  |  |  |  |
| 44.0...45.15 | 44.0...44.15 | 44.0...44.7   | 42.12...42.15 | 0 | 0 | 1 | 0 | 1 | 0 | 1 | 0 |  |  |  |  |  |  |  |  |
|              |              |               | 43.0...43.3   | 1 | 1 | 0 | 0 | 1 | 0 | 1 | 0 |  |  |  |  |  |  |  |  |
|              |              |               | 43.4...43.7   | 0 | 1 | 0 | 0 | 1 | 0 | 1 | 0 |  |  |  |  |  |  |  |  |
|              | 45.0...45.15 | 45.0...45.7   | 43.8...43.15  | 1 | 0 | 0 | 0 | 1 | 0 | 1 | 0 |  |  |  |  |  |  |  |  |
|              |              |               | 44.0...44.3   | 1 | 1 | 1 | 1 | 0 | 0 | 1 | 0 |  |  |  |  |  |  |  |  |
|              |              |               | 44.4...44.7   | 0 | 1 | 1 | 1 | 0 | 0 | 1 | 0 |  |  |  |  |  |  |  |  |
| 46.0...47.15 | 46.0...46.15 | 46.0...46.7   | 44.8...44.15  | 1 | 0 | 1 | 1 | 0 | 0 | 1 | 0 |  |  |  |  |  |  |  |  |
|              |              |               | 44.12...44.15 | 0 | 0 | 1 | 1 | 0 | 0 | 1 | 0 |  |  |  |  |  |  |  |  |
|              |              |               | 45.0...45.3   | 1 | 1 | 0 | 1 | 0 | 0 | 1 | 0 |  |  |  |  |  |  |  |  |
|              | 47.0...47.15 | 47.0...47.7   | 45.4...45.7   | 0 | 1 | 0 | 1 | 0 | 0 | 1 | 0 |  |  |  |  |  |  |  |  |
|              |              |               | 45.8...45.15  | 1 | 0 | 0 | 1 | 0 | 0 | 1 | 0 |  |  |  |  |  |  |  |  |
|              |              |               | 45.12...45.15 | 0 | 0 | 0 | 1 | 0 | 0 | 1 | 0 |  |  |  |  |  |  |  |  |
| 48.0...49.15 | 48.0...48.15 | 48.0...48.7   | 46.4...46.7   | 1 | 1 | 1 | 0 | 0 | 0 | 1 | 0 |  |  |  |  |  |  |  |  |
|              |              |               | 46.8...46.15  | 0 | 1 | 1 | 0 | 0 | 0 | 1 | 0 |  |  |  |  |  |  |  |  |
|              |              |               | 46.12...46.15 | 0 | 0 | 1 | 0 | 0 | 0 | 1 | 0 |  |  |  |  |  |  |  |  |
|              | 49.0...49.15 | 49.0...49.7   | 47.0...47.3   | 1 | 1 | 0 | 0 | 0 | 0 | 1 | 0 |  |  |  |  |  |  |  |  |
|              |              |               | 47.4...47.7   | 0 | 1 | 0 | 0 | 0 | 0 | 1 | 0 |  |  |  |  |  |  |  |  |
|              |              |               | 47.8...47.15  | 1 | 0 | 0 | 0 | 0 | 0 | 1 | 0 |  |  |  |  |  |  |  |  |
| 50.0...51.15 | 50.0...50.15 | 50.0...50.7   | 47.12...47.15 | 0 | 0 | 0 | 0 | 0 | 0 | 1 | 0 |  |  |  |  |  |  |  |  |
|              |              |               | 48.0...48.3   | 1 | 1 | 1 | 1 | 1 | 1 | 0 | 0 |  |  |  |  |  |  |  |  |
|              |              |               | 48.4...48.7   | 0 | 1 | 1 | 1 | 1 | 1 | 0 | 0 |  |  |  |  |  |  |  |  |
|              | 51.0...51.15 | 51.0...51.7   | 48.8...48.15  | 1 | 0 | 1 | 1 | 1 | 1 | 0 | 0 |  |  |  |  |  |  |  |  |
|              |              |               | 48.12...48.15 | 0 | 0 | 1 | 1 | 1 | 1 | 0 | 0 |  |  |  |  |  |  |  |  |
|              |              |               | 49.0...49.3   | 1 | 1 | 0 | 1 | 1 | 1 | 0 | 0 |  |  |  |  |  |  |  |  |
| 51.8...51.15 | 51.8...51.11 | 49.4...49.7   | 0             | 1 | 0 | 1 | 1 | 1 | 0 | 0 |   |  |  |  |  |  |  |  |  |
|              |              | 49.8...49.11  | 1             | 0 | 0 | 1 | 1 | 1 | 0 | 0 |   |  |  |  |  |  |  |  |  |
|              |              | 49.12...49.15 | 0             | 0 | 0 | 1 | 1 | 1 | 0 | 0 |   |  |  |  |  |  |  |  |  |

|                     |   |                     |   |   |
|---------------------|---|---------------------|---|---|
| <b>Codierung</b>    | Alle Baugruppen dürfen nur bei ausgeschalteter Versorgungsspannung ausgetauscht werden. | <b>Schalter</b>     | 0 = off/open  | 1 = on  |
| <b>Coding</b>       | Cards must be exchanged only while the supply voltage is disconnected.                  | <b>Switches</b>     |  |  |
| <b>Codage</b>       | Les modules doivent tous être remplacés hors tension.                                   | <b>Codeurs</b>      |  |  |
| <b>Codifica</b>     | Togliere tensione prima di inserire o rimuovere i moduli.                               | <b>Interruttori</b> |   |   |
| <b>Codificación</b> | Las tarjetas deben insertarse o extraerse sólo con la alimentación desconectada.        | <b>Codificador</b>  |   |   |

Baugruppentyp / Module Type / Type de module /  
Tipi di moduli / Tipo de tarjeta

Schalternummer / Switch Number / No. de microrupteur /  
N° interruttore / N° de codificador

| A            | B            | C           | D             |               |   |   |   |   |   |   |   |   |   |
|--------------|--------------|-------------|---------------|---------------|---|---|---|---|---|---|---|---|---|
|              |              |             | 1             |               |   | 2 |   |   |   |   |   |   |   |
|              |              |             | 1             | 2             | 3 | 4 | 5 | 6 | 7 | 8 |   |   |   |
|              |              |             | 1             | 2             | 3 | 4 | 5 | 6 | 7 | 8 |   |   |   |
| 52.0...53.15 | 52.0...52.15 | 52.0...52.7 | 52.0...52.3   | 1             | 1 | 1 | 1 | 0 | 1 | 0 | 0 | 0 |   |
|              |              |             | 52.4...52.7   | 0             | 1 | 1 | 1 | 0 | 1 | 0 | 0 | 0 |   |
|              |              |             | 52.8...52.15  | 1             | 0 | 1 | 1 | 0 | 1 | 0 | 0 | 0 |   |
|              | 53.0...53.15 | 53.0...53.7 | 53.0...53.3   | 53.4...53.7   | 1 | 1 | 0 | 1 | 0 | 1 | 0 | 0 | 0 |
|              |              |             |               | 53.8...53.15  | 1 | 0 | 0 | 1 | 0 | 1 | 0 | 0 | 0 |
|              |              |             |               | 53.12...53.15 | 0 | 0 | 0 | 1 | 0 | 1 | 0 | 0 | 0 |
| 54.0...55.15 | 54.0...54.15 | 54.0...54.7 | 54.4...54.7   | 1             | 1 | 1 | 0 | 0 | 1 | 0 | 0 | 0 |   |
|              |              |             | 54.8...54.15  | 0             | 1 | 1 | 0 | 0 | 1 | 0 | 0 | 0 |   |
|              |              |             | 54.12...54.15 | 1             | 0 | 1 | 0 | 0 | 1 | 0 | 0 | 0 |   |
|              | 55.0...55.15 | 55.0...55.7 | 55.0...55.3   | 55.4...55.7   | 0 | 0 | 1 | 0 | 0 | 1 | 0 | 0 | 0 |
|              |              |             |               | 55.8...55.15  | 1 | 1 | 0 | 0 | 0 | 1 | 0 | 0 | 0 |
|              |              |             |               | 55.12...55.15 | 0 | 1 | 0 | 0 | 0 | 1 | 0 | 0 | 0 |
| 56.0...57.15 | 56.0...56.15 | 56.0...56.7 | 56.4...56.7   | 1             | 1 | 1 | 1 | 1 | 0 | 0 | 0 | 0 |   |
|              |              |             | 56.8...56.15  | 0             | 1 | 1 | 1 | 1 | 0 | 0 | 0 | 0 |   |
|              |              |             | 56.12...56.15 | 1             | 0 | 1 | 1 | 1 | 0 | 0 | 0 | 0 |   |
|              | 57.0...57.15 | 57.0...57.7 | 57.0...57.3   | 57.4...57.7   | 0 | 0 | 1 | 1 | 1 | 0 | 0 | 0 | 0 |
|              |              |             |               | 57.8...57.15  | 1 | 0 | 0 | 1 | 1 | 0 | 0 | 0 | 0 |
|              |              |             |               | 57.12...57.15 | 0 | 0 | 0 | 1 | 1 | 0 | 0 | 0 | 0 |
| 58.0...59.15 | 58.0...58.15 | 58.0...58.7 | 58.4...58.7   | 1             | 1 | 1 | 0 | 1 | 0 | 0 | 0 | 0 |   |
|              |              |             | 58.8...58.15  | 0             | 1 | 1 | 0 | 1 | 0 | 0 | 0 | 0 |   |
|              |              |             | 58.12...58.15 | 0             | 0 | 1 | 0 | 1 | 0 | 0 | 0 | 0 |   |
|              | 59.0...59.15 | 59.0...59.7 | 59.0...59.3   | 59.4...59.7   | 1 | 1 | 0 | 0 | 1 | 0 | 0 | 0 | 0 |
|              |              |             |               | 59.8...59.15  | 0 | 1 | 0 | 0 | 1 | 0 | 0 | 0 | 0 |
|              |              |             |               | 59.12...59.15 | 1 | 0 | 0 | 0 | 1 | 0 | 0 | 0 | 0 |
| 60.0...61.15 | 60.0...60.15 | 60.0...60.7 | 60.4...60.7   | 0             | 0 | 0 | 1 | 0 | 0 | 0 | 0 | 0 |   |
|              |              |             | 60.8...60.15  | 1             | 0 | 1 | 1 | 0 | 0 | 0 | 0 | 0 |   |
|              |              |             | 60.12...60.15 | 0             | 0 | 1 | 1 | 0 | 0 | 0 | 0 | 0 |   |
|              | 61.0...61.15 | 61.0...61.7 | 61.0...61.3   | 61.4...61.7   | 1 | 1 | 0 | 1 | 0 | 0 | 0 | 0 | 0 |
|              |              |             |               | 61.8...61.15  | 0 | 1 | 0 | 1 | 0 | 0 | 0 | 0 | 0 |
|              |              |             |               | 61.12...61.15 | 1 | 0 | 0 | 1 | 0 | 0 | 0 | 0 | 0 |
| 62.0...63.15 | 62.0...62.15 | 62.0...62.7 | 62.4...62.7   | 1             | 1 | 1 | 0 | 0 | 0 | 0 | 0 | 0 |   |
|              |              |             | 62.8...62.15  | 0             | 1 | 1 | 0 | 0 | 0 | 0 | 0 | 0 |   |
|              |              |             | 62.12...62.15 | 1             | 0 | 1 | 0 | 0 | 0 | 0 | 0 | 0 |   |
|              | 63.0...63.15 | 63.0...63.7 | 63.0...63.3   | 63.4...63.7   | 1 | 1 | 0 | 0 | 0 | 0 | 0 | 0 | 0 |
|              |              |             |               | 63.8...63.15  | 0 | 1 | 0 | 0 | 0 | 0 | 0 | 0 | 0 |
|              |              |             |               | 63.12...63.15 | 1 | 0 | 0 | 0 | 0 | 0 | 0 | 0 | 0 |